

FT 25-C

RGB colour sensor in miniature housing



FT 25-C

RGB colour sensor in miniature housing with high switching frequency



 made in Germany



Reliable colour detection:

The main task of the FT 25-C RGB colour sensor is the detection of a defined colour. It is also suitable for very rapid applications thanks to its high switching frequency. Mounting by means of a dovetail and the MBD F25ST mounting rod, available as an accessory, allows easy and precise fine alignment.

TYPICAL FT 25-C

- Smallest cubic colour sensor on the market (34 x 20 x 12 mm³)
- High switching frequency of 10 kHz for rapid applications
- Detection of a taught-in colour
- Detection of "non-colours", e.g. black, white and grey
- Bright light spot with sharp contour for easy alignment and precise front-edge detection
- Static or external teach-in
- "Communicating" light spot for simplest setup
- Hermetically sealed housings (IP 69K & IP 67)

The FT 25-C RGB colour sensor is not only the smallest cubic colour sensor currently available on the market, but is also one of the quickest: with a switching frequency of up to 10 kHz it is as fast as a contrast sensor and thus also suitable for the most rapid printed mark applications. The FT 25-C can identify any colour in the visible spectrum including all the “non-colours” and also very reliably detects the smallest of colour differences. It keeps even the narrowest print marks and smallest markings in view thanks to its bright light spot with a sharp elongated contour (1 × 5 mm²).

Fits into every space

Thanks to its miniature design, SensoPart’s smallest colour sensor is also easily accommodated in very restricted installation spaces, whereby the patented dovetail mounting allows user-friendly fine

alignment. The operating concept is also clever: the FT 25-C is rapidly and easily configured via teach-in or control line. The quality of the colour detection is signalled via a “communicating” light spot: the blinking of the red, blue or green transmission LED provides you with a clear statement on the stability of your process.

As a result of its space-saving design and rapidity, the FT 25-C is suitable for use in numerous sectors and applications, for example, packaging and labeling machines as well as bottling lines.

FT 25-C – Product Overview				
	Type of light	Scanning distance	Special features	Page
FT 25-C	Red LED, green LED, blue LED	12 ± 3 mm	The world’s smallest RGB colour sensor with a switching frequency of ≤ 10 kHz	4

FT 25-C

RGB colour sensor



PRODUCT HIGHLIGHTS

- Smallest RGB colour sensor with high switching frequency ≤ 10 kHz
- Precise detection of the slightest of contrast differences
- Very robust operation despite fluttering and glossy objects
- Feedback via „responding light spot“ about quality of taught-in colour value

Optical data		Functions	
Scanning distance	12 mm	Indicator LED, green	Operating voltage indicator
Depth of field	± 3 mm	Indicator LED, yellow	Switching output indicator
Type of light	Red LED, 633 nm Green LED, 525 nm Blue LED, 460 nm	Sensitivity adjustment	Via Teach-in button and control input
Light spot size	1×5 mm ²	Adjustment possibilities	N.O./N.C. via Teach-in button and control input
		Default settings	Button lock via control input
			N.O.
Electrical data		Mechanical data	
Operating voltage, +U _B	10 ... 30V DC ¹	Dimensions	34 x 20 x 12 mm ³
No-load current, I ₀	≤ 30 mA	Enclosure rating	IP 67 / IP 69K ³
Output current, I _e	≤ 100 mA	Material, housing	ABS
Protective circuits	Reverse-polarity protection, U _B / short-circuit protection (Q)	Material, front screen	PMMA
Protection class	2	Type of connection	(See Selection Table)
Standby time	< 300 ms	Ambient temperature: operation	-20 ... +55 °C ⁴
Switching output, Q	Push-Pull	Ambient temperature: storage	-20 ... +80 °C
Output function	N.O. / N.C.	Weight (metal plug device)	10 g
Switching frequency, f (ti/tp 1:1) ²	(See Selection Table)	Vibration and impact resistance	EN 60947-5-2
Response time	(See Selection Table)		

¹ Max. 10 % ripple, within U_B, ~ 50 Hz / 100 Hz ² f = 1 / (T x Nyq x 2) ³ With connected IP 67 / IP 69K plug ⁴ UL: -20 ... +50 °C

Switching frequency, f (ti/tp 1:1) ²	Response time	Scanning distance	Type of connection	Part number	Article number
≤ 10000 Hz	≤ 50 μ s	12 ± 3 mm	Metal plug, M8x1, 4-pin	FT 25-C1-GS-M4M	607-21020
≤ 2500 Hz	≤ 200 μ s	12 ± 3 mm	Metal plug, M8x1, 4-pin	FT 25-C2-GS-M4M	607-21021

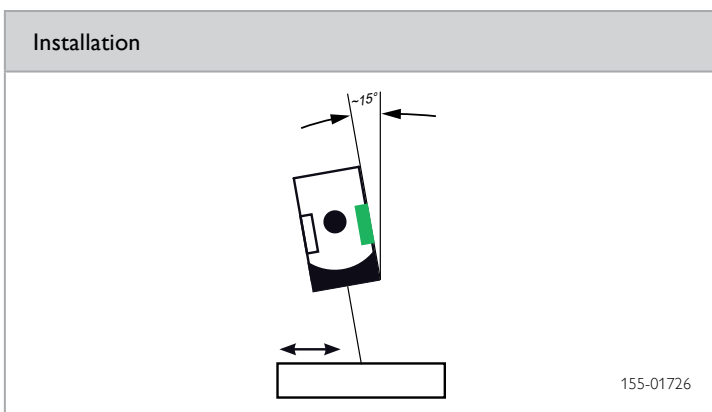
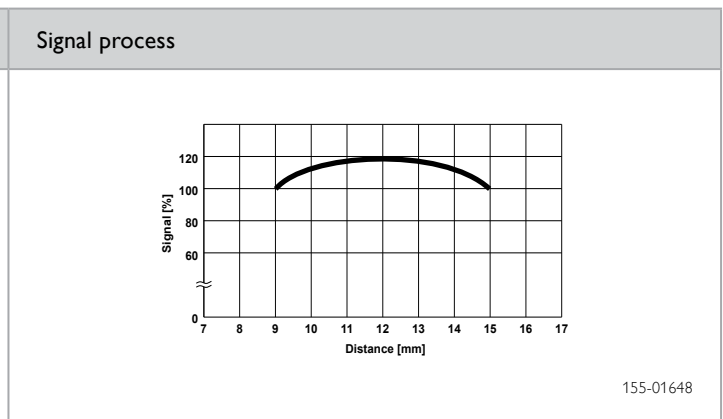
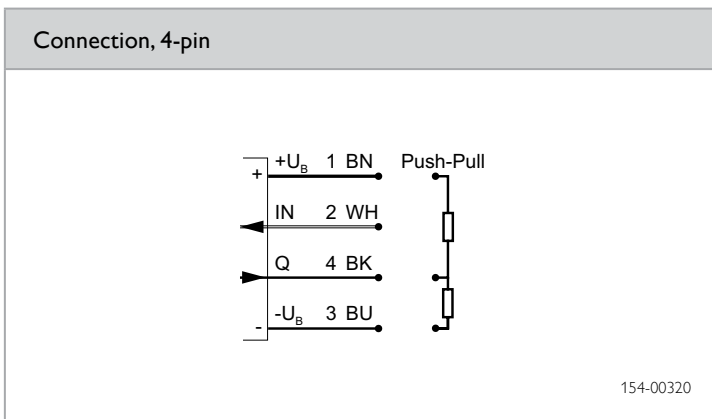
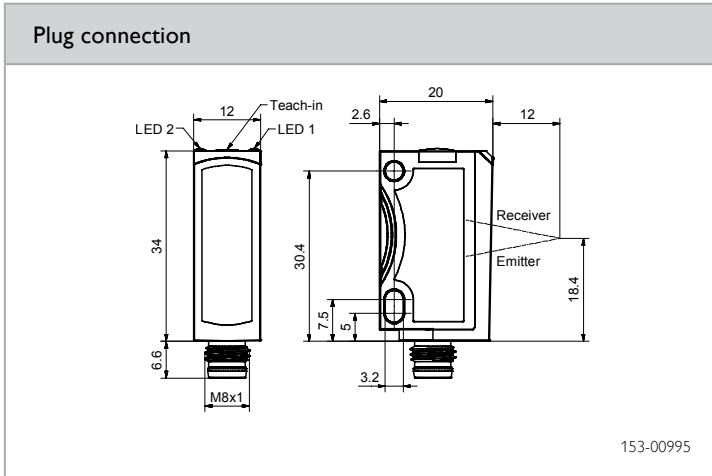









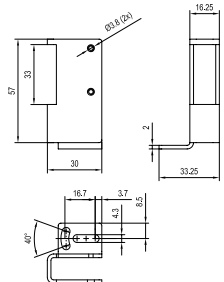

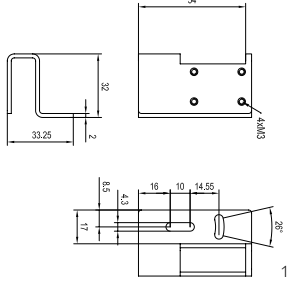
Accessories

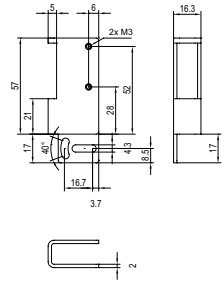
Connection cables	See product catalogue/ accessories
Brackets	

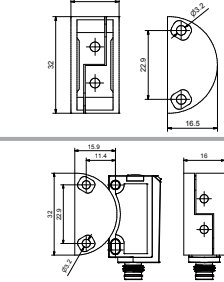
Accessories

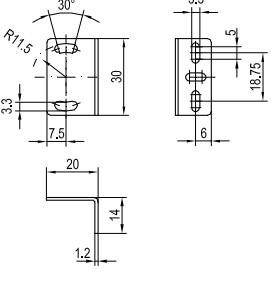
Brackets

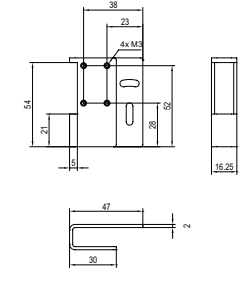
Brackets			
	 <p style="text-align: right;">153-01017</p>	<p>Part number / Article number</p> <p>Description</p> <p>Suitable for</p>	<p>MSP F 20-11 / 558-41006</p> <p>Protective sensor angle bracket with screws, very robust Material: stainless steel V2A</p> <p>F 20 UT 20-150 F 25 UT 20-S150 FL 20 UT 20-240</p>
	 <p style="text-align: right;">153-00908</p>	<p>Part number / Article number</p> <p>Description</p> <p>Suitable for</p>	<p>MSP F 20-23 / 558-41011</p> <p>Protective sensor angle bracket with screws, very robust Material: stainless steel V2A</p> <p>F 20 UT 20-150 F 25 UT 20-S150 FL 20 UT 20-240</p>
	 <p style="text-align: right;">153-00973</p>	<p>Part number / Article number</p> <p>Description</p> <p>Suitable for</p>	<p>MSP F 20-13 / 558-41008</p> <p>Protective sensor angle bracket with screws, very robust Material: stainless steel V2A</p> <p>F 20 UT 20-150 F 25 UT 20-S150 FL 20 UT 20-240</p>
	 <p style="text-align: right;">153-00945</p> <p style="text-align: right;">153-00946</p>	<p>Part number / Article number</p> <p>Description</p> <p>Suitable for</p>	<p>MBD F 25 / 661-01000</p> <p>Dovetail clamp mounting, adjustable $\pm 15^\circ$, with screws Material: anodised aluminium</p> <p>F 25</p>
	 <p style="text-align: right;">153-00241</p>	<p>Part number / Article number</p> <p>Description</p> <p>Suitable for</p>	<p>MS F 20 / 558-41000</p> <p>Mounting bracket with screws Material: nickel-plated steel</p> <p>F 20 F 25 UT 20 FL 20</p>
	 <p style="text-align: right;">153-000974</p>	<p>Part number / Article number</p> <p>Description</p> <p>Suitable for</p>	<p>MSP F 20-21 / 558-41009</p> <p>Protective sensor angle bracket with screws, very robust Material: stainless steel V2A</p> <p>F 20 UT 20-150 F 25 UT 20-S150 FL 20 UT 20-240</p>

Brackets								
	1 153-01001	Part number / Article number Description Suitable for	MBD F 25ST / 661-01001 Bracket for dovetail on mounting rod, with clamping screw Material: aluminium F 25FT 25-RGB1-GS-KL4					
	 153-01002	Part number / Article number Description Suitable for	F 25FT 25-RGB1-GS-KL4					
	2 <table border="1" style="margin-left: 20px;"> <tr> <td>x = 200</td> <td>MST 45-20</td> </tr> <tr> <td>x = 300</td> <td>MST 45-30</td> </tr> <tr> <td>x = 400</td> <td>MST 45-40</td> </tr> </table> 153-00545	x = 200	MST 45-20	x = 300	MST 45-30	x = 400	MST 45-40	Part number / Article number Description Suitable for
x = 200	MST 45-20							
x = 300	MST 45-30							
x = 400	MST 45-40							
3 153-01000	Part number / Article number Description Suitable for	MB ST1 / 661-01002 Bracket for mounting rods, with clamping screw Material: aluminium MST 45-20 MST 45-30 MST 45-40						

Cables		
Part number	Article number	Description
M8, 4-pin		
K4-2m-G-PUR	902-50801	2 m, straight, PUR
K4-5m-G-PUR	902-51617	5 m, straight, PUR
K4-10m-G-PUR	902-51610	10 m, straight, PUR
K4-2m-W-PUR	902-50803	2 m, 90°, PUR
K4-5m-W-PUR	902-51618	5 m, 90°, PUR
K4-10m-W-PUR	902-51629	10 m, 90°, PUR
K4-2m-W-PL-PUR	902-51642	2 m, 90°, PUR, with indicator LED
K4-5m-W-PL-PUR	902-51643	5 m, 90°, PUR, with indicator LED
CM4 FG-E-5m-PVC	902-50221	5 m, straight, PVC, with hex nut SW 9 stainless steel (IP 69K)
CM4 FW-E-5m-PVC	902-50222	5 m, 90°, PVC, with hex nut SW 9 stainless steel (IP 69K)

For further accessories see SensoPart's Complete Catalogue, chapter Accessories or www.sensopart.com

We look ahead.

Yesterday, today and in the future.

 **SENSOPART**



“We gauge ourselves not by what is possible today, but by our vision of what can be achieved” – this has been our motto since the foundation of Sensopart in 1994. Our goal is to always be a step ahead and to be able to offer our customers the most innovative sensor for industrial automation.

With our easy to integrate VISOR® Vision sensors and our compact laser sensors with an amazing background suppression made in Germany, we stick up to this motto.

Get ready – we still have a lot of ideas for the future.

SENSOR TECHNOLOGY

- Light barriers
- Proximity switches
- Laser sensors
- Miniature sensors
- Distance sensors
- Colour sensors
- Contrast sensors
- Anti-collision sensors
- Slot sensors
- Fibre-optic amplifiers
- Inductive sensors
- Capacitive sensors
- Ultrasonic sensors

VISION

- Vision sensors
- Smart cameras
- Vision systems
- Object detection
- Object measurement
- Colour detection
- Code reading OCR
- Lighting
- Lenses

Sold & Serviced By:



Canadian and International Sales

ELECTROMATE

877-737-8698

sales@electromate.com

www.electromate.com

U.S. Sales

SERVO2GO.com

877-378-0240

sales@servo2go.com

www.servo2go.com