

# SV2Dx Servo Drives

SV200 Servo Drives for DC-Powered Applications



- 24 to 60 VDC input
- 10 A cont., 20 A peak output current
- Compact size for multi-axis applications
- Ideal for OEMs
- Designed for use with J Series motors
- Wide range of control options
- 8 regular digital inputs, 5-24 VDC
- 4 high-speed digital inputs, 5-24 VDC
- 6 digital outputs, 30 VDC max
- 2 analog inputs, -10 to +10 V
- Safe Torque Off (STO) input

---

## Why Choose SV200?

SV200 digital servo drives are compact, powerful, and functional servo drives, designed for use in demanding motion control applications in a wide range of industries.

---

## Wide Selection from a Single Source:

Servo drives, motors, cables, software, and accessories, all available from Applied Motion.

- Support for pulse & direction, analog torque/velocity/position, streaming commands, stored program, fieldbus, and industrial Ethernet control.
- Q Programming provides robust, on-board motion control for decentralized applications.
- Support for CANopen, Modbus RTU/TCP, and EtherNet/IP networks.
- Planetary gearheads available for increased torque output and inertia matching.

---

## Performance:

SV200 servo drives were designed with demanding applications in mind.

- Programmable notch filter and an anti-vibration algorithm ensure smooth motion and accurate positioning.
- Improved EMC over legacy drive systems.



---

## Functionality:

Broad functionality in a compact servo drive that is ideal for OEM and multi-axis applications.

- Auto-tuning for quick and reliable commissioning of the servo axis.
- Separate power for main and control circuits enable “keep-alive” functionality to maintain DC power to the controller while power to the motor is removed.
- Dedicated Safe Torque Off (STO) circuit for safety-rated applications
- Internal fault protection from over-temperature, over-voltage, and over-current (short circuit) conditions.
- Dual-port communications for daisy chaining drives together (line or ring networks).

---

## Recommended Servo Motors:

J Series Servo Motors are the perfect companion.

- High power density, low rotor inertia.
- 60 to 550 Watts continuous power ratings.
- Up to 40 in-lbs peak torque.
- 40, 60 and 80 mm frame sizes.
- Integral holding brakes for vertical applications.

# SV2Dx Servo Drives

SV200 Servo Drives for DC-Powered Applications



## Drive Model Numbers

The following table lists the available SV2Dx servo drives by model number. For AC-powered SV200 drives visit [applied-motion.com](http://applied-motion.com).

Model Number	Control Modes	Communication Ports†
SV2D10-P-NE	Step & Direction, Analog Torque/Velocity	N/A
SV2D10-Q-AE	Streaming Commands, Analog Positioning, Encoder Following, Q Programming	RS-232
SV2D10-Q-RE	Streaming Commands, Analog Positioning, Encoder Following, Q Programming, Modbus RTU	RS-485
SV2D10-Q-DE	Streaming Commands, Analog Positioning, Encoder Following, Q Programming, Modbus TCP	Ethernet
SV2D10-C-CE	CANopen	CANopen
SV2D10-IP-DE*	EtherNet/IP, Q Programming	EtherNet/IP

†All non-Ethernet drives include a USB port for configuration with *SVX Servo Suite* software.

\*Contact Applied Motion Products for availability.



Sold & Serviced By:



Canadian and International Sales

**ELECTROMATE**

877-737-8698  
[sales@electromate.com](mailto:sales@electromate.com)  
[www.electromate.com](http://www.electromate.com)

U.S. Sales

**SERVO2GO.com**

877-378-0240  
[sales@servo2go.com](mailto:sales@servo2go.com)  
[www.servo2go.com](http://www.servo2go.com)

# SV2Dx Servo Drives

SV200 Servo Drives for DC-Powered Applications



## Drive Specifications

Input Power	Main Circuit		20 to 60 volts DC
	Control Circuit (optional)		10 to 60 volts DC, can be used for “keep-alive” function
Environment	Temperature		Ambient temperature: 0 to 50 °C (if the ambient temperature of the servo drive is greater than 40 °C, install the drive in a well-ventilated location). Storage temperature: -20 to 65 °C
	Humidity		Both operating and storage: 10 to 85% RH or less
	Altitude		Lower than 1000 m
	Vibration		5.88 m/s <sup>2</sup> or less, 10 to 60 Hz (do not use continuously at resonance frequency)
Control method			IGBT PWM Sinusoidal wave drive
Encoder feedback			2500 ppr optical encoder with shared or separate commutation signals
I/O	Digital Signal	Input	8 optically isolated multi-function inputs, 5-24VDC, 20mA 4 optically isolated multi-function high speed inputs, 5-24VDC, 20mA
		Output	6 optically isolated multi-function outputs, 5-24VDC, 20mA
	Analog signal	Input	2 inputs (12Bit A/D: 2 input)
	Pulse signal	Input	2 photocoupler inputs compatible with both line driver I/F and open collector I/F 2 line receiver inputs compatible with line driver I/F
		Output	3 line driver outputs, 1 open collector output
Communication	Mini USB		Programming port for connection with PC or 1:1 communication to a host.
	RS-232		RS-232 communication
	RS-485		RS-485 communication & Modbus RTU
	CAN bus		CANopen communication
	Ethernet		EtherNet/IP or eSCL
Front panel			4 keys (MODE, UP, DOWN, SET), LED (5-digit)
Regeneration Resistor			Built-in regenerative resistor (external resistor is also enabled)
Dynamic Brake			Built-in
Control inputs			(1) Servo-ON input (2) Alarm clear input (3) CW/CCW Limit (4) Pulse & Direction or CW/CCW input (5) Gain Switch (6) Control mode Switch (7) Pulse Inhibition (8) General Input
Control outputs			(1) Alarm output (2) Servo-Ready output (3) External brake release (4) Speed arrival output (5) Torque arrival output (6) Tach out (7) General output (8) Position arrival output
Certification			RoHS, EN 61800-3:2004, EN 61800-5-1:2007

Sold & Serviced By:



# SV2Dx Servo Drives

SV200 Servo Drives for DC-Powered Applications



## Drive Dimensions (mm)

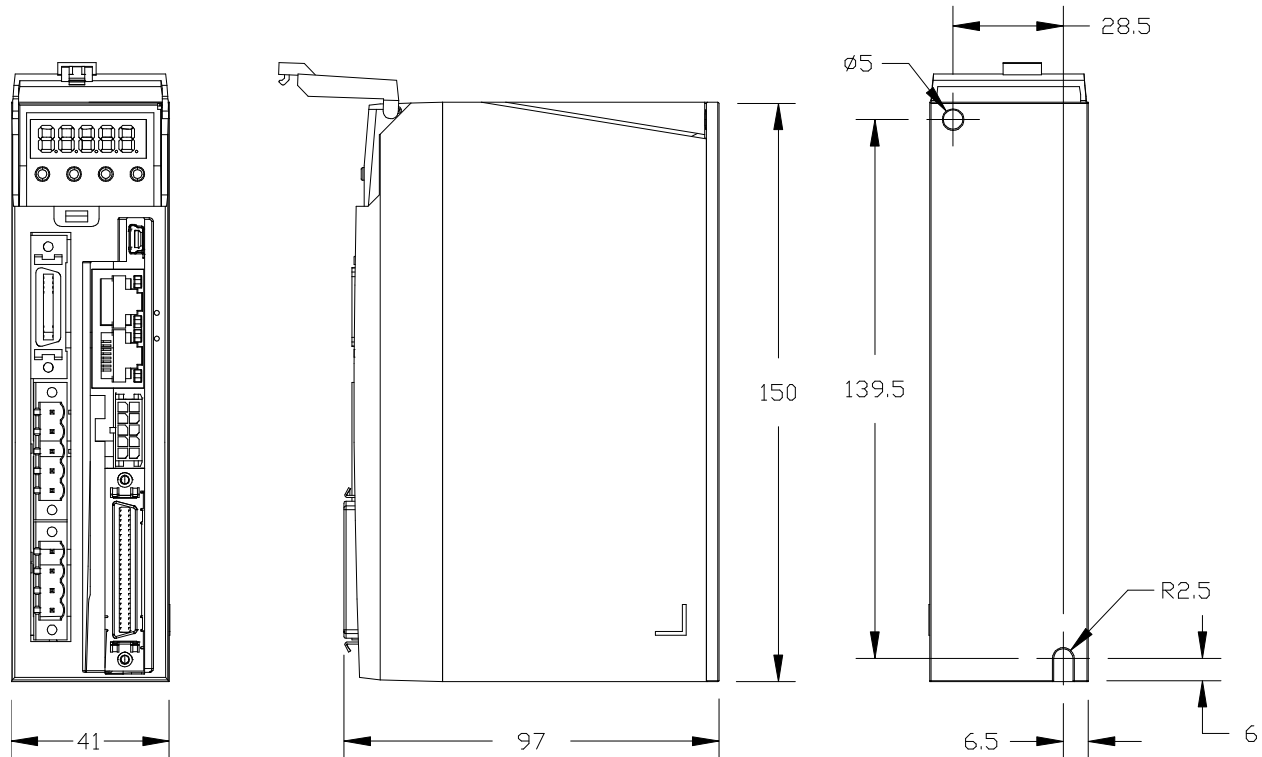

## Recommended J Series Servo Motors

The following J Series Servo Motors are recommended for use with SV2Dx servo drives. These motors ship from inventory in our Watsonville, CA warehouse. Pricing is available at [applied-motion.com](http://applied-motion.com).

Part Number	Frame Size	Rated Power (W)	Rated Voltage (VDC)	Brake	Cont. Torque (in-lb)	Peak Torque (in-lb)	Rated Current	Peak Current	Rotor Inertia (oz-in-sec <sup>2</sup> )
J0100-303-3-000	40 mm	100	24	No	2.83	8.23	5.2	15.6	6.06E-04
J0100-353-3-000	40 mm	100	24	Yes	2.83	8.23	5.2	15.6	6.99E-04
J0200-304-4-000	60 mm	200	48	No	5.66	16.8	5.2	15.6	2.34E-03
J0200-354-4-000	60 mm	200	48	Yes	5.66	16.8	5.2	15.6	3.12E-03
J0400-305-4-000	60 mm	400	60	No	11.24	33.63	6.9	20.7	3.85E-03
J0400-355-4-000	60 mm	400	60	Yes	11.24	33.63	6.9	20.7	4.61E-03

Sold & Serviced By:

Canadian and International Sales  
  
 877-737-8698  
[sales@electromate.com](mailto:sales@electromate.com)  
[www.electromate.com](http://www.electromate.com)

U.S. Sales  
  
 877-378-0240  
[sales@servo2go.com](mailto:sales@servo2go.com)  
[www.servo2go.com](http://www.servo2go.com)

# SV2Dx Servo Drives

SV200 Servo Drives for DC-Powered Applications



## Torque-Speed Curves for Recommended J Series Servo Motors

J0100-3x3-3-000(100 Watts) -5.2Amps  
DC Bus--24VDC

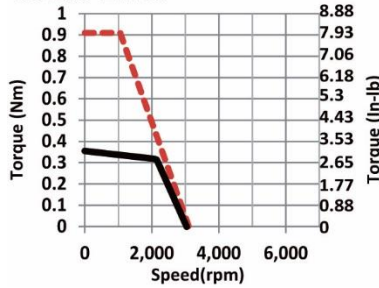

J0100-3x3-3-000(100 Watts) -5.2Amps  
DC Bus--48VDC

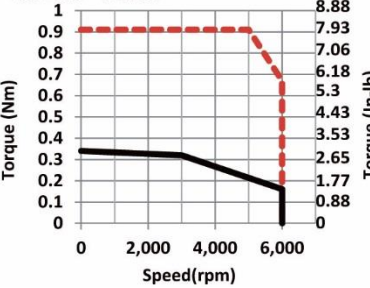

J0100-3x3-3-000(100 Watts) -5.2Amps  
DC Bus--60VDC

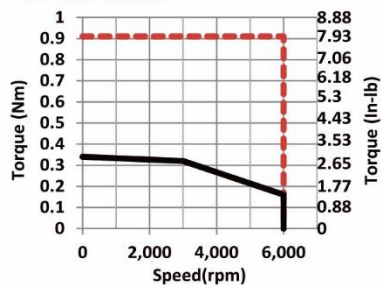

J0200-3x4-4-000(200 Watts) -10Amps  
DC Bus--24VDC

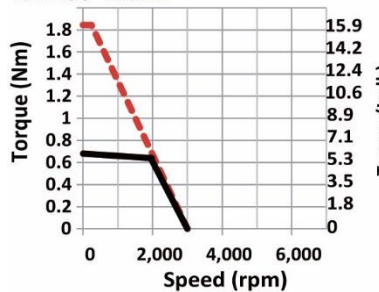

J0200-3x4-4-000(200 Watts) -10Amps  
DC Bus--48VDC

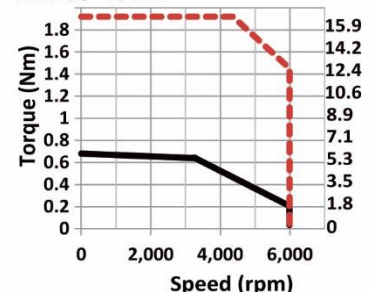

J0200-3x4-4-000(200 Watts) -10Amps  
DC Bus--60VDC

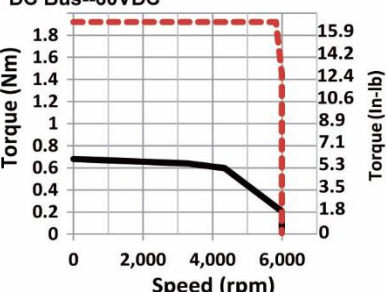

J0400-3x5-4-000(400 Watts) -6.9Amps  
DC Bus--48VDC

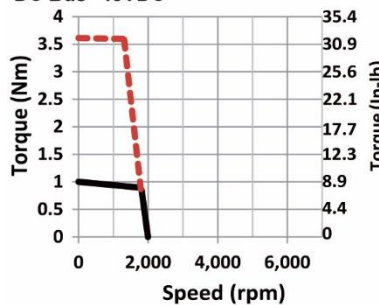

J0400-3x5-4-000(400 Watts) -6.9Amps  
DC Bus--60VDC

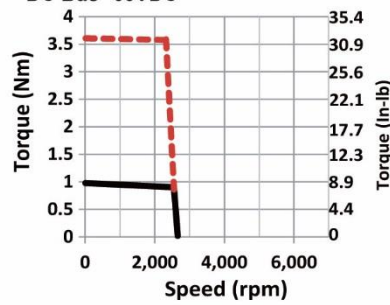

----- Max. Intermittent Torque  
 \_\_\_\_\_ Max. Continuous Torque

Sold & Serviced By:



Canadian and International Sales  
**ELECTROMATE**  
 877-737-8698  
 sales@electromate.com  
 www.electromate.com

U.S. Sales  
**SERVO2GO.com**  
 877-378-0240  
 sales@servo2go.com  
 www.servo2go.com



# SV2Dx Servo Drives

SV200 Servo Drives for DC-Powered Applications



## Special Order J Series Servo Motors

The following J Series Servo Motors are available for use with SV2Dx servo drives by special order. Contact our sales department at 1-800-525-1609 to request price and availability.

Part Number	Frame Size	Rated Power (W)	Rated Voltage	Brake	Cont. Torque (in-lb)	Peak Torque (in-lb)	Rated Current	Peak Current	Rotor Inertia (oz-in-sec <sup>2</sup> )
J0060-403-3-000	40 mm	60	24	No	1.68	4.25	5.7	14.3	3.28E-04
J0060-453-3-000	40 mm	60	24	Yes	1.68	4.25	5.7	14.3	4.22E-04
J0200-404-4-000	60 mm	200	48	No	5.66	16.8	10	30	2.34E-03
J0200-454-4-000	60 mm	200	48	Yes	5.66	16.8	10	30	3.12E-03
J0400-404-4-000	60 mm	400	48	No	10.7	31.86	10	30	3.85E-03
J0400-454-4-000	60 mm	400	48	Yes	10.7	31.86	10	30	4.61E-03
J0300-404-5-000	80 mm	300	48	No	8.41	20.35	10	25	6.37E-03
J0300-454-5-000	80 mm	300	48	Yes	8.41	20.35	10	25	7.51E-03
J0550-405-5-000	80 mm	550	60	No	15.93	40.71	10	28	8.92E-03
J0550-455-5-000	80 mm	550	60	Yes	15.93	40.71	10	28	10.05E-03

## Torque-Speed Curves for Special Order J Series Servo Motors

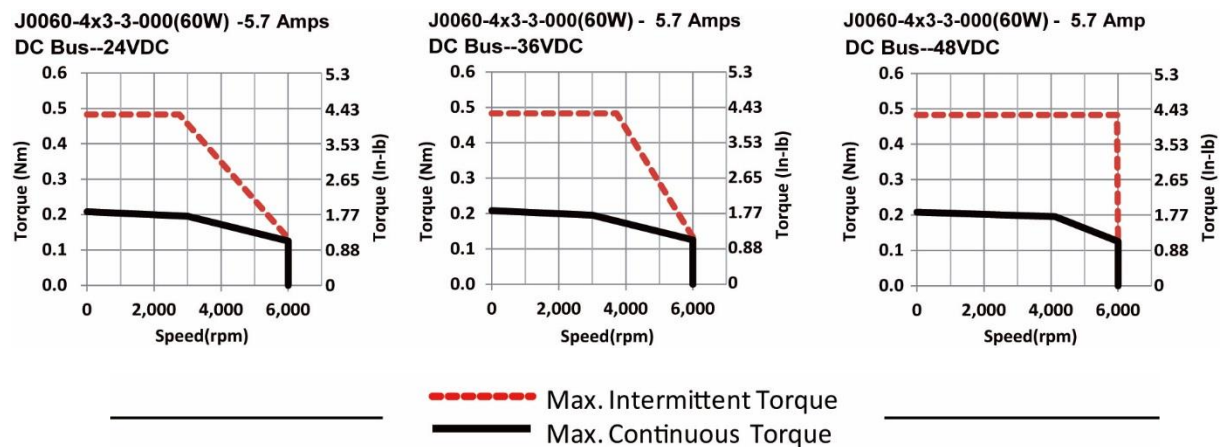

Sold & Serviced By:



# SV2Dx Servo Drives

SV200 Servo Drives for DC-Powered Applications



J0200-4x4-4-000(200 Watts) -5.2Amps  
DC Bus--48VDC

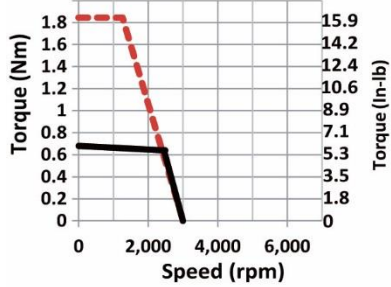

J0200-4x4-4-000(200 Watts) -5.2Amps  
DC Bus--60VDC

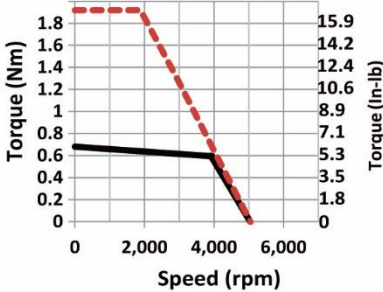

J0400-4x4-4-000(400 Watts) -10Amps  
DC Bus--24VDC

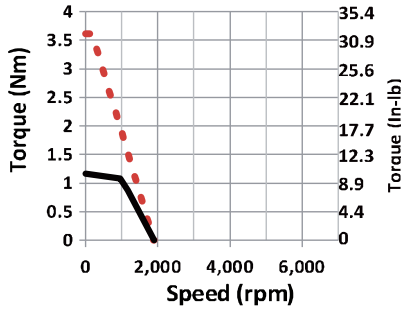

J0400-4x4-4-000(400 Watts) -10Amps  
DC Bus--48VDC

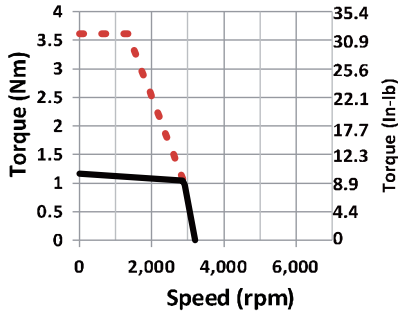

J0400-4x4-4-000(400 Watts) -10Amps  
DC Bus--60VDC

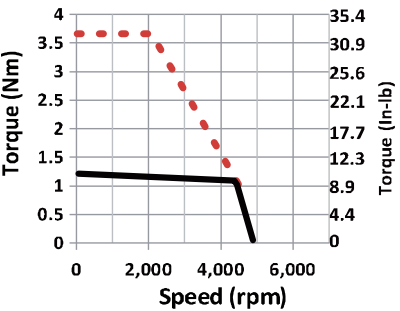

J0300-4x4-5-000(300 Watts) -10Amps  
DC Bus--24VDC

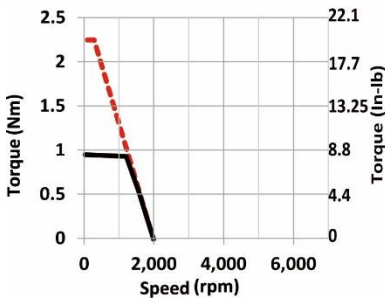

J0300-4x4-5-000(300 Watts) -10Amps  
DC Bus--48VDC

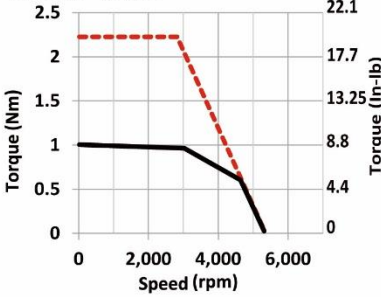

J0550-4x5-5-000(550 Watts) -10Amps  
48 VDC - 10 Amps

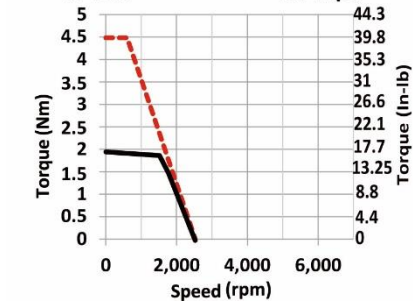

J0550-4x5-5-000(550 Watts) -10Amps  
60 VDC - 10 Amps

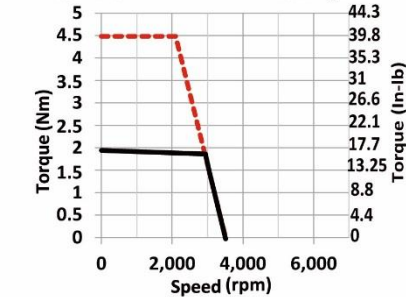

Sold & Serviced By:



Canadian and International Sales

**ELECTROMATE**

877-737-8698  
sales@electromate.com  
www.electromate.com

U.S. Sales

**SERVO2GO.com**

877-378-0240  
sales@servo2go.com  
www.servo2go.com

# SV2Dx Servo Drives

SV200 Servo Drives for DC-Powered Applications



## Drive and Motor Accessories

The following cables and accessories are specifically designed for use with SV200 servo drives and J Series servo motors.

Part Number	Description
<i>Drive Accessories</i>	
3004-327-2M	Drive I/O cable, 2 meter, flying leads
BOB-4	Drive I/O breakout board, DIN rail mount, with 0.5 m extension cable
RC880	Regen clamp for preventing DC power supplies from shutting down due to over-voltage conditions
PS150A24	Power supply, 85-265 VAC input, 24 VDC output, 150 Watts
PS320A48	Power supply, 85-265 VAC input, 48 VDC output, 320 Watts

Sold & Serviced By:

