

Sold & Serviced By:



Toll Free Phone (877) SERV098

www.electromate.com

sales@electromate.com



WAGO Rail-Mounted Terminal Block Systems

Full Line Catalog, Volume 1 – Edition 2019/2020

1

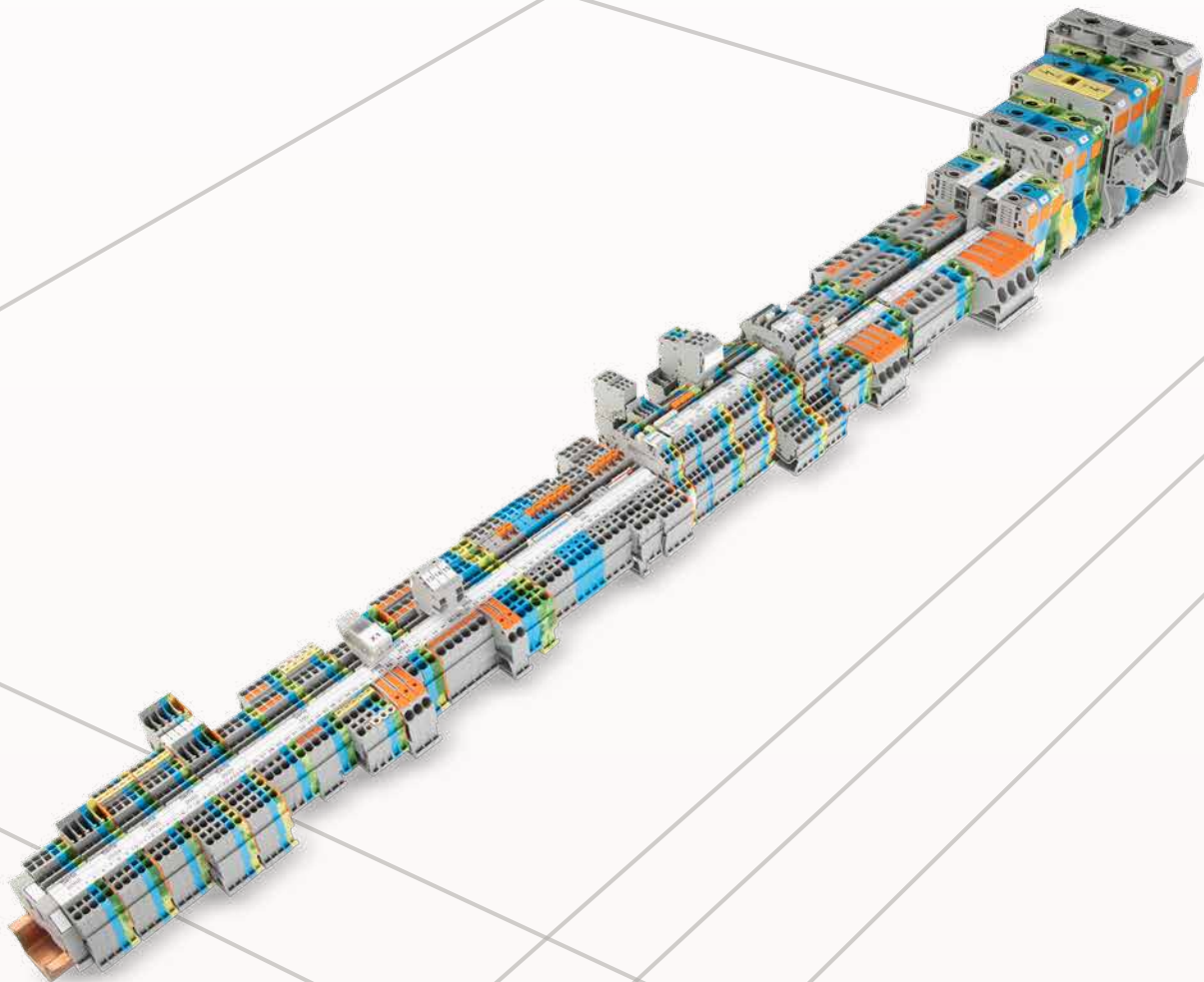

WAGO Full Line Catalogs



Volume 1, WAGO Rail-Mount Terminal Block Systems

- Rail-Mount Terminal Blocks
- Rail-Mount Terminal Blocks with Pluggable Connector (X-COM®-SYSTEM)
- Patchboard Systems
- Terminal Strips
- PUSH WIRE® Connectors for Junction Boxes
- Lighting Connectors
- Shield Connecting System



Volume 2, WAGO PCB Terminal Blocks and WAGO Connectors

- PCB Terminal Blocks
- THR/SMD PCB Terminal Blocks
- *MULTI CONNECTION SYSTEM (MCS)*
- Pluggable PCB Terminal Blocks
- Feedthrough Terminal Blocks
- Specialty Connectors
- Empty Housings



Volume 3, Automation Technology

- Solutions & Software
- Operating & Monitoring
- Controllers
- Modular I/O-SYSTEM, IP20
- Industrial Switches
- Radio Technology
- IP67 Sensor/Actuator Boxes, IP67 Cables and Connectors



Volume 4, WAGO Interface Electronic

- Relay and Optocoupler Modules
- Signal Conditioners and Isolation Amplifiers
- Current and Energy Measurement Technology
- Power Supplies
- Interface Modules and System Wiring
- Overvoltage Protection
- Empty Housings



Volume 5, WAGO Pluggable Connection System WINSTA®

- Pluggable Connectors
- Snap-In Device Connectors
- Pluggable PCB Connectors
- Distribution Connectors
- Cable Assemblies
- Flat Cable Systems
- Distribution Boxes



Volume 6, WAGO Marking

- Printer
- Software
- Terminal Block Marking
- Cable and Conductor Marking
- Device Marking
- Marker Carriers

Volume 1, WAGO Rail-Mount Terminal Block Systems

			Page	
	WAGO Rail-Mount Terminal Blocks TOPJOB® S Front-Entry Wiring	Push-in CAGE CLAMP® 1 ... 16 (25 "f-st") mm ² / 16 ... 4 AWG for DIN-35 rail	23	1
	WAGO Rail-Mount Terminal Blocks with a Pluggable Connector X-COM®S-SYSTEM Front-Entry Wiring	Push-in CAGE CLAMP® 1 ... 2.5 (4) mm ² / 16 ... 12 AWG for DIN-35 rail	161	2
	WAGO Installation Rail-Mount Terminal Blocks TOPJOB® S Front-Entry Wiring	Push-in CAGE CLAMP® 1 ... 4 (6) mm ² / 16 ... 10 AWG for DIN-35 rail	199	3
	WAGO High-Current Rail-Mount Terminal Blocks Side-Entry Wiring	POWER CAGE CLAMP 35 ... 185 mm ² / 2 AWG ... 350 kcmil, 1500 V nominal voltage, for DIN-35 rail	217	4
	WAGO Rail-Mount Terminal Blocks "Classic" WAGO Installation Rail-Mount Terminal Blocks TOPJOB® "Classic" Front-Entry Wiring	CAGE CLAMP® 1.5 ... 35 mm ² / 16 ... 2 AWG for DIN-35 rail	231	5
	WAGO Rail-Mount Terminal Blocks with a Pluggable Connector X-COM®-SYSTEM Front-Entry Wiring	CAGE CLAMP® 2.5 (4) mm ² / 12 AWG for DIN-35 rail	351	6
	WAGO Rail-Mount Terminal Blocks "Mini" WAGO Rail-Mount Terminal Blocks "Compact" Front-Entry Wiring	CAGE CLAMP® 2.5 mm ² (4 mm ²) / 12 AWG for DIN-35 and DIN-15 rails	423	7
	WAGO Modular Terminal Blocks and WAGO Terminal Strips Side-/Front-Entry Wiring	CAGE CLAMP® 1.5 ... 4 mm ² / 16 ... 12 AWG for panel mounting	447	8
	WAGO Chassis-Mount Terminal Strips WAGO Field-Wiring Terminal Blocks Side-Entry Wiring	Push-in CAGE CLAMP® 2.5 mm ² / 22 AWG, 4 mm ² / 12 AWG for panel mounting	477	9
	WAGO Rail-Mount Terminal Blocks "Classic" Side-Entry Wiring	CAGE CLAMP® 1.5 ... 16 mm ² / 16 ... 6 AWG for DIN-35 rail	499	10
	WAGO Patchboard Systems WAGO Busbar Terminal Blocks	CAGE CLAMP® 1.5 ... 16 mm ² / 16 ... 6 AWG	511	11
	WAGO Splicing Connectors WAGO Lighting Connectors		535	12
	WAGO Accessories and WAGO Tools		569	13
	Technical Section		659	14
	Indexes and Addresses		681	15

Operating WAGO Connection Technologies

Please follow the applicable product-specific termination instructions.

PUSH-IN CAGE CLAMP®



Push-in CAGE CLAMP® terminates the following copper conductors:
solid



stranded



fine-stranded,
also with tinned
single strands



fine-stranded,
tip-bonded



fine-stranded,
with ferrule
(gastight crimped)



fine-stranded,
with pin terminal
(gastight crimped)

The universal connection with an additional advantage:

Push-in connection

Terminate solid and stranded (Class B 7 strands or less), as well as ferruled conductors, by simply pushing them in – no tools required.

Termination for all conductor types:

- Open clamping unit.
- Insert the conductor.
- Release clamp – done!

CAGE CLAMP®

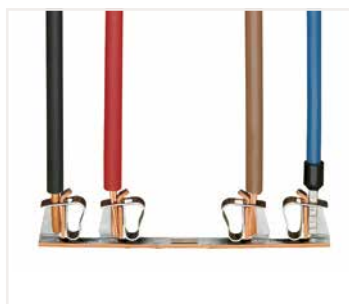

CAGE CLAMP® terminates the following copper conductors:
solid



stranded



fine-stranded,
also with tinned
single strands



fine-stranded,
tip-bonded



fine-stranded,
with ferrule
(gastight crimped)



fine-stranded,
with pin terminal
(gastight crimped)

The universal connection for solid, stranded and fine-stranded conductors

Termination:

- Open clamping unit.
- Insert the conductor.
- Release clamp – done!

Operating WAGO Connection Technologies

Please follow the applicable product-specific termination instructions.

POWER CAGE CLAMP®



POWER CAGE CLAMP terminates the following copper conductors:
solid



stranded



fine-stranded,
also with tinned
single strands



fine-stranded,
with ferrule
(gastight crimped)

The universal connection for conductors larger than 35 mm² (2 AWG)

Termination:

- Open clamp by turning a T-wrench counter-clockwise.
- Press the integrated latch to open clamping unit for hands-free wiring.
- Insert the conductor.
- A small counter-clockwise rotation closes the clamp, securing conductor.

PUSH WIRE®

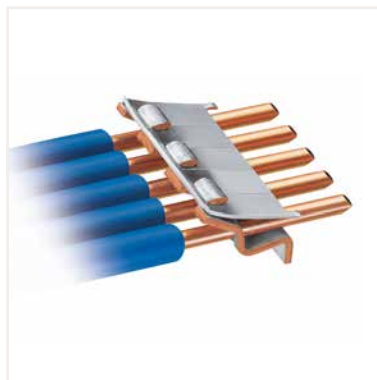

PUSH WIRE® terminates the following copper conductors:
solid

PUSH WIRE® connection for solid and stranded conductors (depending on the model used)

Termination:

Tool-free, twist-free terminations for solid and rigid stranded conductors – simply push into the unit.

Sold & Serviced By:



Toll Free Phone (877) SERV098

www.electromate.com

sales@electromate.com

Product Overview

WAGO Rail-Mount Terminal Blocks TOPJOB® S; with Push-in CAGE CLAMP® Connection

Through terminal blocks; with lever and Push-in CAGE CLAMP®



Page 26

Ground conductor terminal blocks; with lever and Push-in CAGE CLAMP®



Page 26

Through terminal blocks; with lever and push-button



Page 29

WAGO Rail-Mount Terminal Blocks TOPJOB® S; with Push-in CAGE CLAMP® Connection

Ground conductor terminal blocks; with lever and push-button



Page 29

Through terminal blocks; with push-button



Page 32

Ground conductor terminal blocks; with push-button

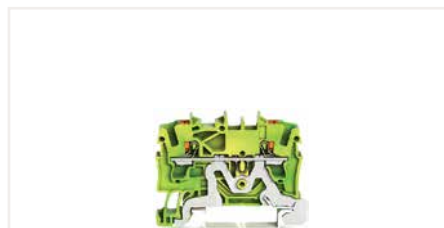

Page 32

WAGO Rail-Mount Terminal Blocks TOPJOB® S; with Push-in CAGE CLAMP® Connection

Through terminal blocks

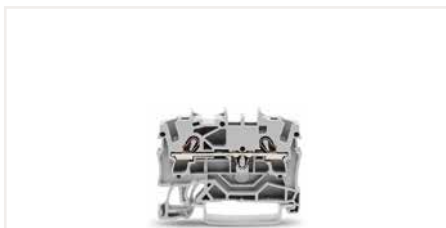

Page 46

Ground conductor terminal blocks



Page 46

Shield terminal blocks



Page 48

WAGO Rail-Mount Terminal Blocks TOPJOB® S; with Push-in CAGE CLAMP® Connection

Double-potential terminal blocks

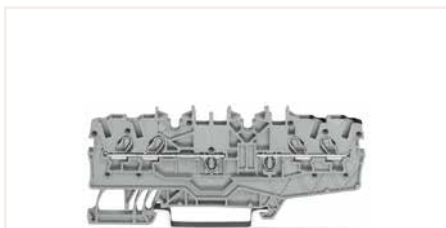

Page 47

Double-deck terminal blocks



Page 60

Double-deck disconnect terminal blocks

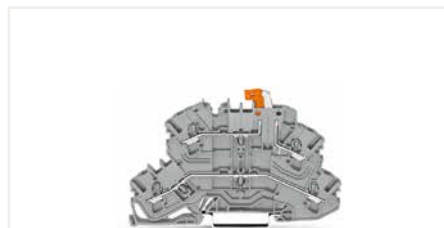

Page 74

Product Overview

WAGO Rail-Mount Terminal Blocks TOPJOB® S; with Push-in CAGE CLAMP® Connection

Double-deck carrier terminal blocks



Page 74

Double-deck fuse terminal blocks

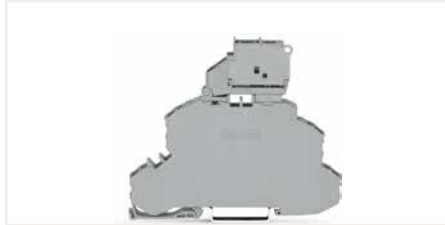

Page 75

Triple-deck terminal blocks



Page 76

WAGO Rail-Mount Terminal Blocks TOPJOB® S; with Push-in CAGE CLAMP® Connection

Quadruple-deck rail-mount terminal blocks as rail-mount terminal blocks for electric motor wiring



Page 78

Disconnect and test terminal blocks



Page 82

Disconnect/test terminal blocks; for current and voltage transformer circuits



Page 110

WAGO Rail-Mount Terminal Blocks TOPJOB® S; with Push-in CAGE CLAMP® Connection

Fuse terminal blocks for mini-automotive blade-style fuses



Page 88

Fused disconnect terminal blocks with a pivoting fuse holder for glass cartridge fuses

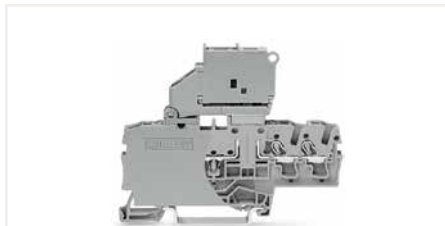

Page 90

Fuse plugs and carrier terminal blocks



Page 114

WAGO Rail-Mount Terminal Blocks TOPJOB® S; with Push-in CAGE CLAMP® Connection

Sensor terminal blocks

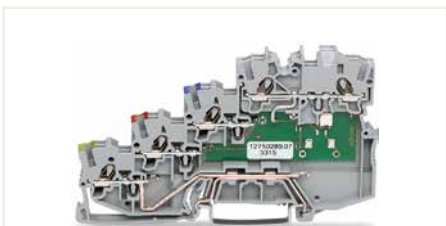

Page 120

Actuator terminal blocks

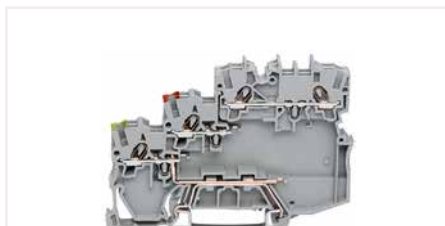

Page 122

Sensor and actuator supply terminal blocks



Page 120

Product Overview

WAGO Rail-Mount Terminal Blocks TOPJOB® S; with Push-in CAGE CLAMP® Connection

Sensor terminal blocks; with a pluggable signal level



Page 125

Actuator terminal blocks; with a pluggable signal level



Page 127

Sensor and actuator supply terminal blocks; with a pluggable signal level

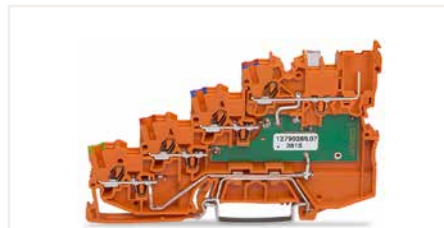

Page 125

WAGO Rail-Mount Terminal Blocks TOPJOB® S; with Push-in CAGE CLAMP® Connection

Diode terminal blocks

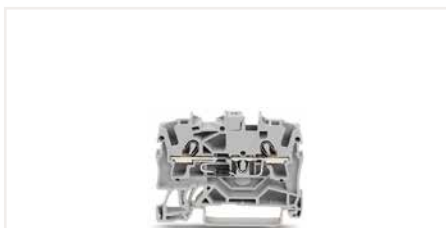

Page 128

LED terminal blocks



Page 128

Multilevel diode and LED terminal blocks



Page 134

WAGO Rail-Mount Terminal Blocks TOPJOB® S; with Push-in CAGE CLAMP® Connection

Diode modules



Page 138

LED modules



Page 140

Empty component plug housings



Page 142

WAGO Rail-Mount Terminal Blocks TOPJOB® S; with Push-in CAGE CLAMP® Connection

Component plugs



Page 144

Product Overview

WAGO Rail-Mount Terminal Blocks with a Pluggable Connector, X-COM®S-SYSTEM-MINI

Carrier terminal blocks



Page 164

Ground carrier terminal blocks



Page 164

Double-deck carrier terminal blocks

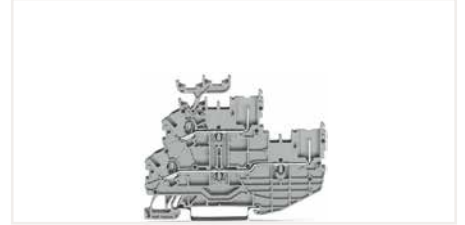

Page 166

WAGO Rail-Mount Terminal Blocks with a Pluggable Connector, X-COM®S-SYSTEM-MINI

1-conductor female plugs

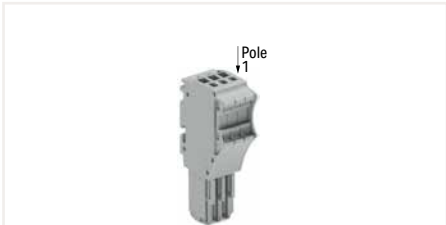

Page 168

2-conductor female plugs

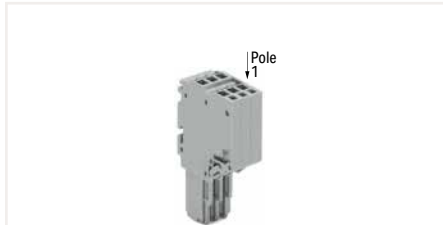

Page 168

Pre-assembled female plugs

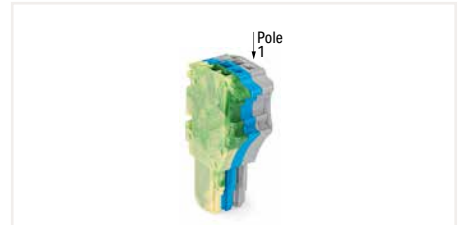

Page 172

WAGO Rail-Mount Terminal Blocks with a Pluggable Connector, X-COM®S-SYSTEM-MINI

Female plugs for self-assembly



Page 170

1-conductor female plugs; with locking levers and strain relief plates



Page 176

2-conductor female plugs; with locking levers and strain relief plates

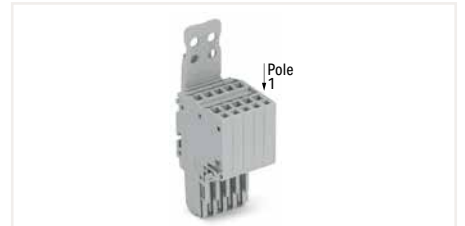

Page 178

WAGO Rail-Mount Terminal Blocks with a Pluggable Connector, X-COM®S-SYSTEM

Carrier terminal blocks



Page 180

Ground carrier terminal blocks



Page 180

Double-deck carrier terminal blocks

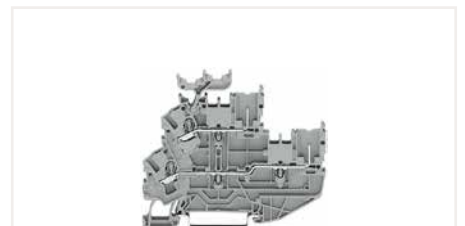

Page 182

Product Overview

WAGO Rail-Mount Terminal Blocks with a Pluggable Connector, X-COM®S-SYSTEM

Female plugs

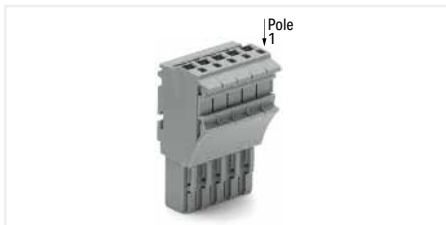

Page 184

Pre-assembled female plugs

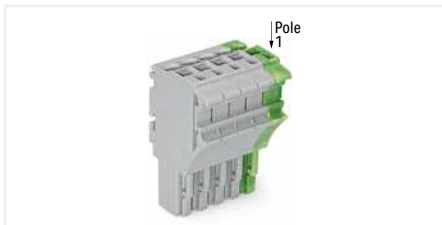

Page 188

Female plugs for self-assembly



Page 186

WAGO Rail-Mount Terminal Blocks with a Pluggable Connector, X-COM®S-SYSTEM

WAGO Rail-Mount Terminal Blocks with a Pluggable Connector, X-COM®S-SYSTEM; for Ex applications

Female plugs; with locking levers and strain relief plates



Page 190

Carrier terminal blocks; for Ex nA applications



Page 192

Ground carrier terminal blocks; for Ex nA applications



Page 192

WAGO Rail-Mount Terminal Blocks with a Pluggable Connector, X-COM®S-SYSTEM; for Ex applications

Double-deck carrier terminal blocks; for Ex nA applications



Page 194

Female plugs; for Ex nA applications



Page 196

Pre-assembled female plugs; for Ex nA applications



Page 197

WAGO Installation Rail-Mount Terminal Blocks TOPJOB® S; with Push-in CAGE CLAMP® Connection

Multilevel installation terminal blocks; with an N-disconnect slide link; 2.5 (4) mm²



Page 202

Multilevel installation terminal blocks; with an internal N-disconnection



Page 204

Double-fuse plugs



Page 208

Product Overview

WAGO Installation Rail-Mount Terminal Blocks TOPJOB® S; with Push-in CAGE CLAMP® Connection

Multilevel installation terminal blocks; with an N-disconnect slide link; 4 (6) mm² (10 AWG)



Page 210

N-conductor disconnect terminal blocks and power distribution disconnect terminal blocks



Page 212

Supply terminal blocks for distribution boxes

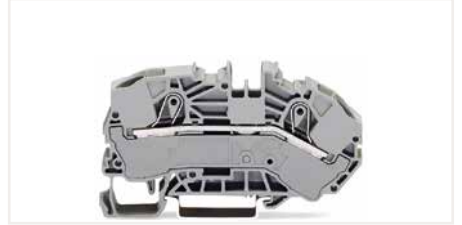

Page 214

WAGO High-Current Rail-Mount Terminal Blocks

Through terminal blocks; 35 mm² (2 AWG)



Page 220

Ground conductor terminal blocks; 35 mm² (2 AWG)



Page 220

Power taps; for high-current terminal blocks 35 mm² (2 AWG)



Page 220

WAGO High-Current Rail-Mount Terminal Blocks

Through terminal blocks; 50 mm² (1/0 AWG)



Page 224

Ground conductor terminal blocks; 50 mm² (1/0 AWG)



Page 224

Power taps; for high-current terminal blocks 50 mm² (1/0 AWG)



Page 224

WAGO High-Current Rail-Mount Terminal Blocks

Through terminal blocks with mounting flanges; 50 mm² (1/0 AWG)



Page 225

Through terminal blocks with mounting flanges; 50 mm² (1/0 AWG)



Page 225

Product Overview

WAGO High-Current Rail-Mount Terminal Blocks

Through terminal blocks; 95 mm² (4/0 AWG)



Page 226

Ground conductor terminal blocks; 95 mm² (4/0 AWG)



Page 226

Power taps; for high-current terminal blocks 95 mm² (4/0 AWG)



Page 226

WAGO High-Current Rail-Mount Terminal Blocks

Through terminal blocks with mounting flanges; 95 mm² (4/0 AWG)



Page 227

Through terminal blocks with mounting flanges; 95 mm² (4/0 AWG)



Page 227

WAGO High-Current Rail-Mount Terminal Blocks

Through terminal blocks; 185 mm² (350 kcmil)



Page 228

Ground conductor terminal blocks; 185 mm² (350 kcmil)



Page 228

Power taps; for high-current terminal blocks 185 mm² (350 kcmil)



Page 228

WAGO High-Current Rail-Mount Terminal Blocks

Through terminal blocks with mounting flanges; 185 mm² (350 kcmil)



Page 229

Through terminal blocks with mounting flanges; 185 mm² (350 kcmil)



Page 229

Product Overview

WAGO Rail-Mount Terminal Blocks, Classic; with CAGE CLAMP® Connection Front-Entry Wiring

Through terminal blocks

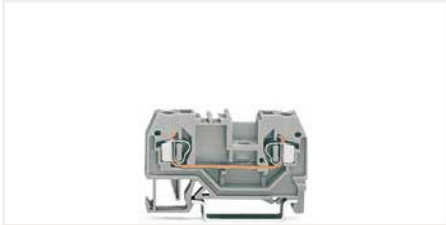

Page 234

Ground conductor terminal blocks



Page 234

Shield terminal blocks



Page 234

WAGO Rail-Mount Terminal Blocks, Classic; with CAGE CLAMP® Connection Front-Entry Wiring

Double-potential terminal blocks



Page 235

Distribution terminal blocks



Page 249

Double-deck terminal blocks



Page 252

WAGO Rail-Mount Terminal Blocks, Classic; with CAGE CLAMP® Connection Front-Entry Wiring

Triple-deck terminal blocks

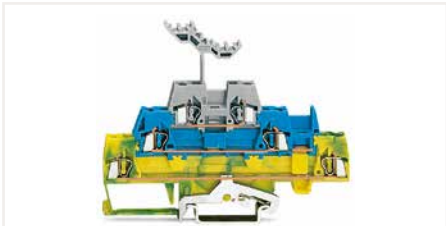

Page 262

Quadruple-deck rail-mount terminal blocks as
rail-mount terminal blocks for electric motor wiring



Page 264

Disconnect and test terminal blocks



Page 278

WAGO Rail-Mount Terminal Blocks, Classic; with CAGE CLAMP® Connection Front-Entry Wiring

Disconnect and test terminal blocks



Page 276

Disconnect/test terminal blocks; for current and voltage
transformer circuits



Page 286

Ground conductor disconnect terminal blocks



Page 292

Product Overview

WAGO Rail-Mount Terminal Blocks, Classic; with CAGE CLAMP® Connection Front-Entry Wiring

Fuse terminal blocks for mini-automotive blade-style fuses

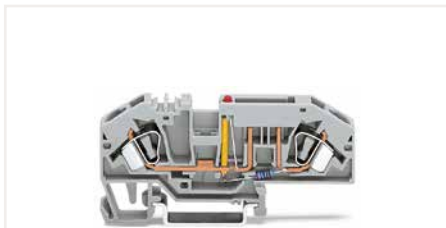

Page 294

Fused disconnect terminal blocks with a pivoting fuse holder for glass cartridge fuses



Page 298

Fuse terminal blocks; for Class CC fuses and 10 x 38 mm (1 3/8" x 1 1/2") cylindrical fuses



Page 306

WAGO Rail-Mount Terminal Blocks, Classic; with CAGE CLAMP® Connection Front-Entry Wiring

Fuse plugs and carrier terminal blocks



Page 302

Diode terminal blocks



Page 328

LED terminal blocks



Page 328

WAGO Rail-Mount Terminal Blocks, Classic; with CAGE CLAMP® Connection Front-Entry Wiring

Diode modules



Page 338

LED modules



Page 340

Sensor and actuator terminal blocks



Page 312

WAGO Rail-Mount Terminal Blocks, TOPJOB® Classic; with CAGE CLAMP® Connection

Through terminal blocks



Page 267

Ground conductor terminal blocks



Page 267

N-conductor disconnect terminal blocks and power distribution disconnect terminal blocks



Page 271

Product Overview

WAGO Rail-Mount Terminal Blocks with a Pluggable Connector, X-COM®-SYSTEM

Carrier terminal blocks



Page 358

Ground carrier terminal blocks

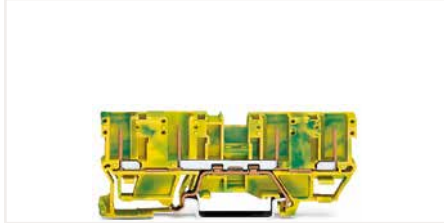

Page 358

Disconnect carrier terminal blocks



Page 370

WAGO Rail-Mount Terminal Blocks with a Pluggable Connector, X-COM®-SYSTEM

Diode carrier terminal blocks

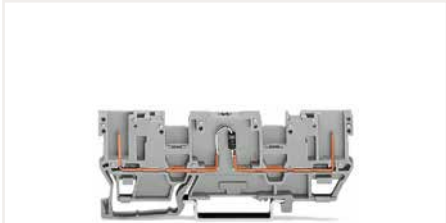

Page 372

LED carrier terminal blocks



Page 374

Carrier terminal blocks; for pluggable modules



Page 380

WAGO Rail-Mount Terminal Blocks with a Pluggable Connector, X-COM®-SYSTEM

Double-deck carrier terminal blocks



Page 388

Male connectors; with CAGE CLAMP® connection



Page 398

Male headers; with solder pins



Page 402

WAGO Rail-Mount Terminal Blocks with a Pluggable Connector, X-COM®-SYSTEM

Female plugs; with/without lateral locking lever

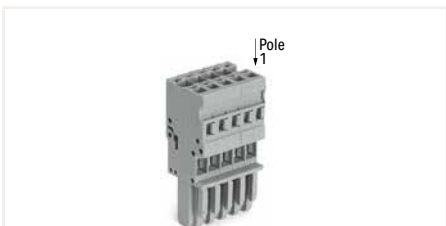

Page 408

Female plugs for self-assembly



Page 412

Pre-assembled female plugs

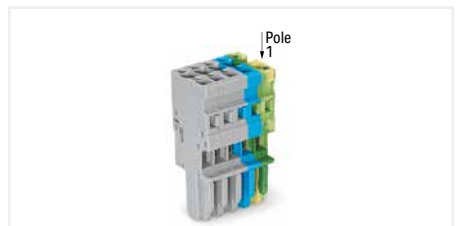

Page 414

Product Overview

WAGO Rail-Mount Terminal Blocks, Mini; with CAGE CLAMP® Connection

Through terminal blocks; for DIN-35 rail



Page 426

Ground conductor terminal blocks; for DIN-35 rail



Page 426

Through terminal blocks Ex e II; for DIN-15 rail



Page 426

WAGO Rail-Mount Terminal Blocks, Mini; with CAGE CLAMP® Connection

Through terminal blocks; for DIN-15 rail



Page 427

Ground conductor terminal blocks; for DIN-15 rail

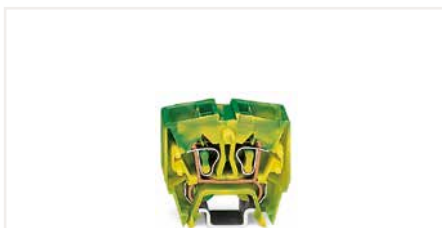

Page 427

Through terminal blocks Ex e II; for DIN-15 rail

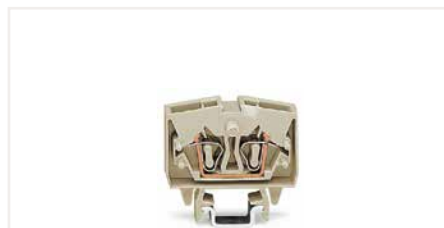

Page 427

WAGO Rail-Mount Terminal Blocks, Compact; with CAGE CLAMP COMPACT Connection

Through terminal blocks; for DIN-35 rail



Page 430

Ground conductor terminal blocks; for DIN-35 rail

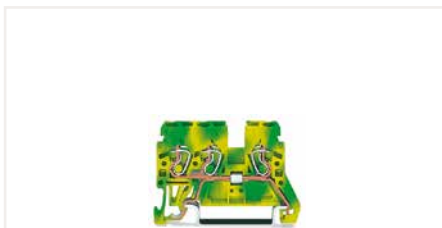

Page 430

Through terminal blocks Ex e II; for DIN-15 rail

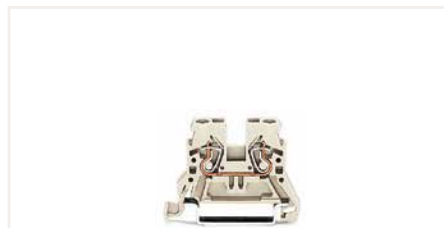

Page 430

WAGO Rail-Mount Terminal Blocks, Compact; with CAGE CLAMP COMPACT Connection

Through terminal blocks; for DIN-15 rail

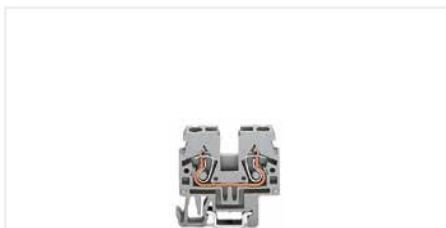

Page 431

Ground conductor terminal blocks; for DIN-15 rail

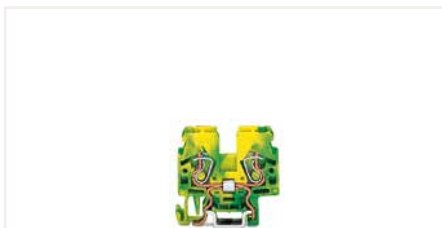

Page 431

Through terminal blocks Ex e II; for DIN-15 rail

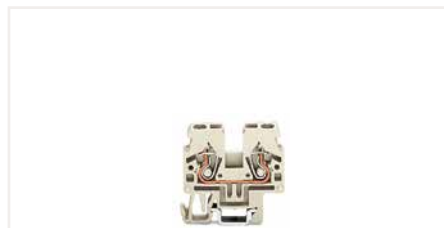

Page 431

Product Overview

WAGO Rail-Mount Terminal Blocks, Compact; with CAGE CLAMP COMPACT Connection

Double-potential terminal blocks



Page 431

Double-deck terminal blocks



Page 432

Triple-deck terminal blocks

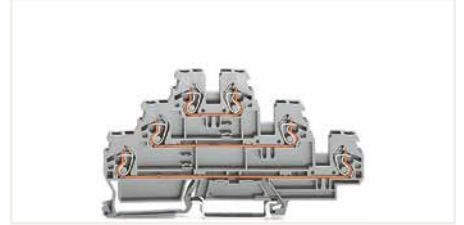

Page 434

WAGO Rail-Mount Terminal Blocks, Compact; with CAGE CLAMP COMPACT Connection

Multilevel diode and LED terminal blocks



Page 436

Pluggable tap-off modules



Page 441

Sensor and actuator terminal blocks



Page 443

WAGO Modular Terminal Blocks and WAGO Terminal Strips

Modular terminal blocks

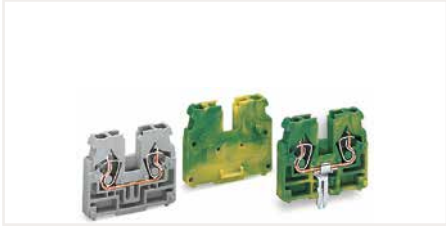

Page 450

Terminal strips; with mounting flanges



Page 449

Terminal strips; with snap-in mounting feet



Page 449

WAGO Modular Terminal Blocks and WAGO Terminal Strips

Modular terminal blocks



Page 454

Terminal strips; with mounting flanges



Page 456

Terminal strips; with snap-in mounting feet



Page 456

Product Overview

WAGO Modular Terminal Blocks and WAGO Terminal Strips

Modular terminal blocks



Page 460

Terminal strips; with mounting flanges



Page 461

Terminal strips; with snap-in mounting feet



Page 461

WAGO Chassis-Mount Terminal Strips WAGO Field-Wiring Terminal Blocks

4-conductor chassis-mount terminal strips



Page 480

Field-wiring terminal blocks



Page 489

WAGO Rail-Mount Terminal Blocks, Classic; with CAGE CLAMP® Connection Side-Entry Wiring

Through terminal blocks



Page 502

Ground conductor terminal blocks



Page 502

Disconnect and test terminal blocks



Page 506

WAGO Rail-Mount Terminal Blocks, Classic; with CAGE CLAMP® Connection Side-Entry Wiring

Ground conductor disconnect terminal blocks



Page 507

Fused disconnect terminal blocks; for glass cartridge fuses



Page 508

Product Overview

WAGO Patchboard Systems

Matrix patchboards



Page 514

Matrix patchboards; with push-buttons



Page 521

Additional modules



Page 522

WAGO Patchboard Systems

Terminal blocks for matrix patching



Page 526

Common potential terminal blocks



Page 527

3-conductor, double-potential terminal blocks or terminal blocks for matrix patching



Page 531

WAGO Busbar Terminal Blocks

Busbar terminal blocks



Page 533

Ground busbar terminal blocks



Page 533

Insulated busbar carriers



Page 533

WAGO PUSH WIRE® Connectors for Junction Boxes

COMPACT PUSH WIRE® connector for junction boxes



Page 537

COMPACT PUSH WIRE® connector for junction boxes



Page 537

Mounting carriers



Page 537

Product Overview

WAGO PUSH WIRE® Connectors for Junction Boxes

PUSH WIRE® connectors for junction boxes



Page 540

Ex PUSH WIRE® connectors for junction boxes



Page 542

Mounting carriers



Page 539

WAGO PUSH WIRE® Connectors for Junction Boxes

MICRO PUSH WIRE® connectors for junction boxes



Page 546

MICRO PUSH WIRE® connectors for junction boxes



Page 546

Mounting carriers



Page 547

WAGO Splicing Connectors for All Conductor Types

COMPACT splicing connectors for all conductor types;
4 mm²/12 AWG



Page 549

Mounting carriers



Page 551

Mounting carrier; for 4 mm²/12 AWG single connectors



Page 553

WAGO Splicing Connectors for All Conductor Types

COMPACT splicing connectors for all conductor types;
6 mm²/10 AWG



Page 555

Mounting carriers



Page 555

Product Overview

WAGO Splicing Connectors for All Conductor Types

CLASSIC splicing connectors for all conductor types



Page 557

Mounting carriers



Page 559

WAGO Lighting Connectors

Lighting connectors



Page 561

Lighting connectors



Page 561

"Service" connectors



Page 561

WAGO Splicing Connector Set

Vario-T-BOXX



Page 562

L-BOXX® 102



Page 562

Splicing connector sets



Page 564

WAGO Lighting Connectors

Luminaire disconnect connectors



Page 566

Product Overview

WAGO Shield Connection System

Shield clamping saddles



Page 575

Shield clamping saddles



Page 572

Busbar carriers



Page 578

WAGO Marking Systems

Marker cards



Page 588

WMB Inline markers



Page 588

Marking strips



Page 588

WAGO Marking Systems

Marker carriers

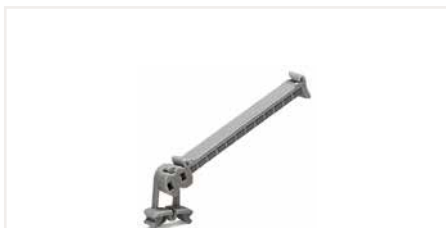

Page 599

Marker carriers



Page 597

Marking cards; self-adhesive marking strips; with marking



Page 590

WAGO Mounting Accessories

Screwless end stops



Page 606

DIN-35 rails



Page 604

Collective jumper carriers



Page 605

Product Overview

WAGO Mounting Accessories

Covers



Page 609

Screwless end stops



Page 611

DIN-15 rails



Page 611

WAGO Tools

Operating tools



Page 612

Operating tools



Page 612

Operating tools



Page 613

WAGO Tools

Cable cutter



Page 624

Cable stripper



Page 615

Wire strippers



Page 616

WAGO Tools

Crimping tools



Page 618

Ferrules



Page 619

Measurement devices



Page 626

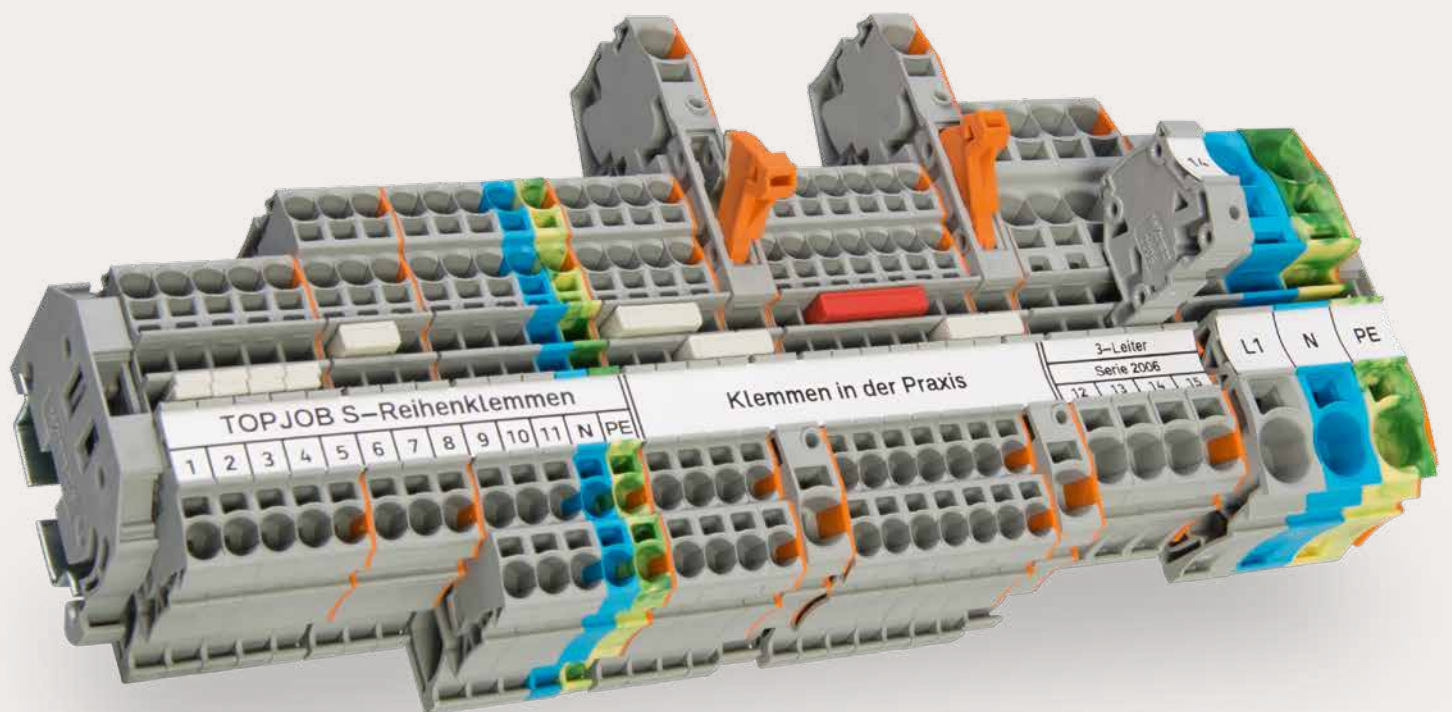

WAGO Rail-Mount Terminal Blocks TOPJOB® S

WAGO Rail-Mount Terminal Blocks TOPJOB® S

Front-Entry Wiring

			Page
	Through and Ground Conductor Terminal Blocks; with Levers and Push-in CAGE CLAMP®	2102/2106/2116 Series	26
	Through and Ground Conductor Terminal Blocks; with Levers and Push-Buttons	2102/2106/2116 Series	29
	0.25 ... 16 (25 "f-st") mm ² (22 ... 4 AWG)		
	Through and Ground Conductor Terminal Blocks; with Push-Buttons	2200 ... 2216 Series	32
	0.14 ... 16 (25 "f-st") mm ² (24 ... 4 AWG)		
	Through, Ground Conductor, Shield Conductor and Ex Terminal Blocks	2000 ... 2016 Series	46
	0.14 ... 16 (25 "f-st") mm ² (24 ... 4 AWG)		
	Multilevel Rail-Mount Terminal Blocks	2000/2002 Series	60
	1 (1.5) mm ² (16 AWG) and 2.5 (4) mm ² (12 AWG)		
	Disconnect/Test, Fuse and Through Terminal Blocks of Same Profile	2002 Series	80
	0.25 ... 2.5 (4) mm ² (22 ... 12 AWG)		
	Fused Disconnect Terminal Blocks with a Pivoting Fuse Holder	2002 Series	90
	0.25 ... 2.5 (4) mm ² (22 ... 12 AWG)		
	Disconnect, Ground Conductor Disconnect and Fuse Terminal Blocks	2006 Series	100
	0.5 ... 6 (10) mm ² (20 ... 8 AWG)		
	Disconnect/Test Terminal Blocks; for Current and Voltage Transformer Circuits	2007 Series	110
	0.5 ... 6 (10) mm ² (20 ... 8 AWG)		
	Fuse Plugs on Carrier Terminal Blocks	2004/2006 Series	114
	Sensor and Actuator Terminal Blocks	2000/2020 Series	120
	0.14 ... 1 (1.5) mm ² (24 ... 16 AWG)		
	Diode and LED Terminal Blocks	2001/2002/2004 Series	128
	0.25 ... 4 (6) mm ² (22 ... 10 AWG)		
	Multilevel Diode and LED Terminal Blocks	2002 Series	134
	0.25 ... 2.5 (4) mm ² (22 ... 12 AWG)		
	Diode, LED Modules and Empty Component Plugs Housing	2002 Series	138
	Accessories for Rail-Mount Terminal Blocks TOPJOB® S		146

Rail-Mount Terminal Blocks TOPJOB® S; with Levers and Push-in CAGE CLAMP® 2102, 2106 and 2116 Series Description and Installation

1

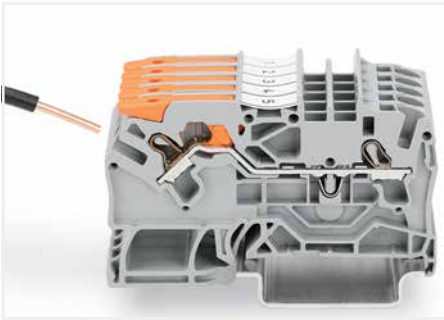

Push-in termination of solid conductors

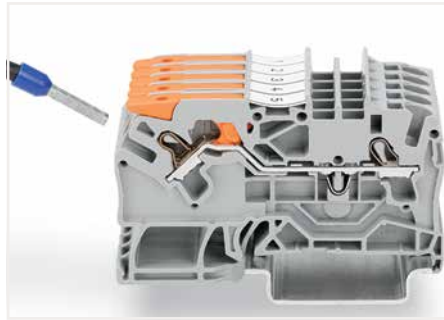

Push-in termination of fine-stranded conductors with ferrules

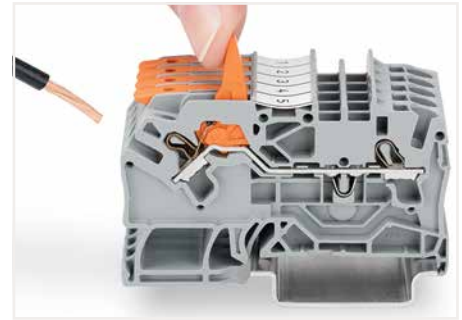

Pull the lever up until it stops, then connect the fine-stranded conductor.

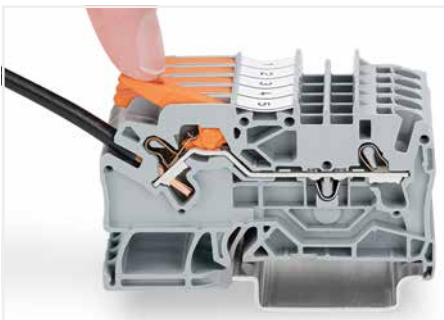

Push the lever back down – done!



Insert push-in type jumper bar and push down until it hits backstop.

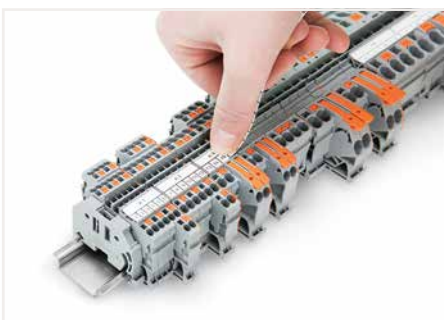
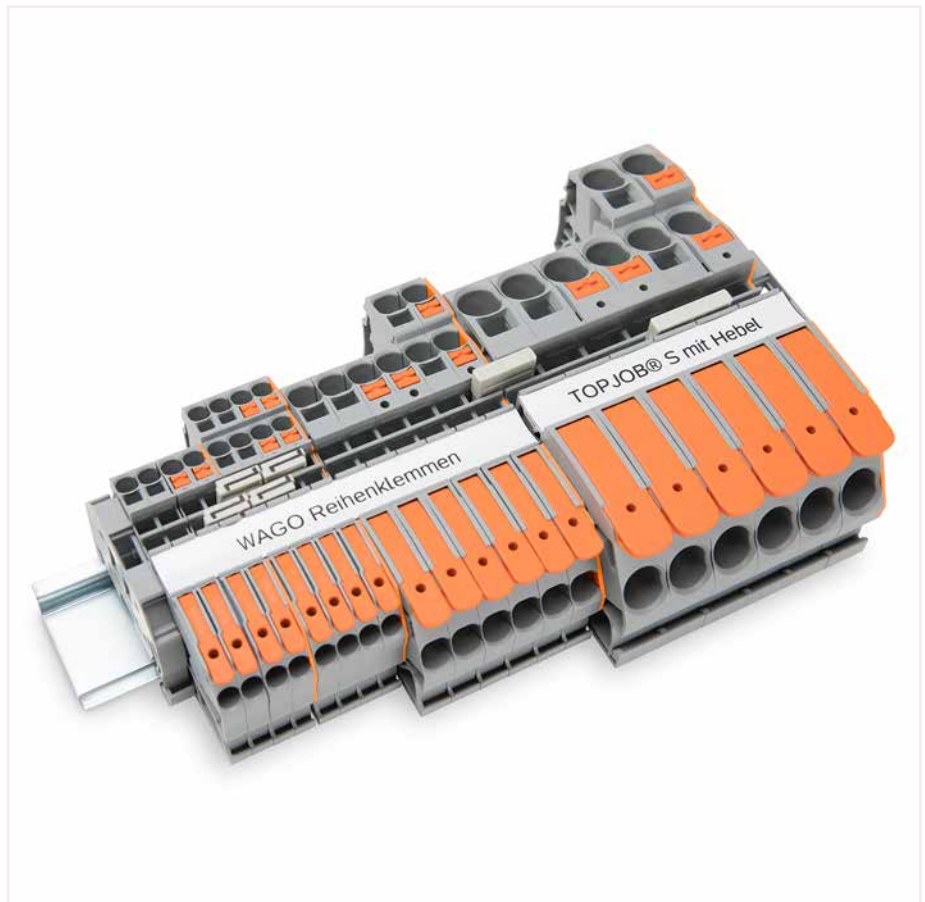

Snapping a marking strip into the marker slot.



Snapping a marking strip into the marker slot.



Testing with a 2 mm Ø test plug (max. 42 V).



Push-in CAGE CLAMP® terminates the following copper conductors:
solid



stranded



fine-stranded, also with tinned single strands

PUSH-IN CAGE CLAMP®

Rail-Mount Terminal Blocks TOPJOB® S; with Push-Buttons and Push-in CAGE CLAMP®

2200 to 2216 Series

Description and Installation

1



Push-in termination of solid and ferruled conductors



Insert fine-stranded conductors via operating tool.



Removing all conductors via operating tool.



Insert push-in type jumper bar and push down until it hits backstop.



Commoning with step-down jumpers.

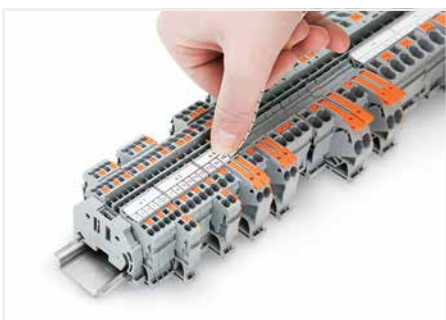

Snapping a marking strip into the marker slot.



Snapping a marking strip into the marker slot.



Testing with a 2 mm Ø test plug (max. 42 V).



fine-stranded, tip-bonded



fine-stranded, with ferrule (gastight crimped)



fine-stranded, with pin terminal (gastight crimped)

PUSH-IN CAGE CLAMP®



Through and Ground Conductor Terminal Block TOPJOB® S; with Lever and Push-in CAGE CLAMP® 2.5 (4) mm²; 2102 Series

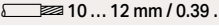

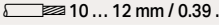
1

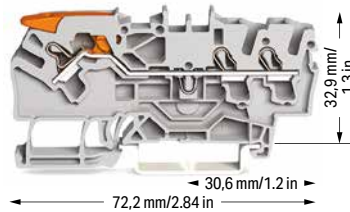
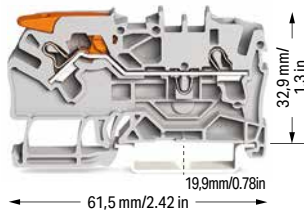
Technical Data	
0.25 ... 2.5 (4) mm ² ①	22 ... 12 AWG
800 V/8 kV/3 ②	
I _N 24 A (32 A)	
Terminal block width: 5.2 mm / 0.205 inch	
 10 ... 12 mm / 0.39 ... 0.47 inch	

Technical Data	
0.25 ... 2.5 (4) mm ² ①	22 ... 12 AWG
800 V/8 kV/3 ②	
I _N 24 A (30 A)	
Terminal block width: 5.2 mm / 0.205 inch	
 10 ... 12 mm / 0.39 ... 0.47 inch	







2-conductor through terminal block; with lever and Push-in CAGE CLAMP®		
Color	Item No.	Pack. Unit
 gray	2102-1201	50
 blue	2102-1204 ③	50

3-conductor through terminal block; with lever and Push-in CAGE CLAMP®		
Color	Item No.	Pack. Unit
 gray	2102-1301	50
 blue	2102-1304 ③	50

2-conductor ground terminal block; with lever and Push-in CAGE CLAMP®		
Color	Item No.	Pack. Unit
 green-yellow	2102-1207	50

3-conductor ground terminal block; with lever and Push-in CAGE CLAMP®		
Color	Item No.	Pack. Unit
 green-yellow	2102-1307	50

Accessories; item-specific			
End and intermediate plate; 0.8 mm thick			
	orange	2102-1292	100 (25)
	gray	2102-1291	100 (25)

Accessories; item-specific			
End and intermediate plate; 0.8 mm thick			
	orange	2102-1392	100 (25)
	gray	2102-1391	100 (25)

Accessories; 2102 Series Appropriate marking systems: WMB/WMB Inline/Marking strips

Insulation stop; 5 pcs/strip; 0.25 ... 0.5 mm ²			
Color	Item No.	Pack. Unit	
	light gray	2002-171	200 (25)

Push-in type jumper bar; insulated; I _N 25 A; light gray			
	1 to 3	2002-433	25
	1 to 4	2002-434	25
	1 to 5	2002-435	25
	1 to 6	2002-436	25
	1 to 7	2002-437	25
	1 to 8	2002-438	25
	1 to 9	2002-439	25
	1 to 10	2002-440	25

Insulation stop; 5 pcs/strip; 0.75 ... 1 mm ²			
Color	Item No.	Pack. Unit	
	dark gray	2002-172	200 (25)

Adjacent jumper for continuous commoning; insulated; I _N 25 A, light gray			
	2-way	2002-400	25

Protective warning marker; with black high-voltage symbol; for 5 terminal blocks			
Color	Item No.	Pack. Unit	
	yellow	2002-115	100 (25)

Adjacent jumper for continuous commoning; insulated; I _N 25 A; 1 to 3			
	light gray	2002-423	25
	red	2002-423/000-005	25
	blue	2002-423/000-006	25

Push-in type jumper bar; insulated; I _N 25 A; light gray			
	2-way	2002-402	25
	3-way	2002-403	25
	4-way	2002-404	25
	5-way	2002-405	25
	6-way	2002-406	25
	7-way	2002-407	25
	8-way	2002-408	25
	9-way	2002-409	25
	10-way	2002-410	25

Adjacent jumper for continuous commoning; insulated; I _N 25 A, light gray			
	5-way	2002-415	25

Delta jumper; insulated; I _N = I _N terminal block; light gray			
	1-2 3-4 5-6	2002-406/020-000	25

Push-in type wire jumper; insulated; 1.5 mm ² conductor cross-section; I _N 18 A			
	L = 60 mm	2009-412	100 (10)
	L = 110 mm	2009-414	100 (10)
	L = 250 mm	2009-416	100 (10)

Star point jumper; insulated; I _N = I _N terminal block; light gray			
	1-3-5	2002-405/011-000	25

① Conductor range: 0.25 ... 4 mm² "s+f-st"; Push-in termination: 1 ... 4 mm² "s" and 1 ... 2.5 mm² "insulated ferrules, 12 mm"
Depending on the conductor characteristic, a conductor with a smaller cross section can also be inserted via push-in termination.

② 800 V = rated voltage
8 kV = rated impulse voltage
3 = pollution degree
(see Section 14)

③ Terminal blocks with a blue insulated housing are suitable for Ex i applications.

Please observe the application notes:
Jumpers, from page 152
Testing accessories, from page 146
Marking, from page 588

Approvals and corresponding ratings, visit www.wago.com

Accessories; 2102 Series
Appropriate marking systems:
WMB/WMB Inline/Marking strips

Staggered jumper; insulated; I _N 25 A; light gray			
	2-way	2002-472	25
	3-way	2002-473	25
	4-way	2002-474	25
	5-way	2002-475	25
	6-way	2002-476	25
	7-way	2002-477	25
	8-way	2002-478	25
	9-way	2002-479	25
	10-way	2002-480	25
	11-way	2002-481	25
	12-way	2002-482	25

Customized staggered jumper; insulated; with contact lugs broken off at the factory and circuit printing; I _N 25 A; light gray			
	1-3	2002-473/011-000	25
	1-3-5	2002-475/011-000	25
	1-3-5-7	2002-477/011-000	25
	1-3-5-7-9	2002-479/011-000	25
	1-3-5-7-9-11	2002-481/011-000	25

Modular connector; snaps together; for jumper contact slot			
	gray	2002-511	100 (25)

L-type test plug module; snaps together			
	gray	2002-611	100 (25)

WMB Inline, plain; 1,500 WMB markers (5 mm)/reel; 5 ... 5.2 mm stretchable			
	white	2009-115	1

Marking strip; plain; 11 mm wide; 50 m reel			
	white	2009-110	1

WMB marking card; white; 10 strips with 10 markers/card; 5 ... 5.2 mm stretchable			
	plain	793-5501	5

Through and Ground Conductor Terminal Block TOPJOB® S; with Lever and Push-in CAGE CLAMP®

6 (10) mm²; 2106 Series

Technical Data	
0.5 ... 6 (10) mm ² ①	20 ... 8 AWG
800 V/8 kV/3 ②	
I _N 41 A (55 A)	
Terminal block width: 7.5 mm / 0.295 inch	
13 ... 15 mm / 0.51 ... 0.59 inch	

Technical Data	
0.5 ... 6 (10) mm ² ①	20 ... 8 AWG
800 V/8 kV/3 ②	
I _N 41 A (55 A)	
Terminal block width: 7.5 mm / 0.295 inch	
13 ... 15 mm / 0.51 ... 0.59 inch	

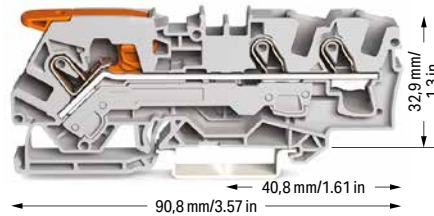

2-conductor through terminal block; with lever and Push-in CAGE CLAMP®		
Color	Item No.	Pack. Unit
gray	2106-1201	25
blue	2106-1204 ③	25

3-conductor through terminal block; with lever and Push-in CAGE CLAMP®		
Color	Item No.	Pack. Unit
gray	2106-1301	25
blue	2106-1304 ③	25

2-conductor ground terminal block; with lever and Push-in CAGE CLAMP®		
Color	Item No.	Pack. Unit
green-yellow	2106-1207	25

3-conductor ground terminal block; with lever and Push-in CAGE CLAMP®		
Color	Item No.	Pack. Unit
green-yellow	2106-1307	25

Accessories; item-specific			
End and intermediate plate; 1 mm thick			
orange	2106-1292	100 (25)	
gray	2106-1291	100 (25)	

Accessories; item-specific			
End and intermediate plate; 1 mm thick			
orange	2106-1392	100 (25)	
gray	2106-1391	100 (25)	

Accessories; 2106 Series Appropriate marking systems: WMB/WMB Inline/Marking strips

Push-in type jumper bar; insulated; I _N 41 A; light gray			
2-way	2006-402	25	
3-way	2006-403	25	
4-way	2006-404	25	
5-way	2006-405	25	

Lockout cap; for conductor entry and operating slot			
gray	2006-191	25	

Push-in type jumper bar; insulated; I _N 41 A; light gray			
1 to 3	2006-433	25	
1 to 4	2006-434	25	
1 to 5	2006-435	25	

Modular connector; snaps together; for jumper contact slot			
gray	2006-511	50 (25)	

Star point jumper; insulated; I _N = I _N terminal block; light gray			
1-3-5	2006-405/011-000	25	

Test plug adapter; for 4 mm Ø test plug			
gray	2009-174	100 (25)	

Protective warning marker; with black high-voltage symbol; for 5 terminal blocks			
yellow	2006-115	100 (25)	

Marking strip; plain; 11 mm wide; 50 m reel			
white	2009-110	1	

WMB marking card; white; 10 strips with 10 markers/card; 5 ... 5.2 mm stretchable			
plain	793-5501	5	

- Conductor range: 0.5 ... 10 mm² "s+f-st"; Push-in termination: 2.5 ... 10 mm² "s" and 2.5 ... 6 mm² "insulated ferrules; 12 mm" Depending on the conductor characteristic, a conductor with a smaller cross section can also be inserted via push-in termination.
 - 800 V = rated voltage
8 kV = rated impulse voltage
3 = pollution degree (see Section 14)
 - Terminal blocks with a blue insulated housing are suitable for Ex i applications.
- Please observe the application notes:
Jumpers, from page 155
Testing accessories, from page 148
Marking, from page 588
- Approvals and corresponding ratings, visit www.wago.com

1

PUSH-IN CAGE CLAMP®

Through and Ground Conductor Terminal Block TOPJOB® S; with Lever and Push-in CAGE CLAMP®

16 (25 "f-st") mm²; 2102 Series

1

Technical Data	
0.5 ... 16 (25 "f-st") mm ² ①	20 ... 4 AWG
800 V/8 kV/3 ②	
I _N 76 A (90 A)	
Terminal block width: 12 mm / 0.472 inch	
 18 ... 20 mm / 0.71 ... 0.79 inch	

Technical Data	
0.5 ... 16 (25 "f-st") mm ² ①	20 ... 4 AWG
800 V/8 kV/3 ②	
I _N 76 A (90 A)	
Terminal block width: 12 mm / 0.472 inch	
 18 ... 20 mm / 0.71 ... 0.79 inch	

① Conductor range: 0.5 ... 16 mm² "s+f-st", 25 mm² "f-st"; Push-in termination: 6 ... 16 mm² "s" and 6 ... 16 mm² "insulated ferrules; 18 mm"
Depending on the conductor characteristic, a conductor with a smaller cross section can also be inserted via push-in termination.



② 800 V = rated voltage
8 kV = rated impulse voltage
3 = pollution degree
(see Section 14)

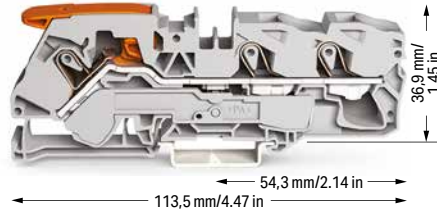
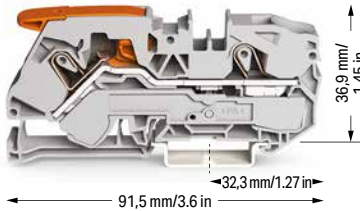

③ Terminal blocks with a blue insulated housing are suitable for Ex i applications.

Please observe the application notes:
Jumpers, from page 155
Testing accessories, from page 149
Marking, from page 588

Approvals and corresponding ratings, visit www.wago.com







2-conductor through terminal block; with lever and Push-in CAGE CLAMP®		
Color	Item No.	Pack. Unit
 gray	2116-1201	20
 blue	2116-1204 ③	20

3-conductor through terminal block; with lever and Push-in CAGE CLAMP®		
Color	Item No.	Pack. Unit
 gray	2116-1301	20
 blue	2116-1304 ③	20





2-conductor ground terminal block; with lever and Push-in CAGE CLAMP®		
15 mm high DIN-35 rails shall be used for a current load higher than 76 A!		
Color	Item No.	Pack. Unit
 green-yellow	2116-1207	20

3-conductor ground terminal block; with lever and Push-in CAGE CLAMP®		
15 mm high DIN-35 rails shall be used for a current load higher than 76 A!		
Color	Item No.	Pack. Unit
 green-yellow	2116-1307	20



Accessories; item-specific			
End and intermediate plate; 1 mm thick			
	orange	2116-1292	100 (25)
	gray	2116-1291	100 (25)

Accessories; item-specific			
End and intermediate plate; 1 mm thick			
	orange	2116-1392	100 (25)
	gray	2116-1391	100 (25)

Accessories; 2116 Series
Appropriate marking systems: WMB/WMB Inline/Marking strips

Push-in type jumper bar; insulated; I _N 41 A; light gray			
	2-way	2016-402	25
	3-way	2016-403	25
	4-way	2016-404	25
	5-way	2016-405	25

Finger guard; touch-proof cover protects unused conductor entries			
	yellow	2016-100	100 (25)

Push-in type jumper bar; insulated; I _N 41 A; light gray			
	1 to 3	2016-433	25
	1 to 4	2016-434	25
	1 to 5	2016-435	25

Modular connector; snaps together; for jumper contact slot			
	gray	2016-511	50 (25)

Star point jumper; insulated; I _N = I _N terminal block; light gray			
	1-3-5	2016-405/011-000	25

Test plug adapter; for 4 mm Ø test plug			
	gray	2009-174	100 (25)

Protective warning marker; with black high-voltage symbol; for 5 terminal blocks			
	yellow	2016-115	100 (25)

Marking strip; plain; 11 mm wide; 50 m reel			
	white	2009-110	1

WMB marking card; white; 10 strips with 10 markers/card; 5 ... 5.2 mm stretchable			
	plain	793-5501	5

Through and Ground Conductor Terminal Block TOPJOB® S; with Lever and Push-Button 2.5 (4) mm²; 2102 Series

Technical Data	
0.25 ... 2.5 (4) mm ² ①	22 ... 12 AWG
800 V/8 kV/3 ②	
I _N 24 A (32 A)	
Terminal block width: 5.2 mm / 0.205 inch	
 10 ... 12 mm / 0.39 ... 0.47 inch	

Technical Data	
0.25 ... 2.5 (4) mm ² ①	22 ... 12 AWG
800 V/8 kV/3 ②	
I _N 24 A (30 A)	
Terminal block width: 5.2 mm / 0.205 inch	
 10 ... 12 mm / 0.39 ... 0.47 inch	

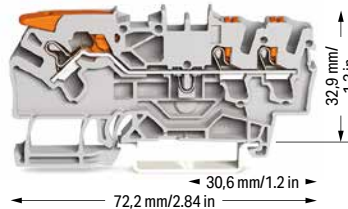
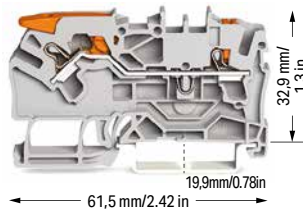





2-conductor through terminal block; with lever and push-button		
Color	Item No.	Pack. Unit
gray	2102-5201	50
blue	2102-5204 ③	50

3-conductor through terminal block; with lever and push-button		
Color	Item No.	Pack. Unit
gray	2102-5301	50
blue	2102-5304 ③	50

2-conductor ground terminal block; with lever and push-button		
Color	Item No.	Pack. Unit
green-yellow	2102-5207	50

3-conductor ground terminal block; with lever and push-button		
Color	Item No.	Pack. Unit
green-yellow	2102-5307	50

Accessories; item-specific			
End and intermediate plate; 0.8 mm thick			
	orange	2102-1292	100 (25)
	gray	2102-1291	100 (25)



Accessories; item-specific			
End and intermediate plate; 0.8 mm thick			
	orange	2102-1392	100 (25)
	gray	2102-1391	100 (25)









Accessories; 2102 Series Appropriate marking systems: WMB/WMB Inline/Marking strips

Insulation stop; 5 pcs/strip; 0.25 ... 0.5 mm ²			
	light gray	2002-171	200 (25)









Adjacent jumper for continuous commoning; insulated; I _N 25 A, light gray			
	2-way	2002-400	25



Insulation stop; 5 pcs/strip; 0.75 ... 1 mm ²			
	dark gray	2002-172	200 (25)

Adjacent jumper for continuous commoning; insulated; I _N 25 A; 1 to 3			
	light gray	2002-423	25
	red	2002-423/000-005	25
	blue	2002-423/000-006	25







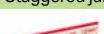



Push-in type jumper bar; insulated; I _N 25 A; light gray			
	2-way	2002-402	25
	3-way	2002-403	25
	4-way	2002-404	25
	5-way	2002-405	25
	6-way	2002-406	25
	7-way	2002-407	25
	8-way	2002-408	25
	9-way	2002-409	25
	10-way	2002-410	25

Adjacent jumper for continuous commoning; insulated; I _N 25 A, light gray			
	5-way	2002-415	25

Push-in type jumper bar; insulated; I _N 25 A; light gray			
	1 to 3	2002-433	25
	1 to 4	2002-434	25
	1 to 5	2002-435	25
	1 to 6	2002-436	25
	1 to 7	2002-437	25
	1 to 8	2002-438	25
	1 to 9	2002-439	25
	1 to 10	2002-440	25

Push-in type wire jumper; insulated; 1.5 mm ² conductor cross-section; I _N 18 A			
	L = 60 mm	2009-412	100 (10)
	L = 110 mm	2009-414	100 (10)
	L = 250 mm	2009-416	100 (10)

Delta jumper; insulated; I _N = I _N terminal block; light gray			
	1-2 3-4 5-6	2002-406/020-000	25

Staggered jumper; insulated; I _N 25 A; light gray			
	2-way	2002-472	25
	3-way	2002-473	25
	4-way	2002-474	25
	5-way	2002-475	25
	6-way	2002-476	25
	7-way	2002-477	25
	8-way	2002-478	25
	9-way	2002-479	25
	10-way	2002-480	25
	11-way	2002-481	25
	12-way	2002-482	25

① Conductor range: 0.25 ... 4 mm² "s+f-st"; Push-in termination: 1 ... 4 mm² "s" and 1 ... 2.5 mm² "insulated ferrules, 12 mm"
Depending on the conductor characteristic, a conductor with a smaller cross section can also be inserted via push-in termination.

② 800 V = rated voltage
8 kV = rated impulse voltage
3 = pollution degree
(see Section 14)

③ Terminal blocks with a blue insulated housing are suitable for Ex i applications.

Please observe the application notes:
Jumpers, from page 152
Testing accessories, from page 146
Marking, from page 588

Approvals and corresponding ratings, visit www.wago.com

Accessories; 2102 Series
Appropriate marking systems:
WMB/WMB Inline/Marking strips

Customized staggered jumper; insulated; with contact lugs broken off at the factory and circuit printing; I_N 25 A; light gray

	1-3	2002-473/011-000	25
	1-3-5	2002-475/011-000	25
	1-3-5-7	2002-477/011-000	25
	1-3-5-7-9	2002-479/011-000	25
	1-3-5-7-9-11	2002-481/011-000	25

Star point jumper; insulated; I_N = I_N terminal block; light gray

	1-3-5	2002-405/011-000	25
---	-------	------------------	----

Modular connector; snaps together; for jumper contact slot

	gray	2002-511	100 (25)
---	------	----------	----------

Spacer module; snaps together; bridges commoned terminal blocks

	gray	2002-549	100 (25)
---	------	----------	----------

End plate; for modular connector; 1.5 mm thick

	gray	2002-541	100 (25)
---	------	----------	----------

WMB Inline, plain; 1,500 WMB markers (5 mm)/reel; 5 ... 5.2 mm stretchable

	white	2009-115	1
---	-------	----------	---

Marking strip; plain; 11 mm wide; 50 m reel

	white	2009-110	1
---	-------	----------	---

Through and Ground Conductor Terminal Block TOPJOB® S; with Lever and Push-Button 6 (10) mm²; 2106 Series

1

Technical Data

0.5 ... 6 (10) mm² ① | 20 ... 8 AWG

800 V/8 kV/3 ②

I_N 41 A (55 A)

Terminal block width: 7.5 mm / 0.295 inch

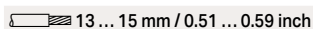
 13 ... 15 mm / 0.51 ... 0.59 inch

Technical Data

0.5 ... 6 (10) mm² ① | 20 ... 8 AWG

800 V/8 kV/3 ②

I_N 41 A (55 A)

Terminal block width: 7.5 mm / 0.295 inch

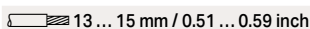
 13 ... 15 mm / 0.51 ... 0.59 inch

① Conductor range: 0.5 ... 10 mm² "s+f-st"; Push-in termination: 2.5 ... 10 mm² "s" and 2.5 ... 6 mm² "insulated ferrules; 12 mm" Depending on the conductor characteristic, a conductor with a smaller cross section can also be inserted via push-in termination.

② 800 V = rated voltage
8 kV = rated impulse voltage
3 = pollution degree
(see Section 14)

③ Terminal blocks with a blue insulated housing are suitable for Ex i applications.

Please observe the application notes:
Jumpers, from page 155
Testing accessories, from page 148
Marking, from page 588

Approvals and corresponding ratings, visit www.wago.com

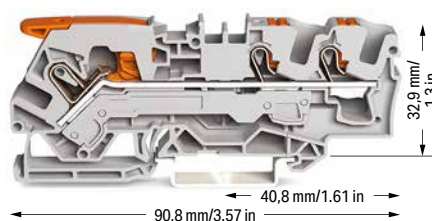
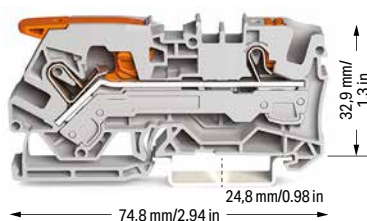

2-conductor through terminal block; with lever and push-button

Color	Item No.	Pack. Unit
gray	2106-5201	25
blue	2106-5204 ③	25

3-conductor through terminal block; with lever and push-button

Color	Item No.	Pack. Unit
gray	2106-5301	25
blue	2106-5304 ③	25

2-conductor ground terminal block; with lever and push-button

green-yellow	2106-5207	25
--------------	-----------	----

3-conductor ground terminal block; with lever and push-button

green-yellow	2106-5307	25
--------------	-----------	----

Accessories; item-specific

End and intermediate plate; 1 mm thick

orange	2106-1292	100 (25)
gray	2106-1291	100 (25)

Accessories; item-specific

End and intermediate plate; 1 mm thick

orange	2106-1392	100 (25)
gray	2106-1391	100 (25)

Accessories; 2106 Series

Appropriate marking systems: WMB/WMB Inline/Marking strips

Push-in type jumper bar; insulated; I_N 41 A; light gray

	2-way	2006-402	25
	3-way	2006-403	25
	4-way	2006-404	25
	5-way	2006-405	25

Push-in type jumper bar; insulated; I_N 41 A; light gray

	1 to 3	2006-433	25
	1 to 4	2006-434	25
	1 to 5	2006-435	25

Star point jumper; insulated; I_N = I_N terminal block; light gray

	1-3-5	2006-405/011-000	25
---	-------	------------------	----

Lockout cap; for conductor entry and operating slot

	gray	2006-191	25
---	------	----------	----

Modular connector; snaps together; for jumper contact slot

	gray	2006-511	50 (25)
---	------	----------	---------

Test plug adapter; for 4 mm Ø test plug

	gray	2009-174	100 (25)
---	------	----------	----------

Marking strip; plain; 11 mm wide; 50 m reel

	white	2009-110	1
---	-------	----------	---

WMB marking card; white; 10 strips with 10 markers/card; 5 ... 5.2 mm stretchable

	plain	793-5501	5
---	-------	----------	---

Through and Ground Conductor Terminal Block TOPJOB® S; with Lever and Push-Button 16 (25 "f-st") mm²; 2102 Series

Technical Data	
0.5 ... 16 (25 "f-st") mm ² ①	20 ... 4 AWG
800 V/8 kV/3 ②	
I _N 76 A (90 A)	
Terminal block width: 12 mm / 0.472 inch	
 18 ... 20 mm / 0.71 ... 0.79 inch	

Technical Data	
0.5 ... 16 (25 "f-st") mm ² ①	20 ... 4 AWG
800 V/8 kV/3 ②	
I _N 76 A (90 A)	
Terminal block width: 12 mm / 0.472 inch	
 18 ... 20 mm / 0.71 ... 0.79 inch	

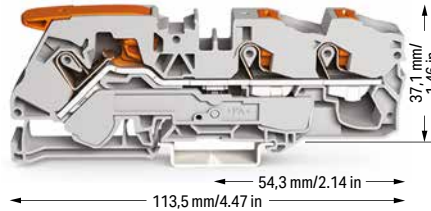
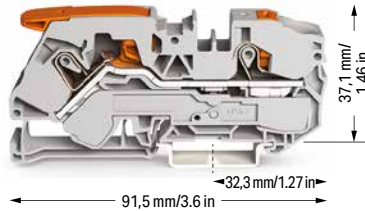





2-conductor through terminal block; with lever and push-button		
Color	Item No.	Pack. Unit
○ gray	2116-5201	20
● blue	2116-5204 ③	20

3-conductor through terminal block; with lever and push-button		
Color	Item No.	Pack. Unit
○ gray	2116-5301	20
● blue	2116-5304 ③	20

2-conductor ground terminal block; with lever and push-button 15 mm high DIN-35 rails shall be used for a current load higher than 76 A!		
Color	Item No.	Pack. Unit
● green-yellow	2116-5207	20

3-conductor ground terminal block; with lever and push-button 15 mm high DIN-35 rails shall be used for a current load higher than 76 A!		
Color	Item No.	Pack. Unit
● green-yellow	2116-5307	20

Accessories; item-specific			
End and intermediate plate; 1 mm thick			
	orange	2116-1292	100 (25)
	gray	2116-1291	100 (25)

Accessories; item-specific			
End and intermediate plate; 1 mm thick			
	orange	2116-1392	100 (25)
	gray	2116-1391	100 (25)

Accessories; 2116 Series
Appropriate marking systems: WMB/WMB Inline/Marking strips

Push-in type jumper bar; insulated; I _N 41 A; light gray			
	2-way	2016-402	25
	3-way	2016-403	25
	4-way	2016-404	25
	5-way	2016-405	25

Finger guard; touch-proof cover protects unused conductor entries			
	yellow	2016-100	100 (25)

Push-in type jumper bar; insulated; I _N 41 A; light gray			
	1 to 3	2016-433	25
	1 to 4	2016-434	25
	1 to 5	2016-435	25

Modular connector; snaps together; for jumper contact slot			
	gray	2016-511	50 (25)

Star point jumper; insulated; I _N = I _N terminal block; light gray			
	1-3-5	2016-405/011-000	25

Test plug adapter; for 4 mm Ø test plug			
	gray	2009-174	100 (25)

Marking strip; plain; 11 mm wide; 50 m reel			
	white	2009-110	1

WMB marking card; white; 10 strips with 10 markers/card; 5 ... 5.2 mm stretchable			
	plain	793-5501	5

① Conductor range: 0.5 ... 16 mm² "s+f-st", 25 mm² "f-st"; Push-in termination: 6 ... 16 mm² "s" and 6 ... 16 mm² "insulated ferrules; 18 mm"
Depending on the conductor characteristic, a conductor with a smaller cross section can also be inserted via push-in termination.

② 800 V = rated voltage
8 kV = rated impulse voltage
3 = pollution degree
(see Section 14)

③ Terminal blocks with a blue insulated housing are suitable for Ex i applications.

Please observe the application notes:
Jumpers, from page 155
Testing accessories, from page 149
Marking, from page 588

Approvals and corresponding ratings, visit www.wago.com

Through and Ground Conductor Terminal Block TOPJOB® S; with Push-Button 1 (1.5) mm²; 2200 Series

1

Technical Data	
0.14 ... 1 (1.5) mm ² ①	24 ... 16 AWG
800 V/8 kV/3 ②	
I _N 13.5 A (18 A)	
Terminal block width: 3.5 mm / 0.138 inch	
9 ... 11 mm / 0.35 ... 0.43 inch	

Technical Data	
0.14 ... 1 (1.5) mm ² ①	24 ... 16 AWG
800 V/8 kV/3 ②	
I _N 13.5 A (18 A)	
Terminal block width: 3.5 mm / 0.138 inch	
9 ... 11 mm / 0.35 ... 0.43 inch	

Technical Data	
0.14 ... 1 (1.5) mm ² ①	24 ... 16 AWG
800 V/8 kV/3 ②	
I _N 13.5 A (18 A)	
Terminal block width: 3.5 mm / 0.138 inch	
9 ... 11 mm / 0.35 ... 0.43 inch	

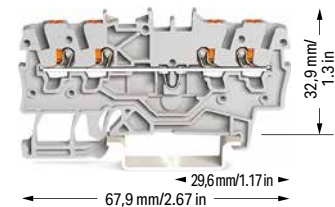
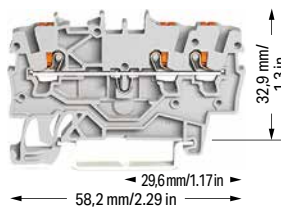
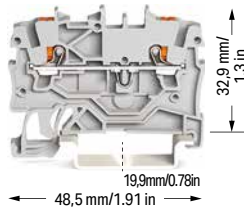

2-conductor through terminal block; with push-button		
Color	Item No.	Pack. Unit
○ gray	2200-1201	100
● blue	2200-1204 ③	100

3-conductor through terminal block; with push-button		
Color	Item No.	Pack. Unit
○ gray	2200-1301	100
● blue	2200-1304 ③	100

4-conductor through terminal block; with push-button		
Color	Item No.	Pack. Unit
○ gray	2200-1401	100
● blue	2200-1404 ③	100

2-conductor ground terminal block; with push-button		
● green-yellow	2200-1207	100

3-conductor ground terminal block; with push-button		
● green-yellow	2200-1307	100

4-conductor ground terminal block; with push-button		
● green-yellow	2200-1407	100

Accessories; item-specific			
End and intermediate plate; 0.7 mm thick			
orange	2000-1292	100 (25)	
gray	2000-1291	100 (25)	

Accessories; item-specific			
End and intermediate plate; 0.7 mm thick			
orange	2000-1392	100 (25)	
gray	2000-1391	100 (25)	

Accessories; item-specific			
End and intermediate plate; 0.7 mm thick			
orange	2000-1492	100 (25)	
gray	2000-1491	100 (25)	

Accessories; 2200 Series

Appropriate marking systems: WMB/WMB Inline/Marking strips

Push-in type jumper bar; insulated; I _N 14 A; light gray			
	2-way	2000-402	25
	3-way	2000-403	25
	4-way	2000-404	25
	5-way	2000-405	25
	6-way	2000-406	25
	7-way	2000-407	25
	8-way	2000-408	25
	9-way	2000-409	25
	10-way	2000-410	25

Modular connector; snaps together; for jumper contact slot			
Terminal block width: 5 mm / 0.197 inch			
	gray	2000-511	100 (25)

WMB Inline; plain; 2,300 WMB markers (3.5 mm)/reel			
	white	2009-113	1

Push-in type jumper bar; insulated; I _N 14 A; light gray			
	1 to 3	2000-433	25
	1 to 4	2000-434	25
	1 to 5	2000-435	25
	1 to 6	2000-436	25
	1 to 7	2000-437	25
	1 to 8	2000-438	25
	1 to 9	2000-439	25
	1 to 10	2000-440	25

Modular connector; snaps together; for jumper contact slot			
	gray	2000-510	100 (25)

Marking strip; plain; 11 mm wide; 50 m reel			
	white	2009-110	1

Delta jumper; insulated; I _N = I _N terminal block; light gray			
	1-2-3-4-5-6	2000-406/020-000	25

Spacer module; snaps together; bridges commoned terminal blocks			
	gray	2000-549	100 (25)

WMB marking card; white; 10 strips with 10 markers/card; for 3.5 mm terminal block width			
	plain	793-3501	5

Star point jumper; insulated; I _N = I _N terminal block; light gray			
	1-3-5	2000-405/011-000	25

End plate; for modular connector; 1.5 mm thick			
	gray	2002-541	100 (25)

Push-in type wire jumper; insulated; 0.75 mm ² conductor cross-section; I _N 9 A			
	L = 60 mm	2009-402	100 (10)
	L = 110 mm	2009-404	100 (10)
	L = 250 mm	2009-406	100 (10)

Test plug; with 500 mm cable; 2 mm Ø; max. 42 V			
	red	210-136	50

Test plug; with 500 mm cable; 2.3 mm Ø; max. 42 V			
	yellow	210-137	50

❶ Conductor range: 0.14 ... 1.5 mm² "s+f-st";
Push-in termination: 0.5 ... 1.5 mm² "s" and
0.5 ... 0.75 mm² "insulated ferrules; 12 mm"
Depending on the conductor characteristic, a conduc-
tor with a smaller cross section can also be inserted
via push-in termination.

❷ 800 V = rated voltage
8 kV = rated impulse voltage
3 = pollution degree
(see Section 14)

❸ Terminal blocks with a blue insulated housing are
suitable for Ex i applications.

Please observe the application notes:
Jumpers, from page 152
Testing accessories, from page 146
Marking, from page 588

Approvals and corresponding ratings,
visit www.wago.com

Through and Ground Conductor Terminal Block TOPJOB® S; with Push-Button

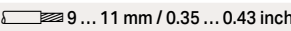

1.5 (2.5) mm²; 2201 Series



Technical Data	
0.25 ... 1.5 (2.5) mm ² ①	22 ... 14 AWG
800 V/8 kV/3 ②	
I _N 18 A (24 A)	
Terminal block width: 4.2 mm / 0.165 inch	
 9 ... 11 mm / 0.35 ... 0.43 inch	

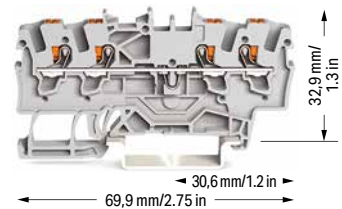
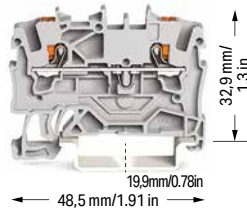

Technical Data	
0.25 ... 1.5 (2.5) mm ² ①	22 ... 14 AWG
800 V/8 kV/3 ②	
I _N 18 A (24 A)	
Terminal block width: 4.2 mm / 0.165 inch	
 9 ... 11 mm / 0.35 ... 0.43 inch	

Technical Data	
0.25 ... 1.5 (2.5) mm ² ①	22 ... 14 AWG
800 V/8 kV/3 ②	
I _N 18 A (24 A)	
Terminal block width: 4.2 mm / 0.165 inch	
 9 ... 11 mm / 0.35 ... 0.43 inch	





2-conductor through terminal block; with push-button		
Color	Item No.	Pack. Unit
 gray	2201-1201	100
 blue	2201-1204 ③	100



3-conductor through terminal block; with push-button		
Color	Item No.	Pack. Unit
 gray	2201-1301	100
 blue	2201-1304 ③	100



4-conductor through terminal block; with push-button		
Color	Item No.	Pack. Unit
 gray	2201-1401	100
 blue	2201-1404 ③	100



2-conductor ground terminal block; with push-button		
 green-yellow	2201-1207	100



3-conductor ground terminal block; with push-button		
 green-yellow	2201-1307	100



4-conductor ground terminal block; with push-button		
 green-yellow	2201-1407	100



Accessories; item-specific			
End and intermediate plate; 0.8 mm thick			
	orange	2002-1292	100 (25)
	gray	2002-1291	100 (25)

Accessories; item-specific			
End and intermediate plate; 0.8 mm thick			
	orange	2002-1392	100 (25)
	gray	2002-1391	100 (25)

Accessories; item-specific			
End and intermediate plate; 0.8 mm thick			
	orange	2002-1492	100 (25)
	gray	2002-1491	100 (25)

Separator; oversized; 2 mm thick			
	orange	2002-1294	100 (25)
	gray	2002-1293	100 (25)

Separator; oversized; 2 mm thick			
	orange	2002-1394	100 (25)
	gray	2002-1393	100 (25)

Separator; oversized; 2 mm thick			
	orange	2002-1494	100 (25)
	gray	2002-1493	100 (25)

Accessories; 2201 Series

Appropriate marking systems: WMB/WMB Inline/Marking strips

Insulation stop; 5 pcs/strip; 0.25 ... 0.5 mm ²			
	light gray	2001-171	200 (25)

Delta jumper; insulated; I _N = I _N terminal block; light gray			
	1-2 3-4 5-6	2001-406/020-000	25

Test plug adapter; for 4 mm Ø test plug			
	gray	2009-174	100 (25)

Push-in type jumper bar; insulated; I _N 18 A; light gray			
	2-way	2001-402	25
	3-way	2001-403	25
	4-way	2001-404	25
	5-way	2001-405	25
	6-way	2001-406	25
	7-way	2001-407	25
	8-way	2001-408	25
	9-way	2001-409	25
	10-way	2001-410	25

Star point jumper; insulated; I _N = I _N terminal block; light gray			
	1-3-5	2001-405/011-000	25

Banana plug; for 4 mm socket diameter; color mixed; 10 x orange, white, black, blue, yellow; max. 42 V			
		215-111	50

Push-in type wire jumper; insulated; 1.5 mm ² conductor cross-section; I _N 18 A			
	L = 60 mm	2009-412	100 (10)
	L = 110 mm	2009-414	100 (10)
	L = 250 mm	2009-416	100 (10)

Testing tap; for max. 2.5 mm ²			
	gray	2009-182	100 (25)

Push-in type jumper bar; insulated; I _N 18 A; light gray			
	1 to 3	2001-433	25
	1 to 4	2001-434	25
	1 to 5	2001-435	25
	1 to 6	2001-436	25
	1 to 7	2001-437	25
	1 to 8	2001-438	25
	1 to 9	2001-439	25
	1 to 10	2001-440	25

Modular connector; snaps together; for jumper contact slot			
	gray	2001-511	100 (25)

Test plug; with 500 mm cable; 2 mm Ø; max. 42 V			
	red	210-136	50

Spacer module; snaps together; bridges commoned terminal blocks			
	gray	2001-549	100 (25)

Test plug; with 500 mm cable; 2.3 mm Ø; max. 42 V			
	yellow	210-137	50

End plate; for modular connector; 1.5 mm thick			
	gray	2002-541	100 (25)

WMB Inline; plain; 2,000 WMB markers (4 mm)/reel; 4 ... 4.2 mm stretchable			
	white	2009-114	1

❶ Conductor range: 0.25 ... 2.5 mm² "s+f-st";
Push-in termination: 0.75 ... 2.5 mm² "s" and
0.75 ... 1.5 mm² "insulated ferrules; 12 mm"
Depending on the conductor characteristic, a conduc-
tor with a smaller cross section can also be inserted
via push-in termination.

❷ 800 V = rated voltage
8 kV = rated impulse voltage
3 = pollution degree
(see Section 14)

❸ Terminal blocks with a blue insulated housing are
suitable for Ex i applications.

Please observe the application notes:
Jumpers, from page 155
Testing accessories, from page 146
Marking, from page 588

Approvals and corresponding ratings,
visit www.wago.com

Accessories; 2201 Series

Appropriate marking systems:
WMB/WMB Inline/Marking strips

Marking strip; plain; 11 mm wide; 50 m reel

white 2009-110 1



WMB marking card; white; 10 strips with 10 markers/card; 4 ... 4.2 mm stretchable

plain 793-4501 5



WMB marking card; plain; 10 strips with 10 markers/card; 4 ... 4.2 mm stretchable

yellow	793-4501/000-002	5
red	793-4501/000-005	5
blue	793-4501/000-006	5
gray	793-4501/000-007	5
orange	793-4501/000-012	5
light green	793-4501/000-017	5
green	793-4501/000-023	5
violet	793-4501/000-024	5



Screwless end stop; for DIN-35 rail; 6 mm wide

gray 249-116 100 (25)



Screwless end stop; for DIN-35 rail; 10 mm wide

gray 249-117 50 (25)





Through and Ground Conductor Terminal Block TOPJOB® S; with Push-Button

2.5 (4) mm²; 2202 Series





1

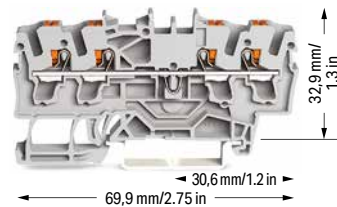
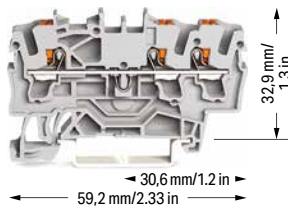
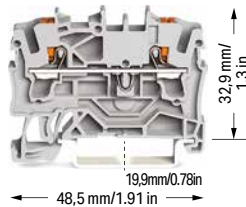

Technical Data	
0.25 ... 2.5 (4) mm ² ①	22 ... 12 AWG
800 V/8 kV/3 ②	
I _N 24 A (32 A)	
Terminal block width: 5.2 mm / 0.205 inch	
 10 ... 12 mm / 0.39 ... 0.47 inch	



Technical Data	
0.25 ... 2.5 (4) mm ² ①	22 ... 12 AWG
800 V/8 kV/3 ②	
I _N 24 A (32 A)	
Terminal block width: 5.2 mm / 0.205 inch	
 10 ... 12 mm / 0.39 ... 0.47 inch	

Technical Data	
0.25 ... 2.5 (4) mm ² ①	22 ... 12 AWG
800 V/8 kV/3 ②	
I _N 24 A (32 A)	
Terminal block width: 5.2 mm / 0.205 inch	
 10 ... 12 mm / 0.39 ... 0.47 inch	





2-conductor through terminal block; with push-button		
Color	Item No.	Pack. Unit
 gray	2202-1201	100
 blue	2202-1204 ③	100
 red	2202-1203	100
 black	2202-1205	100



3-conductor through terminal block; with push-button		
Color	Item No.	Pack. Unit
 gray	2202-1301	100
 blue	2202-1304 ③	100



4-conductor through terminal block; with push-button		
Color	Item No.	Pack. Unit
 gray	2202-1401	100
 blue	2202-1404 ③	100



2-conductor ground terminal block; with push-button		
 green-yellow	2202-1207	100



3-conductor ground terminal block; with push-button		
 green-yellow	2202-1307	100



4-conductor ground terminal block; with push-button		
 green-yellow	2202-1407	100



Accessories; item-specific		
End and intermediate plate; 0.8 mm thick		
 orange	2002-1292	100 (25)
 gray	2002-1291	100 (25)

Accessories; item-specific		
End and intermediate plate; 0.8 mm thick		
 orange	2002-1392	100 (25)
 gray	2002-1391	100 (25)

Accessories; item-specific		
End and intermediate plate; 0.8 mm thick		
 orange	2002-1492	100 (25)
 gray	2002-1491	100 (25)

Separator; oversized; 2 mm thick		
 orange	2002-1294	100 (25)
 gray	2002-1293	100 (25)

Separator; oversized; 2 mm thick		
 orange	2002-1394	100 (25)
 gray	2002-1393	100 (25)

Separator; oversized; 2 mm thick		
 orange	2002-1494	100 (25)
 gray	2002-1493	100 (25)

Accessories; 2202 Series

Appropriate marking systems: WMB/WMB Inline/Marking strips

Insulation stop; 5 pcs/strip; 0.25 ... 0.5 mm ²		
 light gray	2002-171	200 (25)

Delta jumper; insulated; I _N = I _N terminal block; light gray		
 1-2 3-4 5-6	2002-406/020-000	25

Staggered jumper; insulated; I _N 25 A; light gray		
 2-way	2002-472	25
3-way	2002-473	25
4-way	2002-474	25
5-way	2002-475	25
6-way	2002-476	25
7-way	2002-477	25
8-way	2002-478	25
9-way	2002-479	25
10-way	2002-480	25
11-way	2002-481	25
12-way	2002-482	25



Insulation stop; 5 pcs/strip; 0.75 ... 1 mm ²		
 dark gray	2002-172	200 (25)

Star point jumper; insulated; I _N = I _N terminal block; light gray		
 1-3-5	2002-405/011-000	25

Push-in type jumper bar; insulated; I _N 25 A; light gray		
 2-way	2002-402	25
3-way	2002-403	25
4-way	2002-404	25
5-way	2002-405	25
6-way	2002-406	25
7-way	2002-407	25
8-way	2002-408	25
9-way	2002-409	25
10-way	2002-410	25

Adjacent jumper for continuous commoning; insulated; I _N 25 A, light gray		
 2-way	2002-400	25

Push-in type jumper bar; insulated; I _N 25 A; light gray		
 1 to 3	2002-433	25
1 to 4	2002-434	25
1 to 5	2002-435	25
1 to 6	2002-436	25
1 to 7	2002-437	25
1 to 8	2002-438	25
1 to 9	2002-439	25
1 to 10	2002-440	25

Adjacent jumper for continuous commoning; insulated; I _N 25 A; 1 to 3		
 light gray	2002-423	25
 red	2002-423/000-005	25
 blue	2002-423/000-006	25

Adjacent jumper for continuous commoning; insulated; I _N 25 A, light gray		
 5-way	2002-415	25

Customized staggered jumper; insulated; with contact lugs broken off at the factory and circuit printing; I _N 25 A; light gray		
 1-3	2002-473/011-000	25
1-3-5	2002-475/011-000	25
1-3-5-7	2002-477/011-000	25
1-3-5-7-9	2002-479/011-000	25
1-3-5-7-9-11	2002-481/011-000	25

Push-in type wire jumper; insulated; 1.5 mm ² conductor cross-section; I _N 18 A		
 L = 60 mm	2009-412	100 (10)
L = 110 mm	2009-414	100 (10)
L = 250 mm	2009-416	100 (10)

❶ Conductor range: 0.25 ... 4 mm² "s+f-st";
Push-in termination: 1 ... 4 mm² "s" and 1 ... 2.5 mm²
"insulated ferrules, 12 mm"
Depending on the conductor characteristic, a conductor with a smaller cross section can also be inserted via push-in termination.

❷ 800 V = rated voltage
8 kV = rated impulse voltage
3 = pollution degree
(see Section 14)

❸ Terminal blocks with a blue insulated housing are suitable for Ex i applications.

Please observe the application notes:
Jumpers, from page 152
Testing accessories, from page 146
Marking, from page 588

Approvals and corresponding ratings,
visit www.wago.com

Accessories; 2202 Series

Appropriate marking systems:
WMB/WMB Inline/Marking strips

Modular connector; snaps together; for jumper contact slot



gray 2002-511 100 (25)

Spacer module; snaps together; bridges commoned terminal blocks



gray 2002-549 100 (25)

End plate; for modular connector; 1.5 mm thick



gray 2002-541 100 (25)

WMB Inline, plain; 1,500 WMB markers (5 mm)/reel;
5 ... 5.2 mm stretchable



white 2009-115 1

Marking strip; plain; 11 mm wide; 50 m reel



white 2009-110 1

WMB marking card; white; 10 strips with 10 markers/card;
5 ... 5.2 mm stretchable





plain 793-5501 5

Through and Ground Conductor Terminal Block TOPJOB® S; with Push-Button 4 (6) mm²; 2204 Series



1



Technical Data	
0.5 ... 4 (6) mm ² ①	20 ... 10 AWG
800 V/8 kV/3 ②	
I _N 32 A (41 A)	
Terminal block width: 6.2 mm / 0.244 inch	
 11 ... 13 mm / 0.43 ... 0.51 inch	

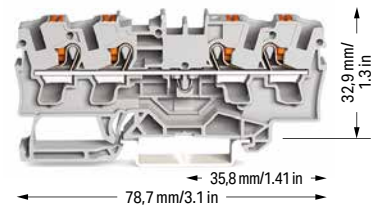
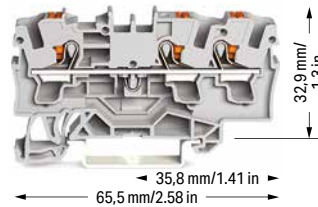
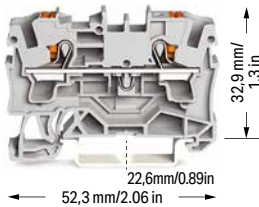

Technical Data	
0.5 ... 4 (6) mm ² ①	20 ... 10 AWG
800 V/8 kV/3 ②	
I _N 32 A (41 A)	
Terminal block width: 6.2 mm / 0.244 inch	
 11 ... 13 mm / 0.43 ... 0.51 inch	

Technical Data	
0.5 ... 4 (6) mm ² ①	20 ... 10 AWG
800 V/8 kV/3 ②	
I _N 32 A (41 A)	
Terminal block width: 6.2 mm / 0.244 inch	
 11 ... 13 mm / 0.43 ... 0.51 inch	





2-conductor through terminal block; with push-button		
Color	Item No.	Pack. Unit
 gray	2204-1201	50
 blue	2204-1204 ③	50



3-conductor through terminal block; with push-button		
Color	Item No.	Pack. Unit
 gray	2204-1301	50
 blue	2204-1304 ③	50



4-conductor through terminal block; with push-button		
Color	Item No.	Pack. Unit
 gray	2204-1401	50
 blue	2204-1404 ③	50



2-conductor ground terminal block; with push-button		
 green-yellow	2204-1207	50



3-conductor ground terminal block; with push-button		
 green-yellow	2204-1307	50



4-conductor ground terminal block; with push-button		
 green-yellow	2204-1407	50



Accessories; item-specific			
End and intermediate plate; 1 mm thick			
 orange	2004-1292	100 (25)	
 gray	2004-1291	100 (25)	

Accessories; item-specific			
End and intermediate plate; 1 mm thick			
 orange	2004-1392	100 (25)	
 gray	2004-1391	100 (25)	

Accessories; item-specific			
End and intermediate plate; 1 mm thick			
 orange	2004-1492	100 (25)	
 gray	2004-1491	100 (25)	

Separator; oversized; 2 mm thick			
 orange	2004-1294	100 (25)	
 gray	2004-1293	100 (25)	

Separator; oversized; 2 mm thick			
 orange	2004-1394	100 (25)	
 gray	2004-1393	100 (25)	

Separator; oversized; 2 mm thick			
 orange	2004-1494	100 (25)	
 gray	2004-1493	100 (25)	

Accessories; 2204 Series

Appropriate marking systems: WMB/WMB Inline/Marking strips

Insulation stop; 5 pcs/strip; 0.25 ... 0.5 mm ²			
 light gray	2004-171	200 (25)	









Star point jumper; insulated; I _N = I _N terminal block; light gray			
 1-3-5	2004-405/011-000	25	

Banana plug; for 4 mm socket diameter; color mixed; 10 x orange, white, black, blue, yellow; max. 42 V			
	215-111	50	

Insulation stop; 5 pcs/strip; 0.75 ... 1 mm ²			
 dark gray	2004-172	200 (25)	









Delta jumper; insulated; I _N = I _N terminal block; light gray			
 1-2 3-4 5-6	2004-406/020-000		

Testing tap; for max. 2.5 mm ²			
 gray	2009-182	100 (25)	

Push-in type jumper bar; insulated; I _N 32 A; light gray			
 2-way	2004-402	25	
 3-way	2004-403	25	
 4-way	2004-404	25	
 5-way	2004-405	25	
 6-way	2004-406	25	
 7-way	2004-407	25	
 8-way	2004-408	25	
 9-way	2004-409	25	
 10-way	2004-410	25	

Modular connector; snaps together; for jumper contact slot			
 gray	2004-511	100 (25)	

Marking strip; plain; 11 mm wide; 50 m reel			
 white	2009-110	1	

Push-in type jumper bar; insulated; I _N 32 A; light gray			
 1 to 3	2004-433	25	
 1 to 4	2004-434	25	
 1 to 5	2004-435	25	
 1 to 6	2004-436	25	
 1 to 7	2004-437	25	
 1 to 8	2004-438	25	
 1 to 9	2004-439	25	
 1 to 10	2004-440	25	

Spacer module; snaps together; bridges commoned terminal blocks			
 gray	2004-549	100 (25)	

WMB marking card; white; 10 strips with 10 markers/card; 5 ... 5.2 mm stretchable			
 plain	793-5501	5	

End plate; for modular connector; 1.5 mm thick			
 gray	2004-541	100 (25)	

Group marker carrier; snap-on type for jumper slot; 5 mm wide			
 gray	2009-191	50 (25)	

Test plug adapter; for 4 mm Ø test plug			
 gray	2009-174	100 (25)	

❶ Conductor range: 0.5 ... 6 mm² "s+f-st";
Push-in termination: 1.5 ... 6 mm² "s" and 1.5 ... 4 mm²
"insulated ferrules; 12 mm"
Depending on the conductor characteristic, a conductor with a smaller cross section can also be inserted via push-in termination.

❷ 800 V = rated voltage
8 kV = rated impulse voltage
3 = pollution degree
(see Section 14)

❸ Terminal blocks with a blue insulated housing are suitable for Ex i applications.

Please observe the application notes:
Jumpers, from page 155
Testing accessories, from page 148
Marking, from page 588

Approvals and corresponding ratings,
visit www.wago.com

Through and Ground Conductor Terminal Block TOPJOB® S; with Push-Button 6 (10) mm²; 2206 Series

1

Technical Data

0.5 ... 6 (10) mm² ① | 20 ... 8 AWG
800 V/8 kV/3 ②
I_N 41 A (57 A)
Terminal block width: 7.5 mm / 0.295 inch
13 ... 15 mm / 0.51 ... 0.59 inch

Technical Data

0.5 ... 6 (10) mm² ① | 20 ... 8 AWG
800 V/8 kV/3 ②
I_N 41 A (57 A)
Terminal block width: 7.5 mm / 0.295 inch
13 ... 15 mm / 0.51 ... 0.59 inch



① Conductor range: 0.5 ... 10 mm² "s+f-st"; Push-in termination: 2.5 ... 10 mm² "s" and 2.5 ... 6 mm² "insulated ferrules; 12 mm"
Depending on the conductor characteristic, a conductor with a smaller cross section can also be inserted via push-in termination.

② 800 V = rated voltage
8 kV = rated impulse voltage
3 = pollution degree
(see Section 14)

③ Terminal blocks with a blue insulated housing are suitable for Ex i applications.

Please observe the application notes:
Jumpers, from page 155
Testing accessories, from page 148
Marking, from page 588

Approvals and corresponding ratings, visit www.wago.com

2-conductor through terminal block; with push-button

Color	Item No.	Pack. Unit
gray	2206-1201	50
blue	2206-1204 ③	50

3-conductor through terminal block; with push-button

Color	Item No.	Pack. Unit
gray	2206-1301	25
blue	2206-1304 ③	25

2-conductor ground terminal block; with push-button

green-yellow	2206-1207	50
--------------	-----------	----

3-conductor ground terminal block; with push-button

green-yellow	2206-1307	25
--------------	-----------	----

Accessories; item-specific

End and intermediate plate; 1 mm thick

orange	2006-1292	100 (25)
gray	2006-1291	100 (25)

Accessories; item-specific

End and intermediate plate; 1 mm thick

orange	2006-1392	100 (25)
gray	2006-1391	100 (25)

Separator; oversized; 2 mm thick

orange	2006-1294	100 (25)
gray	2006-1293	100 (25)

Separator; oversized; 2 mm thick

orange	2006-1394	100 (25)
gray	2006-1393	100 (25)

Accessories; 2206 Series

Appropriate marking systems: WMB/WMB Inline/Marking strips

Push-in type jumper bar; insulated; I_N 41 A; light gray

2-way	2006-402	25
3-way	2006-403	25
4-way	2006-404	25
5-way	2006-405	25

Modular connector; snaps together; for jumper contact slot

gray	2006-511	50 (25)
------	----------	---------

Push-in type jumper bar; insulated; I_N 41 A; light gray

1 to 3	2006-433	25
1 to 4	2006-434	25
1 to 5	2006-435	25

Test plug adapter; for 4 mm Ø test plug

gray	2009-174	100 (25)
------	----------	----------

Star point jumper; insulated; I_N = I_N terminal block; light gray

1-3-5	2006-405/011-000	25
-------	------------------	----

Marking strip; plain; 11 mm wide; 50 m reel

white	2009-110	1
-------	----------	---

WMB marking card; white; 10 strips with 10 markers/card; 5 ... 5.2 mm stretchable

plain	793-5501	5
-------	----------	---

Through and Ground Conductor Terminal Block TOPJOB® S; with Push-Button 10 (16) mm²; 2210 Series

Technical Data

0,5 ... 10 (16) mm² ① | 20 ... 6 AWG

800 V/8 kV/3 ②

I_N 57 A (76 A)

Terminal block width: 10 mm / 0.394 inch

 17 ... 19 mm / 0.67 ... 0.91 inch

Technical Data

0,5 ... 10 (16) mm² ① | 20 ... 6 AWG

800 V/8 kV/3 ②

I_N 57 A (76 A)

Terminal block width: 10 mm / 0.394 inch

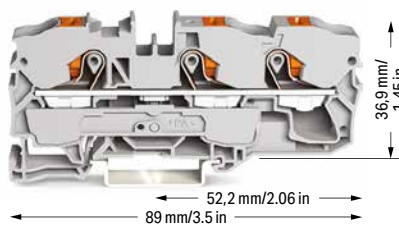
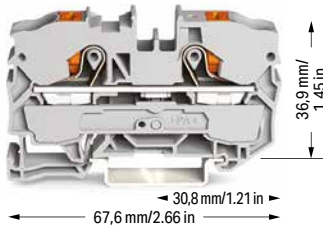
 17 ... 19 mm / 0.67 ... 0.91 inch

2-conductor through terminal block; with push-button

Color	Item No.	Pack. Unit
gray	2210-1201	25
blue	2210-1204 ③	25

3-conductor through terminal block; with push-button

Color	Item No.	Pack. Unit
gray	2210-1301	25
blue	2210-1304 ③	25

2-conductor ground terminal block; with push-button

green-yellow	2210-1207	25
--------------	-----------	----

3-conductor ground terminal block; with push-button

green-yellow	2210-1307	25
--------------	-----------	----

Accessories; item-specific

End and intermediate plate; 1 mm thick

orange	2010-1292	100 (25)
gray	2010-1291	100 (25)

Accessories; item-specific

End and intermediate plate; 1 mm thick

orange	2010-1392	100 (25)
gray	2010-1391	100 (25)



Accessories; 2210 Series

Appropriate marking systems: WMB/WMB Inline/Marking strips

Push-in type jumper bar; insulated; I_N 57 A; light gray

	2-way	2010-402	25
	3-way	2010-403	25
	4-way	2010-404	25
	5-way	2010-405	25

Push-in type jumper bar; insulated; I_N 57 A; light gray

	1 to 3	2010-433	25
	1 to 4	2010-434	25
	1 to 5	2010-435	25

Star point jumper; insulated; I_N = I_N terminal block; light gray

	1-3-5	2010-405/011-000	25
---	-------	------------------	----

Finger guard; touch-proof cover protects unused conductor entries

	yellow	2010-100	100 (25)
---	--------	----------	----------

Modular connector; snaps together; for jumper contact slot

	gray	2010-511	50 (25)
---	------	----------	---------

Test plug adapter; for 4 mm Ø test plug

	gray	2009-174	100 (25)
---	------	----------	----------

Marking strip; plain; 11 mm wide; 50 m reel

	white	2009-110	1
---	-------	----------	---

WMB marking card; white; 10 strips with 10 markers/card; 5 ... 5.2 mm stretchable

	plain	793-5501	5
---	-------	----------	---

① Conductor range: 0.5 ... 16 mm² "s+f-st"; Push-in termination: 4 ... 16 mm² "s" and 4 ... 10 mm² "insulated ferrules; 18 mm"
Depending on the conductor characteristic, a conductor with a smaller cross section can also be inserted via push-in termination.

② 800 V = rated voltage
8 kV = rated impulse voltage
3 = pollution degree
(see Section 14)

③ Terminal blocks with a blue insulated housing are suitable for Ex i applications.

Please observe the application notes:
Jumpers, from page 155
Testing accessories, from page 148
Marking, from page 588

Approvals and corresponding ratings, visit www.wago.com

Through and Ground Conductor Terminal Block TOPJOB® S; with Push-Button 16 (25 "f-st") mm²; 2216 Series

1

Technical Data	
0.5 ... 16 (25 "f-st") mm ² ①	20 ... 4 AWG
800 V/8 kV/3 ②	
I _N 76 A (90 A)	
Terminal block width: 12 mm / 0.472 inch	
 18 ... 20 mm / 0.71 ... 0.79 inch	

Technical Data	
0.5 ... 16 (25 "f-st") mm ² ①	20 ... 4 AWG
800 V/8 kV/3 ②	
I _N 76 A (90 A)	
Terminal block width: 12 mm / 0.472 inch	
 18 ... 20 mm / 0.71 ... 0.79 inch	

① Conductor range: 0.5 ... 16 mm² "s+f-st", 25 mm² "f-st"; Push-in termination: 6 ... 16 mm² "s" and 6 ... 16 mm² "insulated ferrules; 18 mm"
Depending on the conductor characteristic, a conductor with a smaller cross section can also be inserted via push-in termination.



② 800 V = rated voltage
8 kV = rated impulse voltage
3 = pollution degree
(see Section 14)



③ Terminal blocks with a blue insulated housing are suitable for Ex i applications.

Please observe the application notes:
Jumpers, from page 155
Testing accessories, from page 149
Marking, from page 588

Approvals and corresponding ratings, visit www.wago.com







2-conductor through terminal block; with push-button		
Color	Item No.	Pack. Unit
 gray	2216-1201	20
 blue	2216-1204 ③	20

3-conductor through terminal block; with push-button		
Color	Item No.	Pack. Unit
 gray	2216-1301	20
 blue	2216-1304 ③	20





2-conductor ground terminal block; with push-button		
15 mm high DIN-35 rails shall be used for a current load higher than 76 A!		
 green-yellow	2216-1207	50

3-conductor ground terminal block; with push-button		
15 mm high DIN-35 rails shall be used for a current load higher than 76 A!		
 green-yellow	2216-1307	20



Accessories; item-specific			
End and intermediate plate; 1 mm thick			
	orange	2016-1292	100 (25)
	gray	2016-1291	100 (25)

Accessories; item-specific			
End and intermediate plate; 1 mm thick			
	orange	2016-1392	100 (25)
	gray	2016-1391	100 (25)

Accessories; 2216 Series
Appropriate marking systems: WMB/WMB Inline/Marking strips

Push-in type jumper bar; insulated; I _N 41 A; light gray			
	2-way	2016-402	25
	3-way	2016-403	25
	4-way	2016-404	25
	5-way	2016-405	25

Finger guard; touch-proof cover protects unused conductor entries			
	yellow	2016-100	100 (25)

Push-in type jumper bar; insulated; I _N 41 A; light gray			
	1 to 3	2016-433	25
	1 to 4	2016-434	25
	1 to 5	2016-435	25

Modular connector; snaps together; for jumper contact slot			
	gray	2016-511	50 (25)

Star point jumper; insulated; I _N = I _N terminal block; light gray			
	1-3-5	2016-405/011-000	25

Test plug adapter; for 4 mm Ø test plug			
	gray	2009-174	100 (25)

Marking strip; plain; 11 mm wide; 50 m reel			
	white	2009-110	1

WMB marking card; white; 10 strips with 10 markers/card; 5 ... 5.2 mm stretchable			
	plain	793-5501	5

Rail-Mount Terminal Blocks TOPJOB® S; with Push-in CAGE CLAMP®

2000 to 2016 Series

Description and Installation

1



Push-in termination of solid and ferruled conductors

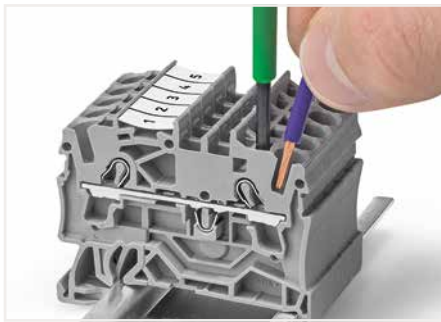

Insert fine-stranded conductors via operating tool.

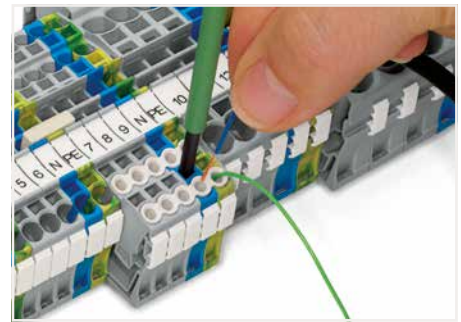

Conductor termination – insulation stop



Insert push-in type jumper bar and push down until it hits backstop.



Custom jumpers are created by breaking and removing jumper contacts (2000, 2001, 2002, 2004 Series).

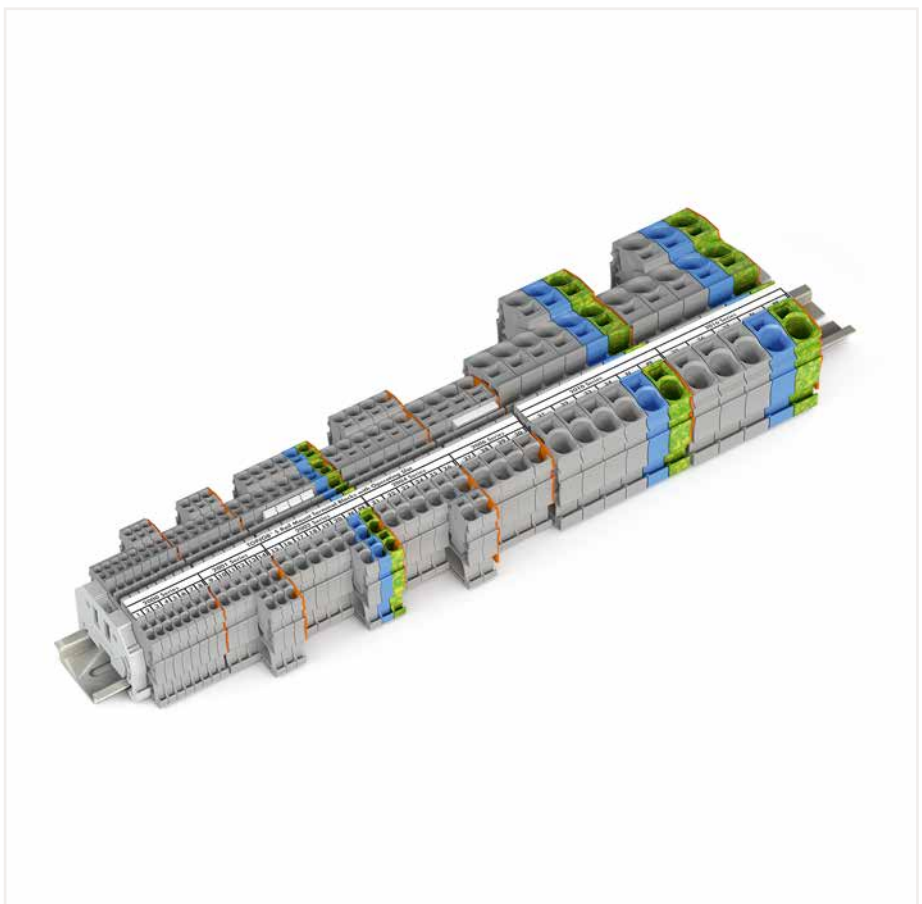

Push-in type jumper bar: Marking with a felt-tip pen.

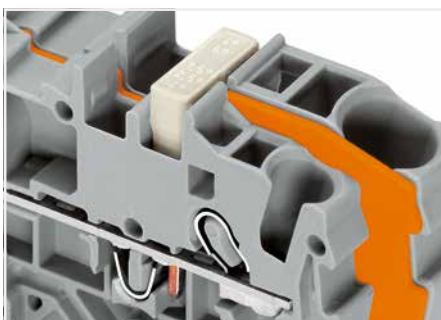

Commoning with step-down jumpers.

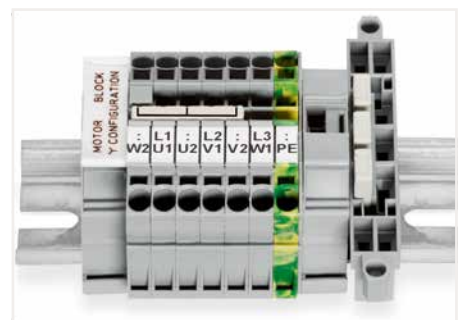

This star point jumper was specifically developed to create a "star point" and is used on motor terminal boards equipped with Rail-Mount Terminal Blocks TOPJOB® S.



Push-in CAGE CLAMP® terminates the following copper conductors: solid



stranded



fine-stranded, also with tinned single strands

PUSH-IN CAGE CLAMP®

1

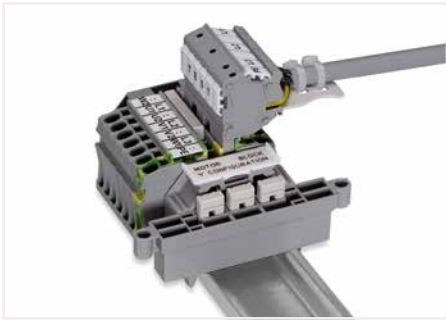

Rail-mount terminal block assembly for electric motor wiring



L-type test plug modules fitted in a triple-deck terminal block



Testing tap (2009-182) for tool-free connection of test cables up to 2.5 mm² (12 AWG) – compatible with 2000 to 2016 Series

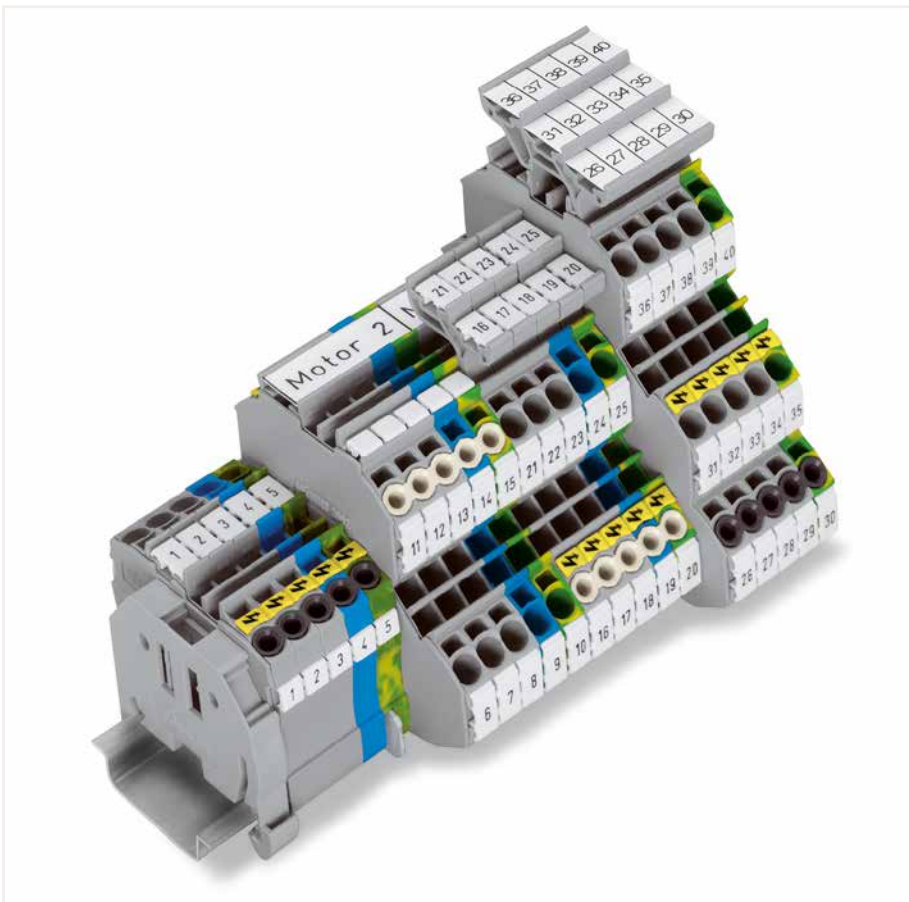

Test plug adapter (2009-174, CAT I) for 4 mm Ø plugs – compatible with 2000 to 2016 Series



Group marker carrier (2009-163) for marking strips (2009-110)

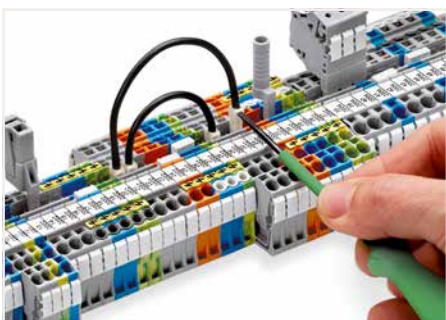

Push down the wire jumper until fully inserted. Lift the jumper with an operating tool for rewiring.

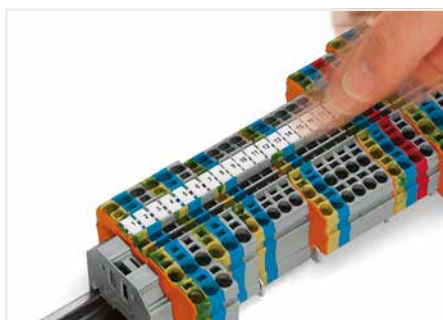

Snapping a marking strip into the marker slot.

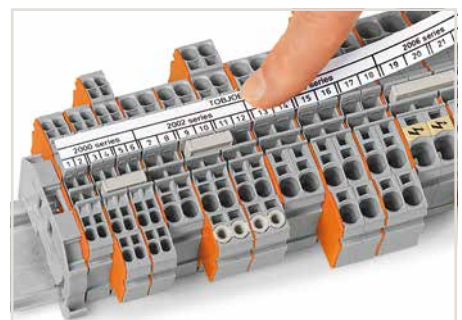

Snapping a marking strip into the marker slot.



fine-stranded, tip-bonded



fine-stranded, with ferrule (gastight crimped)



fine-stranded, with pin terminal (gastight crimped)

Through/Ground Conductor/Ex and Double-Potential Terminal Block TOPJOB® S 1 (1.5) mm²; 2000 Series

1

Technical Data	
0.14 ... 1 (1.5) mm ² ①	24 ... 16 AWG
800 V/8 kV/3 ②	600 V, 10 A ③
I _N 13.5 A (18 A)	600 V, 10 A ④
Terminal block width: 3.5 mm / 0.138 inch	
9 ... 11 mm / 0.35 ... 0.43 inch	

Technical Data	
0.14 ... 1 (1.5) mm ² ①	24 ... 16 AWG
800 V/8 kV/3 ②	600 V, 10 A ③
I _N 13.5 A (18 A)	600 V, 10 A ④
Terminal block width: 3.5 mm / 0.138 inch	
9 ... 11 mm / 0.35 ... 0.43 inch	

Technical Data	
0.14 ... 1 (1.5) mm ² ①	24 ... 16 AWG
800 V/8 kV/3 ②	600 V, 10 A ③
I _N 13.5 A (18 A)	600 V, 10 A ④
Terminal block width: 3.5 mm / 0.138 inch	
9 ... 11 mm / 0.35 ... 0.43 inch	

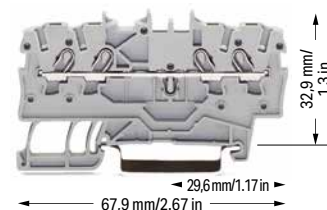
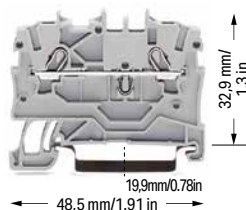

2-conductor through terminal block

Color	Item No.	Pack. Unit
gray ⑤	2000-1201 ④	100
blue ⑤	2000-1204 ③ ④	100
orange ⑤	2000-1202 ④	100
red ⑤	2000-1203 ④	100
black ⑤	2000-1205 ④	100
yellow ⑤	2000-1206 ④	100

3-conductor through terminal block

Color	Item No.	Pack. Unit
gray ⑤	2000-1301 ④	100
blue ⑤	2000-1304 ③ ④	100
orange ⑤	2000-1302 ④	100
red ⑤	2000-1303 ④	100
black ⑤	2000-1305 ④	100
yellow ⑤	2000-1306 ④	100

4-conductor through terminal block

Color	Item No.	Pack. Unit
gray ⑤	2000-1401 ④	100
blue ⑤	2000-1404 ③ ④	100
orange ⑤	2000-1402 ④	100
red ⑤	2000-1403 ④	100
black ⑤	2000-1405 ④	100
yellow ⑤	2000-1406 ④	100

2-conductor ground terminal block

green-yellow ⑤	2000-1207 ④	100
----------------	-------------	-----

3-conductor ground terminal block

green-yellow ⑤	2000-1307 ④	100
----------------	-------------	-----

4-conductor ground terminal block

green-yellow ⑤	2000-1407 ④	100
----------------	-------------	-----

Accessories; item-specific

End and intermediate plate; 0.7 mm thick

orange	2000-1292	100 (25)
gray	2000-1291	100 (25)

Accessories; item-specific

End and intermediate plate; 0.7 mm thick

orange	2000-1392	100 (25)
gray	2000-1391	100 (25)

Accessories; item-specific

End and intermediate plate; 0.7 mm thick

orange	2000-1492	100 (25)
gray	2000-1491	100 (25)

Ex e/Ex i separator; orange; 3 mm thick

90 mm	209-190	50 (25)
120 mm	209-191	50 (25)

Ex e/Ex i separator; orange; 3 mm thick

120 mm	209-191	50 (25)
--------	---------	---------

Ex e/Ex i separator; orange; 3 mm thick

120 mm	209-191	50 (25)
--------	---------	---------

Accessories; 2000 Series

Appropriate marking systems: WMB/WMB Inline/Marking strips

Push-in type jumper bar; insulated; I_N 14 A; light gray

2-way	2000-402	25
3-way	2000-403	25
4-way	2000-404	25
5-way	2000-405	25
6-way	2000-406	25
7-way	2000-407	25
8-way	2000-408	25
9-way	2000-409	25
10-way	2000-410	25

Delta jumper; insulated; I_N = I_N terminal block; light gray

1-2 3-4 5-6	2000-406/020-000	25
-------------	------------------	----

Spacer module; snaps together; bridges commoned terminal blocks

gray	2000-549	100 (25)
------	----------	----------

Push-in type jumper bar; insulated; I_N 14 A; light gray

1 to 3	2000-433	25
1 to 4	2000-434	25
1 to 5	2000-435	25
1 to 6	2000-436	25
1 to 7	2000-437	25
1 to 8	2000-438	25
1 to 9	2000-439	25
1 to 10	2000-440	25

Star point jumper; insulated; I_N = I_N terminal block; light gray

1-3-5	2000-405/011-000	25
-------	------------------	----

End plate; for modular connector; 1.5 mm thick

gray	2002-541	100 (25)
------	----------	----------

Push-in type wire jumper; insulated; 0.75 mm² conductor cross-section; I_N 9 A

L = 60 mm	2009-402	100 (10)
L = 110 mm	2009-404	100 (10)
L = 250 mm	2009-406	100 (10)

Test plug adapter; for 4 mm Ø test plug

gray	2009-174	100 (25)
------	----------	----------

Protective warning marker; with black high-voltage symbol; for 5 terminal blocks

yellow	2000-115	100 (25)
--------	----------	----------

Modular connector; snaps together; for jumper contact slot

gray	2000-511	100 (25)
------	----------	----------

Banana plug; for 4 mm socket diameter; color mixed; 10 x orange, white, black, blue, yellow; max. 42 V

	215-111	50
--	---------	----

Testing tap; for max. 2.5 mm²

gray	2009-182	100 (25)
------	----------	----------

Technical Data

0.14 ... 1 (1.5) mm ² ①	24 ... 16 AWG
800 V/8 kV/3 ②	600 V, 10 A ③
I _N 13.5 A (18 A)	600 V, 10 A ④
Terminal block width: 3.5 mm / 0.138 inch	
9 ... 11 mm / 0.35 ... 0.43 inch	

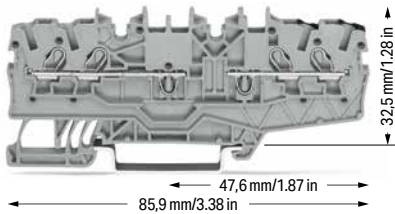

Double-potential terminal block; both potentials can be commoned

Color	Item No.	Pack. Unit
○ gray	2000-2141	100

① Conductor range: 0.14 ... 1.5 mm² "s+f-st"; Push-in termination: 0.5 ... 1.5 mm² "s" and 0.5 ... 0.75 mm² "insulated ferrules; 12 mm" Depending on the conductor characteristic, a conductor with a smaller cross section can also be inserted via push-in termination.

② 800 V = rated voltage
8 kV = rated impulse voltage
3 = pollution degree
(see Section 14)

③ Terminal blocks with a blue insulated housing are suitable for Ex i applications.

④ Terminal blocks with an Ex mark are suitable for Ex e II applications.
550 V; 13 A
12 A jumper
(see Section 14)

Please observe the application notes:
Separator for Ex e/Ex i applications, see page 55
Step-down jumpers, see page 59
Jumpers, from page 152
Testing accessories, from page 146
Marking, from page 588

Approvals and corresponding ratings, visit www.wago.com

Accessories; item-specific

End and intermediate plate; 0.7 mm thick		
orange	2000-2196	100 (25)
gray	2000-2195	100 (25)

Test plug; with 500 mm cable; 2 mm Ø; max. 42 V

	red	210-136	50
---	-----	---------	----

Test plug; with 500 mm cable; 2.3 mm Ø; max. 42 V

	yellow	210-137	50
---	--------	---------	----

WMB Inline; plain; 2,300 WMB markers (3.5 mm)/reel

	white	2009-113	1
---	-------	----------	---

Marking strip; plain; 11 mm wide; 50 m reel

	white	2009-110	1
---	-------	----------	---

WMB marking card; white; 10 strips with 10 markers/card; for 3.5 mm terminal block width

	plain	793-3501	5
---	-------	----------	---

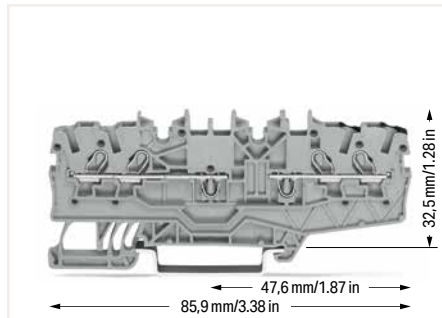

Front-entry double-potential terminal blocks are space savers. Two independent feedthrough circuits are placed in one insulated housing on one level in just 3.5 mm. This achieves a width of just 1.75 mm versus standard through terminal blocks. Input and output of a circuit are placed on the same side of the terminal block. Both circuits can be individually marked according to input and output.



Standard and quick marking options:
Three marker slots are available for both individual markers and marking strips.



2009-193 Group Marker Carrier (equipped with marking strips) for all 2001 to 2016 Series Rail-Mount Terminal Blocks TOPJOB® S
Do not use on an end plate!

Through/Ground Conductor/Shield Conductor/Ex and Double-Potential Terminal Block TOPJOB® S 1.5 (2.5) mm²; 2001 Series

1

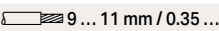
Technical Data	
0.25 ... 1.5 (2.5) mm ² ①	22 ... 14 AWG
800 V/8 kV/3 ②	600 V, 15 A ③
I _N 18 A (24 A)	600 V, 15 A ④
Terminal block width: 4.2 mm / 0.165 inch	
 9 ... 11 mm / 0.35 ... 0.43 inch	

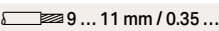
Technical Data	
0.25 ... 1.5 (2.5) mm ² ①	22 ... 14 AWG
800 V/8 kV/3 ②	600 V, 15 A ③
I _N 18 A (24 A)	600 V, 15 A ④
Terminal block width: 4.2 mm / 0.165 inch	
 9 ... 11 mm / 0.35 ... 0.43 inch	

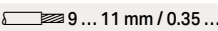
Technical Data	
0.25 ... 1.5 (2.5) mm ² ①	22 ... 14 AWG
800 V/8 kV/3 ②	600 V, 15 A ③
I _N 18 A (24 A)	600 V, 15 A ④
Terminal block width: 4.2 mm / 0.165 inch	
 9 ... 11 mm / 0.35 ... 0.43 inch	

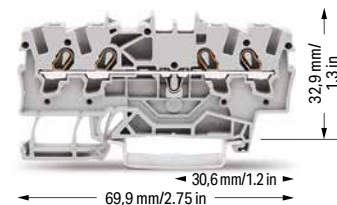
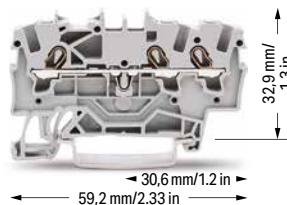
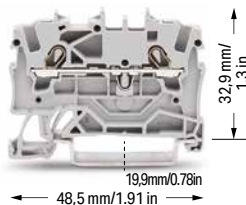

2-conductor through terminal block		
Color	Item No.	Pack. Unit
gray ⑤	2001-1201 ④	100
blue ⑤	2001-1204 ③ ④	100
orange ⑤	2001-1202 ④	100
red ⑤	2001-1203 ④	100
black ⑤	2001-1205 ④	100
yellow ⑤	2001-1206 ④	100

3-conductor through terminal block		
Color	Item No.	Pack. Unit
gray ⑤	2001-1301 ④	100
blue ⑤	2001-1304 ③ ④	100
orange ⑤	2001-1302 ④	100
red ⑤	2001-1303 ④	100
black ⑤	2001-1305 ④	100
yellow ⑤	2001-1306 ④	100

4-conductor through terminal block		
Color	Item No.	Pack. Unit
gray ⑤	2001-1401 ④	100
blue ⑤	2001-1404 ③ ④	100
orange ⑤	2001-1402 ④	100
red ⑤	2001-1403 ④	100
black ⑤	2001-1405 ④	100
yellow ⑤	2001-1406 ④	100

2-conductor ground terminal block		
green-yellow ⑤	2001-1207 ④	100

3-conductor ground terminal block		
green-yellow ⑤	2001-1307 ④	100

4-conductor ground terminal block		
green-yellow ⑤	2001-1407 ④	100

2-conductor shield terminal block		
white	2001-1208	100



3-conductor shield terminal block		
white	2001-1308	100



4-conductor shield terminal block		
white	2001-1408	100



Other terminal blocks with the same profile:		
Diode	2001-1211/1000-411	Page 128

Other terminal blocks with the same profile:		
Diode	2001-1311/1000-411	Page 128
LED	2001-1321/1000-434	Page 128

Other terminal blocks with the same profile:		
Diode	2001-1411/1000-411	Page 128
LED	2001-1421/1000-434	Page 128



Accessories; item-specific			
End and intermediate plate; 0.8 mm thick			
	orange	2002-1292	100 (25)
	gray	2002-1291	100 (25)



Accessories; item-specific			
End and intermediate plate; 0.8 mm thick			
	orange	2002-1392	100 (25)
	gray	2002-1391	100 (25)

Accessories; item-specific			
End and intermediate plate; 0.8 mm thick			
	orange	2002-1492	100 (25)
	gray	2002-1491	100 (25)

Separator; oversized; 2 mm thick			
	orange	2002-1294	100 (25)
	gray	2002-1293	100 (25)

Separator; oversized; 2 mm thick			
	orange	2002-1394	100 (25)
	gray	2002-1393	100 (25)

Separator; oversized; 2 mm thick			
	orange	2002-1494	100 (25)
	gray	2002-1493	100 (25)

Ex e/Ex i separator; orange; 3 mm thick			
	90 mm	209-190	50 (25)
	120 mm	209-191	50 (25)

Ex e/Ex i separator; orange; 3 mm thick			
	120 mm	209-191	50 (25)

Ex e/Ex i separator; orange; 3 mm thick			
	120 mm	209-191	50 (25)

Accessories; 2001 Series

Appropriate marking systems: WMB/WMB Inline/Marking strips

Insulation stop; 5 pcs/strip; 0.25 ... 0.5 mm ²			
	light gray	2001-171	200 (25)

Push-in type jumper bar; insulated; I _N 18 A; light gray			
	2-way	2001-402	25
	3-way	2001-403	25
	4-way	2001-404	25
	5-way	2001-405	25
	6-way	2001-406	25
	7-way	2001-407	25
	8-way	2001-408	25
	9-way	2001-409	25
	10-way	2001-410	25

Push-in type jumper bar; insulated; I _N 18 A; light gray			
	1 to 3	2001-433	25
	1 to 4	2001-434	25
	1 to 5	2001-435	25
	1 to 6	2001-436	25
	1 to 7	2001-437	25
	1 to 8	2001-438	25
	1 to 9	2001-439	25
	1 to 10	2001-440	25

Protective warning marker; with black high-voltage symbol; for 5 terminal blocks			
	yellow	2001-115	100 (25)

Step-down jumper; insulated; commons 6/4 mm ² (10/12 AWG) to 4/2.5/1.5 mm ² (12/14/16 AWG); I _N 32 A			
	light gray	2006-499	25

Technical Data

0.25 ... 1.5 (2.5) mm ² ①	22 ... 14 AWG
800 V/8 kV/3 ②	600 V, 15 A ③
I _N 18 A (24 A)	600 V, 15 A ④
Terminal block width: 4.2 mm / 0.165 inch	
9 ... 11 mm / 0.35 ... 0.43 inch	

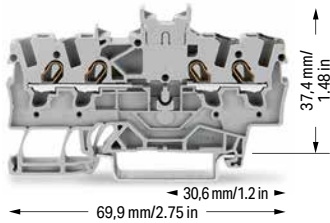

Double-potential terminal block; with double, center marking level

Color	Item No.	Pack. Unit
gray	2001-1441	100

① Conductor range: 0.25 ... 2.5 mm² "s+f-st"; Push-in termination: 0.75 ... 2.5 mm² "s" and 0.75 ... 1.5 mm² "insulated ferrules; 12 mm" Depending on the conductor characteristic, a conductor with a smaller cross section can also be inserted via push-in termination.

② 800 V = rated voltage
8 kV = rated impulse voltage
3 = pollution degree (see Section 14)

③ Terminal blocks with a blue insulated housing are suitable for Ex i applications.

④ Terminal blocks with an Ex mark are suitable for Ex e II applications.
550 V; 17 A
16 A jumper (see Section 14)

Please observe the application notes:
Separator for Ex e/Ex i applications, see page 55
Step-down jumpers, see page 59
Jumpers, from page 155
Testing accessories, from page 146
Marking, from page 588

Approvals and corresponding ratings, visit www.wago.com

Accessories; 2001 Series

Appropriate marking systems:
WMB/WMB Inline/Marking strips

Modular connector; snaps together; for jumper contact slot

gray	2001-511	100 (25)
------	----------	----------

Spacer module; snaps together; bridges commoned terminal blocks

gray	2001-549	100 (25)
------	----------	----------

End plate; for modular connector; 1.5 mm thick

gray	2002-541	100 (25)
------	----------	----------

Test plug adapter; for 4 mm Ø test plug

gray	2009-174	100 (25)
------	----------	----------

Banana plug; for 4 mm socket diameter; color mixed; 10 x orange, white, black, blue, yellow; max. 42 V

	215-111	50
--	---------	----

Testing tap; for max. 2.5 mm²

gray	2009-182	100 (25)
------	----------	----------

Test plug; with 500 mm cable; 2 mm Ø; max. 42 V

red	210-136	50
-----	---------	----

Test plug; with 500 mm cable; 2.3 mm Ø; max. 42 V

yellow	210-137	50
--------	---------	----

WMB Inline; plain; 2,000 WMB markers (4 mm)/reel; 4 ... 4.2 mm stretchable

white	2009-114	1
-------	----------	---

Accessories; 2001 Series

Appropriate marking systems:
WMB/WMB Inline/Marking strips

Marking strip; plain; 11 mm wide; 50 m reel

white	2009-110	1
-------	----------	---

WMB marking card; white; 10 strips with 10 markers/card; 4 ... 4.2 mm stretchable

plain	793-4501	5
-------	----------	---

WMB marking card; plain; 10 strips with 10 markers/card; 4 ... 4.2 mm stretchable

yellow	793-4501/000-002	5
red	793-4501/000-005	5
blue	793-4501/000-006	5
gray	793-4501/000-007	5
orange	793-4501/000-012	5
light green	793-4501/000-017	5
green	793-4501/000-023	5
violet	793-4501/000-024	5

Screwless end stop; for DIN-35 rail; 6 mm wide

gray	249-116	100 (25)
------	---------	----------

Screwless end stop; for DIN-35 rail; 10 mm wide

gray	249-117	50 (25)
------	---------	---------

Accessories; item-specific

End and intermediate plate; 0.9 mm thick

orange	2002-1492	100 (25)
gray	2002-1491	100 (25)

Separator; oversized; 2 mm thick

orange	2002-1494	100 (25)
gray	2002-1493	100 (25)

Delta jumper; insulated; I_N = I_N terminal block; light gray

1-2 3-4 5-6	2001-406/020-000	25
-------------	------------------	----

Star point jumper; insulated; I_N = I_N terminal block; light gray

1-3-5	2001-405/011-000	25
-------	------------------	----

Push-in type wire jumper; insulated; 1.5 mm² conductor cross-section; I_N 18 A

L = 60 mm	2009-412	100 (10)
L = 110 mm	2009-414	100 (10)
L = 250 mm	2009-416	100 (10)

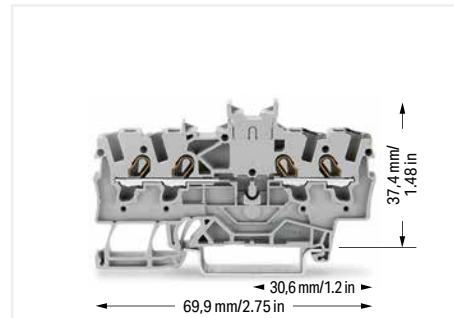

Notice: These double-potential terminal blocks cannot be commoned with push-in type jumper bars! Front-entry double-potential terminal blocks are space savers. Two independent feedthrough circuits are placed in one insulated housing on one level in just 4.2 mm. This achieves a width of just 2.1 mm versus standard through terminal blocks. Input and output of a circuit are placed on the same side of the terminal block. Both circuits can be individually marked according to input and output.

Through/Conductor/Shield Conductor/Ex and Double-Potential Terminal Block TOPJOB® S 2.5 (4) mm²; 2002 Series

1

Technical Data

0.25 ... 2.5 (4) mm ² ①	22 ... 12 AWG
800 V/8 kV/3 ②	600 V, 20 A ③
I _N 24 A (32 A)	600 V, 20 A ④
Terminal block width: 5.2 mm / 0.205 inch	
 10 ... 12 mm / 0.39 ... 0.47 inch	

Technical Data

0.25 ... 2.5 (4) mm ² ①	22 ... 12 AWG
800 V/8 kV/3 ②	600 V, 20 A ③
I _N 24 A (32 A)	600 V, 20 A ④
Terminal block width: 5.2 mm / 0.205 inch	
 10 ... 12 mm / 0.39 ... 0.47 inch	

Technical Data

0.25 ... 2.5 (4) mm ² ①	22 ... 12 AWG
800 V/8 kV/3 ②	600 V, 20 A ③
I _N 24 A (32 A)	600 V, 20 A ④
Terminal block width: 5.2 mm / 0.205 inch	
 10 ... 12 mm / 0.39 ... 0.47 inch	

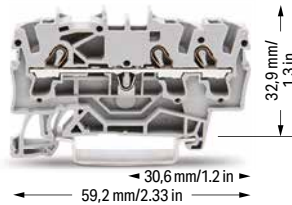
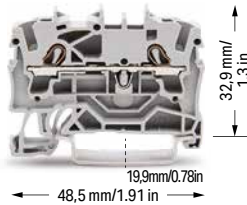

2-conductor through terminal block

Color	Item No.	Pack. Unit
gray ⑤	2002-1201 ④	100
blue ⑤	2002-1204 ③ ④	100
orange ⑤	2002-1202 ④	100
red ⑤	2002-1203 ④	100
black ⑤	2002-1205 ④	100
yellow ⑤	2002-1206 ④	100

3-conductor through terminal block

Color	Item No.	Pack. Unit
gray ⑤	2002-1301 ④	100
blue ⑤	2002-1304 ③ ④	100
orange ⑤	2002-1302 ④	100
red ⑤	2002-1303 ④	100
black ⑤	2002-1305 ④	100
yellow ⑤	2002-1306 ④	100

4-conductor through terminal block

Color	Item No.	Pack. Unit
gray ⑤	2002-1401 ④	100
blue ⑤	2002-1404 ③ ④	100
orange ⑤	2002-1402 ④	100
red ⑤	2002-1403 ④	100
black ⑤	2002-1405 ④	100
yellow ⑤	2002-1406 ④	100

2-conductor ground terminal block

green-yellow ⑤	2002-1207 ④	100
----------------	-------------	-----

3-conductor ground terminal block

green-yellow ⑤	2002-1307 ④	100
----------------	-------------	-----

4-conductor ground terminal block

green-yellow ⑤	2002-1407 ④	100
----------------	-------------	-----

2-conductor shield terminal block

white	2002-1208	100
-------	-----------	-----

3-conductor shield terminal block

white	2002-1308	100
-------	-----------	-----

4-conductor shield terminal block

white	2002-1408	100
-------	-----------	-----

Other terminal blocks with the same profile:

Diode	2002-1211/1000-411	Page 130
-------	--------------------	----------

Other terminal blocks with the same profile:

Diode	2002-1311/1000-411	Page 130
LED	2002-1321/1000-434	Page 130

Other terminal blocks with the same profile:

Diode	2002-1411/1000-411	Page 130
LED	2002-1421/1000-434	Page 130

Accessories; item-specific

End and intermediate plate; 0.8 mm thick

orange	2002-1292	100 (25)
gray	2002-1291	100 (25)

Accessories; item-specific

End and intermediate plate; 0.8 mm thick

orange	2002-1392	100 (25)
gray	2002-1391	100 (25)

Accessories; item-specific

End and intermediate plate; 0.8 mm thick

orange	2002-1492	100 (25)
gray	2002-1491	100 (25)

Separator; oversized; 2 mm thick

orange	2002-1294	100 (25)
gray	2002-1293	100 (25)

Separator; oversized; 2 mm thick

orange	2002-1394	100 (25)
gray	2002-1393	100 (25)

Separator; oversized; 2 mm thick

orange	2002-1494	100 (25)
gray	2002-1493	100 (25)

Ex e/Ex i separator; orange; 3 mm thick

90 mm	209-190	50 (25)
120 mm	209-191	50 (25)

Ex e/Ex i separator; orange; 3 mm thick

120 mm	209-191	50 (25)
--------	---------	---------

Ex e/Ex i separator; orange; 3 mm thick

120 mm	209-191	50 (25)
--------	---------	---------

Accessories; 2002 Series

Appropriate marking systems: WMB/WMB Inline/Marking strips

Insulation stop; 5 pcs/strip; 0.25 ... 0.5 mm²

light gray	2002-171	200 (25)
------------	----------	----------

Push-in type jumper bar; insulated; I_N 25 A; light gray

2-way	2002-402	25
3-way	2002-403	25
4-way	2002-404	25
5-way	2002-405	25
6-way	2002-406	25
7-way	2002-407	25
8-way	2002-408	25
9-way	2002-409	25
10-way	2002-410	25

Push-in type jumper bar; insulated; I_N 25 A; light gray

1 to 3	2002-433	25
1 to 4	2002-434	25
1 to 5	2002-435	25
1 to 6	2002-436	25
1 to 7	2002-437	25
1 to 8	2002-438	25
1 to 9	2002-439	25
1 to 10	2002-440	25

Insulation stop; 5 pcs/strip; 0.75 ... 1 mm²

dark gray	2002-172	200 (25)
-----------	----------	----------

Protective warning marker; with black high-voltage symbol; for 5 terminal blocks

yellow	2002-115	100 (25)
--------	----------	----------

Technical Data

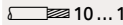
0.25 ... 2.5 (4) mm ² ①	22 ... 12 AWG
800 V/8 kV/3 ②	600 V, 20 A ③
I _N 24 A (32 A)	600 V, 20 A ④
Terminal block width: 5.2 mm / 0.205 inch	
 10 ... 12 mm / 0.39 ... 0.47 inch	

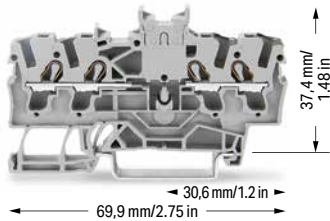

Double-potential terminal block; with double, center marking level

Color	Item No.	Pack. Unit
gray ⑤	2002-1441 ④	100

① Conductor range: 0.25 ... 4 mm² "s+f-st"; Push-in termination: 1 ... 4 mm² "s" and 1 ... 2.5 mm² "insulated ferrules, 12 mm"
Depending on the conductor characteristic, a conductor with a smaller cross section can also be inserted via push-in termination.

② 800 V = rated voltage
8 kV = rated impulse voltage
3 = pollution degree
(see Section 14)

③ Terminal blocks with a blue insulated housing are suitable for Ex i applications.

④ Terminal blocks with an Ex mark are suitable for Ex e II applications.
550 V; 22 A
20 A jumper
(see Section 14)

Please observe the application notes:
Separator for Ex e/Ex i applications, see page 55
Step-down jumpers, see page 59
Jumpers, from page 152
Testing accessories, from page 146
Marking, from page 588

Approvals and corresponding ratings, visit www.wago.com

Accessories; 2002 Series

Appropriate marking systems:
WMB/WMB Inline/Marking strips

Staggered jumper; insulated; I_N 25 A; light gray

 2-way	2002-472	25
3-way	2002-473	25
4-way	2002-474	25
5-way	2002-475	25
6-way	2002-476	25
7-way	2002-477	25
8-way	2002-478	25
9-way	2002-479	25
10-way	2002-480	25
11-way	2002-481	25
12-way	2002-482	25

Customized staggered jumper; insulated; with contact lugs broken off at the factory and circuit printing; I_N 25 A; light gray

 1-3	2002-473/011-000	25
1-3-5	2002-475/011-000	25
1-3-5-7	2002-477/011-000	25
1-3-5-7-9	2002-479/011-000	25
1-3-5-7-9-11	2002-481/011-000	25

Step-down jumper; insulated; commons 6/4 mm² (10/12 AWG) to 4/2.5/1.5 mm² (12/14/16 AWG); I_N 32 A

 light gray	2006-499	25
--	----------	----

Adjacent jumper for continuous commoning; insulated; I_N 25 A, light gray

 2-way	2002-400	25
---	----------	----

Adjacent jumper for continuous commoning; insulated; I_N 25 A; 1 to 3

 light gray	2002-423	25
red	2002-423/000-005	25
blue	2002-423/000-006	25

Adjacent jumper for continuous commoning; insulated; I_N 25 A, light gray

 5-way	2002-415	25
---	----------	----

Accessories; 2002 Series

Appropriate marking systems:
WMB/WMB Inline/Marking strips

Modular connector; snaps together; for jumper contact slot

 gray	2002-511	100 (25)
--	----------	----------

Spacer module; snaps together; bridges commoned terminal blocks

 gray	2002-549	100 (25)
--	----------	----------

End plate; for modular connector; 1.5 mm thick

 gray	2002-541	100 (25)
--	----------	----------

L-type test plug module; snaps together

 gray	2002-611	100 (25)
--	----------	----------

L-type spacer module; snaps together; bridges commoned terminal blocks

 gray	2002-649	100 (25)
--	----------	----------

End plate; for modular test plug module; 1.5 mm thick

 gray	2002-641	100 (25)
--	----------	----------

WMB Inline, plain; 1,500 WMB markers (5 mm)/reel; 5 ... 5.2 mm stretchable

 white	2009-115	1
---	----------	---

Marking strip; plain; 11 mm wide; 50 m reel

 white	2009-110	1
---	----------	---

WMB marking card; white; 10 strips with 10 markers/card; 5 ... 5.2 mm stretchable

 plain	793-5501	5
---	----------	---

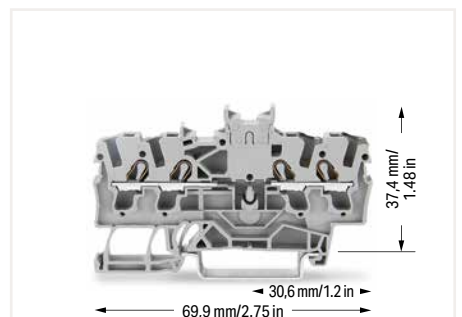

Notice: These double-potential terminal blocks cannot be commoned with push-in type jumper bars! Front-entry double-potential terminal blocks are space savers. Two independent feedthrough circuits are placed in one insulated housing on one level in just 5.2 mm. This achieves a width of just 2.6 mm versus standard through terminal blocks. Input and output of a circuit are placed on the same side of the terminal block. Both circuits can be individually marked according to input and output.

Through/Ground Conductor/Shield Conductor/Ex Terminal Block TOPJOB® S

2.5 (4) mm²; 2002 Series



1

Technical Data

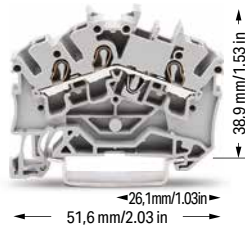
0.25 ... 2.5 (4) mm ² ①	22 ... 12 AWG
800 V/8 kV/3 ②	600 V, 20 A ③
I _N 24 A (32 A)	600 V, 20 A ④
Terminal block width: 5.2 mm / 0.205 inch	
 10 ... 12 mm / 0.39 ... 0.47 inch	



3-conductor through terminal block

Color	Item No.	Pack. Unit
 gray ⑤	2002-6301 ④	100
 blue ⑤	2002-6304 ③ ④	100
 orange ⑤	2002-6302 ④	100
 red ⑤	2002-6303 ④	100
 black ⑤	2002-6305 ④	100
 yellow ⑤	2002-6306 ④	100

3-conductor ground terminal block

 green-yellow ⑤	2002-6307 ④	100
---	-------------	-----

3-conductor shield terminal block

 white	2002-6308	100
--	-----------	-----

Accessories; 2002 Series

Appropriate marking systems:
WMB/WMB Inline/Marking strips

End and intermediate plate; 0.8 mm thick

 orange	2002-6392	100 (25)
gray	2002-6391	100 (25)

Ex e/Ex i separator; orange; 3 mm thick

 120 mm	209-191	50 (25)
---	---------	---------

Insulation stop; 5 pcs/strip; 0.25 ... 0.5 mm²

 light gray	2002-171	200 (25)
---	----------	----------

Insulation stop; 5 pcs/strip; 0.75 ... 1 mm²

 dark gray	2002-172	200 (25)
--	----------	----------

Protective warning marker; with black high-voltage symbol; for 5 terminal blocks

 yellow	2002-115	100 (25)
---	----------	----------

Push-in type jumper bar; insulated; I_N 25 A; light gray

 2-way	2002-402	25
3-way	2002-403	25
4-way	2002-404	25
5-way	2002-405	25
6-way	2002-406	25
7-way	2002-407	25
8-way	2002-408	25
9-way	2002-409	25
10-way	2002-410	25

① Conductor range: 0.25 ... 4 mm² "s+f-st"; Push-in termination: 1 ... 4 mm² "s" and 1 ... 2.5 mm² "insulated ferrules, 12 mm"
Depending on the conductor characteristic, a conductor with a smaller cross section can also be inserted via push-in termination.

② 800 V = rated voltage
8 kV = rated impulse voltage
3 = pollution degree
(see Section 14)

③ Terminal blocks with a blue insulated housing are suitable for Ex i applications.

④ Terminal blocks with an Ex mark are suitable for Ex e II applications.
550 V; 22 A
20 A jumper
(see Section 14)

Please observe the application notes:
Separator for Ex e/Ex i applications, see page 55
Step-down jumpers, see page 59
Jumpers, from page 152
Testing accessories, from page 146
Marking, from page 588

Approvals and corresponding ratings, visit www.wago.com

Accessories; 2002 Series

Appropriate marking systems:
WMB/WMB Inline/Marking strips

Push-in type jumper bar; insulated; I_N 25 A; light gray

 1 to 3	2002-433	25
1 to 4	2002-434	25
1 to 5	2002-435	25
1 to 6	2002-436	25
1 to 7	2002-437	25
1 to 8	2002-438	25
1 to 9	2002-439	25
1 to 10	2002-440	25

Delta jumper; insulated; I_N = I_N terminal block; light gray

 1-2 3-4 5-6	2002-406/020-000	25
---	------------------	----

Star point jumper; insulated; I_N = I_N terminal block; light gray

 1-3-5	2002-405/011-000	25
---	------------------	----

Staggered jumper; insulated; I_N 25 A; light gray

 2-way	2002-472	25
3-way	2002-473	25
4-way	2002-474	25
5-way	2002-475	25
6-way	2002-476	25
7-way	2002-477	25
8-way	2002-478	25
9-way	2002-479	25
10-way	2002-480	25
11-way	2002-481	25
12-way	2002-482	25

Customized staggered jumper; insulated; with contact lugs broken off at the factory and circuit printing; I_N 25 A; light gray

 1-3	2002-473/011-000	25
1-3-5	2002-475/011-000	25
1-3-5-7	2002-477/011-000	25
1-3-5-7-9	2002-479/011-000	25
1-3-5-7-9-11	2002-481/011-000	25

Adjacent jumper for continuous commoning; insulated; I_N 25 A, light gray

 2-way	2002-400	25
---	----------	----

Accessories; 2002 Series

Appropriate marking systems:
WMB/WMB Inline/Marking strips

Adjacent jumper for continuous commoning; insulated; I_N 25 A; 1 to 3

 light gray	2002-423	25
red	2002-423/000-005	25
blue	2002-423/000-006	25

Adjacent jumper for continuous commoning; insulated; I_N 25 A, light gray

 5-way	2002-415	25
---	----------	----

Push-in type wire jumper; insulated; 1.5 mm² conductor cross-section; I_N 18 A

 L = 60 mm	2009-412	100 (10)
L = 110 mm	2009-414	100 (10)
L = 250 mm	2009-416	100 (10)

Modular connector; snaps together; for jumper contact slot

 gray	2002-511	100 (25)
--	----------	----------

Spacer module; snaps together; bridges commoned terminal blocks

 gray	2002-549	100 (25)
---	----------	----------

End plate; for modular connector; 1.5 mm thick

 gray	2002-541	100 (25)
--	----------	----------

L-type test plug module; snaps together

 gray	2002-611	100 (25)
--	----------	----------

L-type spacer module; snaps together; bridges commoned terminal blocks

 gray	2002-649	100 (25)
--	----------	----------

End plate; for modular test plug module; 1.5 mm thick

 gray	2002-641	100 (25)
--	----------	----------

WMB Inline, plain; 1,500 WMB markers (5 mm)/reel; 5 ... 5.2 mm stretchable

 white	2009-115	1
---	----------	---

Marking strip; plain; 11 mm wide; 50 m reel

 white	2009-110	1
---	----------	---

WMB marking card; white; 10 strips with 10 markers/card; 5 ... 5.2 mm stretchable

 plain	793-5501	5
---	----------	---

Through/Ground Conductor/Ex Terminal Block TOPJOB® S

2.5 (4) mm²; 2002 Series

Technical Data

0.25 ... 2.5 (4) mm² ①	22 ... 12 AWG
800 V/8 kV/3 ①	600 V, 20 A ②
I _N 24 A (32 A)	600 V, 20 A ③
Terminal block width: 5.2 mm / 0.205 inch	
10 ... 12 mm / 0.39 ... 0.47 inch	



4-conductor through terminal block
 Notice: This terminal block cannot be commoned with push-in type jumper bars!

Color	Item No.	Pack. Unit
gray ④	2002-6401 ④	100
blue ④	2002-6404 ④ ④	100
orange ④	2002-6402 ④	100
red ④	2002-6403 ④	100
black ④	2002-6405 ④	100
yellow ④	2002-6406 ④	100

4-conductor ground terminal block
 green-yellow ④ 2002-6407 ④ 100

Accessories; 2002 Series
 Appropriate marking systems:
 WMB/WMB Inline/Marking strips

End and intermediate plate; 0.8 mm thick
 orange 2002-6392 100 (25)
 gray 2002-6391 100 (25)

Ex e/Ex i separator; orange; 3 mm thick
 120 mm 209-191 50 (25)

Insulation stop; 5 pcs/strip; 0.25 ... 0.5 mm²
 light gray 2002-171 200 (25)

Insulation stop; 5 pcs/strip; 0.75 ... 1 mm²
 dark gray 2002-172 200 (25)

Protective warning marker; with black high-voltage symbol; for 5 terminal blocks
 yellow 2002-115 100 (25)

WMB Inline, plain; 1,500 WMB markers (5 mm)/reel; 5 ... 5.2 mm stretchable
 white 2009-115 1

Marking strip; plain; 11 mm wide; 50 m reel
 white 2009-110 1

- Conductor range: 0.25 ... 4 mm² "s+f-st"; Push-in termination: 1 ... 4 mm² "s" and 1 ... 2.5 mm² "insulated ferrules, 12 mm" Depending on the conductor characteristic, a conductor with a smaller cross section can also be inserted via push-in termination.
- 800 V = rated voltage
 8 kV = rated impulse voltage
 3 = pollution degree (see Section 14)
- Terminal blocks with a blue insulated housing are suitable for Ex i applications.
- Terminal blocks with an Ex mark are suitable for Ex e II applications.
 550 V; 22 A
 20 A jumper (see Section 14)

Please observe the application notes:
 Separator for Ex e/Ex i applications, see page 55
 Marking, from page 58

Approvals and corresponding ratings, visit www.wago.com

Accessories; 2002 Series
 Appropriate marking systems:
 WMB/WMB Inline/Marking strips

WMB marking card; white; 10 strips with 10 markers/card; 5 ... 5.2 mm stretchable

plain	793-5501	5
-------	----------	---

WMB marking card; plain; 10 strips with 10 markers/card; 5 ... 5.2 mm stretchable

yellow	793-5501/000-002	5
red	793-5501/000-005	5
blue	793-5501/000-006	5
gray	793-5501/000-007	5
orange	793-5501/000-012	5
light green	793-5501/000-017	5
green	793-5501/000-023	5
violet	793-5501/000-024	5

Screwless end stop; for DIN-35 rail; 6 mm wide
 gray 249-116 100 (25)

Screwless end stop; for DIN-35 rail; 10 mm wide
 gray 249-117 50 (25)

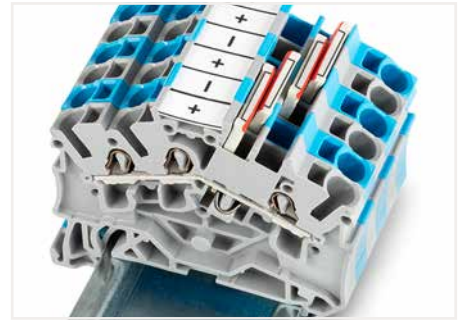

3- and 4-conductor terminal blocks (angled type): WAGO's Rail-Mount Terminal Blocks TOPJOB® S have a 35-degree conductor entry angle permitting a very small bend radius and an extremely short wiring distance to the cable duct. These are space- and cost-saving solutions for switchgear and control cabinet applications that use the LSC wiring system from Lütze. The design allows cable duct to be placed very close to the terminal blocks, keeping its height relatively low.

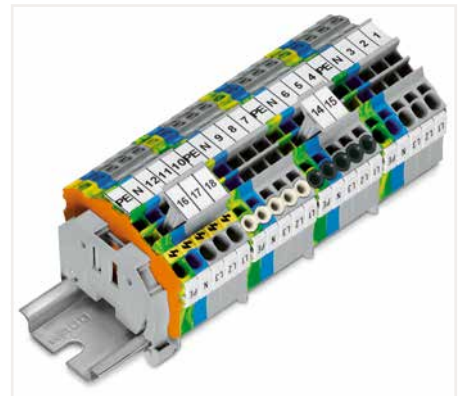

- Product features:**
- Push-in CAGE CLAMP® connection for all conductor types, with the additional benefit of solid, stranded and fine-stranded conductors with ferrules being simply pushed in
 - Vibration-proof, fast, maintenance-free
 - 3-conductor through and ground conductor terminal blocks equipped with a dual jumper slot
 - 4-conductor terminal blocks permit potential multiplication – no additional jumpers or terminal blocks needed
 - 3- and 4-conductor terminal blocks have the same dimensions.
 - An end plate must be applied when changing from a 3-conductor terminal block to a 4-conductor terminal block and vice versa.

Sold & Serviced By:

 Toll Free Phone (877) SERV098
www.electromate.com
sales@electromate.com

Through/Ground Conductor/Shield Conductor/Ex Terminal Block TOPJOB® S 4 (6) mm²; 2004 Series

1

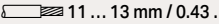
Technical Data	
0.5 ... 4 (6) mm ² ①	20 ... 10 AWG
800 V/8 kV/3 ②	600 V, 30 A ③
I _N 32 A (41 A)	600 V, 30 A ④
Terminal block width: 6.2 mm / 0.244 inch	
 11 ... 13 mm / 0.43 ... 0.51 inch	

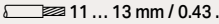
Technical Data	
0.5 ... 4 (6) mm ² ①	20 ... 10 AWG
800 V/8 kV/3 ②	600 V, 30 A ③
I _N 32 A (41 A)	600 V, 30 A ④
Terminal block width: 6.2 mm / 0.244 inch	
 11 ... 13 mm / 0.43 ... 0.51 inch	

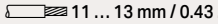
Technical Data	
0.5 ... 4 (6) mm ² ①	20 ... 10 AWG
800 V/8 kV/3 ②	600 V, 30 A ③
I _N 32 A (41 A)	600 V, 30 A ④
Terminal block width: 6.2 mm / 0.244 inch	
 11 ... 13 mm / 0.43 ... 0.51 inch	

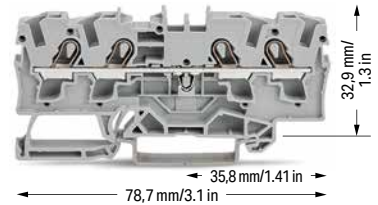
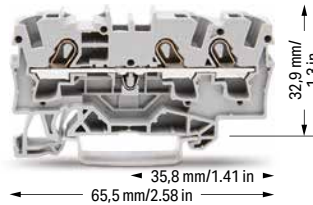

2-conductor through terminal block		
Color	Item No.	Pack. Unit
gray ⑤	2004-1201 ④	50
blue ⑤	2004-1204 ③ ④	50
orange ⑤	2004-1202 ④	50
red ⑤	2004-1203 ④	50
black ⑤	2004-1205 ④	50
yellow ⑤	2004-1206 ④	50

3-conductor through terminal block		
Color	Item No.	Pack. Unit
gray ⑤	2004-1301 ④	50
blue ⑤	2004-1304 ③ ④	50
orange ⑤	2004-1302 ④	50
red ⑤	2004-1303 ④	50
black ⑤	2004-1305 ④	50
yellow ⑤	2004-1306 ④	50

4-conductor through terminal block		
Color	Item No.	Pack. Unit
gray ⑤	2004-1401 ④	50
blue ⑤	2004-1404 ③ ④	50
orange ⑤	2004-1402 ④	50
red ⑤	2004-1403 ④	50
black ⑤	2004-1405 ④	50
yellow ⑤	2004-1406 ④	50

2-conductor ground terminal block		
green-yellow ⑤	2004-1207 ④	50

3-conductor ground terminal block		
green-yellow ⑤	2004-1307 ④	50



4-conductor ground terminal block		
green-yellow ⑤	2004-1407 ④	50



4-conductor shield terminal block		
white ⑤	2004-1408	50



Other terminal blocks with the same profile:		
Diode	2004-1211/1000-401	Page 132



Other terminal blocks with the same profile:		
Diode	2004-1311/1000-401	Page 132



Other terminal blocks with the same profile:		
Diode	2004-1411/1000-401	Page 132



Accessories; item-specific		
End and intermediate plate; 1 mm thick		
 orange	2004-1292	100 (25)
 gray	2004-1291	100 (25)



Accessories; item-specific		
End and intermediate plate; 1 mm thick		
 orange	2004-1392	100 (25)
 gray	2004-1391	100 (25)

Accessories; item-specific		
End and intermediate plate; 1 mm thick		
 orange	2004-1492	100 (25)
 gray	2004-1491	100 (25)

Separator; oversized; 2 mm thick		
 orange	2004-1294	100 (25)
 gray	2004-1293	100 (25)

Separator; oversized; 2 mm thick		
 orange	2004-1394	100 (25)
 gray	2004-1393	100 (25)

Separator; oversized; 2 mm thick		
 orange	2004-1494	100 (25)
 gray	2004-1493	100 (25)

Ex e/Ex i separator; orange; 3 mm thick		
 90 mm	209-190	50 (25)
 120 mm	209-191	50 (25)









Ex e/Ex i separator; orange; 3 mm thick		
 120 mm	209-191	50 (25)









Ex e/Ex i separator; orange; 3 mm thick		
 120 mm	209-191	50 (25)

Accessories; 2004 Series

Appropriate marking systems: WMB/WMB Inline/Marking strips

Insulation stop; 5 pcs/strip; 0.25 ... 0.5 mm ²		
 light gray	2004-171	200 (25)

Push-in type jumper bar; insulated; I _N 32 A; light gray		
 2-way	2004-402	25
 3-way	2004-403	25
 4-way	2004-404	25
 5-way	2004-405	25
 6-way	2004-406	25
 7-way	2004-407	25
 8-way	2004-408	25
 9-way	2004-409	25
 10-way	2004-410	25

Push-in type jumper bar; insulated; I _N 32 A; light gray		
 1 to 3	2004-433	25
 1 to 4	2004-434	25
 1 to 5	2004-435	25
 1 to 6	2004-436	25
 1 to 7	2004-437	25
 1 to 8	2004-438	25
 1 to 9	2004-439	25
 1 to 10	2004-440	25

Insulation stop; 5 pcs/strip; 0.75 ... 1 mm ²		
 dark gray	2004-172	200 (25)

Star point jumper; insulated; I _N = I _N terminal block; light gray		
 1-3-5	2004-405/011-000	25

Step-down jumper; insulated; commons 6/4 mm ² (10/12 AWG) to 4/2.5/1.5 mm ² (12/14/16 AWG); I _N 32 A		
 light gray	2006-499	25

Protective warning marker; with black high-voltage symbol; for 5 terminal blocks		
 yellow	2004-115	100 (25)

Delta jumper; insulated; I _N = I _N terminal block; light gray		
 1-2-3-4-5-6	2004-406/020-000	25

- ❶ Conductor range: 0.5 ... 6 mm² "s+f-st"; Push-in termination: 1.5 ... 6 mm² "s" and 1.5 ... 4 mm² "insulated ferrules; 12 mm"
Depending on the conductor characteristic, a conductor with a smaller cross section can also be inserted via push-in termination.
- ❷ 800 V = rated voltage
8 kV = rated impulse voltage
3 = pollution degree
(see Section 14)
- ❸ Terminal blocks with a blue insulated housing are suitable for Ex i applications.
- ❹ Terminal blocks with an Ex mark are suitable for Ex e II applications.
550 V; 30 A
(see Section 14)

Please observe the application notes:
Separator for Ex e/Ex i applications, see page 55
Step-down jumpers, see page 59
Jumpers, from page 155
Testing accessories, from page 148
Marking, from page 588

Approvals and corresponding ratings, visit www.wago.com

Accessories; 2004 Series

Appropriate marking systems:
WMB/WMB Inline/Marking strips

Modular connector; snaps together; for jumper contact slot

	gray	2004-511	100 (25)
---	------	----------	----------

Spacer module; snaps together; bridges commoned terminal blocks

	gray	2004-549	100 (25)
---	------	----------	----------

End plate; for modular connector; 1.5 mm thick

	gray	2004-541	100 (25)
---	------	----------	----------

Test plug adapter; for 4 mm Ø test plug

	gray	2009-174	100 (25)
---	------	----------	----------

Banana plug; for 4 mm socket diameter; color mixed; 10 x orange, white, black, blue, yellow; max. 42 V

		215-111	50
---	--	---------	----

Testing tap; for max. 2.5 mm²

	gray	2009-182	100 (25)
---	------	----------	----------

Marking strip; plain; 11 mm wide; 50 m reel

	white	2009-110	1
---	-------	----------	---

WMB marking card; white; 10 strips with 10 markers/card; 5 ... 5.2 mm stretchable

	plain	793-5501	5
---	-------	----------	---

Group marker carrier; snap-on type for jumper slot; 5 mm wide

	gray	2009-191	50 (25)
---	------	----------	---------

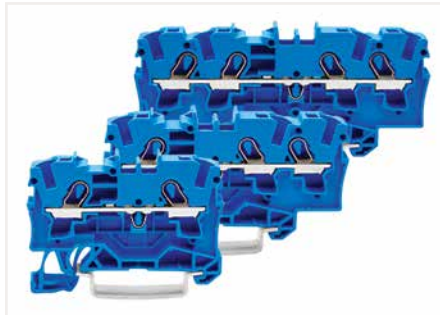

Through terminal blocks with a blue insulated housing are suitable for Ex i applications.



All through and ground conductor terminal blocks are suitable for Ex e II applications.

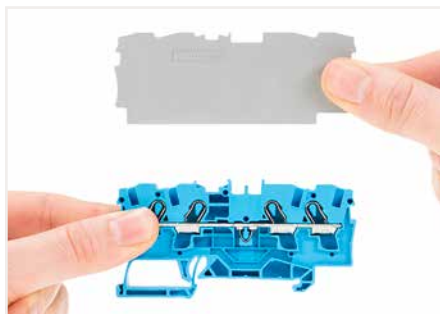

Separator for Ex e/Ex i applications:
An end plate must be applied to the terminal block located directly behind an Ex e/Ex i separator plate.



Ex e II/Ex i terminal strip
Notice:
The movable feet of terminal blocks and separator plates must face the same direction.

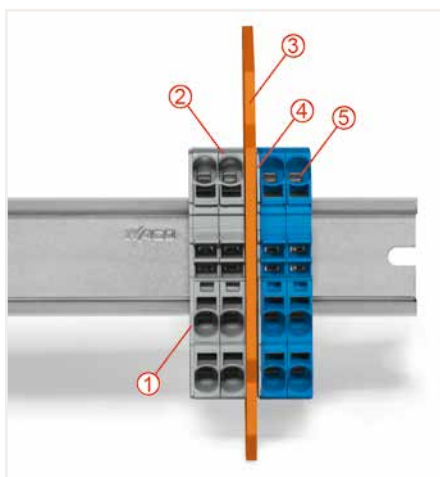

Separator located between Ex e II and Ex i terminal strip
❶ End plate
❷ Ex e II terminal blocks
❸ Separator for Ex e/Ex i applications
❹ End plate
❺ Ex i terminal blocks



Example of marking (rear):
The embossed details on the terminal blocks show the manufacturer's name, the series no., the type of protection Ex e II, the approval no., the approval data and the name of the testing authority.

Through/Ground Conductor/Shield Conductor/Ex Terminal Block TOPJOB® S

6 (10) mm²; 2006 Series

1

Technical Data

0.5 ... 6 (10) mm ² ①	20 ... 8 AWG
800 V/8 kV/3 ②	600 V, 50 A ③
I _N 41 A (57 A)	600 V, 50 A ④
Terminal block width: 7.5 mm / 0.295 inch	
13 ... 15 mm / 0.51 ... 0.59 inch	



2-conductor through terminal block

Color	Item No.	Pack. Unit
gray ⑤	2006-1201 ④	50
blue ⑤	2006-1204 ③ ④	50
orange ⑤	2006-1202 ④	50

2-conductor ground terminal block

green-yellow ⑤	2006-1207 ④	50
----------------	-------------	----

2-conductor shield terminal block

white	2006-1208	50
-------	-----------	----

Accessories; item-specific

End and intermediate plate; 1 mm thick

orange	2006-1292	100 (25)
gray	2006-1291	100 (25)

Separator; oversized; 2 mm thick

orange	2006-1294	100 (25)
gray	2006-1293	100 (25)

Accessories; 2006 Series

Appropriate marking systems: WMB/WMB Inline/Marking strips

Ex e/Ex i separator; orange; 3 mm thick

120 mm	209-191	50 (25)
--------	---------	---------

Push-in type jumper bar; insulated; I_N 41 A; light gray

2-way	2006-402	25
3-way	2006-403	25
4-way	2006-404	25
5-way	2006-405	25

Push-in type jumper bar; insulated; I_N 41 A; light gray

1 to 3	2006-433	25
1 to 4	2006-434	25
1 to 5	2006-435	25

Star point jumper; insulated; I_N = I_N terminal block; light gray

1-3-5	2006-405/011-000	25
-------	------------------	----

Step-down jumper; insulated; commons 6/4 mm² (10/12 AWG) to 4/2.5/1.5 mm² (12/14/16 AWG); I_N 32 A

light gray	2006-499	25
------------	----------	----

Technical Data

0.5 ... 6 (10) mm ² ①	20 ... 8 AWG
800 V/8 kV/3 ②	600 V, 50 A ③
I _N 41 A (57 A)	600 V, 50 A ④
Terminal block width: 7.5 mm / 0.295 inch	
13 ... 15 mm / 0.51 ... 0.59 inch	

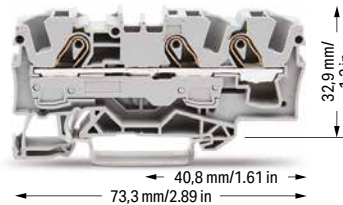

3-conductor through terminal block

Color	Item No.	Pack. Unit
gray ⑤	2006-1301 ④	25
blue ⑤	2006-1304 ③ ④	25
orange ⑤	2006-1302 ④	25
black ⑤	2006-1305 ④	25

3-conductor ground terminal block

green-yellow ⑤	2006-1307 ④	25
----------------	-------------	----

Accessories; item-specific

End and intermediate plate; 1 mm thick

orange	2006-1392	100 (25)
gray	2006-1391	100 (25)

Separator; oversized; 2 mm thick

orange	2006-1394	100 (25)
gray	2006-1393	100 (25)

Protective warning marker; with black high-voltage symbol; for 5 terminal blocks

yellow	2006-115	100 (25)
--------	----------	----------

Lockout cap; for conductor entry and operating slot

gray	2006-191	25
------	----------	----

Modular connector; snaps together; for jumper contact slot

gray	2006-511	50 (25)
------	----------	---------

Test plug adapter; for 4 mm Ø test plug

gray	2009-174	100 (25)
------	----------	----------

Marking strip; plain; 11 mm wide; 50 m reel

white	2009-110	1
-------	----------	---

① Conductor range: 0.5 ... 10 mm² "s+f-st"; Push-in termination: 2.5 ... 10 mm² "s" and 2.5 ... 6 mm² "insulated ferrules; 12 mm"
Depending on the conductor characteristic, a conductor with a smaller cross section can also be inserted via push-in termination.

② 800 V = rated voltage
8 kV = rated impulse voltage
3 = pollution degree
(see Section 14)

③ Terminal blocks with a blue insulated housing are suitable for Ex i applications.

④ Terminal blocks with an Ex mark are suitable for Ex e II applications.
550 V; 38 A; for 2-conductor terminal blocks
550 V; 36 A; for 3-conductor terminal blocks
33 A jumper
(see Section 14)

Please observe the application notes:
Separator for Ex e/Ex i applications, see page 55
Step-down jumpers, see page 59
Jumpers, from page 155
Testing accessories, from page 148
Marking, from page 588

Approvals and corresponding ratings, visit www.wago.com



Cover (2006-191) seals unused conductor entry.

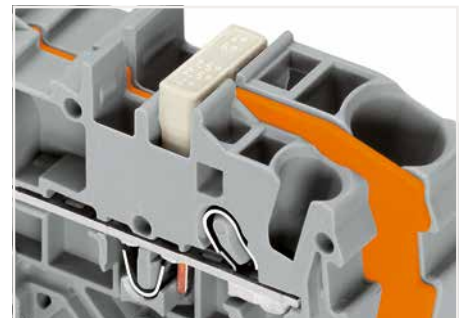

Commoning with step-down jumpers.

Through/Ground Conductor/Shield Conductor/Ex Terminal Block TOPJOB® S

10 (16) mm²; 2010 Series

Technical Data	
0.5 ... 10 (16) mm ² ①	20 ... 6 AWG
800 V/8 kV/3 ②	600 V, 65 A ③
I _n 57 A (76 A)	600 V, 65 A ④
Terminal block width: 10 mm / 0.394 inch	
17 ... 19 mm / 0.67 ... 0.91 inch	

Technical Data	
0.5 ... 10 (16) mm ² ①	20 ... 6 AWG
800 V/8 kV/3 ②	600 V, 65 A ③
I _n 57 A (76 A)	600 V, 65 A ④
Terminal block width: 10 mm / 0.394 inch	
17 ... 19 mm / 0.67 ... 0.91 inch	

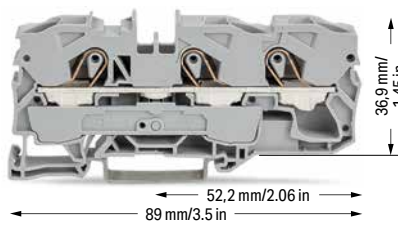
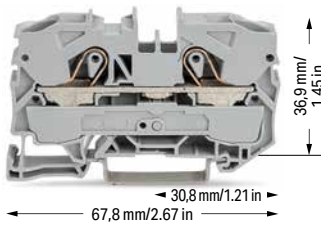

2-conductor through terminal block		
Color	Item No.	Pack. Unit
gray ⑤	2010-1201 ④	25
blue ⑤	2010-1204 ③ ④	25
orange ⑤	2010-1202 ④	25
black ⑤	2010-1205 ④	25

3-conductor through terminal block		
Color	Item No.	Pack. Unit
gray ⑤	2010-1301 ④	25
blue ⑤	2010-1304 ③ ④	25
orange ⑤	2010-1302 ④	25
black ⑤	2010-1305 ④	25

2-conductor ground terminal block		
green-yellow ⑤	2010-1207 ④	25

3-conductor ground terminal block		
green-yellow ⑤	2010-1307 ④	25

2-conductor shield terminal block		
white	2010-1208	25

Accessories; item-specific			
End and intermediate plate; 1 mm thick			
orange	2010-1292	100 (25)	
gray	2010-1291	100 (25)	

Accessories; item-specific			
End and intermediate plate; 1 mm thick			
orange	2010-1392	100 (25)	
gray	2010-1391	100 (25)	

Ex e/Ex i separator; orange; 3 mm thick		
120 mm	209-191	50 (25)

Accessories; 2010 Series
Appropriate marking systems: WMB/WMB Inline/Marking strips

Push-in type jumper bar; insulated; I _n 57 A; light gray			
2-way	2010-402	25	
3-way	2010-403	25	
4-way	2010-404	25	
5-way	2010-405	25	

Finger guard; touch-proof cover protects unused conductor entries			
yellow	2010-100	100 (25)	

Push-in type jumper bar; insulated; I _n 57 A; light gray			
1 to 3	2010-433	25	
1 to 4	2010-434	25	
1 to 5	2010-435	25	

Modular connector; snaps together; for jumper contact slot			
gray	2010-511	50 (25)	

Star point jumper; insulated; I _n = I _n terminal block; light gray			
1-3-5	2010-405/011-000	25	

Test plug adapter; for 4 mm Ø test plug			
gray	2009-174	100 (25)	

Step-down jumper; insulated; commons 16/10 mm ² (8/10 AWG) to 10/6/4/2.5 mm ² (8/10/12/14 AWG); I _n 57 A			
light gray	2016-499	25	

Marking strip; plain; 11 mm wide; 50 m reel			
white	2009-110	1	

Protective warning marker; with black high-voltage symbol; for 5 terminal blocks			
yellow	2010-115	100 (25)	

WMB marking card; white; 10 strips with 10 markers/card; 5 ... 5.2 mm stretchable			
plain	793-5501	5	

- Conductor range: 0.5 ... 16 mm² "s+f-st"; Push-in termination: 4 ... 16 mm² "s" and 4 ... 10 mm² "insulated ferrules; 18 mm"
Depending on the conductor characteristic, a conductor with a smaller cross section can also be inserted via push-in termination.
- 800 V = rated voltage
8 kV = rated impulse voltage
3 = pollution degree
(see Section 14)
- Terminal blocks with a blue insulated housing are suitable for Ex i applications.
- Terminal blocks with an Ex mark are suitable for Ex e II applications.
550 V; 51 A; for 2-conductor terminal blocks
550 V; 50 A; for 3-conductor terminal blocks
(see Section 14)

Please observe the application notes:
Separator for Ex e/Ex i applications, see page 55
Step-down jumpers, see page 59
Jumpers, from page 155
Testing accessories, from page 148
Marking, from page 588

Approvals and corresponding ratings, visit www.wago.com



Commoning with step-down jumpers:
An end plate must be inserted between the terminal blocks to be commoned. Step-down jumpers (2016-499) common 16/10 mm² (16/8 AWG) terminal blocks (2016/2010 Series) with 10/6/4/2.5 mm² (8/10/12/14 AWG) terminal blocks (2010/2006/2004/2002 Series). Step-down jumpers are simply pushed down for full insertion, similar to other push-in type jumper bars.
Note:
The total current of the outgoing circuits must not exceed the nominal current of the step-down jumper/push-in type jumper bar.

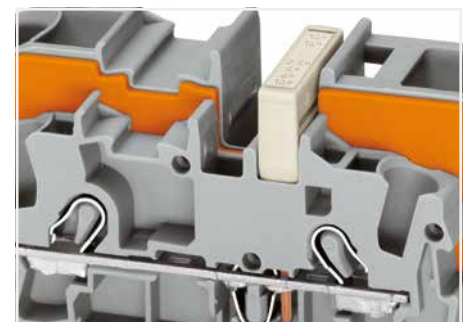

Commoning with step-down jumpers.

Through/Ground Conductor/Shield Conductor/Ex Terminal Block TOPJOB® S

16 (25 "f-st") mm²; 2016 Series



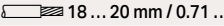

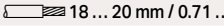
1



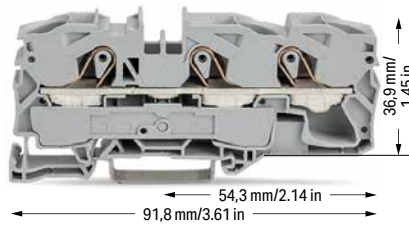
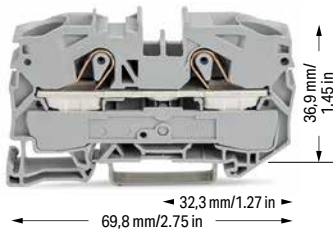



Technical Data	
0.5 ... 16 (25 "f-st") mm ² ①	20 ... 4 AWG
800 V/8 kV/3 ②	600 V, 85 A ③
I _N 76 A (90 A)	600 V, 80 A ④
Terminal block width: 12 mm / 0.472 inch	
 18 ... 20 mm / 0.71 ... 0.79 inch	

Technical Data	
0.5 ... 16 (25 "f-st") mm ² ①	20 ... 4 AWG
800 V/8 kV/3 ②	600 V, 85 A ③
I _N 76 A (90 A)	600 V, 80 A ④
Terminal block width: 12 mm / 0.472 inch	
 18 ... 20 mm / 0.71 ... 0.79 inch	

- ① Conductor range: 0.5 ... 16 mm² "s+f-st", 25 mm² "f-st"; Push-in termination: 6 ... 16 mm² "s" and 6 ... 16 mm² "insulated ferrules; 18 mm" Depending on the conductor characteristic, a conductor with a smaller cross section can also be inserted via push-in termination.
- ② 800 V = rated voltage
8 kV = rated impulse voltage
3 = pollution degree (see Section 14)
- ③ Terminal blocks with a blue insulated housing are suitable for Ex i applications.
- ④ Terminal blocks with an Ex mark are suitable for Ex e II applications.
550 V; 70 A; for 2-conductor terminal blocks
550 V; 67 A; for 3-conductor terminal blocks
65 A jumper (see Section 14)





2-conductor through terminal block		
Color	Item No.	Pack. Unit
 gray ⑤	2016-1201 ④	20
 blue ⑤	2016-1204 ③ ④	20
 orange ⑤	2016-1202 ④	20
 red ⑤	2016-1203 ④	20

3-conductor through terminal block		
Color	Item No.	Pack. Unit
 gray ⑤	2016-1301 ④	20
 blue ⑤	2016-1304 ③ ④	20
 orange ⑤	2016-1302 ④	20
 red ⑤	2016-1203 ④	20
 black ⑤	2016-1305 ④	20
 yellow ⑤	2016-1206 ④	20

Please observe the application notes:
Separator for Ex e/Ex i applications, see page 55
Step-down jumpers, see page 59
Jumpers, from page 155
Testing accessories, from page 149
Marking, from page 588

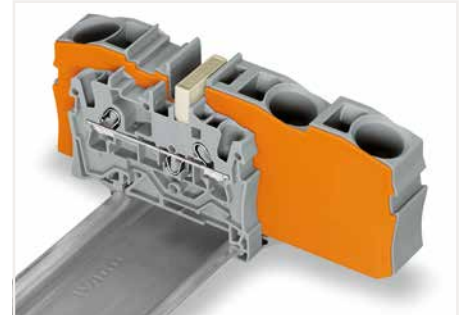

Approvals and corresponding ratings, visit www.wago.com





2-conductor ground terminal block		
15 mm high DIN-35 rails shall be used for a current load higher than 76 A!		
 green-yellow ⑤	2016-1207 ④	20

3-conductor ground terminal block		
15 mm high DIN-35 rails shall be used for a current load higher than 76 A!		
 green-yellow ⑤	2016-1307 ④	20

2-conductor shield terminal block		
15 mm high DIN-35 rails shall be used for a current load higher than 76 A!		
 white	2016-1208	20





Accessories; item-specific			
End and intermediate plate; 1 mm thick			
	orange	2016-1292	100 (25)
	gray	2016-1291	100 (25)

Accessories; item-specific			
End and intermediate plate; 1 mm thick			
	orange	2016-1392	100 (25)
	gray	2016-1391	100 (25)



Ex e/Ex i separator; orange; 3 mm thick			
	120 mm	209-191	50 (25)

Step-down jumpers common terminal blocks of different sizes, without losing a conductor clamping point. This can be beneficial on long conductor runs where voltage drop can be a problem. A large conductor can be easily connected to smaller conductors at the distribution point. Commoning may be made in either direction using the special thin end plate to cover the open side. Additional through terminal blocks having a smaller cross-section may be commoned using push-in type jumper bars.

Accessories; 2016 Series
Appropriate marking systems: WMB/WMB Inline/Marking strips

Push-in type jumper bar; insulated; I _N 41 A; light gray			
	2-way	2016-402	25
	3-way	2016-403	25
	4-way	2016-404	25
	5-way	2016-405	25

Protective warning marker; with black high-voltage symbol; for 5 terminal blocks			
	yellow	2016-115	100 (25)

Push-in type jumper bar; insulated; I _N 41 A; light gray			
	1 to 3	2016-433	25
	1 to 4	2016-434	25
	1 to 5	2016-435	25

Finger guard; touch-proof cover protects unused conductor entries			
	yellow	2016-100	100 (25)

Star point jumper; insulated; I _N = I _N terminal block; light gray			
	1-3-5	2016-405/011-000	25

Modular connector; snaps together; for jumper contact slot			
	gray	2016-511	50 (25)

Step-down jumper; insulated; commons 16/10 mm ² (8/10 AWG) to 10/6/4/2.5 mm ² (8/10/12/14 AWG); I _N 57 A			
	light gray	2016-499	25

Test plug adapter; for 4 mm Ø test plug			
	gray	2009-174	100 (25)



Finger guard seals an unused conductor entry.

Step-Down Jumpers TOPJOB® S Installation



Step-down jumpers (2006-499 and 2016-499)

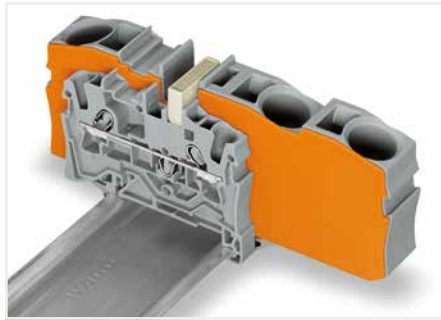

Step-down jumpers connect terminal blocks of different sizes, without losing a conductor clamping point. This can be beneficial on long conductor runs where voltage drop can be a problem. A large conductor can be easily connected to smaller conductors at the distribution point. Commoning may be made in either direction using the special thin end plate to cover the open side. Additional through terminal blocks having a smaller cross-section may be commoned using push-in type jumper bars.



Using step-down jumpers, an end plate must be inserted between the terminal blocks to be commoned.

1

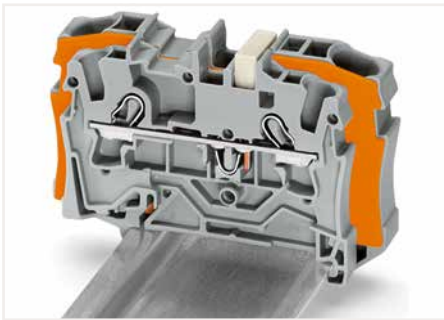

Step-down jumper (2006-499) commons 6/4 mm² (10/12 AWG) terminal blocks (2006/2004 Series) with 4/2.5/1.5 mm² (AWG 12/14/16) terminal blocks (2004/2002/2001 Series).



Step-down jumper (2016-499) commons 16/10 mm² (16/8 AWG) terminal blocks (2016/2010 Series) with 10/6/4/2.5 mm² (8/10/12/14 AWG) terminal blocks (2010/2006/2004/2002 Series).



Stepping down via push-in type jumper bar:
Commoning via open terminal side with end plate allows jumpering over two cross-section sizes for 16 mm² (6 AWG) and 10 mm² (8 AWG) and one cross-section size for 6/4/2.5 mm² (10/12/14 AWG). An example: from 16 mm² (6 AWG) to 6 mm² (10 AWG) (see illustration above) or from 10 mm² (8 AWG) to 4 mm² (12 AWG).

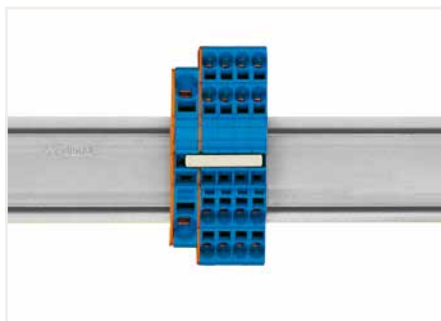

Stepping down via push-in type jumper bar:
Commoning via closed terminal side with end plate allows jumpering over two cross-section sizes, e.g., from 16 mm² (6 AWG) to 6 mm² (10 AWG) or from 6 mm² (10 AWG) to 2.5 mm² (14 AWG) (see illustration above).



Note:
The total current of the outgoing circuits must not exceed the nominal current of the step-down jumper/push-in type jumper bar.

Double-Deck Terminal Block TOPJOB® S

1 (1.5) mm²; 2000 Series

1

Technical Data	
0.14 ... 1 (1.5) mm ² ①	24 ... 16 AWG
500 V/6 kV/3 ②	600 V, 10 A ③
I _N 13.5 A (16 A)	
Terminal block width: 3.5 mm / 0.138 inch	
9 ... 11 mm / 0.35 ... 0.43 inch	

Technical Data	
0.14 ... 1 (1.5) mm ² ①	24 ... 16 AWG
500 V/6 kV/3 ②	600 V, 10 A ③
I _N 13.5 A (16 A)	
Terminal block width: 3.5 mm / 0.138 inch	
9 ... 11 mm / 0.35 ... 0.43 inch	

Technical Data	
0.14 ... 1 (1.5) mm ² ①	24 ... 16 AWG
500 V/6 kV/3 ②	600 V, 10 A ③
I _N 13.5 A (16 A)	
Terminal block width: 3.5 mm / 0.138 inch	
9 ... 11 mm / 0.35 ... 0.43 inch	

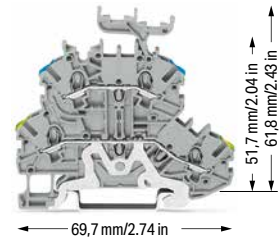
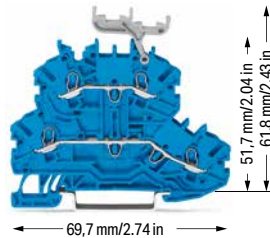
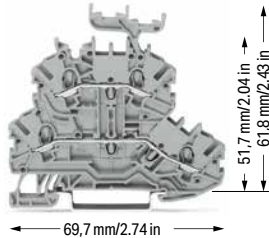

Double-deck terminal block; through/through terminal block; with marker carrier; gray housing		
	Item No.	Pack. Unit
○ L/L	2000-2231	50
○ N/L	2000-2232	50
○ L/N	2000-2233	50

Double-deck terminal block; through/through terminal block; with marker carrier; blue housing		
	Item No.	Pack. Unit
● N/N	2000-2234	50

Double-deck terminal block; ground conductor/through terminal block; with marker carrier; blue housing		
	Item No.	Pack. Unit
○ PE/N	2000-2247	50
○ PE/L	2000-2257	50

Double-deck terminal block; through/through terminal block; without marker carrier; gray housing		
	Item No.	Pack. Unit
○ L/L	2000-2201	50
○ N/L	2000-2202	50
○ L/N	2000-2203	50

Double-deck terminal block; through/through terminal block; without marker carrier; blue housing		
	Item No.	Pack. Unit
● N/N	2000-2204	50

Double-deck terminal block; ground conductor/through terminal block; without marker carrier; gray housing		
	Item No.	Pack. Unit
○ PE/N	2000-2217	50
○ PE/L	2000-2227	50

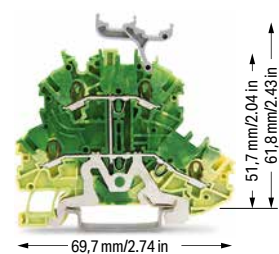
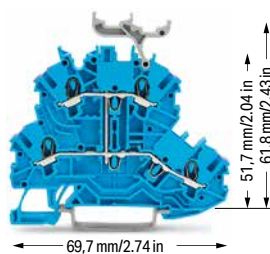
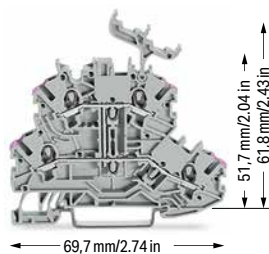

Double-deck terminal block; 4-conductor through terminal block; with marker carrier; internally commoned; violet conductor entry; gray housing		
	Item No.	Pack. Unit
○ L	2000-2238	50

Double-deck terminal block; 4-conductor through terminal block; with marker carrier; internally commoned; violet conductor entry; blue housing		
	Item No.	Pack. Unit
● N	2000-2239	50

Double-deck terminal block; 4-conductor ground terminal block; with marker carrier; internally commoned; green-yellow housing		
	Item No.	Pack. Unit
● PE	2000-2237	50

Double-deck terminal block; 4-conductor through terminal block; without marker carrier; internally commoned; violet conductor entry; gray housing		
	Item No.	Pack. Unit
○ L	2000-2208	50

Double-deck terminal block; 4-conductor through terminal block; without marker carrier; internally commoned; violet conductor entry; blue housing		
	Item No.	Pack. Unit
● N	2000-2209	50

Double-deck terminal block; 4-conductor ground terminal block; without marker carrier; internally commoned; green-yellow housing		
	Item No.	Pack. Unit
● PE	2000-2207	50

Technical Data

0.14 ... 1 (1.5) mm ² ①	24 ... 16 AWG
500 V/6 kV/3 ②	600 V, 10 A ③
I _N 13.5 A (16 A)	
Terminal block width: 3.5 mm / 0.138 inch	
9 ... 11 mm / 0.35 ... 0.43 inch	

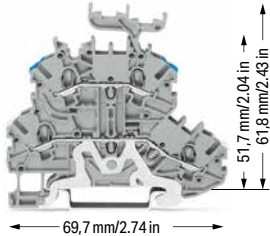

Double-deck terminal block; shield/through terminal block; with marker carrier; gray housing

	Item No.	Pack. Unit
○ Shield/N	2000-2248	50
○ Shield/L	2000-2258	50

Double-deck terminal block; shield/through terminal block; without marker carrier; gray housing

○ Shield/N	2000-2218	50
○ Shield/L	2000-2228	50

① Conductor range: 0.14 ... 1.5 mm² "s+f-st"; Push-in termination: 0.5 ... 1.5 mm² "s" and 0.5 ... 0.75 mm² "insulated ferrules; 12 mm" Depending on the conductor characteristic, a conductor with a smaller cross section can also be inserted via push-in termination.

② 800 V = rated voltage
8 kV = rated impulse voltage
3 = pollution degree
(see Section 14)

Please observe the application notes:
Jumpers, from page 157
Testing accessories, from page 151
Marking, from page 588

Approvals and corresponding ratings, visit www.wago.com

Accessories; 2000 Series

Appropriate marking systems:
WMB/WMB Inline/Marking strips

End and intermediate plate; 0.7 mm thick

orange	2000-2292	25
gray	2000-2291	25

Push-in type jumper bar; insulated; I_N 14 A; light gray

2-way	2000-402	25
3-way	2000-403	25
4-way	2000-404	25
5-way	2000-405	25
6-way	2000-406	25
7-way	2000-407	25
8-way	2000-408	25
9-way	2000-409	25
10-way	2000-410	25

Push-in type jumper bar; insulated; I_N 14 A; light gray

1 to 3	2000-433	25
1 to 4	2000-434	25
1 to 5	2000-435	25
1 to 6	2000-436	25
1 to 7	2000-437	25
1 to 8	2000-438	25
1 to 9	2000-439	25
1 to 10	2000-440	25

Double-deck vertical jumper; insulated; I_N 13.5 A

light gray	2000-492	100 (25)
------------	----------	----------

Protective warning marker; with black high-voltage symbol; for 5 terminal blocks

yellow	2000-115	100 (25)
--------	----------	----------

Test plug adapter; for 4 mm Ø test plug

gray	2009-174	100 (25)
------	----------	----------

Banana plug; for 4 mm socket diameter; color mixed; 10 x orange, white, black, blue, yellow; max. 42 V

	215-111	50
--	---------	----

Testing tap; for max. 2.5 mm²

gray	2009-182	100 (25)
------	----------	----------

WMB Inline; plain; 2,300 WMB markers (3.5 mm)/reel

white	2009-113	1
-------	----------	---

Accessories; 2000 Series

Appropriate marking systems:
WMB/WMB Inline/Marking strips

WMB marking card; white; 10 strips with 10 markers/card; for 3.5 mm terminal block width

plain	793-3501	5
-------	----------	---

Marking strip; plain; 11 mm wide; 50 m reel

white	2009-110	1
-------	----------	---

Double-deck marker carrier; pivoting

gray	2000-121	50 (25)
------	----------	---------

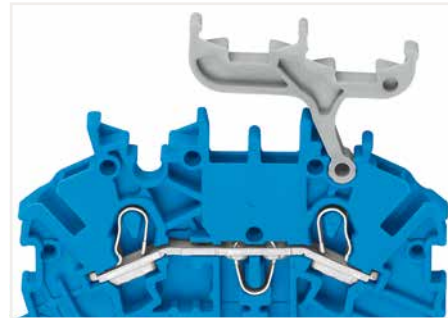

Double-deck terminal blocks:
A double-deck marker carrier (2000-121) can be retrofitted to double-deck terminal blocks without a marker carrier.

Double-Deck Terminal Block TOPJOB® S; with End Plate; 800 V 1 (1.5) mm²; 2000 Series

1

Technical Data	
0.14 ... 1 (1.5) mm ² ①	24 ... 16 AWG
800 V/8 kV/3 ②	600 V, 10 A ③
I _N 13.5 A (16 A)	
Terminal block width: 4.2 mm / 0.165 inch	
9 ... 11 mm / 0.35 ... 0.43 inch	

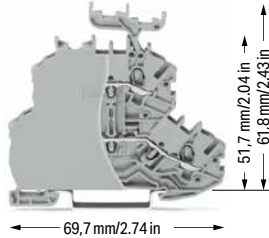

Double-deck terminal block; through/through terminal block; with end plate; with marker carrier; gray housing

	Item No.	Pack. Unit
○ L/L	2000-2231/099-000	50
○ N/L	2000-2232/099-000	50
○ L/N	2000-2233/099-000	50

Double-deck terminal block; through/through terminal block; with end plate; without marker carrier; gray housing		
○ L/L	2000-2201/099-000	50
○ N/L	2000-2202/099-000	50
○ L/N	2000-2203/099-000	50

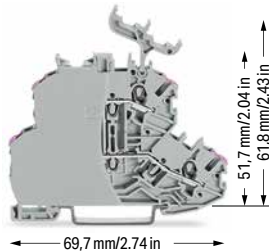

Technical Data	
0.14 ... 1 (1.5) mm ² ①	24 ... 16 AWG
800 V/8 kV/3 ②	600 V, 10 A ③
I _N 13.5 A (16 A)	
Terminal block width: 4.2 mm / 0.165 inch	
9 ... 11 mm / 0.35 ... 0.43 inch	

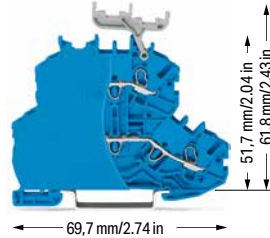

Double-deck terminal block; through/through terminal block; with end plate; with marker carrier; blue housing

	Item No.	Pack. Unit
● N/N	2000-2234/099-000	50

Double-deck terminal block; through/through terminal block; with end plate; without marker carrier; blue housing		
● N/N	2000-2204/099-000	50

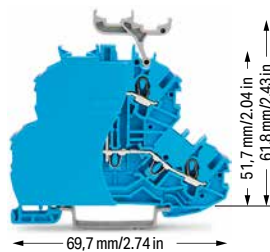

Technical Data	
0.14 ... 1 (1.5) mm ² ①	24 ... 16 AWG
800 V/8 kV/3 ②	600 V, 10 A ③
I _N 13.5 A (16 A)	
Terminal block width: 4.2 mm / 0.165 inch	
9 ... 11 mm / 0.35 ... 0.43 inch	

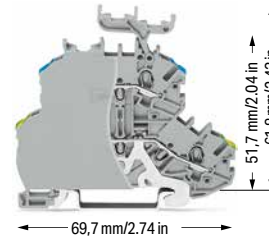

Double-deck terminal block; ground conductor/through terminal block; with end plate; with marker carrier; gray housing

	Item No.	Pack. Unit
○ PE/N	2000-2247/099-000	50
○ PE/L	2000-2257/099-000	50

Double-deck terminal block; ground conductor/through terminal block; with end plate; without marker carrier; gray housing		
○ PE/N	2000-2217/099-000	50
○ PE/L	2000-2227/099-000	50

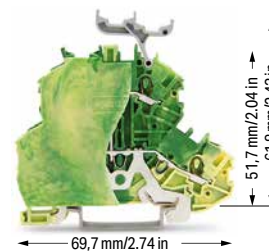

Double-deck terminal block; 4-conductor through terminal block; with end plate; with marker carrier; internally commoned; violet conductor entry; gray housing		
	Item No.	Pack. Unit
○ L	2000-2238/099-000	50

Double-deck terminal block; 4-conductor through terminal block; with end plate; without marker carrier; internally commoned; violet conductor entry; gray housing		
○ L	2000-2208/099-000	50

Double-deck terminal block; 4-conductor through terminal block; with end plate; with marker carrier; internally commoned; violet conductor entry; blue housing		
	Item No.	Pack. Unit
● N	2000-2239/099-000	50

Double-deck terminal block; 4-conductor through terminal block; with end plate; without marker carrier; internally commoned; violet conductor entry; blue housing		
● N	2000-2209/099-000	50

Double-deck terminal block; 4-conductor ground terminal block; with end plate; with marker carrier; internally commoned; green-yellow housing		
	Item No.	Pack. Unit
● PE	2000-2237/099-000	50

Double-deck terminal block; 4-conductor ground terminal block; with end plate; without marker carrier; internally commoned; green-yellow housing		
● PE	2000-2207/099-000	50

Technical Data	
0.14 ... 1 (1.5) mm ² ①	24 ... 16 AWG
800 V/8 kV/3 ②	600 V, 10 A ③
I _N 13.5 A (16 A)	
Terminal block width: 4.2 mm / 0.165 inch	
9 ... 11 mm / 0.35 ... 0.43 inch	

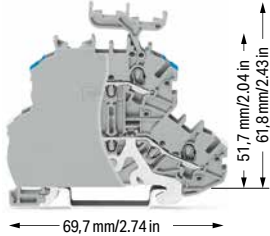

Double-deck terminal block; shield/through terminal block; with end plate; with marker carrier; gray housing

	Item No.	Pack. Unit
○ Shield/N	2000-2248/099-000	50
○ Shield/L	2000-2258/099-000	50

Double-deck terminal block; shield/through terminal block; with end plate; without marker carrier; gray housing

	Item No.	Pack. Unit
○ Shield/N	2000-2218/099-000	50
○ Shield/L	2000-2228/099-000	50

① Conductor range: 0.14 ... 1.5 mm² "s+f-st"; Push-in termination: 0.5 ... 1.5 mm² "s" and 0.5 ... 0.75 mm² "insulated ferrules; 12 mm" Depending on the conductor characteristic, a conductor with a smaller cross section can also be inserted via push-in termination.

② 800 V = rated voltage
8 kV = rated impulse voltage
3 = pollution degree
(see Section 14)

Please observe the application notes:
Jumpers, from page 157
Testing accessories, from page 151
Marking, from page 588

Approvals and corresponding ratings, visit www.wago.com

Accessories; 2000 Series

Appropriate marking systems:
WMB/WMB Inline/Marking strips

End and intermediate plate; 0.7 mm thick

orange	2000-2292	25
gray	2000-2291	25

Push-in type jumper bar; insulated; I_N 18 A; light gray

2-way	2001-402	25
3-way	2001-403	25
4-way	2001-404	25
5-way	2001-405	25
6-way	2001-406	25
7-way	2001-407	25
8-way	2001-408	25
9-way	2001-409	25
10-way	2001-410	25

Push-in type jumper bar; insulated; I_N 18 A; light gray

1 to 3	2001-433	25
1 to 4	2001-434	25
1 to 5	2001-435	25
1 to 6	2001-436	25
1 to 7	2001-437	25
1 to 8	2001-438	25
1 to 9	2001-439	25
1 to 10	2001-440	25

Double-deck vertical jumper; insulated; I_N 13.5 A

light gray	2000-492	100 (25)
------------	----------	----------

Protective warning marker; with black high-voltage symbol; for 5 terminal blocks

yellow	2001-115	100 (25)
--------	----------	----------

Test plug adapter; for 4 mm Ø test plug

gray	2009-174	100 (25)
------	----------	----------

Banana plug; for 4 mm socket diameter; color mixed; 10 x orange, white, black, blue, yellow; max. 42 V

	215-111	50
--	---------	----

Testing tap; for max. 2.5 mm²

gray	2009-182	100 (25)
------	----------	----------

Accessories; 2000 Series

Appropriate marking systems:
WMB/WMB Inline/Marking strips

WMB Inline; plain; 2,000 WMB markers (4 mm)/reel; 4 ... 4.2 mm stretchable

white	2009-114	1
-------	----------	---

WMB marking card; white; 10 strips with 10 markers/card; 4 ... 4.2 mm stretchable

plain	793-4501	5
-------	----------	---

WMB marking card; plain; 10 strips with 10 markers/card; 4 ... 4.2 mm stretchable

yellow	793-4501/000-002	5
red	793-4501/000-005	5
blue	793-4501/000-006	5
gray	793-4501/000-007	5
orange	793-4501/000-012	5
light green	793-4501/000-017	5
green	793-4501/000-023	5
violet	793-4501/000-024	5

Marking strip; plain; 11 mm wide; 50 m reel

white	2009-110	1
-------	----------	---

Double-deck marker carrier; pivoting

gray	2000-121	50 (25)
------	----------	---------



Double-deck terminal blocks:
A double-deck marker carrier (2000-121) can be retrofitted to double-deck terminal blocks without a marker carrier.

Double-Deck Terminal Block TOPJOB® S

2.5 (4) mm²; 2002 Series

1

Technical Data	
0.25 ... 2.5 (4) mm ² ①	22 ... 12 AWG
500 V/6 kV/3 ②	600 V, 20 A ③
I _N 24 A (28 A)	600 V, 20 A ④
Terminal block width: 5.2 mm / 0.205 inch	
10 ... 12 mm / 0.39 ... 0.47 inch	

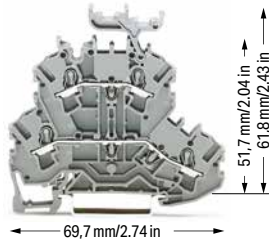

Double-deck terminal block; through/through terminal block; with marker carrier; gray housing		
	Item No.	Pack. Unit
○ L/L ⑤	2002-2231 ④	50
○ N/L ⑤	2002-2232 ④	50
○ L/N ⑤	2002-2233 ④	50

Technical Data	
0.25 ... 2.5 (4) mm ² ①	22 ... 12 AWG
500 V/6 kV/3 ②	600 V, 20 A ③
I _N 24 A (28 A)	600 V, 20 A ④
Terminal block width: 5.2 mm / 0.205 inch	
10 ... 12 mm / 0.39 ... 0.47 inch	

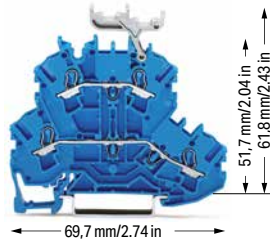

Double-deck terminal block; through/through terminal block; with marker carrier; blue housing		
	Item No.	Pack. Unit
● N/N ⑤	2002-2234 ③ ④	50

Technical Data	
0.25 ... 2.5 (4) mm ² ①	22 ... 12 AWG
500 V/6 kV/3 ②	600 V, 20 A ③
I _N 24 A (28 A)	600 V, 20 A ④
Terminal block width: 5.2 mm / 0.205 inch	
10 ... 12 mm / 0.39 ... 0.47 inch	

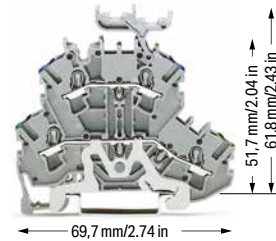

Double-deck terminal block; ground conductor/through terminal block; with marker carrier; blue housing		
	Item No.	Pack. Unit
○ PE/N ⑤	2002-2247 ④	50
○ PE/L ⑤	2002-2257 ④	50

Double-deck terminal block; through/through terminal block; without marker carrier; gray housing		
	Item No.	Pack. Unit
○ L/L ⑤	2002-2201 ④	50
○ N/L ⑤	2002-2202 ④	50
○ L/N ⑤	2002-2203 ④	50

Double-deck terminal block; through/through terminal block; without marker carrier; blue housing		
	Item No.	Pack. Unit
● N/N ⑤	2002-2204 ③ ④	50

Double-deck terminal block; ground conductor/through terminal block; without marker carrier; gray housing		
	Item No.	Pack. Unit
○ PE/N ⑤	2002-2217 ④	50
○ PE/L ⑤	2002-2227 ④	50

Other terminal blocks with the same profile:		
Diode	2002-2211/1000-410	Page 134
LED	2002-2221/1000-434	Page 134

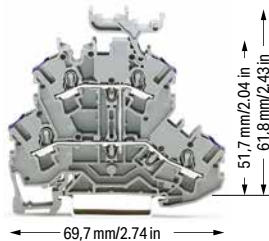

Double-deck terminal block; 4-conductor through terminal block; with marker carrier; internally commoned; violet conductor entry; gray housing		
	Item No.	Pack. Unit
○ L ⑤	2002-2238 ④	50

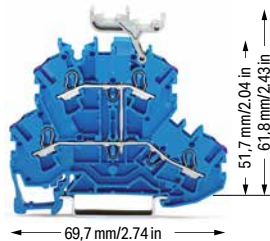

Double-deck terminal block; 4-conductor through terminal block; with marker carrier; internally commoned; violet conductor entry; blue housing		
	Item No.	Pack. Unit
● N ⑤	2002-2239 ③ ④	50

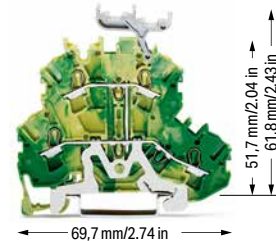

Double-deck terminal block; 4-conductor ground terminal block; with marker carrier; internally commoned; green-yellow housing		
	Item No.	Pack. Unit
● PE ⑤	2002-2237 ④	50

Double-deck terminal block; 4-conductor through terminal block; without marker carrier; internally commoned; violet conductor entry; gray housing		
	Item No.	Pack. Unit
○ L ⑤	2002-2208 ④	50

Double-deck terminal block; 4-conductor through terminal block; without marker carrier; internally commoned; violet conductor entry; blue housing		
	Item No.	Pack. Unit
● N ⑤	2002-2209 ③ ④	50

Double-deck terminal block; 4-conductor ground terminal block; without marker carrier; internally commoned; green-yellow housing		
	Item No.	Pack. Unit
● PE ⑤	2002-2207 ④	50

Technical Data

0.25 ... 2.5 (4) mm ² ①	22 ... 12 AWG
500 V/6 kV/3 ②	600 V, 20 A ③
I _N 24 A (28 A)	600 V, 20 A ④
Terminal block width: 5.2 mm / 0.205 inch	
10 ... 12 mm / 0.39 ... 0.47 inch	

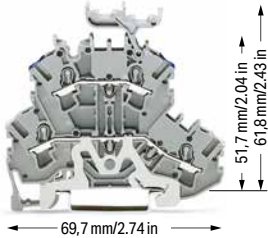

Double-deck terminal block; shield/through terminal block; with marker carrier; gray housing

	Item No.	Pack. Unit
○ Shield/N	2002-2248	50
○ Shield/L	2002-2258	50

Double-deck terminal block; shield/through terminal block; without marker carrier; gray housing

○ Shield/N	2002-2218	50
○ Shield/L	2002-2228	50

- Conductor range: 0.25 ... 4 mm² "s+f-st"; Push-in termination: 1 ... 4 mm² "s" and 1 ... 2.5 mm² "insulated ferrules, 12 mm" Depending on the conductor characteristic, a conductor with a smaller cross section can also be inserted via push-in termination.
- 500 V = rated voltage
6 kV = rated impulse voltage
3 = pollution degree (see Section 14)
- Terminal blocks with a blue insulated housing are suitable for Ex i applications.
- Terminal blocks with an Ex mark are suitable for Ex e II applications.
440 V; 20 A
18 A jumper (see Section 14)

Please observe the application notes:
Jumpers, from page 157
Testing accessories, from page 151
Marking, from page 588

Approvals and corresponding ratings, visit www.wago.com

Accessories; 2002 Series

Appropriate marking systems:
WMB/WMB Inline/Marking strips

End and intermediate plate; 0.8 mm thick

orange	2002-2292	100 (25)
gray	2002-2291	100 (25)

Ex e/Ex i separator; orange; 3 mm thick

125.5 mm	209-192	50 (25)
----------	---------	---------

Separator plate; oversized upper deck; snap-on type; 2 mm thick

orange	2002-2296	100 (25)
gray	2002-2295	100 (25)

Insulation stop; 5 pcs/strip; 0.25 ... 0.5 mm²

light gray	2002-171	200 (25)
------------	----------	----------

Insulation stop; 5 pcs/strip; 0.75 ... 1 mm²

dark gray	2002-172	200 (25)
-----------	----------	----------

Push-in type jumper bar; insulated; I_N 25 A; light gray

2-way	2002-402	25
3-way	2002-403	25
4-way	2002-404	25
5-way	2002-405	25
6-way	2002-406	25
7-way	2002-407	25
8-way	2002-408	25
9-way	2002-409	25
10-way	2002-410	25

Push-in type jumper bar; insulated; I_N 25 A; light gray

1 to 3	2002-433	25
1 to 4	2002-434	25
1 to 5	2002-435	25
1 to 6	2002-436	25
1 to 7	2002-437	25
1 to 8	2002-438	25
1 to 9	2002-439	25
1 to 10	2002-440	25

Accessories; 2002 Series

Appropriate marking systems:
WMB/WMB Inline/Marking strips

Double-deck vertical jumper; insulated; I_N 24 A

light gray	2002-492	100 (25)
orange	2002-492/000-012	100 (25)

Double-deck marker carrier; pivoting

gray	2002-121	50 (25)
------	----------	---------

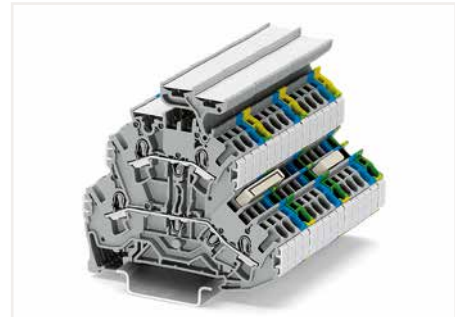

Double-deck terminal block assembly



Both ground and shield conductor terminal blocks have a contact foot in the bottom level, automatically establishing direct contact to the DIN-rail or busbar. The flexible double-deck marker carrier, which is placed above the wiring level, can be pushed aside during wiring. The carrier has two staggered levels for WMB markers that perfectly align with the terminal block decks. With a terminal block width of just 5.2 mm, an effective width of just 2.6 mm for terminal blocks of same or different potentials can be realized for conductors ranging 0.25 mm² ... 4 mm² (22 ... 12 AWG). Shielded control cables are becoming an increasingly common solution to external signal interference. Front-entry shield conductor terminal blocks are ideal for connecting braided cables. Like front-entry ground conductor terminal blocks, they are equipped with a grounding foot for direct electrical connection to the rail, however they differ significantly by their white insulated housing. Shield conductor terminal blocks for front-entry wiring can be directly mounted beside signal-conductor terminal blocks, providing excellent deflection of interfering signals.

Double-Deck Terminal Block TOPJOB® S; with End Plate; 800 V 2.5 (4) mm²; 2002 Series

1

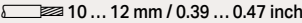
Technical Data	
0.25 ... 2.5 (4) mm ² ①	22 ... 12 AWG
800 V/8 kV/3 ②	600 V, 20 A ③
I _N 24 A	600 V, 20 A ④
Terminal block width: 6.2 mm / 0.244 inch	
 10 ... 12 mm / 0.39 ... 0.47 inch	

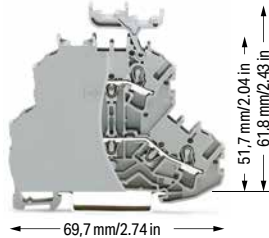

Double-deck terminal block; through/through terminal block; with end plate; with marker carrier; gray housing

	Item No.	Pack. Unit
<input type="radio"/> L/L	2002-2231/099-000	50
<input type="radio"/> N/L	2002-2232/099-000	50
<input type="radio"/> L/N	2002-2233/099-000	50

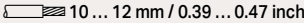
Technical Data	
0.25 ... 2.5 (4) mm ² ①	22 ... 12 AWG
800 V/8 kV/3 ②	600 V, 20 A ③
I _N 24 A	600 V, 20 A ④
Terminal block width: 6.2 mm / 0.244 inch	
 10 ... 12 mm / 0.39 ... 0.47 inch	

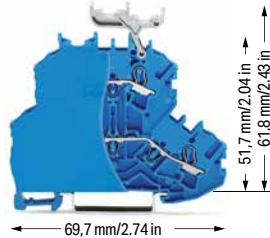

Double-deck terminal block; through/through terminal block; with end plate; with marker carrier; blue housing

	Item No.	Pack. Unit
<input checked="" type="radio"/> N/N	2002-2234/099-000 ⑤	50

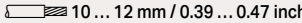
Technical Data	
0.25 ... 2.5 (4) mm ² ①	22 ... 12 AWG
800 V/8 kV/3 ②	600 V, 20 A ③
I _N 24 A	600 V, 20 A ④
Terminal block width: 6.2 mm / 0.244 inch	
 10 ... 12 mm / 0.39 ... 0.47 inch	

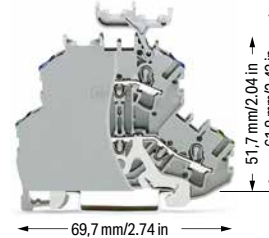

Double-deck terminal block; ground conductor/through terminal block; with end plate; with marker carrier; gray housing

	Item No.	Pack. Unit
<input type="radio"/> PE/N	2002-2247/099-000	50
<input type="radio"/> PE/L	2002-2257/099-000	50

Double-deck terminal block; through/through terminal block; with end plate; without marker carrier; gray housing		
<input type="radio"/> L/L	2002-2201/099-000	50
<input type="radio"/> N/L	2002-2202/099-000	50
<input type="radio"/> L/N	2002-2203/099-000	50

Double-deck terminal block; through/through terminal block; with end plate; without marker carrier; blue housing		
<input checked="" type="radio"/> N/N	2002-2204/099-000 ⑥	50

Double-deck terminal block; ground conductor/through terminal block; with end plate; without marker carrier; gray housing		
<input type="radio"/> PE/N	2002-2217/099-000	50
<input type="radio"/> PE/L	2002-2227/099-000	50

Other terminal blocks with the same profile:		
Diode	2002-2211/1000-410	Page 134
LED	2002-2221/1000-434	Page 134

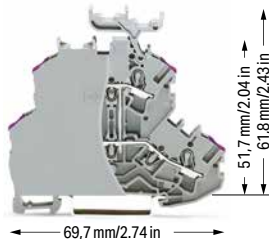

Double-deck terminal block; 4-conductor through terminal block; with end plate; with marker carrier; internally commoned; violet conductor entry; gray housing

	Item No.	Pack. Unit
<input type="radio"/> L	2002-2238/099-000	50

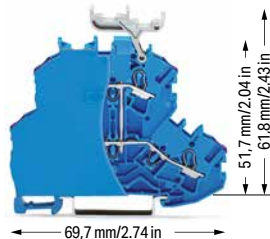

Double-deck terminal block; 4-conductor through terminal block; with end plate; with marker carrier; internally commoned; violet conductor entry; blue housing

	Item No.	Pack. Unit
<input checked="" type="radio"/> N	2002-2239/099-000 ⑦	50

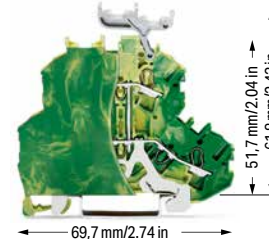

Double-deck terminal block; 4-conductor ground terminal block; with end plate; with marker carrier; internally commoned; green-yellow housing

	Item No.	Pack. Unit
<input checked="" type="radio"/> PE	2002-2237/099-000	50

Double-deck terminal block; 4-conductor through terminal block; with end plate; without marker carrier; internally commoned; violet conductor entry; gray housing		
<input type="radio"/> L	2002-2208/099-000	50

Double-deck terminal block; 4-conductor through terminal block; with end plate; without marker carrier; internally commoned; violet conductor entry; blue housing		
<input checked="" type="radio"/> N	2002-2209/099-000 ⑧	50

Double-deck terminal block; 4-conductor ground terminal block; with end plate; without marker carrier; internally commoned; green-yellow housing		
<input checked="" type="radio"/> PE	2002-2207/099-000	50

Technical Data

0.25 ... 2.5 (4) mm ² ①	22 ... 12 AWG
800 V/8 kV/3 ②	600 V, 20 A ③
I _N 24 A	600 V, 20 A ④
Terminal block width: 6.2 mm / 0.244 inch	
10 ... 12 mm / 0.39 ... 0.47 inch	

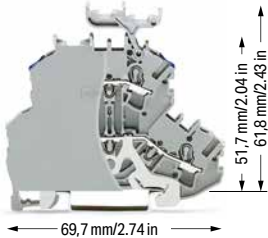

Double-deck terminal block; shield/through terminal block; with end plate; with marker carrier; gray housing

	Item No.	Pack. Unit
○ Shield/N	2002-2248/099-000	50
○ Shield/L	2002-2258/099-000	50

Double-deck terminal block; shield/through terminal block; with end plate; without marker carrier; gray housing

○ Shield/N	2002-2218/099-000	50
○ Shield/L	2002-2228/099-000	50

① Conductor range: 0.25 ... 4 mm² "s+f-st"; Push-in termination: 1 ... 4 mm² "s" and 1 ... 2.5 mm² "insulated ferrules, 12 mm" Depending on the conductor characteristic, a conductor with a smaller cross section can also be inserted via push-in termination.

② 800 V = rated voltage
8 kV = rated impulse voltage
3 = pollution degree (see Section 14)

③ Terminal blocks with a blue insulated housing are suitable for Ex i applications.

Please observe the application notes:
Jumpers, from page 157
Testing accessories, from page 151
Marking, from page 588

A protective warning marker and an insulation stop must be applied individually. Due to the 6.2 mm width of double-deck terminal blocks with end plates, 2004 Series Push-In Type Jumper Bars must be used.

Approvals and corresponding ratings, visit www.wago.com

Accessories; 2002 Series

Appropriate marking systems:
WMB/Marking strips

End and intermediate plate; 0.8 mm thick

 orange	2002-2292	100 (25)
 gray	2002-2291	100 (25)

Insulation stop; 5 pcs/strip; 0.25 ... 0.5 mm²

 light gray	2002-171	200 (25)
--	----------	----------

Insulation stop; 5 pcs/strip; 0.75 ... 1 mm²

 dark gray	2002-172	200 (25)
---	----------	----------

Push-in type jumper bar; insulated; I_N 32 A; light gray

 2-way	2004-402	25
3-way	2004-403	25
4-way	2004-404	25
5-way	2004-405	25
6-way	2004-406	25
7-way	2004-407	25
8-way	2004-408	25
9-way	2004-409	25
10-way	2004-410	25

Push-in type jumper bar; insulated; I_N 32 A; light gray

 1 to 3	2004-433	25
1 to 4	2004-434	25
1 to 5	2004-435	25
1 to 6	2004-436	25
1 to 7	2004-437	25
1 to 8	2004-438	25
1 to 9	2004-439	25
1 to 10	2004-440	25

Double-deck vertical jumper; insulated; I_N 24 A

 light gray	2002-492	100 (25)
orange	2002-492/000-012	100 (25)

Protective warning marker; with black high-voltage symbol; for 5 terminal blocks

 yellow	2002-115	100 (25)
--	----------	----------

Accessories; 2002 Series

Appropriate marking systems:
WMB/Marking strips

Test plug adapter; for 4 mm Ø test plug

 gray	2009-174	100 (25)
--	----------	----------

Banana plug; for 4 mm socket diameter; color mixed; 10 x orange, white, black, blue, yellow; max. 42 V

 215-111	50
---	----

WMB marking card; white; 10 strips with 10 markers/card; 5 ... 5.2 mm stretchable

 plain	793-5501	5
---	----------	---

WMB marking card; plain; 10 strips with 10 markers/card; 5 ... 5.2 mm stretchable

 yellow	793-5501/000-002	5
red	793-5501/000-005	5
blue	793-5501/000-006	5
gray	793-5501/000-007	5
orange	793-5501/000-012	5
light green	793-5501/000-017	5
green	793-5501/000-023	5
violet	793-5501/000-024	5

Marking strip; plain; 11 mm wide; 50 m reel

 white	2009-110	1
---	----------	---

Double-deck marker carrier; pivoting

 gray	2002-121	50 (25)
--	----------	---------

Double-Deck Terminal Block TOPJOB® S

2.5 (4) mm²; 2002 Series

1

Technical Data	
0.25 ... 2.5 (4) mm ² ①	22 ... 12 AWG
1000 VAC/DC / 1500 VDC / 12 kV / 3 ②	
I _N 24 A	
Terminal block width: 7.2 mm / 0.283 inch	
 10 ... 12 mm / 0.39 ... 0.47 inch	

Technical Data	
0.25 ... 2.5 (4) mm ² ①	22 ... 12 AWG
1000 VAC/DC / 1500 VDC / 12 kV / 3 ②	
I _N 24 A	
Terminal block width: 7.2 mm / 0.283 inch	
 10 ... 12 mm / 0.39 ... 0.47 inch	

- ① Conductor range: 0.25 ... 4 mm² "s+f-st"; Push-in termination: 1 ... 4 mm² "s" and 1 ... 2.5 mm² "insulated ferrules, 12 mm"
Depending on the conductor characteristic, a conductor with a smaller cross section can also be inserted via push-in termination.
- ② 1000 VAC/DC = rated voltage
1500 VDC
12 kV = rated impulse voltage
3 = pollution degree
(see Section 14)

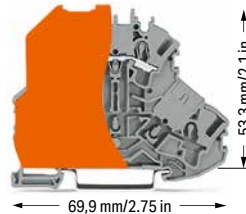
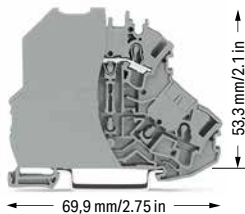

Please observe the application notes:
Testing accessories, from page 151
Marking, from page 588

A protective warning marker and an insulation stop must be applied individually.

Approvals and corresponding ratings, visit www.wago.com

Double-deck terminal block; contact insert only on upper deck; gray separator plate; oversized; gray housing		
	Item No.	Pack. Unit
○ L	2002-2201/097-000	50

Double-deck terminal block; contact insert only on upper deck; orange separator plate; oversized; gray housing		
	Item No.	Pack. Unit
○ L	2002-2201/098-000	50

Accessories; 2002 Series

Appropriate marking systems: WMB/Marking strips

Insulation stop; 5 pcs/strip; 0.25 ... 0.5 mm ²		
light gray	2002-171	200 (25)



Insulation stop; 5 pcs/strip; 0.75 ... 1 mm ²		
dark gray	2002-172	200 (25)



Protective warning marker; with black high-voltage symbol; for 5 terminal blocks		
yellow	2002-115	100 (25)



Test plug adapter; for 4 mm Ø test plug		
gray	2009-174	100 (25)



Banana plug; for 4 mm socket diameter; color mixed; 10 x orange, white, black, blue, yellow; max. 42 V		
	215-111	50



Testing tap; for max. 2.5 mm ²		
gray	2009-182	100 (25)



WMB marking card; white; 10 strips with 10 markers/card; 5 ... 5.2 mm stretchable		
plain	793-5501	5



WMB marking card; plain; 10 strips with 10 markers/card; 5 ... 5.2 mm stretchable		
yellow	793-5501/000-002	5
red	793-5501/000-005	5
blue	793-5501/000-006	5
gray	793-5501/000-007	5
orange	793-5501/000-012	5
light green	793-5501/000-017	5
green	793-5501/000-023	5
violet	793-5501/000-024	5



Marking strip; plain; 11 mm wide; 50 m reel		
white	2009-110	1



Double-deck marker carrier; pivoting		
gray	2002-121	50 (25)



Double-Deck Terminal Block TOPJOB® S; with Vertical Conductor Entry 2.5 (4) mm²; 2002 Series

Technical Data	
0.25 ... 2.5 (4) mm ² ①	22 ... 12 AWG
800 V/8 kV/3 ②	
I _N 24 A (28 A)	
Terminal block width: 5.2 mm / 0.205 inch	
 10 ... 12 mm / 0.39 ... 0.47 inch	

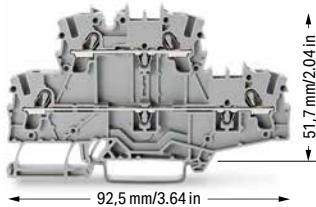

Double-deck terminal block; through/through terminal block; with vertical conductor entry; without marker carrier; gray housing

	Item No.	Pack. Unit
○ L/L ③	2002-2701 ④	50
○ N/L ③	2002-2702 ④	50
○ L/N ③	2002-2703 ④	50

Double-deck terminal block; through/through terminal block; with vertical conductor entry; without marker carrier; blue housing

● N/N ③	2002-2704 ③ ④	50
---------	---------------	----

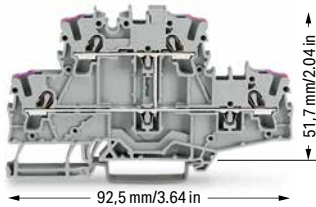

Double-deck terminal block; 4-conductor through terminal block; with vertical conductor entry; without marker carrier; internally commoned; violet conductor entry; gray housing

	Item No.	Pack. Unit
○ L ③	2002-2708 ④	50

Double-deck terminal block; 4-conductor through terminal block; with vertical conductor entry; without marker carrier; internally commoned; violet conductor entry; blue housing

● N ③	2002-2709 ③ ④	50
-------	---------------	----

Technical Data	
0.25 ... 2.5 (4) mm ² ①	22 ... 12 AWG
800 V/8 kV/3 ②	
I _N 24 A (28 A)	
Terminal block width: 5.2 mm / 0.205 inch	
 10 ... 12 mm / 0.39 ... 0.47 inch	

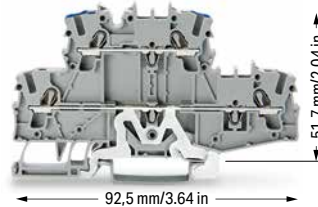

Double-deck terminal block; ground conductor/through terminal block; with vertical conductor entry; without marker carrier; gray housing

	Item No.	Pack. Unit
○ PE/N ③	2002-2717 ④	50
○ PE/L ③	2002-2727 ④	50

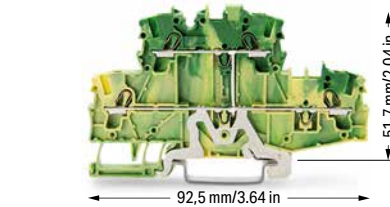

Double-deck terminal block; 4-conductor ground terminal block; with vertical conductor entry; without marker carrier; internally commoned; green-yellow housing

	Item No.	Pack. Unit
● PE	2002-2707	50
● PE ③	2002-2707/999-950 ④	50

- ① Conductor range: 0.25 ... 4 mm² "s+f-st"; Push-in termination: 1 ... 4 mm² "s" and 1 ... 2.5 mm² "insulated ferrules, 12 mm"
Depending on the conductor characteristic, a conductor with a smaller cross section can also be inserted via push-in termination.
- ② 800 V = rated voltage
8 kV = rated impulse voltage
3 = pollution degree
(see Section 14)
- ③ Terminal blocks with a blue insulated housing are suitable for Ex i applications.
- ④ Terminal blocks with an Ex mark are suitable for Ex e II applications.
440 V; 20 A
18 A jumper
(see Section 14)



Please observe the application notes:
Jumpers, from page 157
Testing accessories, from page 151
Marking, from page 588

Approvals and corresponding ratings, visit www.wago.com

Accessories; 2002 Series

Appropriate marking systems:
WMB/WMB Inline/Marking strips

End and intermediate plate; 0.8 mm thick

 orange	2002-2792	100 (25)
 gray	2002-2791	100 (25)

Double-deck marker carrier; pivoting

 gray	2002-121	50 (25)
--	----------	---------

Insulation stop; 5 pcs/strip; 0.25 ... 0.5 mm²

 light gray	2002-171	200 (25)
--	----------	----------

Insulation stop; 5 pcs/strip; 0.75 ... 1 mm²

 dark gray	2002-172	200 (25)
---	----------	----------

Push-in type jumper bar; insulated; I_N 25 A; light gray

 2-way	2002-402	25
3-way	2002-403	25
4-way	2002-404	25
5-way	2002-405	25
6-way	2002-406	25
7-way	2002-407	25
8-way	2002-408	25
9-way	2002-409	25
10-way	2002-410	25

Push-in type jumper bar; insulated; I_N 25 A; light gray

 1 to 3	2002-433	25
1 to 4	2002-434	25
1 to 5	2002-435	25
1 to 6	2002-436	25
1 to 7	2002-437	25
1 to 8	2002-438	25
1 to 9	2002-439	25
1 to 10	2002-440	25

Double-deck vertical jumper; insulated; I_N 24 A

 light gray	2002-492	100 (25)
orange	2002-492/000-012	100 (25)

4-Conductor Double-Deck Terminal Block TOPJOB® S

2.5 (4) mm²; 2002 Series

1

Technical Data	
0.25 ... 2.5 (4) mm ² ①	22 ... 12 AWG
800 V/8 kV/3 ②	600 V, 20 A ③
I _N 24 A (28 A)	600 V, 20 A ④
Terminal block width: 5.2 mm / 0.205 inch	
 10 ... 12 mm / 0.39 ... 0.47 inch	

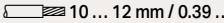
Technical Data	
0.25 ... 2.5 (4) mm ² ①	22 ... 12 AWG
800 V/8 kV/3 ②	600 V, 20 A ③
I _N 24 A (28 A)	600 V, 20 A ④
Terminal block width: 5.2 mm / 0.205 inch	
 10 ... 12 mm / 0.39 ... 0.47 inch	

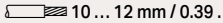
Technical Data	
0.25 ... 2.5 (4) mm ² ①	22 ... 12 AWG
800 V/8 kV/3 ②	600 V, 20 A ③
I _N 24 A (28 A)	600 V, 20 A ④
Terminal block width: 5.2 mm / 0.205 inch	
 10 ... 12 mm / 0.39 ... 0.47 inch	

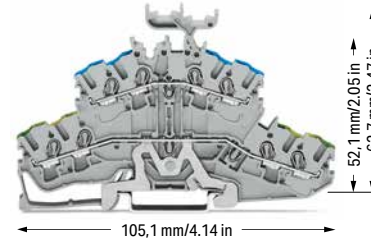
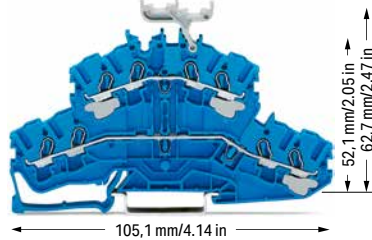
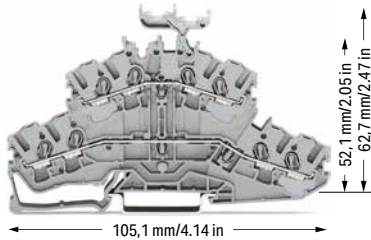

4-conductor double-deck terminal block; through/through terminal block; with marker carrier; gray housing

	Item No.	Pack. Unit
<input type="radio"/> L/L ⑤	2002-2431 ④	50
<input type="radio"/> N/L ⑤	2002-2432 ④	50
<input type="radio"/> L/N ⑤	2002-2433 ④	50

4-conductor double-deck terminal block; through/through terminal block; with marker carrier; blue housing

	Item No.	Pack. Unit
<input checked="" type="radio"/> N/N ⑤	2002-2434 ③ ④	50

4-conductor double-deck terminal block; ground conductor/through terminal block; with marker carrier; gray housing

	Item No.	Pack. Unit
<input type="radio"/> PE/N ⑤	2002-2447 ④	50
<input type="radio"/> PE/L ⑤	2002-2457 ④	50

4-conductor double-deck terminal block; through/through terminal block; without marker carrier; gray housing

<input type="radio"/> L/L ⑤	2002-2401 ④	50
<input type="radio"/> N/L ⑤	2002-2402 ④	50
<input type="radio"/> L/N ⑤	2002-2403 ④	50

4-conductor double-deck terminal block; through/through terminal block; without marker carrier; blue housing

<input checked="" type="radio"/> N/N ⑤	2002-2404 ③ ④	50
--	---------------	----

4-conductor double-deck terminal block; ground conductor/through terminal block; without marker carrier; gray housing

<input type="radio"/> PE/N ⑤	2002-2417 ④	50
<input type="radio"/> PE/L ⑤	2002-2427 ④	50

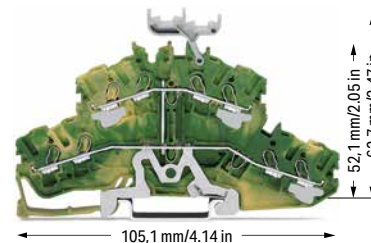
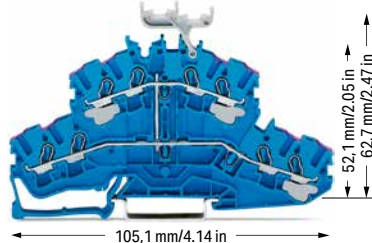
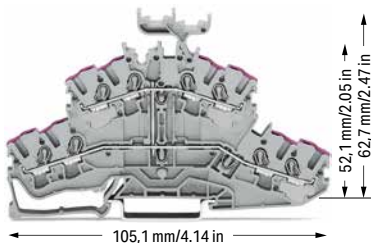

4-conductor double-deck terminal block; 8-conductor through terminal block; with marker carrier; internally commoned; violet conductor entry; gray housing

	Item No.	Pack. Unit
<input type="radio"/> L ⑤	2002-2438 ④	50

4-conductor double-deck terminal block; 8-conductor through terminal block; with marker carrier; internally commoned; violet conductor entry; blue housing

	Item No.	Pack. Unit
<input checked="" type="radio"/> N ⑤	2002-2439 ③ ④	50

4-conductor double-deck terminal block; 8-conductor ground terminal block; with marker carrier; internally commoned; green-yellow housing

	Item No.	Pack. Unit
<input checked="" type="radio"/> PE ⑤	2002-2437 ④	50

4-conductor double-deck terminal block; 8-conductor through terminal block; without marker carrier; internally commoned; violet conductor entry; gray housing

<input type="radio"/> L ⑤	2002-2408 ④	50
---------------------------	-------------	----

4-conductor double-deck terminal block; 8-conductor through terminal block; without marker carrier; internally commoned; violet conductor entry; blue housing

<input checked="" type="radio"/> N ⑤	2002-2409 ③ ④	50
--------------------------------------	---------------	----

4-conductor double-deck terminal block; 8-conductor ground terminal block; without marker carrier; internally commoned; green-yellow housing

<input checked="" type="radio"/> PE ⑤	2002-2407 ④	50
---------------------------------------	-------------	----

Technical Data

0.25 ... 2.5 (4) mm² ①	22 ... 12 AWG
800 V/8 kV/3 ②	600 V, 20 A ③
I _N 24 A (28 A)	600 V, 20 A ④
Terminal block width: 5.2 mm / 0.205 inch	
10 ... 12 mm / 0.39 ... 0.47 inch	

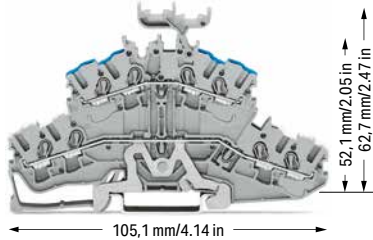

4-conductor double-deck terminal block; shield/through terminal block; with marker carrier; gray housing

	Item No.	Pack. Unit
○ Shield/N	2002-2448	50
○ Shield/L	2002-2458	50

4-conductor double-deck terminal block; shield/through terminal block; without marker carrier; gray housing

○ Shield/N	2002-2418	50
○ Shield/L	2002-2428	50

① Conductor range: 0.25 ... 4 mm² "s+f-st"; Push-in termination: 1 ... 4 mm² "s" and 1 ... 2.5 mm² "insulated ferrules, 12 mm"
Depending on the conductor characteristic, a conductor with a smaller cross section can also be inserted via push-in termination.

② 800 V = rated voltage
8 kV = rated impulse voltage
3 = pollution degree
(see Section 14)

③ Terminal blocks with a blue insulated housing are suitable for Ex i applications.

④ Terminal blocks with an Ex mark are suitable for Ex e ll applications.
550 V; 21 A
17 A jumper
16 A staggered jumper
(see Section 14)

Please observe the application notes:
Jumpers, from page 157
Testing accessories, from page 151
Marking, from page 588

Approvals and corresponding ratings, visit www.wago.com

Accessories; 2002 Series
Appropriate marking systems:
WMB/WMB Inline/Marking strips

End and intermediate plate; 0.8 mm thick

orange	2002-2492	100 (25)
gray	2002-2491	100 (25)

Insulation stop; 5 pcs/strip; 0.25 ... 0.5 mm²

light gray	2002-171	200 (25)
------------	----------	----------

Insulation stop; 5 pcs/strip; 0.75 ... 1 mm²

dark gray	2002-172	200 (25)
-----------	----------	----------

Push-in type jumper bar; insulated; I_N 25 A; light gray

2-way	2002-402	25
3-way	2002-403	25
4-way	2002-404	25
5-way	2002-405	25
6-way	2002-406	25
7-way	2002-407	25
8-way	2002-408	25
9-way	2002-409	25
10-way	2002-410	25

Push-in type jumper bar; insulated; I_N 25 A; light gray

1 to 3	2002-433	25
1 to 4	2002-434	25
1 to 5	2002-435	25
1 to 6	2002-436	25
1 to 7	2002-437	25
1 to 8	2002-438	25
1 to 9	2002-439	25
1 to 10	2002-440	25

Double-deck vertical jumper; insulated; I_N 24 A

light gray	2002-492	100 (25)
orange	2002-492/000-012	100 (25)

Adjacent jumper for continuous commoning; insulated; I_N 25 A, light gray

2-way	2002-400	25
-------	----------	----

Accessories; 2002 Series
Appropriate marking systems:
WMB/WMB Inline/Marking strips

Adjacent jumper for continuous commoning; insulated; I_N 25 A; 1 to 3

light gray	2002-423	25
red	2002-423/000-005	25
blue	2002-423/000-006	25

Protective warning marker; with black high-voltage symbol; for 5 terminal blocks

yellow	2002-115	100 (25)
--------	----------	----------

Test plug adapter; for 4 mm Ø test plug

gray	2009-174	100 (25)
------	----------	----------

Banana plug; for 4 mm socket diameter; color mixed; 10 x orange, white, black, blue, yellow; max. 42 V

	215-111	50
--	---------	----

Testing tap; for max. 2.5 mm²

gray	2009-182	100 (25)
------	----------	----------

WMB Inline, plain; 1,500 WMB markers (5 mm)/reel; 5 ... 5.2 mm stretchable

white	2009-115	1
-------	----------	---

Marking strip; plain; 11 mm wide; 50 m reel

white	2009-110	1
-------	----------	---

WMB marking card; white; 10 strips with 10 markers/card; 5 ... 5.2 mm stretchable

plain	793-5501	5
-------	----------	---

Double-deck marker carrier; pivoting

gray	2002-121	50 (25)
------	----------	---------

Group marker carrier; snap-on type for jumper slot; 5 mm wide

gray	2009-191	50 (25)
------	----------	---------

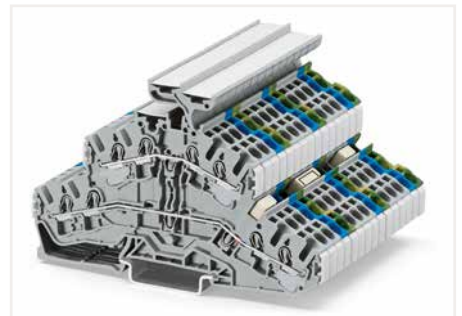

Double-deck terminal block assembly

Double-Deck Terminal Block TOPJOB® S

2.5 (4) mm²; 2002 Series

1

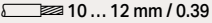
Technical Data	
0.25 ... 2.5 (4) mm ² ①	22 ... 12 AWG
500 V/6 kV/3 ②	300 V, 20 A ③
I _N 24 A (28 A)	
Terminal block width: 5.2 mm / 0.205 inch	
 10 ... 12 mm / 0.39 ... 0.47 inch	

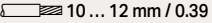
Technical Data	
0.25 ... 2.5 (4) mm ² ①	22 ... 12 AWG
500 V/6 kV/3 ②	300 V, 20 A ③
I _N 24 A (28 A)	
Terminal block width: 5.2 mm / 0.205 inch	
 10 ... 12 mm / 0.39 ... 0.47 inch	

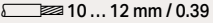
Technical Data	
0.25 ... 2.5 (4) mm ² ①	22 ... 12 AWG
500 V/6 kV/3 ②	300 V, 20 A ③
I _N 24 A (28 A)	
Terminal block width: 5.2 mm / 0.205 inch	
 10 ... 12 mm / 0.39 ... 0.47 inch	

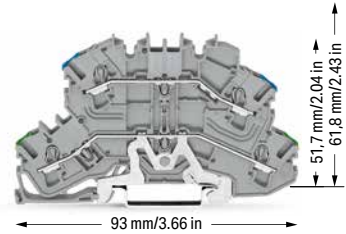
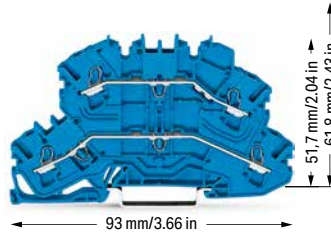
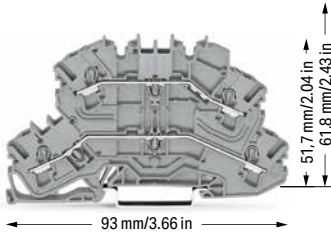

Double-deck terminal block; through/through terminal block; same profile as double-deck disconnect terminal block; without marker carrier; gray housing

	Item No.	Pack. Unit
○ L/L ④	2002-2601 ④	50
○ N/L ④	2002-2602 ④	50
○ L/N ④	2002-2603 ④	50

Double-deck terminal block; through/through terminal block; same profile as double-deck disconnect terminal block; without marker carrier; blue housing

	Item No.	Pack. Unit
● N/N ④	2002-2604 ③ ④	50

Double-deck terminal block; ground conductor/through terminal block; same profile as double-deck disconnect terminal block; without marker carrier; gray housing

	Item No.	Pack. Unit
○ PE/N ④	2002-2647 ④	50
○ PE/L ④	2002-2657 ④	50

Other terminal blocks with the same profile:

Carrier	2002-2661	Page 74
Disconnect	2002-2671	Page 74
Fuse	2002-2611	Page 75

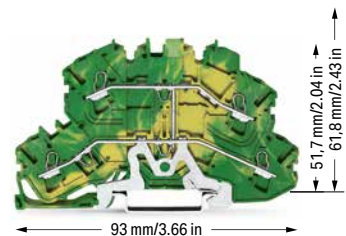
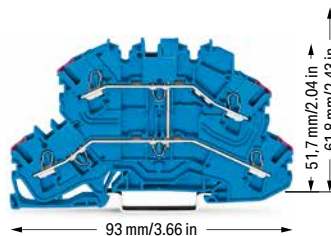
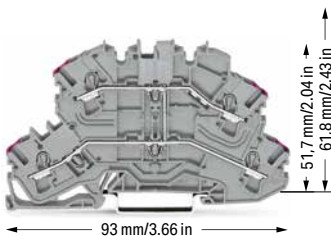

Double-deck terminal block; 4-conductor through terminal block; same profile as double-deck disconnect terminal block; without marker carrier; internally commoned; violet conductor entry; gray housing

	Item No.	Pack. Unit
○ L ④	2002-2608 ④	50

Double-deck terminal block; 4-conductor through terminal block; same profile as double-deck disconnect terminal block; without marker carrier; internally commoned; violet conductor entry; blue housing

	Item No.	Pack. Unit
● N ④	2002-2609 ③ ④	50

Double-deck terminal block; 4-conductor ground terminal block; same profile as double-deck disconnect terminal block; without marker carrier; internally commoned; green-yellow housing

	Item No.	Pack. Unit
● PE ④	2002-2607 ④	50

Sold & Serviced By:



Toll Free Phone (877) SERV098
www.electromate.com
sales@electromate.com

- ❶ Conductor range: 0.25 ... 4 mm² "s+f-st"; Push-in termination: 1 ... 4 mm² "s" and 1 ... 2.5 mm² "insulated ferrules, 12 mm"
Depending on the conductor characteristic, a conductor with a smaller cross section can also be inserted via push-in termination.
- ❷ 500 V = rated voltage
6 kV = rated impulse voltage
3 = pollution degree
(see Section 14)
- ❸ Terminal blocks with a blue insulated housing are suitable for Ex i applications.
- ❹ Terminal blocks with an Ex mark are suitable for Ex ec IIc applications.
(see Section 14)

Please observe the application notes:
Jumpers, from page 157
Testing accessories, from page 151
Marking, from page 588

Approvals and corresponding ratings,
visit www.wago.com

Accessories; 2002 Series

Appropriate marking systems:
WMB/WMB Inline/Marking strips

End and intermediate plate; 1 mm thick

	orange	2002-2692	100 (25)
	gray	2002-2691	100 (25)

Double-deck marker carrier; pivoting

	gray	2002-121	50 (25)
---	------	----------	---------

Insulation stop; 5 pcs/strip; 0.25 ... 0.5 mm²

	light gray	2002-171	200 (25)
---	------------	----------	----------

Insulation stop; 5 pcs/strip; 0.75 ... 1 mm²

	dark gray	2002-172	200 (25)
---	-----------	----------	----------

Push-in type jumper bar; insulated; I_n 25 A; light gray

	2-way	2002-402	25
	3-way	2002-403	25
	4-way	2002-404	25
	5-way	2002-405	25
	6-way	2002-406	25
	7-way	2002-407	25
	8-way	2002-408	25
	9-way	2002-409	25
	10-way	2002-410	25

Push-in type jumper bar; insulated; I_n 25 A; light gray

	1 to 3	2002-433	25
	1 to 4	2002-434	25
	1 to 5	2002-435	25
	1 to 6	2002-436	25
	1 to 7	2002-437	25
	1 to 8	2002-438	25
	1 to 9	2002-439	25
	1 to 10	2002-440	25

Double-deck vertical jumper; insulated; I_n 24 A

	light gray	2002-492	100 (25)
	orange	2002-492/000-012	100 (25)

Adjacent jumper for continuous commoning; insulated; I_n 25 A, light gray

	2-way	2002-400	25
---	-------	----------	----

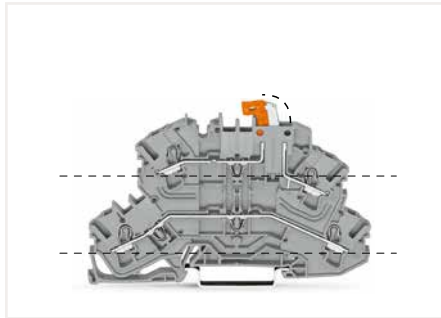

Double-deck disconnect terminal blocks with a pivoting knife disconnect (2002-2671) can be used as through terminal blocks on the lower deck and as disconnect terminal blocks on the upper deck.
Besides disconnection and measurement, double-deck carrier terminal blocks (2002-2667) also provide ground conductor functionality.

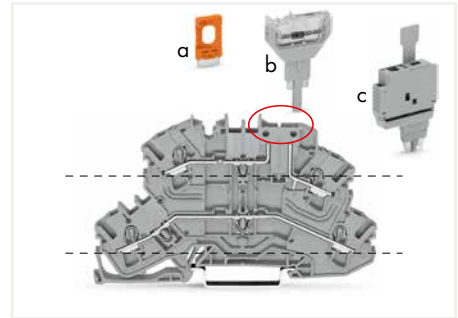

Carrier terminal blocks (2002-2661) have the same design as disconnect terminal blocks.
The following components may be used:
- Disconnect plugs (a: 2002-401)
- Pluggable diode (b: 2002-800/1000-411)
- LED module (2002-800/1000-541, no illustration)
- Fuse plug (c: 2004-911)



Double-deck fuse disconnect terminal blocks with a pivoting fuse holder (2002-2611, gray) are compatible with disconnect, carrier, through and ground conductor terminal blocks. The fuse holder is also available with a blown fuse LED indicator (e.g., 2002-2611/1000-541 for 12-30 V).



An end plate for fuse disconnect terminal blocks (shown in orange, 2002-1092) is used for additional protection, preventing the fuse holder from being opened. The fuse cannot be replaced until disconnecting the fuse holder from the power supply.

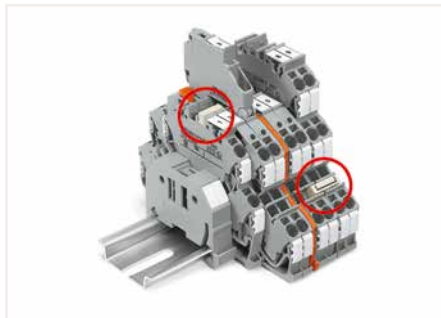

The same profile allows for commoning with double-deck terminal blocks (upper deck) and with triple-deck terminal blocks (lower deck).

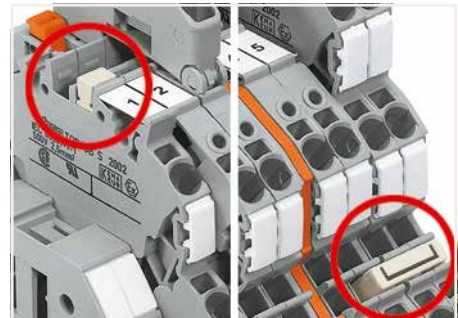

Left picture – Vertical jumper (2002-492)
Right picture – Push-in type jumper bar (2002 Series)

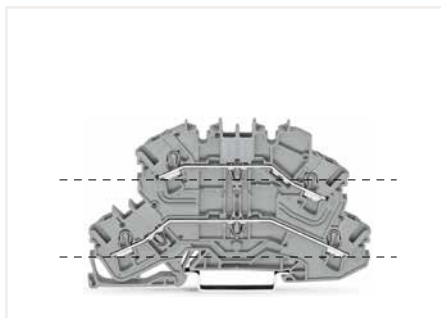

Through terminal blocks (2002-2601) feature two independent current bars on both lower and upper deck, sharing the same profile as disconnect terminal blocks. These terminal blocks can be commoned via double-deck vertical jumpers (2002-492).

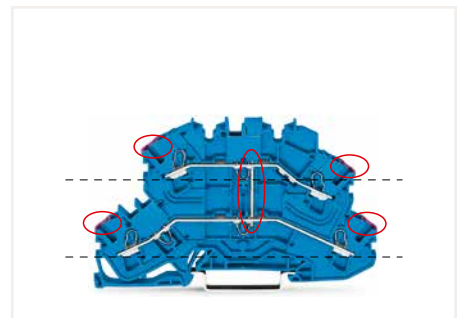

4-conductor through terminal blocks (2002-2609) with internal commoning can be immediately identified via violet conductor entry.

Double-Deck Disconnect Terminal Block and Carrier Terminal Block TOPJOB® S

2.5 (4) mm²; 2002 Series

1

Technical Data	
0.25 ... 2.5 (4) mm ² ❶	22 ... 12 AWG
400 V/6 kV/3 ❷	300 V, 20 A ❸
I _N 16 A	
Terminal block width: 5.2 mm / 0.205 inch	
10 ... 12 mm / 0.39 ... 0.47 inch	

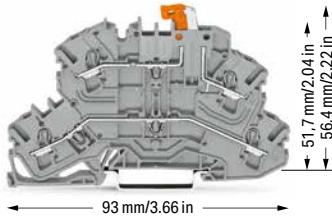

Double-deck disconnect terminal block; with a pivoting knife disconnect; gray housing		
	Item No.	Pack. Unit
○ L/L ❹	2002-2671 ❸	50
○ N/L ❹	2002-2672 ❸	50

Other terminal blocks with the same profile:		
Through	2002-2601	Page 72
Fuse	2002-2611	Page 75

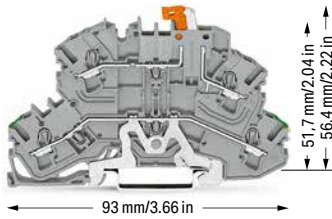

Double-deck disconnect terminal block; with a pivoting knife disconnect; gray housing		
	Item No.	Pack. Unit
○ Shield/L ❹	2002-2678 ❸	50

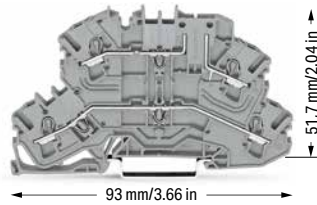

Technical Data	
0.25 ... 2.5 (4) mm ² ❶	22 ... 12 AWG
400 V/6 kV/3 ❷	300 V, 20 A ❸
I _N 16 A	
Terminal block width: 5.2 mm / 0.205 inch	
10 ... 12 mm / 0.39 ... 0.47 inch	





Double-deck carrier terminal block; upper-deck base; gray housing		
	Item No.	Pack. Unit
○ L/L ❹	2002-2661 ❸	50
○ N/L ❹	2002-2662 ❸	50

Double-deck carrier terminal block; upper-deck base; gray housing		
	Item No.	Pack. Unit
○ PE/L ❹	2002-2667 ❸	50

- ❶ Conductor range: 0.25 ... 4 mm² "s+f-st"; Push-in termination: 1 ... 4 mm² "s" and 1 ... 2.5 mm² "insulated ferrules, 12 mm"
Depending on the conductor characteristic, a conductor with a smaller cross section can also be inserted via push-in termination.
 - ❷ 400 V = rated voltage
6 kV = rated impulse voltage
3 = pollution degree
(see Section 14)
 - ❸ Terminal blocks with an Ex mark are suitable for Ex ec IIc applications.
(see Section 14)
- Please observe the application notes:
Jumpers, from page 157
Testing accessories, from page 151
Marking, from page 588
- Approvals and corresponding ratings, visit www.wago.com

Accessories; 2002 Series		
Appropriate marking systems: WMB/WMB Inline/Marking strips		
End and intermediate plate; 1 mm thick		
	orange	2002-2692 100 (25)
	gray	2002-2691 100 (25)

Double-deck marker carrier; pivoting		
	gray	2002-121 50 (25)

Insulation stop; 5 pcs/strip; 0.25 ... 0.5 mm ²		
	light gray	2002-171 200 (25)

Insulation stop; 5 pcs/strip; 0.75 ... 1 mm ²		
	dark gray	2002-172 200 (25)

Push-in type jumper bar; insulated; I _N 25 A; light gray		
	2-way	2002-402 25
	3-way	2002-403 25
	4-way	2002-404 25
	5-way	2002-405 25
	6-way	2002-406 25
	7-way	2002-407 25
	8-way	2002-408 25
	9-way	2002-409 25
	10-way	2002-410 25

Push-in type jumper bar; insulated; I _N 25 A; light gray		
	1 to 3	2002-433 25
	1 to 4	2002-434 25
	1 to 5	2002-435 25
	1 to 6	2002-436 25
	1 to 7	2002-437 25
	1 to 8	2002-438 25
	1 to 9	2002-439 25
	1 to 10	2002-440 25

Double-deck vertical jumper; insulated; I _N 24 A		
	light gray	2002-492 100 (25)
	orange	2002-492/000-012 100 (25)

Adjacent jumper for continuous commoning; insulated; I _N 25 A, light gray		
	2-way	2002-400 25

Double-Deck Fuse Terminal Block TOPJOB® S

2.5 (4) mm²; 2002 Series

Technical Data	
0.25 ... 2.5 (4) mm ² ❶	22 ... 12 AWG
250 V/6 kV/3 ❷	300 V, 6.3 A ❸
I _N 6.3 A	
Terminal block width: 6.2 mm / 0.244 inch	
10 ... 12 mm / 0.39 ... 0.47 inch	

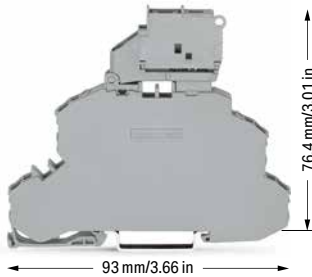

Double-deck fuse disconnect terminal block with a pivoting fuse holder; through/fuse terminal block; for 5 x 20 mm glass cartridge fuse; without blown fuse indication; gray
Electrical ratings are given by the fuse.

	Item No.	Pack. Unit
○ L/L ❹	2002-2611 ❺	25
○ N/L ❹	2002-2612 ❺	25

Other terminal blocks with the same profile:		
Through	2002-2601	Page 72

Accessories; 2002 Series

Appropriate marking systems: WMB/Marking strips

End and intermediate plate; 1 mm thick			
orange	2002-2692	100 (25)	
gray	2002-2691	100 (25)	

End plate for fuse terminal blocks; 2 mm thick			
orange	2002-1092	100 (25)	
gray	2002-1091	100 (25)	

Push-in type jumper bar; insulated; I _N 32 A; light gray			
2-way	2004-402	25	
3-way	2004-403	25	
4-way	2004-404	25	
5-way	2004-405	25	
6-way	2004-406	25	
7-way	2004-407	25	
8-way	2004-408	25	
9-way	2004-409	25	
10-way	2004-410	25	

Push-in type jumper bar; insulated; I _N 32 A; light gray			
1 to 3	2004-433	25	
1 to 4	2004-434	25	
1 to 5	2004-435	25	
1 to 6	2004-436	25	
1 to 7	2004-437	25	
1 to 8	2004-438	25	
1 to 9	2004-439	25	
1 to 10	2004-440	25	

Double-deck vertical jumper; insulated; I _N 24 A			
light gray	2002-492	100 (25)	
orange	2002-492/000-012	100 (25)	

Technical Data	
0.25 ... 2.5 (4) mm ² ❶	22 ... 12 AWG
250 V/6 kV/3 ❷	300 V, 6.3 A ❸
I _N 6.3 A	
Terminal block width: 6.2 mm / 0.244 inch	
10 ... 12 mm / 0.39 ... 0.47 inch	



Double-deck fuse disconnect terminal block with a pivoting fuse holder; through/fuse terminal block; for 5 x 20 mm glass cartridge fuse; with blown fuse indication by LED; gray
Electrical ratings are given by the fuse and blown fuse indication. Leakage current in case of a blown fuse: LED 2 mA

	Item No.	Pack. Unit
○ 12 ... 30 V ❹	2002-2611/1000-541 ❺	25
○ 30 ... 65 V ❹	2002-2611/1000-542 ❺	25
○ 230 V ❹	2002-2611/1000-836 ❺	25
○ 120 V ❹	2002-2611/1000-867 ❺	25

Insulation stop; 5 pcs/strip; 0.25 ... 0.5 mm ²			
light gray	2002-171	200 (25)	

Insulation stop; 5 pcs/strip; 0.75 ... 1 mm ²			
dark gray	2002-172	200 (25)	

Protective warning marker; with black high-voltage symbol; for 5 terminal blocks			
yellow	2002-115	100 (25)	

Test plug; with 500 mm cable; 2 mm Ø; max. 42 V			
red	210-136	50	

Test plug; with 500 mm cable; 2.3 mm Ø; max. 42 V			
	210-137	50	

Marking strip; plain; 11 mm wide; 50 m reel			
white	2009-110	1	

WMB marking card; white; 10 strips with 10 markers/card; 5 ... 5.2 mm stretchable			
plain	793-5501	5	

❶ Conductor range: 0.25 ... 4 mm² "s+f-st"; Push-in termination: 1 ... 4 mm² "s" and 1 ... 2.5 mm² "insulated ferrules, 12 mm"
Depending on the conductor characteristic, a conductor with a smaller cross section can also be inserted via push-in termination.

❷ 250 V = rated voltage
6 kV = rated impulse voltage
3 = pollution degree
(see Section 14)

❸ Terminal blocks with an Ex mark are suitable for Ex ec IIc applications.
(see Section 14)

Please observe the application notes:
Jumpers, from page 157
Marking, from page 588

A protective warning marker and an insulation stop must be applied individually. Due to the 6.2 mm width of double-deck terminal blocks with end plates, 2004 Series Push-In Type Jumper Bars must be used.

Approvals and corresponding ratings, visit www.wago.com

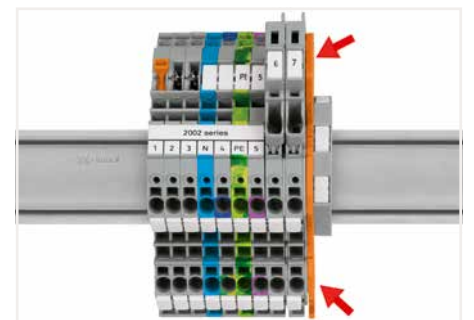

Additionally, an end plate for fuse terminal blocks (e.g., 2002-1092, orange) must be used at the end of an assembly or if there is no adjacent fuse terminal block.

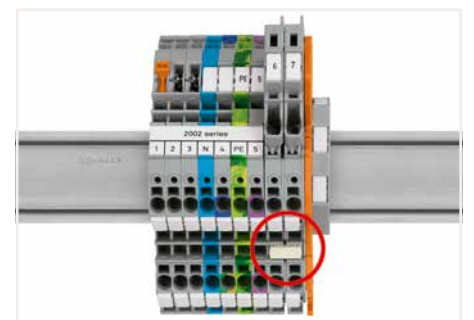

An intermediate plate is supplied with all 6.2 mm wide fused disconnect terminal blocks.
Due to the 6.2 mm width of fuse disconnect terminal blocks with a pivoting fuse holder, 2004 Series Push-In Type Jumper Bars must be used.

Triple-Deck Terminal Block TOPJOB® S

2.5 (4) mm²; 2002 Series

1

Technical Data	
0.25 ... 2.5 (4) mm ² ①	22 ... 12 AWG
500 V/6 kV/3 ②	600 V, 20 A ③
I _N 24 A (28 A)	600 V, 20 A ④
Terminal block width: 5.2 mm / 0.205 inch	
10 ... 12 mm / 0.39 ... 0.47 inch	

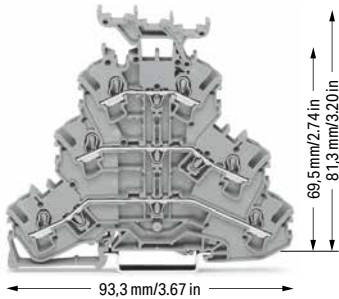

Triple-deck terminal block; through/through/through terminal block; with marker carrier; gray housing		
	Item No.	Pack. Unit
○ L/L/L ⑤	2002-3231 ④	50
○ L/L/N ⑤	2002-3233 ④	50

Triple-deck terminal block; through/through/through terminal block; without marker carrier; gray housing		
	Item No.	Pack. Unit
○ L/L/L ⑤	2002-3201 ④	50
○ L/L/N ⑤	2002-3203 ④	50

Other terminal blocks with the same profile:		
Diode	2002-3211/1000-410	Page 136
LED	2002-3221/1000-434	Page 136

Technical Data	
0.25 ... 2.5 (4) mm ² ①	22 ... 12 AWG
500 V/6 kV/3 ②	600 V, 20 A ③
I _N 24 A (28 A)	600 V, 20 A ④
Terminal block width: 5.2 mm / 0.205 inch	
10 ... 12 mm / 0.39 ... 0.47 inch	

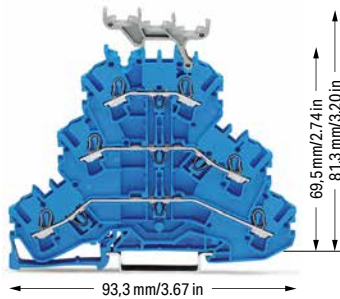

Triple-deck terminal block; through/through/through terminal block; with marker carrier; blue housing		
	Item No.	Pack. Unit
● N/N/N ⑤	2002-3234 ④ ④	50

Triple-deck terminal block; through/through/through terminal block; without marker carrier; blue housing		
	Item No.	Pack. Unit
● N/N/N ⑤	2002-3204 ④ ④	50

Technical Data	
0.25 ... 2.5 (4) mm ² ①	22 ... 12 AWG
500 V/6 kV/3 ②	600 V, 20 A ③
I _N 24 A (28 A)	600 V, 20 A ④
Terminal block width: 5.2 mm / 0.205 inch	
10 ... 12 mm / 0.39 ... 0.47 inch	

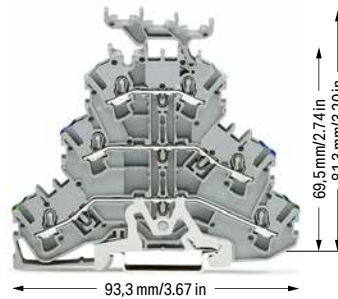

Triple-deck terminal block; through/through/through terminal block; with marker carrier; blue housing		
	Item No.	Pack. Unit
○ PE/N/L ⑤	2002-3247 ④	50
○ PE/L/L ⑤	2002-3257 ④	50

Triple-deck terminal block; ground conductor/through/through terminal block; without marker carrier; gray housing		
	Item No.	Pack. Unit
○ PE/N/L ⑤	2002-3217 ④	50
○ PE/L/L ⑤	2002-3227 ④	50

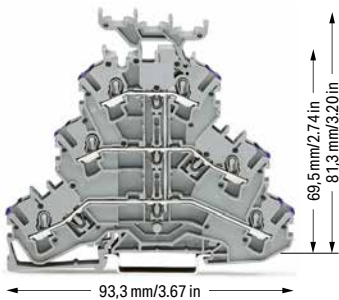

Triple-deck terminal block; 6-conductor through terminal block; with marker carrier; internally commoned; violet conductor entry; gray housing		
	Item No.	Pack. Unit
○ L ⑤	2002-3238 ④	50

Triple-deck terminal block; 6-conductor through terminal block; without marker carrier; internally commoned; violet conductor entry; gray housing		
	Item No.	Pack. Unit
○ L ⑤	2002-3208 ④	50

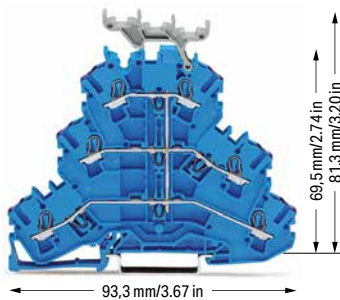

Triple-deck terminal block; 6-conductor through terminal block; with marker carrier; internally commoned; violet conductor entry; blue housing		
	Item No.	Pack. Unit
● N ⑤	2002-3239 ④ ④	50

Triple-deck terminal block; 6-conductor through terminal block; without marker carrier; internally commoned; violet conductor entry; blue housing		
	Item No.	Pack. Unit
● N ⑤	2002-3209 ④ ④	50

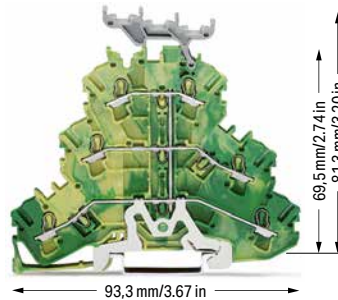

Triple-deck terminal block; 6-conductor ground terminal block; with marker carrier; internally commoned; green-yellow housing		
	Item No.	Pack. Unit
● PE ⑤	2002-3237 ④	50

Triple-deck terminal block; 6-conductor ground terminal block; without marker carrier; internally commoned; green-yellow housing		
	Item No.	Pack. Unit
● PE ⑤	2002-3207 ④	50

Technical Data

0.25 ... 2.5 (4) mm ² ①	22 ... 12 AWG
500 V/6 kV/3 ②	600 V, 20 A ③
I _N 24 A (28 A)	600 V, 20 A ④
Terminal block width: 5.2 mm / 0.205 inch	
10 ... 12 mm / 0.39 ... 0.47 inch	

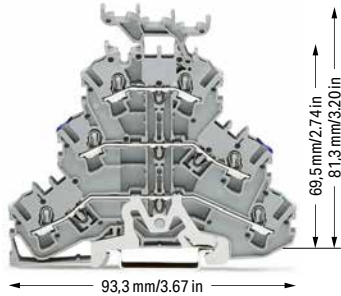

Triple-deck terminal block; shield/through/through terminal block; with marker carrier; gray housing

	Item No.	Pack. Unit
○ Shield/N/L	2002-3248	50
○ Shield/L/L	2002-3258	50

Triple-deck terminal block; shield/through/through terminal block; without marker carrier; gray housing

○ Shield/N/L	2002-3218	50
○ Shield/L/L	2002-3228	50

① Conductor range: 0.25 ... 4 mm² "s+f-st"; Push-in termination: 1 ... 4 mm² "s" and 1 ... 2.5 mm² "insulated ferrules, 12 mm"
Depending on the conductor characteristic, a conductor with a smaller cross section can also be inserted via push-in termination.

② 500 V = rated voltage
6 kV = rated impulse voltage
3 = pollution degree (see Section 14)

③ Terminal blocks with a blue insulated housing are suitable for Ex i applications.

④ Terminal blocks with an Ex mark are suitable for Ex e II applications.
440 V, 19 A
17 A jumper (see Section 14)

Please observe the application notes:
Jumpers, from page 157
Testing accessories, from page 151
Marking, from page 588

Approvals and corresponding ratings, visit www.wago.com

Accessories; 2002 Series

Appropriate marking systems:
WMB/WMB Inline/Marking strips

End and intermediate plate; 0.8 mm thick

	orange	2002-3292	100 (25)
	gray	2002-3291	100 (25)

Triple-deck marker carrier; pivoting

	gray	2002-131	50 (25)
---	------	----------	---------

Insulation stop; 5 pcs/strip; 0.25 ... 0.5 mm²

	light gray	2002-171	200 (25)
---	------------	----------	----------

Insulation stop; 5 pcs/strip; 0.75 ... 1 mm²

	dark gray	2002-172	200 (25)
---	-----------	----------	----------

Push-in type jumper bar; insulated; I_N 25 A; light gray

	2-way	2002-402	25
	3-way	2002-403	25
	4-way	2002-404	25
	5-way	2002-405	25
	6-way	2002-406	25
	7-way	2002-407	25
	8-way	2002-408	25
	9-way	2002-409	25
	10-way	2002-410	25

Push-in type jumper bar; insulated; I_N 25 A; light gray

	1 to 3	2002-433	25
	1 to 4	2002-434	25
	1 to 5	2002-435	25
	1 to 6	2002-436	25
	1 to 7	2002-437	25
	1 to 8	2002-438	25
	1 to 9	2002-439	25
	1 to 10	2002-440	25

Double-deck vertical jumper; insulated; I_N 24 A

	light gray	2002-492	100 (25)
	orange	2002-492/000-012	100 (25)

Triple-deck vertical jumper; insulated; I_N 24 A

	light gray	2002-493	100 (25)
---	------------	----------	----------



Triple-deck vertical jumpers (2002-493) connect the three levels of triple-deck terminal blocks.



Combination of multilevel terminal blocks

Quadruple-Deck Rail-Mount Terminal Block for Wiring of Electric Motors TOPJOB® S

2.5 (4) mm²; 2002 Series

1

Technical Data	
0.25 ... 2.5 (4) mm ² ①	22 ... 12 AWG
800 V/8 kV/3 ②	
I _N 20 A (25 A)	
Terminal block width: 5.2 mm / 0.205 inch	
10 ... 12 mm / 0.39 ... 0.47 inch	

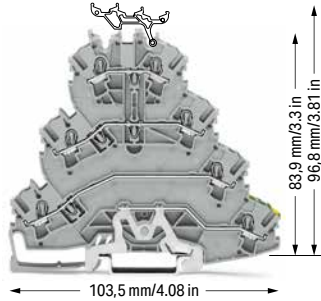

Quadruple-deck rail-mount terminal block; electric motor wiring rail-mount terminal block; without marker carrier; gray

	Item No.	Pack. Unit
○ L1 - L2 - L3 - PE ③	2002-4127 ③	25

	Item No.	Pack. Unit
○ L1 - L2 - L3 - PE ③	2002-4157 ③	25

Technical Data	
0.25 ... 2.5 (4) mm ² ①	22 ... 12 AWG
800 V/8 kV/3 ②	
I _N 20 A (25 A)	
Terminal block width: 5.2 mm / 0.205 inch	
10 ... 12 mm / 0.39 ... 0.47 inch	

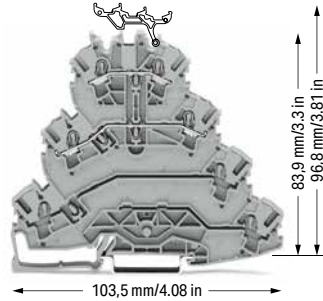

Quadruple-deck rail-mount terminal block; electric motor wiring rail-mount terminal block; without marker carrier; gray

	Item No.	Pack. Unit
○ L1 - L2 ③	2002-4111 ③	25

	Item No.	Pack. Unit
○ L1 - L2 ③	2002-4141 ③	25

Technical Data	
0.25 ... 2.5 (4) mm ² ①	22 ... 12 AWG
800 V/8 kV/3 ②	
I _N 20 A (25 A)	
Terminal block width: 5.2 mm / 0.205 inch	
10 ... 12 mm / 0.39 ... 0.47 inch	

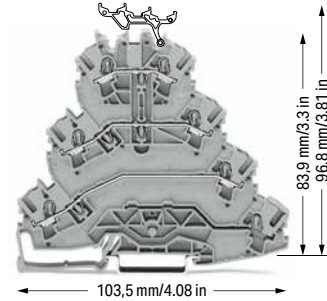

Quadruple-deck rail-mount terminal block; electric motor wiring rail-mount terminal block; without marker carrier; gray

	Item No.	Pack. Unit
○ L1 - L2 - L3 ③	2002-4101 ③	25

	Item No.	Pack. Unit
○ L1 - L2 - L3 ③	2002-4131 ③	25

Accessories; 2002 Series

Appropriate marking systems: WMB/WMB Inline/Marking strips

End and intermediate plate; 1 mm thick			
	orange	2002-4192	100 (25)
	gray	2002-4191	100 (25)

Insulation stop; 5 pcs/strip; 0.25 ... 0.5 mm ²			
	light gray	2002-171	200 (25)

Insulation stop; 5 pcs/strip; 0.75 ... 1 mm ²			
	dark gray	2002-172	200 (25)

Protective warning marker; with black high-voltage symbol; for 5 terminal blocks			
	yellow	2002-115	100 (25)

Lockout cap; for conductor entry and operating slot			
	orange	2002-192	25
	gray	2002-191	25
	blue	2002-194	25

Push-in type jumper bar; insulated; I _N 25 A; light gray			
	2-way	2002-402	25
	3-way	2002-403	25
	4-way	2002-404	25
	5-way	2002-405	25
	6-way	2002-406	25
	7-way	2002-407	25
	8-way	2002-408	25
	9-way	2002-409	25
	10-way	2002-410	25

Adjacent jumper for continuous commoning; insulated; I _N 25 A, light gray			
	2-way	2002-415	25

Push-in type jumper bar; insulated; I _N 25 A; light gray			
	1 to 3	2002-433	25
	1 to 4	2002-434	25
	1 to 5	2002-435	25
	1 to 6	2002-436	25
	1 to 7	2002-437	25
	1 to 8	2002-438	25
	1 to 9	2002-439	25
	1 to 10	2002-440	25

Delta jumper; insulated; I _N = I _N terminal block; light gray			
	1-2 3-4 5-6	2002-406/020-000	25

Star point jumper; insulated; I _N = I _N terminal block; light gray			
	1-3-5	2002-405/011-000	25

Staggered jumper; insulated; I _N 25 A; light gray			
	2-way	2002-472	25
	3-way	2002-473	25
	4-way	2002-474	25
	5-way	2002-475	25
	6-way	2002-476	25
	7-way	2002-477	25
	8-way	2002-478	25
	9-way	2002-479	25
	10-way	2002-480	25
	11-way	2002-481	25
	12-way	2002-482	25

Adjacent jumper for continuous commoning; insulated; I _N 25 A, light gray			
	5-way	2002-400	25

Adjacent jumper for continuous commoning; insulated; I _N 25 A; 1 to 3			
	light gray	2002-423	25
	red	2002-423/000-005	25
	blue	2002-423/000-006	25

Push-in type wire jumper; insulated; 1.5 mm ² conductor cross-section; I _N 18 A			
	L = 60 mm	2009-412	100 (10)
	L = 110 mm	2009-414	100 (10)
	L = 250 mm	2009-416	100 (10)

WMB Inline, plain; 1,500 WMB markers (5 mm)/reel; 5 ... 5.2 mm stretchable			
	white	2009-115	1

Marking strip; plain; 11 mm wide; 50 m reel			
	white	2009-110	1

WMB marking card; white; 10 strips with 10 markers/card; 5 ... 5.2 mm stretchable			
	plain	793-5501	5

Triple-deck marker carrier; pivoting			
	gray	2002-131	50 (25)

❶ Conductor range: 0.25 ... 4 mm² "s+f-st";
Push-in termination: 1 ... 4 mm² "s" and 1 ... 2.5 mm²
"insulated ferrules, 12 mm"
Depending on the conductor characteristic, a conductor with a smaller cross section can also be inserted via push-in termination.

❷ 800 V = rated voltage
8 kV = rated impulse voltage
3 = pollution degree
(see Section 14)

❸ Terminal blocks with an Ex mark are suitable for Ex e II applications.
440 V, 19 A
17 A jumper
(see Section 14)

Please observe the application notes:
Jumpers, from page 152
Testing accessories, from page 151
Marking, from page 588

Approvals and corresponding ratings,
visit www.wago.com



Creating spacer housings for electric motor wiring rail-mount terminal blocks via lockout caps (2002-192) for conductor entry and operating slot.

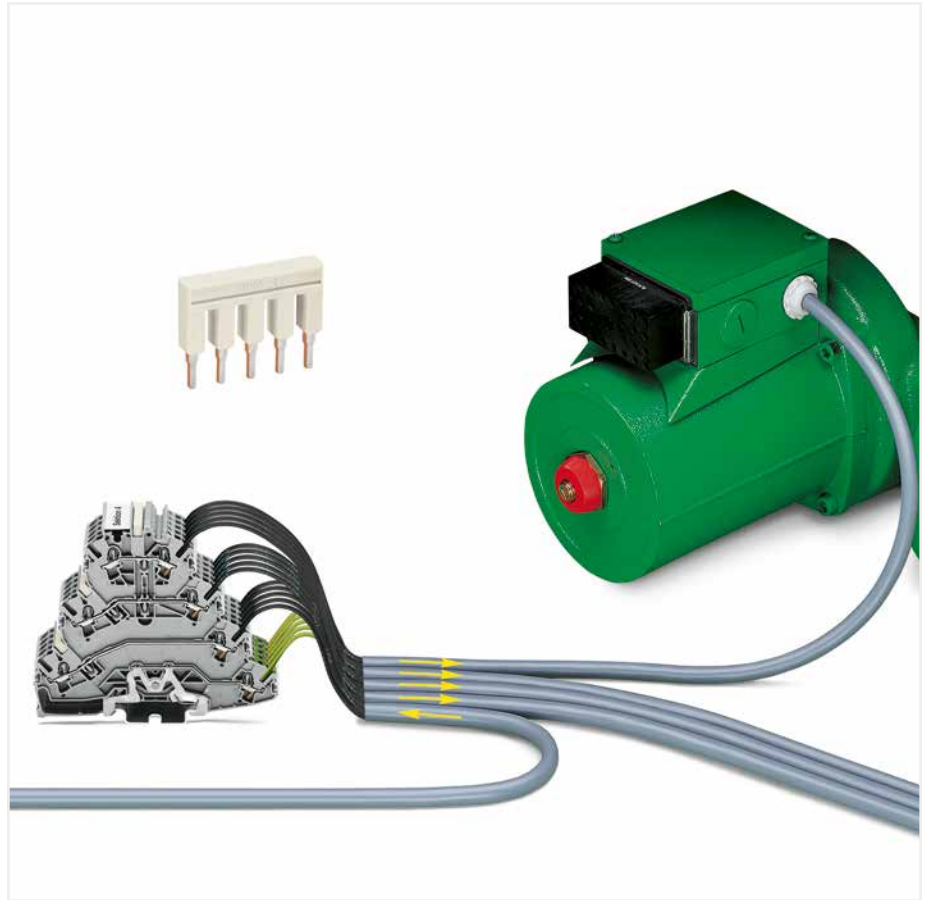

In addition to rail-mount terminal blocks for electric motor wiring, special versions are also available.

- Version without ground contact and only two potentials:
These terminal blocks were custom designed to support additional functions, such as engine brakes or temperature sensors. Sharing a common profile, this terminal block version can be put next to the appropriate electric motor wiring terminal block without using intermediate plates. That makes the rail assembly easier to understand and wire. This also prevents wiring errors as no conductor entry is unused.
- Version without ground contact and with three potentials:
Clearly designated clamping units are the primary advantage to this terminal block design. When using devices with protective insulation, for example, there are no open ground clamping units that could create confusion.



Testing with voltage tester.



Marking clamping points via WMB Multi Marking System.
Group marking via marking strips (Item No. 709-177).

Double-Deck Disconnect/Test Terminal Block TOPJOB® S

2.5 (4) mm²; 2002 Series

1

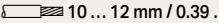
Technical Data	
0.25 ... 2.5 (4) mm ² ①	22 ... 12 AWG
400 V/6 kV/3 ②	300 V, 15 A ③
I _N 16 A	300 V, 15 A ④
Terminal block width: 5.2 mm / 0.205 inch	
 10 ... 12 mm / 0.39 ... 0.47 inch	

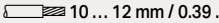
Technical Data	
0.25 ... 2.5 (4) mm ² ①	22 ... 12 AWG
400 V/6 kV/3 ②	300 V, 15 A ③
I _N 16 A	300 V, 15 A ④
Terminal block width: 5.2 mm / 0.205 inch	
 10 ... 12 mm / 0.39 ... 0.47 inch	

Technical Data	
0.25 ... 2.5 (4) mm ² ①	22 ... 12 AWG
400 V/6 kV/3 ②	300 V, 15 A ③
I _N 16 A	300 V, 15 A ④
Terminal block width: 5.2 mm / 0.205 inch	
 10 ... 12 mm / 0.39 ... 0.47 inch	

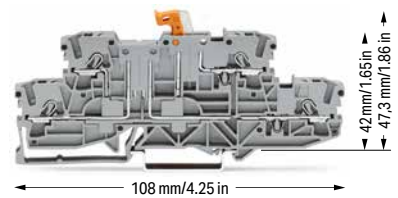
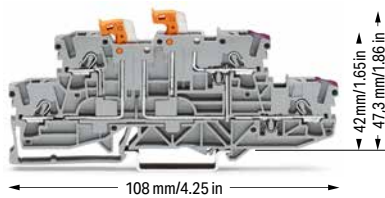
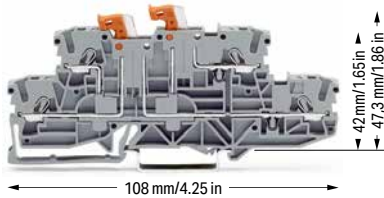

Double-deck, double-disconnect terminal block; with 2 pivoting knife disconnects; gray housing

Double-deck, double-disconnect terminal block; with two pivoting knife disconnects; lower and upper decks internally commoned on right side, violet conductor entry; gray housing

Double-deck disconnect terminal block; with pivoting knife disconnect; same profile as double-deck, double-disconnect terminal block; gray housing

	Item No.	Pack. Unit
○ L/L ⑤	2002-2951 ⑥	50
○ N/L ⑤	2002-2952 ⑥	50

	Item No.	Pack. Unit
○ L/L ⑤	2002-2958 ⑥	50

	Item No.	Pack. Unit
○ L/L ⑤	2002-2971 ⑥	50
○ N/L ⑤	2002-2972 ⑥	50

Double-deck, double-disconnect terminal block; with 2 pivoting knife disconnects; blue housing

Double-deck, double-disconnect terminal block; with two pivoting knife disconnects; lower and upper decks internally commoned on right side, violet conductor entry; blue housing

Double-deck disconnect terminal block; with pivoting knife disconnect; same profile as double-deck, double-disconnect terminal block; blue housing

● N/N ⑤	2002-2954 ⑥	50
---------	-------------	----

● N/N ⑤	2002-2959 ⑥	50
---------	-------------	----

● N/N ⑤	2002-2974 ⑥	50
---------	-------------	----

Accessories; 2002 Series

Appropriate marking systems: WMB/WMB Inline/Marking strips

End and intermediate plate; 1 mm thick			
	orange	2002-2992	100 (25)
	gray	2002-2991	100 (25)

Insulation stop; 5 pcs/strip; 0.25 ... 0.5 mm ²			
	light gray	2002-171	200 (25)

Insulation stop; 5 pcs/strip; 0.75 ... 1 mm ²			
	dark gray	2002-172	200 (25)

Protective warning marker; with black high-voltage symbol; for 5 terminal blocks			
	yellow	2002-115	100 (25)

Push-in type jumper bar; insulated; I _N 25 A; light gray			
	2-way	2002-402	25
	3-way	2002-403	25
	4-way	2002-404	25
	5-way	2002-405	25
	6-way	2002-406	25
	7-way	2002-407	25
	8-way	2002-408	25
	9-way	2002-409	25
	10-way	2002-410	25

Push-in type wire jumper; insulated; 1.5 mm ² conductor cross-section; I _N 18 A			
	L = 60 mm	2009-412	100 (10)
	L = 110 mm	2009-414	100 (10)
	L = 250 mm	2009-416	100 (10)

Push-in type jumper bar; insulated; I _N 25 A; light gray			
	1 to 3	2002-433	25
	1 to 4	2002-434	25
	1 to 5	2002-435	25
	1 to 6	2002-436	25
	1 to 7	2002-437	25
	1 to 8	2002-438	25
	1 to 9	2002-439	25
	1 to 10	2002-440	25

Delta jumper; insulated; I _N = I _N terminal block; light gray			
	1-2 3-4 5-6	2002-406/020-000	25

Star point jumper; insulated; I _N = I _N terminal block; light gray			
	1-3-5	2002-405/011-000	25

Staggered jumper; insulated; I _N 25 A; light gray			
	2-way	2002-472	25
	3-way	2002-473	25
	4-way	2002-474	25
	5-way	2002-475	25
	6-way	2002-476	25
	7-way	2002-477	25
	8-way	2002-478	25
	9-way	2002-479	25
	10-way	2002-480	25
	11-way	2002-481	25
	12-way	2002-482	25

Adjacent jumper for continuous commoning; insulated; I _N 25 A, light gray			
	2-way	2002-400	25

Adjacent jumper for continuous commoning; insulated; I _N 25 A; 1 to 3			
	light gray	2002-423	25
	red	2002-423/000-005	25
	blue	2002-423/000-006	25

Modular connector; snaps together; for jumper contact slot			
	gray	2002-511	100 (25)

Spacer module; snaps together; bridges commoned terminal blocks			
	gray	2002-549	100 (25)

End plate; for modular connector; 1.5 mm thick			
	gray	2002-541	100 (25)

Test plug adapter; for 4 mm Ø test plug			
	gray	2009-174	100 (25)

Banana plug; for 4 mm socket diameter; color mixed; 10 x orange, white, black, blue, yellow; max. 42 V			
		215-111	50

❶ Conductor range: 0.25 ... 4 mm² "s+f-st";
Push-in termination: 1 ... 4 mm² "s" and 1 ... 2.5 mm²
"insulated ferrules, 12 mm"
Depending on the conductor characteristic, a conductor with a smaller cross section can also be inserted via push-in termination.

❷ 400 V = rated voltage
6 kV = rated impulse voltage
3 = pollution degree
(see Section 14)

❸ Terminal blocks with an Ex mark are suitable for Ex ec IIc applications.
(see Section 14)

Please observe the application notes:
Jumpers, from page 152
Testing accessories, from page 146
Marking, from page 588

Approvals and corresponding ratings,
visit www.wago.com

Accessories; 2002 Series

Appropriate marking systems:
WMB/WMB Inline/Marking strips

Testing tap; for max. 2.5 mm²

	gray	2009-182	100 (25)
---	------	----------	----------

WMB Inline, plain; 1,500 WMB markers (5 mm)/reel; 5 ... 5.2 mm stretchable

	white	2009-115	1
---	-------	----------	---

Marking strip; plain; 11 mm wide; 50 m reel

	white	2009-110	1
---	-------	----------	---

WMB marking card; white; 10 strips with 10 markers/card; 5 ... 5.2 mm stretchable

	plain	793-5501	5
---	-------	----------	---

WMB marking card; plain; 10 strips with 10 markers/card; 5 ... 5.2 mm stretchable

	yellow	793-5501/000-002	5
	red	793-5501/000-005	5
	blue	793-5501/000-006	5
	gray	793-5501/000-007	5
	orange	793-5501/000-012	5
	light green	793-5501/000-017	5
	green	793-5501/000-023	5
	violet	793-5501/000-024	5

Group marker carrier; snap-on type for jumper slot; 5 mm wide

	gray	2009-191	50 (25)
---	------	----------	---------

Screwless end stop; for DIN-35 rail; 6 mm wide

	gray	249-116	100 (25)
---	------	---------	----------

Screwless end stop; for DIN-35 rail; 10 mm wide

	gray	249-117	50 (25)
---	------	---------	---------



Double-deck, double-disconnect terminal blocks (2002-2951) with group marker carrier (2002-160) accommodated in jumper contact slot

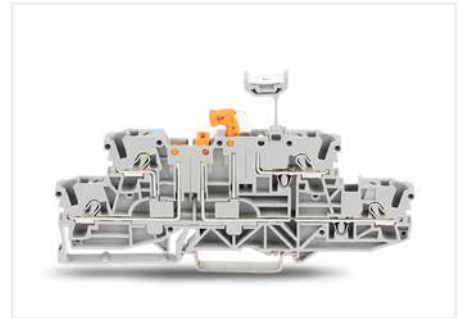

Double-deck, double-disconnect terminal block (2002-2951) with group marker carrier (2002-160) accommodated in jumper contact slot

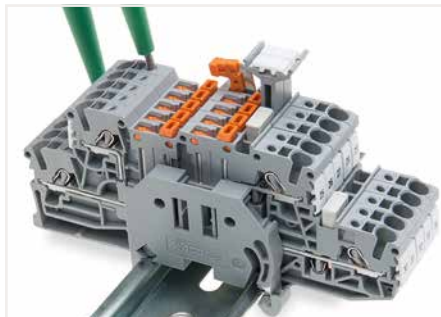

Testing with voltage tester.

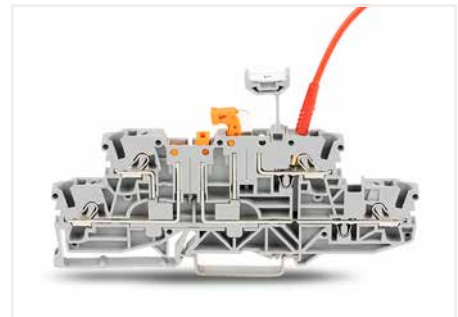

Double-deck, double-disconnect terminal block (2002-2951) with group marker carrier (2002-160) accommodated in a jumper contact slot and test plug (210-136)

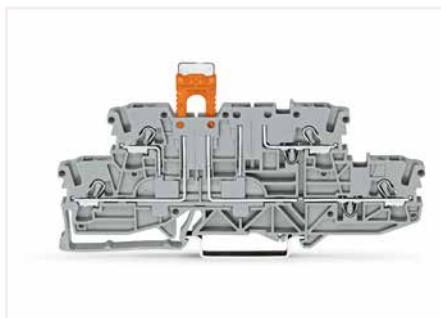

Carrier terminal block (2002-2941) with disconnect plug (2002-401) in parked position



Carrier terminal block (2002-2941) with disconnect plug (2002-401) in operating position

Disconnect/Test Terminal Block and Through Terminal Block of Same Profile TOPJOB® S 2.5 (4) mm²; 2002 Series

1

Technical Data	
0.25 ... 2.5 (4) mm ² ①	22 ... 12 AWG
400 V/6 kV/3 ②	300 V, 15 A ③
I _N 16 A	300 V, 10 A ④
Terminal block width: 5.2 mm / 0.205 inch	
10 ... 12 mm / 0.39 ... 0.47 inch	

Technical Data	
0.25 ... 2.5 (4) mm ² ①	22 ... 12 AWG
400 V/6 kV/3 ②	300 V, 15 A ③
I _N 16 A	300 V, 10 A ④
Terminal block width: 5.2 mm / 0.205 inch	
10 ... 12 mm / 0.39 ... 0.47 inch	

Technical Data	
0.25 ... 2.5 (4) mm ² ①	22 ... 12 AWG
400 V/6 kV/3 ②	300 V, 15 A ③
I _N 16 A	300 V, 10 A ④
Terminal block width: 5.2 mm / 0.205 inch	
10 ... 12 mm / 0.39 ... 0.47 inch	

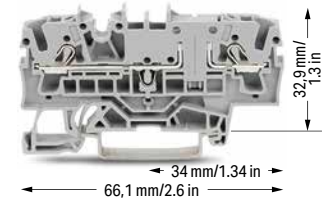
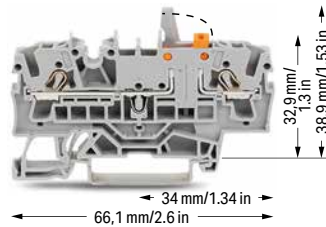
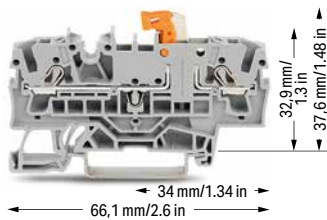

2-conductor disconnect/test terminal block; with test point; orange disconnect link

2-conductor disconnect/test terminal block; with mechanical interlock; with test point; orange disconnect link

2-conductor through terminal block; with test point; same profile as 2-conductor disconnect terminal block

Color	Item No.	Pack. Unit
gray ⑤	2002-1671 ⑥	50
blue ⑤	2002-1674 ⑥	50
orange ⑤	2002-1672 ⑥	50

Color	Item No.	Pack. Unit
gray ⑤	2002-1671/401-000 ⑥	50
blue ⑤	2002-1674/401-000 ⑥	50
orange ⑤	2002-1672/401-000 ⑥	50

Color	Item No.	Pack. Unit
gray ⑤	2002-1601 ⑥	50
blue ⑤	2002-1604 ⑥	50
orange ⑤	2002-1602 ⑥	50

Other terminal blocks with the same profile:

Carrier	2002-1661	Page 114
Fuse	2002-1681	Page 88

Accessories; 2002 Series

Appropriate marking systems: WMB/WMB Inline/Marking strips

End and intermediate plate; 1 mm thick			
orange	2002-1692	100 (25)	
gray	2002-1691	100 (25)	

Insulation stop; 5 pcs/strip; 0.25 ... 0.5 mm ²		
light gray	2002-171	200 (25)

Insulation stop; 5 pcs/strip; 0.75 ... 1 mm ²		
dark gray	2002-172	200 (25)

Protective warning marker; with black high-voltage symbol; for 5 terminal blocks		
yellow	2002-115	100 (25)

Push-in type jumper bar; insulated; I _N 25 A; light gray			
2-way	2002-402	25	
3-way	2002-403	25	
4-way	2002-404	25	
5-way	2002-405	25	
6-way	2002-406	25	
7-way	2002-407	25	
8-way	2002-408	25	
9-way	2002-409	25	
10-way	2002-410	25	

Push-in type wire jumper; insulated; 1.5 mm ² conductor cross-section; I _N 18 A			
L = 60 mm	2009-412	100 (10)	
L = 110 mm	2009-414	100 (10)	
L = 250 mm	2009-416	100 (10)	

Push-in type jumper bar; insulated; I _N 25 A; light gray			
1 to 3	2002-433	25	
1 to 4	2002-434	25	
1 to 5	2002-435	25	
1 to 6	2002-436	25	
1 to 7	2002-437	25	
1 to 8	2002-438	25	
1 to 9	2002-439	25	
1 to 10	2002-440	25	

Delta jumper; insulated; I _N = I _N terminal block; light gray		
1-2 3-4 5-6	2002-406/020-000	25

Star point jumper; insulated; I _N = I _N terminal block; light gray		
1-3-5	2002-405/011-000	25

Staggered jumper; insulated; I _N 25 A; light gray			
2-way	2002-472	25	
3-way	2002-473	25	
4-way	2002-474	25	
5-way	2002-475	25	
6-way	2002-476	25	
7-way	2002-477	25	
8-way	2002-478	25	
9-way	2002-479	25	
10-way	2002-480	25	
11-way	2002-481	25	
12-way	2002-482	25	

Customized staggered jumper; insulated; with contact lugs broken off at the factory and circuit printing; I _N 25 A; light gray			
1-3	2002-473/011-000	25	
1-3-5	2002-475/011-000	25	
1-3-5-7	2002-477/011-000	25	
1-3-5-7-9	2002-479/011-000	25	
1-3-5-7-9-11	2002-481/011-000	25	

Adjacent jumper for continuous commoning; insulated; I _N 25 A; light gray		
2-way	2002-400	25

Adjacent jumper for continuous commoning; insulated; I _N 25 A; 1 to 3			
light gray	2002-423	25	
red	2002-423/000-005	25	
blue	2002-423/000-006	25	

Modular connector; snaps together; for jumper contact slot			
gray	2002-511	100 (25)	

Spacer module; snaps together; bridges commoned terminal blocks		
gray	2002-549	100 (25)

End plate; for modular connector; 1.5 mm thick		
gray	2002-541	100 (25)

❶ Conductor range: 0.25 ... 4 mm² "s+f-st";
Push-in termination: 1 ... 4 mm² "s" and 1 ... 2.5 mm²
"insulated ferrules, 12 mm"
Depending on the conductor characteristic, a conductor with a smaller cross section can also be inserted via push-in termination.

❷ 400 V = rated voltage
6 kV = rated impulse voltage
3 = pollution degree
(see Section 14)

❸ Terminal blocks with an Ex mark are suitable for Ex ec IIc applications.
(see Section 14)

Please observe the application notes:
Jumpers, from page 152
Testing accessories, from page 146
Marking, from page 588

Approvals and corresponding ratings,
visit www.wago.com

Accessories; 2002 Series

Appropriate marking systems:
WMB/WMB Inline/Marking strips

L-type test plug module; snaps together



gray 2002-611 100 (25)

L-type spacer module; snaps together; bridges commoned terminal blocks



gray 2002-649 100 (25)

End plate; for modular test plug module; 1.5 mm thick



gray 2002-641 100 (25)

Test plug adapter; for 4 mm Ø test plug



gray 2009-174 100 (25)

Banana plug; for 4 mm socket diameter; color mixed; 10 x orange, white, black, blue, yellow; max. 42 V



215-111 50

Testing tap; for max. 2.5 mm²



gray 2009-182 100 (25)

WMB Inline, plain; 1,500 WMB markers (5 mm)/reel; 5 ... 5.2 mm stretchable



white 2009-115 1

Marking strip; plain; 11 mm wide; 50 m reel



white 2009-110 1

WMB marking card; white; 10 strips with 10 markers/card; 5 ... 5.2 mm stretchable



plain 793-5501 5

Double-deck marker carrier; pivoting



gray 2002-121 50 (25)



Disconnect/test terminal block with pivoting knife disconnect – testing with voltage tester.



Carrier terminal block (2002-1861) with disconnect plug (2002-401) in parked position



Carrier terminal block (2002-1861) with disconnect plug (2002-401) in operating position

Disconnect/Test Terminal Block and Through/Ground Terminal Block TOPJOB® S

2.5 (4) mm²; 2002 Series

1

Technical Data	
0.25 ... 2.5 (4) mm ² ①	22 ... 12 AWG
400 V/6 kV/3 ②	300 V, 15 A ③
I _N 16 A	300 V, 10 A ④
Terminal block width: 5.2 mm / 0.205 inch	
10 ... 12 mm / 0.39 ... 0.47 inch	

Technical Data	
0.25 ... 2.5 (4) mm ² ①	22 ... 12 AWG
400 V/6 kV/3 ②	300 V, 15 A ③
I _N 16 A	
Terminal block width: 5.2 mm / 0.205 inch	
10 ... 12 mm / 0.39 ... 0.47 inch	

Technical Data	
0.25 ... 2.5 (4) mm ² ①	22 ... 12 AWG
400 V/6 kV/3 ②	300 V, 15 A ③
I _N 16 A	300 V, 10 A ④
Terminal block width: 5.2 mm / 0.205 inch	
10 ... 12 mm / 0.39 ... 0.47 inch	

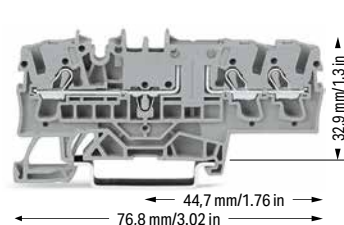
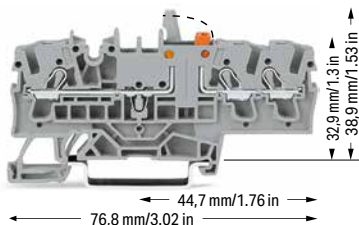
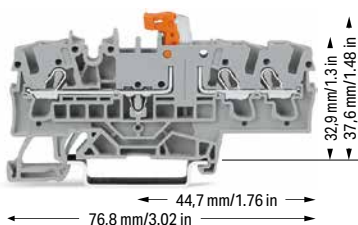

3-conductor disconnect/test terminal block; with test point; orange disconnect link

Color	Item No.	Pack. Unit
gray ⑤	2002-1771 ⑥	50
blue ⑤	2002-1774 ⑥	50
orange ⑤	2002-1772 ⑥	50

3-conductor disconnect/test terminal block; with mechanical interlock; with test point; orange disconnect link

Color	Item No.	Pack. Unit
gray ⑤	2002-1771/401-000 ⑥	50
blue ⑤	2002-1774/401-000 ⑥	50
orange ⑤	2002-1772/401-000 ⑥	50

3-conductor through terminal block; with test point; same profile as 3-conductor disconnect terminal block

Color	Item No.	Pack. Unit
gray ⑤	2002-1701 ⑥	50
blue ⑤	2002-1704 ⑥	50
orange ⑤	2002-1702 ⑥	50

3-conductor ground terminal block		
green-yellow ⑤	2002-1707 ⑥	50

Other terminal blocks with the same profile:

Carrier	2002-1761	Page 114
Fuse	2002-1781	Page 88

Accessories; 2002 Series

Appropriate marking systems: WMB/WMB Inline/Marking strips

End and intermediate plate; 1 mm thick

orange	2002-1792	100 (25)
gray	2002-1791	100 (25)

Insulation stop; 5 pcs/strip; 0.25 ... 0.5 mm²

light gray	2002-171	200 (25)
------------	----------	----------

Insulation stop; 5 pcs/strip; 0.75 ... 1 mm²

dark gray	2002-172	200 (25)
-----------	----------	----------

Protective warning marker; with black high-voltage symbol; for 5 terminal blocks

yellow	2002-115	100 (25)
--------	----------	----------

Push-in type jumper bar; insulated; I_N 25 A; light gray

2-way	2002-402	25
3-way	2002-403	25
4-way	2002-404	25
5-way	2002-405	25
6-way	2002-406	25
7-way	2002-407	25
8-way	2002-408	25
9-way	2002-409	25
10-way	2002-410	25

Push-in type wire jumper; insulated; 1.5 mm² conductor cross-section; I_N 18 A

L = 60 mm	2009-412	100 (10)
L = 110 mm	2009-414	100 (10)
L = 250 mm	2009-416	100 (10)

Push-in type jumper bar; insulated; I_N 25 A; light gray

1 to 3	2002-433	25
1 to 4	2002-434	25
1 to 5	2002-435	25
1 to 6	2002-436	25
1 to 7	2002-437	25
1 to 8	2002-438	25
1 to 9	2002-439	25
1 to 10	2002-440	25

Delta jumper; insulated; I_N = I_N terminal block; light gray

1-2 3-4 5-6	2002-406/020-000	25
-------------	------------------	----

Star point jumper; insulated; I_N = I_N terminal block; light gray

1-3-5	2002-405/011-000	25
-------	------------------	----

Staggered jumper; insulated; I_N 25 A; light gray

2-way	2002-472	25
3-way	2002-473	25
4-way	2002-474	25
5-way	2002-475	25
6-way	2002-476	25
7-way	2002-477	25
8-way	2002-478	25
9-way	2002-479	25
10-way	2002-480	25
11-way	2002-481	25
12-way	2002-482	25

Customized staggered jumper; insulated; with contact lugs broken off at the factory and circuit printing; I_N 25 A; light gray

1-3	2002-473/011-000	25
1-3-5	2002-475/011-000	25
1-3-5-7	2002-477/011-000	25
1-3-5-7-9	2002-479/011-000	25
1-3-5-7-9-11	2002-481/011-000	25

Adjacent jumper for continuous commoning; insulated; I_N 25 A; light gray

2-way	2002-400	25
-------	----------	----

Adjacent jumper for continuous commoning; insulated; I_N 25 A; 1 to 3

light gray	2002-423	25
red	2002-423/000-005	25
blue	2002-423/000-006	25

Modular connector; snaps together; for jumper contact slot

gray	2002-511	100 (25)
------	----------	----------

End plate; for modular connector; 1.5 mm thick

gray	2002-541	100 (25)
------	----------	----------

❶ Conductor range: 0.25 ... 4 mm² "s+f-st";
Push-in termination: 1 ... 4 mm² "s" and 1 ... 2.5 mm²
"insulated ferrules, 12 mm"
Depending on the conductor characteristic, a conductor with a smaller cross section can also be inserted via push-in termination.

❷ 400 V = rated voltage
6 kV = rated impulse voltage
3 = pollution degree
(see Section 14)

❸ Terminal blocks with an Ex mark are suitable for Ex ec IIc applications.
(see Section 14)

Please observe the application notes:
Jumpers, from page 152
Testing accessories, from page 146
Marking, from page 588

Approvals and corresponding ratings,
visit www.wago.com

Accessories; 2002 Series

Appropriate marking systems:
WMB/WMB Inline/Marking strips

L-type test plug module; snaps together

	gray	2002-611	100 (25)
---	------	----------	----------

L-type spacer module; snaps together; bridges commoned terminal blocks

	gray	2002-649	100 (25)
---	------	----------	----------

End plate; for modular test plug module; 1.5 mm thick

	gray	2002-641	100 (25)
---	------	----------	----------

Test plug adapter; for 4 mm Ø test plug

	gray	2009-174	100 (25)
---	------	----------	----------

Banana plug; for 4 mm socket diameter; color mixed; 10 x orange, white, black, blue, yellow; max. 42 V

		215-111	50
---	--	---------	----

Testing tap; for max. 2.5 mm²

	gray	2009-182	100 (25)
---	------	----------	----------

WMB Inline, plain; 1,500 WMB markers (5 mm)/reel; 5 ... 5.2 mm stretchable

	white	2009-115	1
---	-------	----------	---

Marking strip; plain; 11 mm wide; 50 m reel

	white	2009-110	1
---	-------	----------	---

WMB marking card; white; 10 strips with 10 markers/card; 5 ... 5.2 mm stretchable

	plain	793-5501	5
---	-------	----------	---

Double-deck marker carrier; pivoting

	gray	2002-121	50 (25)
---	------	----------	---------

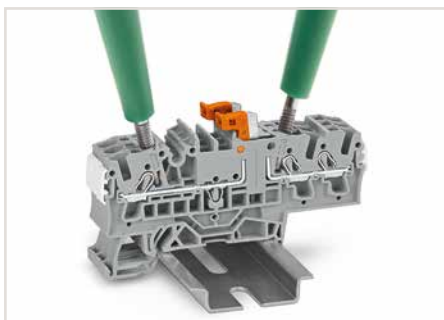

Disconnect/test terminal block with pivoting knife disconnect – testing with voltage tester.

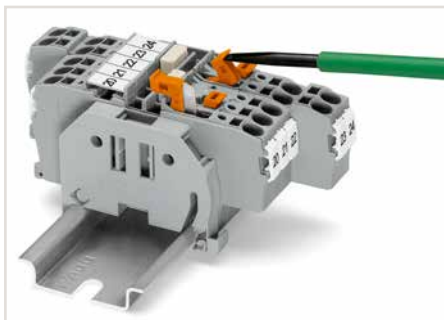

Disconnect/test terminal block with pivoting knife disconnect – opening a knife disconnect.



Disconnect/test terminal block with pivoting knife disconnect – closing the knife disconnect.

Disconnect/Test Terminal Block and Through Terminal Block of Same Profile TOPJOB® S 2.5 (4) mm²; 2002 Series

1

Technical Data	
0.25 ... 2.5 (4) mm ² ①	22 ... 12 AWG
400 V/6 kV/3 ②	300 V, 15 A ③
I _N 16 A	300 V, 10 A ④
Terminal block width: 5.2 mm / 0.205 inch	
10 ... 12 mm / 0.39 ... 0.47 inch	

Technical Data	
0.25 ... 2.5 (4) mm ² ①	22 ... 12 AWG
400 V/6 kV/3 ②	300 V, 15 A ③
I _N 16 A	300 V, 10 A ④
Terminal block width: 5.2 mm / 0.205 inch	
10 ... 12 mm / 0.39 ... 0.47 inch	

Technical Data	
0.25 ... 2.5 (4) mm ² ①	22 ... 12 AWG
400 V/6 kV/3 ②	300 V, 15 A ③
I _N 16 A	300 V, 10 A ④
Terminal block width: 5.2 mm / 0.205 inch	
10 ... 12 mm / 0.39 ... 0.47 inch	

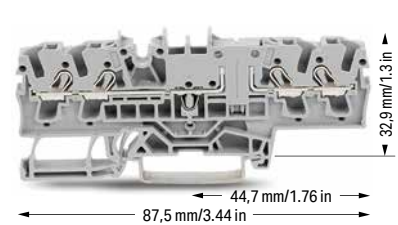
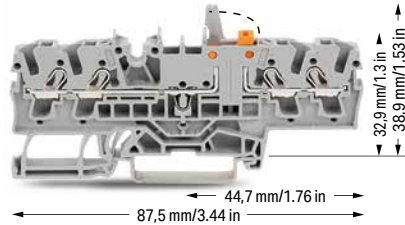
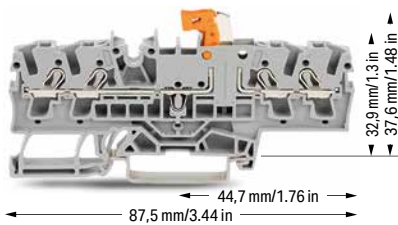

4-conductor disconnect/test terminal block; with test point; orange disconnect link

4-conductor disconnect/test terminal block; with mechanical interlock; with test point; orange disconnect link

4-conductor through terminal block; with test point; same profile as 4-conductor disconnect terminal block

Color	Item No.	Pack. Unit
gray ⑤	2002-1871 ⑥	50
blue ⑤	2002-1874 ⑥	50
orange ⑤	2002-1872 ⑥	50

Color	Item No.	Pack. Unit
gray ⑤	2002-1871/401-000 ⑥	50
blue ⑤	2002-1874/401-000 ⑥	50
orange ⑤	2002-1872/401-000 ⑥	50

Color	Item No.	Pack. Unit
gray ⑤	2002-1801 ⑥	50
blue ⑤	2002-1804 ⑥	50
orange ⑤	2002-1802 ⑥	50

Other terminal blocks with the same profile:

Carrier	2002-1861	Page 114
Fuse	2002-1881	Page 88

Accessories; 2002 Series

Appropriate marking systems: WMB/WMB Inline/Marking strips

End and intermediate plate; 1 mm thick			
orange	2002-1892	100 (25)	
gray	2002-1891	100 (25)	

Insulation stop; 5 pcs/strip; 0.25 ... 0.5 mm ²			
light gray	2002-171	200 (25)	

Insulation stop; 5 pcs/strip; 0.75 ... 1 mm ²			
dark gray	2002-172	200 (25)	

Protective warning marker; with black high-voltage symbol; for 5 terminal blocks			
yellow	2002-115	100 (25)	

Push-in type jumper bar; insulated; I _N 25 A; light gray			
2-way	2002-402	25	
3-way	2002-403	25	
4-way	2002-404	25	
5-way	2002-405	25	
6-way	2002-406	25	
7-way	2002-407	25	
8-way	2002-408	25	
9-way	2002-409	25	
10-way	2002-410	25	

Push-in type wire jumper; insulated; 1.5 mm ² conductor cross-section; I _N 18 A			
L = 60 mm	2009-412	100 (10)	
L = 110 mm	2009-414	100 (10)	
L = 250 mm	2009-416	100 (10)	

Push-in type jumper bar; insulated; I _N 25 A; light gray			
1 to 3	2002-433	25	
1 to 4	2002-434	25	
1 to 5	2002-435	25	
1 to 6	2002-436	25	
1 to 7	2002-437	25	
1 to 8	2002-438	25	
1 to 9	2002-439	25	
1 to 10	2002-440	25	

Delta jumper; insulated; I _N = I _N terminal block; light gray			
1-2 3-4 5-6	2002-406/020-000	25	

Star point jumper; insulated; I _N = I _N terminal block; light gray			
1-3-5	2002-405/011-000	25	

Staggered jumper; insulated; I _N 25 A; light gray			
2-way	2002-472	25	
3-way	2002-473	25	
4-way	2002-474	25	
5-way	2002-475	25	
6-way	2002-476	25	
7-way	2002-477	25	
8-way	2002-478	25	
9-way	2002-479	25	
10-way	2002-480	25	
11-way	2002-481	25	
12-way	2002-482	25	

Customized staggered jumper; insulated; with contact lugs broken off at the factory and circuit printing; I _N 25 A; light gray			
1-3	2002-473/011-000	25	
1-3-5	2002-475/011-000	25	
1-3-5-7	2002-477/011-000	25	
1-3-5-7-9	2002-479/011-000	25	
1-3-5-7-9-11	2002-481/011-000	25	

Adjacent jumper for continuous commoning; insulated; I _N 25 A; light gray			
2-way	2002-400	25	

Adjacent jumper for continuous commoning; insulated; I _N 25 A; 1 to 3			
light gray	2002-423	25	
red	2002-423/000-005	25	
blue	2002-423/000-006	25	

Modular connector; snaps together; for jumper contact slot			
gray	2002-511	100 (25)	

Spacer module; snaps together; bridges commoned terminal blocks			
gray	2002-549	100 (25)	

End plate; for modular connector; 1.5 mm thick			
gray	2002-541	100 (25)	

❶ Conductor range: 0.25 ... 4 mm² "s+f-st";
Push-in termination: 1 ... 4 mm² "s" and 1 ... 2.5 mm²
"insulated ferrules, 12 mm"
Depending on the conductor characteristic, a conductor with a smaller cross section can also be inserted via push-in termination.

❷ 400 V = rated voltage
6 kV = rated impulse voltage
3 = pollution degree
(see Section 14)

❸ Terminal blocks with an Ex mark are suitable for Ex ec IIc applications.
(see Section 14)

Please observe the application notes:
Jumpers, from page 152
Testing accessories, from page 146
Marking, from page 588

Approvals and corresponding ratings,
visit www.wago.com

Accessories; 2002 Series

Appropriate marking systems:
WMB/WMB Inline/Marking strips

L-type test plug module; snaps together



gray 2002-611 100 (25)

L-type spacer module; snaps together; bridges commoned terminal blocks



gray 2002-649 100 (25)

End plate; for modular test plug module; 1.5 mm thick



gray 2002-641 100 (25)

Test plug adapter; for 4 mm Ø test plug



gray 2009-174 100 (25)

Banana plug; for 4 mm socket diameter; color mixed; 10 x orange, white, black, blue, yellow; max. 42 V



215-111 50

Testing tap; for max. 2.5 mm²



gray 2009-182 100 (25)

WMB Inline, plain; 1,500 WMB markers (5 mm)/reel; 5 ... 5.2 mm stretchable



white 2009-115 1

Marking strip; plain; 11 mm wide; 50 m reel



white 2009-110 1

WMB marking card; white; 10 strips with 10 markers/card; 5 ... 5.2 mm stretchable



plain 793-5501 5

Double-deck marker carrier; pivoting



gray 2002-121 50 (25)

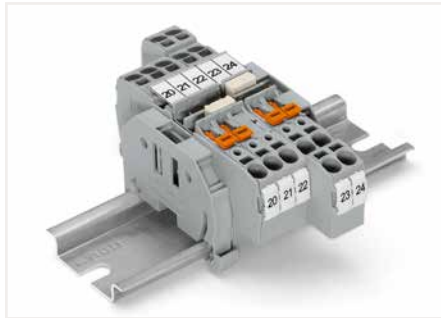

Through Terminal Blocks and Disconnect/Test Terminal Blocks

- One center and two side marker slots for WMB markers or marking strips
- Dual jumper slots in the same location as other 2002 Series terminal blocks
- Commoning options in front of or behind the knife disconnect, depending on the power supply direction



Disconnect/test terminal block with pivoting knife disconnect and mechanical interlock – knife disconnect in open position



Disconnect/test terminal block with pivoting knife disconnect and mechanical interlock – top view

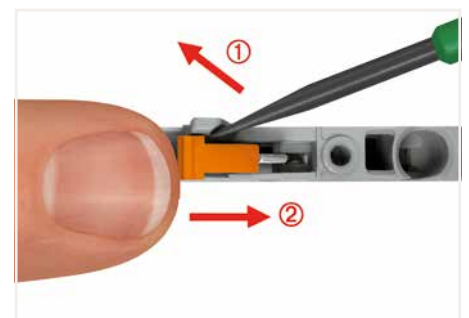

Disconnect/test terminal block with pivoting knife disconnect and mechanical interlock – closing the knife disconnect.

Sold & Serviced By:

ELECTROMATE

Toll Free Phone (877) SERV098

www.electromate.com

sales@electromate.com

Fuse Terminal Block TOPJOB® S; for Mini-Automotive Blade-Style Fuses

2.5 (4) mm²; 2002 Series

1

Technical Data

0.25 ... 2.5 (4) mm ² ❶	22 ... 12 AWG
400 V/6 kV/3 ❷	300 V, 10 A ❸
I _N 10 A ❸	300 V, 10 A ❸
Terminal block width: 5.2 mm / 0.205 inch	
10 ... 12 mm / 0.39 ... 0.47 inch	

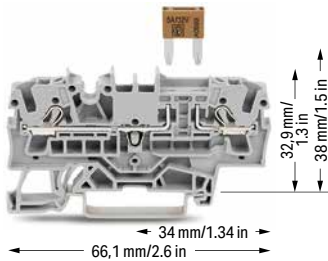

2-conductor fuse terminal block; with test point; for mini-automotive blade-style fuses

Color	Item No.	Pack. Unit
gray ❹	2002-1681 ❹	50

Blade-style fuses are not offered by WAGO.

Other terminal blocks with the same profile:

Through	2002-1601	Page 82
---------	-----------	---------

Accessories; item-specific

End and intermediate plate; 1 mm thick

orange	2002-1692	100 (25)
gray	2002-1691	100 (25)

Technical Data

0.25 ... 2.5 (4) mm ² ❶	22 ... 12 AWG
400 V/6 kV/3 ❷	300 V, 10 A ❸
I _N 10 A ❸	300 V, 10 A ❸
Terminal block width: 5.2 mm / 0.205 inch	
10 ... 12 mm / 0.39 ... 0.47 inch	

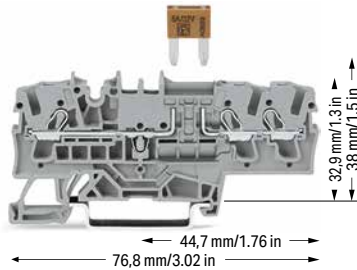

3-conductor fuse terminal block; with test point; for mini-automotive blade-style fuses

Color	Item No.	Pack. Unit
gray ❹	2002-1781 ❹	50

Blade-style fuses are not offered by WAGO.

Other terminal blocks with the same profile:

Through	2002-1701	Page 84
---------	-----------	---------

Accessories; item-specific

End and intermediate plate; 1 mm thick

orange	2002-1792	100 (25)
gray	2002-1791	100 (25)

Technical Data

0.25 ... 2.5 (4) mm ² ❶	22 ... 12 AWG
400 V/6 kV/3 ❷	300 V, 10 A ❸
I _N 10 A ❸	300 V, 10 A ❸
Terminal block width: 5.2 mm / 0.205 inch	
10 ... 12 mm / 0.39 ... 0.47 inch	

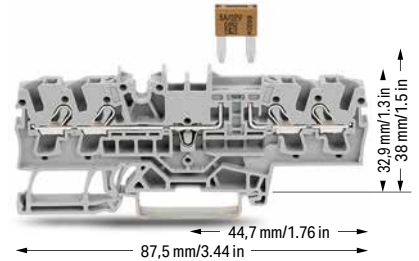

4-conductor fuse terminal block; with test point; for mini-automotive blade-style fuses

Color	Item No.	Pack. Unit
gray ❹	2002-1881 ❹	100

Blade-style fuses are not offered by WAGO.

Other terminal blocks with the same profile:

Through	2002-1801	Page 86
---------	-----------	---------

Accessories; item-specific

End and intermediate plate; 1 mm thick

orange	2002-1892	100 (25)
gray	2002-1891	100 (25)

Accessories; 2002 Series

Appropriate marking systems: WMB/WMB Inline/Marking strips

Insulation stop; 5 pcs/strip; 0.25 ... 0.5 mm²

light gray	2002-171	200 (25)
------------	----------	----------



Insulation stop; 5 pcs/strip; 0.75 ... 1 mm²

dark gray	2002-172	200 (25)
-----------	----------	----------



Protective warning marker; with black high-voltage symbol; for 5 terminal blocks

yellow	2002-115	100 (25)
--------	----------	----------



Push-in type jumper bar; insulated; I_N 25 A; light gray

2-way	2002-402	25
3-way	2002-403	25
4-way	2002-404	25
5-way	2002-405	25
6-way	2002-406	25
7-way	2002-407	25
8-way	2002-408	25
9-way	2002-409	25
10-way	2002-410	25



Push-in type wire jumper; insulated; 1.5 mm² conductor cross-section; I_N 18 A

L = 60 mm	2009-412	100 (10)
L = 110 mm	2009-414	100 (10)
L = 250 mm	2009-416	100 (10)



Push-in type jumper bar; insulated; I_N 25 A; light gray

1 to 3	2002-433	25
1 to 4	2002-434	25
1 to 5	2002-435	25
1 to 6	2002-436	25
1 to 7	2002-437	25
1 to 8	2002-438	25
1 to 9	2002-439	25
1 to 10	2002-440	25



Delta jumper; insulated; I_N = I_N terminal block; light gray

1-2 3-4 5-6	2002-406/020-000	25
-------------	------------------	----



Star point jumper; insulated; I_N = I_N terminal block; light gray

1-3-5	2002-405/011-000	25
-------	------------------	----



Staggered jumper; insulated; I_N 25 A; light gray

2-way	2002-472	25
3-way	2002-473	25
4-way	2002-474	25
5-way	2002-475	25
6-way	2002-476	25
7-way	2002-477	25
8-way	2002-478	25
9-way	2002-479	25
10-way	2002-480	25
11-way	2002-481	25
12-way	2002-482	25



Customized staggered jumper; insulated; with contact lugs broken off at the factory and circuit printing; I_N 25 A; light gray

1-3	2002-473/011-000	25
1-3-5	2002-475/011-000	25
1-3-5-7	2002-477/011-000	25
1-3-5-7-9	2002-479/011-000	25
1-3-5-7-9-11	2002-481/011-000	25

Adjacent jumper for continuous commoning; insulated; I_N 25 A; light gray

2-way	2002-400	25
-------	----------	----



Adjacent jumper for continuous commoning; insulated; I_N 25 A; 1 to 3

light gray	2002-423	25
red	2002-423/000-005	25
blue	2002-423/000-006	25



Modular connector; snaps together; for jumper contact slot

gray	2002-511	100 (25)
------	----------	----------



Spacer module; snaps together; bridges commoned terminal blocks

gray	2002-549	100 (25)
------	----------	----------



- ❶ Conductor range: 0.25 ... 4 mm² "s+f-st";
Push-in termination: 1 ... 4 mm² "s" and 1 ... 2.5 mm²
"insulated ferrules, 12 mm"
Depending on the conductor characteristic, a conductor with a smaller cross section can also be inserted via push-in termination.
- ❷ 400 V = rated voltage
6 kV = rated impulse voltage
3 = pollution degree
(see Section 14)
- ❸ Observe touch-proof protection for 42 V and higher voltages!
 - 10 A (individual arrangement)
 - 5 A (block arrangement)
- ❹ Terminal blocks with an Ex mark are suitable for Ex ec IIc applications.
(see Section 14)

Please observe the application notes:
Jumpers, from page 152
Testing accessories, from page 146
Marking, from page 588

Approvals and corresponding ratings,
visit www.wago.com

Accessories; 2002 Series

Appropriate marking systems:
WMB/WMB Inline/Marking strips

L-type test plug module; snaps together



gray 2002-611 100 (25)

L-type spacer module; snaps together; bridges commoned terminal blocks



gray 2002-649 100 (25)

Test plug adapter; for 4 mm Ø test plug



gray 2009-174 100 (25)

Banana plug; for 4 mm socket diameter; color mixed; 10 x orange, white, black, blue, yellow; max. 42 V



215-111 50

Testing tap; for max. 2.5 mm²



gray 2009-182 100 (25)

WMB Inline, plain; 1,500 WMB markers (5 mm)/reel; 5 ... 5.2 mm stretchable



white 2009-115 1

Marking strip; plain; 11 mm wide; 50 m reel



white 2009-110 1

WMB marking card; white; 10 strips with 10 markers/card; 5 ... 5.2 mm stretchable



plain 793-5501 5

Double-deck marker carrier; pivoting



gray 2002-121 50 (25)



Selecting the correct fuse cartridge is important for product safety within applications, as well as for fuse cartridge service life and reliability. Fuse cartridges can operate perfectly as protection (break-off point) if they are properly selected and used according to manufacturer specifications.

Nominal current ratings for fuse cartridges are defined differently in international standards.

This is why the recommended continuous current-carrying capacity of the fuses is a max. 80% of their nominal current according to DIN 72581/Part 3 (for a surrounding air temperature of 23°C).

With regard to product safety, fuse cartridges must generally be tested both under normal and faulty operating conditions within your application.

Fused Disconnect Terminal Block with Pivoting Fuse Holder TOPJOB® S; for 5 x 20 mm Glass Cartridge Fuse

2.5 (4) mm²; 2002 Series

1

Technical Data	
0.25 ... 2.5 (4) mm ² ①	22 ... 12 AWG
250 V/6 kV/3 ②	250 V, 6.3 A ③
I _N 6.3 A	250 V, 6.3 A ④
Terminal block width: 6.2 mm / 0.244 inch	
10 ... 12 mm / 0.39 ... 0.47 inch	

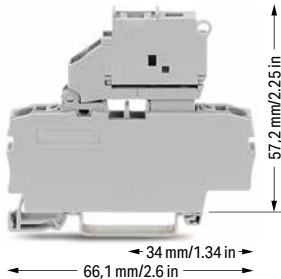

2-conductor fused disconnect terminal block with a pivoting fuse holder; for 5 x 20 mm glass cartridge fuse; without blown fuse indication Electrical ratings are given by the fuse.		
Item No.	Pack. Unit	
gray ⑤	2002-1611 ⑥	50

2-conductor fused disconnect terminal block with a pivoting fuse holder; for 5 x 20 mm glass cartridge fuse; with blown fuse indication by LED; gray Electrical ratings are given by the fuse and blown fuse indication. Leakage current in case of a blown fuse: LED 2 mA		
12 ... 30 V ⑤	2002-1611/1000-541 ⑥	50
30 ... 65 V ⑤	2002-1611/1000-542 ⑥	50
230 V ⑤	2002-1611/1000-836 ⑥	50
120 V ⑤	2002-1611/1000-867 ⑥	50

Other terminal blocks with the same profile:		
Through	2002-1601	Page 82

Technical Data	
0.25 ... 2.5 (4) mm ² ①	22 ... 12 AWG
250 V/6 kV/3 ②	250 V, 6.3 A ③
I _N 6.3 A	250 V, 6.3 A ④
Terminal block width: 6.2 mm / 0.244 inch	
10 ... 12 mm / 0.39 ... 0.47 inch	

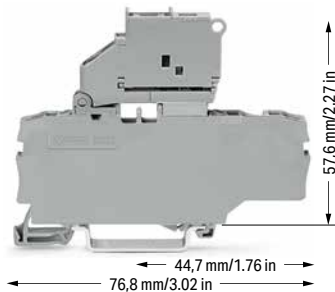

3-conductor fused disconnect terminal block with a pivoting fuse holder; for 5 x 20 mm glass cartridge fuse; without blown fuse indication Electrical ratings are given by the fuse.		
Item No.	Pack. Unit	
gray ⑤	2002-1711 ⑥	50

3-conductor fused disconnect terminal block with a pivoting fuse holder; for 5 x 20 mm glass cartridge fuse; with blown fuse indication by LED; gray Electrical ratings are given by the fuse and blown fuse indication. Leakage current in case of a blown fuse: LED 2 mA		
12 ... 30 V ⑤	2002-1711/1000-541 ⑥	50
30 ... 65 V ⑤	2002-1711/1000-542 ⑥	50
230 V ⑤	2002-1711/1000-836 ⑥	50
120 V ⑤	2002-1711/1000-867 ⑥	50

Other terminal blocks with the same profile:		
Through	2002-1701	Page 84

Technical Data	
0.25 ... 2.5 (4) mm ² ①	22 ... 12 AWG
250 V/6 kV/3 ②	250 V, 6.3 A ③
I _N 6.3 A	250 V, 6.3 A ④
Terminal block width: 6.2 mm / 0.244 inch	
10 ... 12 mm / 0.39 ... 0.47 inch	



4-conductor fused disconnect terminal block with a pivoting fuse holder; for 5 x 20 mm glass cartridge fuse; without blown fuse indication Electrical ratings are given by the fuse.		
Item No.	Pack. Unit	
gray ⑤	2002-1811 ⑥	100

4-conductor fused disconnect terminal block with a pivoting fuse holder; for 5 x 20 mm glass cartridge fuse; with blown fuse indication by LED; gray Electrical ratings are given by the fuse and blown fuse indication. Leakage current in case of a blown fuse: LED 2 mA		
12 ... 30 V ⑤	2002-1811/1000-541 ⑥	50
30 ... 65 V ⑤	2002-1811/1000-542 ⑥	50
230 V ⑤	2002-1811/1000-836 ⑥	50
120 V ⑤	2002-1811/1000-867 ⑥	50

Other terminal blocks with the same profile:		
Through	2002-1801	Page 86

Accessories; 2002 Series

Appropriate marking systems: WMB/WMB Inline/Marking strips

End plate for fuse terminal blocks; 2 mm thick			
orange	2002-992	100 (25)	
gray	2002-991	100 (25)	

Insulation stop; 5 pcs/strip; 0.25 ... 0.5 mm ²			
light gray	2002-171	200 (25)	

Insulation stop; 5 pcs/strip; 0.75 ... 1 mm ²			
dark gray	2002-172	200 (25)	

Protective warning marker; with black high-voltage symbol; for 5 terminal blocks			
yellow	2002-115	100 (25)	

Push-in type wire jumper; insulated; 1.5 mm ² conductor cross-section; I _N 18 A			
L = 60 mm	2009-412	100 (10)	
L = 110 mm	2009-414	100 (10)	
L = 250 mm	2009-416	100 (10)	

Push-in type jumper bar; insulated; I _N 32 A; light gray			
2-way	2004-402	25	
3-way	2004-403	25	
4-way	2004-404	25	
5-way	2004-405	25	
6-way	2004-406	25	
7-way	2004-407	25	
8-way	2004-408	25	
9-way	2004-409	25	
10-way	2004-410	25	

Push-in type jumper bar; insulated; I _N 32 A; light gray			
1 to 3	2004-433	25	
1 to 4	2004-434	25	
1 to 5	2004-435	25	
1 to 6	2004-436	25	
1 to 7	2004-437	25	
1 to 8	2004-438	25	
1 to 9	2004-439	25	
1 to 10	2004-440	25	

- ❶ Conductor range: 0.25 ... 4 mm² "s+f-st";
Push-in termination: 1 ... 4 mm² "s" and 1 ... 2.5 mm²
"insulated ferrules, 12 mm"
Depending on the conductor characteristic, a conductor with a smaller cross section can also be inserted via push-in termination.
- ❷ 250 V = rated voltage
6 kV = rated impulse voltage
3 = pollution degree
(see Section 14)
- ❸ Terminal blocks with an Ex mark are suitable for Ex ec IIc applications.
(see Section 14)

Please observe the application notes:
Jumpers, from page 156
Marking, from page 588

A protective warning marker and an insulation stop must be applied individually. Due to the 6.2 mm width of fused disconnect terminal blocks with end plates, 2004 Series Push-In Type Jumper Bars must be used.

Approvals and corresponding ratings,
visit www.wago.com



Fuse terminal blocks with a width of 6.2 mm can be assembled adjacently. If there is no adjacent fuse terminal block at the end of the assembly, an end plate must be used.

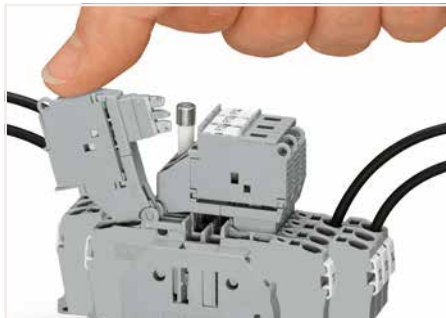

Fused disconnect terminal block with a pivoting fuse holder – pivoting the fuse holder into the locked open position.

Glass cartridge fuse 5 x 20

Series Item No.	Overload and short circuit protection		Short circuit protection only	
	Individual argmt.	Group argmt.	Individual argmt.	Group argmt.
Fuse terminal blocks				
2002-1611				
2002-1711	1.6 W	1.6 W	2.5 W	2.5 W
2002-1811				
2002-1611/.....				
2002-1711/.....	1.6 W	1.6 W	2.5 W	2.5 W
2002-1811/.....				

When selecting glass cartridge fuses, make sure that the maximum power loss listed below is not exceeded. The power loss is determined according to IEC or EN 60947-7-3/VDE 0611-6 at 23°C. The temperature rise of the terminal blocks must be checked according to their application and mounting. Higher ambient temperatures represent an additional impact on fuse cartridges. Therefore, in such applications, the rated current must be reduced if necessary. More details are available from the manufacturers.



Fused disconnect terminal block with a pivoting fuse holder – fuse replacement: Open the cover to replace the fuse.

Disconnect/Test Terminal Block and Through/Ground Terminal Block TOPJOB® S; with Additional Jumper Slot 2.5 (4) mm²; 2002 Series

1

Technical Data	
0.25 ... 2.5 (4) mm ² ①	22 ... 12 AWG
400 V/6 kV/3 ②	300 V, 15 A ③
I _N 16 A	
Terminal block width: 5.2 mm / 0.205 inch	
10 ... 12 mm / 0.39 ... 0.47 inch	

Technical Data	
0.25 ... 2.5 (4) mm ² ①	22 ... 12 AWG
400 V/6 kV/3 ②	300 V, 15 A ③
I _N 16 A	
Terminal block width: 5.2 mm / 0.205 inch	
10 ... 12 mm / 0.39 ... 0.47 inch	

Technical Data	
0.25 ... 2.5 (4) mm ² ①	22 ... 12 AWG
400 V/6 kV/3 ②	300 V, 15 A ③
I _N 16 A	
Terminal block width: 5.2 mm / 0.205 inch	
10 ... 12 mm / 0.39 ... 0.47 inch	

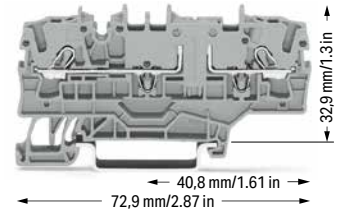
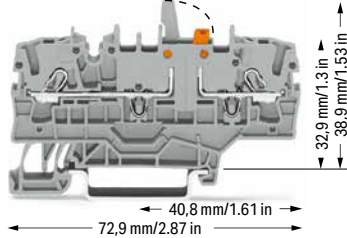
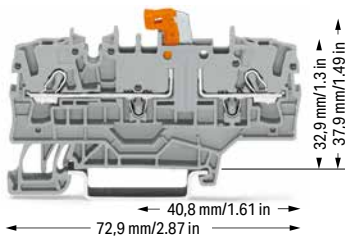

2-conductor disconnect/test terminal block; with test point; orange disconnect link; with additional jumper slot

Color	Item No.	Pack. Unit
gray ④	2002-1971 ⑤	50
blue ④	2002-1974 ⑤	50
orange ④	2002-1972 ⑤	50

2-conductor disconnect/test terminal block; with mechanical interlock; with test point; orange disconnect link; with additional jumper slot

Color	Item No.	Pack. Unit
gray ④	2002-1971/401-000 ⑤	50
blue ④	2002-1974/401-000 ⑤	50
orange ④	2002-1972/401-000 ⑤	50

2-conductor through terminal block; with test point; with additional jumper slot; same profile as 2-conductor disconnect terminal block

Color	Item No.	Pack. Unit
gray ④	2002-1901 ⑤	50
blue ④	2002-1904 ⑤	50
orange ④	2002-1902 ⑤	50

2-conductor ground terminal block		
green-yellow ④	2002-1907 ⑤	50

Other terminal blocks with the same profile:		
Carrier	2002-1961	Page 114
Fuse	2002-1981	Page 94

Accessories; 2002 Series

Appropriate marking systems: WMB/WMB Inline/Marking strips

End and intermediate plate; 1 mm thick

orange	2002-1992	100 (25)
gray	2002-1991	100 (25)

Insulation stop; 5 pcs/strip; 0.25 ... 0.5 mm²

light gray	2002-171	200 (25)
------------	----------	----------

Insulation stop; 5 pcs/strip; 0.75 ... 1 mm²

dark gray	2002-172	200 (25)
-----------	----------	----------

Protective warning marker; with black high-voltage symbol; for 5 terminal blocks

yellow	2002-115	100 (25)
--------	----------	----------

Push-in type jumper bar; insulated; I_N 25 A; light gray

2-way	2002-402	25
3-way	2002-403	25
4-way	2002-404	25
5-way	2002-405	25
6-way	2002-406	25
7-way	2002-407	25
8-way	2002-408	25
9-way	2002-409	25
10-way	2002-410	25

Push-in type wire jumper; insulated; 1.5 mm² conductor cross-section; I_N 18 A

L = 60 mm	2009-412	100 (10)
L = 110 mm	2009-414	100 (10)
L = 250 mm	2009-416	100 (10)

Push-in type jumper bar; insulated; I_N 25 A; light gray

1 to 3	2002-433	25
1 to 4	2002-434	25
1 to 5	2002-435	25
1 to 6	2002-436	25
1 to 7	2002-437	25
1 to 8	2002-438	25
1 to 9	2002-439	25
1 to 10	2002-440	25

Delta jumper; insulated; I_N = I_N terminal block; light gray

1-2 3-4 5-6	2002-406/020-000	25
-------------	------------------	----

Star point jumper; insulated; I_N = I_N terminal block; light gray

1-3-5	2002-405/011-000	25
-------	------------------	----

Staggered jumper; insulated; I_N 25 A; light gray

2-way	2002-472	25
3-way	2002-473	25
4-way	2002-474	25
5-way	2002-475	25
6-way	2002-476	25
7-way	2002-477	25
8-way	2002-478	25
9-way	2002-479	25
10-way	2002-480	25
11-way	2002-481	25
12-way	2002-482	25

Customized staggered jumper; insulated; with contact lugs broken off at the factory and circuit printing; I_N 25 A; light gray

1-3	2002-473/011-000	25
1-3-5	2002-475/011-000	25
1-3-5-7	2002-477/011-000	25
1-3-5-7-9	2002-479/011-000	25
1-3-5-7-9-11	2002-481/011-000	25

Adjacent jumper for continuous commoning; insulated; I_N 25 A; light gray

2-way	2002-400	25
-------	----------	----

Adjacent jumper for continuous commoning; insulated; I_N 25 A; 1 to 3

light gray	2002-423	25
red	2002-423/000-005	25
blue	2002-423/000-006	25

Modular connector; snaps together; for jumper contact slot

gray	2002-511	100 (25)
------	----------	----------

End plate; for modular connector; 1.5 mm thick

gray	2002-541	100 (25)
------	----------	----------

❶ Conductor range: 0.25 ... 4 mm² "s+f-st"; Push-in termination: 1 ... 4 mm² "s" and 1 ... 2.5 mm² "insulated ferrules, 12 mm"
Depending on the conductor characteristic, a conductor with a smaller cross section can also be inserted via push-in termination.

❷ 400 V = rated voltage
6 kV = rated impulse voltage
3 = pollution degree
(see Section 14)

❸ Terminal blocks with an Ex mark are suitable for Ex ec IIc applications.
(see Section 14)

Please observe the application notes:
Jumpers, from page 152
Testing accessories, from page 146
Marking, from page 588

Approvals and corresponding ratings,
visit www.wago.com

Accessories; 2002 Series

Appropriate marking systems:
WMB/WMB Inline/Marking strips

L-type test plug module; snaps together

	gray	2002-611	100 (25)
---	------	----------	----------

L-type spacer module; snaps together; bridges commoned terminal blocks

	gray	2002-649	100 (25)
---	------	----------	----------

End plate; for modular test plug module; 1.5 mm thick

	gray	2002-641	100 (25)
---	------	----------	----------

Test plug adapter; for 4 mm Ø test plug

	gray	2009-174	100 (25)
---	------	----------	----------

Banana plug; for 4 mm socket diameter; color mixed; 10 x orange, white, black, blue, yellow; max. 42 V

		215-111	50
---	--	---------	----

Testing tap; for max. 2.5 mm²

	gray	2009-182	100 (25)
---	------	----------	----------

WMB Inline, plain; 1,500 WMB markers (5 mm)/reel; 5 ... 5.2 mm stretchable

	white	2009-115	1
---	-------	----------	---

Marking strip; plain; 11 mm wide; 50 m reel

	white	2009-110	1
---	-------	----------	---

WMB marking card; white; 10 strips with 10 markers/card; 5 ... 5.2 mm stretchable

	plain	793-5501	5
---	-------	----------	---

Double-deck marker carrier; pivoting

	gray	2002-121	50 (25)
---	------	----------	---------

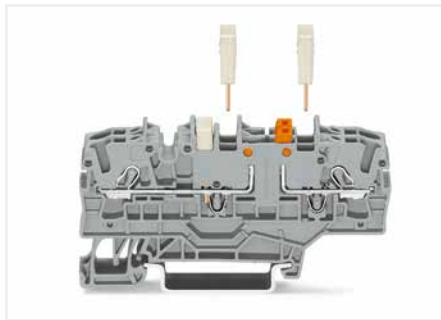

Three jumper slots available



2-conductor carrier terminal block with additional jumper slot (2002-1961)



Disconnect/test terminal block with pivoting knife disconnect and mechanical interlock – knife disconnect in open position



Disconnect/test terminal block with pivoting knife disconnect and mechanical interlock – top view

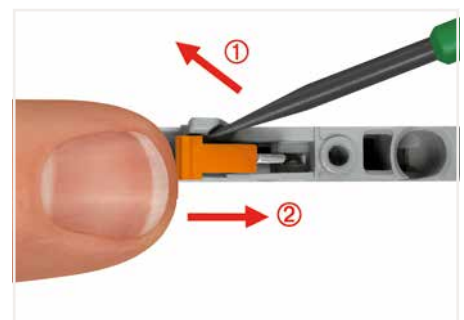

Disconnect/test terminal block with pivoting knife disconnect and mechanical interlock – closing the knife disconnect.

Fuse Terminal Block TOPJOB® S; for Mini-Automotive Blade-Style Fuses; with Additional Jumper Slot

2.5 (4) mm²; 2002 Series

1

Technical Data	
0.25 ... 2.5 (4) mm ² ①	22 ... 12 AWG
400 V/6 kV/3 ②	12 V, 10 A ③
I _N 10 A ③	
Terminal block width: 5.2 mm / 0.205 inch	
10 ... 12 mm / 0.39 ... 0.47 inch	

Technical Data	
0.25 ... 2.5 (4) mm ² ①	22 ... 12 AWG
400 V/6 kV/3 ②	24 V, 10 A ③
I _N 10 A ③	
Terminal block width: 5.2 mm / 0.205 inch	
10 ... 12 mm / 0.39 ... 0.47 inch	

Technical Data	
0.25 ... 2.5 (4) mm ² ①	22 ... 12 AWG
400 V/6 kV/3 ②	48 V, 10 A ③
I _N 10 A ③	
Terminal block width: 5.2 mm / 0.205 inch	
10 ... 12 mm / 0.39 ... 0.47 inch	

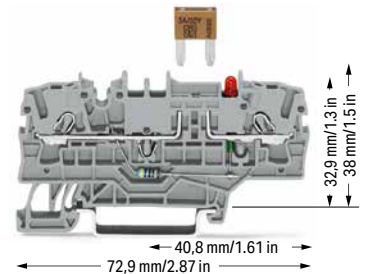
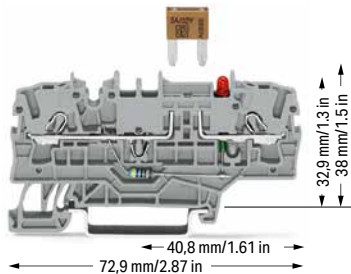
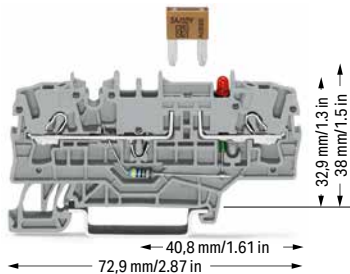

2002-1981/1000-429

2002-1981/1000-449

2002-1981/1000-413

2002-1981/1000-434

2002-1981/1000-414

2002-1981/1000-435

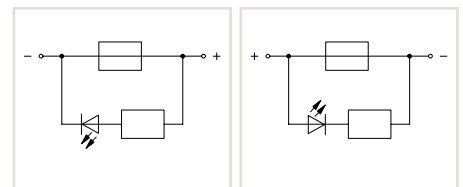
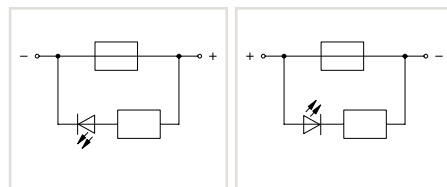
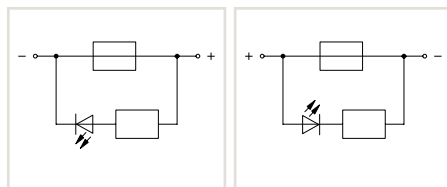

2-conductor fuse terminal block; with test point; for mini-automotive blade-style fuses; 12 V; with blown fuse indication by LED; LED power consumption: 4.8 mA Electrical ratings are given by the fuse and blown fuse indication. Blade-style fuses: Observe touch-proof protection for 42 V and higher voltages!

2-conductor fuse terminal block; with test point; for mini-automotive blade-style fuses; 24 V; with blown fuse indication by LED; LED power consumption: 4.8 mA Electrical ratings are given by the fuse and blown fuse indication. Blade-style fuses: Observe touch-proof protection for 42 V and higher voltages!

2-conductor fuse terminal block; with test point; for mini-automotive blade-style fuses; 48 V; with blown fuse indication by LED; LED power consumption: 4.8 mA Electrical ratings are given by the fuse and blown fuse indication. Blade-style fuses: Observe touch-proof protection for 42 V and higher voltages!

Color	Item No.	Pack. Unit
gray ④	2002-1981/1000-429 ④	50
gray ④	2002-1981/1000-449 ④	50

Color	Item No.	Pack. Unit
gray ④	2002-1981/1000-413 ④	50
gray ④	2002-1981/1000-434 ④	50

Color	Item No.	Pack. Unit
gray ④	2002-1981/1000-414 ④	50
gray ④	2002-1981/1000-435 ④	50

Other terminal blocks with the same profile:
Through 2002-1901 Page 92

Accessories; 2002 Series

Appropriate marking systems: WMB/WMB Inline/Marking strips

End and intermediate plate; 1 mm thick		
orange	2002-1992	100 (25)
gray	2002-1991	100 (25)

Insulation stop; 5 pcs/strip; 0.25 ... 0.5 mm ²		
light gray	2002-171	200 (25)

Insulation stop; 5 pcs/strip; 0.75 ... 1 mm ²		
dark gray	2002-172	200 (25)

Protective warning marker; with black high-voltage symbol; for 5 terminal blocks		
yellow	2002-115	100 (25)

Push-in type wire jumper; insulated; 1.5 mm ² conductor cross-section; I _N 18 A		
L = 60 mm	2009-412	100 (10)
L = 110 mm	2009-414	100 (10)
L = 250 mm	2009-416	100 (10)

Push-in type jumper bar; insulated; I _N 25 A; light gray		
2-way	2002-402	25
3-way	2002-403	25
4-way	2002-404	25
5-way	2002-405	25
6-way	2002-406	25
7-way	2002-407	25
8-way	2002-408	25
9-way	2002-409	25
10-way	2002-410	25

Push-in type jumper bar; insulated; I _N 25 A; light gray		
1 to 3	2002-433	25
1 to 4	2002-434	25
1 to 5	2002-435	25
1 to 6	2002-436	25
1 to 7	2002-437	25
1 to 8	2002-438	25
1 to 9	2002-439	25
1 to 10	2002-440	25

Staggered jumper; insulated; I _N 25 A; light gray		
2-way	2002-472	25
3-way	2002-473	25
4-way	2002-474	25
5-way	2002-475	25
6-way	2002-476	25
7-way	2002-477	25
8-way	2002-478	25
9-way	2002-479	25
10-way	2002-480	25
11-way	2002-481	25
12-way	2002-482	25

Adjacent jumper for continuous commoning; insulated; I _N 25 A; light gray		
2-way	2002-400	25

Adjacent jumper for continuous commoning; insulated; I _N 25 A; 1 to 3		
light gray	2002-423	25
red	2002-423/000-005	25
blue	2002-423/000-006	25

Technical Data

0.25 ... 2.5 (4) mm ² ❶	22 ... 12 AWG
400 V/6 kV/3 ❷	250 V, 10 A ❸
I_N 10 A ❸	
Terminal block width: 5.2 mm / 0.205 inch	
10 ... 12 mm / 0.39 ... 0.47 inch	

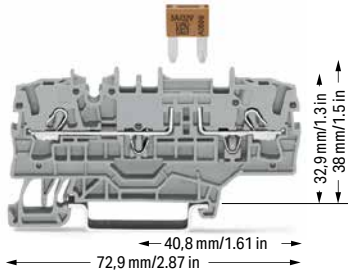

- ❶ Conductor range: 0.25 ... 4 mm² "s+f-st"; Push-in termination: 1 ... 4 mm² "s" and 1 ... 2.5 mm² "insulated ferrules, 12 mm"
Depending on the conductor characteristic, a conductor with a smaller cross section can also be inserted via push-in termination.
- ❷ 400 V = rated voltage
6 kV = rated impulse voltage
3 = pollution degree (see Section 14)
- ❸ Observe touch-proof protection for 42 V and higher voltages!
10 A (individual arrangement)
5 A (block arrangement)
- ❹ Terminal blocks with an Ex mark are suitable for Ex ec llc applications. (see Section 14)

Blade-style fuses are not offered by WAGO.

Please observe the application notes:
Jumpers, from page 152
Testing accessories, from page 146
Marking, from page 588

Approvals and corresponding ratings, visit www.wago.com



Selecting the correct fuse cartridge is important for product safety within applications, as well as for fuse cartridge service life and reliability. Fuse cartridges can operate perfectly as protection (break-off point) if they are properly selected and used according to manufacturer specifications. Nominal current ratings for fuse cartridges are defined differently in international standards. This is why the recommended continuous current-carrying capacity of the fuses is a max. 80% of their nominal current according to DIN 72581/Part 3 (for a surrounding air temperature of 23°C). With regard to product safety, fuse cartridges must generally be tested both under normal and faulty operating conditions within your application.

2-conductor fuse terminal block; with test point; for mini-automotive blade-style fuses; without blown fuse indication; with additional jumper slot
Electrical ratings are given by the fuse. Blade-style fuses: Observe touch-proof protection for 42 V and higher voltages!

Color	Item No.	Pack. Unit
○ gray ⑤	2002-1981 ❹	50

WMB Inline, plain; 1,500 WMB markers (5 mm)/reel; 5 ... 5.2 mm stretchable

white	2009-115	1
-------	----------	---

Marking strip; plain; 11 mm wide; 50 m reel

white	2009-110	1
-------	----------	---

WMB marking card; white; 10 strips with 10 markers/card; 5 ... 5.2 mm stretchable

plain	793-5501	5
-------	----------	---

Double-deck marker carrier; pivoting

gray	2002-121	50 (25)
------	----------	---------

PUSH-IN CAGE CLAMP®

Fused Disconnect Terminal Block with Pivoting Fuse Holder TOPJOB® S; with Additional Jumper Slot; for 5 x 20 mm Glass Cartridge Fuse 2.5 (4) mm²; 2002 Series

1

Technical Data	
0.25 ... 2.5 (4) mm ² ①	22 ... 12 AWG
250 V/6 kV/3 ②	600 V, 6.3 A ③
I _N 6.3 A	
Terminal block width: 6.2 mm / 0.244 inch	
10 ... 12 mm / 0.39 ... 0.47 inch	

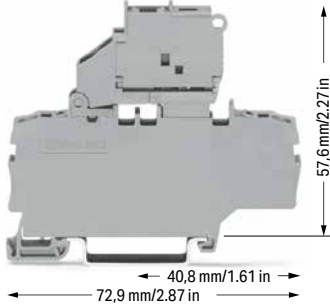

2-conductor fused disconnect terminal block with a pivoting fuse holder; with additional jumper slot; for 5 x 20 mm glass cartridge fuse; without blown fuse indication
Electrical ratings are given by the fuse.

Color	Item No.	Pack. Unit
gray ④	2002-1911 ⑤	50

Other terminal blocks with the same profile:		
Through	2002-1901	Page 92

Accessories; 2002 Series

Appropriate marking systems: WMB/WMB Inline/Marking strips

End plate for fuse terminal blocks; 2 mm thick

	orange	2002-992	100 (25)
	gray	2002-991	100 (25)

Insulation stop; 5 pcs/strip; 0.25 ... 0.5 mm²

	light gray	2002-171	200 (25)
--	------------	----------	----------

Insulation stop; 5 pcs/strip; 0.75 ... 1 mm²

	dark gray	2002-172	200 (25)
--	-----------	----------	----------

Protective warning marker; with black high-voltage symbol; for 5 terminal blocks

	yellow	2002-115	100 (25)
--	--------	----------	----------

Push-in type wire jumper; insulated; 1.5 mm² conductor cross-section; I_N 18 A

	L = 60 mm	2009-412	100 (10)
	L = 110 mm	2009-414	100 (10)
	L = 250 mm	2009-416	100 (10)

Technical Data	
0.25 ... 2.5 (4) mm ² ①	22 ... 12 AWG
250 V/6 kV/3 ②	30 V, 6.3 A ③
I _N 6.3 A	
Terminal block width: 6.2 mm / 0.244 inch	
10 ... 12 mm / 0.39 ... 0.47 inch	

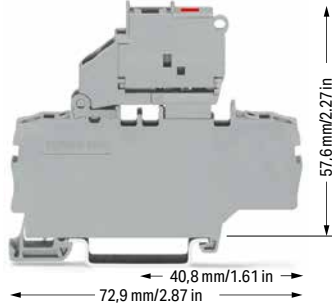

2-conductor fused disconnect terminal block with a pivoting fuse holder; with additional jumper slot; for 5 x 20 mm glass cartridge fuse; with blown fuse indication by LED; gray
Electrical ratings are given by the fuse and blown fuse indication. Leakage current in case of a blown fuse: LED 2 mA

	Item No.	Pack. Unit
12 ... 30 V ④	2002-1911/1000-541 ⑤	50
30 ... 65 V ④	2002-1911/1000-542 ⑤	50
120 V ④	2002-1911/1000-867 ⑤	50
230 V ④	2002-1911/1000-836 ⑤	50

Other terminal blocks with the same profile:		
Through	2002-1901	Page 92

Push-in type jumper bar; insulated; I_N 32 A; light gray

	2-way	2004-402	25
	3-way	2004-403	25
	4-way	2004-404	25
	5-way	2004-405	25
	6-way	2004-406	25
	7-way	2004-407	25
	8-way	2004-408	25
	9-way	2004-409	25
	10-way	2004-410	25

Push-in type jumper bar; insulated; I_N 32 A; light gray

	1 to 3	2004-433	25
	1 to 4	2004-434	25
	1 to 5	2004-435	25
	1 to 6	2004-436	25
	1 to 7	2004-437	25
	1 to 8	2004-438	25
	1 to 9	2004-439	25
	1 to 10	2004-440	25

① Conductor range: 0.25 ... 4 mm² "s+f-st"; Push-in termination: 1 ... 4 mm² "s" and 1 ... 2.5 mm² "insulated ferrules, 12 mm"
Depending on the conductor characteristic, a conductor with a smaller cross section can also be inserted via push-in termination.

② 250 V = rated voltage
6 kV = rated impulse voltage
3 = pollution degree
(see Section 14)

③ Terminal blocks with an Ex mark are suitable for Ex ec IIc applications.
(see Section 14)

Please observe the application notes:
Jumpers, from page 156
Marking, from page 588

A protective warning marker and an insulation stop must be applied individually. Due to the 6.2 mm width of fused disconnect terminal blocks with end plates, 2004 Series Push-In Type Jumper Bars must be used.

Approvals and corresponding ratings, visit www.wago.com

Glass cartridge fuses 5 x 20

Series Item No.	Overload and short circuit protection		Short circuit protection only	
	Individual argmt.	Group argmt.	Individual argmt.	Group argmt.
Fuse terminal blocks				
2002-1911	1.6 W	1.6 W	2.5 W	2.5 W
2002-1911/.....	1.6 W	1.6 W	2.5 W	2.5 W

When selecting glass cartridge fuses, make sure that the maximum power loss listed below is not exceeded. The power loss is determined according to IEC or EN 60947-7-3/VDE 0611-6 at 23°C. The temperature rise of the terminal blocks must be checked according to their application and mounting. Higher ambient temperatures represent an additional impact on fuse cartridges. Therefore, in such applications, the rated current must be reduced if necessary. More details are available from the manufacturers.

Disconnect Terminal Block and Ground Conductor Disconnect Terminal Block and Through Terminal Block of Same Profile TOPJOB® S

6 (10) mm²; 2006 Series

1

Technical Data	
0.5 ... 6 (10) mm ² ①	20 ... 8 AWG
800 V/8 kV/3 ②	600 V, 15 A ③
I _N 30 A	600 V, 30 A ④
Terminal block width: 7.5 mm / 0.295 inch	
13 ... 15 mm / 0.51 ... 0.59 inch	

Technical Data	
0.5 ... 6 (10) mm ² ①	20 ... 8 AWG
800 V/8 kV/3 ②	600 V, 30 A ③
I _N 30 A	600 V, 30 A ④
Terminal block width: 7.5 mm / 0.295 inch	
13 ... 15 mm / 0.51 ... 0.59 inch	

Technical Data	
0.5 ... 6 (10) mm ² ①	20 ... 8 AWG
Terminal block width: 15 mm / 0.591 inch	
13 ... 15 mm / 0.51 ... 0.59 inch	

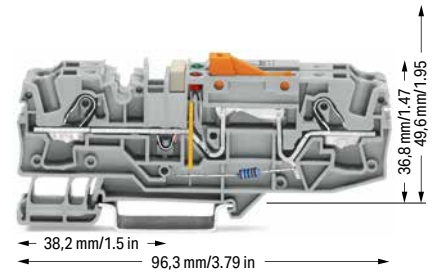
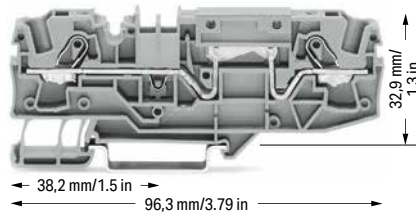
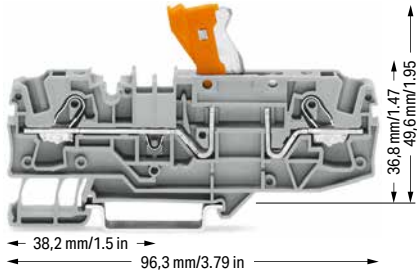

2-conductor disconnect terminal block; with test point; orange disconnect link

Color	Item No.	Pack. Unit
○ gray	2006-1671	25
● blue	2006-1674	25

2-conductor through terminal block; with test point; same profile as 2-conductor disconnect terminal block

Color	Item No.	Pack. Unit
○ gray	2006-1601	25
● blue	2006-1604	25

Ground conductor disconnect terminal block; with test point; orange disconnect link; gray

	Item No.	Pack. Unit
○ 24 V	2006-1671/1000-848	12
○ 48 V	2006-1671/1000-849	12
○ 120 V	2006-1671/1000-850	12
○ 230 V	2006-1671/1000-851	12

Other terminal blocks with the same profile:

Through	2006-1601	Page 98
---------	-----------	---------

Other terminal blocks with the same profile:

Carrier	2006-1661	Page 116
Fuse	2006-1681	Page 100

Other terminal blocks with the same profile:

Through	2006-1601	Page 98
---------	-----------	---------

Accessories; item-specific

Push-in type jumper bar; insulated; I_N 41 A; light gray

	2-way	2006-402	25
	3-way	2006-403	25
	4-way	2006-404	25
	5-way	2006-405	25

Push-in type jumper bar; insulated; I_N 41 A; light gray

	1 to 3	2006-433	25
	1 to 4	2006-434	25
	1 to 5	2006-435	25

Star point jumper; insulated; I_N = I_N terminal block; light gray

	1-3-5	2006-405/011-000	25
--	-------	------------------	----

Accessories; item-specific

Push-in type jumper bar; insulated; I_N 41 A; light gray

	2-way	2006-402	25
	3-way	2006-403	25
	4-way	2006-404	25
	5-way	2006-405	25

Push-in type jumper bar; insulated; I_N 41 A; light gray

	1 to 3	2006-433	25
	1 to 4	2006-434	25
	1 to 5	2006-435	25

Star point jumper; insulated; I_N = I_N terminal block; light gray

	1-3-5	2006-405/011-000	25
--	-------	------------------	----

Accessories; item-specific

Push-in type jumper bar; insulated; I_N 41 A; light gray

	2-way	2006-402	25
--	-------	----------	----

Accessories; 2006 Series

Appropriate marking systems: WMB/Marking strips

End and intermediate plate; 1 mm thick

	orange	2006-1692	100 (25)
	gray	2006-1691	100 (25)

Double-deck marker carrier; pivoting

	gray	2002-121	50 (25)
--	------	----------	---------

Protective warning marker; with black high-voltage symbol; for 5 terminal blocks

	yellow	2006-115	100 (25)
--	--------	----------	----------

❶ Conductor range: 0.5 ... 10 mm² "s+f-st";
Push-in termination: 2.5 ... 10 mm² "s" and
2.5 ... 6 mm² "insulated ferrules; 12 mm"
Depending on the conductor characteristic, a conductor
with a smaller cross section can also be inserted
via push-in termination.

❷ 800 V = rated voltage
8 kV = rated impulse voltage
3 = pollution degree
(see Section 14)

Please observe the application notes:
Jumpers, from page 155
Marking, from page 588

Approvals and corresponding ratings,
visit www.wago.com



Ground conductor disconnect terminal block – top view

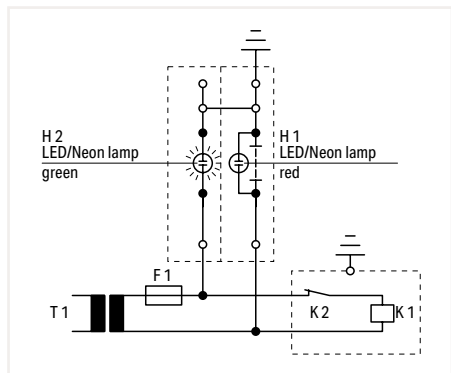

Operating condition
Slide link closed, auxiliary circuit grounded,
green LED/neon lamp illuminates.

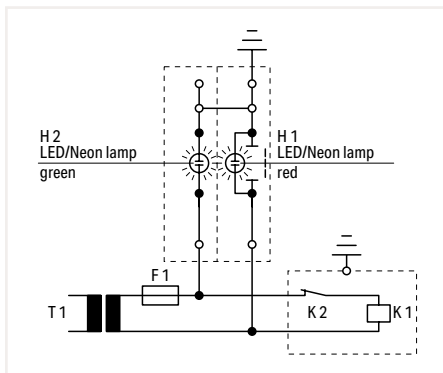

Test condition – no grounding
Slide link open, auxiliary circuit not grounded.

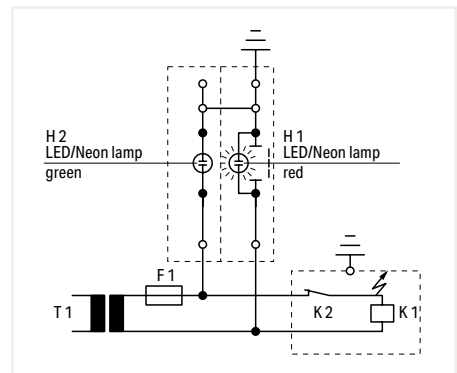

Test condition – grounding
Slide link open, auxiliary circuit not grounded,
red LED/neon lamp illuminates.

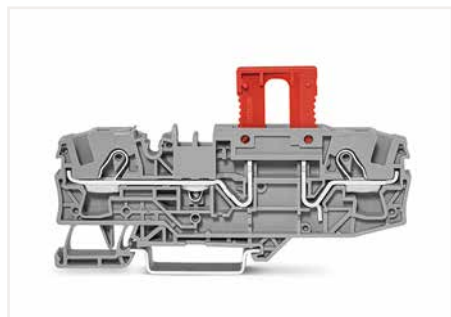

Blind plug (2006-451) for carrier terminal block (indicates a
disconnection)

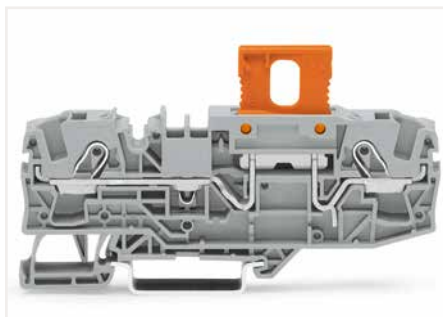

Carrier terminal block (2006-401) with disconnect plug
(2006-1661) in operating position

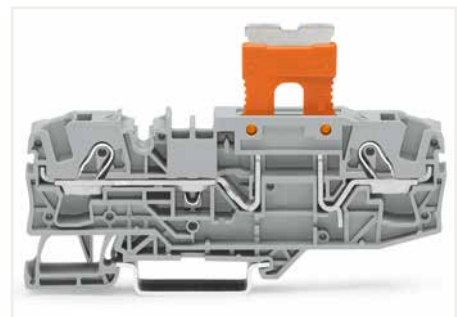

Carrier terminal block (2006-401) with disconnect plug
(2006-1661) in parked position

IEC 60204/DIN VDE 0113 "Safety of machinery – Electrical
equipment of machines – Part 1: General requirements,"
Section 9.4.3.1:

Ground faults on control circuits must not cause unintentional
starting, hazardous movements, or prevent stopping
of the machine.

In order to fulfill this requirement, a connection to the protective
bonding circuit must be provided in accordance
with Section 8.2 and the devices must be connected as
described in Section 9.1.4. Control circuits fed from a
transformer and not connected to the protective bonding
circuit must be provided with an insulation monitoring
device (e.g., residual current device), which either indicates a
ground fault or interrupts the circuit automatically
after a ground fault.

In the case of electronic circuits, the connection of one
side of the control circuit to the protective bonding circuit
in accordance with Section 9.1.4 can prevent unintentional
operation. When this does not help, or if due to other reasons
that electronic circuits cannot be connected to the
protective bonding circuit, other measures must be taken
to achieve the same level of safety.

Multipole control switches that interrupt all live conductors
must be used where the control circuit is directly connected
between the phase conductors of the supply or
between a phase conductor and a neutral conductor,
which is either not grounded or grounded through a high
impedance. This is required for starting or stopping
machine functions, which can cause a hazardous situation
including: damaging the machine or halting work in progress
in the event of unintentional starting or failure to stop.

Fuse Terminal Block for Automotive Blade-Style Fuses TOPJOB® S

6 (10) mm²; 2006 Series

1

Technical Data	
0.5 ... 6 (10) mm ² ①	20 ... 8 AWG
500 V/6 kV/3 ②	12 V, 15 A VA
I _N 25 A (30 A) ③	12 V, 30 A CA
Terminal block width: 7.5 mm / 0.295 inch	
13 ... 15 mm / 0.51 ... 0.59 inch	

Technical Data	
0.5 ... 6 (10) mm ² ①	20 ... 8 AWG
500 V/6 kV/3 ②	24 V, 15 A VA
I _N 25 A (30 A) ③	24 V, 30 A CA
Terminal block width: 7.5 mm / 0.295 inch	
13 ... 15 mm / 0.51 ... 0.59 inch	

Technical Data	
0.5 ... 6 (10) mm ² ①	20 ... 8 AWG
500 V/6 kV/3 ②	48 V, 30 A VA
I _N 25 A (30 A) ③	48 V, 30 A CA
Terminal block width: 7.5 mm / 0.295 inch	
13 ... 15 mm / 0.51 ... 0.59 inch	

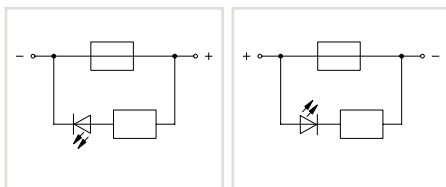
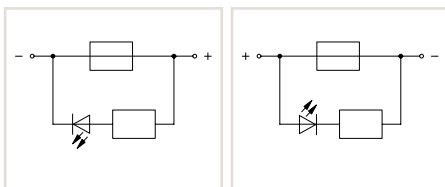
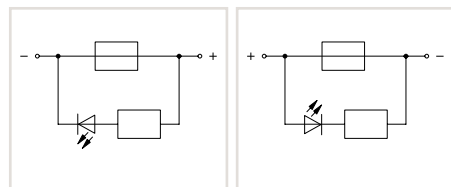
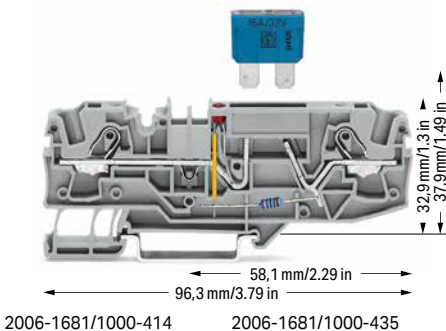
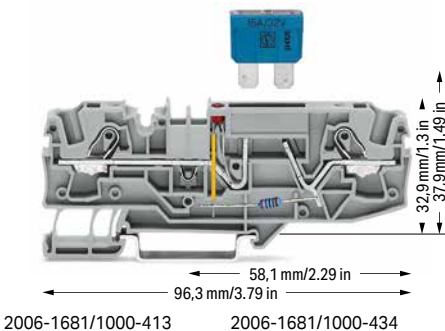
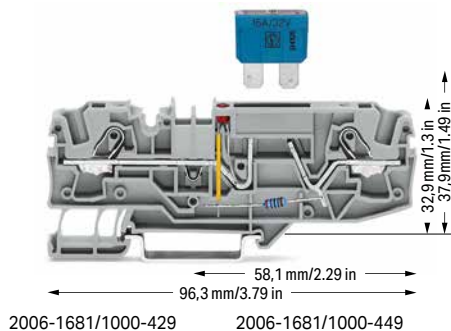

2-conductor fuse terminal block for automotive blade-style fuses; 12 V; with test point; with blown fuse indication by LED; LED power consumption: 4.8 mA
Electrical ratings are given by the fuse and blown fuse indication. Blade-style fuses: Observe touch-proof protection for 42 V and higher voltages!

2-conductor fuse terminal block for automotive blade-style fuses; 24 V; with test point; with blown fuse indication by LED; LED power consumption: 4.8 mA
Electrical ratings are given by the fuse and blown fuse indication. Blade-style fuses: Observe touch-proof protection for 42 V and higher voltages!

2-conductor fuse terminal block for automotive blade-style fuses; 48 V; with test point; with blown fuse indication by LED; LED power consumption: 4.8 mA
Electrical ratings are given by the fuse and blown fuse indication. Blade-style fuses: Observe touch-proof protection for 42 V and higher voltages!

Color	Item No.	Pack. Unit
○ gray	2006-1681/1000-429	25
○ gray	2006-1681/1000-449	25

Color	Item No.	Pack. Unit
○ gray	2006-1681/1000-413	25
○ gray	2006-1681/1000-434	25

Color	Item No.	Pack. Unit
○ gray	2006-1681/1000-414	25
○ gray	2006-1681/1000-435	25

Other terminal blocks with the same profile:
Through [2006-1601](#) [Page 98](#)

Accessories; 2006 Series

Appropriate marking systems: WMB/Marking strips

End and intermediate plate; 1 mm thick		
orange	2006-1692	100 (25)
gray	2006-1691	100 (25)

Marking strip; plain; 11 mm wide; 50 m reel		
white	2009-110	1

Push-in type jumper bar; insulated; I _N 41 A; light gray		
2-way	2006-402	25
3-way	2006-403	25
4-way	2006-404	25
5-way	2006-405	25

WMB marking card; white; 10 strips with 10 markers/card; 5 ... 5.2 mm stretchable		
plain	793-5501	5

Push-in type jumper bar; insulated; I _N 41 A; light gray		
1 to 3	2006-433	25
1 to 4	2006-434	25
1 to 5	2006-435	25

Double-deck marker carrier; pivoting		
gray	2002-121	50 (25)

Protective warning marker; with black high-voltage symbol; for 5 terminal blocks		
yellow	2006-115	100 (25)

Technical Data

0.5 ... 6 (10) mm ² ①	20 ... 8 AWG
500 V/6 kV/3 ②	600 V, 15 A ③
I _N 25 A (30 A)	600 V, 30 A ③
Terminal block width: 7.5 mm / 0.295 inch	
13 ... 15 mm / 0.51 ... 0.59 inch	

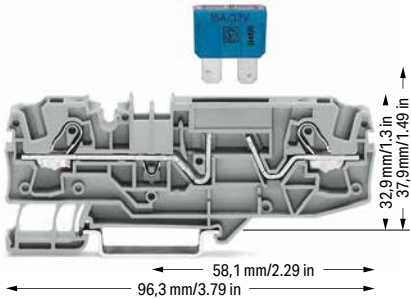

① Conductor range: 0.5 ... 10 mm² "s+f-st"; Push-in termination: 2.5 ... 10 mm² "s" and 2.5 ... 6 mm² "insulated ferrules; 12 mm" Depending on the conductor characteristic, a conductor with a smaller cross section can also be inserted via push-in termination.

② 500 V = rated voltage
6 kV = rated impulse voltage
3 = pollution degree (see Section 14)

③ LED power consumption: 4.8 mA

Blade-style fuses are not offered by WAGO. Thermal automotive circuit breakers are not offered by WAGO. WAGO recommends automotive circuit breakers from ETA.

Please observe the application notes: Marking, from page 588

Approvals and corresponding ratings, visit www.wago.com

2-conductor fuse terminal block for automotive blade-style fuses; with test point; without blown fuse indication; Electrical ratings are given by the fuse. Blade-style fuses: Observe touch-proof protection for 42 V and higher voltages!

Color	Item No.	Pack. Unit
○ gray	2006-1681	25

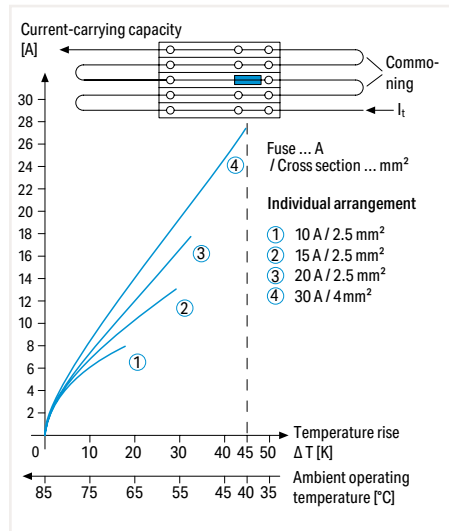

Application Notes on Fuse Terminal Blocks
Diagram: Individual arrangement

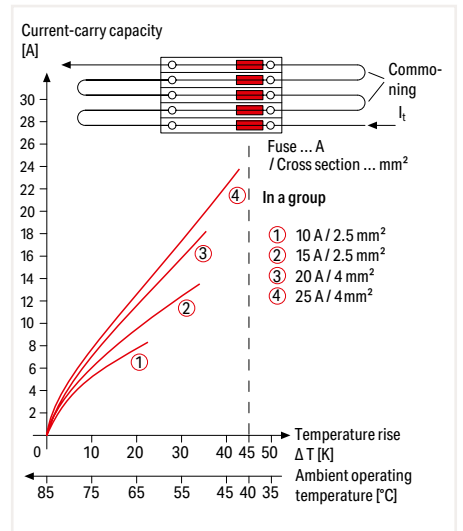

Application Notes on Fuse Terminal Blocks
Diagram: Block arrangement

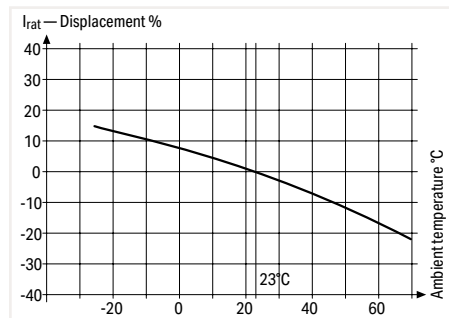

Application Notes on Fuse Terminal Blocks
Nominal current ratings for fuse cartridges are defined differently in international standards. This is why the recommended continuous current-carrying capacity of the fuses is a max. 80% of their nominal current according to DIN 72581/Part 3 (for an surrounding air temperature of 23°C).
Selecting the correct fuse cartridge is important for product safety within applications, as well as for fuse cartridge service life and reliability. Fuse cartridges will only operate perfectly as protection components (break-off point) if they are properly selected and used as intended (i.e., according to the state of the technology and valid specifications, as well as data sheet characteristics), according to basic safety requirements (i.e., persons, animals and property must be protected against hazards).

Information from the mini-automotive, blade-type fuse manufacturers

Derating T _{amb} / °C	%	F _T
-25	14	0.877
-20	13	0.885
-15	12	0.893
-10	11	0.901
-5	10	0.909
0	9	0.917
5	8	0.926
10	6	0.943
15	4	0.962
20	2	0.980
23	0	1.000
30	-2	1.020
35	-4	1.042
40	-6	1.064
45	-8	1.087
50	-10	1.111
55	-13	1.149
60	-16	1.190
65	-19	1.235
70	-22	1.282

With regard to product safety, fuse cartridges must generally be tested both under normal and faulty operating conditions within your application.

PUSH-IN CAGE CLAMP®

Fused Disconnect Terminal Block with Pivoting Fuse Holder TOPJOB® S; for 5 x 20 mm, 5 x 30 mm and ¼" x ¼" Glass Cartridge Fuse 6 (10) mm²; 2006 Series

1

Technical Data	
0.5 ... 6 (10) mm ² ①	20 ... 8 AWG
800 V/8 kV/3 ②	600 V, 15 A III
I _N 10 A	600 V, 15 A III
Terminal block width: 7.5 mm / 0.295 inch	
13 ... 15 mm / 0.51 ... 0.59 inch	

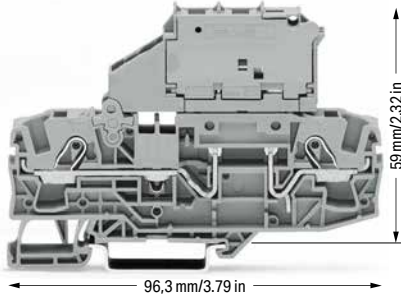

Technical Data	
0.5 ... 6 (10) mm ² ①	20 ... 8 AWG
800 V/8 kV/3 ②	30 V, 15 A III
I _N 10 A	30 V, 15 A III
Terminal block width: 7.5 mm / 0.295 inch	
13 ... 15 mm / 0.51 ... 0.59 inch	

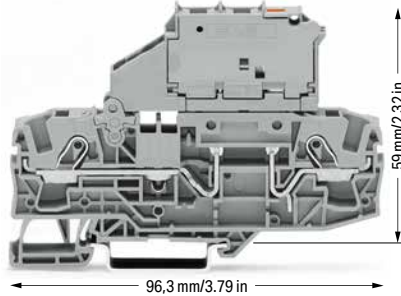

2-conductor fused disconnect terminal block with a pivoting fuse holder; without blown fuse indication
Electrical ratings are given by the fuse.

for 5 x 20 mm glass cartridge fuse

Color	Item No.	Pack. Unit
○ gray	2006-1611	25

for 5 x 30 mm glass cartridge fuse

○ gray	2006-1621	25
--------	-----------	----

for ¼" x ¼" glass cartridge fuse

○ gray	2006-1631	25
--------	-----------	----

Other terminal blocks with the same profile:

Through	2006-1601	Page 98
---------	-----------	---------

2-conductor fused disconnect terminal block with a pivoting fuse holder; gray; with blown fuse indication by LED
Electrical ratings are given by the fuse and blown fuse indication. Leakage current in case of a blown fuse: LED 2 mA

for 5 x 20 mm glass cartridge fuse

	Item No.	Pack. Unit
○ 12 ... 30 V	2006-1611/1000-541	25
○ 30 ... 65 V	2006-1611/1000-542	25
○ 120 V	2006-1611/1000-867	25
○ 230 V	2006-1611/1000-836	25

for 5 x 30 mm glass cartridge fuse

○ 12 ... 30 V	2006-1621/1000-541	25
○ 30 ... 65 V	2006-1621/1000-542	25
○ 120 V	2006-1621/1000-867	25
○ 230 V	2006-1621/1000-836	25
○ 380 ... 500 V	2006-1621/1000-859	25

for ¼" x ¼" glass cartridge fuse

○ 12 ... 30 V	2006-1631/1000-541	25
○ 30 ... 65 V	2006-1631/1000-542	25
○ 120 V	2006-1631/1000-867	25
○ 230 V	2006-1631/1000-836	25
○ 380 ... 500 V	2006-1631/1000-859	25

Other terminal blocks with the same profile:

Through	2006-1601	Page 98
---------	-----------	---------

Accessories; 2006 Series

Appropriate marking systems: WMB/Marking strips

End and intermediate plate; 1 mm thick

orange	2006-1692	100 (25)
gray	2006-1691	100 (25)

End plate for fuse terminal blocks; 2 mm thick

orange	2006-992	100 (25)
gray	2006-991	100 (25)

Push-in type jumper bar; insulated; I_N 41 A; light gray

2-way	2006-402	25
3-way	2006-403	25
4-way	2006-404	25
5-way	2006-405	25

Push-in type jumper bar; insulated; I_N 41 A; light gray

1 to 3	2006-433	25
1 to 4	2006-434	25
1 to 5	2006-435	25

Star point jumper; insulated; I_N = I_N terminal block; light gray

1-3-5	2006-405/011-000	25
-------	------------------	----

Protective warning marker; with black high-voltage symbol; for 5 terminal blocks

yellow	2006-115	100 (25)
--------	----------	----------

Test plug; with 500 mm cable; 2 mm Ø; max. 42 V

red	210-136	50
-----	---------	----

WMB marking card; white; 10 strips with 10 markers/card; 5 ... 5.2 mm stretchable

plain	793-5501	5
-------	----------	---

① Conductor range: 0.5 ... 10 mm² "s+f-st"; Push-in termination: 2.5 ... 10 mm² "s" and 2.5 ... 6 mm² "insulated ferrules; 12 mm"
Depending on the conductor characteristic, a conductor with a smaller cross section can also be inserted via push-in termination.

② 800 V = rated voltage
8 kV = rated impulse voltage
3 = pollution degree
(see Section 14)

Please observe the application notes:
Jumpers, from page 155
Marking, from page 588

Approvals and corresponding ratings, visit www.wago.com



Fused disconnect terminal block with a pivoting fuse holder - pivoting the fuse holder into the locked open position.

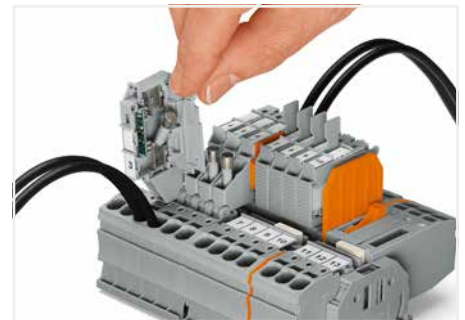

Fused disconnect terminal block with a pivoting fuse holder - fuse replacement: Open the cover to replace the fuse.



Sold & Serviced By:





Toll Free Phone (877) SERV098
www.electromate.com
sales@electromate.com

Fused Disconnect Terminal Block with Pivoting Fuse Holder TOPJOB® S; for ¼" x 1¼" Glass Cartridge Fuse

6 (10) mm²; 2006 Series

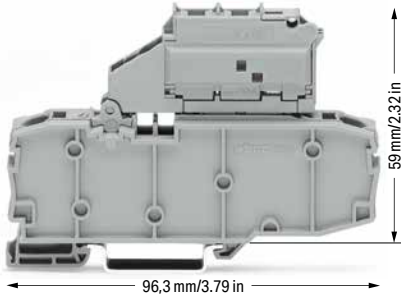
Technical Data	
0.5 ... 6 (10) mm ² ①	20 ... 8 AWG
800 V/8 kV/3 ②	600 V, 15 A 
I _N 10 A	600 V, 15 A _Ⓢ
Terminal block width: 10.4 mm / 0.409 inch	
 13 ... 15 mm / 0.51 ... 0.59 inch	



Technical Data	
0.5 ... 6 (10) mm ² ①	20 ... 8 AWG
800 V/8 kV/3 ②	30 V, 15 A 
I _N 10 A	30 V, 15 A _Ⓢ
Terminal block width: 10.4 mm / 0.409 inch	
 13 ... 15 mm / 0.51 ... 0.59 inch	

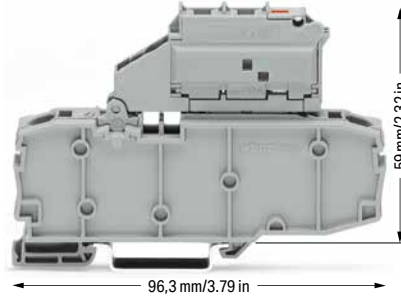





Fused disconnect terminal block with a pivoting fuse holder and end plate; without blown fuse indication
Electrical ratings are given by the fuse.

for ¼" x 1¼" glass cartridge fuse

Color	Item No.	Pack. Unit
 gray	2006-1631/099-000	25

Fused disconnect terminal block with a pivoting fuse holder and end plate; gray; with blown fuse indication by LED
Electrical ratings are given by the fuse and blown fuse indication. Leakage current in case of a blown fuse: LED 2 mA

for ¼" x 1¼" glass cartridge fuse

	Item No.	Pack. Unit
 12 ... 30 V	2006-1631/1099-541	25
 30 ... 65 V	2006-1631/1099-542	25
 120 V	2006-1631/1099-867	25
 230 V	2006-1631/1099-836	25
 380 ... 500 V	2006-1631/1099-859	25

- Conductor range: 0.5 ... 10 mm² "s+f-st"; Push-in termination: 2.5 ... 10 mm² "s" and 2.5 ... 6 mm² "insulated ferrules; 12 mm" Depending on the conductor characteristic, a conductor with a smaller cross section can also be inserted via push-in termination.
- 800 V = rated voltage
8 kV = rated impulse voltage
3 = pollution degree
(see Section 14)

Please observe the application notes:
Jumpers, from page 155
Marking, from page 588

Approvals and corresponding ratings, visit www.wago.com

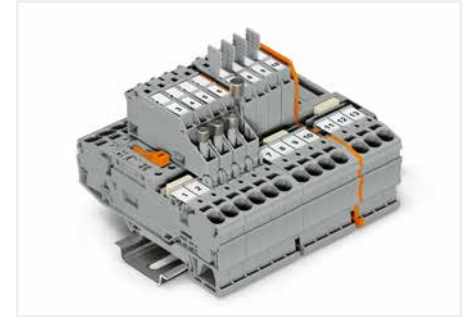

Pivoting fuse holder with spare fuse holder

Other terminal blocks with the same profile:

Through	2006-1601	Page 98
---------	-----------	---------

Other terminal blocks with the same profile:

Through	2006-1601	Page 98
---------	-----------	---------

Accessories; 2006 Series Appropriate marking systems: WMB/Marking strips

End plate for fuse terminal blocks; 2 mm thick

 orange	2006-992	100 (25)
gray	2006-991	100 (25)

Push-in type jumper bar; insulated; I_N 25 A; light gray

 1 to 3	2002-433	25
1 to 5	2002-435	25
1 to 7	2002-437	25
1 to 9	2002-439	25

Star point jumper; insulated; I_N = I_N terminal block; light gray

 1-3-5	2002-405/011-000	25
---	------------------	----

Protective warning marker; with black high-voltage symbol; for 5 terminal blocks

 yellow	2006-115	100 (25)
--	----------	----------

Test plug; with 500 mm cable; 2 mm Ø; max. 42 V

 red	210-136	50
---	---------	----

WMB marking card; white; 10 strips with 10 markers/card; 5 ... 5.2 mm stretchable

 plain	793-5501	5
---	----------	---

Glass cartridge fuses

Series Item No.	Overload and short circuit protection		Short circuit protection only		
	Individual argmt.	Group argmt.	Individual argmt.	Group argmt.	
Fused disconnect terminal blocks					
2006-1611	7.5	1.6 W	1.6 W	2.5 W	2.5 W
2006-1621	7.5	1.6 W	1.6 W	2.5 W	2.5 W
2006-1631	7.5	1.6 W	1.6 W	2.5 W	2.5 W
2006-1631 /099-...	10.4	2.5 W	2.5 W	2.5 W	2.5 W
2006-1631 /1099-...	10.4	2.5 W	2.5 W	2.5 W	2.5 W

When selecting glass cartridge fuses, make sure that the maximum power loss listed below is not exceeded. The power loss is determined according to IEC or EN 60947-7-3/VDE 0611-6 at 23°C. The temperature rise of the terminal blocks must be checked according to their application and mounting. Higher ambient temperatures represent an additional impact on fuse cartridges. Therefore, in such applications, the rated current must be reduced if necessary. More details are available from the manufacturers.

Disconnect/Test Terminal Block; Through/Carrier Terminal Block of Same Profile TOPJOB® S 6 (10) mm²; 2006 Series

1

Technical Data	
0.5 ... 6 (10) mm ² ①	20 ... 8 AWG
1000 VAC/DC / 1500 VDC / 12 kV / 3 ②	
I _N 30 A 600 V, 30 A ^{VA} ; 1000 V, 30 A [ⓐ]	
Terminal block width: 15 mm / 0.591 inch	
13 ... 15 mm / 0.51 ... 0.59 inch	

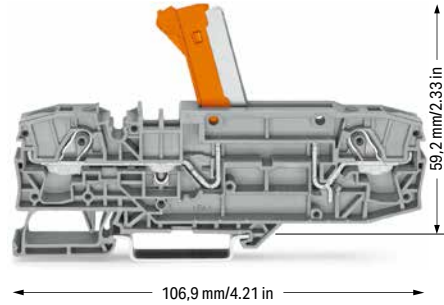

2-conductor disconnect/test terminal block; with test point; orange disconnect link

Color	Item No.	Pack. Unit
○ gray	2006-8671	12
● blue	2006-8674	12

Technical Data	
0.5 ... 6 (10) mm ² ①	20 ... 8 AWG
1000 VAC/DC / 1500 VDC / 12 kV / 3 ②	
I _N 30 A 600 V, 30 A ^{VA} ; 1000 V, 30 A [ⓐ]	
Terminal block width: 15 mm / 0.591 inch	
13 ... 15 mm / 0.51 ... 0.59 inch	

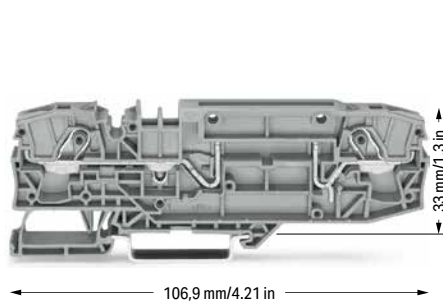

2-conductor carrier terminal block; with test point

Color	Item No.	Pack. Unit
○ gray	2006-8661	12
● blue	2006-8664	12

Technical Data	
0.5 ... 6 (10) mm ² ①	20 ... 8 AWG
1000 VAC/DC / 1500 VDC / 12 kV / 3 ②	
I _N 30 A 600 V, 30 A ^{VA} ; 1000 V, 30 A [ⓐ]	
Terminal block width: 15 mm / 0.591 inch	
13 ... 15 mm / 0.51 ... 0.59 inch	

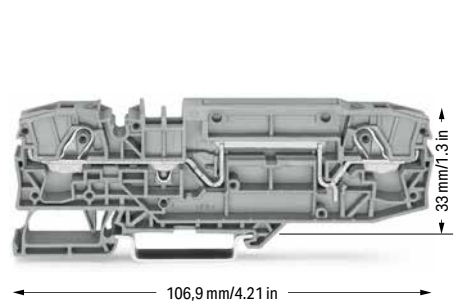

2-conductor through terminal block; with test point; same profile as 2-conductor disconnect terminal block

Color	Item No.	Pack. Unit
○ gray	2006-8601	12
● blue	2006-8604	12

Accessories; item-specific
Disconnect plug for carrier terminal blocks; suitable when using a carrier terminal block as disconnect terminal block

	orange	2006-8401	48 (12)
---	--------	-----------	---------

Accessories; 2006 Series

End and intermediate plate; 1 mm thick			
	orange	2006-8692	48 (12)
	gray	2006-8691	48 (12)

Protective warning marker; with black high-voltage symbol; for 5 terminal blocks			
	yellow	2006-115	100 (25)

Push-in type jumper bar; insulated; I _N 41 A; light gray			
	1 to 3	2006-433	25
	1 to 5	2006-435	25

Lockout cap; for conductor entry and operating slot			
	gray	2006-191	25

Appropriate marking systems: WMB/Marking strips

WMB Inline, plain; 1,500 WMB markers (5 mm)/reel; 5 ... 5.2 mm stretchable			
	white	2009-115	1

Marking strip; plain; 11 mm wide; 50 m reel			
	white	2009-110	1

WMB marking card; white; 10 strips with 10 markers/card; 5 ... 5.2 mm stretchable			
	plain	793-5501	5

WMB marking card; plain; 10 strips with 10 markers/card; 5 ... 5.2 mm stretchable			
	yellow	793-5501/000-002	5
	red	793-5501/000-005	5
	blue	793-5501/000-006	5
	gray	793-5501/000-007	5
	orange	793-5501/000-012	5
	light green	793-5501/000-017	5
	green	793-5501/000-023	5
	violet	793-5501/000-024	5

❶ Conductor range: 0.5 ... 10 mm² "s+f-st";
Push-in termination: 2.5 ... 10 mm² "s" and
2.5 ... 6 mm² "insulated ferrules; 12 mm"
Depending on the conductor characteristic, a conductor with a smaller cross section can also be inserted via push-in termination.

❷ 1000 VAC/DC = rated voltage
1500 VDC
12 kV = rated impulse voltage
3 = pollution degree
(see Section 14)

Please observe the application notes:
Marking, from page 588

Protective warning markers must be applied individually.

Approvals and corresponding ratings,
visit www.wago.com

Both 2006-8671 and 2006-8661 Disconnect Terminal Blocks are specially designed for use in photovoltaic and wind power systems, where voltages exceeding 1,000 V (IEC) and 600 V (UL) occur (e.g., generator junction boxes).

- Ideal for high voltages in renewable energy applications
- **Disconnect terminal blocks with two alternative disconnect options:**
with orange knife disconnect (2006-8671)
with orange disconnect plug (2006-8661)
- These 2006 Series terminal blocks are approved for 1,500 VDC (IEC) or 1,000 VDC (UL) and 30 A.
- With a terminal block width of 15 mm, the maximum cross-section for solid and fine-stranded conductors is 10 mm² (AWG 8) and 6 mm² (AWG 10) for ferruled conductors.
- Equipped with two test slots
- Compatible with through terminal blocks of the same profile and all other terminal blocks TOPJOB® S



Disconnect/test terminal block with knife disconnect (2006-8671) in disconnect position

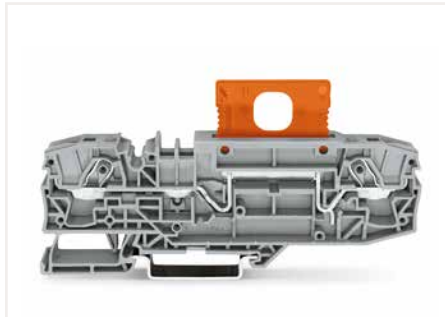

Carrier terminal block with disconnect plug (2006-8401) in operating position

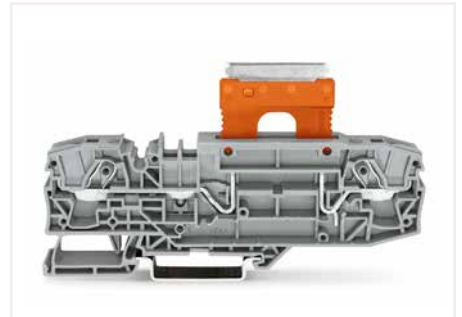

Carrier terminal block with disconnect plug (2006-8401) in parked position



Commoning a 15 mm-wide terminal block via push-in type jumper bars: 1 to 3 (2006-433) and 1 to 5 (2006-435).

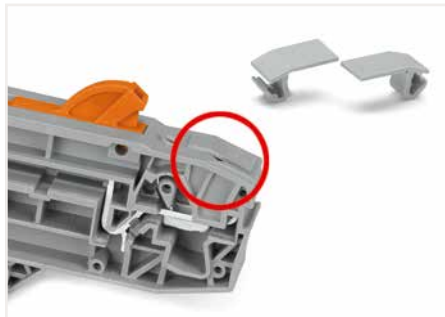

Cover (2006-191) seals unused conductor entry.

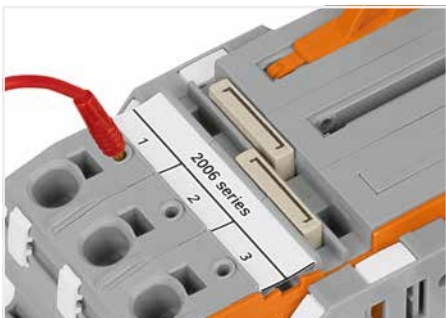

Test slots on both terminal block sides allow for direct measurement.



Test slots on both terminal block sides allow for direct measurement.



Alternatively, measurement can also be performed using Connectors (2006-511) from terminal block 1 to 2. Spacer modules (2006-549) must be used to compensate for the 15 mm terminal block width.

Current Transformer Terminal Blocks TOPJOB® S, 2007-8821 (Orange Disconnect Link)

1

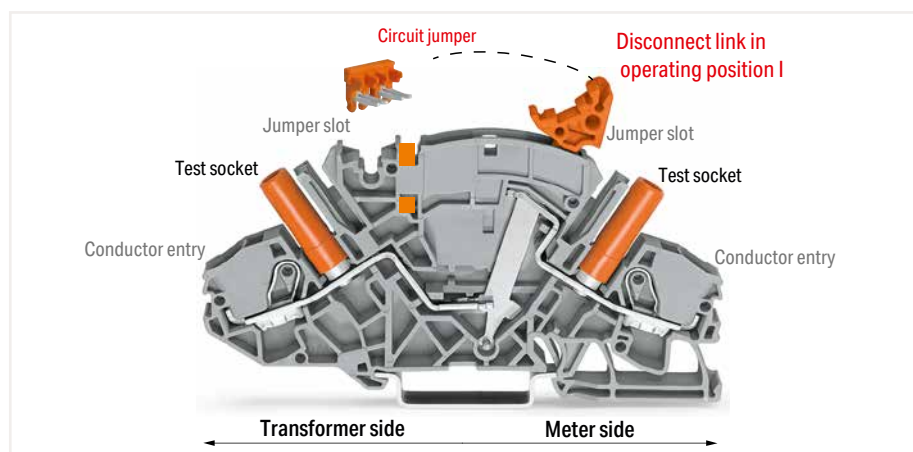

Current Transformer (Disconnect/Test) Terminal Block (2007-8821) is designed for current transformer circuits.

First, the current transformer is shorted via disconnect link and circuit jumper (insert jumper, move disconnect link from operating position I to shorting position II, activate shorting path). Connecting a measurement device via test socket on the meter side can only be performed once circuit disconnection is complete (disconnect link in measuring position III).

Advantages:

- Top-of-unit circuit jumper slot for shorting path activation
- Disconnect link provides intuitive and easy operation, as well as exact switching status indication.
- Combines high functionality with compact design (99.6 mm long and 8 mm wide).
- All 2007 Series terminal blocks are rated at 30 A/500 V (IEC) and 300 V (UL).
- With a terminal block width of 8 mm, the maximum cross-section for solid and fine-stranded conductors is 10 mm² (8 AWG) and 6 mm² (10 AWG) for ferruled conductors.
- Touch-proof test sockets for 4 mm Ø test plugs on transformer and meter side.
- Compatible with through and ground conductor terminal blocks having the same profile.

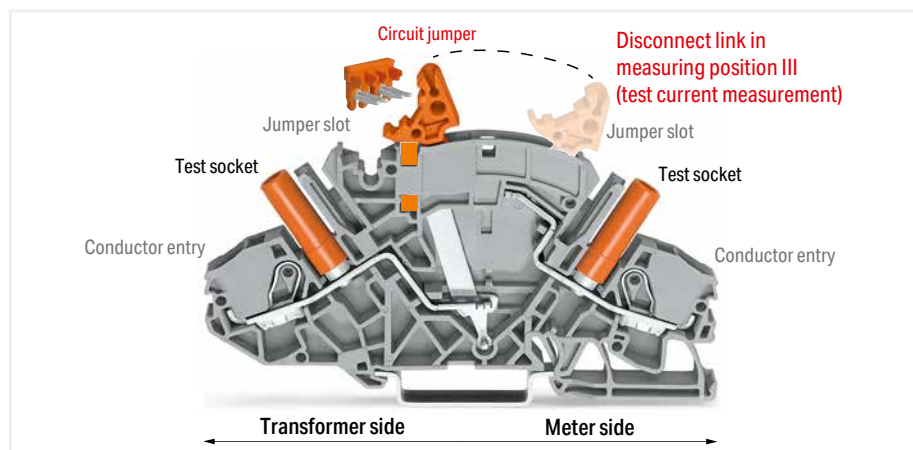
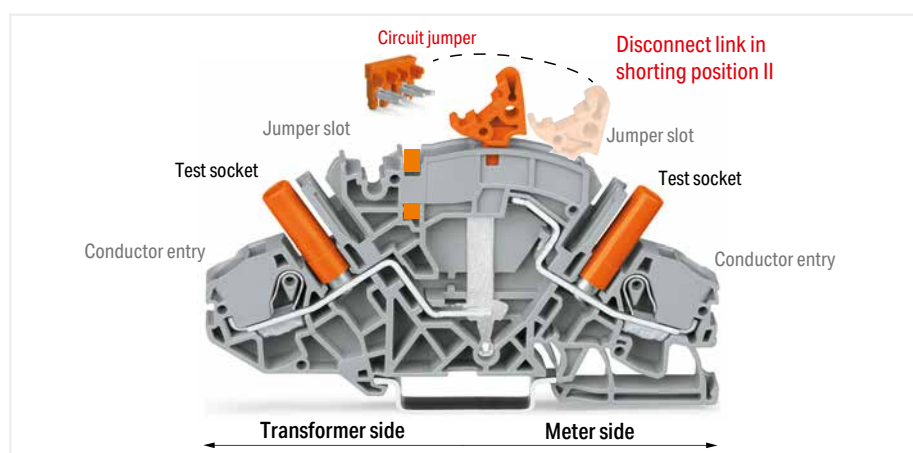

Preparing shorting path for the current transformer circuits.



Insert insulated, touch-proof circuit jumpers into jumper slot.



Using locking covers or profiles for adjacent terminal blocks allows disconnect links to be operated simultaneously.

Implementing a Current and Voltage Transformer Circuit TOPJOB® S



Disconnect link in operating position I
Terminal blocks required:
2 x disconnect/test terminal block (2007-8821)
1 x circuit jumper, orange (2007-8442)
Locking covers or interlocking links (option)

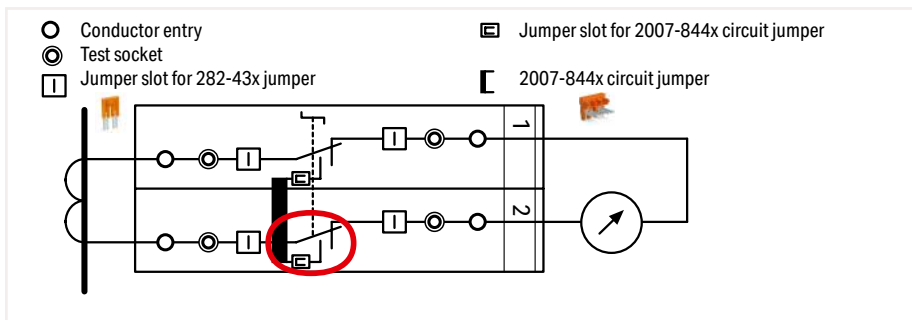

In the operating position, the measurement device is connected to the transformer, the circuit jumper is inserted and the disconnect link is in position I.



Disconnect link in shorting position II

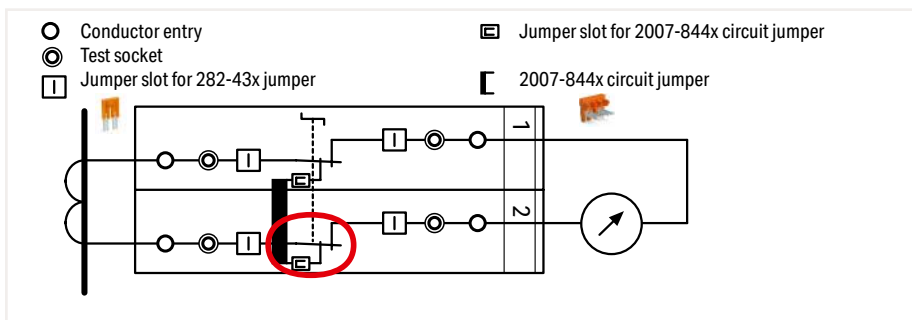

The transformer is not disconnected from the measuring device yet, the shorting path is activated by moving the disconnect link into shorting position II and the transformer is safely shorted.



Test current measurement: Disconnect link in measuring position III

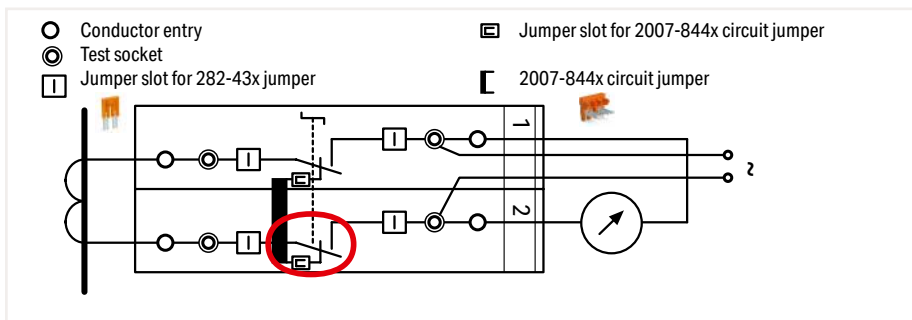

The measuring device is electrically disconnected from the transformer. If required, an external voltage can be applied to the measuring device via the test socket.



Measurement testing (using both test sockets)
Terminal block 1: Disconnect link in operating position I
Terminal block 2: Disconnect link in measuring position III

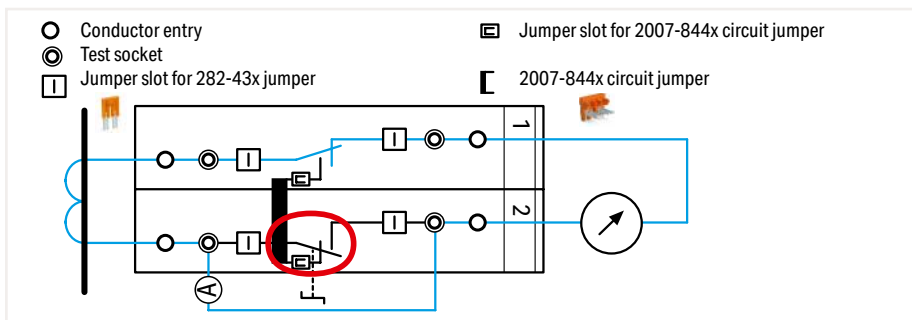

Measurement testing: First insert the reference current meter (A) into the test socket, then move the disconnect link into measurement point III (test current measurement).

Examples for Current Transformer Circuits TOPJOB® S

1



Measuring set for a three-phase current transformer
Terminal blocks required:

- 6 x disconnect/test terminal block (2007-8821)
- 3 x circuit jumper, orange (2007-8442)
- In addition: interlocking link, locking cover, lock-out

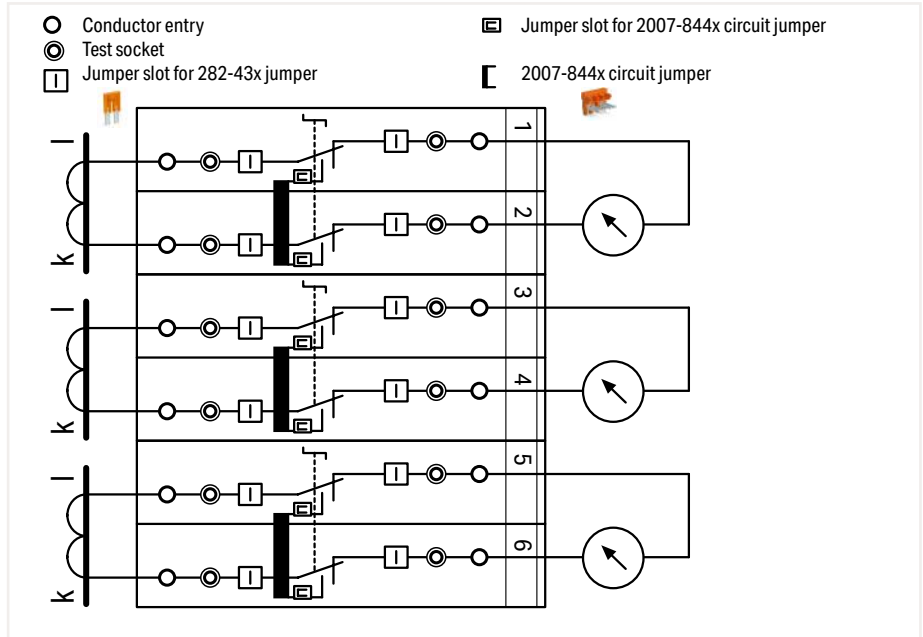

Pairs of disconnect links are interconnected via locking cover or interlocking link. Measurement testing is performed after the interlocking is released.



Measuring set for a three-phase current transformer
with 'Y' point

- Terminal blocks required:
- 6 x disconnect/test terminal block (2007-8821)
 - 1 x circuit jumper, orange (2007-8446)
 - 1 x jumper, orange (282-433)
 - In addition: interlocking link, locking cover, lock-out

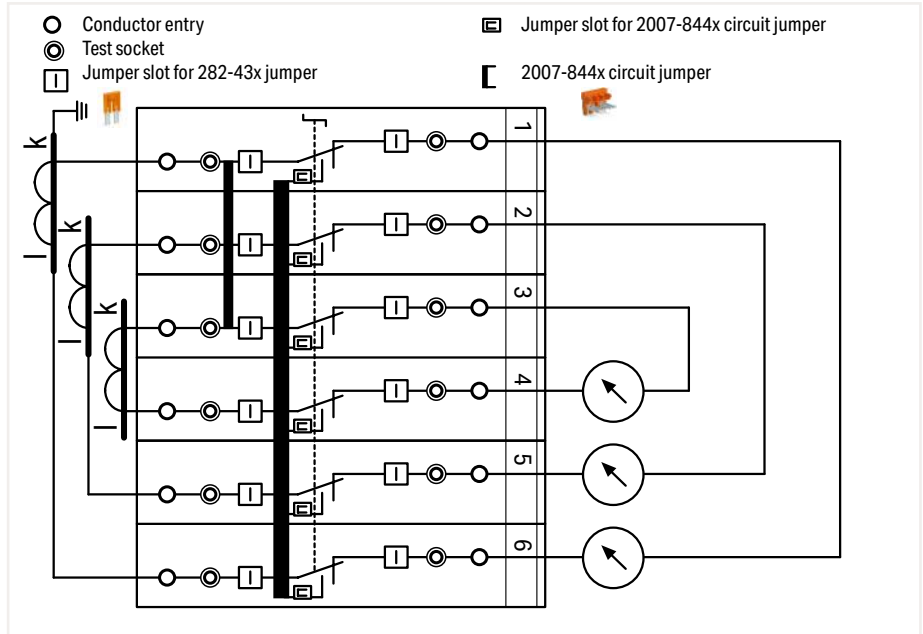

All six disconnect links are interconnected via locking cover or interlocking link.

Voltage Transformer Terminal Blocks TOPJOB® S, 2007-8811 (Light Gray Disconnect Link)

1

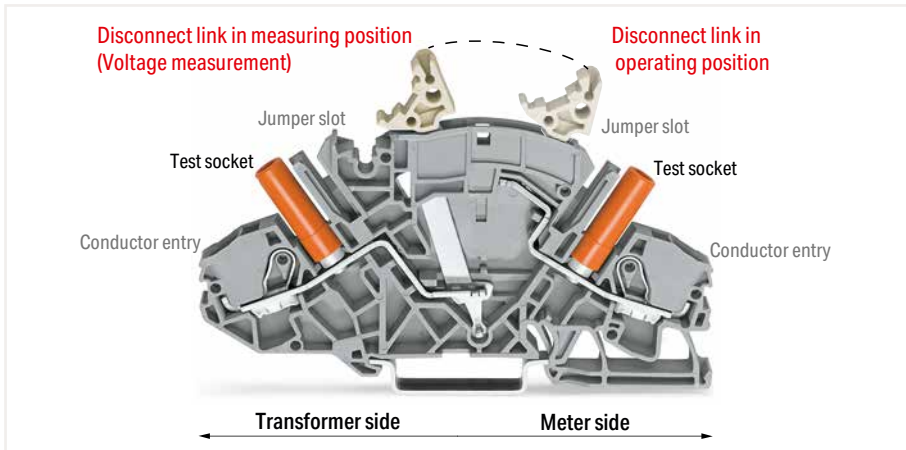

Voltage Transformer (Disconnect/Test) Terminal Block (2007-8811) is designed for current transformer circuits.

First, disconnect the voltage transformer from the circuit (move disconnect link from operating position to measurement position). Connecting a measurement device via test socket on the meter side can only be performed after disconnection is complete (measuring position).

Advantages:

- For voltage transformer circuits (no circuit jumper slot required as for 2007-8821 Current Transformer Terminal Block)
- Disconnect link provides intuitive and easy operation, as well as exact switching status indication.
- Combines high functionality with compact design (99.6 mm long and 8 mm wide).
- All 2007 Series terminal blocks are rated at 30 A/500 V (IEC) and 300 V (UL).
- With a terminal block width of 8 mm, the maximum cross-section for solid and fine-stranded conductors is 10 mm² (8 AWG) and 6 mm² (10 AWG) for ferruled conductors.
- Touch-proof test sockets for 4 mm Ø test plugs on transformer and meter side.
- Compatible with through and ground conductor terminal blocks having the same profile.



Example for voltage transformer testing:
Measuring set for single-phase voltage transformer testing

Terminal blocks required:

- 1 x disconnect/test terminal block (2007-8811)
- 1 x through terminal block (2007-8801)
- 1 x end plate, orange (2007-8892)
- In addition: locking cover, lock-out

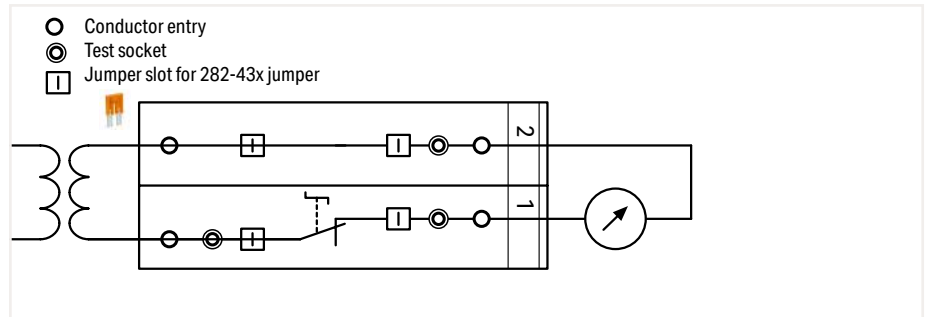

Disconnecting the voltage transformer from the circuit: Move disconnect link from operating position to measurement position.
Voltage measurement: Connecting a measurement device via test socket on the meter side can only be performed after disconnection is complete (measuring point).



Marking via WMB Multi markers or marking strips.



Additional commoning option on the transformer side



Multipole switching via snap-on type, transparent (locking) cover for disconnect links.

Disconnect/Test Terminal Block, Through/Ground Conductor Terminal Block TOPJOB® S; for Current and Voltage Transformer Circuits 6 mm²; 2007 Series

1

Technical Data	
0.5 ... 6 (10) mm ² ①	20 ... 8 AWG
500 V/6 kV/3 ②	300 V, 30 A ③
I _N 30 A	
Terminal block width: 8 mm / 0.315 inch	
13 ... 15 mm / 0.51 ... 0.59 inch	

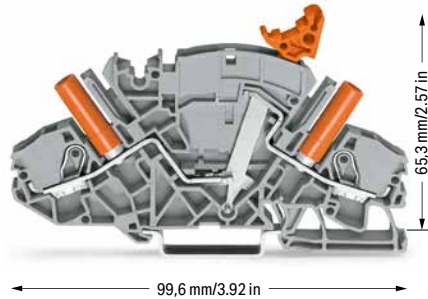

2-conductor disconnect/test terminal block; e.g., current transformer circuits; with circuit jumper slot; with touch-proof test sockets; for 4 mm Ø test plugs

Color	Item No.	Pack. Unit
○ gray	2007-8821	20

Technical Data	
0.5 ... 6 (10) mm ² ①	20 ... 8 AWG
500 V/6 kV/3 ②	300 V, 30 A ③
I _N 30 A	
Terminal block width: 8 mm / 0.315 inch	
13 ... 15 mm / 0.51 ... 0.59 inch	

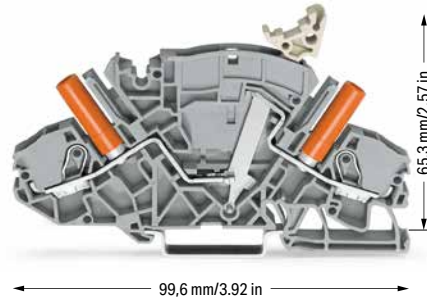

Disconnect/test terminal block; e.g., for voltage transformer circuits; with touch-proof test sockets; for 4 mm Ø test plugs

Color	Item No.	Pack. Unit
○ gray	2007-8811	20

Technical Data	
0.5 ... 6 (10) mm ² ①	20 ... 8 AWG
500 V/6 kV/3 ②	300 V, 30 A ③
I _N 30 A	
Terminal block width: 8 mm / 0.315 inch	
13 ... 15 mm / 0.51 ... 0.59 inch	

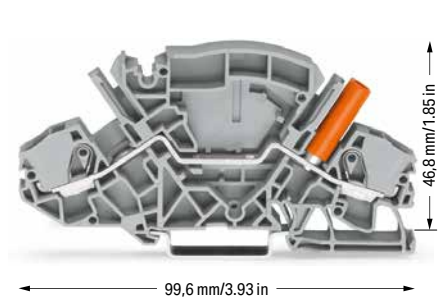

2-conductor through terminal block; with touch-proof test socket; for 4 mm Ø test plugs

Color	Item No.	Pack. Unit
○ gray	2007-8801	20
● blue	2007-8804	20

Accessories; item-specific

Jumper; insulated; I_N 30 A; orange

	2-way	2007-8442	50 (10)
	3-way	2007-8443	50 (10)
	4-way	2007-8444	50 (10)
	5-way	2007-8445	50 (10)
	6-way	2007-8446	50 (10)
	7-way	2007-8447	50 (10)
	8-way	2007-8448	50 (10)

Accessories; 2007 Series

End and separator plate; 1.5 mm thick; without lock-out seal option

	orange	2007-8892	50 (10)
	gray	2007-8891	50 (10)

End and separator plate; 1.5 mm thick; with lock-out seal option

	orange	2007-8894	50 (10)
	gray	2007-8893	50 (10)

Lock-out device; for disconnect link

	yellow	2007-8899	100 (20)
--	--------	-----------	----------

Locking cover; mechanically locks multiple links; transparent

	1-pole	282-881	50 (10)
	2-pole	282-882	50 (10)
	3-pole	282-883	50 (10)
	4-pole	282-884	50 (10)
	5-pole	282-885	50 (10)
	6-pole	282-886	50 (10)
	7-pole	282-887	50 (10)
	8-pole	282-888	50 (10)

Appropriate marking systems: WMB/Marking strips

Jumper; insulated; I_N 30 A; orange

	2-way	282-432	50 (10)
	3-way	282-433	50 (10)
	4-way	282-434	50 (10)
	5-way	282-435	50 (10)
	6-way	282-436	50 (10)
	7-way	282-437	50 (10)
	8-way	282-438	50 (10)
	9-way	282-439	50 (10)
	10-way	282-440	50 (10)

Jumper with safety lid; insulated; I_N 30 A; orange

	2-way	282-432/100-000	50 (10)
	3-way	282-433/100-000	50 (10)
	4-way	282-434/100-000	50 (10)

Interlocking link; mechanically locks multiple links; 1 m long

	transparent	210-254	1
--	-------------	---------	---

Jumper; insulated; I_N 30 A; orange

	1-3-5	282-435/011-000	50 (10)
	1-4-5	282-435/301-000	50 (10)
	1-3-4-5	282-435/300-000	50 (10)
	1-2-4-6	282-436/301-000	50 (10)
	1-4-6	282-436/304-000	50 (10)
	1-3-5-7	282-437/011-000	50 (10)
	1-4-7	282-437/012-000	50 (10)
	1-2-5-8	282-438/300-000	50 (10)
	1-4-7-8	282-438/301-000	50 (10)
	1-3-5-7-9	282-439/011-000	50 (10)

Protective warning marker; with black high-voltage symbol; for 5 terminal blocks

	yellow	2006-115	100 (25)
--	--------	----------	----------

WMB marking card; white; 10 strips with 10 markers/card; stretchable 5 ... 5.2 mm

	plain	793-5501	5
--	-------	----------	---

Marking strip; plain; 11 mm wide; 50 m reel

	white	2009-110	1
--	-------	----------	---

Technical Data

0.5 ... 6 (10) mm² ① | 20 ... 8 AWG

Terminal block width: 8 mm / 0.315 inch

13 ... 15 mm / 0.51 ... 0.59 inch



46,8 mm / 1.85 in

99,6 mm / 3.93 in

2-conductor ground terminal block; with touch-proof test socket; for 4 mm Ø test plugs

Color	Item No.	Pack. Unit
green-yellow	2007-8807	20

① Conductor range: 0.5 ... 10 mm² "s+f-st"; Push-in termination: 2.5 ... 10 mm² "s" and 2.5 ... 6 mm² "insulated ferrules; 12 mm"
Depending on the conductor characteristic, a conductor with a smaller cross section can also be inserted via push-in termination.

② 500 V = rated voltage
6 kV = rated impulse voltage
3 = pollution degree (see Section 14)

Please observe the application notes: Marking, from page 588

Approvals and corresponding ratings, visit www.wago.com



Marking via WMB Multi markers or marking strips.



Lock-out prevents accidental operation of disconnect link.



Lock-out snaps into one of two notched positions.

WMB marking card; 10 strips with 10 markers/card; stretchable 5 ... 5.2 mm; yellow

	k/I (50x)	794-5553/000-002	5
---	-----------	------------------	---

WMB marking card; 10 strips with 10 markers/card; stretchable 5 ... 5.2 mm; blue

	U/V (50x)	794-5554/000-006	5
---	-----------	------------------	---



Interlocking link mechanically locks multiple links for multi-pole switching applications.



A lock-out seal can be used on the disconnect link in operating position I in combination with an end and separator plate (2007-8893 or 2007-8894).

Terminal Block Assembly TOPJOB® S; for Current and Voltage Transformers

6 (10) mm²; 2007 Series

1

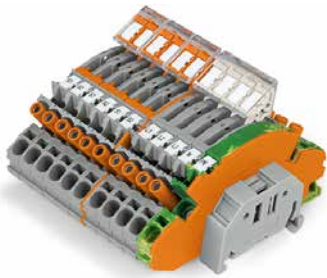

Item No. for 2007-8873	Quantity
Designation	
249-117	2
Screwless end stop; 10 mm wide	
282-882	3
Locking cover; mechanically locks multiple links, 2-pole	
282-884	1
Locking cover; mechanically locks multiple links, 4-pole	
2007-8442	3
Circuit jumper; insulated; 2-way	
2007-8807	1
2-conductor ground terminal block; with touch-proof test socket; for 4 mm Ø test plugs	
2007-8811	4
2-conductor disconnect/test terminal block; with touch-proof test sockets; for 4 mm Ø test plugs	
2007-8821	6
2-conductor disconnect/test terminal block; with touch-proof test sockets; for 4 mm Ø test plugs	
2007-8892	2
End and separator plate; 1.5 mm thick; without lock-out seal option	
2009-115	21 markers
WMB Inline, plain; 1,500 WMB markers (5 mm)/reel; 5 ... 5.2 mm stretchable	
282-435/011-000	1
Jumper; insulated; 1-3-5	
Assembly width incl. end stop: 11.2 cm	

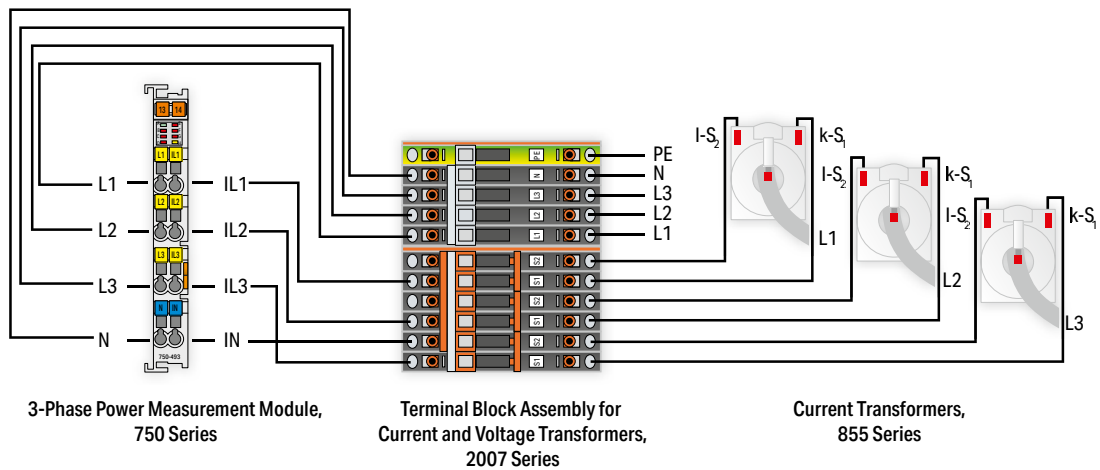



Item No. for 2007-8876	Quantity
Designation	
249-117 Screwless end stop; 10 mm wide	2
282-369 Collective jumper carrier; for DIN-35 rail; compatible with jumpers for transverse switching terminal block (282-811) and longitudinal switching disconnect terminal block (282-821)	1
282-882 Locking cover; mechanically locks multiple links, 2-pole	3
2007-8442 Circuit jumper; insulated; 2-way	3
2007-8821 2-conductor disconnect/test terminal block; with touch-proof test sockets; for 4 mm Ø test plugs	6
2007-8892 End and separator plate; 1.5 mm thick; without lock-out seal option	1
2009-115 WMB Inline, plain; 1,500 WMB markers (5 mm)/reel; 5 ... 5.2 mm stretchable	12 markers
282-435/011-000 Jumper; insulated; 1-3-5	1
Assembly width incl. end stop: 8.5 cm	

Fuse Plug TOPJOB® S on Carrier Terminal Block 2.5 (4) mm² 2004 Series

1

Technical Data	
250 V / I _N 6.3 A	Plug width: 6.1 mm / 0.24 inch

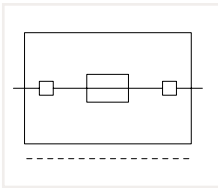

Fuse plug with pull-tab; for 5 x 20 mm glass cartridge fuses
Electrical ratings are given by the fuse.

Color	Item No.	Pack. Unit
○ gray	2004-911	50

Technical Data	
250 V / I _N 6.3 A	Plug width: 6.1 mm / 0.24 inch

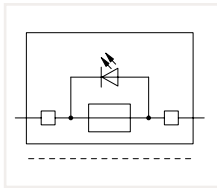

Fuse plug with pull-tab; for 5 x 20 mm glass cartridge fuses; with LED, gray
Electrical ratings are given by the fuse and blown fuse indication. Leakage current in case of a blown fuse: LED 2 mA

	Item No.	Pack. Unit
○ 12 ... 30 V	2004-911/1000-541	50
○ 30 ... 65 V	2004-911/1000-542	50
○ 120 V	2004-911/1000-867	50
○ 230 V	2004-911/1000-836	50

Approvals and corresponding ratings, visit www.wago.com

Accessories; for fuse plugs

Appropriate marking systems:
WMB/Marking strips

End plate for fuse terminal blocks; 2 mm thick

	orange	2002-992	100 (25)
	gray	2002-991	100 (25)

Shorting link; 5 x 20 mm; allows the fuse plug to be used as a disconnect plug

	I _N 6.3 A	281-503	250 (25)
--	----------------------	---------	----------

WMB marking card; white; 10 strips with 10 markers/card; 5 ... 5.2 mm stretchable

	plain	793-5501	5
--	-------	----------	---

WMB marking card; plain; 10 strips with 10 markers/card; 5 ... 5.2 mm stretchable

	yellow	793-5501/000-002	5
	red	793-5501/000-005	5
	blue	793-5501/000-006	5
	gray	793-5501/000-007	5
	orange	793-5501/000-012	5
	light green	793-5501/000-017	5
	green	793-5501/000-023	5
	violet	793-5501/000-024	5

Accessories; for fuse plugs

Appropriate marking systems: WMB/Marking strips

2-conductor carrier terminal block;
0.25 ... 2.5 (4) mm² / 22 ... 12 AWG
Terminal block width: 5.2 mm / 0.205 inch

	gray	2002-1661	50
--	------	-----------	----

End and intermediate plate; 1 mm thick

	orange	2002-1692	100 (25)
	gray	2002-1691	100 (25)

3-conductor carrier terminal block;
0.25 ... 2.5 (4) mm² / 22 ... 12 AWG
Terminal block width: 5.2 mm / 0.205 inch

	gray	2002-1761	50
--	------	-----------	----

End and intermediate plate; 1 mm thick

	orange	2002-1792	100 (25)
	gray	2002-1791	100 (25)

4-conductor carrier terminal block;
0.25 ... 2.5 (4) mm² / 22 ... 12 AWG
Terminal block width: 5.2 mm / 0.205 inch

	gray	2002-1861	50
--	------	-----------	----

End and intermediate plate; 1 mm thick

	orange	2002-1892	100 (25)
	gray	2002-1891	100 (25)

2-conductor carrier terminal block;
0.25 ... 2.5 (4) mm² / 22 ... 12 AWG
Terminal block width: 5.2 mm / 0.205 inch

	gray	2002-1961	50
--	------	-----------	----

End and intermediate plate; 1 mm thick

	orange	2002-1992	100 (25)
	gray	2002-1991	100 (25)

Double-deck carrier terminal block;
0.25 ... 2.5 (4) mm² / 22 ... 12 AWG
Terminal block width: 5.2 mm / 0.205 inch

	L/L	2002-2961	50
--	-----	-----------	----

Double-deck carrier terminal block;
0.25 ... 2.5 (4) mm² / 22 ... 12 AWG
Terminal block width: 5.2 mm / 0.205 inch

	L/N	2002-2963	50
--	-----	-----------	----

End and intermediate plate; 1 mm thick

	orange	2002-2992	100 (25)
	gray	2002-2991	100 (25)

Disconnect plug for carrier terminal blocks; suitable when using a carrier terminal block as disconnect terminal block

	orange	2002-401	100 (25)
--	--------	----------	----------

Fuse Plug TOPJOB® S on Carrier Terminal Blocks 2.5 (4) mm²

Technical Information

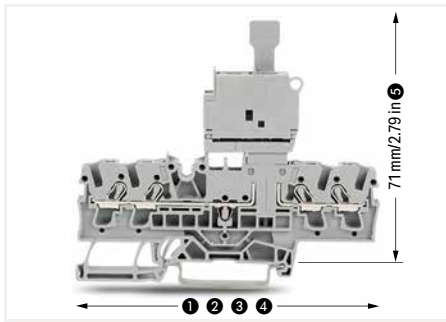

Fuse plug dimensions:

- ❶ 66.1 mm / 2.62 inch for 2002-1661
- ❷ 76.8 mm / 3.02 inch for 2002-1761
- ❸ 87.5 mm / 3.45 inch for 2002-1861
- ❹ 72.9 mm / 2.87 inch for 2002-1961
- ❺ with inserted fuse plug



Using fuse plugs with rail-mount terminal blocks for control circuit protection is highly advantageous because the function and wiring levels are separated:

- No additional cost for assembly and wiring
- No risk of accidental contact with live parts when disconnecting the fuse plug
- The fuse plug is completely separated from the carrier terminal block when replacing a fuse – away from current carrying parts
- The fuse plug can be removed by service personnel
- No unintentional reclosing of the circuit by another person
- Quickly exchange a fuse by using a prepared "stand-by plug"

Fuse plug features for quick and safe applications:

- Optional LED indicates blown fuse
- Top-of-unit marking slot provides clear carrier terminal block identification
- Two test slots with touch contacts
- Terminal blocks/plugs provide high-density wiring in a width of just 5.2/6.1 mm
- May be used as a disconnect plug in combination with a shorting link

Glass cartridge fuses 5 x 20

Series Item No.	Overload and short circuit protection		Short circuit protection only	
	Individual argmt.	Group argmt.	Individual argmt.	Group argmt.
Fuse terminal blocks				
2004-911 2004-911/.....	1.6 W	1.6 W	2.5 W	2.5 W

When selecting glass cartridge fuses, make sure that the maximum power loss listed below is not exceeded. The power loss is determined according to IEC or EN 60947-7-3/VDE 0611-6 at 23°C. The temperature rise of the terminal blocks must be checked according to their application and mounting. Higher ambient temperatures represent an additional impact on fuse cartridges. Therefore, in such applications, the rated current must be reduced if necessary. More details are available from the manufacturers.

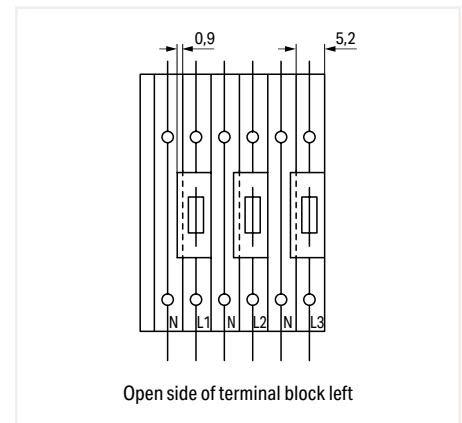

Please note:

The extra width of the plug (6.1 mm compared to 5.2 mm for carrier terminal blocks) must be compensated for with intermediate plates (1 mm) when building an assembly of carrier terminal blocks equipped with fuse plugs.

Fuse Plug TOPJOB® S on Carrier Terminal Block 6 (10) mm² 2006 Series

1

Technical Data		
800 V / I _n 10 A		
Plug width: 7.4 mm / 0.291 inch		

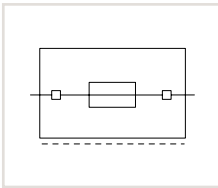

Fuse plug with pull-tab
Electrical ratings are given by the fuse.

for 5 x 20 mm glass cartridge fuse		
Color	Item No.	Pack. Unit
○ gray	2006-911	25

Technical Data		
800 V / I _n 10 A		
Plug width: 7.4 mm / 0.291 inch		

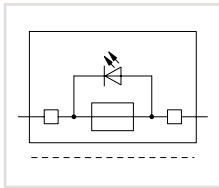

Fuse plug with pull-tab; with LED; gray
Electrical ratings are given by the fuse and blown fuse indication. Leakage current in case of a blown fuse: LED 2 mA

for 5 x 20 mm glass cartridge fuse		
	Item No.	Pack. Unit
○ 12 ... 30 V	2006-911/1000-541	25
○ 30 ... 65 V	2006-911/1000-542	25
○ 120 V	2006-911/1000-867	25
○ 230 V	2006-911/1000-836	25

Technical Data		
800 V / I _n 10 A		
Plug width: 10.4 mm / 0.409 inch		

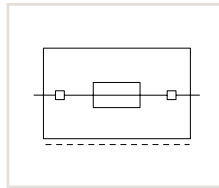

Fuse plug with pull-tab
Electrical ratings are given by the fuse.

for 1/4" x 1/4" glass cartridge fuse		
Color	Item No.	Pack. Unit
○ gray	2006-931/099-000	25

for 5 x 30 mm glass cartridge fuse		
○ gray	2006-921	25

for 5 x 30 mm glass cartridge fuse		
○ 12 ... 30 V	2006-921/1000-541	25
○ 30 ... 65 V	2006-921/1000-542	25
○ 120 V	2006-921/1000-867	25
○ 230 V	2006-921/1000-836	25
○ 380 ... 500 V	2006-921/1000-859	25

for 1/4" x 1/4" glass cartridge fuse		
○ gray	2006-931	25

for 1/4" x 1/4" glass cartridge fuse		
○ 12 ... 30 V	2006-931/1000-541	25
○ 30 ... 65 V	2006-931/1000-542	25
○ 120 V	2006-931/1000-867	25
○ 230 V	2006-931/1000-836	25
○ 380 ... 500 V	2006-931/1000-859	25

Accessories; item-specific		
End and intermediate plate; 1 mm thick		
orange	2006-1692	100 (25)
gray	2006-1691	100 (25)

Accessories; item-specific		
End and intermediate plate; 1 mm thick		
orange	2006-1692	100 (25)
gray	2006-1691	100 (25)

Accessories; item-specific		
Intermediate plate; 2.9 mm thick		
orange	2006-1696	100 (25)
gray	2006-1695	100 (25)

Accessories; for fuse plugs

End plate for fuse terminal blocks; 2 mm thick		
orange	2006-992	100 (25)
gray	2006-991	100 (25)

Appropriate marking systems: WMB/Marking strips

Shorting link; 5 x 20 mm; allows the fuse plug to be used as a disconnect plug		
I _n 6.3 A	281-503	250 (25)

Screwless end stop; for DIN-35 rail; 6 mm wide		
gray	249-116	100 (25)

2-conductor carrier terminal block; 0.5 ... 6 (10) mm ² / 20 ... 8 AWG Terminal block width: 7.5 mm / 0.295 inch		
gray	2006-1661	25
blue	2006-1664	25

WMB marking card; white; 10 strips with 10 markers/card; 5 ... 5.2 mm stretchable		
plain	793-5501	5

Screwless end stop; for DIN-35 rail; 10 mm wide		
gray	249-117	50 (25)

Technical Data
 800 V / I_n 10 A
 Plug width: 10.4 mm / 0.409 inch

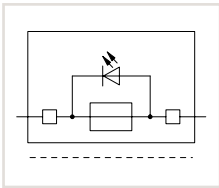

Fuse plug with pull-tab; with LED; gray
 Electrical ratings are given by the fuse and blown fuse indication. Leakage current in case of a blown fuse: LED 2 mA

for 1/4" x 1/4" glass cartridge fuse

	Item No.	Pack. Unit
○ 12 ... 30 V	2006-931/1099-541	25
○ 30 ... 65 V	2006-931/1099-542	25
○ 120 V	2006-931/1099-867	25
○ 230 V	2006-931/1099-836	25
○ 380 ... 500 V	2006-931/1099-859	25

Approvals and corresponding ratings, visit www.wago.com

Glass cartridge fuses

Series Item No.	Overload and short circuit protection		Short circuit protection only	
	Individual argmt.	Group argmt.	Individual argmt.	Group argmt.
Fused disconnect terminal blocks				
2006-911	7.5	1.6 W	1.6 W	2.5 W
2006-921	7.5	1.6 W	1.6 W	2.5 W
2006-931	7.5	1.6 W	1.6 W	2.5 W
2006-931 /099-...	10.4	2.5 W	2.5 W	2.5 W
2006-931 /1099-...	10.4	2.5 W	2.5 W	2.5 W

Using fuse plugs with rail-mount terminal blocks for control circuit protection is highly advantageous because the function and wiring levels are separated:

- No additional cost for assembly and wiring
- No risk of accidental contact with live parts when disconnecting the fuse plug
- The fuse plug is completely separated from the carrier terminal block when replacing a fuse – away from current carrying parts
- The fuse plug can be removed by service personnel
- No unintentional reclosing of the circuit by another person
- Quickly exchange a fuse by using a prepared "stand-by plug"

Fuse plug features for quick and safe applications:

- Optional LED indicates blown fuse
- Top-of-unit marking slot provides clear carrier terminal block identification
- Two test slots with touch contacts
- Terminal blocks/plugs provide high-density wiring in a width of just 7.5/7.4 (10.4) mm
- May be used as a disconnect plug in combination with a shorting link

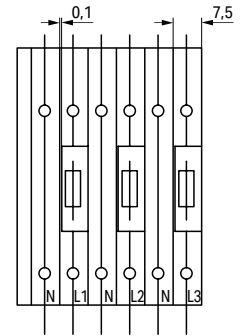

Open side of terminal block left

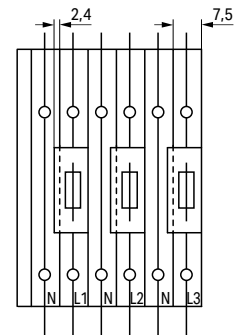

Open side of terminal block left

When using 10.4 mm wide plugs, please note: The extra width of the plug (10.4 mm compared to 7.5 mm for carrier terminal blocks) must be compensated for with intermediate plates (2.9 mm) when building an assembly of carrier terminal blocks equipped with fuse plugs.

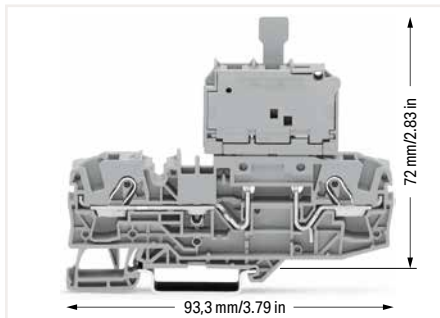

Fuse plug dimensions

Accessories; item-specific

Intermediate plate; 2.9 mm thick

orange	2006-1696	100 (25)
gray	2006-1695	100 (25)



Pivoting fuse holder with spare fuse holder



The end plate ensures that the fuse can only be removed when the fuse plug is pulled out.

Sensor Terminal Blocks and Actuator Terminal Blocks TOPJOB® S

2000 Series

Description and Installation

1



Commoning (signal level):
Commoning the signal level with push-in type jumper bars (2000 Series). Models with an LED can only be commoned in one jumper slot.
Test Plug Adapters can be used in all jumper slots.



Upper level: two independent signal pathways



Commoning (potential level):
Commoning potential levels via push-in type jumper bars (2000 Series).



Power supply:
Orange supply terminal block of same profile from both the cabinet and sensor sides

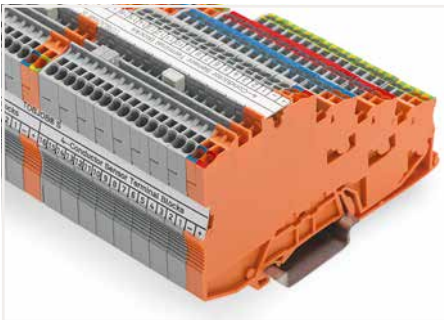

Marking:
Marking strips (2009-110) – from the top or the side

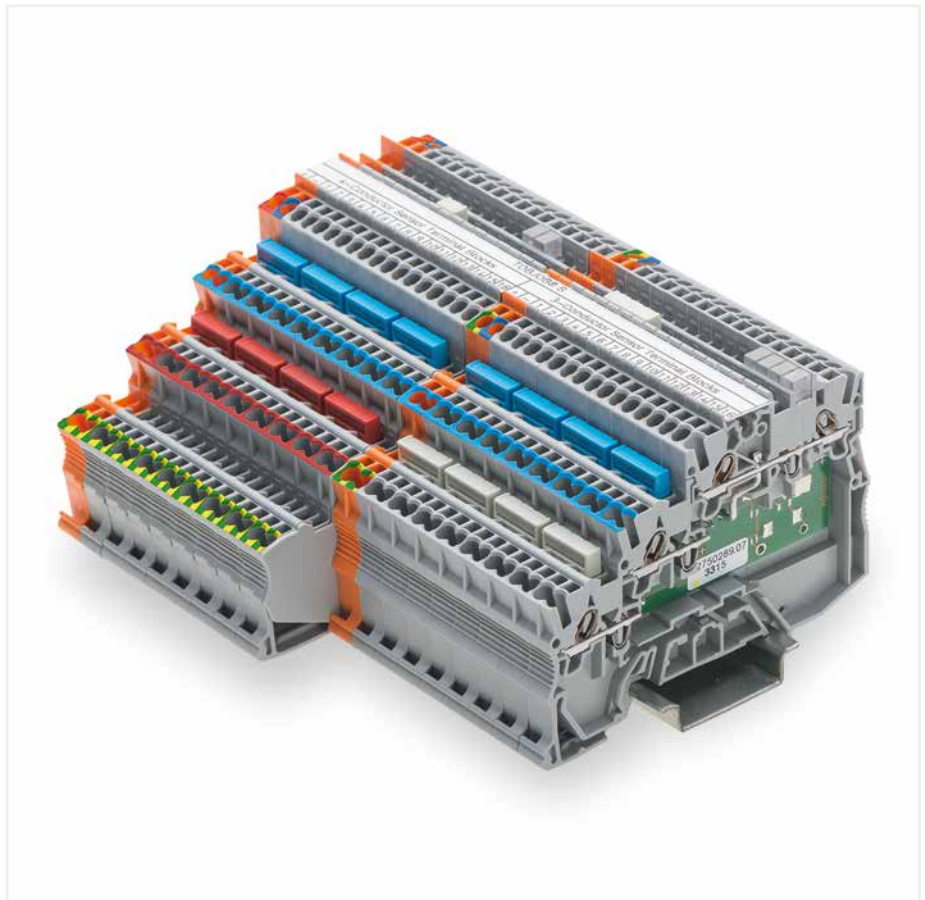

Terminal block assembly with 4-conductor sensor terminal blocks and 3-conductor actuator terminal blocks

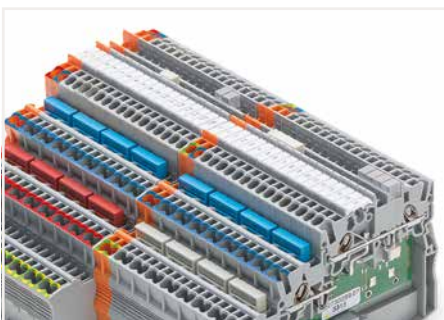

Marking:
3.5 mm WMB markers (793-35xx) from the top or the side – additional marking option via marker carrier

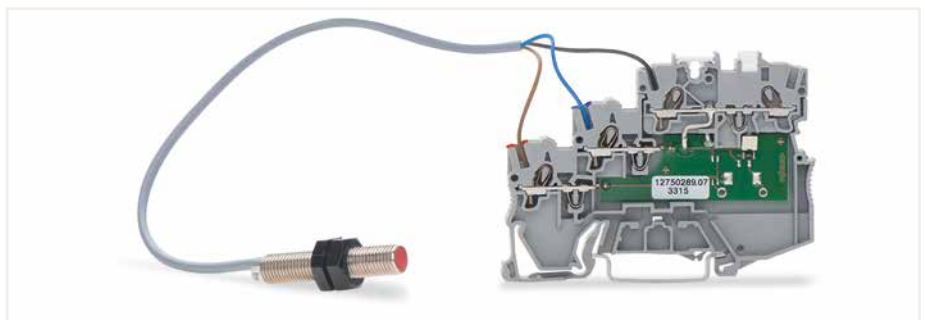

3-conductor sensor LED terminal block with a connected sensor



Commoning (potential level):
Continuous commoning in the potential levels via push-in type jumper bars for even pole numbers (2000 Series)



Potential levels: two adjacent commoning options on a current bar

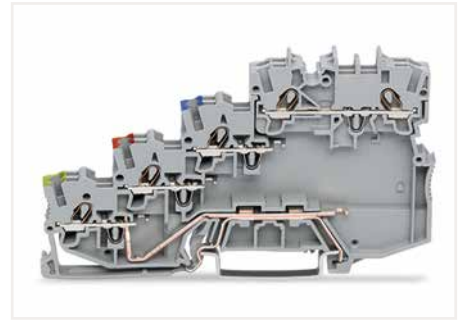

4-conductor sensor terminal block with ground contact

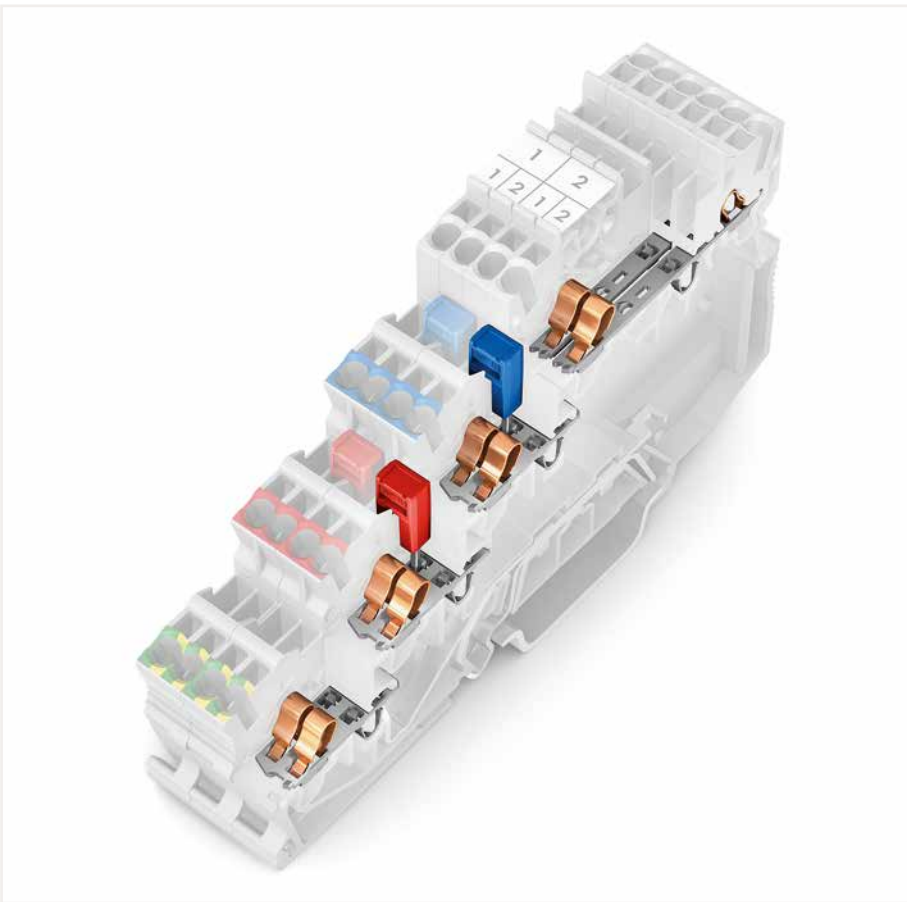

Upper level: two independent signal pathways, in 3.5 mm spacing per pole, with a dual jumper slot
Lower levels: two interconnected potential clamping units, with a single jumper slot, can be commoned in both directions



Ground commoning:
For sensor and actuator terminal blocks without ground connection to the DIN-rail, the ground connection can be performed by commoning to the terminal block with a ground foot.

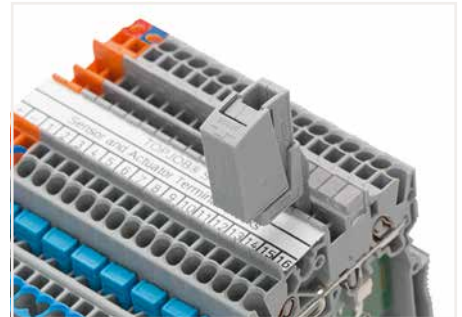

Testing via testing tap (2009-182) (up to max. 42 V).

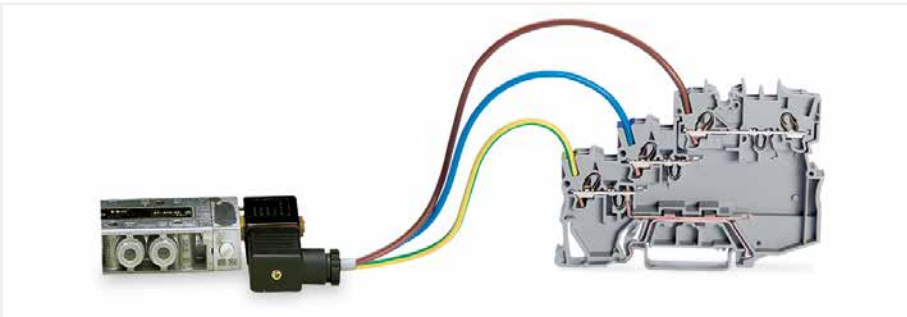

3-conductor actuator LED terminal block with a connected actuator

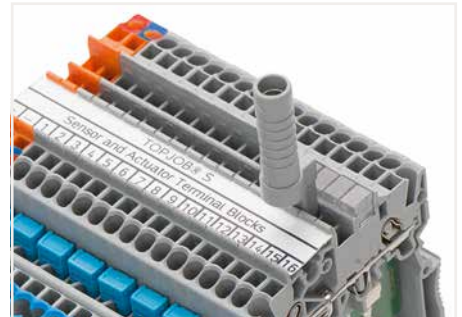

Testing via test plug adapter (2009-174) (up to max. 42 V).

3-Conductor Sensor Terminal Block TOPJOB® S

1 (1.5) mm²; 2000 Series

1

Technical Data	
0.14 ... 1 (1.5) mm ² ❶	24 ... 16 AWG
250 V/4 kV/3 ❷	300 V, 10 A
I _N 13.5 A	
Terminal block width: 7 mm / 0.276 inch ❸	
9 ... 11 mm / 0.35 ... 0.43 inch	

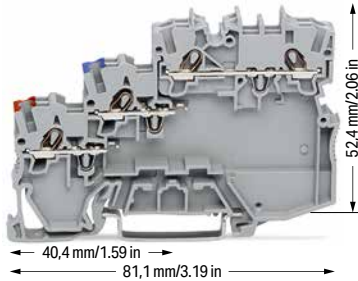

2000-5311

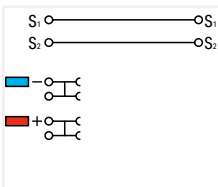

3-conductor sensor terminal block

Color	Item No.	Pack. Unit
gray	2000-5311	50

Technical Data	
0.14 ... 1 (1.5) mm ² ❶	24 ... 16 AWG
24 VDC	24 VDC
I _N 13.5 A	
Terminal block width: 7 mm / 0.276 inch ❸	
9 ... 11 mm / 0.35 ... 0.43 inch	

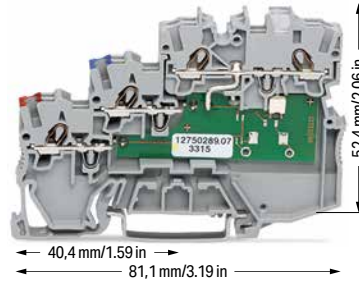

2000-5311/1102-950

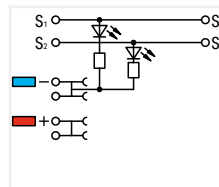

3-conductor sensor terminal block; yellow LED; for PNP (high-side) switching sensors

Color	Item No.	Pack. Unit
gray	2000-5311/1102-950	50

3-conductor sensor terminal block; yellow LED; for NPN (low-side) switching sensors

Color	Item No.	Pack. Unit
gray	2000-5311/1101-951	50

❶ Conductor range: 0.14 ... 1.5 mm² "s+f-st"; Push-in termination: 0.5 ... 1.5 mm² "s" and 0.5 ... 0.75 mm² "insulated ferrules; 12 mm" Depending on the conductor characteristic, a conductor with a smaller cross section can also be inserted via push-in termination.

❷ 250 V = rated voltage
4 kV = rated impulse voltage
3 = pollution degree (see Section 14)

❸ 3.5 mm spacing per signal (2 x 3.5 mm = 7 mm)
Note:
The double spacing per pole of this terminal block series maximizes connectivity. For example, ten sensors may be connected using only five sensor terminal blocks plus a power supply terminal block.

Please observe the application notes: Jumpers, from page 152

Approvals and corresponding ratings, visit www.wago.com

Accessories; for 3-conductor terminal blocks

Appropriate marking systems:
WMB/WMB Inline/Marking strips

End and intermediate plate; 1 mm thick; for 3-conductor terminal blocks

gray	2000-5391	100 (25)
------	-----------	----------

Push-in type jumper bar; insulated; I_N 14 A; light gray

2-way	2000-402	25
3-way	2000-403	25
4-way	2000-404	25
5-way	2000-405	25
6-way	2000-406	25
7-way	2000-407	25
8-way	2000-408	25
9-way	2000-409	25
10-way	2000-410	25

Colored push-in type jumper bar

- red .../000-005
- blue .../000-006

Push-in type jumper bar; insulated; I_N 14 A; light gray

1 to 3	2000-433	25
1 to 4	2000-434	25
1 to 5	2000-435	25
1 to 6	2000-436	25
1 to 7	2000-437	25
1 to 8	2000-438	25
1 to 9	2000-439	25
1 to 10	2000-440	25

Double-deck marker carrier; pivoting

gray	2000-121	50 (25)
------	----------	---------

Marking strip; plain; 11 mm wide; 50 m reel

white	2009-110	1
-------	----------	---

WMB marking card; white; 10 strips with 10 markers/card; for 3.5 mm terminal block width

plain	793-3501	5
-------	----------	---

Operating tool with a partially insulated shaft; type 1; (2.5 x 0.4) mm blade

	210-719	1
--	---------	---

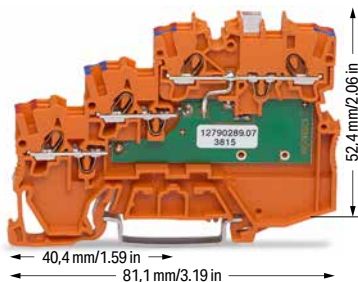

2000-5372/1102-953

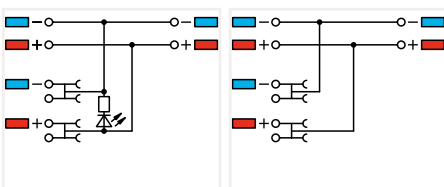

3-conductor sensor LED supply terminal block; green LED; 24 VDC

Color	Item No.	Pack. Unit
orange	2000-5372/1102-953	15

3-conductor sensor supply terminal block; max. 250 V; internally commoned

Color	Item No.	Pack. Unit
orange	2000-5372	15

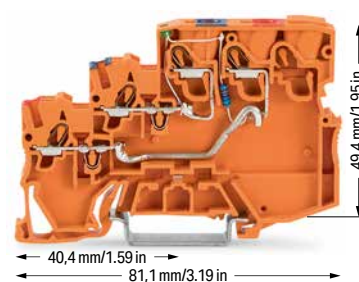

2000-5352/1102-953

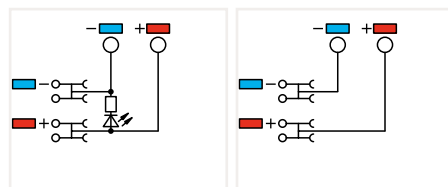

3-conductor sensor LED supply terminal block; green LED; 24 VDC control panel side: 2.5 (4) mm²; max. 28 A

Color	Item No.	Pack. Unit
orange	2000-5352/1102-953	50

3-conductor sensor supply terminal block; max. 250 V; control panel side: 2.5 (4) mm²; max. 28 A

Color	Item No.	Pack. Unit
orange	2000-5352	50

4-Conductor Sensor Terminal Block TOPJOB® S

1 (1.5) mm²; 2000 Series

Technical Data	
0.14 ... 1 (1.5) mm ² ①	24 ... 16 AWG
250 V/4 kV/3 ②	300 V, 10 A
I _N 13.5 A	
Terminal block width: 7 mm / 0.276 inch ③	
9 ... 11 mm / 0.35 ... 0.43 inch	

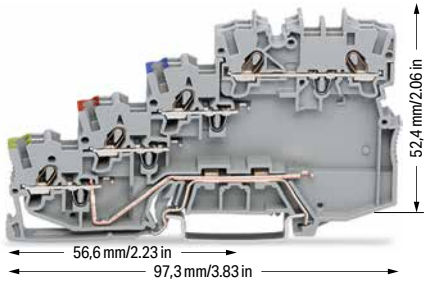

2000-5417

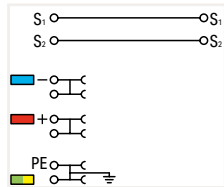

4-conductor sensor terminal block; with ground connection

Color	Item No.	Pack. Unit
gray	2000-5417	50

Technical Data	
0.14 ... 1 (1.5) mm ² ①	24 ... 16 AWG
24 VDC	24 VDC
I _N 13.5 A	
Terminal block width: 7 mm / 0.276 inch ③	
9 ... 11 mm / 0.35 ... 0.43 inch	

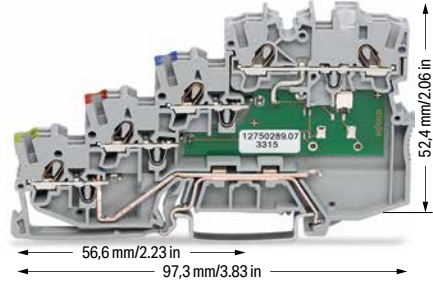

2000-5417/1102-950

2000-5417/1101-951

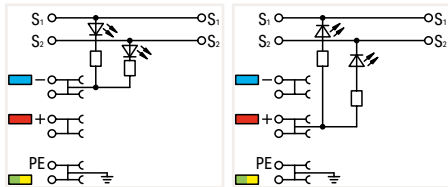

4-conductor sensor LED terminal block; yellow LED; for PNP (high-side) switching sensors; with ground connection

Color	Item No.	Pack. Unit
gray	2000-5417/1102-950	50

4-conductor sensor terminal block; yellow LED; for NPN (low-side) switching sensors; with ground connection

gray	2000-5417/1101-951	50
------	--------------------	----

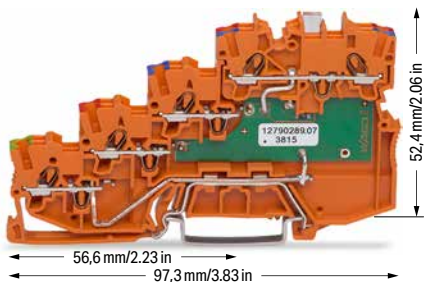

2000-5477/1102-953

2000-5477

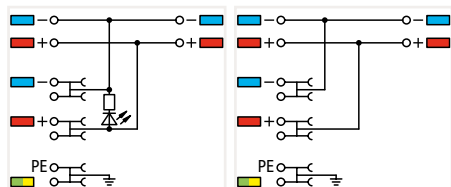

4-conductor sensor LED supply terminal block; green LED; 24 VDC; with ground connection

Color	Item No.	Pack. Unit
orange	2000-5477/1102-953	15

4-conductor sensor supply terminal block; max. 250 V; internally commoned; with ground connection

orange	2000-5477	15
--------	-----------	----

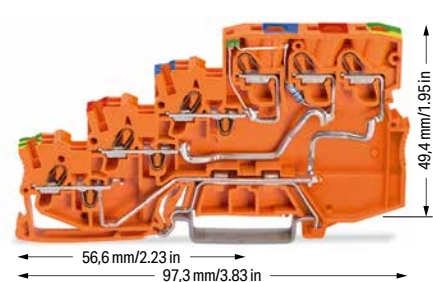

2000-5457/1102-953

2000-5457

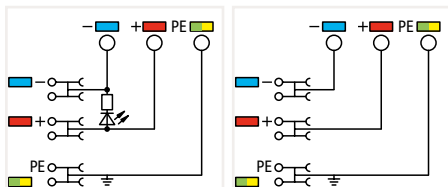

3-conductor sensor LED supply terminal block; green LED; 24 VDC control panel side: 2.5 (4) mm²; max. 28 A

Color	Item No.	Pack. Unit
orange	2000-5457/1102-953	15

4-conductor sensor supply terminal block; max. 250 V; with ground connection; control panel side: 2.5 (4) mm²; max. 28 A

orange	2000-5457	15
--------	-----------	----

① Conductor range: 0.14 ... 1.5 mm² "s+f-st"; Push-in termination: 0.5 ... 1.5 mm² "s" and 0.5 ... 0.75 mm² "insulated ferrules; 12 mm" Depending on the conductor characteristic, a conductor with a smaller cross section can also be inserted via push-in termination.

② 250 V = rated voltage
4 kV = rated impulse voltage
3 = pollution degree (see Section 14)

③ 3.5 mm spacing per signal (2 x 3.5 mm = 7 mm)
Note:
The double spacing per pole of this terminal block series maximizes connectivity. For example, ten sensors may be connected using only five sensor terminal blocks plus a power supply terminal block.

Please observe the application notes: Jumpers, from page 152

Approvals and corresponding ratings, visit www.wago.com

Accessories; for 4-conductor terminal blocks
Appropriate marking systems:
WMB/WMB Inline/Marking strips

End and intermediate plate; 1 mm thick; for 4-conductor terminal blocks

gray	2000-5491	100 (25)
------	-----------	----------

Push-in type jumper bar; insulated; I_N 14 A; light gray

2-way	2000-402	25
3-way	2000-403	25
4-way	2000-404	25
5-way	2000-405	25
6-way	2000-406	25
7-way	2000-407	25
8-way	2000-408	25
9-way	2000-409	25
10-way	2000-410	25

Colored push-in type jumper bar

red	.../000-005
blue	.../000-006
yellow-green	.../000-018

Push-in type jumper bar; insulated; I_N 14 A; light gray

1 to 3	2000-433	25
1 to 4	2000-434	25
1 to 5	2000-435	25
1 to 6	2000-436	25
1 to 7	2000-437	25
1 to 8	2000-438	25
1 to 9	2000-439	25
1 to 10	2000-440	25

Double-deck marker carrier; pivoting

gray	2000-121	50 (25)
------	----------	---------

Marking strip; plain; 11 mm wide; 50 m reel

white	2009-110	1
-------	----------	---

WMB marking card; white; 10 strips with 10 markers/card; for 3.5 mm terminal block width

plain	793-3501	5
-------	----------	---

Operating tool with a partially insulated shaft; type 1; (2.5 x 0.4) mm blade

	210-719	1
--	---------	---

3-Conductor Actuator Terminal Block TOPJOB® S

1 (1.5) mm²; 2000 Series

1

Technical Data

0.14 ... 1 (1.5) mm ² ①	24 ... 16 AWG
250 V/4 kV/3 ②	300 V, 10 A
I _N 13.5 A	
Terminal block width: 7 mm / 0.276 inch ③	
9 ... 11 mm / 0.35 ... 0.43 inch	

Technical Data

0.14 ... 1 (1.5) mm ² ①	24 ... 16 AWG
24 VDC	24 VDC
I _N 13.5 A	
Terminal block width: 7 mm / 0.276 inch ③	
9 ... 11 mm / 0.35 ... 0.43 inch	

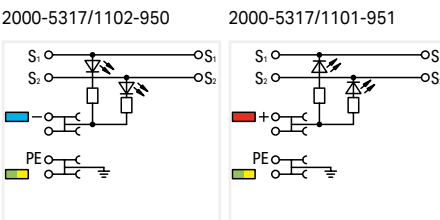
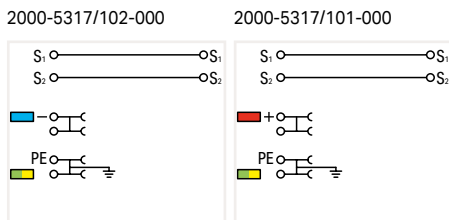
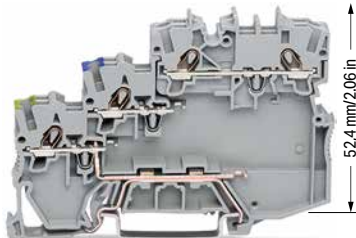

3-conductor actuator terminal block; for PNP (high-side) switching actuators; with ground connection

Color	Item No.	Pack. Unit
gray	2000-5317/102-000	50

3-conductor actuator terminal block; yellow LED; for PNP (high-side) switching actuators; with ground connection

Color	Item No.	Pack. Unit
gray	2000-5317/1102-950	50

3-conductor actuator terminal block; for NPN (low-side) switching actuators; with ground connection

Color	Item No.	Pack. Unit
gray	2000-5317/101-000	50

3-conductor actuator terminal block; yellow LED; for NPN (low-side) switching actuators; with ground connection

Color	Item No.	Pack. Unit
gray	2000-5317/1101-951	50

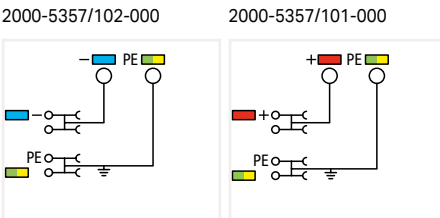
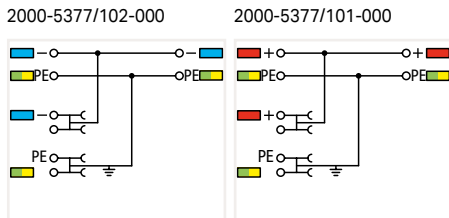
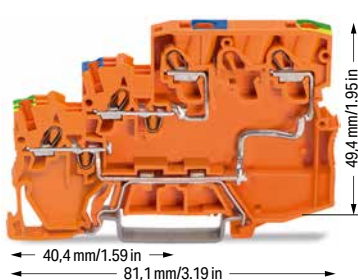
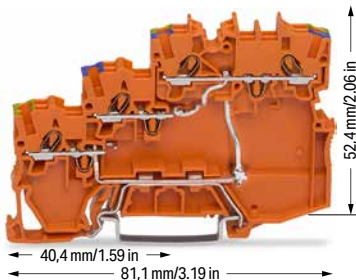

3-conductor actuator supply terminal block; max. 250 V; for PNP (high-side) switching actuators; with ground connection; internally commoned

Color	Item No.	Pack. Unit
orange	2000-5377/102-000	15

3-conductor actuator supply terminal block; max. 250 V; control panel side: 2.5 (4) mm²; max. 28 A; for PNP (high-side) switching actuators; with ground connection

Color	Item No.	Pack. Unit
orange	2000-5357/102-000	15

3-conductor actuator supply terminal block; max. 250 V; for NPN (low-side) switching actuators; with ground connection

Color	Item No.	Pack. Unit
orange	2000-5377/101-000	15

3-conductor actuator supply terminal block; max. 250 V; control panel side: 2.5 (4) mm²; max. 28 A; for NPN (low-side) switching actuators; with ground connection

Color	Item No.	Pack. Unit
orange	2000-5357/101-000	15

① Conductor range: 0.14 ... 1.5 mm² "s+f-st"; Push-in termination: 0.5 ... 1.5 mm² "s" and 0.5 ... 0.75 mm² "insulated ferrules; 12 mm" Depending on the conductor characteristic, a conductor with a smaller cross section can also be inserted via push-in termination.

② 250 V = rated voltage
4 kV = rated impulse voltage
3 = pollution degree (see Section 14)

③ 3.5 mm spacing per signal (2 x 3.5 mm = 7 mm)
Note:
The double spacing per pole of this terminal block series maximizes connectivity. For example, ten sensors may be connected using only five sensor terminal blocks plus a power supply terminal block.

Please observe the application notes: Jumpers, from page 152

Approvals and corresponding ratings, visit www.wago.com

Accessories; for 3-conductor terminal blocks

Appropriate marking systems:
WMB/WMB Inline/Marking strips

End and intermediate plate; 1 mm thick; for 3-conductor terminal blocks

gray	2000-5391	100 (25)
------	-----------	----------

Push-in type jumper bar; insulated; I_N 14 A; light gray

2-way	2000-402	25
3-way	2000-403	25
4-way	2000-404	25
5-way	2000-405	25
6-way	2000-406	25
7-way	2000-407	25
8-way	2000-408	25
9-way	2000-409	25
10-way	2000-410	25

Colored push-in type jumper bar

red	.../000-005
blue	.../000-006
yellow-green	.../000-018

Push-in type jumper bar; insulated; I_N 14 A; light gray

1 to 3	2000-433	25
1 to 4	2000-434	25
1 to 5	2000-435	25
1 to 6	2000-436	25
1 to 7	2000-437	25
1 to 8	2000-438	25
1 to 9	2000-439	25
1 to 10	2000-440	25

Double-deck marker carrier; pivoting

gray	2000-121	50 (25)
------	----------	---------

Marking strip; plain; 11 mm wide; 50 m reel

white	2009-110	1
-------	----------	---

WMB marking card; white; 10 strips with 10 markers/card; for 3.5 mm terminal block width

plain	793-3501	5
-------	----------	---

Operating tool with a partially insulated shaft; type 1; (2.5 x 0.4) mm blade

	210-719	1
--	---------	---

4-Conductor Sensor Terminal Block and 3-Conductor Actuator Terminal Block TOPJOB® S 1 (1.5) mm²; 2000 Series

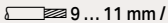
Technical Data	
0.14 ... 1 (1.5) mm ² ①	24 ... 16 AWG
250 V/4 kV/3 ②	300 V, 10 A
I _N 13.5 A	
Terminal block width: 7 mm / 0.276 inch ③	
 9 ... 11 mm / 0.35 ... 0.43 inch	



2000-5410

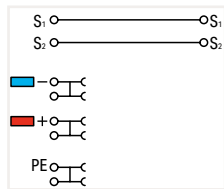

4-conductor sensor terminal block; with ground via push-in type jumper bar

Color	Item No.	Pack. Unit
○ gray	2000-5410	50

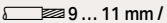
Technical Data	
0.14 ... 1 (1.5) mm ² ①	24 ... 16 AWG
24 VDC	24 VDC
I _N 13.5 A	
Terminal block width: 7 mm / 0.276 inch ③	
 9 ... 11 mm / 0.35 ... 0.43 inch	

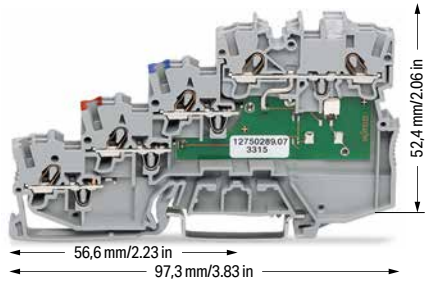

2000-5410/1102-950

2000-5410/1101-951

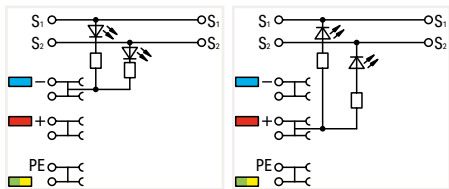

4-conductor sensor LED terminal block; yellow LED; for PNP (high-side) switching sensors; with ground via push-in type jumper bar

Color	Item No.	Pack. Unit
○ gray	2000-5410/1102-950	50

4-conductor sensor LED terminal block; yellow LED; for NPN (low-side) switching sensors; with ground via push-in type jumper bar

○ gray	2000-5410/1101-951	50
--------	--------------------	----

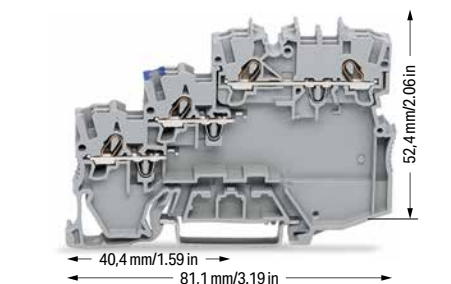

2000-5310/102-000

2000-5310/101-000

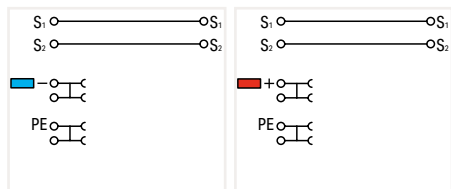

3-conductor actuator terminal block; for PNP (high-side) switching actuators; with ground via push-in type jumper bar

Color	Item No.	Pack. Unit
○ gray	2000-5310/102-000	50

3-conductor actuator terminal block; for NPN (low-side) switching actuators; with ground via push-in type jumper bar

○ gray	2000-5310/101-000	50
--------	-------------------	----

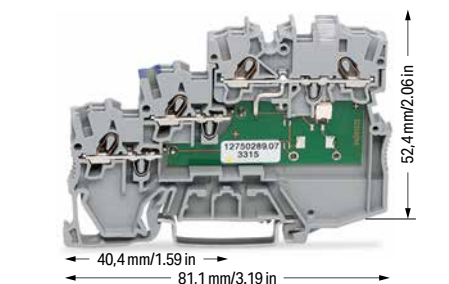

2000-5310/1102-950

2000-5310/1101-951

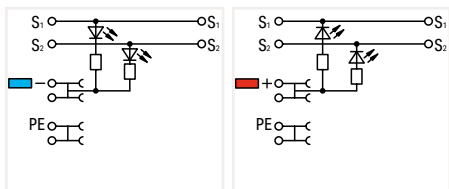

3-conductor actuator terminal block; yellow LED; for PNP (high-side) switching actuators; with ground via push-in type jumper bar

Color	Item No.	Pack. Unit
○ gray	2000-5310/1102-950	50

3-conductor actuator terminal block; yellow LED; for NPN (low-side) switching actuators; with ground via push-in type jumper bar

○ gray	2000-5310/1101-951	50
--------	--------------------	----

① Conductor range: 0.14 ... 1.5 mm² "s+f-st"; Push-in termination: 0.5 ... 1.5 mm² "s" and 0.5 ... 0.75 mm² "insulated ferrules; 12 mm" Depending on the conductor characteristic, a conductor with a smaller cross section can also be inserted via push-in termination.

② 250 V = rated voltage
4 kV = rated impulse voltage
3 = pollution degree
(see Section 14)

③ 3.5 mm spacing per signal (2 x 3.5 mm = 7 mm)
Note:
The double spacing per pole of this terminal block series maximizes connectivity. For example, ten sensors may be connected using only five sensor terminal blocks plus a power supply terminal block.

Please observe the application notes: Jumpers, from page 152

Approvals and corresponding ratings, visit www.wago.com

Accessories; for 4-conductor terminal blocks
Appropriate marking systems:
WMB/WMB Inline/Marking strips



End and intermediate plate; 1 mm thick; for 4-conductor terminal blocks

	gray	2000-5491	100 (25)
---	------	-----------	----------

Push-in type jumper bar; insulated; I_N 14 A; light gray

	2-way	2000-402	25
	3-way	2000-403	25
	4-way	2000-404	25
	5-way	2000-405	25
	6-way	2000-406	25
	7-way	2000-407	25
	8-way	2000-408	25
	9-way	2000-409	25
	10-way	2000-410	25

Colored push-in type jumper bar

-  red .../000-005
-  blue .../000-006
-  yellow-green .../000-018

Push-in type jumper bar; insulated; I_N 14 A; light gray

	1 to 3	2000-433	25
	1 to 4	2000-434	25
	1 to 5	2000-435	25
	1 to 6	2000-436	25
	1 to 7	2000-437	25
	1 to 8	2000-438	25
	1 to 9	2000-439	25
	1 to 10	2000-440	25

Double-deck marker carrier; pivoting

	gray	2000-121	50 (25)
---	------	----------	---------

Marking strip; plain; 11 mm wide; 50 m reel

	white	2009-110	1
---	-------	----------	---

WMB marking card; white; 10 strips with 10 markers/card; for 3.5 mm terminal block width

	plain	793-3501	5
---	-------	----------	---

Operating tool with a partially insulated shaft; type 1; (2.5 x 0.4) mm blade

		210-719	1
---	--	---------	---

PUSH-IN CAGE CLAMP®

Sensor Terminal Blocks and Actuator Terminal Blocks TOPJOB® S; with Pluggable Signal Level 2020 Series

Description and Installation

1

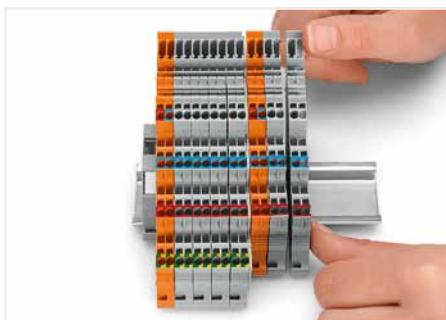

Snap individual terminal blocks onto the DIN-rail and slide together.



Separate terminal block assembly and slide individual terminal blocks laterally using an operating tool.

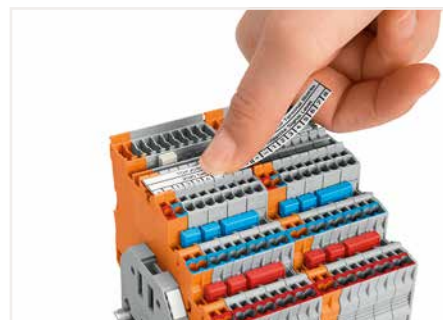

Labeling terminal blocks via marking strips (2009-110) or 3.5 mm wide WMB markers (793-35xx) – from the top or the side.

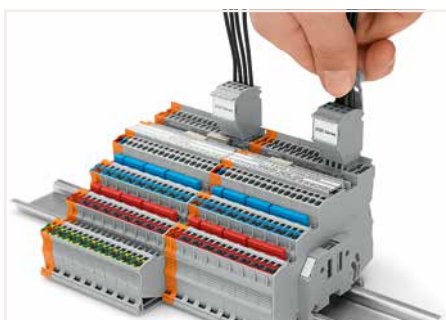

Removing a female plug via conductor bundle provided with strain relief plate.

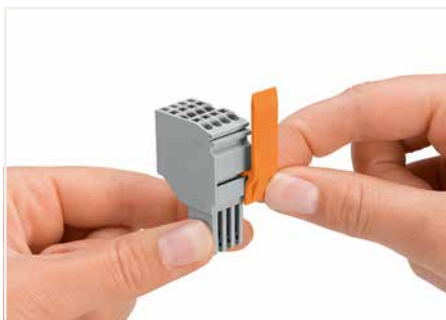
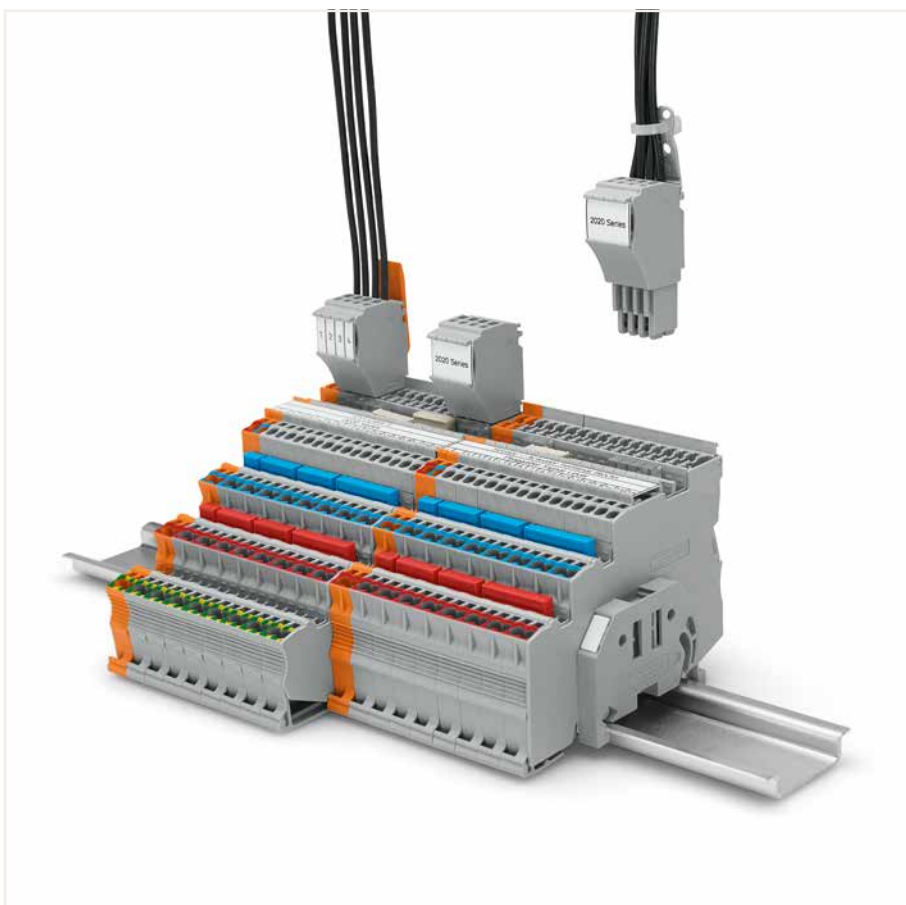

Slide the locking lever into position.



Testing via testing tap (2009-182) or test plug adapter (2009-174) (up to max. 42 V).



Insert coding pin into the corresponding slot and twist it off.



Remove the coding finger using a cutting tool.

3-Conductor Sensor Terminal Block TOPJOB® S; with Pluggable Signal Level 1 (1.5) mm²; 2020 Series

Technical Data	
0.14 ... 1 (1.5) mm ² ①	24 ... 16 AWG
250 V/4 kV/3 ②	300 V, 10 A
I _N 13.5 A	
Terminal block width: 7 mm / 0.276 inch ③	
9 ... 11 mm / 0.35 ... 0.43 inch	

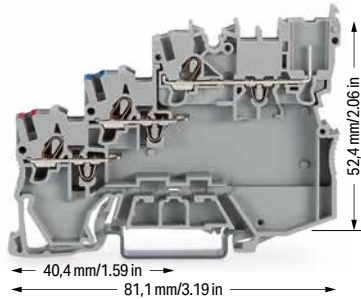

2020-5311

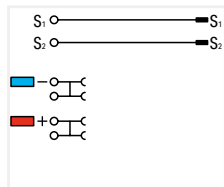

3-conductor sensor terminal block; with pluggable signal level

Color	Item No.	Pack. Unit
gray	2020-5311	50

Note:
According to EN 61984, pluggable connectors without a current interrupting capacity must not be mated or unmated when live or under load. An appropriate end plate must be applied to the carrier terminal blocks after each female plug.

Technical Data	
0.14 ... 1 (1.5) mm ² ①	24 ... 16 AWG
24 VDC	24 VDC
I _N 13.5 A	
Terminal block width: 7 mm / 0.276 inch ③	
9 ... 11 mm / 0.35 ... 0.43 inch	

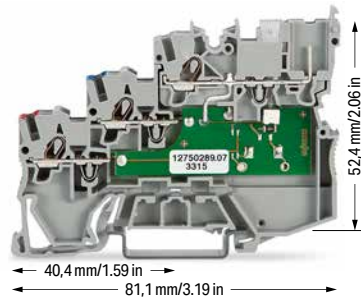

2020-5311/1102-950

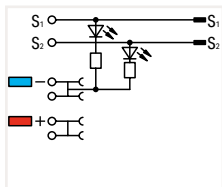

3-conductor sensor terminal block; yellow LED; for PNP (high-side) switching sensors; with pluggable signal level

Color	Item No.	Pack. Unit
gray	2020-5311/1102-950	50

- Conductor range: 0.14 ... 1.5 mm² "s+f-st"; Push-in termination: 0.5 ... 1.5 mm² "s" and 0.5 ... 0.75 mm² "insulated ferrules; 12 mm" Depending on the conductor characteristic, a conductor with a smaller cross section can also be inserted via push-in termination.
- 250 V = rated voltage
4 kV = rated impulse voltage
3 = pollution degree (see Section 14)

- 3.5 mm spacing per signal (2 x 3.5 mm = 7 mm)
Note:
The double spacing per pole of this terminal block series maximizes connectivity. For example, ten sensors may be connected using only five sensor terminal blocks plus a power supply terminal block.

Please observe the application notes: Jumpers, from page 152

Approvals and corresponding ratings, visit www.wago.com

Accessories; for 3-conductor terminal blocks

Appropriate marking systems:
WMB/WMB Inline/Marking strips

End and intermediate plate; 1 mm thick; for 3-conductor terminal blocks

gray	2020-5391	100 (25)
------	-----------	----------

Push-in type jumper bar; insulated; I_N 14 A; light gray

2-way	2000-402	25
3-way	2000-403	25
4-way	2000-404	25
5-way	2000-405	25
6-way	2000-406	25
7-way	2000-407	25
8-way	2000-408	25
9-way	2000-409	25
10-way	2000-410	25

Colored push-in type jumper bar

- red .../000-005
- blue .../000-006

Push-in type jumper bar; insulated; I_N 14 A; light gray

1 to 3	2000-433	25
1 to 4	2000-434	25
1 to 5	2000-435	25
1 to 6	2000-436	25
1 to 7	2000-437	25
1 to 8	2000-438	25
1 to 9	2000-439	25
1 to 10	2000-440	25

Carrier with 6 coding pins; for coding female plugs

orange	2020-100	100 (25)
--------	----------	----------

1-conductor female plug

gray	2020-102	100
------	----------	-----

2-conductor female plug

gray	2020-202	100
------	----------	-----

Test plug adapter; for 4 mm Ø test plug

gray	2009-174	100 (25)
------	----------	----------

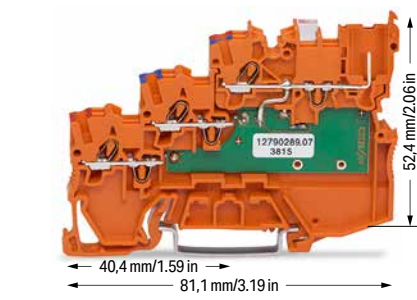

2020-5372/1102-953

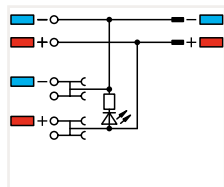

3-conductor sensor LED supply terminal block; green LED; 24 VDC; with pluggable signal level

Color	Item No.	Pack. Unit
orange	2020-5372/1102-953	15

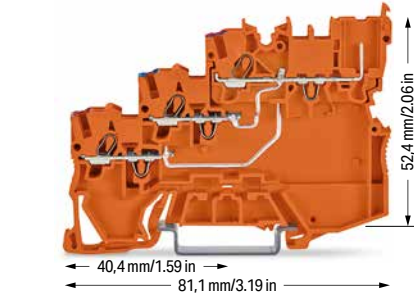

2020-5372

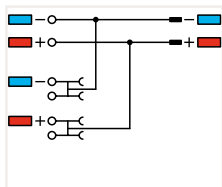

3-conductor sensor supply terminal block; max. 250 V; internally commoned; with pluggable signal level

Color	Item No.	Pack. Unit
orange	2020-5372	50

4-Conductor Sensor Terminal Block TOPJOB® S; with Pluggable Signal Level 1 (1.5) mm²; 2020 Series

1

Technical Data	
0.14 ... 1 (1.5) mm² ❶	24 ... 16 AWG
250 V/4 kV/3 ❷	300 V, 10 A
I _N 13.5 A	
Terminal block width: 7 mm / 0.276 inch ❸	
9 ... 11 mm / 0.35 ... 0.43 inch	



2020-5417

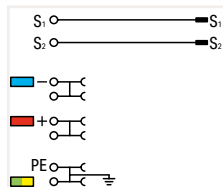

4-conductor sensor terminal block; with ground connection; with pluggable signal level

Color	Item No.	Pack. Unit
gray	2020-5417	50

Note:
According to EN 61984, pluggable connectors without a current interrupting capacity must not be mated or unmated when live or under load. An appropriate end plate must be applied to the carrier terminal blocks after each female plug.

Technical Data	
0.14 ... 1 (1.5) mm² ❶	24 ... 16 AWG
24 VDC	24 VDC
I _N 13.5 A	
Terminal block width: 7 mm / 0.276 inch ❸	
9 ... 11 mm / 0.35 ... 0.43 inch	

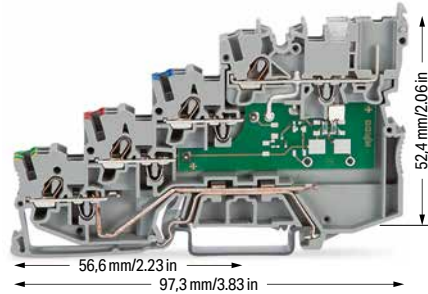

2020-5417/1102-950

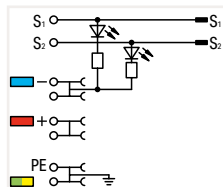

4-conductor sensor terminal block; yellow LED; for PNP (high-side) switching sensors; with ground connection; with pluggable signal level

Color	Item No.	Pack. Unit
gray	2020-5417/1102-950	50

❶ Conductor range: 0.14 ... 1.5 mm² "s+f-st"; Push-in termination: 0.5 ... 1.5 mm² "s" and 0.5 ... 0.75 mm² "insulated ferrules; 12 mm" Depending on the conductor characteristic, a conductor with a smaller cross section can also be inserted via push-in termination.

❷ 250 V = rated voltage
4 kV = rated impulse voltage
3 = pollution degree (see Section 14)

❸ 3.5 mm spacing per signal (2 x 3.5 mm = 7 mm)
Note:
The double spacing per pole of this terminal block series maximizes connectivity. For example, ten sensors may be connected using only five sensor terminal blocks plus a power supply terminal block.

Please observe the application notes: Jumpers, from page 152

Approvals and corresponding ratings, visit www.wago.com

Accessories; for 4-conductor terminal blocks

Appropriate marking systems:
WMB/WMB Inline/Marking strips

End and intermediate plate; 1 mm thick; for 4-conductor terminal blocks

gray	2020-5491	100 (25)
------	-----------	----------

Push-in type jumper bar; insulated; I_N 14 A; light gray

2-way	2000-402	25
3-way	2000-403	25
4-way	2000-404	25
5-way	2000-405	25
6-way	2000-406	25
7-way	2000-407	25
8-way	2000-408	25
9-way	2000-409	25
10-way	2000-410	25

Colored push-in type jumper bar

red	.../000-005
blue	.../000-006
yellow-green	.../000-018

Push-in type jumper bar; insulated; I_N 14 A; light gray

1 to 3	2000-433	25
1 to 4	2000-434	25
1 to 5	2000-435	25
1 to 6	2000-436	25
1 to 7	2000-437	25
1 to 8	2000-438	25
1 to 9	2000-439	25
1 to 10	2000-440	25

Carrier with 6 coding pins; for coding female plugs

orange	2020-100	100 (25)
--------	----------	----------

1-conductor female plug

gray	2020-102	100
------	----------	-----

2-conductor female plug

gray	2020-202	100
------	----------	-----

Test plug adapter; for 4 mm Ø test plug

gray	2009-174	100 (25)
------	----------	----------

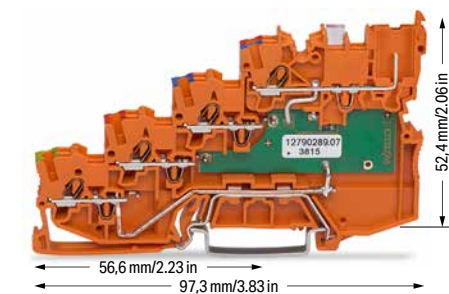

2020-5477/1102-953

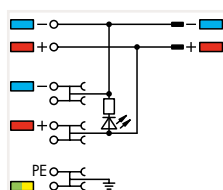

4-conductor sensor LED supply terminal block; green LED; 24 VDC; with ground connection; with pluggable signal level

Color	Item No.	Pack. Unit
orange	2020-5477/1102-953	15

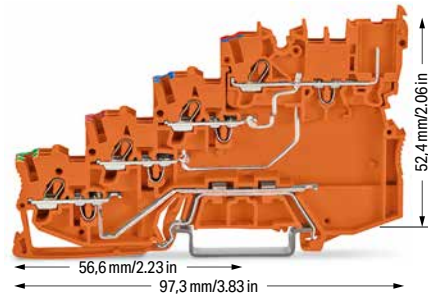

2020-5477

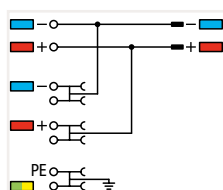

4-conductor sensor supply terminal block; max. 250 V; internally commoned; with ground connection; with pluggable signal level

Color	Item No.	Pack. Unit
orange	2020-5477	50

3-Conductor Actuator Terminal Block TOPJOB® S; with Pluggable Signal Level 1 (1.5) mm²; 2020 Series

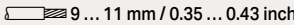
Technical Data	
0.14 ... 1 (1.5) mm ² ①	24 ... 16 AWG
250 V/4 kV/3 ②	300 V, 10 A
I _N 13.5 A	
Terminal block width: 7 mm / 0.276 inch ③	
	

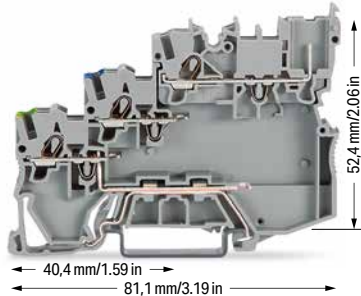

2020-5317/102-000

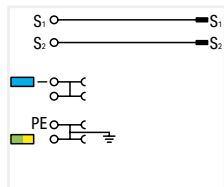

3-conductor actuator terminal block; for PNP (high-side) switching actuators; with ground connection; with pluggable signal level

Color	Item No.	Pack. Unit
gray	2020-5317/102-000	50

Note:
According to EN 61984, pluggable connectors without a current interrupting capacity must not be mated or unmated when live or under load. An appropriate end plate must be applied to the carrier terminal blocks after each female plug.

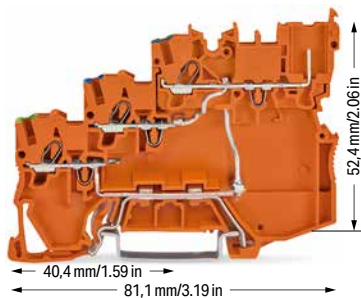

2020-5377/102-000

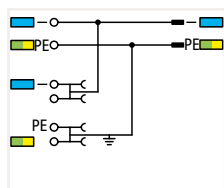

3-conductor actuator supply terminal block; for PNP (high-side) switching actuators; with ground connection; internally commoned; with pluggable signal level

Color	Item No.	Pack. Unit
orange	2020-5377/102-000	15

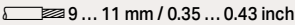
Technical Data	
0.14 ... 1 (1.5) mm ² ①	24 ... 16 AWG
24 VDC	24 VDC
I _N 13.5 A	
Terminal block width: 7 mm / 0.276 inch ③	
	

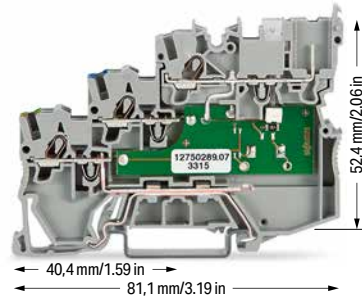

2020-5317/1102-950

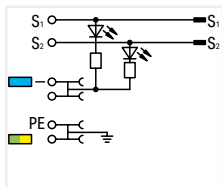

3-conductor actuator terminal block; yellow LED; for PNP (high-side) switching actuators; with ground connection; with pluggable signal level

Color	Item No.	Pack. Unit
gray	2020-5317/1102-950	50

- Conductor range: 0.14 ... 1.5 mm² "s-f-st"; Push-in termination: 0.5 ... 1.5 mm² "s" and 0.5 ... 0.75 mm² "insulated ferrules; 12 mm"
Depending on the conductor characteristic, a conductor with a smaller cross section can also be inserted via push-in termination.
- 250 V = rated voltage
4 kV = rated impulse voltage
3 = pollution degree
(see Section 14)

- 3.5 mm spacing per signal (2 x 3.5 mm = 7 mm)
Note:
The double spacing per pole of this terminal block series maximizes connectivity. For example, ten sensors may be connected using only five sensor terminal blocks plus a power supply terminal block.

Please observe the application notes: Jumpers, from page 152

Approvals and corresponding ratings, visit www.wago.com

Accessories; for 3-conductor terminal blocks

Appropriate marking systems:
WMB/WMB Inline/Marking strips

End and intermediate plate; 1 mm thick; for 3-conductor terminal blocks

	gray	2020-5391	100 (25)
---	------	-----------	----------

Push-in type jumper bar; insulated; I_N 14 A; light gray

	2-way	2000-402	25
	3-way	2000-403	25
	4-way	2000-404	25
	5-way	2000-405	25
	6-way	2000-406	25
	7-way	2000-407	25
	8-way	2000-408	25
	9-way	2000-409	25
	10-way	2000-410	25

Colored push-in type jumper bar

- red .../000-005
- blue .../000-006
- yellow-green .../000-018

Push-in type jumper bar; insulated; I_N 14 A; light gray

	1 to 3	2000-433	25
	1 to 4	2000-434	25
	1 to 5	2000-435	25
	1 to 6	2000-436	25
	1 to 7	2000-437	25
	1 to 8	2000-438	25
	1 to 9	2000-439	25
	1 to 10	2000-440	25

Carrier with 6 coding pins; for coding female plugs

	orange	2020-100	100 (25)
---	--------	----------	----------

1-conductor female plug

	gray	2020-102	100
---	------	----------	-----

2-conductor female plug

	gray	2020-202	100
---	------	----------	-----

Test plug adapter; for 4 mm Ø test plug

	gray	2009-174	100 (25)
---	------	----------	----------

Diode Terminal Block and LED Terminal Block TOPJOB® S

1.5 (2.5) mm²; 2001 Series

1

Technical Data	
0.25 ... 1.5 (2.5) mm ² ①	22 ... 14 AWG
U _N 250 V; U _{RM} 1000 V	
1N4007 - 0.5 A continuous current	
Terminal block width: 4.2 mm / 0.165 inch	
9 ... 11 mm / 0.35 ... 0.43 inch	

Technical Data	
0.25 ... 1.5 (2.5) mm ² ①	22 ... 14 AWG
U _N 250 V; U _{RM} 1000 V	
1N4007 - 0.5 A continuous current	
Terminal block width: 4.2 mm / 0.165 inch	
9 ... 11 mm / 0.35 ... 0.43 inch	

Technical Data	
0.25 ... 1.5 (2.5) mm ² ①	22 ... 14 AWG
24 VDC	
I _F 0.025 A max.	
Terminal block width: 4.2 mm / 0.165 inch	
9 ... 11 mm / 0.35 ... 0.43 inch	

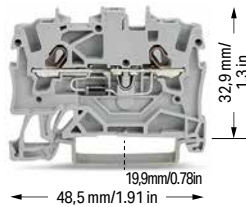

2001-1211/1000-411 2001-1211/1000-410

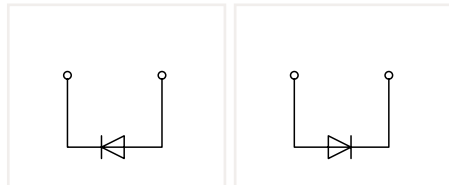

2-conductor diode terminal block; with 1N4007 diode

Color	Item No.	Pack. Unit
○ gray	2001-1211/1000-411	100
○ gray	2001-1211/1000-410	100

Other terminal blocks with the same profile:
Through 2001-1201 Page 48

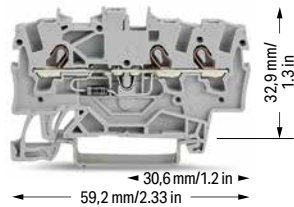

2001-1311/1000-411 2001-1311/1000-410

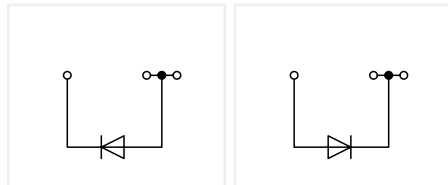

3-conductor diode terminal block; with 1N4007 diode

Color	Item No.	Pack. Unit
○ gray	2001-1311/1000-411	100
○ gray	2001-1311/1000-410	100

Other terminal blocks with the same profile:
Through 2001-1301 Page 48

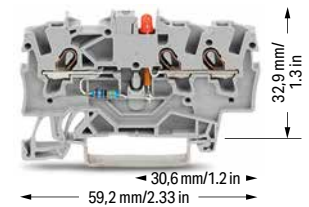

2001-1321/1000-434 2001-1321/1000-413

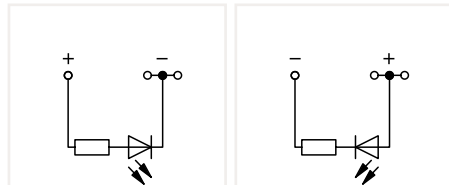

3-conductor LED terminal block; with red LED
Notice: This LED terminal block cannot be commoned with push-in type jumper bars.

Color	Item No.	Pack. Unit
○ gray	2001-1321/1000-434	100
○ gray	2001-1321/1000-413	100

Other terminal blocks with the same profile:
Through 2001-1301 Page 48



2001-1411/1000-411 2001-1411/1000-410

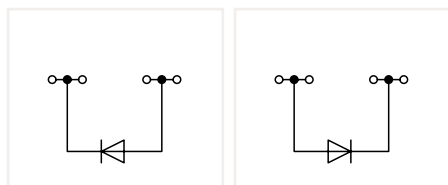

4-conductor diode terminal block; with 1N4007 diode

Color	Item No.	Pack. Unit
○ gray	2001-1411/1000-411	100
○ gray	2001-1411/1000-410	100

Other terminal blocks with the same profile:
Through 2001-1401 Page 48



2001-1411/1000-434 2001-1411/1000-413

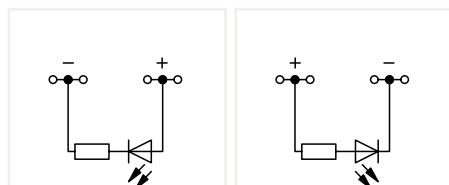

4-conductor LED terminal block; with red LED
Notice: This LED terminal block cannot be commoned with push-in type jumper bars.

Color	Item No.	Pack. Unit
○ gray	2001-1421/1000-434	100
○ gray	2001-1421/1000-413	100

Other terminal blocks with the same profile:
Through 2001-1401 Page 48

Diode Terminal Blocks and LED Terminal Blocks TOPJOB® S Circuit Configuration Examples

❶ Conductor range: 0.25 ... 2.5 mm² "s+f-st";
Push-in termination: 0.75 ... 2.5 mm² "s" and
0.75 ... 1.5 mm² "insulated ferrules; 12 mm"
Depending on the conductor characteristic, a conductor with a smaller cross section can also be inserted via push-in termination.

Approvals and corresponding ratings, visit www.wago.com

Accessories; 2001 Series

Appropriate marking systems:
WMB/WMB Inline/Marking strips

Insulation stop; 5 pcs/strip; 0.25 ... 0.5 mm²

light gray	2001-171	200 (25)
------------	----------	----------



Push-in type jumper bar; insulated; I_N 18 A; light gray

2-way	2001-402	25
3-way	2001-403	25
4-way	2001-404	25
5-way	2001-405	25
6-way	2001-406	25
7-way	2001-407	25
8-way	2001-408	25
9-way	2001-409	25
10-way	2001-410	25



Push-in type jumper bar; insulated; I_N 18 A; light gray

1 to 3	2001-433	25
1 to 4	2001-434	25
1 to 5	2001-435	25
1 to 6	2001-436	25
1 to 7	2001-437	25
1 to 8	2001-438	25
1 to 9	2001-439	25
1 to 10	2001-440	25

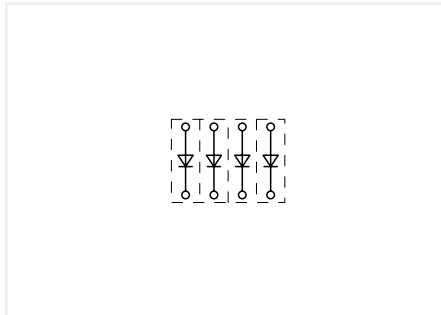

Open diode gates can be created using the following terminal blocks:
2001-1211/1000-410 or 2001-1211/1000-411



These diode terminal blocks have been specially developed for custom diode circuits, such as lamp test and collective fault signal circuits.

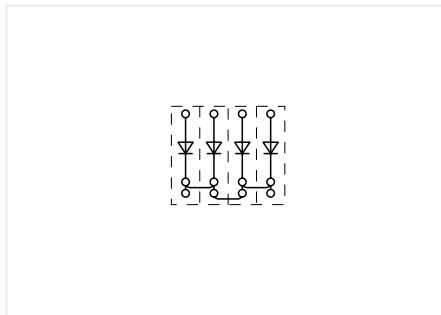

Polarized diode gates with a common cathode can be created using the following terminal blocks:
2001-1311/1000-410 or 2001-1311/1000-411

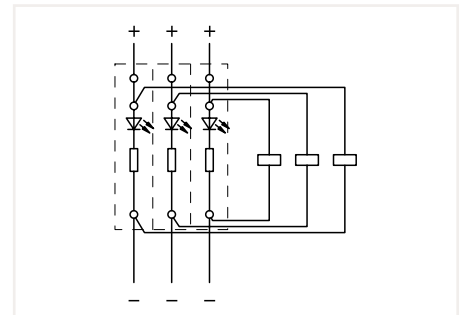

Circuit-related voltage indications can be created using the following terminal blocks:
2001-1321/1000-434 or 2001-1321/1000-413

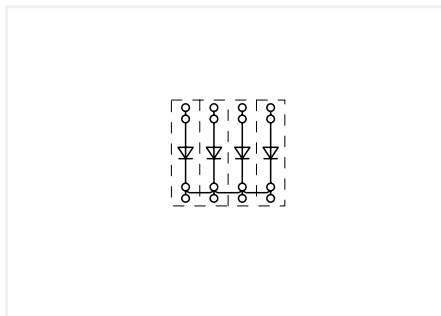

Polarized diode gates with a common cathode can be created using the following terminal blocks:
2001-1411/1000-410 or 2001-1411/1000-411

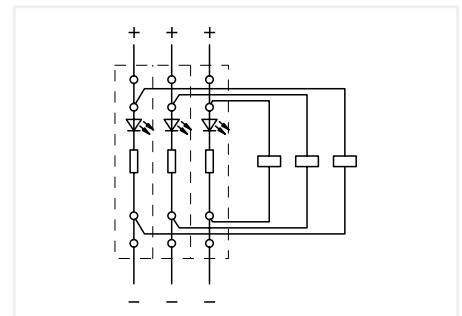

Circuit-related voltage indications can be created using the following terminal blocks:
2001-1421/1000-434 or 2001-1421/1000-413

Sold & Serviced By:



Toll Free Phone (877) SERV098

www.electromate.com

sales@electromate.com

Diode Terminal Block and LED Terminal Block TOPJOB® S

2.5 (4) mm²; 2002 Series

1

Technical Data	
0.25 ... 2.5 (4) mm ² ①	22 ... 12 AWG
U _N 250 V; U _{RM} 1000 V	
1N4007 - 0.5 A continuous current	
Terminal block width: 5.2 mm / 0.205 inch	
10 ... 12 mm / 0.39 ... 0.47 inch	

Technical Data	
0.25 ... 2.5 (4) mm ² ①	22 ... 12 AWG
U _N 250 V; U _{RM} 1000 V	
1N4007 - 0.5 A continuous current	
Terminal block width: 5.2 mm / 0.205 inch	
10 ... 12 mm / 0.39 ... 0.47 inch	

Technical Data	
0.25 ... 2.5 (4) mm ² ①	22 ... 12 AWG
24 VDC	
I _F 0.025 A max.	
Terminal block width: 5.2 mm / 0.205 inch	
10 ... 12 mm / 0.39 ... 0.47 inch	

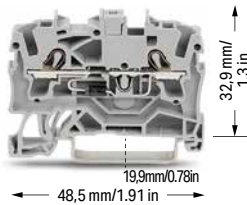

2002-1211/1000-411 2002-1211/1000-410

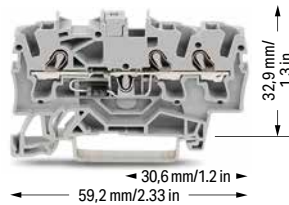

2002-1311/1000-411 2002-1311/1000-410

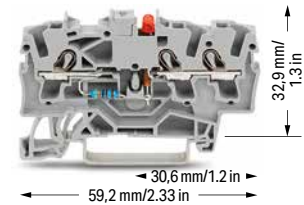

2002-1321/1000-434 2002-1321/1000-413

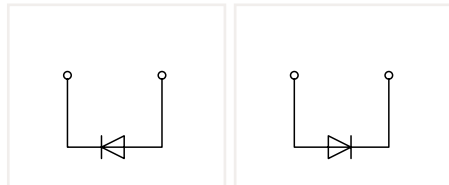

2-conductor diode terminal block; with 1N4007 diode

Color	Item No.	Pack. Unit
○ gray	2002-1211/1000-411	100
○ gray	2002-1211/1000-410	100

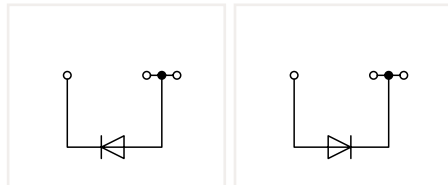

3-conductor diode terminal block; with 1N4007 diode

Color	Item No.	Pack. Unit
○ gray	2002-1311/1000-411	100
○ gray	2002-1311/1000-410	100

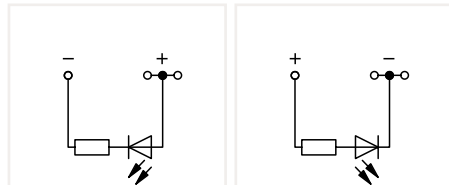

3-conductor LED terminal block; with red LED
Notice: This LED terminal block cannot be commoned with push-in type jumper bars.

Color	Item No.	Pack. Unit
○ gray	2002-1321/1000-434	100
○ gray	2002-1321/1000-413	100

Other terminal blocks with the same profile:
Through 2002-1201 Page 64

Other terminal blocks with the same profile:
Through 2002-1301 Page 64

Other terminal blocks with the same profile:
Through 2002-1301 Page 64



2002-1411/1000-411 2002-1411/1000-410



2002-1411/1000-434 2002-1411/1000-413

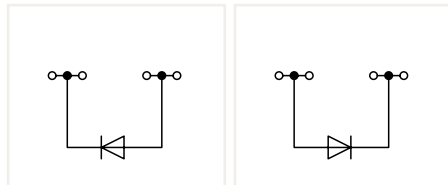

4-conductor diode terminal block; with 1N4007 diode

Color	Item No.	Pack. Unit
○ gray	2002-1411/1000-411	100
○ gray	2002-1411/1000-410	100

Other terminal blocks with the same profile:
Through 2002-1401 Page 64

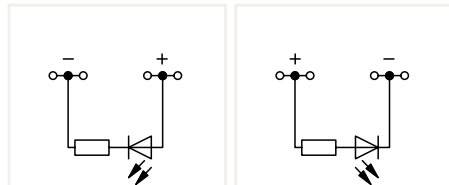

4-conductor LED terminal block; with red LED
Notice: This LED terminal block cannot be commoned with push-in type jumper bars.

Color	Item No.	Pack. Unit
○ gray	2002-1421/1000-434	100
○ gray	2002-1421/1000-413	100

Other terminal blocks with the same profile:
Through 2002-1401 Page 64

Diode Terminal Blocks and LED Terminal Blocks TOPJOB® S Circuit Configuration Examples

❶ Conductor range: 0.25 ... 4 mm² "s+f-st";
Push-in termination: 1 ... 4 mm² "s" and 1 ... 2.5 mm²
"insulated ferrules, 12 mm"
Depending on the conductor characteristic, a conductor with a smaller cross section can also be inserted via push-in termination.

Approvals and corresponding ratings, visit www.wago.com

Accessories; 2002 Series

Appropriate marking systems:
WMB/WMB Inline/Marking strips

Insulation stop; 5 pcs/strip; 0.25 ... 0.5 mm²

light gray	2002-171	200 (25)
------------	----------	----------



Insulation stop; 5 pcs/strip; 0.75 ... 1 mm²

dark gray	2002-172	200 (25)
-----------	----------	----------



Push-in type jumper bar; insulated; I_N 25 A; light gray

2-way	2002-402	25
3-way	2002-403	25
4-way	2002-404	25
5-way	2002-405	25
6-way	2002-406	25
7-way	2002-407	25
8-way	2002-408	25
9-way	2002-409	25
10-way	2002-410	25



Push-in type jumper bar; insulated; I_N 25 A; light gray

1 to 3	2002-433	25
1 to 4	2002-434	25
1 to 5	2002-435	25
1 to 6	2002-436	25
1 to 7	2002-437	25
1 to 8	2002-438	25
1 to 9	2002-439	25
1 to 10	2002-440	25

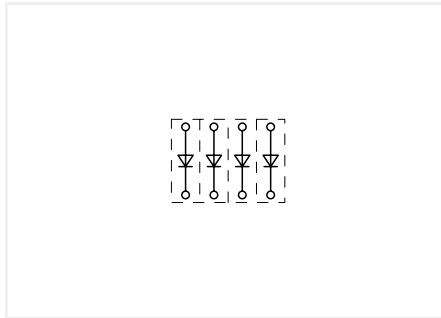

Open diode gates can be created using the following terminal blocks:
2002-1211/1000-410 or 2002-1211/1000-411



Using LED terminal blocks, monitoring units can be designed, e.g., for control and operating circuits.

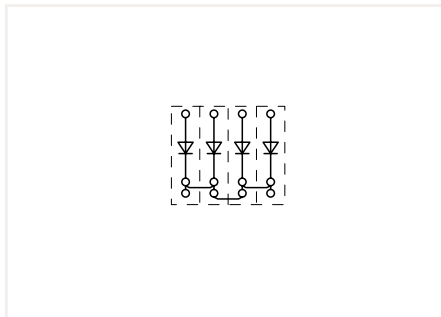

Polarized diode gates with a common cathode can be created using the following terminal blocks:
2002-1311/1000-410 or 2002-1311/1000-411

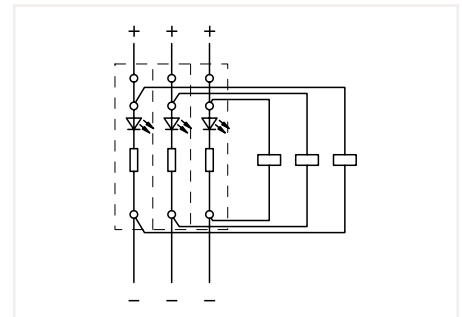

Circuit-related voltage indications can be created using the following terminal blocks:
2002-1321/1000-434 or 2002-1321/1000-413

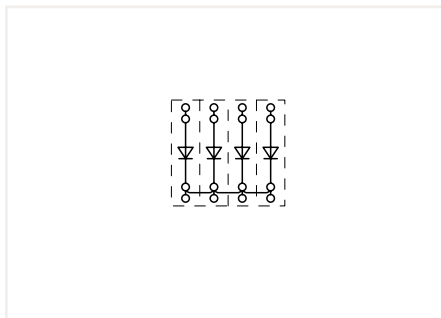

Polarized diode gates with a common cathode can be created using the following terminal blocks:
2002-1411/1000-410 or 2002-1411/1000-411

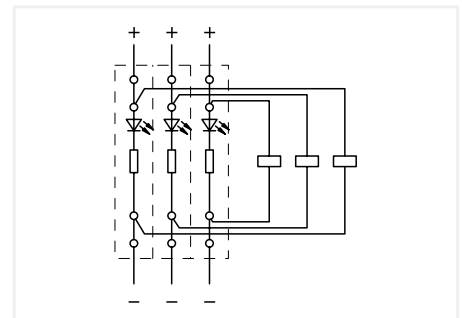

Circuit-related voltage indications can be created using the following terminal blocks:
2002-1421/1000-434 or 2002-1421/1000-413

Diode Terminal Block TOPJOB® S

4 (6) mm²; 2004 Series

1

Technical Data	
0.5 ... 4 (6) mm ² ①	20 ... 10 AWG
U _N 250 V; U _{RM} 1000 V	
1N5408 - 1.5 A continuous current	
Terminal block width: 6.2 mm / 0.244 inch	
11 ... 13 mm / 0.43 ... 0.51 inch	

Technical Data	
0.5 ... 4 (6) mm ² ①	20 ... 10 AWG
U _N 250 V; U _{RM} 1000 V	
1N5408 - 1.5 A continuous current	
Terminal block width: 6.2 mm / 0.244 inch	
11 ... 13 mm / 0.43 ... 0.51 inch	

Technical Data	
0.5 ... 4 (6) mm ² ①	20 ... 10 AWG
U _N 250 V; U _{RM} 1000 V	
1N5408 - 1.5 A continuous current	
Terminal block width: 6.2 mm / 0.244 inch	
11 ... 13 mm / 0.43 ... 0.51 inch	

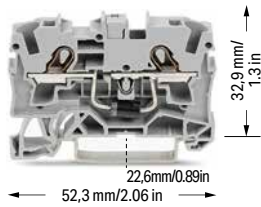

2004-1211/1000-401 2004-1211/1000-400

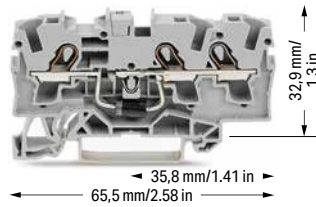

2004-1311/1000-401 2004-1311/1000-400

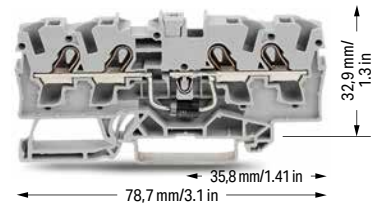

2004-1411/1000-401 2004-1411/1000-400

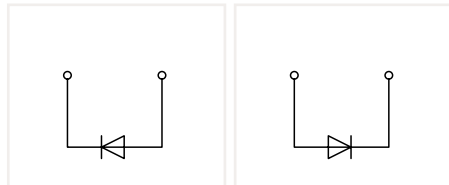

2-conductor diode terminal block; with 1N5408 diode		
Color	Item No.	Pack. Unit
○ gray	2004-1211/1000-401	50
○ gray	2004-1211/1000-400	50

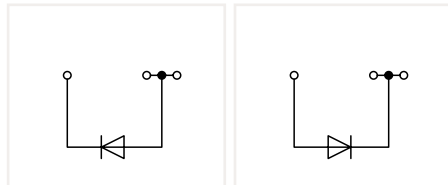

3-conductor diode terminal block; with 1N5408 diode		
Color	Item No.	Pack. Unit
○ gray	2004-1311/1000-401	50
○ gray	2004-1311/1000-400	50

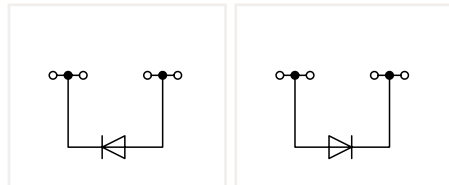

4-conductor diode terminal block; with 1N5408 diode		
Color	Item No.	Pack. Unit
○ gray	2004-1411/1000-401	50
○ gray	2004-1411/1000-400	50

Other terminal blocks with the same profile:		
Through	2004-1201	Page 54

Other terminal blocks with the same profile:		
Through	2004-1301	Page 54

Other terminal blocks with the same profile:		
Through	2004-1401	Page 54

Diode Terminal Blocks TOPJOB® S

Circuit Configuration Examples

❶ Conductor range: 0.5 ... 6 mm² "s+f-st";
 Push-in termination: 1.5 ... 6 mm² "s" and 1.5 ... 4 mm²
 "insulated ferrules; 12 mm"
 Depending on the conductor characteristic, a conductor with a smaller cross section can also be inserted via push-in termination.

Approvals and corresponding ratings, visit www.wago.com

Accessories; 2004 Series

Appropriate marking systems:
 WMB/WMB Inline/Marking strips

Insulation stop; 5 pcs/strip; 0.25 ... 0.5 mm²

light gray	2004-171	200 (25)
------------	----------	----------



Insulation stop; 5 pcs/strip; 0.75 ... 1 mm²

dark gray	2004-172	200 (25)
-----------	----------	----------



Push-in type jumper bar; insulated; I_N 32 A; light gray

2-way	2004-402	25
3-way	2004-403	25
4-way	2004-404	25
5-way	2004-405	25
6-way	2004-406	25
7-way	2004-407	25
8-way	2004-408	25
9-way	2004-409	25
10-way	2004-410	25



Push-in type jumper bar; insulated; I_N 32 A; light gray

1 to 3	2004-433	25
1 to 4	2004-434	25
1 to 5	2004-435	25
1 to 6	2004-436	25
1 to 7	2004-437	25
1 to 8	2004-438	25
1 to 9	2004-439	25
1 to 10	2004-440	25



Wire commoning chain; 50 connections; insulated; I_N 8 A

black	210-103	5
-------	---------	---



Wire commoning chain; 50 connections; insulated; I_N 8 A

blue	210-123	5
------	---------	---

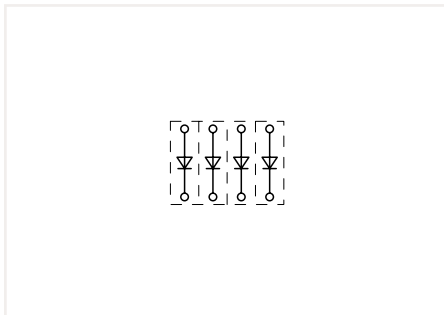

Open diode gates can be created using the following terminal blocks:
 2004-1211/1000-400 or 2004-1211/1000-401



These diode terminal blocks have been specially developed for custom diode circuits, such as lamp test and collective fault signal circuits.

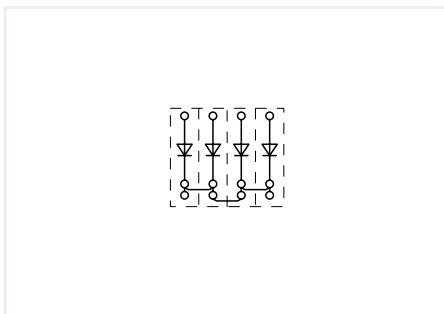

Polarized diode gates with a common cathode can be created using the following terminal blocks:
 2004-1311/1000-400 or 2004-1311/1000-401

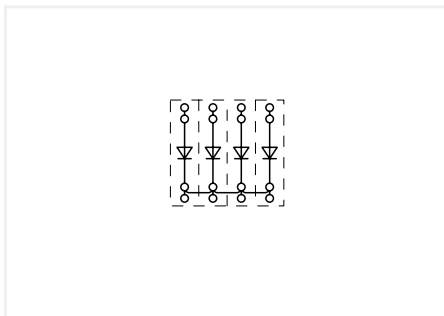

Polarized diode gates with a common cathode can be created using the following terminal blocks:
 2004-1411/1000-400 or 2004-1411/1000-401

Double-Deck Diode Terminal Block and LED Terminal Block TOPJOB® S

2.5 (4) mm²; 2002 Series

1

Technical Data	
0.25 ... 2.5 (4) mm ² ①	22 ... 12 AWG
U _N 250 V; U _{RM} 1000 V	
1N4007 - 0.5 A continuous current	
Terminal block width: 5.2 mm / 0.205 inch	
10 ... 12 mm / 0.39 ... 0.47 inch	

Technical Data	
0.25 ... 2.5 (4) mm ² ①	22 ... 12 AWG
U _N 250 V; U _{RM} 1000 V	
1N4007 - 0.5 A continuous current	
Terminal block width: 5.2 mm / 0.205 inch	
10 ... 12 mm / 0.39 ... 0.47 inch	

Technical Data	
0.25 ... 2.5 (4) mm ² ①	22 ... 12 AWG
24 VDC	
I _F 0.025 A max.	
Terminal block width: 5.2 mm / 0.205 inch	
10 ... 12 mm / 0.39 ... 0.47 inch	

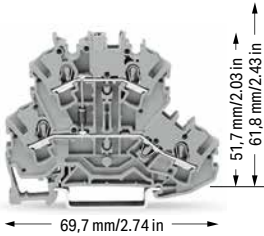

2002-2211/1000-410 2002-2211/1000-411

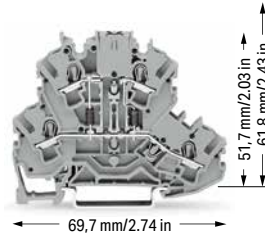

2002-2213/1000-487 2002-2213/1000-488

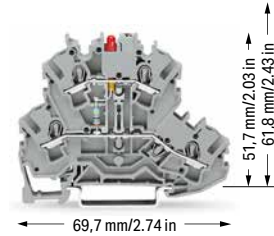

2002-2221/1000-434 2002-2221/1000-413

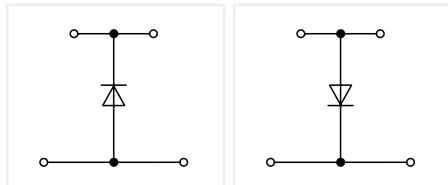

Double-deck diode terminal block; with 1N4007 diode

Color	Item No.	Pack. Unit
○ gray	2002-2211/1000-410	50
○ gray	2002-2211/1000-411	50

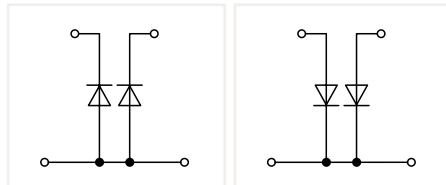

Double-deck diode terminal block; with two 1N4007 diodes

Color	Item No.	Pack. Unit
○ gray	2002-2213/1000-487	50
○ gray	2002-2213/1000-488	50

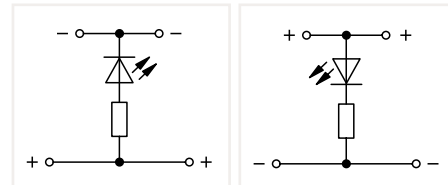

Double-deck LED terminal block; with red LED

Color	Item No.	Pack. Unit
○ gray	2002-2221/1000-434	50
○ gray	2002-2221/1000-413	50

Other terminal blocks with the same profile:
Through 2002-2201 Page 64

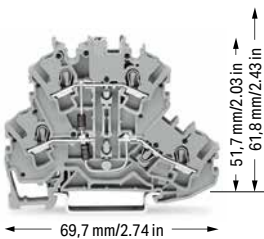

2002-2214/1000-492 2002-2214/1000-491

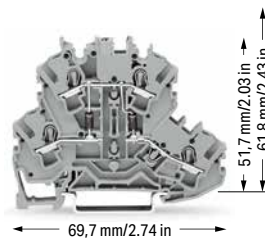

2002-2214/1000-489 2002-2214/1000-490

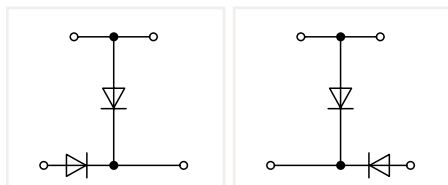

Double-deck diode terminal block; with two 1N4007 diodes

Color	Item No.	Pack. Unit
○ gray	2002-2214/1000-492	50
○ gray	2002-2214/1000-491	50

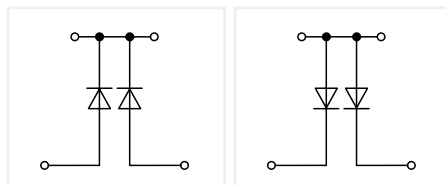

Double-deck diode terminal block; with two 1N4007 diodes

Color	Item No.	Pack. Unit
○ gray	2002-2214/1000-489	50
○ gray	2002-2214/1000-490	50

Double-Deck Diode Terminal Blocks and LED Terminal Blocks TOPJOB® S Circuit Configuration Examples

❶ Conductor range: 0.25 ... 4 mm² "s+f-st";
Push-in termination: 1 ... 4 mm² "s" and 1 ... 2.5 mm²
"insulated ferrules, 12 mm"
Depending on the conductor characteristic, a conductor with a smaller cross section can also be inserted via push-in termination.

Approvals and corresponding ratings, visit www.wago.com

Accessories; 2002 Series

Appropriate marking systems:
WMB/WMB Inline/Marking strips

End and intermediate plate; 0.8 mm thick

orange	2002-2292	100 (25)
gray	2002-2291	100 (25)

Double-deck marker carrier; pivoting

gray	2002-121	50 (25)
------	----------	---------

Insulation stop; 5 pcs/strip; 0.25 ... 0.5 mm²

light gray	2002-171	200 (25)
------------	----------	----------

Insulation stop; 5 pcs/strip; 0.75 ... 1 mm²

dark gray	2002-172	200 (25)
-----------	----------	----------

Push-in type jumper bar; insulated; I_n 25 A; light gray

2-way	2002-402	25
3-way	2002-403	25
4-way	2002-404	25
5-way	2002-405	25
6-way	2002-406	25
7-way	2002-407	25
8-way	2002-408	25
9-way	2002-409	25
10-way	2002-410	25

Push-in type jumper bar; insulated; I_n 25 A; light gray

1 to 3	2002-433	25
1 to 4	2002-434	25
1 to 5	2002-435	25
1 to 6	2002-436	25
1 to 7	2002-437	25
1 to 8	2002-438	25
1 to 9	2002-439	25
1 to 10	2002-440	25

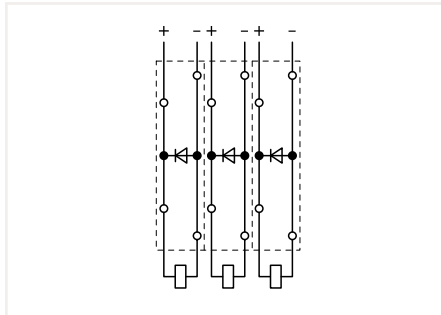

Open diode gates can be created using the following terminal blocks:
2002-2211/1000-410 or 2002-2211/1000-411

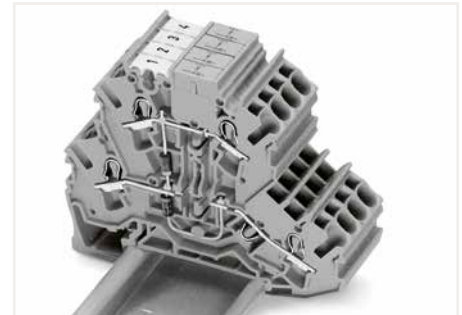

Double-deck diode terminal blocks were specifically developed for custom diode circuits, such as lamp test and collective fault signal circuits. These terminal blocks provide high-density wiring in a width of just 5.2 mm. Push-in type jumper bars provide additional options for custom circuit design.

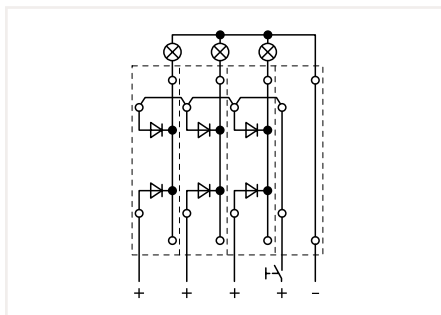

Polarized diode gates with a common cathode can be created using the following terminal blocks:
2002-2213/1000-487 or 2002-2213/1000-488

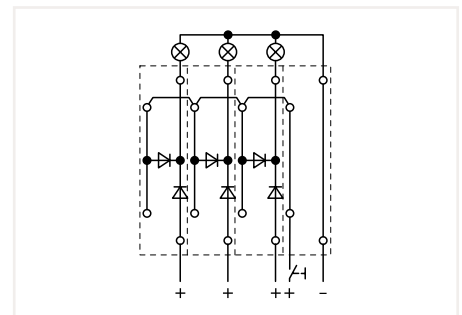

Lamp test circuits can be created using the following terminal blocks:
2002-2214/1000-492 or 2002-2214/1000-491

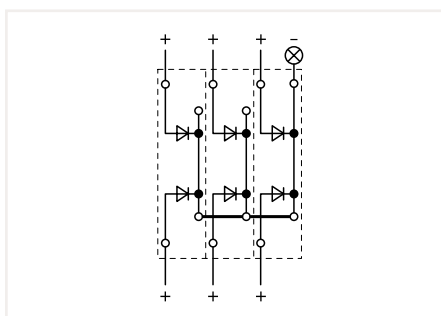

Polarized diode gates with a common cathode can be created using the following terminal blocks:
2002-2214/1000-489 or 2002-2214/1000-490

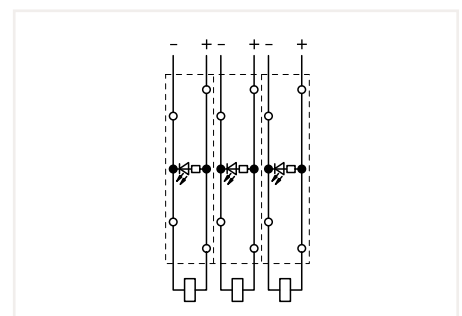

Circuit-related voltage indications can be created using the following terminal blocks:
2002-2221/1000-434 or 2002-2221/1000-413

Triple-Deck Diode Terminal Block and LED Terminal Block TOPJOB® S

2.5 (4) mm²; 2002 Series

1

Technical Data	
0.25 ... 2.5 (4) mm ² ①	22 ... 12 AWG
U _N 250 V; U _{RM} 1000 V	
1N4007 - 0.5 A continuous current	
Terminal block width: 5.2 mm / 0.205 inch	
10 ... 12 mm / 0.39 ... 0.47 inch	

Technical Data	
0.25 ... 2.5 (4) mm ² ①	22 ... 12 AWG
U _N 250 V; U _{RM} 1000 V	
1N4007 - 0.5 A continuous current	
Terminal block width: 5.2 mm / 0.205 inch	
10 ... 12 mm / 0.39 ... 0.47 inch	

Technical Data	
0.25 ... 2.5 (4) mm ² ①	22 ... 12 AWG
24 VDC	
I _F 0.025 A max.	
Terminal block width: 5.2 mm / 0.205 inch	
10 ... 12 mm / 0.39 ... 0.47 inch	

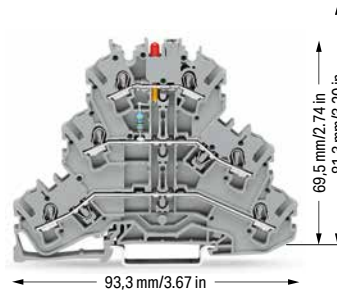
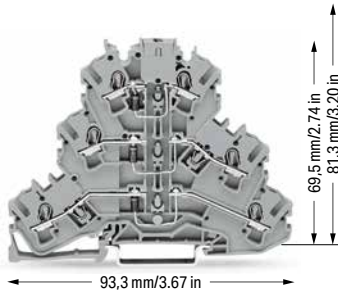
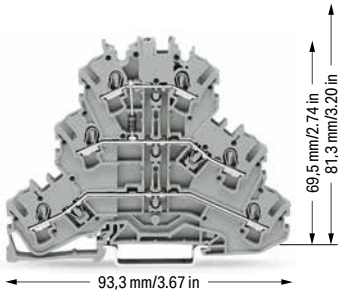

2002-3211/1000-410 2002-3211/1000-411

2002-3212/1000-673 2002-3212/1000-674

2002-3221/1000-434 2002-3221/1000-413

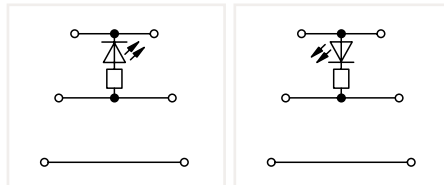
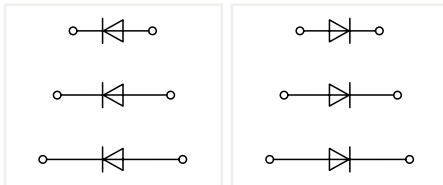
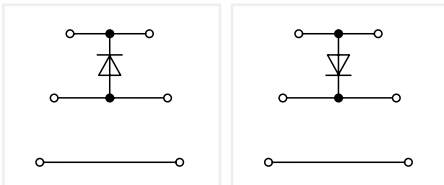

Triple-deck diode terminal block, with 1N4007 diode

Triple-deck diode terminal block, with three 1N4007 diodes

Triple-deck LED terminal block, with red LED

Color	Item No.	Pack. Unit
○ gray	2002-3211/1000-410	50
○ gray	2002-3211/1000-411	50

Color	Item No.	Pack. Unit
○ gray	2002-3212/1000-673	50
○ gray	2002-3212/1000-674	50

Color	Item No.	Pack. Unit
○ gray	2002-3221/1000-434	50
○ gray	2002-3221/1000-413	50

Other terminal blocks with the same profile:

Through	2002-3201	Page 76
---------	-----------	---------

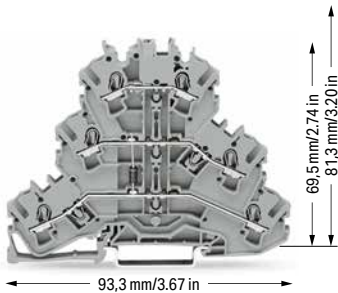

2002-3211/1000-675 2002-3211/1000-676

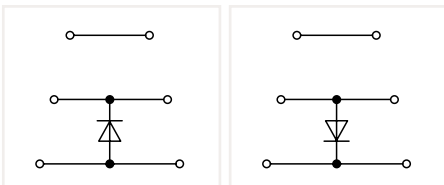

Triple-deck diode terminal block, with 1N4007 diode

Color	Item No.	Pack. Unit
○ gray	2002-3211/1000-675	50
○ gray	2002-3211/1000-676	50

❶ Conductor range: 0.25 ... 4 mm² "s+f-st"; Push-in termination: 1 ... 4 mm² "s" and 1 ... 2.5 mm² "insulated ferrules, 12 mm"
Depending on the conductor characteristic, a conductor with a smaller cross section can also be inserted via push-in termination.

Approvals and corresponding ratings, visit www.wago.com

Accessories; 2002 Series
Appropriate marking systems:
WMB/WMB Inline/Marking strips

End and intermediate plate; 0.8 mm thick

	orange	2002-3292	100 (25)
	gray	2002-3291	100 (25)

Insulation stop; 5 pcs/strip; 0.25 ... 0.5 mm²

	light gray	2002-171	200 (25)
---	------------	----------	----------

Insulation stop; 5 pcs/strip; 0.75 ... 1 mm²

	dark gray	2002-172	200 (25)
---	-----------	----------	----------

Push-in type jumper bar; insulated; I_n 25 A; light gray

	2-way	2002-402	25
	3-way	2002-403	25
	4-way	2002-404	25
	5-way	2002-405	25
	6-way	2002-406	25
	7-way	2002-407	25
	8-way	2002-408	25
	9-way	2002-409	25
	10-way	2002-410	25

Push-in type jumper bar; insulated; I_n 25 A; light gray

	1 to 3	2002-433	25
	1 to 4	2002-434	25
	1 to 5	2002-435	25
	1 to 6	2002-436	25
	1 to 7	2002-437	25
	1 to 8	2002-438	25
	1 to 9	2002-439	25
	1 to 10	2002-440	25

Modular connector; snaps together; for jumper contact slot

	gray	2002-511	100 (25)
---	------	----------	----------

Spacer module; snaps together; bridges commoned terminal blocks

	gray	2002-549	100 (25)
---	------	----------	----------

End plate; for modular connector; 1.5 mm thick

	gray	2002-541	100 (25)
---	------	----------	----------

Test plug; with 500 mm cable; 2 mm Ø; max. 42 V

	red	210-136	50
---	-----	---------	----

Test plug adapter; for 4 mm Ø test plug

	gray	2009-174	100 (25)
---	------	----------	----------

Accessories; 2002 Series
Appropriate marking systems:
WMB/WMB Inline/Marking strips

Banana plug; for 4 mm socket diameter; color mixed; 10 x orange, white, black, blue, yellow; max. 42 V

		215-111	50
---	--	---------	----

Testing tap; for max. 2.5 mm²

	gray	2009-182	100 (25)
---	------	----------	----------

WMB Inline, plain; 1,500 WMB markers (5 mm)/reel; 5 ... 5.2 mm stretchable

	white	2009-115	1
---	-------	----------	---

Marking strip; plain; 11 mm wide; 50 m reel

	white	2009-110	1
---	-------	----------	---

WMB marking card; white; 10 strips with 10 markers/card; 5 ... 5.2 mm stretchable

	plain	793-5501	5
---	-------	----------	---

Triple-deck marker carrier; pivoting

	gray	2002-131	50 (25)
--	------	----------	---------

Group marker carrier; snap-on type for jumper slot; 5 mm wide

	gray	2009-191	50 (25)
---	------	----------	---------

Screwless end stop; for DIN-35 rail; 6 mm wide

	gray	249-116	100 (25)
---	------	---------	----------



Double- and triple-deck LED terminal blocks: Using LED terminal blocks, monitoring units can be designed, e.g., for control and operating circuits.



Triple-deck diode terminal blocks were specifically developed for custom diode circuits, such as lamp test and collective fault signal circuits. These terminal blocks provide high-density wiring in a width of just 5.2 mm. Push-in type jumper bars provide additional options for custom circuit design.

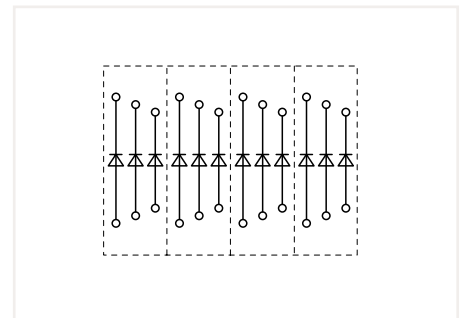

Open diode gates can be created and connected individually using the following terminal blocks: 2002-3212/1000-673 or 2002-3212/1000-674

Using push-in type jumper bars, individual decks can be turned into polarized diode gates.

Pluggable Diode Module TOPJOB® S on Carrier Terminal Block 2.5 (4) mm² 2002 Series

1

Technical Data		
U_N	250 V; U_{RM}	1000 V
I_N	1 A	
Plug width:	5.2 mm / 0.205 inch	



2002-800/1000-411

2002-800/1000-410

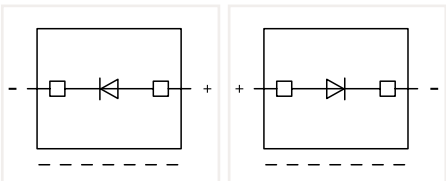

Diode module; with 1N4007 diode; max. operating temperature: 85°C; 5.2 mm wide

Color	Item No.	Pack. Unit
○ gray	2002-800/1000-411	100
○ gray	2002-800/1000-410	100

Accessories for Carrier Terminal Blocks
Appropriate marking systems:
WMB/Marking strips

2-conductor carrier terminal block;
0.25 ... 2.5 (4) mm² / 22 ... 12 AWG
Terminal block width: 5.2 mm / 0.205 inch

gray	2002-1661	50
------	-----------	----

End and intermediate plate; 1 mm thick

orange	2002-1692	100 (25)
gray	2002-1691	100 (25)

3-conductor carrier terminal block;
0.25 ... 2.5 (4) mm² / 22 ... 12 AWG
Terminal block width: 5.2 mm / 0.205 inch

gray	2002-1761	50
------	-----------	----

End and intermediate plate; 1 mm thick

orange	2002-1792	100 (25)
gray	2002-1791	100 (25)

4-conductor carrier terminal block;
0.25 ... 2.5 (4) mm² / 22 ... 12 AWG
Terminal block width: 5.2 mm / 0.205 inch

gray	2002-1861	50
------	-----------	----

End and intermediate plate; 1 mm thick

orange	2002-1892	100 (25)
gray	2002-1891	100 (25)

Please observe the application notes:
Jumpers, from page 152
Marking, from page 588

Approvals and corresponding ratings,
visit www.wago.com

Accessories for Carrier Terminal Blocks

Appropriate marking systems:
WMB/Marking strips

2-conductor carrier terminal block;
0.25 ... 2.5 (4) mm² / 22 ... 12 AWG
Terminal block width: 5.2 mm / 0.205 inch

gray	2002-1961	50
------	-----------	----

End and intermediate plate; 1 mm thick

orange	2002-1992	100 (25)
gray	2002-1991	100 (25)

Push-in type wire jumper; insulated; 1.5 mm² conductor
cross-section; I_N 18 A

L = 60 mm	2009-412	100 (10)
L = 110 mm	2009-414	100 (10)
L = 250 mm	2009-416	100 (10)

Push-in type jumper bar; insulated; I_N 25 A; light gray

2-way	2002-402	25
3-way	2002-403	25
4-way	2002-404	25
5-way	2002-405	25
6-way	2002-406	25
7-way	2002-407	25
8-way	2002-408	25
9-way	2002-409	25
10-way	2002-410	25

Push-in type jumper bar; insulated; I_N 25 A; light gray

1 to 3	2002-433	25
1 to 4	2002-434	25
1 to 5	2002-435	25
1 to 6	2002-436	25
1 to 7	2002-437	25
1 to 8	2002-438	25
1 to 9	2002-439	25
1 to 10	2002-440	25

Staggered jumper; insulated; I_N 25 A; light gray

2-way	2002-472	25
3-way	2002-473	25
4-way	2002-474	25
5-way	2002-475	25
6-way	2002-476	25
7-way	2002-477	25
8-way	2002-478	25
9-way	2002-479	25
10-way	2002-480	25
11-way	2002-481	25
12-way	2002-482	25

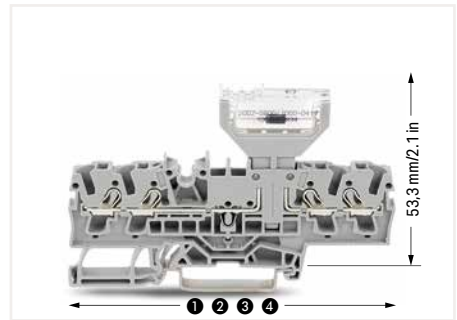

Lengths of carrier terminal blocks with a pluggable diode module:

- ① 66.1 mm / 2.62 inch for 2002-1661
- ② 76.8 mm / 3.02 inch for 2002-1761
- ③ 87.5 mm / 3.45 inch for 2002-1861
- ④ 72.9 mm / 2.87 inch for 2002-1961

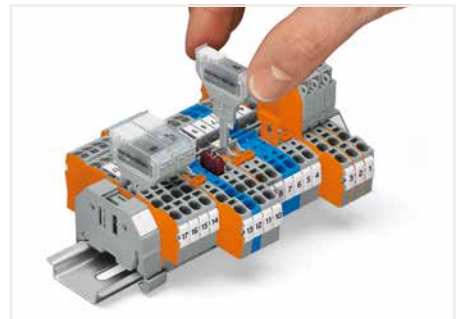

These diode modules are ideal for custom diode circuits (e.g., lamp test and collective fault signal circuits) and offer the following advantages:

- Separation into functional and wiring levels
- Polarized switching direction
- Quick and easy module replacement
- Terminal blocks/modules provide high-density wiring in a width of just 5.2 mm

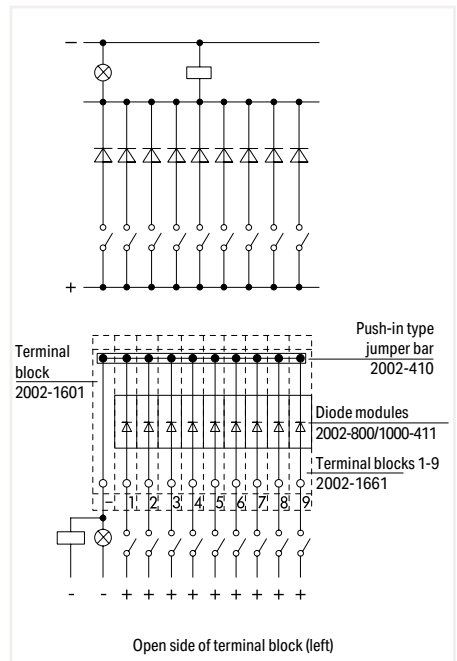

Diode module (2002-800/1000-411)
Diode gate for collective fault indication

Pluggable Diode Module and Empty Component Plug Housing TOPJOB® S on Through Terminal Block 2.5 (4) mm² 2002 Series

Technical Data	
U_N 250 V; U_{RM} 1000 V	
I_N 1 A	
Plug width: 10.4 mm / 0.409 inch	



2002-880/1000-411

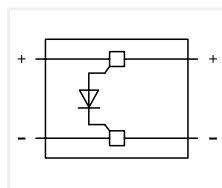

Diode module; with 1N4007 recovery diode; max. operating temperature: 85°C; 10.4 mm wide

Color	Item No.	Pack. Unit
gray	2002-880/1000-411	50

Empty component plug housing; type 4; 10.4 mm wide		
gray	2002-880	50

Accessories for Through Terminal Blocks
Appropriate marking systems: WMB/Marking strips

2-conductor through terminal block; 0.25 ... 2.5 (4) mm ² / 22 ... 12 AWG Terminal block width: 5.2 mm / 0.205 inch		
gray	2002-1201	100

End and intermediate plate; 0.8 mm thick		
orange	2002-1292	100 (25)
gray	2002-1291	100 (25)

3-conductor through terminal block; 0.25 ... 2.5 (4) mm ² / 22 ... 12 AWG Terminal block width: 5.2 mm / 0.205 inch		
gray	2002-1301	100

End and intermediate plate; 0.8 mm thick		
orange	2002-1392	100 (25)
gray	2002-1391	100 (25)

4-conductor through terminal block; 0.25 ... 2.5 (4) mm ² / 22 ... 12 AWG Terminal block width: 5.2 mm / 0.205 inch		
gray	2002-1401	100

End and intermediate plate; 0.8 mm thick		
orange	2002-1492	100 (25)
gray	2002-1491	100 (25)

Please observe the application notes:
Jumpers, from page 152
Marking, from page 588

Approvals and corresponding ratings, visit www.wago.com

Accessories for Through Terminal Blocks
Appropriate marking systems: WMB/Marking strips

Insulation stop; 5 pcs/strip; 0.25 ... 0.5 mm ²		
light gray	2002-171	200 (25)

Insulation stop; 5 pcs/strip; 0.75 ... 1 mm ²		
dark gray	2002-172	200 (25)

Protective warning marker; with black high-voltage symbol; for 5 terminal blocks		
yellow	2002-115	100 (25)

Push-in type wire jumper; insulated; 1.5 mm² conductor cross-section; I_N 18 A

L = 60 mm	2009-412	100 (10)
L = 110 mm	2009-414	100 (10)
L = 250 mm	2009-416	100 (10)

Push-in type jumper bar; insulated; I_N 25 A; light gray

2-way	2002-402	25
3-way	2002-403	25
4-way	2002-404	25
5-way	2002-405	25
6-way	2002-406	25
7-way	2002-407	25
8-way	2002-408	25
9-way	2002-409	25
10-way	2002-410	25

Push-in type jumper bar; insulated; I_N 25 A; light gray

1 to 3	2002-433	25
1 to 4	2002-434	25
1 to 5	2002-435	25
1 to 6	2002-436	25
1 to 7	2002-437	25
1 to 8	2002-438	25
1 to 9	2002-439	25
1 to 10	2002-440	25

Staggered jumper; insulated; I_N 25 A; light gray

2-way	2002-472	25
3-way	2002-473	25
4-way	2002-474	25
5-way	2002-475	25
6-way	2002-476	25
7-way	2002-477	25
8-way	2002-478	25
9-way	2002-479	25
10-way	2002-480	25

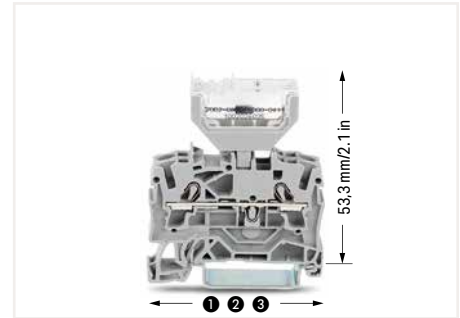

Lengths of through terminal blocks with a pluggable diode module:

- ❶ 48.5 mm / 1.91 inch for 2002-1201
- ❷ 59.2 mm / 2.33 inch for 2002-1301
- ❸ 69.9 mm / 2.75 inch for 2002-1401

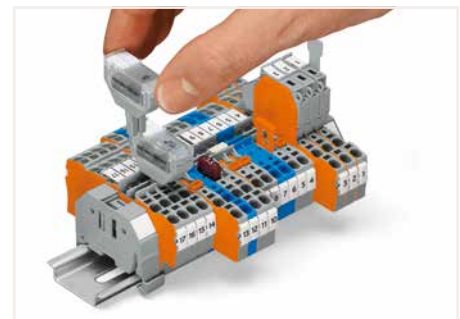

Similar to push-in type jumpers, these diode modules are simply pushed into the current bar's contact slots of two adjacent through terminal blocks, providing the following advantages:

- Compatible with all 2001 to 2006 Series Through Terminal Blocks equipped with jumper slots (note the module's width)
- Easy retrofits for existing systems
- Separation into functional and wiring levels
- Fast replacement of other functional units
- solder-free assembly of diodes, resistors, etc.



Opening the cover via operating tool (2.5 mm blade).

Pluggable LED Module TOPJOB® S on Carrier Terminal Block 2.5 (4) mm² 2002 Series

1

Technical Data
 U_N 250 V; U_{RM} 1000 V
 I_N ≤ 3 mA
 Plug width: 5.2 mm / 0.205 inch

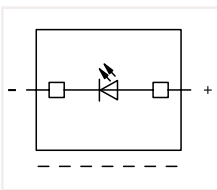

LED module; with red LED; max. operating temperature: 85°C; 5.2 mm wide

	Item No.	Pack. Unit
○ 12 ... 30 V	2002-800/1000-541	100
○ 30 ... 65 V	2002-800/1000-542	100
○ 230 V	2002-800/1000-836	100

Accessories for Carrier Terminal Blocks
 Appropriate marking systems:
 WMB/Marking strips

2-conductor carrier terminal block;
 0.25 ... 2.5 (4) mm² / 22 ... 12 AWG
 Terminal block width: 5.2 mm / 0.205 inch

gray	2002-1661	50
------	-----------	----

End and intermediate plate; 1 mm thick

orange	2002-1692	100 (25)
gray	2002-1691	100 (25)

3-conductor carrier terminal block;
 0.25 ... 2.5 (4) mm² / 22 ... 12 AWG
 Terminal block width: 5.2 mm / 0.205 inch

gray	2002-1761	50
------	-----------	----

End and intermediate plate; 1 mm thick

orange	2002-1792	100 (25)
gray	2002-1791	100 (25)

4-conductor carrier terminal block;
 0.25 ... 2.5 (4) mm² / 22 ... 12 AWG
 Terminal block width: 5.2 mm / 0.205 inch

gray	2002-1861	50
------	-----------	----

End and intermediate plate; 1 mm thick

orange	2002-1892	100 (25)
gray	2002-1891	100 (25)

Please observe the application notes:
 Jumpers, from page 152
 Marking, from page 588

Approvals and corresponding ratings,
 visit www.wago.com

Accessories for Carrier Terminal Blocks

Appropriate marking systems:
 WMB/Marking strips

2-conductor carrier terminal block;
 0.25 ... 2.5 (4) mm² / 22 ... 12 AWG
 Terminal block width: 5.2 mm / 0.205 inch

gray	2002-1961	50
------	-----------	----

End and intermediate plate; 1 mm thick

orange	2002-1992	100 (25)
gray	2002-1991	100 (25)

Push-in type wire jumper; insulated; 1.5 mm² conductor
 cross-section; I_N 18 A

L = 60 mm	2009-412	100 (10)
L = 110 mm	2009-414	100 (10)
L = 250 mm	2009-416	100 (10)

Push-in type jumper bar; insulated; I_N 25 A; light gray

2-way	2002-402	25
3-way	2002-403	25
4-way	2002-404	25
5-way	2002-405	25
6-way	2002-406	25
7-way	2002-407	25
8-way	2002-408	25
9-way	2002-409	25
10-way	2002-410	25

Push-in type jumper bar; insulated; I_N 25 A; light gray

1 to 3	2002-433	25
1 to 4	2002-434	25
1 to 5	2002-435	25
1 to 6	2002-436	25
1 to 7	2002-437	25
1 to 8	2002-438	25
1 to 9	2002-439	25
1 to 10	2002-440	25

Staggered jumper; insulated; I_N 25 A; light gray

2-way	2002-472	25
3-way	2002-473	25
4-way	2002-474	25
5-way	2002-475	25
6-way	2002-476	25
7-way	2002-477	25
8-way	2002-478	25
9-way	2002-479	25
10-way	2002-480	25
11-way	2002-481	25
12-way	2002-482	25



Lengths of carrier terminal blocks with a pluggable LED module:

- ① 66.1 mm / 2.62 inch for 2002-1661
- ② 76.8 mm / 3.02 inch for 2002-1761
- ③ 87.5 mm / 3.45 inch for 2002-1861
- ④ 72.9 mm / 2.87 inch for 2002-1961



The monitoring of control and operating current circuits with LED modules on rail-mount terminal blocks provides several advantages:

- No additional cost for assembly and wiring
- Separation into functional and wiring levels
- Modules can be replaced quickly by other types of modules
- Polarized switching direction
- Terminal blocks/modules provide high-density wiring in a width of just 5.2 mm

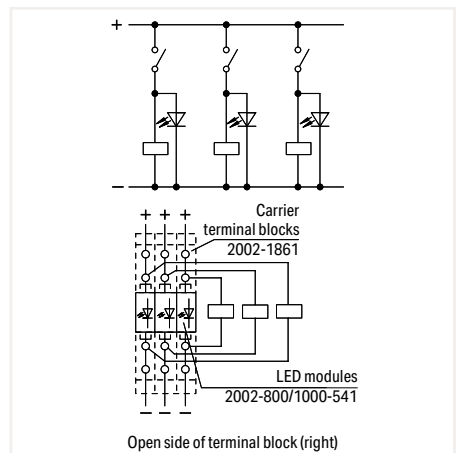

LED module (2002-800/1000-541)
 Voltage control assigned to current circuits

Pluggable LED Module TOPJOB® S on Through Terminal Block 2.5 (4) mm² 2002 Series

Technical Data

$I_N \leq 3 \text{ mA}$

Plug width: 10.4 mm / 0.409 inch



Please observe the application notes:
Marking, from page 588

Approvals and corresponding ratings,
visit www.wago.com



Dimensions of through terminal blocks with a pluggable LED module:

- ① 48.5 mm / 1.91 inch for 2002-1201
- ② 59.2 mm / 2.33 inch for 2002-1301
- ③ 69.9 mm / 2.75 inch for 2002-1401

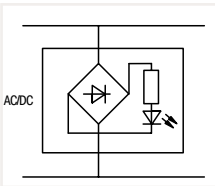

LED module; with red LED; max. operating temperature: 85°C; 10.4 mm wide

	Item No.	Pack. Unit
○ 12 ... 30 V	2002-880/1000-541	50
○ 30 ... 65 V	2002-880/1000-542	50
○ 230 V	2002-880/1000-836	50

Accessories for Through Terminal Blocks

Appropriate marking systems:
WMB/Marking strips

2-conductor through terminal block;
0.25 ... 2.5 (4) mm² / 22 ... 12 AWG
Terminal block width: 5.2 mm / 0.205 inch

gray	2002-1201	100
------	-----------	-----



End and intermediate plate; 0.8 mm thick

orange	2002-1292	100 (25)
gray	2002-1291	100 (25)



3-conductor through terminal block;
0.25 ... 2.5 (4) mm² / 22 ... 12 AWG
Terminal block width: 5.2 mm / 0.205 inch

gray	2002-1301	100
------	-----------	-----



End and intermediate plate; 0.8 mm thick

orange	2002-1392	100 (25)
gray	2002-1391	100 (25)



4-conductor through terminal block;
0.25 ... 2.5 (4) mm² / 22 ... 12 AWG
Terminal block width: 5.2 mm / 0.205 inch

gray	2002-1401	100
------	-----------	-----



End and intermediate plate; 0.8 mm thick

orange	2002-1492	100 (25)
gray	2002-1491	100 (25)



Labeling via WMB Multi markers and marking strips



Testing via 2-pole test plugs.

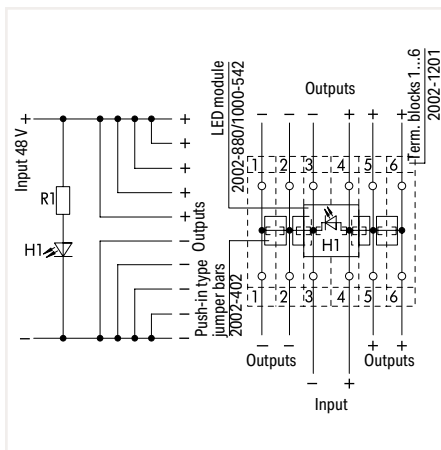

LED module (2002-880/1000-541)
Multiple outputs with indicator lamp

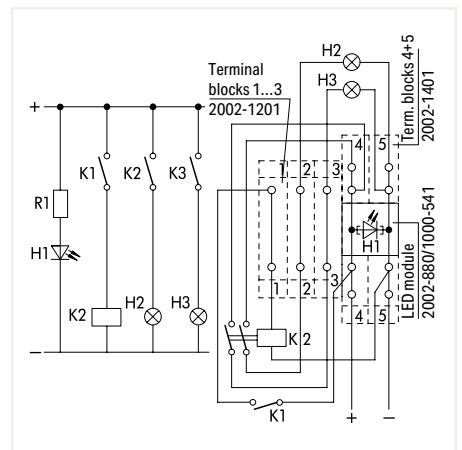

LED module (2002-880/1000-541)
Control unit

Empty Component Plug Housing TOPJOB® S on Carrier Terminal Block 2.5 (4) mm² 2002 Series

1

Technical Data
Plug width: 5.2 mm / 0.205 inch



Empty component plug housing; type 1; 2-pole; 5.2 mm wide		
Color	Item No.	Pack. Unit
○ gray	2002-800	100

Technical Data
Plug width: 10.4 mm / 0.409 inch



Empty component plug housing; type 2; 2-pole; 10.4 mm wide		
Color	Item No.	Pack. Unit
○ gray	2002-810	50

Empty component plug housing; type 3; 4-pole; 10.4 mm wide		
Color	Item No.	Pack. Unit
○ gray	2002-820	50

Please observe the application notes:
Jumpers, from page 152
Marking, from page 588

Approvals and corresponding ratings,
visit www.wago.com

Accessories for Carrier Terminal Blocks

Appropriate marking systems:
WMB/WMB Inline/Marking strips

WMB marking card; white; 10 strips with 10 markers/card; 5 ... 5.2 mm stretchable

	plain	793-5501	5
--	-------	----------	---

WMB marking card; plain; 10 strips with 10 markers/card; 5 ... 5.2 mm stretchable

	yellow	793-5501/000-002	5
	red	793-5501/000-005	5
	blue	793-5501/000-006	5
	gray	793-5501/000-007	5
	orange	793-5501/000-012	5
	light green	793-5501/000-017	5
	green	793-5501/000-023	5
	violet	793-5501/000-024	5

Accessories for Carrier Terminal Blocks

Appropriate marking systems: WMB/Marking strips

2-conductor carrier terminal block;
0.25 ... 2.5 (4) mm² / 22 ... 12 AWG
Terminal block width: 5.2 mm / 0.205 inch

	gray	2002-1661	50
--	------	-----------	----

End and intermediate plate; 1 mm thick

	orange	2002-1692	100 (25)
	gray	2002-1691	100 (25)

3-conductor carrier terminal block;
0.25 ... 2.5 (4) mm² / 22 ... 12 AWG
Terminal block width: 5.2 mm / 0.205 inch

	gray	2002-1761	50
--	------	-----------	----

End and intermediate plate; 1 mm thick

	orange	2002-1792	100 (25)
	gray	2002-1791	100 (25)

4-conductor carrier terminal block;
0.25 ... 2.5 (4) mm² / 22 ... 12 AWG
Terminal block width: 5.2 mm / 0.205 inch

	gray	2002-1861	50
--	------	-----------	----

End and intermediate plate; 1 mm thick

	orange	2002-1892	100 (25)
	gray	2002-1891	100 (25)

2-conductor carrier terminal block;
0.25 ... 2.5 (4) mm² / 22 ... 12 AWG
Terminal block width: 5.2 mm / 0.205 inch

	gray	2002-1961	50
--	------	-----------	----

End and intermediate plate; 1 mm thick

	orange	2002-1992	100 (25)
	gray	2002-1991	100 (25)

Protective warning marker; with black high-voltage symbol; for 5 terminal blocks

	yellow	2002-115	100 (25)
--	--------	----------	----------

Push-in type wire jumper; insulated; 1.5 mm² conductor cross-section; I_N 18 A

	L = 60 mm	2009-412	100 (10)
	L = 110 mm	2009-414	100 (10)
	L = 250 mm	2009-416	100 (10)

Push-in type jumper bar; insulated; I_N 25 A; light gray

	2-way	2002-402	25
	3-way	2002-403	25
	4-way	2002-404	25
	5-way	2002-405	25
	6-way	2002-406	25
	7-way	2002-407	25
	8-way	2002-408	25
	9-way	2002-409	25
	10-way	2002-410	25

Push-in type jumper bar; insulated; I_N 25 A; light gray

	1 to 3	2002-433	25
	1 to 4	2002-434	25
	1 to 5	2002-435	25
	1 to 6	2002-436	25
	1 to 7	2002-437	25
	1 to 8	2002-438	25
	1 to 9	2002-439	25
	1 to 10	2002-440	25

Staggered jumper; insulated; I_N 25 A; light gray

	2-way	2002-472	25
	3-way	2002-473	25
	4-way	2002-474	25
	5-way	2002-475	25
	6-way	2002-476	25
	7-way	2002-477	25
	8-way	2002-478	25
	9-way	2002-479	25
	10-way	2002-480	25
	11-way	2002-481	25
	12-way	2002-482	25

Multi-purpose operating tool; for component plugs

	2002-116	5
--	----------	---

Screwless end stop; for DIN-35 rail; 6 mm wide

	gray	249-116	100 (25)
--	------	---------	----------

Screwless end stop; for DIN-35 rail; 10 mm wide

	gray	249-117	50 (25)
--	------	---------	---------

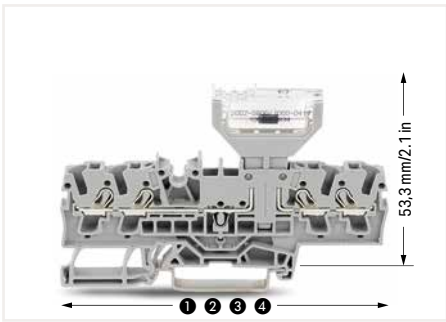

Lengths of carrier terminal blocks with a pluggable diode module:

- ① 66.1 mm / 2.62 inch for 2002-1661
- ② 76.8 mm / 3.02 inch for 2002-1761
- ③ 87.5 mm / 3.45 inch for 2002-1861
- ④ 72.9 mm / 2.87 inch for 2002-1961



Cutting component to the proper length.



Pressing component into plug contact via operating tool.

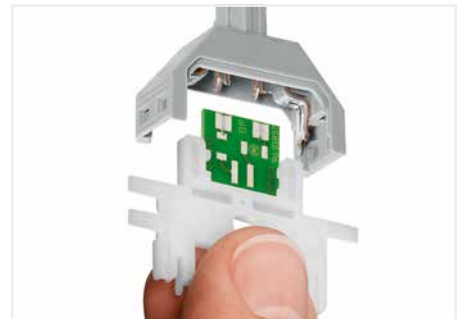

Pushing PCB into plug contact via operating tool.

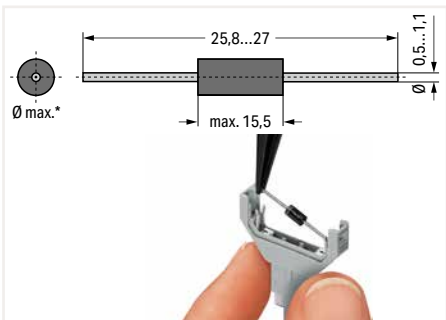

*max. 3.4 mm Ø at 5.2 mm module width and *max. 5.4 mm Ø at 10.4 mm module width
 Notice: Reconnection only possible with similar or larger wire diameter.



Component plugs for building custom circuits solder-free assembly of diodes, resistors, etc. (Illustration shows a 1N4007 diode)

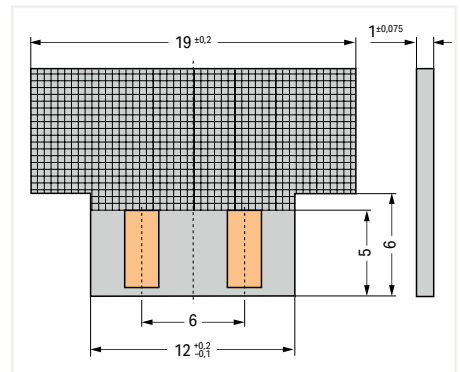

Dimensions of self-assembled PCBs:
 Module height: 2 mm at 5.2 mm module width and module height: 3.3 mm at 10.4 mm module width



When closing the cover, please insert cover as shown in the illustration.



Opening the cover via operating tool (2.5 mm blade).



Opening the cover via multi-purpose operating tool for component plugs.

Component Plug TOPJOB® S on Carrier Terminal Blocks 2.5 (4) mm² 2042 Series

1



Component plug; 4-pole; transparent housing; with fiber optics; 10.3 mm wide

Item No.	Pack. Unit
2042-321	5

Component plug; 6-pole; transparent housing; with fiber optics; 15.5 mm wide

Item No.	Pack. Unit
2042-331	5

Component plug; 8-pole; transparent housing; with fiber optics; 20.7 mm wide

Item No.	Pack. Unit
2042-341	5

Component plug; 10-pole; transparent housing; with fiber optics; 25.9 mm wide

Item No.	Pack. Unit
2042-351	5

Accessories for Carrier Terminal Blocks

Appropriate marking systems: WMB/Marking strips

2-conductor carrier terminal block; 0.25 ... 2.5 (4) mm² / 22 ... 12 AWG
Terminal block width: 5.2 mm / 0.205 inch

Color	Item No.	Pack. Unit
gray	2002-1661	50

End and intermediate plate; 1 mm thick

Color	Item No.	Pack. Unit
orange	2002-1692	100 (25)
gray	2002-1691	100 (25)

3-conductor carrier terminal block; 0.25 ... 2.5 (4) mm² / 22 ... 12 AWG
Terminal block width: 5.2 mm / 0.205 inch

Color	Item No.	Pack. Unit
gray	2002-1761	50

End and intermediate plate; 1 mm thick

Color	Item No.	Pack. Unit
orange	2002-1792	100 (25)
gray	2002-1791	100 (25)

4-conductor carrier terminal block; 0.25 ... 2.5 (4) mm² / 22 ... 12 AWG
Terminal block width: 5.2 mm / 0.205 inch

Color	Item No.	Pack. Unit
gray	2002-1861	50

End and intermediate plate; 1 mm thick

Color	Item No.	Pack. Unit
orange	2002-1892	100 (25)
gray	2002-1891	100 (25)

2-conductor carrier terminal block; 0.25 ... 2.5 (4) mm² / 22 ... 12 AWG
Terminal block width: 5.2 mm / 0.205 inch

Color	Item No.	Pack. Unit
gray	2002-1961	50

End and intermediate plate; 1 mm thick

Color	Item No.	Pack. Unit
orange	2002-1992	100 (25)
gray	2002-1991	100 (25)

Protective warning marker; with black high-voltage symbol; for 5 terminal blocks

Color	Item No.	Pack. Unit
yellow	2002-115	100 (25)

Push-in type wire jumper; insulated; 1.5 mm² conductor cross-section; I_N 18 A

Length (L)	Item No.	Pack. Unit
L = 60 mm	2009-412	100 (10)
L = 110 mm	2009-414	100 (10)
L = 250 mm	2009-416	100 (10)

Push-in type jumper bar; insulated; I_N 25 A; light gray

Way	Item No.	Pack. Unit
2-way	2002-402	25
3-way	2002-403	25
4-way	2002-404	25
5-way	2002-405	25
6-way	2002-406	25
7-way	2002-407	25
8-way	2002-408	25
9-way	2002-409	25
10-way	2002-410	25

Push-in type jumper bar; insulated; I_N 25 A; light gray

Way	Item No.	Pack. Unit
1 to 3	2002-433	25
1 to 4	2002-434	25
1 to 5	2002-435	25
1 to 6	2002-436	25
1 to 7	2002-437	25
1 to 8	2002-438	25
1 to 9	2002-439	25
1 to 10	2002-440	25

Staggered jumper; insulated; I_N 25 A; light gray

Way	Item No.	Pack. Unit
2-way	2002-472	25
3-way	2002-473	25
4-way	2002-474	25
5-way	2002-475	25
6-way	2002-476	25
7-way	2002-477	25
8-way	2002-478	25
9-way	2002-479	25
10-way	2002-480	25
11-way	2002-481	25
12-way	2002-482	25

Length for 2002-1661 – 66.5 mm / 2.62 inch
2-conductor carrier terminal block

Length for 2002-1761 – 76.8 mm / 3.02 inch
3-conductor carrier terminal block

Length for 2002-1861 – 87.5 mm / 3.45 inch
4-conductor carrier terminal block

Length for 2002-1961 – 72.9 mm / 2.87 inch
2-conductor carrier terminal block; with additional jumper slot

Please observe the application notes:
Jumpers, from page 152
Marking, from page 588

Approvals and corresponding ratings,
visit www.wago.com

Accessories for Carrier Terminal Blocks

Appropriate marking systems:
WMB/WMB Inline/Marking strips

WMB marking card; white; 10 strips with 10 markers/card; 5 ... 5.2 mm stretchable

Color	Item No.	Pack. Unit
plain	793-5501	5

WMB marking card; plain; 10 strips with 10 markers/card; 5 ... 5.2 mm stretchable

Color	Item No.	Pack. Unit
yellow	793-5501/000-002	5
red	793-5501/000-005	5
blue	793-5501/000-006	5
gray	793-5501/000-007	5
orange	793-5501/000-012	5
light green	793-5501/000-017	5
green	793-5501/000-023	5
violet	793-5501/000-024	5

Screwless end stop; for DIN-35 rail; 6 mm wide

Color	Item No.	Pack. Unit
gray	249-116	100 (25)

Screwless end stop; for DIN-35 rail; 10 mm wide

Color	Item No.	Pack. Unit
gray	249-117	50 (25)

Connector and Connector Strip TOPJOB® S

1 (1.5) mm²; 2000 Series and 1.5 (2,5) mm²; 2001 Series and 2.5 (4) mm²; 2002 Series

1

Technical Data

0.14 ... 1 (1.5) mm ² ①	24 ... 16 AWG
500 V/6 kV/3 ④	
I _N 13.5 A	
Terminal block width: 3.5 mm / 0.138 inch	
 9 ... 11 mm / 0.35 ... 0.43 inch	

Technical Data

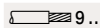
0.25 ... 1.5 (2.5) mm ² ②	22 ... 14 AWG
500 V/6 kV/3 ④	300 V, 15 A ⑤
I _N 18 A	
Terminal block width: 4.2 mm / 0.165 inch	
 9 ... 11 mm / 0.35 ... 0.43 inch	

Technical Data

0.25 ... 2.5 (4) mm ² ③	22 ... 12 AWG
500 V/6 kV/3 ④	300 V, 20 A ⑤
I _N 24 A	
Terminal block width: 5.2 mm / 0.205 inch	
 10 ... 12 mm / 0.39 ... 0.47 inch	

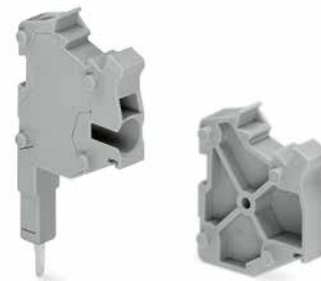

Modular connector; for jumper contact slot; snaps together; gray

	Item No.	Pack. Unit
<input type="radio"/> 1-pole	2000-510	100 (25)

Modular connector; for jumper contact slot; snaps together; gray

	Item No.	Pack. Unit
<input type="radio"/> 1-pole	2001-511	100 (25)

Modular connector; for jumper contact slot; snaps together; gray

	Item No.	Pack. Unit
<input type="radio"/> 1-pole	2002-511	100 (25)

Modular connector; with end plate; for jumper contact slot; snaps together; gray

<input type="radio"/> 1-pole	2000-511	100 (25)
------------------------------	----------	----------

Spacer module; snaps together; bridges commoned terminal blocks

<input type="radio"/> gray	2001-549	100 (25)
----------------------------	----------	----------

Spacer module; snaps together; bridges commoned terminal blocks

<input type="radio"/> gray	2002-549	100 (25)
----------------------------	----------	----------

connector strip; for jumper contact slot; gray

<input type="radio"/> 2-pole	2000-552	25
<input type="radio"/> 3-pole	2000-553	25
<input type="radio"/> 4-pole	2000-554	25
<input type="radio"/> 5-pole	2000-555	10
<input type="radio"/> 6-pole	2000-556	10
<input type="radio"/> 7-pole	2000-557	10
<input type="radio"/> 8-pole	2000-558	10
<input type="radio"/> 9-pole	2000-559	10
<input type="radio"/> 10-pole	2000-560	10

connector strip; for jumper contact slot; gray

<input type="radio"/> 2-pole	2001-552	25
<input type="radio"/> 3-pole	2001-553	25
<input type="radio"/> 4-pole	2001-554	25
<input type="radio"/> 5-pole	2001-555	10
<input type="radio"/> 6-pole	2001-556	10
<input type="radio"/> 7-pole	2001-557	10
<input type="radio"/> 8-pole	2001-558	10
<input type="radio"/> 9-pole	2001-559	10
<input type="radio"/> 10-pole	2001-560	10

connector strip; for jumper contact slot; gray

<input type="radio"/> 2-pole	2002-552	25
<input type="radio"/> 3-pole	2002-553	25
<input type="radio"/> 4-pole	2002-554	25
<input type="radio"/> 5-pole	2002-555	10
<input type="radio"/> 6-pole	2002-556	10
<input type="radio"/> 7-pole	2002-557	10
<input type="radio"/> 8-pole	2002-558	10
<input type="radio"/> 9-pole	2002-559	10
<input type="radio"/> 10-pole	2002-560	10

Accessories; item-specific

WMB Inline; plain; 2,300 WMB markers (3.5 mm)/reel

	white	2009-113	1
---	-------	----------	---

Accessories; item-specific

WMB Inline; plain; 2,000 WMB markers (4 mm)/reel; 4 ... 4.2 mm stretchable

	white	2009-114	1
---	-------	----------	---

Accessories; item-specific

WMB Inline; plain; 1,500 WMB markers (5 mm)/reel; 5 ... 5.2 mm stretchable

	white	2009-115	1
---	-------	----------	---

WMB marking card; white; 10 strips with 10 markers/card; for 3.5 mm terminal block width

	plain	793-3501	5
--	-------	----------	---

WMB marking card; white; 10 strips with 10 markers/card; 4 ... 4.2 mm stretchable

	plain	793-4501	5
---	-------	----------	---

WMB marking card; white; 10 strips with 10 markers/card; 5 ... 5.2 mm stretchable

	plain	793-5501	5
---	-------	----------	---

WMB marking card; plain; 10 strips with 10 markers/card; 4 ... 4.2 mm stretchable

	yellow	793-4501/000-002	5
	red	793-4501/000-005	5
	blue	793-4501/000-006	5
	gray	793-4501/000-007	5
	orange	793-4501/000-012	5
	light green	793-4501/000-017	5
	green	793-4501/000-023	5
	violet	793-4501/000-024	5

WMB marking card; plain; 10 strips with 10 markers/card; 5 ... 5.2 mm stretchable

	yellow	793-5501/000-002	5
	red	793-5501/000-005	5
	blue	793-5501/000-006	5
	gray	793-5501/000-007	5
	orange	793-5501/000-012	5
	light green	793-5501/000-017	5
	green	793-5501/000-023	5
	violet	793-5501/000-024	5

Connectors and Connector Strips TOPJOB® S Installation

❶ Conductor range: 0.14 ... 1.5 mm² "s+f-st";
Push-in termination: 0.5 ... 1.5 mm² "s" and
0.5 ... 0.75 mm² "insulated ferrules; 12 mm"
Depending on the conductor characteristic, a conductor with a smaller cross section can also be inserted via push-in termination.

❷ Conductor range: 0.25 ... 2.5 mm² "s+f-st";
Push-in termination: 0.75 ... 2.5 mm² "s" and
0.75 ... 1.5 mm² "insulated ferrules; 12 mm"
Depending on the conductor characteristic, a conductor with a smaller cross section can also be inserted via push-in termination.

❸ Conductor range: 0.25 ... 4 mm² "s+f-st";
Push-in termination: 1 ... 4 mm² "s" and 1 ... 2.5 mm² "insulated ferrules, 12 mm"
Depending on the conductor characteristic, a conductor with a smaller cross section can also be inserted via push-in termination.

❹ 500 V = rated voltage
6 kV = rated impulse voltage
3 = pollution degree
(see Section 14)

Note:

According to EN 61984, pluggable connectors without a current interrupting capacity must not be mated or unmated when live or under load.

Approvals and corresponding ratings, visit www.wago.com

Accessories; for connector strips

Appropriate marking systems:
WMB/WMB Inline/Marking strips

End plate; for modular connector; 1.5 mm thick

gray	2002-541	100 (25)
------	----------	----------



Test plug; with 500 mm cable; 2 mm Ø; max. 42 V

red	210-136	50
-----	---------	----



Test plug; with 500 mm cable; 2.3 mm Ø; max. 42 V

yellow	210-137	50
--------	---------	----



Strain relief plate; gray

35 mm wide	734-326	100 (25)
6 mm wide	734-327	100 (25)
12.5 mm wide	734-328	100 (25)
25 mm wide	734-329	100 (25)



Marking strip; plain; 11 mm wide; 50 m reel

white	2009-110	1
-------	----------	---

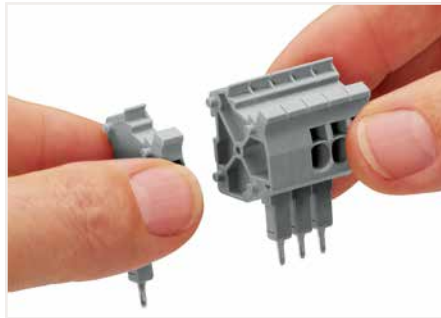

Snapping connectors and spacers together to assemble a multipole connector.



The modular connectors also connect conductors of the same size as the terminal blocks being used.

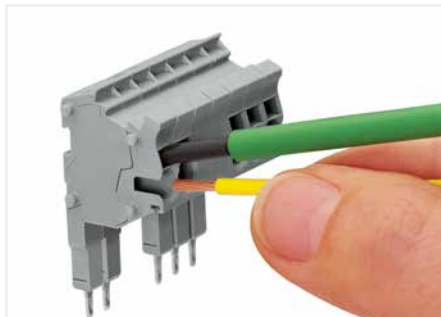

Operating tool for fine-stranded conductors without ferrules – push-in connection of solid conductors



Connectors with a 2 mm Ø test socket for testing voltage via 2-pole voltage tester



Snapping on a strain relief plate.



Rail-mount terminal block assembly for electric motor wiring

1

Connector and Connector Strip TOPJOB® S

4 (6) mm²; 2004 Series; 2006 Series; 2010 Series and 2016 Series

1

Technical Data

0.5 ... 4 (6) mm² ① | 22 ... 10 AWG
500 V/6 kV/3 ② | 300 V, 15 A I_{Nmax}

 I_N 32 A

Terminal block width: 6.2 mm / 0.244 inch

 11 ... 13 mm / 0.43 ... 0.51 inch
**Technical Data**

0.5 ... 4 (6) mm² ① | 22 ... 10 AWG
500 V/6 kV/3 ②

 I_N 32 A

Terminal block width: 7.5 mm / 0.295 inch

 11 ... 13 mm / 0.43 ... 0.51 inch
**Technical Data**

0.5 ... 4 (6) mm² ① | 22 ... 10 AWG
500 V/6 kV/3 ②

 I_N 32 A

Terminal block width: 10 mm / 0.394 inch

 11 ... 13 mm / 0.43 ... 0.51 inch

Modular connector; for jumper contact slot; snaps together; gray

	Item No.	Pack. Unit
<input type="radio"/> 1-pole	2004-511	100 (25)

Modular connector; for jumper contact slot; snaps together; gray

	Item No.	Pack. Unit
<input type="radio"/> 1-pole	2006-511	50 (25)

Modular connector; for jumper contact slot; snaps together; gray

	Item No.	Pack. Unit
<input type="radio"/> 1-pole	2010-511	50 (25)

Spacer module; snaps together; bridges commoned terminal blocks

<input type="radio"/> gray	2004-549	100 (25)
----------------------------	----------	----------

Spacer module; snaps together; bridges commoned terminal blocks

<input type="radio"/> gray	2006-549	50 (25)
----------------------------	----------	---------

Spacer module; snaps together; bridges commoned terminal blocks

<input type="radio"/> gray	2010-549	50 (25)
----------------------------	----------	---------

connector strip; for jumper contact slot; gray

<input type="radio"/> 2-pole	2004-552	25
<input type="radio"/> 3-pole	2004-553	25
<input type="radio"/> 4-pole	2004-554	25
<input type="radio"/> 5-pole	2004-555	10

Accessories; item-specific

Test plug; with 500 mm cable; 2.3 mm Ø; max. 42 V

 yellow	210-137	50
--	---------	----

Accessories, for connector strips

Appropriate marking systems: WMB/WMB Inline/Marking strips

End plate; for modular connector; 1.5 mm thick

 gray	2004-541	100 (25)
--	----------	----------

Test plug; with 500 mm cable; 2 mm Ø; max. 42 V

 red	210-136	50
---	---------	----

Strain relief plate; gray

 35 mm wide	734-326	100 (25)
6 mm wide	734-327	100 (25)
12.5 mm wide	734-328	100 (25)
25 mm wide	734-329	100 (25)

Marking strip; plain; 11 mm wide; 50 m reel

 white	2009-110	1
---	----------	---

WMB marking card; white; 10 strips with 10 markers/card; 5 ... 5.2 mm stretchable

 plain	793-5501	5
--	----------	---

Technical Data0.5 ... 4 (6) mm² ❶ | 22 ... 10 AWG

500 V/6 kV/3 ❷

I_N 32 A

Terminal block width: 12 mm / 0.472 inch

 11 ... 13 mm / 0.43 ... 0.51 inch

❶ Conductor range: 0.5 ... 6 mm² "s+f-st";
Push-in termination: 1.5 ... 6 mm² "s" and 1.5 ... 4 mm²
"insulated ferrules; 12 mm"
Depending on the conductor characteristic, a conductor with a smaller cross section can also be inserted via push-in termination.

❷ 500 V = rated voltage
6 kV = rated impulse voltage
3 = pollution degree
(see Section 14)

Note:

According to EN 61984, pluggable connectors without a current interrupting capacity must not be mated or unmated when live or under load.

Approvals and corresponding ratings, visit www.wago.com

Modular connector; for jumper contact slot; snaps together; gray

	Item No.	Pack. Unit
<input type="radio"/> 1-pole	2016-511	50 (25)

Spacer module; snaps together; bridges commoned terminal blocks

<input type="radio"/> gray	2016-549	50 (25)
----------------------------	----------	---------

PUSH-IN CAGE CLAMP®

L-Type Test Plug Module TOPJOB® S for Testing 5.2 mm Wide Rail-Mount Terminal Blocks – via Conductor Entries

2.5 (4) mm²; 2002 Series

1

Technical Data

0.25 ... 2.5 (4) mm² ① | 22 ... 12 AWG
 500 V/6 kV/3 ②
 I_N 18 A
 Terminal block width: 5.2 mm / 0.205 inch
 10 ... 12 mm / 0.39 ... 0.47 inch

- ① Conductor range: 0.25 ... 4 mm² "s+f-st";
 Push-in termination: 1 ... 4 mm² "s" and 1 ... 2.5 mm² "insulated ferrules, 12 mm"
 Depending on the conductor characteristic, a conductor with a smaller cross section can also be inserted via push-in termination.
- ② 500 V = rated voltage
 6 kV = rated impulse voltage
 3 = pollution degree
 (see Section 14)

Approvals and corresponding ratings, visit www.wago.com

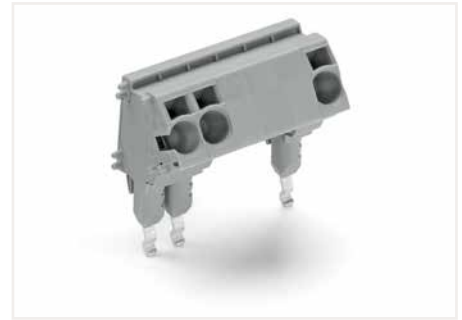

L-type test plug assembly:
 L-type test plug modules and L-type spacer modules (max. 10-pole)
 Additionally, terminal blocks can be skipped using spacer modules.

L-type test plug module; snaps together; gray
 According to EN 61984, pluggable connectors without a current interrupting capacity must not be mated or unmated when live or under load.

	Item No.	Pack. Unit
○ 1-pole	2002-611	100 (25)

L-type spacer module; snaps together; bridges commoned terminal blocks

○ gray	2002-649	100 (25)
--------	----------	----------

Accessories; for L-type test plug modules

Appropriate marking systems:
 WMB/WMB Inline/Mini-WSB

End plate; for modular test plug module; 1.5 mm thick

gray	2002-641	100 (25)
------	----------	----------



Test plug; with 500 mm cable; 2 mm Ø; max. 42 V

red	210-136	50
-----	---------	----



Test plug; with 500 mm cable; 2.3 mm Ø; max. 42 V

yellow	210-137	50
--------	---------	----



Strain relief plate; gray

35 mm wide	734-326	100 (25)
6 mm wide	734-327	100 (25)
12.5 mm wide	734-328	100 (25)
25 mm wide	734-329	100 (25)



WMB Inline, plain; 1,500 WMB markers (5 mm)/reel; 5 ... 5.2 mm stretchable

white	2009-115	1
-------	----------	---



WMB marking card; white; 10 strips with 10 markers/card; 5 ... 5.2 mm stretchable

plain	793-5501	5
-------	----------	---



L-type test plug modules fitted in a triple-deck terminal block



L-type test plug modules for testing rail-mount terminal blocks via conductor entries

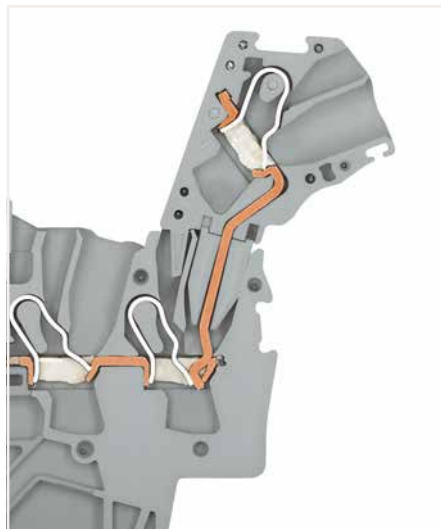

L-type test plug module – cross-sectional view of contacts

Test Plug Adapter and Testing Tap TOPJOB® S 2009 Series



Test plug adapter; for 4 mm Ø test plug; for testing Rail-Mount Terminal Blocks TOPJOB® S
Power must be switched off when installing the test plug adapter. The safety guidelines for working on live installations must be observed.

Color	Item No.	Pack. Unit
○ gray	2009-174	100 (25)

Testing tap; for max. 2.5 mm²; connects test cables (0.08 ... 2.5 mm²) without tool
Power must be switched off when installing the testing tap. The safety guidelines for working on live installations must be observed.

Color	Item No.	Pack. Unit
○ gray	2009-182	100 (25)



Test plug adapter (2009-174, CAT I) for 4 mm Ø plugs – compatible with 2000 to 2016 Series



Testing tap (2009-182) for tool-free connection of test cables up to 2.5 mm² (12 AWG) – compatible with 2000 to 2016 Series

Colored Push-In Type Jumper Bar TOPJOB® S 2000 Series and 2002 Series

1



Push-in type jumper bar; insulated; I_N 14 A; red

	Item No.	Pack. Unit
● 2-way	2000-402/000-005	25
● 3-way	2000-403/000-005	25
● 4-way	2000-404/000-005	25
● 5-way	2000-405/000-005	25
● 6-way	2000-406/000-005	25
● 7-way	2000-407/000-005	25
● 8-way	2000-408/000-005	25
● 9-way	2000-409/000-005	25
● 10-way	2000-410/000-005	25

Push-in type jumper bar; insulated; I_N 14 A; blue

	Item No.	Pack. Unit
● 2-way	2000-402/000-006	25
● 3-way	2000-403/000-006	25
● 4-way	2000-404/000-006	25
● 5-way	2000-405/000-006	25
● 6-way	2000-406/000-006	25
● 7-way	2000-407/000-006	25
● 8-way	2000-408/000-006	25
● 9-way	2000-409/000-006	25
● 10-way	2000-410/000-006	25

Push-in type jumper bar; insulated; yellow-green

	Item No.	Pack. Unit
● 2-way	2000-402/000-018	25

Push-in type jumper bar; insulated; I_N 25 A; red

● 2-way	2002-402/000-005	25
● 3-way	2002-403/000-005	25
● 4-way	2002-404/000-005	25
● 5-way	2002-405/000-005	25
● 6-way	2002-406/000-005	25
● 7-way	2002-407/000-005	25
● 8-way	2002-408/000-005	25
● 9-way	2002-409/000-005	25
● 10-way	2002-410/000-005	25

Push-in type jumper bar; insulated; I_N 25 A; blue

● 2-way	2002-402/000-006	25
● 3-way	2002-403/000-006	25
● 4-way	2002-404/000-006	25
● 5-way	2002-405/000-006	25
● 6-way	2002-406/000-006	25
● 7-way	2002-407/000-006	25
● 8-way	2002-408/000-006	25
● 9-way	2002-409/000-006	25
● 10-way	2002-410/000-006	25



For example, colored push-in type jumper bars are used with sensor terminal blocks.

Adjacent Jumper for Continuous Commoning TOPJOB® S 2002 Series

1

Technical Data	
800 V	
I_N 25 A	



Technical Data	
800 V/8 kV/3	
I_N 25 A	



Technical Data	
800 V/8 kV/3	
I_N 25 A	



Adjacent jumper for continuous commoning; insulated; light gray

	Item No.	Pack. Unit
○ 2-way	2002-400	25

Adjacent jumper for continuous commoning; insulated; 1 to 3

Color	Item No.	Pack. Unit
○ light gray	2002-423	25
● red	2002-423/000-005	25
● blue	2002-423/000-006	25

Adjacent jumper for continuous commoning; insulated; light gray

	Item No.	Pack. Unit
○ 5-way	2002-415	25

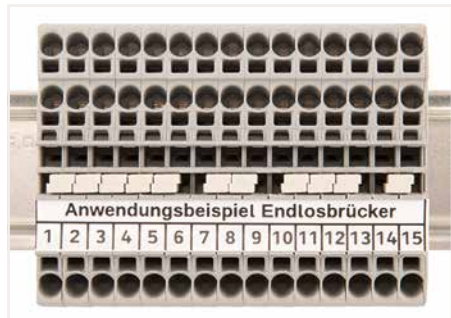

Continuous jumpers (2002 Series) readily connect an endless number of terminal blocks to each other via single jumper slot. Use the second jumper slot for additional commoning or testing.

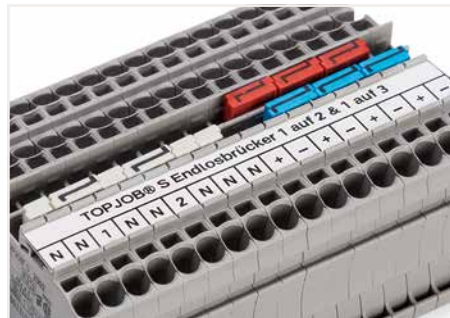

The 1-to-3 adjacent jumper for continuous commoning enables every other terminal block to be commoned. For example, positive and negative potentials can be accommodated alongside each other.

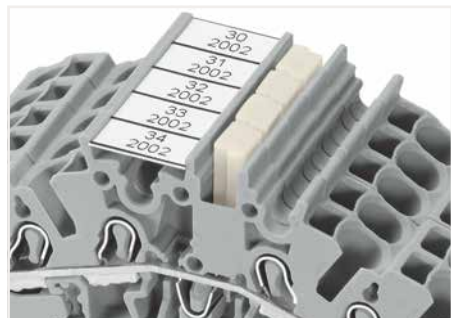

Adjacent jumpers for continuous commoning (2002-400)

Sold & Serviced By:
 **ELECTROMATE**
 Toll Free Phone (877) SERV098
www.electromate.com
sales@electromate.com

Staggered Jumper TOPJOB® S 2002 Series

1

Technical Data

400 V/6 kV/3

I_n 25 A

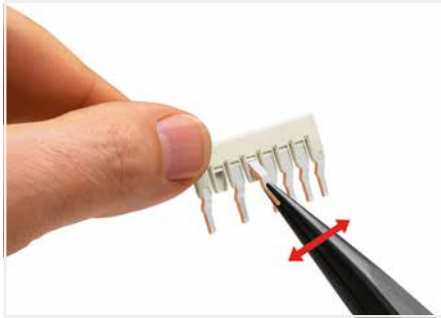

Staggered jumper (seven contacts):
Individual jumper contacts can be broken off by bending them. The remaining piece of insulation will meet requirements for clearances and creepage distances.

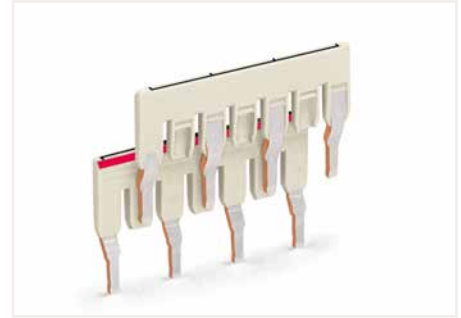

Staggered jumpers (seven contacts)

Staggered jumper; insulated; for 2002, 2003 and 2022 Series Rail-Mount Terminal Blocks; light gray

	Item No.	Pack. Unit
<input type="radio"/> 2-way	2002-472	25
<input type="radio"/> 3-way	2002-473	25
<input type="radio"/> 4-way	2002-474	25
<input type="radio"/> 5-way	2002-475	25
<input type="radio"/> 6-way	2002-476	25
<input type="radio"/> 7-way	2002-477	25
<input type="radio"/> 8-way	2002-478	25
<input type="radio"/> 9-way	2002-479	25
<input type="radio"/> 10-way	2002-480	25
<input type="radio"/> 11-way	2002-481	25
<input type="radio"/> 12-way	2002-482	25

Customized staggered jumper; insulated; with contact lugs broken off at the factory and circuit printing; light gray

<input type="radio"/> 1-3	2002-473/011-000	25
<input type="radio"/> 1-3-5	2002-475/011-000	25
<input type="radio"/> 1-3-5-7	2002-477/011-000	25
<input type="radio"/> 1-3-5-7-9	2002-479/011-000	25
<input type="radio"/> 1-3-5-7-9-11	2002-481/011-000	25

Commoning using staggered jumpers:

Individual jumper contacts can be broken off by bending them. The remaining piece of insulation will meet requirements for clearances and creepage distances.

Custom staggered jumpers can be created, e.g., for bridging over a terminal block with a different potential. Make sure that only one contact lug is in contact with the terminal block.

The contact lugs of the customized staggered jumpers contact the terminal blocks via the gaps created in the second jumper. Insert and press the ready-made jumper assembly into the jumper slot until it hits backstop.

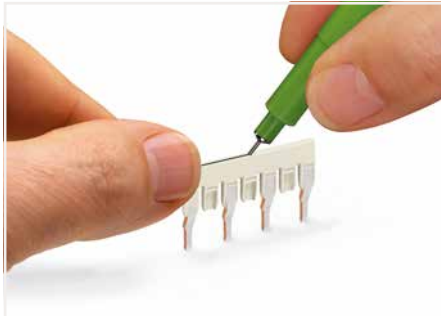

Staggered jumper:
Marking with a felt-tip pen.



Locate red stripes of the staggered jumpers on the inside. Insert staggered jumper and push down until it hits backstop.



Staggering jumpers in a single jumper slot.
Custom staggered jumpers can be created, e.g., for bridging over a terminal block with a different potential. Make sure that only one contact lug is in contact with the terminal block.

The contact lugs of the customized staggered jumpers contact the terminal blocks via the gaps created in the second jumper. Insert and press the ready-made jumper assembly into the jumper slot until it hits backstop.

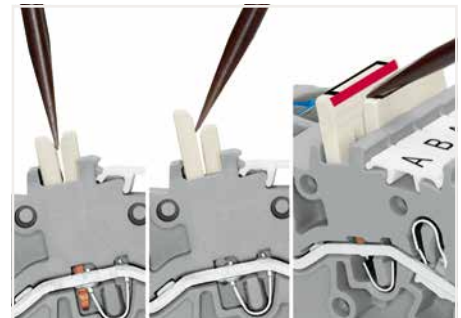

Removing a staggered jumper:
Insert the operating tool between the staggered jumpers, then lift up the jumper.

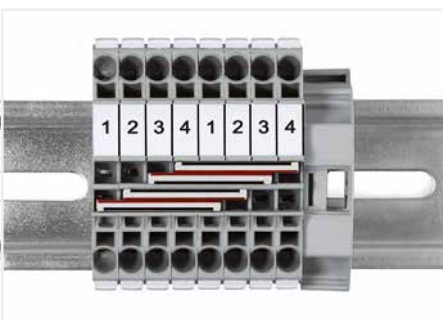

Commoning two potentials in one single jumper slot via extremely slim staggered jumpers.

Star Point Jumper, Delta Jumper and Collective Jumper Carrier TOPJOB® S

Technical Data
800 V/8 kV/3
I _N = I _N terminal block

Technical Data
800 V/8 kV/3
I _N = I _N terminal block



Star point jumper; insulated; 1-3-5; light gray		
	Item No.	Pack. Unit
<input type="radio"/>	2000-405/011-000	25
<input type="radio"/>	2001-405/011-000	25
<input type="radio"/>	2002-405/011-000	25
<input type="radio"/>	2004-405/011-000	25
<input type="radio"/>	2006-405/011-000	25
<input type="radio"/>	2010-405/011-000	25
<input type="radio"/>	2016-405/011-000	25

Delta jumper; insulated; 1-2 3-4 5-6; light gray		
	Item No.	Pack. Unit
<input type="radio"/>	2000-406/020-000	25
<input type="radio"/>	2001-406/020-000	25
<input type="radio"/>	2002-406/020-000	25
<input type="radio"/>	2004-406/020-000	25

Collective jumper carrier; for DIN-35 rail; for 2000 to 2016 Series jumpers		
Color	Item No.	Pack. Unit
<input type="radio"/> gray	2009-180	25

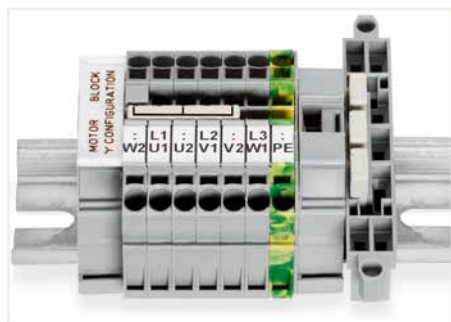

This star point jumper has been specially developed to create a "star point" and is used on motor terminal boards equipped with rail-mount terminal blocks TOPJOB® S.

This delta jumper has been specially developed to create a delta configuration and is used on motor terminal boards equipped with rail-mount terminal blocks TOPJOB® S.

Collective jumper carrier

Push-In Type Wire Jumper TOPJOB® S 2009 Series

1

Technical Data

800 V/8 kV/3

 I_n 9 A

Push-in type wire jumper; insulated; 0.75 mm² conductor cross-section; for 2000 and 2020 Series Rail-Mount Terminal Blocks; gray

	Item No.	Pack. Unit
L = 60 mm	2009-402	100 (10)
L = 110 mm	2009-404	100 (10)
L = 250 mm	2009-406	100 (10)

Technical Data

800 V/8 kV/3

 I_n 18 A

Push-in type wire jumper; insulated; 1.5 mm² conductor cross-section; for 2001, 2002, 2003 and 2022 Series Rail-Mount Terminal Blocks; black

	Item No.	Pack. Unit
L = 60 mm	2009-412	100 (10)
L = 110 mm	2009-414	100 (10)
L = 250 mm	2009-416	100 (10)



Push-in type wire jumper; insulated; L = 110 mm; 1.5 mm² conductor cross-section; for 2001, 2002, 2003 and 2022 Series Rail-Mount Terminal Blocks

Color	Item No.	Pack. Unit
● red	2009-414/000-005	100 (10)
● blue	2009-414/000-006	100 (10)



Push-in type wire jumpers common terminal blocks over longer distances and across multiple levels.

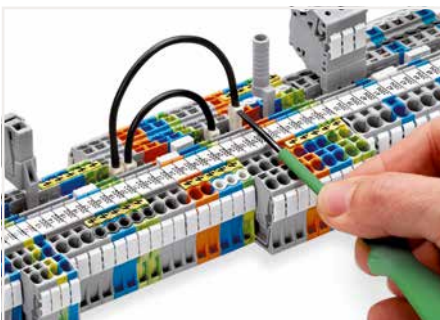

Push down the wire jumper until fully inserted. Lift the jumper with an operating tool for rewiring.

Vertical Jumper TOPJOB® S 2000 Series and 2002 Series

Technical Data	
500 V/6 kV/3	
I_N 13.5 A	



Technical Data	
500 V/6 kV/3	
I_N 24 A	



Technical Data	
500 V/6 kV/3	
I_N 24 A	



Double-deck vertical jumper; insulated		
Color	Item No.	Pack. Unit
○ light gray	2000-492	100 (25)

Double-deck vertical jumper; insulated		
Color	Item No.	Pack. Unit
○ light gray	2002-492	100 (25)
● orange	2002-492/000-012	100 (25)

Triple-deck vertical jumper; insulated		
Color	Item No.	Pack. Unit
○ light gray	2002-493	100 (25)

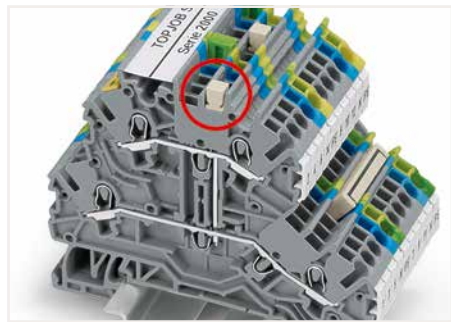

Commoning two levels via double-deck vertical jumper (2000-492).

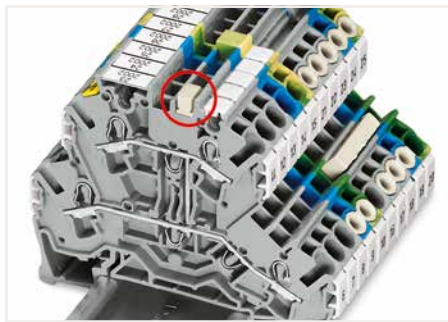

Commoning two levels via double-deck vertical jumper (2002-492).



Created for double- and triple-deck terminal blocks TOPJOB® S, the vertical jumpers can common two or three levels. Clearly marked numerals ("2" and "3") distinguish the double-deck (2002-492) and triple-deck vertical jumpers (2002-493), even when inserted.



Commoning three levels via triple-deck vertical jumper (2002-493).

Disconnect plug and Blind Plug for Carrier Terminal Block TOPJOB® S 2002 Series and 2006 Series

1

Technical Data

400 V/6 kV/3
I_n 10 A

Technical Data

800 V/8 kV/3
I_n 30 A



Disconnect plug for carrier terminal blocks; suitable when using a carrier terminal block as disconnect terminal block

Color	Item No.	Pack. Unit
● orange	2002-401	100 (25)

Disconnect plug for carrier terminal blocks; suitable when using a carrier terminal block as disconnect terminal block

Color	Item No.	Pack. Unit
● orange	2006-401	100 (25)
○ white	2006-401/000-050	100 (25)

Blind plug for carrier terminal block; indicates a disconnection

Color	Item No.	Pack. Unit
● red	2006-451	100 (25)

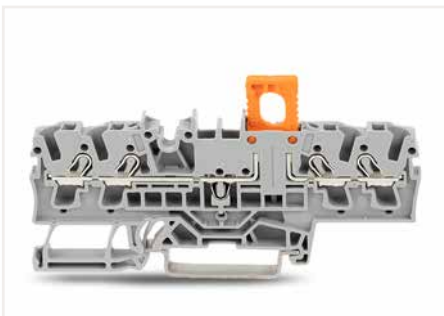

Carrier terminal block (2002-1661) with disconnect plug (2002-401) in operating position

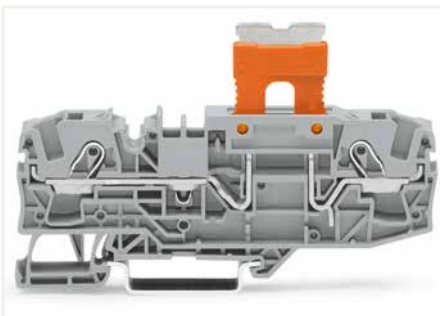

Carrier terminal block (2006-401) with disconnect plug (2002-1661) in parked position

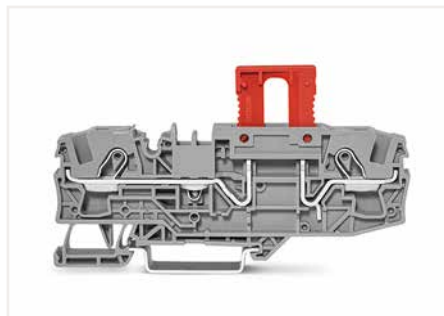

Blind plug (2006-451) for carrier terminal block; indicates a disconnection

Lockout Cap TOPJOB® S 2006 Series



Lockout cap; for conductor entry and operating slot

Color	Item No.	Pack. Unit
○ gray	2006-191	25



Cover (2006-191) seals unused conductor entry.

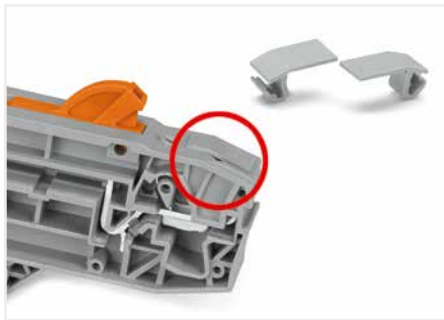

Cover (2006-191) seals unused conductor entry.

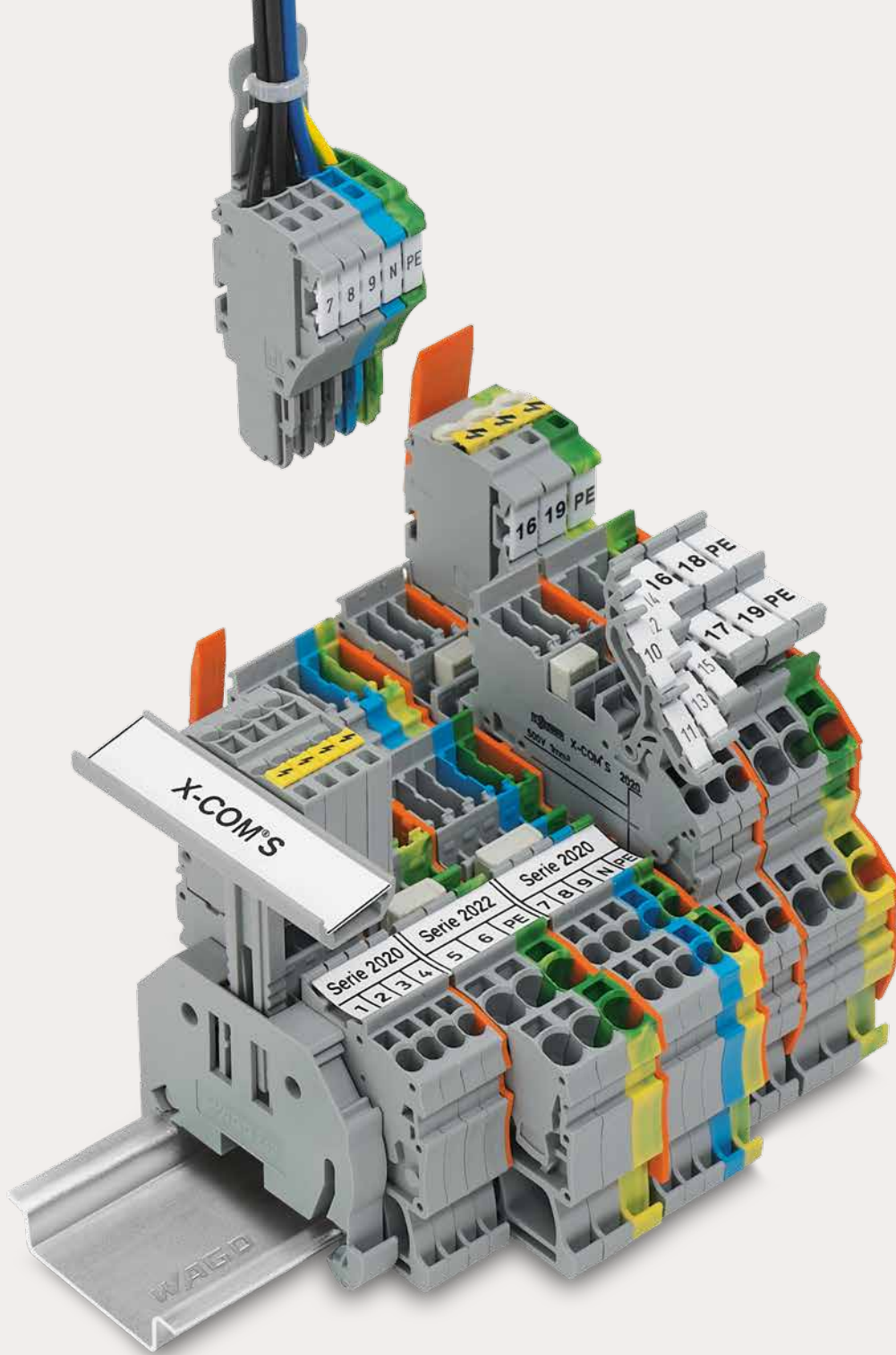

WAGO Rail-Mount Terminal Blocks with a Pluggable Connector X-COM[®]S-SYSTEM

WAGO Rail-Mount Terminal Blocks with a Pluggable Connector X-COM®S-SYSTEM Front-Entry Wiring

			Page
	X-COM®S-SYSTEM-MINI Through and Ground Conductor Carrier Terminal Blocks 0.14 ... 1 (1.5) mm ² (24 ... 16 AWG)	2020 Series	164
	Double-Deck Carrier Terminal Blocks 0.14 ... 1 (1.5) mm ² (24 ... 16 AWG)	2020 Series	166
	1- and 2-Conductor Female Plugs 0.14 ... 1 (1.5) mm ² (24 ... 16 AWG)	2020 Series	168
	1- and 2-Conductor Female Plugs for Self-Assembly 0.14 ... 1 (1.5) mm ² (24 ... 16 AWG)	2020 Series	170
	1- and 2-Conductor Female Plugs with Lateral Locking Levers and Strain Relief Plates 0.14 ... 1 (1.5) mm ² (24 ... 16 AWG)	2020 Series	176
	X-COM®S-SYSTEM Through and Ground Conductor Carrier Terminal Blocks 0.25 ... 2.5 (4) mm ² (22 ... 12 AWG)	2022 Series	180
	Double-Deck Carrier Terminal Blocks 0.25 ... 2.5 (4) mm ² (22 ... 12 AWG)	2022 Series	182
	1-Conductor Female Plugs 0.25 ... 2.5 (4) mm ² (22 ... 12 AWG)	2022 Series	184
	1-Conductor Female Plugs for Self-Assembly 0.25 ... 2.5 (4) mm ² (22 ... 12 AWG)	2022 Series	186
	1-Conductor Female Plugs with Lateral Locking Lever and Strain Relief Plate 0.25 ... 2.5 (4) mm ² (22 ... 12 AWG)	2022 Series	190
	X-COM®S-SYSTEM, for Ex nA Applications Through and Ground Conductor Carrier Terminal Blocks and Double-Deck Carrier Terminal Blocks 0.25 ... 2.5 (4) mm ² (22 ... 12 AWG)	2022 Series	192
	1-Conductor Female Plugs 0.25 ... 2.5 (4) mm ² (22 ... 12 AWG)	2022 Series	196

X-COM®S-SYSTEM-MINI; 2020 Series X-COM®S-SYSTEM; 2022 Series Description and Installation

2

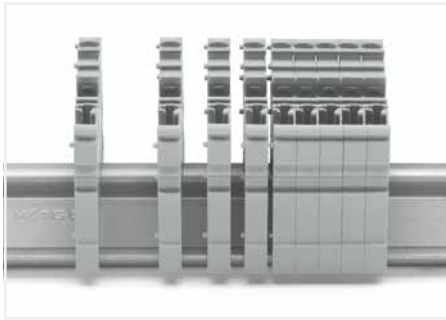

Snap individual carrier terminal blocks onto the DIN-rail and slide together.



Open the assembly by laterally sliding a block via operating tool (3.5 x 0.5 mm blade).

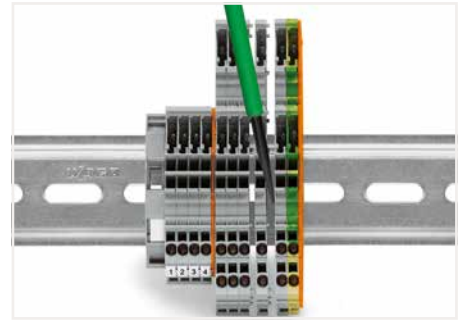

Separate terminal block assembly and slide individual terminal blocks laterally using an operating tool.



Carrier terminal blocks and female plugs are touch-proof.



Push-in CAGE CLAMP® enables solid conductors to be connected by simply pushing them into the unit.

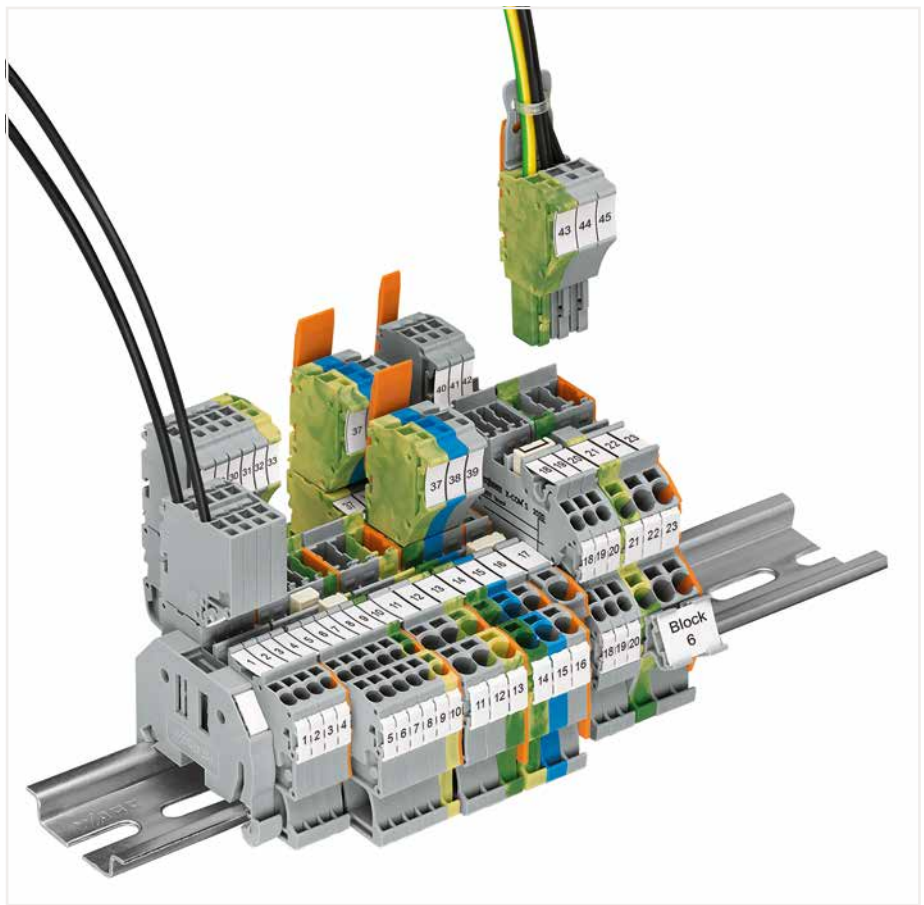

Note: Female plugs used according to the regulations must not be connected/disconnected when live or under load.

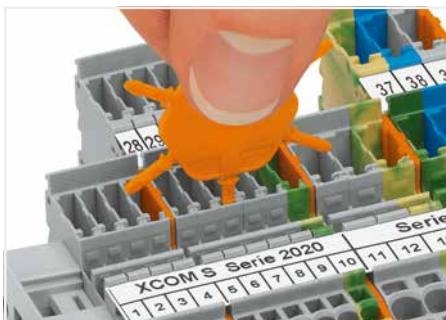

Insert coding pin into the corresponding slot and twist it off.



Coding a female plug: remove coding finger using a suitable tool.

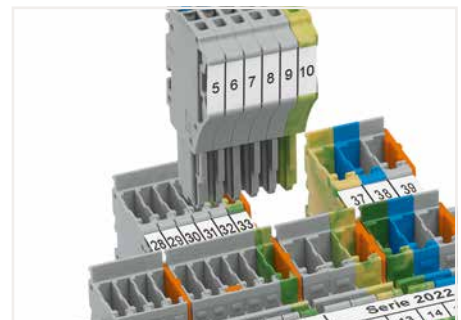

Insert coded female connector into X-COM®S-SYSTEM terminal block assembly.



Push-in CAGE CLAMP® terminates the following copper conductors:
solid



stranded



fine-stranded, also with tinned single strands

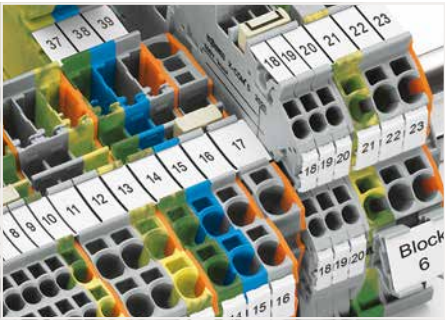

Commoning X-COM®S-SYSTEM Terminal Blocks using jumpers for Terminal Blocks TOPJOB® S. An end plate provides connection to Terminal Blocks TOPJOB® S. 2020 and 2022 Series Terminal Blocks are combinable. Jumper slots are on the same level for both series.

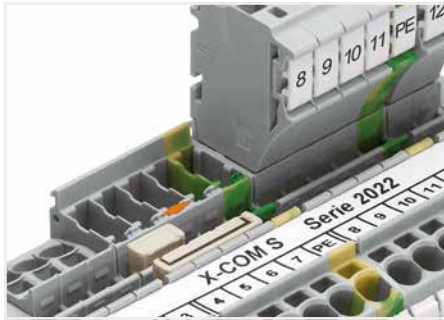

Pairing push-in comb style jumpers.

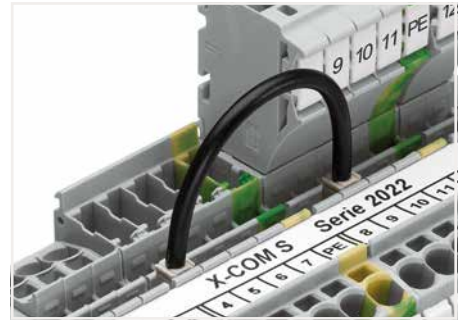

Commoning with push-in type wire jumper.

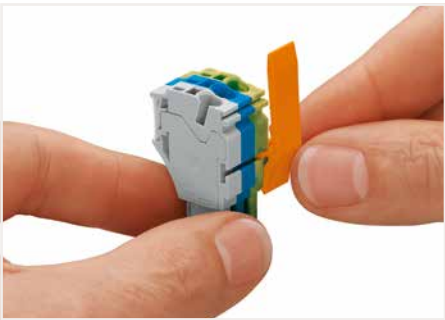

Slide the locking lever into position.

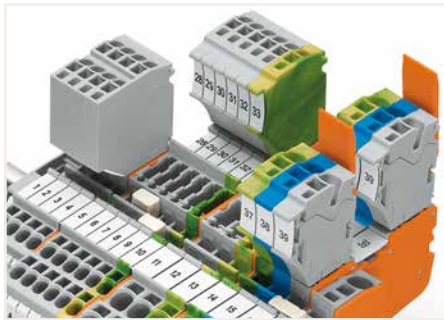

Female plugs can be individually locked.

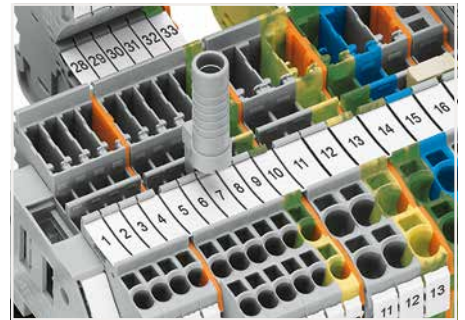

Test plug adapter (2009-174) for 4 mm test plugs or banana plugs – also suitable for X-COM®S-SYSTEM-MINI Terminal Blocks.

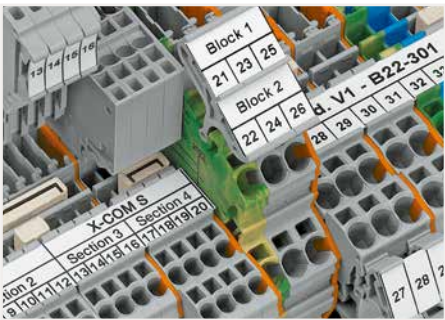

Clear marking via large marking area

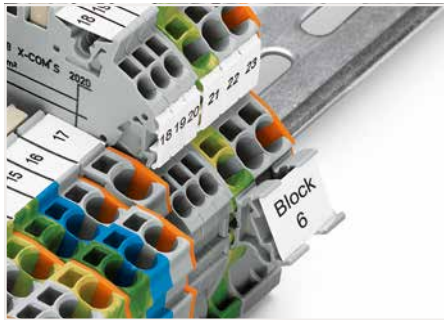

Marker carrier (2009-198)



fine-stranded, tip-bonded



fine-stranded, with ferrule (gastight crimped)



fine-stranded, with pin terminal (gastight crimped)

1-Conductor/1-Pin, 2-Conductor/1-Pin and 2-Conductor/2-Pin Carrier Terminal Block X-COM®S-SYSTEM-MINI 1 (1.5) mm²; 2020 Series

Technical Data	
0.14 ... 1 (1.5) mm ² ①	24 ... 16 AWG
500 V/6 kV/3 ②	300 V, 10 A ③
I _N 13.5 A ③	300 V, 10 A ④
Terminal block width: 3.5 mm / 0.138 inch	
9 ... 11 mm / 0.35 ... 0.43 inch	

Technical Data	
0.14 ... 1 (1.5) mm ² ①	24 ... 16 AWG
500 V/6 kV/3 ②	300 V, 10 A ③
I _N 13.5 A ③	300 V, 10 A ④
Terminal block width: 3.5 mm / 0.138 inch	
9 ... 11 mm / 0.35 ... 0.43 inch	

Technical Data	
0.14 ... 1 (1.5) mm ² ①	24 ... 16 AWG
500 V/6 kV/3 ②	300 V, 10 A ③
I _N 13.5 A ③	300 V, 10 A ④
Terminal block width: 3.5 mm / 0.138 inch	
9 ... 11 mm / 0.35 ... 0.43 inch	

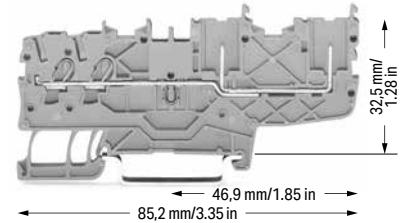
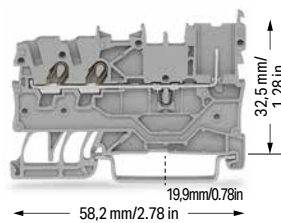
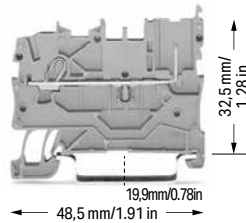

1-conductor/1-pin carrier terminal block		
Color	Item No.	Pack. Unit
○ gray	2020-1201	50
● blue	2020-1204	50

2-conductor/1-pin carrier terminal block		
Color	Item No.	Pack. Unit
○ gray	2020-1301	50
● blue	2020-1304	50

2-conductor/2-pin carrier terminal block		
Color	Item No.	Pack. Unit
○ gray	2020-1401	50
● blue	2020-1404	50

1-conductor/1-pin ground carrier terminal block		
● green-yellow	2020-1207	50

2-conductor/1-pin ground carrier terminal block		
● green-yellow	2020-1307	50

2-conductor/2-pin ground carrier terminal block		
● green-yellow	2020-1407	50

Accessories; item-specific			
End and intermediate plate; 1 mm thick			
orange	2020-1292	100 (25)	
gray	2020-1291	100 (25)	

Accessories; item-specific			
End and intermediate plate; 1 mm thick			
orange	2020-1392	100 (25)	
gray	2020-1391	100 (25)	

Accessories; item-specific			
End and intermediate plate; 1 mm thick			
orange	2020-1492	100 (25)	
gray	2020-1491	100 (25)	

Accessories; 2020 Series

Appropriate marking systems: WMB/WMB Inline/Marking strips

Push-in type jumper bar; insulated; I _N 14 A; light gray			
	2-way	2000-402	25
	3-way	2000-403	25
	4-way	2000-404	25
	5-way	2000-405	25
	6-way	2000-406	25
	7-way	2000-407	25
	8-way	2000-408	25
	9-way	2000-409	25
	10-way	2000-410	25

Delta jumper; insulated; I _N = I _N terminal block; light gray			
	1-2 3-4 5-6	2000-406/020-000	25

Star point jumper; insulated; I _N = I _N terminal block; light gray			
	1-3-5	2000-405/011-000	25

Test plug adapter; for 4 mm Ø test plug			
	gray	2009-174	100 (25)

Push-in type jumper bar; insulated; I _N 14 A; light gray			
	1 to 3	2000-433	25
	1 to 4	2000-434	25
	1 to 5	2000-435	25
	1 to 6	2000-436	25
	1 to 7	2000-437	25
	1 to 8	2000-438	25
	1 to 9	2000-439	25
	1 to 10	2000-440	25

Push-in type wire jumper; insulated; 0.75 mm ² conductor cross-section; I _N 9 A			
	L = 60 mm	2009-402	100 (10)
	L = 110 mm	2009-404	100 (10)
	L = 250 mm	2009-406	100 (10)

Banana plug; for 4 mm socket diameter; color mixed; 10 x orange, white, black, blue, yellow; max. 42 V			
		215-111	50

Protective warning marker; with black high-voltage symbol; for 5 terminal blocks			
	yellow	2000-115	100 (25)

Carrier with 6 coding pins; for coding female plugs			
	orange	2020-100	100 (25)

Testing tap; for max. 2.5 mm ²			
	gray	2009-182	100 (25)

1-conductor female plug			
	gray	2020-102	100

2-conductor female plug			
	gray	2020-202	100

Test pin; 1 mm Ø			
		859-500	1

1 Conductor range: 0.14 ... 1.5 mm² "s+f-st";
Push-in termination: 0.5 ... 1.5 mm² "s" and
0.5 ... 0.75 mm² "insulated ferrules; 12 mm"
Depending on the conductor characteristic, a conduc-
tor with a smaller cross section can also be inserted
via push-in termination.

2 500 V = rated voltage
6 kV = rated impulse voltage
3 = pollution degree
(see Section 14)

3 Current-carrying capacity curves upon request

Note:
When used as intended, female plugs must not be
connected/disconnected when live or under load.
An appropriate end plate must be applied to the
carrier terminal blocks after each female plug.

Please observe the application notes:
Jumpers, from page 152
Testing accessories, from page 151
Marking, from page 588

Approvals and corresponding ratings,
visit www.wago.com

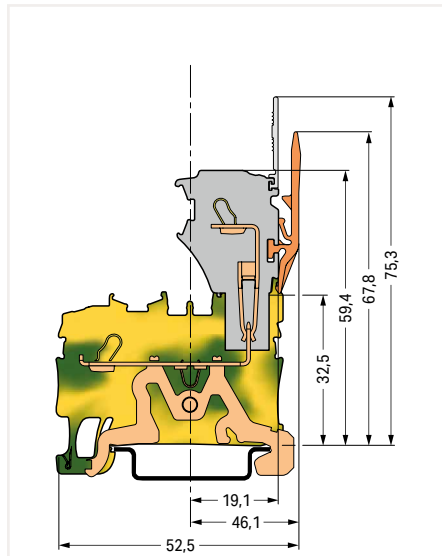

Ground carrier terminal block

Accessories; 2020 Series

Appropriate marking systems:
WMB/WMB Inline/Marking strips

WMB Inline; plain; 2,300 WMB markers (3.5 mm)/reel

	white	2009-113	1
--	-------	----------	---

WMB marking card; white; 10 strips with 10 markers/card; for 3.5 mm terminal block width

	plain	793-3501	5
---	-------	----------	---

Marking strip; plain; 11 mm wide; 50 m reel

	white	2009-110	1
---	-------	----------	---

Screwless end stop; for DIN-35 rail; 6 mm wide

	gray	249-116	100 (25)
---	------	---------	----------

Screwless end stop; for DIN-35 rail; 10 mm wide

	gray	249-117	50 (25)
---	------	---------	---------

1-Conductor/1-Pin Double-Deck Carrier Terminal Block X-COM®S-SYSTEM-MINI 1 (1.5) mm²; 2020 Series

Technical Data	
0.14 ... 1 (1.5) mm ² ①	24 ... 16 AWG
500 V/6 kV/3 ②	300 V, 10 A ③
I _N 13.5 A ③	300 V, 10 A ④
Terminal block width: 3.5 mm / 0.138 inch	
9 ... 11 mm / 0.35 ... 0.43 inch	

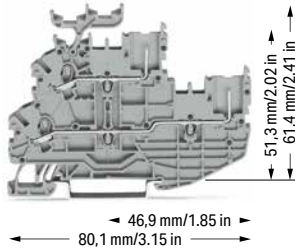

1-conductor/1-pin double-deck carrier terminal block; through/through terminal block; with marker carrier; gray housing

	Item No.	Pack. Unit
<input type="radio"/> L/L	2020-2231	50
<input type="radio"/> N/L	2020-2232	50
<input type="radio"/> L/N	2020-2233	50

Technical Data	
0.14 ... 1 (1.5) mm ² ①	24 ... 16 AWG
500 V/6 kV/3 ②	300 V, 10 A ③
I _N 13.5 A ③	300 V, 10 A ④
Terminal block width: 3.5 mm / 0.138 inch	
9 ... 11 mm / 0.35 ... 0.43 inch	

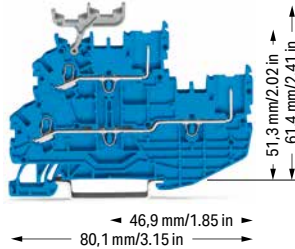

1-conductor/1-pin double-deck carrier terminal block; through/through terminal block; with marker carrier; blue housing

	Item No.	Pack. Unit
<input checked="" type="radio"/> N/N	2020-2234	50

Technical Data	
0.14 ... 1 (1.5) mm ² ①	24 ... 16 AWG
500 V/6 kV/3 ②	300 V, 10 A ③
I _N 13.5 A ③	300 V, 10 A ④
Terminal block width: 3.5 mm / 0.138 inch	
9 ... 11 mm / 0.35 ... 0.43 inch	

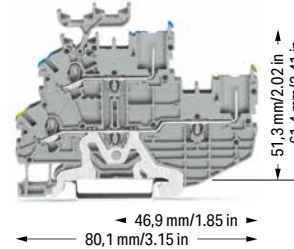

1-conductor/1-pin double-deck carrier terminal block; ground conductor/through terminal block; with marker carrier; gray housing

	Item No.	Pack. Unit
<input type="radio"/> PE/N	2020-2247	50
<input type="radio"/> PE/L	2020-2257	50

1-conductor/1-pin double-deck carrier terminal block; through/through terminal block; without marker carrier; gray housing

	Item No.	Pack. Unit
<input type="radio"/> L/L	2020-2201	50
<input type="radio"/> N/L	2020-2202	50
<input type="radio"/> L/N	2020-2203	50

1-conductor/1-pin double-deck carrier terminal block; through/through terminal block; without marker carrier; blue housing

	Item No.	Pack. Unit
<input checked="" type="radio"/> N/N	2020-2204	50

1-conductor/1-pin double-deck carrier terminal block; ground conductor/through terminal block; without marker carrier; gray housing

	Item No.	Pack. Unit
<input type="radio"/> PE/N	2020-2217	50
<input type="radio"/> PE/L	2020-2227	50

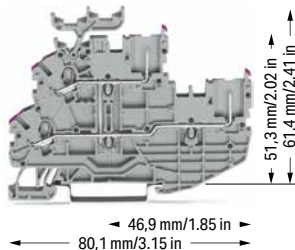

2-conductor/2-pin double-deck carrier terminal block; 2-conductor/2-pin through terminal block; with marker carrier, internally commoned; violet conductor entry; gray housing

	Item No.	Pack. Unit
<input type="radio"/> L	2020-2238	50

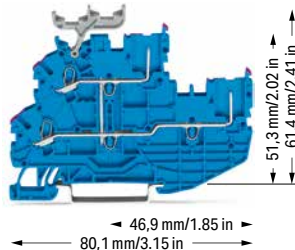

2-conductor/2-pin double-deck carrier terminal block; 2-conductor/2-pin through terminal block; with marker carrier, internally commoned; violet conductor entry; blue housing

	Item No.	Pack. Unit
<input checked="" type="radio"/> N	2020-2239	50

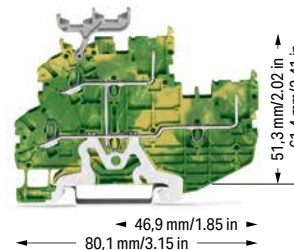

2-conductor/2-pin double-deck carrier block; 2-conductor/2-pin ground conductor block; with marker carrier, internally commoned; green-yellow housing

	Item No.	Pack. Unit
<input checked="" type="radio"/> PE	2020-2237	50

2-conductor/2-pin double-deck carrier terminal block; 2-conductor/2-pin through terminal block; without marker carrier, internally commoned; violet conductor entry; gray housing

	Item No.	Pack. Unit
<input type="radio"/> L	2020-2208	50

2-conductor/2-pin double-deck carrier terminal block; 2-conductor/2-pin through terminal block; without marker carrier, internally commoned; violet conductor entry; blue housing

	Item No.	Pack. Unit
<input checked="" type="radio"/> N	2020-2209	50

2-conductor/2-pin double-deck carrier block; 2-conductor/2-pin ground conductor block; without marker carrier, internally commoned; green-yellow housing

	Item No.	Pack. Unit
<input checked="" type="radio"/> PE	2020-2207	50

1 Conductor range: 0.14 ... 1.5 mm² "s+f-st";
Push-in termination: 0.5 ... 1.5 mm² "s" and
0.5 ... 0.75 mm² "insulated ferrules; 12 mm"
Depending on the conductor characteristic, a conductor
with a smaller cross section can also be inserted
via push-in termination.

2 500 V = rated voltage
6 kV = rated impulse voltage
3 = pollution degree
(see Section 14)

3 Current-carrying capacity curves upon request

Note:

When used as intended, female plugs must not be
connected/disconnected when live or under load.
An appropriate end plate must be applied to the
carrier terminal blocks after each female plug.

Please observe the application notes:
Jumpers, from page 152
Testing accessories, from page 151
Marking, from page 588

Approvals and corresponding ratings,
visit www.wago.com

Accessories; 2020 Series

Appropriate marking systems:
WMB/WMB Inline/Marking strips

End and intermediate plate; 1 mm thick

	orange	2020-2292	100 (25)
	gray	2020-2291	100 (25)

Push-in type jumper bar; insulated; I_N 14 A; light gray

	2-way	2000-402	25
	3-way	2000-403	25
	4-way	2000-404	25
	5-way	2000-405	25
	6-way	2000-406	25
	7-way	2000-407	25
	8-way	2000-408	25
	9-way	2000-409	25
	10-way	2000-410	25

Push-in type jumper bar; insulated; I_N 14 A; light gray

	1 to 3	2000-433	25
	1 to 4	2000-434	25
	1 to 5	2000-435	25
	1 to 6	2000-436	25
	1 to 7	2000-437	25
	1 to 8	2000-438	25
	1 to 9	2000-439	25
	1 to 10	2000-440	25

Double-deck vertical jumper; insulated; I_N 13.5 A

	light gray	2000-492	100 (25)
---	------------	----------	----------

**Protective warning marker; with black high-voltage
symbol; for 5 terminal blocks**

	yellow	2000-115	100 (25)
---	--------	----------	----------

Carrier with 6 coding pins; for coding female plugs

	orange	2020-100	100 (25)
---	--------	----------	----------

Test pin; 1 mm Ø

		859-500	1
---	--	---------	---

Accessories; 2020 Series

Appropriate marking systems:
WMB/WMB Inline/Marking strips

Test plug adapter; for 4 mm Ø test plug

	gray	2009-174	100 (25)
---	------	----------	----------

**Banana plug; for 4 mm socket diameter; color mixed; 10 x
orange, white, black, blue, yellow; max. 42 V**

		215-111	50
---	--	---------	----

Testing tap; for max. 2.5 mm²

	gray	2009-182	100 (25)
---	------	----------	----------

Test plug; with 500 mm cable; 2 mm Ø; max. 42 V

	red	210-136	50
---	-----	---------	----

Test plug; with 500 mm cable; 2.3 mm Ø; max. 42 V

	yellow	210-137	50
---	--------	---------	----

1-conductor female plug

	gray	2020-102	100
--	------	----------	-----

2-conductor female plug

	gray	2020-202	100
---	------	----------	-----

WMB Inline; plain; 2,300 WMB markers (3.5 mm)/reel

	white	2009-113	1
---	-------	----------	---

**WMB marking card; white; 10 strips with 10 markers/card;
for 3.5 mm terminal block width**

	plain	793-3501	5
---	-------	----------	---

Marking strip; plain; 11 mm wide; 50 m reel

	white	2009-110	1
---	-------	----------	---

Double-deck marker carrier; pivoting

	gray	2000-121	50 (25)
---	------	----------	---------



Size comparison:
Double-deck carrier terminal blocks with 3.5 mm and
5.2 mm terminal block widths

Sold & Serviced By:



Toll Free Phone (877) SERV098

www.electromate.com

sales@electromate.com

1-Conductor Female Plug and 2-Conductor Female Plug X-COM®S-SYSTEM-MINI 1 (1.5) mm²; 2020 Series

Technical Data	
0.14 ... 1 (1.5) mm ² ❶	24 ... 16 AWG
500 V/6 kV/3 ❷	300 V, 10 A ❸
I _N 13.5 A ❸	300 V, 10 A ❸
Module width: 3.5 mm / 0.138 inch	
9 ... 11 mm / 0.35 ... 0.43 inch	

Technical Data	
0.14 ... 1 (1.5) mm ² ❶	24 ... 16 AWG
500 V/6 kV/3 ❷	300 V, 10 A ❸
I _N 13.5 A ❸	300 V, 10 A ❸
Module width: 3.5 mm / 0.138 inch	
9 ... 11 mm / 0.35 ... 0.43 inch	

❶ Conductor range: 0.14 ... 1.5 mm² "s+f-st"; Push-in termination: 0.5 ... 1.5 mm² "s" and 0.5 ... 0.75 mm² "insulated ferrules; 12 mm"
Depending on the conductor characteristic, a conductor with a smaller cross section can also be inserted via push-in termination.

❷ 500 V = rated voltage
6 kV = rated impulse voltage
3 = pollution degree
(see Section 14)

❸ Current-carrying capacity curves upon request

Item no. suffixes
blue .../000-006
green-yellow .../000-016

Approvals and corresponding ratings, visit www.wago.com



Dimensions (in mm):

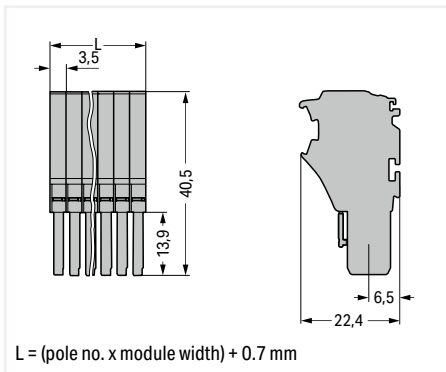

Dimensions (in mm):

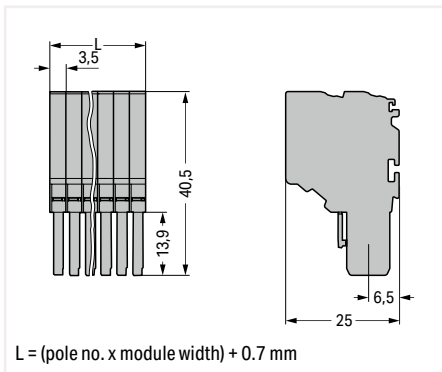

1-conductor female plug; fits into carrier terminal blocks; codable; gray
According to EN 61984, pluggable connectors without a current interrupting capacity must not be mated or unmated when live or under load.
Notice: An appropriate end plate must be applied to the carrier terminal blocks after each female plug.

2-conductor female plug; fits into carrier terminal blocks; codable; gray
According to EN 61984, pluggable connectors without a current interrupting capacity must not be mated or unmated when live or under load.
Notice: An appropriate end plate must be applied to the carrier terminal blocks after each female plug.

Pole No.	Item No.	Pack. Unit
2	2020-102	100
3	2020-103	50
4	2020-104	50
5	2020-105	50
6	2020-106	50
7	2020-107	25
8	2020-108	25
9	2020-109	25
10	2020-110	25
11	2020-111	20
12	2020-112	20
13	2020-113	10
14	2020-114	10
15	2020-115	10

Pole No.	Item No.	Pack. Unit
2	2020-202	100
3	2020-203	50
4	2020-204	50
5	2020-205	50
6	2020-206	25
7	2020-207	25
8	2020-208	25
9	2020-209	25
10	2020-210	25
11	2020-211	20
12	2020-212	20
13	2020-213	10
14	2020-214	10
15	2020-215	10

Accessories; for female plugs

Appropriate marking systems: WMB/WMB Inline/Marking strips

Protective warning marker; with black high-voltage symbol; for 5 terminal blocks			
yellow	2000-115	100 (25)	



Carrier with 6 coding pins; for coding female plugs			
orange	2020-100	100 (25)	



Locking lever; 4.8 mm wide			
orange	2022-142	100 (25)	
gray	2022-141	100 (25)	



Locking lever; 9.6 mm wide			
orange	2022-152	100 (25)	
gray	2022-151	100 (25)	



X-COM®S-SYSTEM terminal block assembly



X-COM®S-SYSTEM terminal block assembly

Carrier Terminal Blocks and 1-/2-Conductor Female Plugs X-COM®S-SYSTEM-MINI Types of Assembly

2



1-conductor female plug
Carrier terminal blocks can be commoned via 2000 Series Push-In Type Jumper Bars and tested via 859-500 Test Pin.

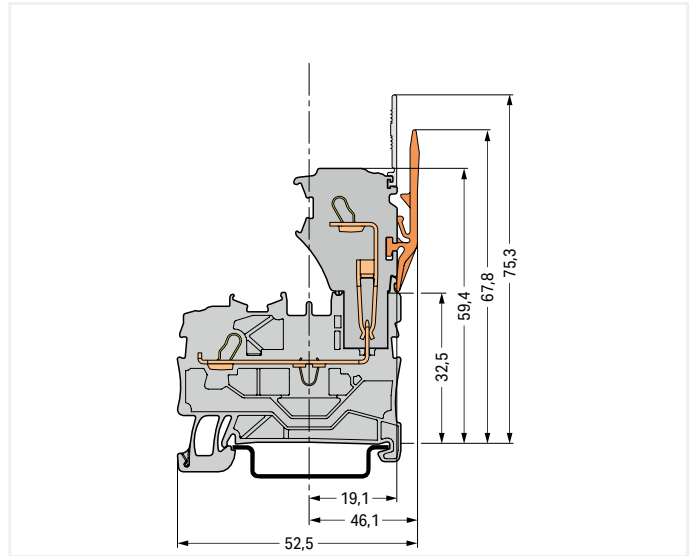

Carrier terminal block

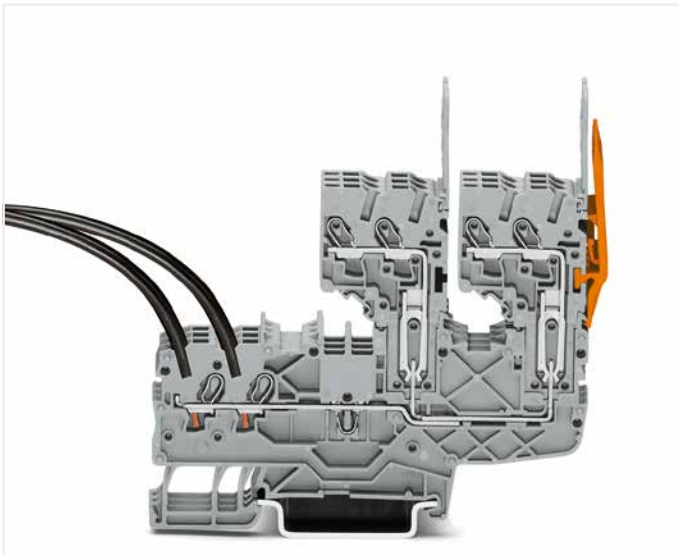

2-conductor female plug
Carrier terminal blocks can be commoned via 2000 Series Push-In Type Jumper Bars and tested via 859-500 Test Pin.

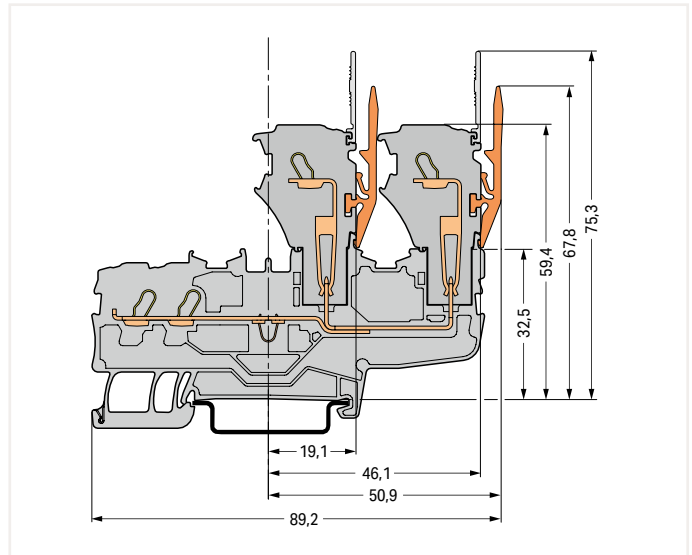

Carrier terminal block

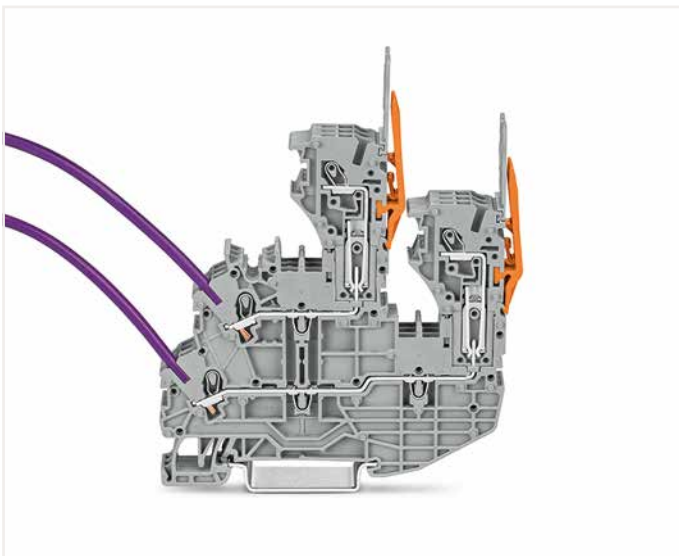

1-conductor female plug
Double-deck carrier terminal blocks can be commoned via 2000 Series Push-In Type Jumper Bars and tested via 859-500 Test Pin.

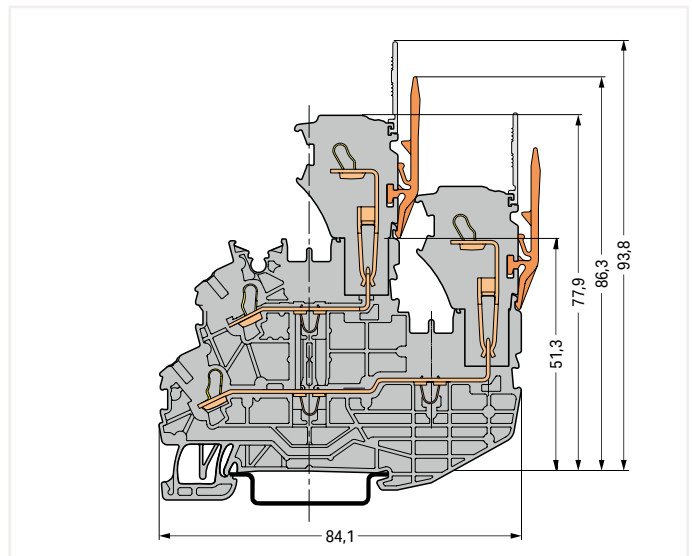

Double-deck carrier terminal block

Female Plug for Self-Assembly X-COM®S-SYSTEM-MINI 1 (1.5) mm²; 2020 Series

Technical Data

0.14 ... 1 (1.5) mm² ① 24 ... 16 AWG

500 V/6 kV/3 ② 300 V, 10 A ③

I_N 13.5 A ③ 300 V, 10 A ③

Terminal block width: 3.5 mm / 0.138 inch

9 ... 11 mm / 0.35 ... 0.43 inch

Technical Data

0.14 ... 1 (1.5) mm² ① 24 ... 16 AWG

500 V/6 kV/3 ② 300 V, 10 A ③

I_N 13.5 A ③ 300 V, 10 A ③

Terminal block width: 3.5 mm / 0.138 inch

9 ... 11 mm / 0.35 ... 0.43 inch



1-conductor end module; codable

Color	Item No.	Pack. Unit
gray	2020-181	250
blue	2020-184	250
green-yellow	2020-187	250

2-conductor end module; codable

Color	Item No.	Pack. Unit
gray	2020-281	250
blue	2020-284	250
green-yellow	2020-287	250

1-conductor base module; with end plate; codable

gray	2020-161	250
blue	2020-164	250
green-yellow	2020-167	250

2-conductor base module; with end plate; codable

gray	2020-261	250
blue	2020-264	250
green-yellow	2020-267	250

Accessories; for female plugs

Appropriate marking systems: WMB/WMB Inline/Marking strips

Protective warning marker; with black high-voltage symbol; for 5 terminal blocks

yellow 2000-115 100 (25)



WMB Inline; plain; 2,300 WMB markers (3.5 mm)/reel

white 2009-113 1



Carrier with 6 coding pins; for coding female plugs

orange 2020-100 100 (25)



WMB marking card; white; 10 strips with 10 markers/card; for 3.5 mm terminal block width

plain 793-3501 5



Locking lever; 4.8 mm wide

orange 2022-142 100 (25)

gray 2022-141 100 (25)



Marking strip; plain; 11 mm wide; 50 m reel

white 2009-110 1



Locking lever; 9.6 mm wide

orange 2022-152 100 (25)

gray 2022-151 100 (25)



Strain relief plate; gray

35 mm wide 734-326 100 (25)

6 mm wide 734-327 100 (25)

12.5 mm wide 734-328 100 (25)

25 mm wide 734-329 100 (25)



① Conductor range: 0.14 ... 1.5 mm² "s+f-st"; Push-in termination: 0.5 ... 1.5 mm² "s" and 0.5 ... 0.75 mm² "insulated ferrules; 12 mm"
Depending on the conductor characteristic, a conductor with a smaller cross section can also be inserted via push-in termination.

② 500 V = rated voltage
6 kV = rated impulse voltage
3 = pollution degree
(see Section 14)

③ Current-carrying capacity curves upon request

Note:

According to EN 61984, pluggable connectors without a current interrupting capacity must not be mated or unmated when live or under load.

Notice: An appropriate end plate must be applied to the carrier terminal blocks after each female plug.

Approvals and corresponding ratings, visit www.wago.com

Customizing Modular Female Plugs

WAGO's modular X-COM®S-SYSTEM female plugs can be customized for applications requiring varying numbers of poles (e.g., when designing prototypes).

Modules and Pole Numbers

A customized X-COM®S-SYSTEM-MINI female plug consists of:

- One base module with end plate
- Up to 14 end modules

Intended Use

According to EN 61984, pluggable connectors without a current interrupting capacity must not be mated or unmated when live or under load.

Mounting

The appropriate mounting tool shall be used in order to guarantee that the individual modules are properly attached to each other without damaging the locking latches.



End module

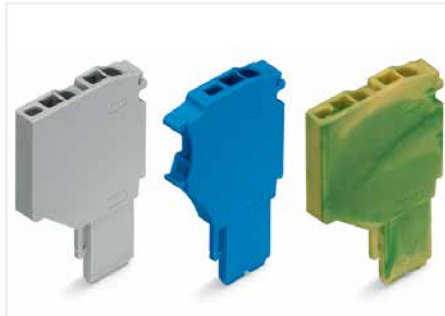

Base module

Example: 5-Pole, 1-Conductor Female Plug

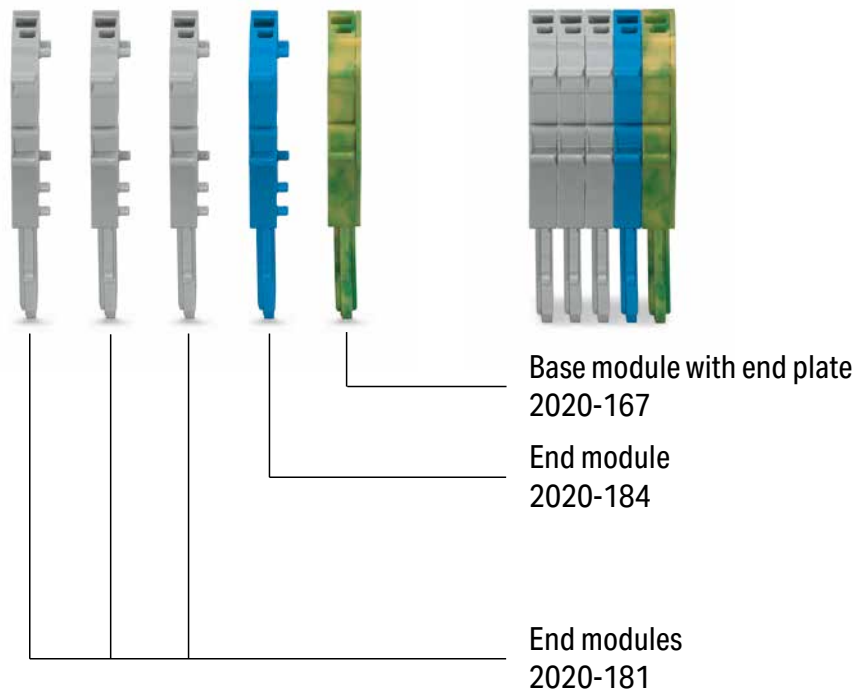

Pre-Assembled 1-Conductor Female Plug X-COM®S-SYSTEM-MINI 1 (1.5) mm²; 2020 Series

Technical Data	
0.14 ... 1 (1.5) mm ² ❶	24 ... 16 AWG
500 V/6 kV/3 ❷	300 V, 10 A
I _N 13.5 A ❸	300 V, 10 A
Module width: 3.5 mm / 0.138 inch	
9 ... 11 mm / 0.35 ... 0.43 inch	

Technical Data	
0.14 ... 1 (1.5) mm ² ❶	24 ... 16 AWG
500 V/6 kV/3 ❷	300 V, 10 A
I _N 13.5 A ❸	300 V, 10 A
Module width: 3.5 mm / 0.138 inch	
9 ... 11 mm / 0.35 ... 0.43 inch	

Technical Data	
0.14 ... 1 (1.5) mm ² ❶	24 ... 16 AWG
500 V/6 kV/3 ❷	300 V, 10 A
I _N 13.5 A ❸	300 V, 10 A
Module width: 3.5 mm / 0.138 inch	
9 ... 11 mm / 0.35 ... 0.43 inch	



1-conductor female plug; with ground base module (green-yellow); fits into carrier terminal blocks; codable

Pole No.	Item No.	Pack. Unit
3	2020-103/000-036	50
4	2020-104/000-036	50
5	2020-105/000-036	50
6	2020-106/000-036	50
7	2020-107/000-036	25
8	2020-108/000-036	25
9	2020-109/000-036	25
10	2020-110/000-036	25
11	2020-111/000-036	20
12	2020-112/000-036	20
13	2020-113/000-036	10
14	2020-114/000-036	10
15	2020-115/000-036	10

1-conductor female plug; with ground end module (green-yellow); fits into carrier terminal blocks; codable

Pole No.	Item No.	Pack. Unit
3	2020-103/000-037	50
4	2020-104/000-037	50
5	2020-105/000-037	50
6	2020-106/000-037	50
7	2020-107/000-037	25
8	2020-108/000-037	25
9	2020-109/000-037	25
10	2020-110/000-037	25
11	2020-111/000-037	20
12	2020-112/000-037	20
13	2020-113/000-037	10
14	2020-114/000-037	10
15	2020-115/000-037	10

1-conductor female plug; with ground base module (green-yellow); fits into carrier terminal blocks; codable

Pole No.	Item No.	Pack. Unit
3	2020-103/000-038	50
4	2020-104/000-038	50
5	2020-105/000-038	50
6	2020-106/000-038	50
7	2020-107/000-038	25
8	2020-108/000-038	25
9	2020-109/000-038	25
10	2020-110/000-038	25
11	2020-111/000-038	20
12	2020-112/000-038	20
13	2020-113/000-038	10
14	2020-114/000-038	10
15	2020-115/000-038	10

Accessories; for female plugs

Appropriate marking systems: WMB/WMB Inline/Marking strips

Protective warning marker; with black high-voltage symbol; for 5 terminal blocks

yellow	2000-115	100 (25)
--------	----------	----------



Carrier with 6 coding pins; for coding female plugs

orange	2020-100	100 (25)
--------	----------	----------



Locking lever; 4.8 mm wide

orange	2022-142	100 (25)
gray	2022-141	100 (25)



Locking lever; 9.6 mm wide

orange	2022-152	100 (25)
gray	2022-151	100 (25)



Strain relief plate; gray

35 mm wide	734-326	100 (25)
6 mm wide	734-327	100 (25)
12.5 mm wide	734-328	100 (25)
25 mm wide	734-329	100 (25)



WMB Inline; plain; 2,300 WMB markers (3.5 mm)/reel

white	2009-113	1
-------	----------	---



WMB marking card; white; 10 strips with 10 markers/card; for 3.5 mm terminal block width

plain	793-3501	5
-------	----------	---



Marking strip; plain; 11 mm wide; 50 m reel

white	2009-110	1
-------	----------	---



Technical Data

0.14 ... 1 (1.5) mm² ❶ | 24 ... 16 AWG

500 V/6 kV/3 ❷ | 300 V, 10 A ❸

I_N 13.5 A ❸ | 300 V, 10 A ❸

Module width: 3.5 mm / 0.138 inch

9 ... 11 mm / 0.35 ... 0.43 inch



❶ Conductor range: 0.14 ... 1.5 mm² "s+f-st";
Push-in termination: 0.5 ... 1.5 mm² "s" and
0.5 ... 0.75 mm² "insulated ferrules; 12 mm"
Depending on the conductor characteristic, a conduc-
tor with a smaller cross section can also be inserted
via push-in termination.

❷ 500 V = rated voltage
6 kV = rated impulse voltage
3 = pollution degree
(see Section 14)

❸ Current-carrying capacity curves upon request

Note:

According to EN 61984, pluggable connectors without
a current interrupting capacity must not be mated or
unmated when live or under load.

Notice: An appropriate end plate must be applied to
the carrier terminal blocks after each female plug.

Approvals and corresponding ratings,
visit www.wago.com

1-conductor female plug; with ground end module
(green-yellow); fits into carrier terminal blocks; codable

Pole No.	Item No.	Pack. Unit
3	2020-103/000-039	50
4	2020-104/000-039	50
5	2020-105/000-039	50
6	2020-106/000-039	50
7	2020-107/000-039	25
8	2020-108/000-039	25
9	2020-109/000-039	25
10	2020-110/000-039	25
11	2020-111/000-039	20
12	2020-112/000-039	20
13	2020-113/000-039	10
14	2020-114/000-039	10
15	2020-115/000-039	10

Pre-Assembled 2-Conductor Female Plug X-COM®S-SYSTEM-MINI 1 (1.5) mm²; 2020 Series

Technical Data	
0.14 ... 1 (1.5) mm ² ❶	24 ... 16 AWG
500 V/6 kV/3 ❷	300 V, 10 A ❸
I _N 13.5 A ❸	300 V, 10 A ❸
Module width: 3.5 mm / 0.138 inch	
9 ... 11 mm / 0.35 ... 0.43 inch	

Technical Data	
0.14 ... 1 (1.5) mm ² ❶	24 ... 16 AWG
500 V/6 kV/3 ❷	300 V, 10 A ❸
I _N 13.5 A ❸	300 V, 10 A ❸
Module width: 3.5 mm / 0.138 inch	
9 ... 11 mm / 0.35 ... 0.43 inch	

Technical Data	
0.14 ... 1 (1.5) mm ² ❶	24 ... 16 AWG
500 V/6 kV/3 ❷	300 V, 10 A ❸
I _N 13.5 A ❸	300 V, 10 A ❸
Module width: 3.5 mm / 0.138 inch	
9 ... 11 mm / 0.35 ... 0.43 inch	



2-conductor female plug; with ground base module (green-yellow); fits into carrier terminal blocks; codable

Pole No.	Item No.	Pack. Unit
3	2020-203/000-036	50
4	2020-204/000-036	50
5	2020-205/000-036	50
6	2020-206/000-036	50
7	2020-207/000-036	25
8	2020-208/000-036	25
9	2020-209/000-036	25
10	2020-210/000-036	25
11	2020-211/000-036	20
12	2020-212/000-036	20
13	2020-213/000-036	10
14	2020-214/000-036	10
15	2020-215/000-036	

2-conductor female plug; with ground end module (green-yellow); fits into carrier terminal blocks; codable

Pole No.	Item No.	Pack. Unit
3	2020-203/000-037	50
4	2020-204/000-037	50
5	2020-205/000-037	50
6	2020-206/000-037	50
7	2020-207/000-037	25
8	2020-208/000-037	25
9	2020-209/000-037	25
10	2020-210/000-037	25
11	2020-211/000-037	20
12	2020-212/000-037	20
13	2020-213/000-037	10
14	2020-214/000-037	10
15	2020-215/000-037	10

2-conductor female plug; with ground base module (green-yellow); fits into carrier terminal blocks; codable

Pole No.	Item No.	Pack. Unit
3	2020-203/000-038	50
4	2020-204/000-038	50
5	2020-205/000-038	50
6	2020-206/000-038	50
7	2020-207/000-038	25
8	2020-208/000-038	25
9	2020-209/000-038	25
10	2020-210/000-038	25
11	2020-211/000-038	20
12	2020-212/000-038	20
13	2020-213/000-038	10
14	2020-214/000-038	10
15	2020-215/000-038	10

Accessories; for female plugs

Appropriate marking systems: WMB/WMB Inline/Marking strips

Protective warning marker; with black high-voltage symbol; for 5 terminal blocks

yellow	2000-115	100 (25)
--------	----------	----------



Carrier with 6 coding pins; for coding female plugs

orange	2020-100	100 (25)
--------	----------	----------



Locking lever; 4.8 mm wide

orange	2022-142	100 (25)
gray	2022-141	100 (25)



Locking lever; 9.6 mm wide

orange	2022-152	100 (25)
gray	2022-151	100 (25)



Strain relief plate; gray

35 mm wide	734-326	100 (25)
6 mm wide	734-327	100 (25)
12.5 mm wide	734-328	100 (25)
25 mm wide	734-329	100 (25)



WMB Inline; plain; 2,300 WMB markers (3.5 mm)/reel

white	2009-113	1
-------	----------	---



WMB marking card; white; 10 strips with 10 markers/card; for 3.5 mm terminal block width

plain	793-3501	5
-------	----------	---



Marking strip; plain; 11 mm wide; 50 m reel

white	2009-110	1
-------	----------	---



Technical Data

0.14 ... 1 (1.5) mm² ❶ | 24 ... 16 AWG

500 V/6 kV/3 ❷ | 300 V, 10 A ❸

I_N 13.5 A ❸ | 300 V, 10 A ❸

Module width: 3.5 mm / 0.138 inch

9 ... 11 mm / 0.35 ... 0.43 inch

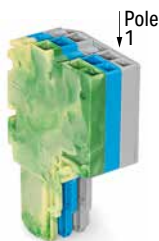

2-conductor female plug; with ground end module (green-yellow); fits into carrier terminal blocks; codable

Pole No.	Item No.	Pack. Unit
3	2020-203/000-039	50
4	2020-204/000-039	50
5	2020-205/000-039	50
6	2020-206/000-039	50
7	2020-207/000-039	25
8	2020-208/000-039	25
9	2020-209/000-039	25
10	2020-210/000-039	25
11	2020-211/000-039	20
12	2020-212/000-039	20
13	2020-213/000-039	10
14	2020-214/000-039	10
15	2020-215/000-039	10

❶ Conductor range: 0.14 ... 1.5 mm² "s+f-st"; Push-in termination: 0.5 ... 1.5 mm² "s" and 0.5 ... 0.75 mm² "insulated ferrules; 12 mm" Depending on the conductor characteristic, a conductor with a smaller cross section can also be inserted via push-in termination.

❷ 500 V = rated voltage
6 kV = rated impulse voltage
3 = pollution degree
(see Section 14)

❸ Current-carrying capacity curves upon request

Note:

According to EN 61984, pluggable connectors without a current interrupting capacity must not be mated or unmated when live or under load.

Notice: An appropriate end plate must be applied to the carrier terminal blocks after each female plug.

Approvals and corresponding ratings, visit www.wago.com

1-Conductor Female Plug X-COM®S-SYSTEM-MINI; with Lateral Locking Lever and Strain Relief Plate

1 (1.5) mm²; 2020 Series

Technical Data	
0.14 ... 1 (1.5) mm ² ❶	24 ... 16 AWG
500 V/6 kV/3 ❷	300 V, 10 A ❸
I _N 13.5 A ❸	300 V, 10 A ❸
Module width: 3.5 mm / 0.138 inch	
9 ... 11 mm / 0.35 ... 0.43 inch	

Technical Data	
0.14 ... 1 (1.5) mm ² ❶	24 ... 16 AWG
500 V/6 kV/3 ❷	300 V, 10 A ❸
I _N 13.5 A ❸	300 V, 10 A ❸
Module width: 3.5 mm / 0.138 inch	
9 ... 11 mm / 0.35 ... 0.43 inch	

Technical Data	
0.14 ... 1 (1.5) mm ² ❶	24 ... 16 AWG
500 V/6 kV/3 ❷	300 V, 10 A ❸
I _N 13.5 A ❸	300 V, 10 A ❸
Module width: 3.5 mm / 0.138 inch	
9 ... 11 mm / 0.35 ... 0.43 inch	

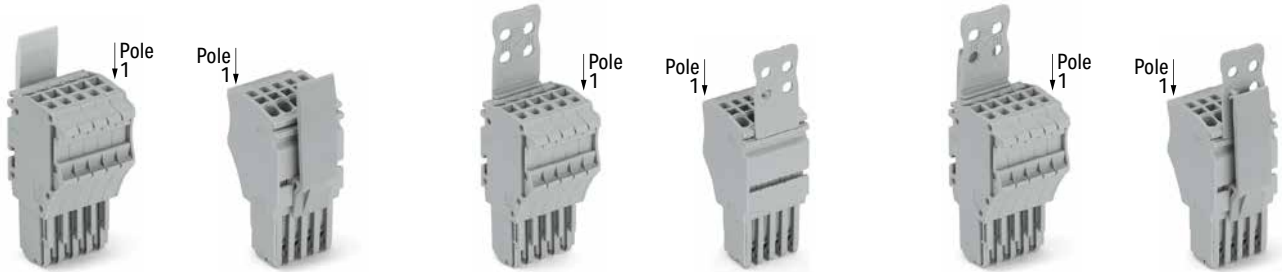

1-conductor female plug; with locking lever; fits into carrier terminal blocks; codable; gray

Pole No.	Item No.	Pack. Unit
○ 2	2020-102/122-000	100
○ 3	2020-103/122-000	50
○ 4	2020-104/124-000	50
○ 5	2020-105/124-000	50
○ 6	2020-106/124-000	25
○ 7	2020-107/124-000	25
○ 8	2020-108/124-000	25
○ 9	2020-109/124-000	25
○ 10	2020-110/125-000	25
○ 11	2020-111/125-000	20
○ 12	2020-112/125-000	20
○ 13	2020-113/125-000	10
○ 14	2020-114/125-000	10
○ 15	2020-115/125-000	10

1-conductor female plug; with strain relief plate; fits into carrier terminal blocks; codable; gray

Pole No.	Item No.	Pack. Unit
○ 2	2020-102/132-000	100
○ 3	2020-103/132-000	50
○ 4	2020-104/133-000	50
○ 5	2020-105/133-000	50
○ 6	2020-106/133-000	25
○ 7	2020-107/134-000	25
○ 8	2020-108/134-000	25
○ 9	2020-109/134-000	25
○ 10	2020-110/135-000	25
○ 11	2020-111/135-000	20
○ 12	2020-112/135-000	20
○ 13	2020-113/135-000	10
○ 14	2020-114/135-000	10
○ 15	2020-115/135-000	10

1-conductor female plug; with strain relief plate and locking lever; fits into carrier terminal blocks; codable; gray

Pole No.	Item No.	Pack. Unit
○ 2	2020-102/142-000	100
○ 3	2020-103/142-000	50
○ 4	2020-104/143-000	50
○ 5	2020-105/143-000	50
○ 6	2020-106/143-000	25
○ 7	2020-107/144-000	25
○ 8	2020-108/144-000	25
○ 9	2020-109/144-000	25
○ 10	2020-110/145-000	25
○ 11	2020-111/145-000	20
○ 12	2020-112/145-000	20
○ 13	2020-113/145-000	10
○ 14	2020-114/145-000	10
○ 15	2020-115/145-000	10

Accessories; for female plugs

Appropriate marking systems: WMB/WMB Inline/Marking strips

Protective warning marker; with black high-voltage symbol; for 5 terminal blocks

yellow	2000-115	100 (25)
--------	----------	----------



Carrier with 6 coding pins; for coding female plugs

orange	2020-100	100 (25)
--------	----------	----------



WMB Inline; plain; 2,300 WMB markers (3.5 mm)/reel

white	2009-113	1
-------	----------	---



Marking strip; plain; 11 mm wide; 50 m reel

white	2009-110	1
-------	----------	---



WMB marking card; white; 10 strips with 10 markers/card; for 3.5 mm terminal block width

plain	793-3501	5
-------	----------	---



❶ Conductor range: 0.14 ... 1.5 mm² "s+f-st";
 Push-in termination: 0.5 ... 1.5 mm² "s" and
 0.5 ... 0.75 mm² "insulated ferrules; 12 mm"
 Depending on the conductor characteristic, a conductor with a smaller cross section can also be inserted via push-in termination.

❷ 500 V = rated voltage
 6 kV = rated impulse voltage
 3 = pollution degree
 (see Section 14)

❸ Current-carrying capacity curves upon request

Note:
 According to EN 61984, pluggable connectors without a current interrupting capacity must not be mated or unmated when live or under load.
 Notice: An appropriate end plate must be applied to the carrier terminal blocks after each female plug.

Approvals and corresponding ratings, visit www.wago.com

Strain Relief Plate (SRP), Gray				Locking Lever (LL), Gray				SRP and LL, Gray
Assembled				Assembled				Assembled
SRP				Pole No.	Quantity	1-Way	2-Way	
Item No. Suffix				Item No. Suffix				Item No. Suffix
Item No.	Color	Width						
734-327	gray	6mm	/132-0xx	2 to 3	1	/122-0xx	-	/142-0xx
734-328	gray	12.5mm	/133-0xx	4 to 6	1	-	/124-0xx	/143-0xx
734-329	gray	25mm	/134-0xx	7 to 9	1	-	/124-0xx	/144-0xx
734-326	gray	35mm	/135-0xx	10 to 15	2	-	/125-0xx	/145-0xx

For colored female plugs, the item number suffix "xx" must be replaced by the blue "-006" and the green-yellow "-016" color suffix.

Dimensions of locking levers

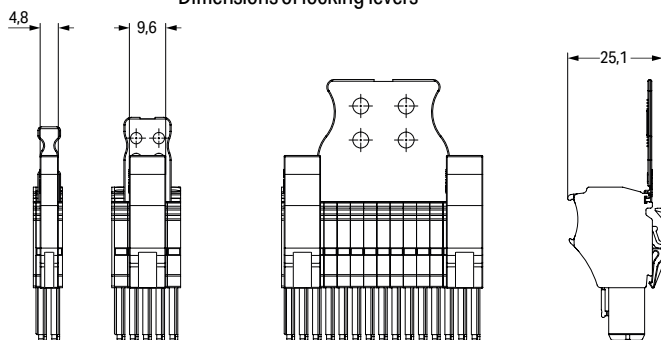

Description	Color	Item No.	Suffix No.
1-conductor female plug	gray	2020-102	none
2- to 15-pole	blue green-yellow	to 2020-115	/000-006 /000-016

Dimensions of strain relief plates

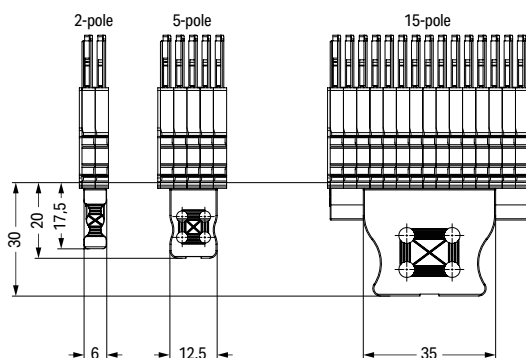

2-Conductor Female Plug X-COM®S-SYSTEM-MINI; with Lateral Locking Lever and Strain Relief Plate

1 (1.5) mm²; 2020 Series

Technical Data	
0.14 ... 1 (1.5) mm ² ❶	24 ... 16 AWG
500 V/6 kV/3 ❷	300 V, 10 A ❸
I _N 13.5 A ❸	300 V, 10 A ❸
Module width: 3.5 mm / 0.138 inch	
9 ... 11 mm / 0.35 ... 0.43 inch	

Technical Data	
0.14 ... 1 (1.5) mm ² ❶	24 ... 16 AWG
500 V/6 kV/3 ❷	300 V, 10 A ❸
I _N 13.5 A ❸	300 V, 10 A ❸
Module width: 3.5 mm / 0.138 inch	
9 ... 11 mm / 0.35 ... 0.43 inch	

Technical Data	
0.14 ... 1 (1.5) mm ² ❶	24 ... 16 AWG
500 V/6 kV/3 ❷	300 V, 10 A ❸
I _N 13.5 A ❸	300 V, 10 A ❸
Module width: 3.5 mm / 0.138 inch	
9 ... 11 mm / 0.35 ... 0.43 inch	

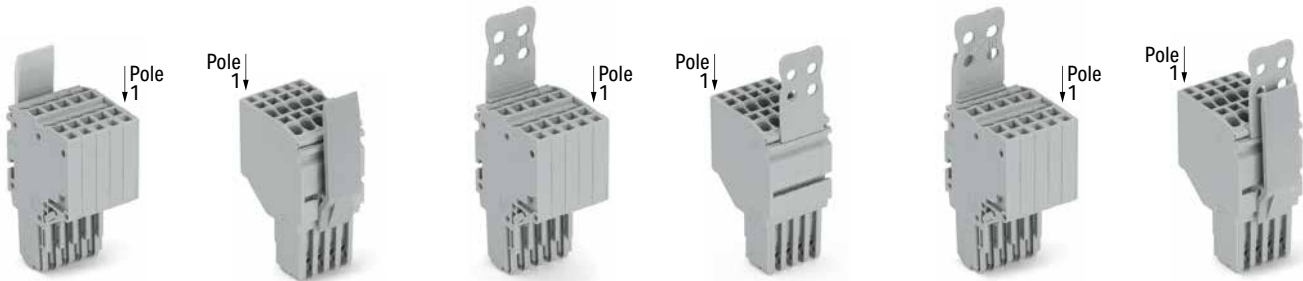

2-conductor female plug; with locking lever; fits into carrier terminal blocks; codable; gray

Pole No.	Item No.	Pack. Unit
○ 2	2020-202/122-000	100
○ 3	2020-203/122-000	50
○ 4	2020-204/124-000	50
○ 5	2020-205/124-000	50
○ 6	2020-206/124-000	25
○ 7	2020-207/124-000	25
○ 8	2020-208/124-000	25
○ 9	2020-209/124-000	25
○ 10	2020-210/125-000	25
○ 11	2020-211/125-000	20
○ 12	2020-212/125-000	20
○ 13	2020-213/125-000	10
○ 14	2020-214/125-000	10
○ 15	2020-215/125-000	10

2-conductor female plug; with strain relief plate; fits into carrier terminal blocks; codable; gray

Pole No.	Item No.	Pack. Unit
○ 2	2020-202/132-000	100
○ 3	2020-203/132-000	50
○ 4	2020-204/133-000	50
○ 5	2020-205/133-000	50
○ 6	2020-206/133-000	25
○ 7	2020-207/134-000	25
○ 8	2020-208/134-000	25
○ 9	2020-209/134-000	25
○ 10	2020-210/135-000	25
○ 11	2020-211/135-000	20
○ 12	2020-212/135-000	20
○ 13	2020-213/135-000	10
○ 14	2020-214/135-000	10
○ 15	2020-215/135-000	10

2-conductor female plug; with strain relief plate and locking lever; fits into carrier terminal blocks; codable; gray

Pole No.	Item No.	Pack. Unit
○ 2	2020-202/142-000	100
○ 3	2020-203/142-000	50
○ 4	2020-204/143-000	50
○ 5	2020-205/143-000	50
○ 6	2020-206/143-000	25
○ 7	2020-207/144-000	25
○ 8	2020-208/144-000	25
○ 9	2020-209/144-000	25
○ 10	2020-210/145-000	25
○ 11	2020-211/145-000	20
○ 12	2020-212/145-000	20
○ 13	2020-213/145-000	10
○ 14	2020-214/145-000	10
○ 15	2020-215/145-000	10

Accessories; for female plugs

Appropriate marking systems: WMB/WMB Inline/Marking strips

Protective warning marker; with black high-voltage symbol; for 5 terminal blocks

yellow	2000-115	100 (25)
--------	----------	----------



Carrier with 6 coding pins; for coding female plugs

orange	2020-100	100 (25)
--------	----------	----------



WMB Inline; plain; 2,300 WMB markers (3.5 mm)/reel

white	2009-113	1
-------	----------	---



Marking strip; plain; 11 mm wide; 50 m reel

white	2009-110	1
-------	----------	---



WMB marking card; white; 10 strips with 10 markers/card; for 3.5 mm terminal block width

plain	793-3501	5
-------	----------	---



❶ Conductor range: 0.14 ... 1.5 mm² "s+f-st";
 Push-in termination: 0.5 ... 1.5 mm² "s" and
 0.5 ... 0.75 mm² "insulated ferrules; 12 mm"
 Depending on the conductor characteristic, a conductor with a smaller cross section can also be inserted via push-in termination.

❷ 500 V = rated voltage
 6 kV = rated impulse voltage
 3 = pollution degree
 (see Section 14)

❸ Current-carrying capacity curves upon request

Note:
 According to EN 61984, pluggable connectors without a current interrupting capacity must not be mated or unmated when live or under load.
 Notice: An appropriate end plate must be applied to the carrier terminal blocks after each female plug.

Approvals and corresponding ratings, visit www.wago.com

Strain Relief Plate (SRP), Gray				Locking Lever (LL), Gray				SRP and LL, Gray
Assembled				Assembled				Assembled
SRP				Pole No.	Quantity	1-Way	2-Way	
Item No. Suffix				Item No. Suffix				Item No. Suffix
Item No.	Color	Width						
734-327	gray	6mm	/132-0xx	2 to 3	1	/122-0xx	-	/142-0xx
734-328	gray	12.5mm	/133-0xx	4 to 6	1	-	/124-0xx	/143-0xx
734-329	gray	25mm	/134-0xx	7 to 9	1	-	/124-0xx	/144-0xx
734-326	gray	35mm	/135-0xx	10 to 15	2	-	/125-0xx	/145-0xx

For colored female plugs, the item number suffix "xx" must be replaced by the blue "-006" and the green-yellow "-016" color suffix.

Dimensions of locking levers

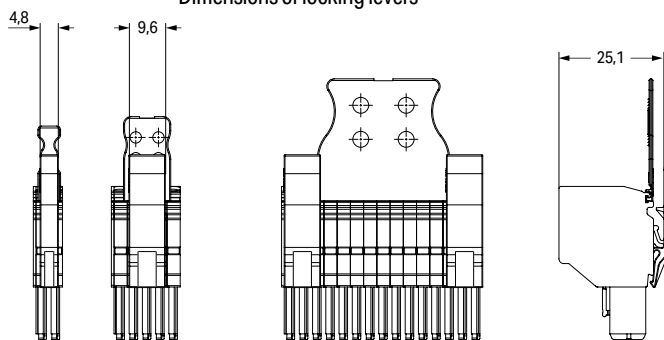

Description	Color	Item No.	Suffix No.
2-conductor female plug	gray	2020-202	none
2- to 15-pole	blue	to	/000-006
	green-yellow	2020-215	/000-016

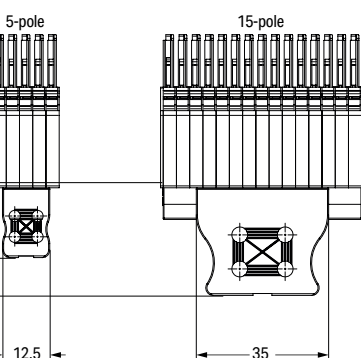

Dimensions of strain relief plates

1-Conductor/1-Pin, 2-Conductor/1-Pin and 2-Conductor/2-Pin Carrier Terminal Block X-COM®S-SYSTEM 2.5 (4) mm²; 2022 Series

Technical Data	
0.25 ... 2.5 (4) mm ² ①	22 ... 12 AWG
690 V/6 kV/3 ②	600 V, 20 A ③
I _N 24 A (32 A) ③	600 V, 20 A ④
Terminal block width: 5.2 mm / 0.205 inch	
10 ... 12 mm / 0.39 ... 0.47 inch	

Technical Data	
0.25 ... 2.5 (4) mm ² ①	22 ... 12 AWG
690 V/6 kV/3 ②	600 V, 20 A ③
I _N 24 A (32 A) ③	600 V, 20 A ④
Terminal block width: 5.2 mm / 0.205 inch	
10 ... 12 mm / 0.39 ... 0.47 inch	

Technical Data	
0.25 ... 2.5 (4) mm ² ①	22 ... 12 AWG
690 V/6 kV/3 ②	600 V, 20 A ③
I _N 24 A (28 A) ③	600 V, 20 A ④
Terminal block width: 5.2 mm / 0.205 inch	
10 ... 12 mm / 0.39 ... 0.47 inch	

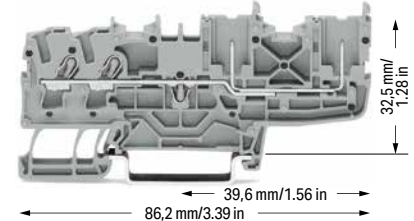
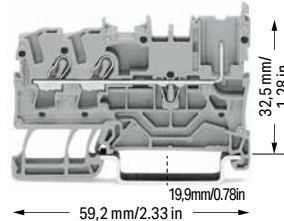
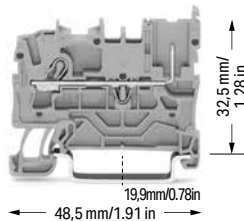

1-conductor/1-pin carrier terminal block		
Color	Item No.	Pack. Unit
gray	2022-1201	100
blue	2022-1204	100
orange	2022-1202	100

2-conductor/1-pin carrier terminal block		
Color	Item No.	Pack. Unit
gray	2022-1301	100
blue	2022-1304	100
orange	2022-1302	100

2-conductor/2-pin carrier terminal block		
Color	Item No.	Pack. Unit
gray	2022-1401	50
blue	2022-1404	50
orange	2022-1402	50

1-conductor/1-pin ground carrier terminal block		
green-yellow	2022-1207	100

2-conductor/1-pin ground carrier terminal block		
green-yellow	2022-1307	100

2-conductor/2-pin ground carrier terminal block		
green-yellow	2022-1407	50

Accessories; item-specific			
End and intermediate plate; 1 mm thick			
orange	2022-1292	100 (25)	
gray	2022-1291	100 (25)	

Accessories; item-specific			
End and intermediate plate; 1 mm thick			
orange	2022-1392	100 (25)	
gray	2022-1391	100 (25)	

Accessories; item-specific			
End and intermediate plate; 1 mm thick			
orange	2022-1492	100 (25)	
gray	2022-1491	100 (25)	

Accessories; 2022 Series

Appropriate marking systems: WMB/WMB Inline/Marking strips

Insulation stop; 5 pcs/strip; 0.25 ... 0.5 mm ²			
light gray	2002-171	200 (25)	

Delta jumper; insulated; I _N = I _N terminal block; light gray			
1-2 3-4 5-6	2002-406/020-000	25	

Adjacent jumper for continuous commoning; insulated; I _N 25 A, light gray			
5-way	2002-415	25	

Insulation stop; 5 pcs/strip; 0.75 ... 1 mm ²			
dark gray	2002-172	200 (25)	

Star point jumper; insulated; I _N = I _N terminal block; light gray			
1-3-5	2002-405/011-000	25	

Push-in type wire jumper; insulated; 1.5 mm ² conductor cross-section; I _N 18 A			
L = 60 mm	2009-412	100 (10)	
L = 110 mm	2009-414	100 (10)	
L = 250 mm	2009-416	100 (10)	

Protective warning marker; with black high-voltage symbol; for 5 terminal blocks			
yellow	2002-115	100 (25)	

Staggered jumper; insulated; I _N 25 A; light gray			
2-way	2002-472	25	
3-way	2002-473	25	
4-way	2002-474	25	
5-way	2002-475	25	
6-way	2002-476	25	
7-way	2002-477	25	
8-way	2002-478	25	
9-way	2002-479	25	
10-way	2002-480	25	
11-way	2002-481	25	
12-way	2002-482	25	

Carrier with 6 coding pins; for coding female plugs			
orange	2022-100	100 (25)	

Push-in type jumper bar; insulated; I _N 25 A; light gray			
2-way	2002-402	25	
3-way	2002-403	25	
4-way	2002-404	25	
5-way	2002-405	25	
6-way	2002-406	25	
7-way	2002-407	25	
8-way	2002-408	25	
9-way	2002-409	25	
10-way	2002-410	25	

Adjacent jumper for continuous commoning; insulated; I _N 25 A, light gray			
2-way	2002-400	25	

Test pin; 1 mm Ø			
	859-500	1	

Push-in type jumper bar; insulated; I _N 25 A; light gray			
1 to 3	2002-433	25	
1 to 4	2002-434	25	
1 to 5	2002-435	25	
1 to 6	2002-436	25	
1 to 7	2002-437	25	
1 to 8	2002-438	25	
1 to 9	2002-439	25	
1 to 10	2002-440	25	

Adjacent jumper for continuous commoning; insulated; I _N 25 A; 1 to 3			
light gray	2002-423	25	
red	2002-423/000-005	25	
blue	2002-423/000-006	25	

1-conductor female plug			
gray	2022-101	200	

❶ Conductor range: 0.25 ... 4 mm² "s+f-st";
Push-in termination: 1 ... 4 mm² "s" and 1 ... 2.5 mm²
"insulated ferrules, 12 mm"
Depending on the conductor characteristic, a conductor with a smaller cross section can also be inserted via push-in termination.

❷ 690 V = rated voltage
6 kV = rated impulse voltage
3 = pollution degree
(see Section 14)

❸ Current-carrying capacity curves upon request

Note:

When used as intended, female plugs must not be connected/disconnected when live or under load.

Please observe the application notes:
Jumpers, from page 152
Marking, from page 588

Approvals and corresponding ratings,
visit www.wago.com



2022 Series X-COM®S-SYSTEM Carrier Terminal Blocks combined with 2022 Series Through Terminal Blocks

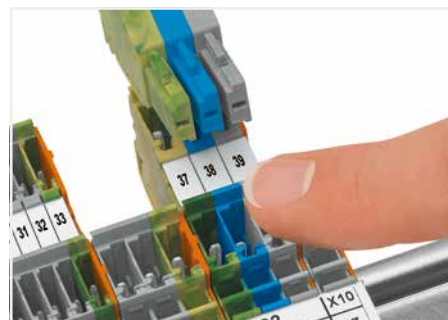

Carrier terminal blocks and female plugs are touch-proof.

Accessories; 2022 Series

Appropriate marking systems:
WMB/WMB Inline/Marking strips

WMB Inline, plain; 1,500 WMB markers (5 mm)/reel;
5 ... 5.2 mm stretchable

white	2009-115	1
-------	----------	---

Marking strip; plain; 11 mm wide; 50 m reel

white	2009-110	1
-------	----------	---

WMB marking card; white; 10 strips with 10 markers/card;
5 ... 5.2 mm stretchable

plain	793-5501	5
-------	----------	---

WMB marking card; plain; 10 strips with 10 markers/card;
5 ... 5.2 mm stretchable

yellow	793-5501/000-002	5
red	793-5501/000-005	5
blue	793-5501/000-006	5
gray	793-5501/000-007	5
orange	793-5501/000-012	5
light green	793-5501/000-017	5
green	793-5501/000-023	5
violet	793-5501/000-024	5

Screwless end stop; for DIN-35 rail; 6 mm wide

gray	249-116	100 (25)
------	---------	----------

Screwless end stop; for DIN-35 rail; 10 mm wide

gray	249-117	50 (25)
------	---------	---------

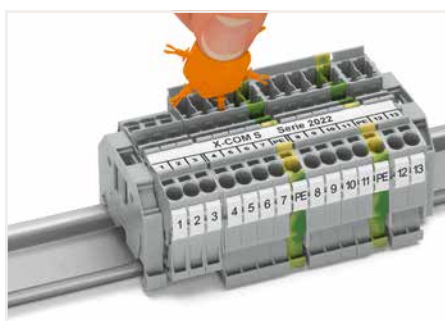

Insert coding pin into the corresponding slot and twist it off.



1-Conductor/1-Pin Double-Deck Carrier Terminal Block X-COM®S-SYSTEM

2.5 (4) mm²; 2022 Series

Technical Data	
0.25 ... 2.5 (4) mm ² ①	22 ... 12 AWG
690 V/6 kV/3 ②	600 V, 20 A ③
I _N 24 A (28 A) ③	600 V, 20 A ④
Terminal block width: 5.2 mm / 0.205 inch	
10 ... 12 mm / 0.39 ... 0.47 inch	

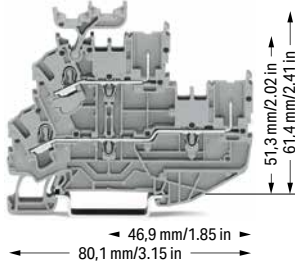

1-conductor/1-pin double-deck carrier terminal block; through/through terminal block; with marker carrier; gray housing

	Item No.	Pack. Unit
<input type="radio"/> L/L	2022-2231	50
<input type="radio"/> N/L	2022-2232	50
<input type="radio"/> L/N	2022-2233	50

Technical Data	
0.25 ... 2.5 (4) mm ² ①	22 ... 12 AWG
690 V/6 kV/3 ②	600 V, 20 A ③
I _N 24 A (28 A) ③	600 V, 20 A ④
Terminal block width: 5.2 mm / 0.205 inch	
10 ... 12 mm / 0.39 ... 0.47 inch	

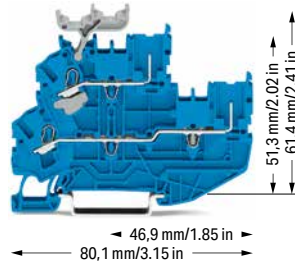

1-conductor/1-pin double-deck carrier terminal block; through/through terminal block; with marker carrier; blue housing

	Item No.	Pack. Unit
<input checked="" type="radio"/> N/N	2022-2234	50

Technical Data	
0.25 ... 2.5 (4) mm ² ①	22 ... 12 AWG
690 V/6 kV/3 ②	600 V, 20 A ③
I _N 24 A (28 A) ③	600 V, 20 A ④
Terminal block width: 5.2 mm / 0.205 inch	
10 ... 12 mm / 0.39 ... 0.47 inch	

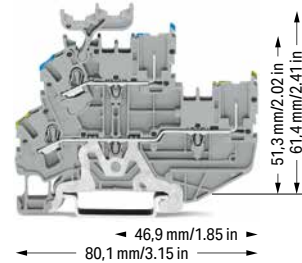

1-conductor/1-pin double-deck carrier terminal block; ground conductor/through terminal block; with marker carrier; gray housing

	Item No.	Pack. Unit
<input type="radio"/> PE/N	2022-2247	50
<input type="radio"/> PE/L	2022-2257	50

1-conductor/1-pin double-deck carrier terminal block; through/through terminal block; without marker carrier; gray housing

	Item No.	Pack. Unit
<input type="radio"/> L/L	2022-2201	50
<input type="radio"/> N/L	2022-2202	50
<input type="radio"/> L/N	2022-2203	50

1-conductor/1-pin double-deck carrier terminal block; through/through terminal block; without marker carrier; blue housing

	Item No.	Pack. Unit
<input checked="" type="radio"/> N/N	2022-2204	50

1-conductor/1-pin double-deck carrier terminal block; ground conductor/through terminal block; without marker carrier; gray housing

	Item No.	Pack. Unit
<input type="radio"/> PE/N	2022-2217	50
<input type="radio"/> PE/L	2022-2227	50

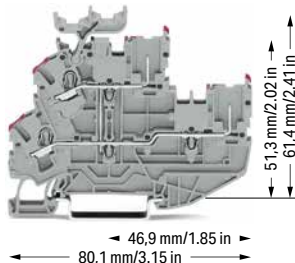

2-conductor/2-pin double-deck carrier terminal block; 2-conductor/2-pin through terminal block; with marker carrier, internally commoned; violet conductor entry; gray housing

	Item No.	Pack. Unit
<input type="radio"/> L	2022-2238	50

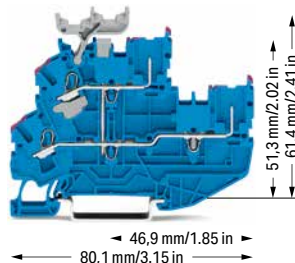

2-conductor/2-pin double-deck carrier terminal block; 2-conductor/2-pin through terminal block; with marker carrier, internally commoned; violet conductor entry; blue housing

	Item No.	Pack. Unit
<input checked="" type="radio"/> N	2022-2239	50

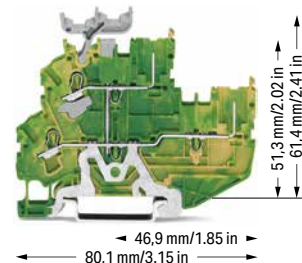

2-conductor/2-pin double-deck carrier block; 2-conductor/2-pin ground conductor block; with marker carrier, internally commoned; green-yellow housing

	Item No.	Pack. Unit
<input checked="" type="radio"/> PE	2022-2237	50

2-conductor/2-pin double-deck carrier terminal block; 2-conductor/2-pin through terminal block; without marker carrier, internally commoned; violet conductor entry; gray housing

	Item No.	Pack. Unit
<input type="radio"/> L	2022-2208	50

2-conductor/2-pin double-deck carrier terminal block; 2-conductor/2-pin through terminal block; without marker carrier, internally commoned; violet conductor entry; blue housing

	Item No.	Pack. Unit
<input checked="" type="radio"/> N	2022-2209	50

2-conductor/2-pin double-deck carrier block; 2-conductor/2-pin ground conductor block; without marker carrier, internally commoned; green-yellow housing

	Item No.	Pack. Unit
<input checked="" type="radio"/> PE	2022-2207	50

❶ Conductor range: 0.25 ... 4 mm² "s+f-st";
Push-in termination: 1 ... 4 mm² "s" and 1 ... 2.5 mm²
"insulated ferrules, 12 mm"
Depending on the conductor characteristic, a conductor with a smaller cross section can also be inserted via push-in termination.

❷ 690 V = rated voltage
6 kV = rated impulse voltage
3 = pollution degree
(see Section 14)

❸ Current-carrying capacity curves upon request

Note:

When used as intended, female plugs must not be connected/disconnected when live or under load.

Please observe the application notes:
Jumpers, from page 152
Marking, from page 588

Approvals and corresponding ratings,
visit www.wago.com

Accessories; 2022 Series

Appropriate marking systems:
WMB/WMB Inline/Marking strips

End and intermediate plate; 1 mm thick

	orange	2022-2292	100 (25)
	gray	2022-2291	100 (25)

Insulation stop; 5 pcs/strip; 0.25 ... 0.5 mm²

	light gray	2002-171	200 (25)
---	------------	----------	----------

Insulation stop; 5 pcs/strip; 0.75 ... 1 mm²

	dark gray	2002-172	200 (25)
---	-----------	----------	----------

Protective warning marker; with black high-voltage symbol; for 5 terminal blocks

	yellow	2002-115	100 (25)
---	--------	----------	----------

Push-in type jumper bar; insulated; I_N 25 A; light gray

	2-way	2002-402	25
	3-way	2002-403	25
	4-way	2002-404	25
	5-way	2002-405	25
	6-way	2002-406	25
	7-way	2002-407	25
	8-way	2002-408	25
	9-way	2002-409	25
	10-way	2002-410	25

Push-in type jumper bar; insulated; I_N 25 A; light gray

	1 to 3	2002-433	25
	1 to 4	2002-434	25
	1 to 5	2002-435	25
	1 to 6	2002-436	25
	1 to 7	2002-437	25
	1 to 8	2002-438	25
	1 to 9	2002-439	25
	1 to 10	2002-440	25

Double-deck vertical jumper; insulated; I_N 24 A

	light gray	2002-492	100 (25)
	orange	2002-492/000-012	100 (25)

Accessories; 2022 Series

Appropriate marking systems:
WMB/WMB Inline/Marking strips

Adjacent jumper for continuous commoning; insulated; I_N 25 A, light gray

	2-way	2002-400	25
---	-------	----------	----

Adjacent jumper for continuous commoning; insulated; I_N 25 A; 1 to 3

	light gray	2002-423	25
	red	2002-423/000-005	25
	blue	2002-423/000-006	25

Adjacent jumper for continuous commoning; insulated; I_N 25 A, light gray

	5-way	2002-415	25
---	-------	----------	----

Carrier with 6 coding pins; for coding female plugs

	orange	2022-100	100 (25)
---	--------	----------	----------

Test pin; 1 mm Ø

		859-500	1
---	--	---------	---

1-conductor female plug

	gray	2022-101	200
---	------	----------	-----

WMB Inline, plain; 1,500 WMB markers (5 mm)/reel; 5 ... 5.2 mm stretchable

	white	2009-115	1
---	-------	----------	---

Marking strip; plain; 11 mm wide; 50 m reel

	white	2009-110	1
---	-------	----------	---

WMB marking card; white; 10 strips with 10 markers/card; 5 ... 5.2 mm stretchable

	plain	793-5501	5
---	-------	----------	---

WMB marking card; plain; 10 strips with 10 markers/card; 5 ... 5.2 mm stretchable

	yellow	793-5501/000-002	5
	red	793-5501/000-005	5
	blue	793-5501/000-006	5
	gray	793-5501/000-007	5
	orange	793-5501/000-012	5
	light green	793-5501/000-017	5
	green	793-5501/000-023	5
	violet	793-5501/000-024	5

Double-deck marker carrier; pivoting

	gray	2002-121	50 (25)
---	------	----------	---------

Screwless end stop; for DIN-35 rail; 6 mm wide

	gray	249-116	100 (25)
---	------	---------	----------



Size comparison:
Double-deck carrier terminal blocks with 3.5 mm and 5.2 mm terminal block widths

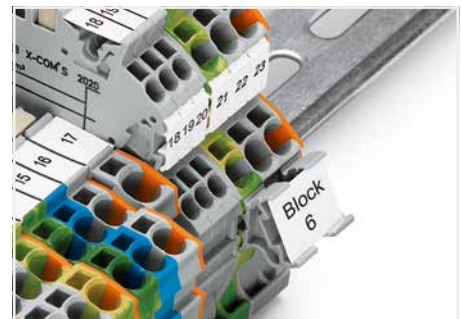

Marker carrier (2009-198)

1-Conductor Female Plug X-COM®S-SYSTEM

2.5 (4) mm²; 2022 Series

Technical Data	
0.25 ... 2.5 (4) mm ² ①	22 ... 12 AWG
690 V/6 kV/3 ②	600 V, 20 A ③
I _N 24 A (32 A) ③	600 V, 20 A ③
Module width: 5.2 mm / 0.205 inch	
10 ... 12 mm / 0.39 ... 0.47 inch	



Dimensions (in mm):

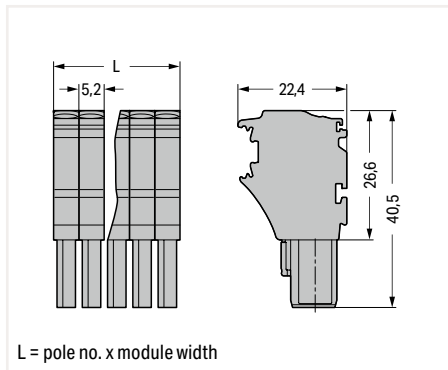

1-conductor female plug; fits into carrier terminal blocks; codable; gray
According to EN 61984, pluggable connectors without a current interrupting capacity must not be mated or unmated when live or under load.

Pole No.	Item No.	Pack. Unit
1	2022-101	200
2	2022-102	200
3	2022-103	100
4	2022-104	100
5	2022-105	50
6	2022-106	50
7	2022-107	50
8	2022-108	50
9	2022-109	50
10	2022-110	25
11	2022-111	25
12	2022-112	25
13	2022-113	25
14	2022-114	25
15	2022-115	25

1-conductor female plug; fits into carrier terminal blocks; codable; green-yellow
According to EN 61984, pluggable connectors without a current interrupting capacity must not be mated or unmated when live or under load.

1	2022-101/000-016	200
2	2022-102/000-016	200

① Conductor range: 0.25 ... 4 mm² "s+f-st"; Push-in termination: 1 ... 4 mm² "s" and 1 ... 2.5 mm² "insulated ferrules, 12 mm"
Depending on the conductor characteristic, a conductor with a smaller cross section can also be inserted via push-in termination.

② 690 V = rated voltage
6 kV = rated impulse voltage
3 = pollution degree (see Section 14)

③ Current-carrying capacity curves upon request

Item no. suffixes
blue .../000-006
orange .../000-012

Approvals and corresponding ratings, visit www.wago.com

Accessories; for female plugs

Appropriate marking systems:
WMB/WMB Inline/Marking strips

Insulation stop; 5 pcs/strip; 0.25 ... 0.5 mm²
light gray 2002-171 200 (25)

Insulation stop; 5 pcs/strip; 0.75 ... 1 mm²
dark gray 2002-172 200 (25)

Protective warning marker; with black high-voltage symbol; for 5 terminal blocks
yellow 2002-115 100 (25)

Locking lever; 4.8 mm wide
orange 2022-142 100 (25)
gray 2022-141 100 (25)

Locking lever; 9.6 mm wide
orange 2022-152 100 (25)
gray 2022-151 100 (25)

Carrier with 6 coding pins; for coding female plugs
orange 2022-100 100 (25)

Strain relief plate; gray
35 mm wide 734-326 100 (25)
6 mm wide 734-327 100 (25)
12.5 mm wide 734-328 100 (25)
25 mm wide 734-329 100 (25)
55 mm wide 734-430 50 (25)
75 mm wide 734-431 50 (25)

WMB Inline, plain; 1,500 WMB markers (5 mm)/reel; 5 ... 5.2 mm stretchable
white 2009-115 1

Marking strip; plain; 11 mm wide; 50 m reel
white 2009-110 1

WMB marking card; white; 10 strips with 10 markers/card; 5 ... 5.2 mm stretchable
plain 793-5501 5



Coding a female plug: remove coding finger using a suitable tool.

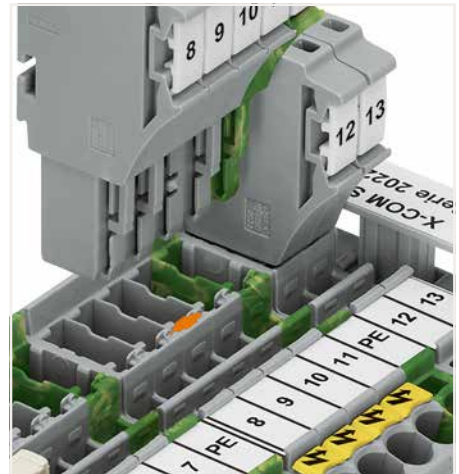

Insert a coding pin (2022-100) into the corresponding location of the carrier terminal block.

Carrier Terminal Blocks and 1-Conductor Female Plugs X-COM®S-SYSTEM

Types of Assembly

2



1-conductor female plug
Carrier terminal blocks can be commoned via 2000 Series Push-In Type Jumper Bars and tested via 859-500 Test Pin.

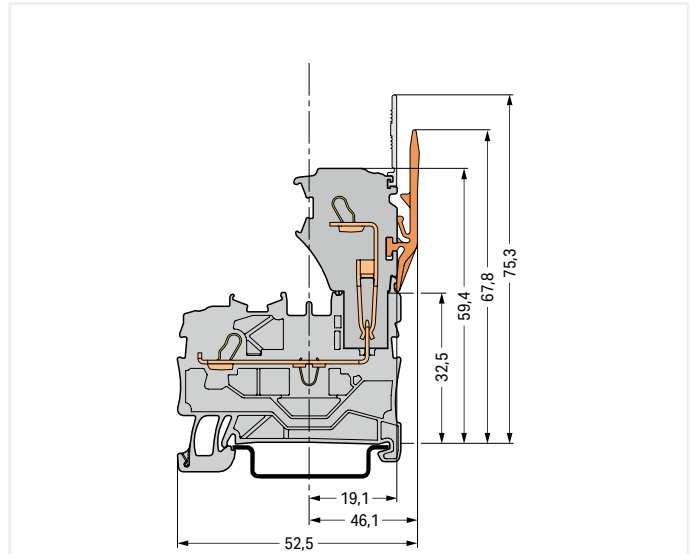

Carrier terminal block

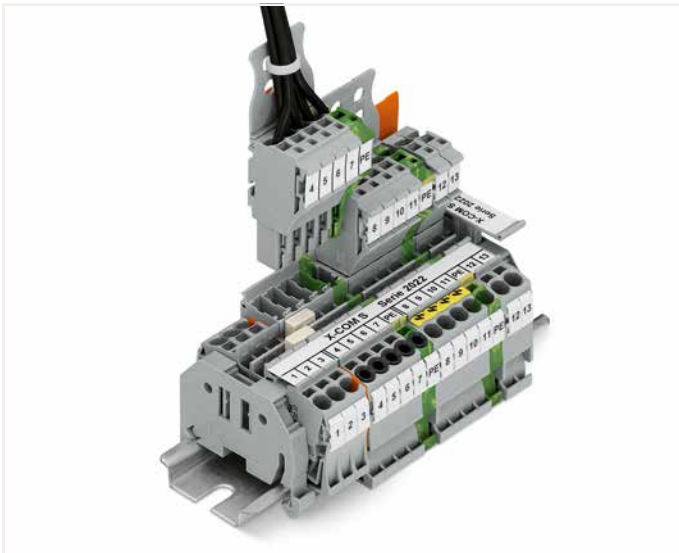

X-COM®S-SYSTEM terminal block assembly

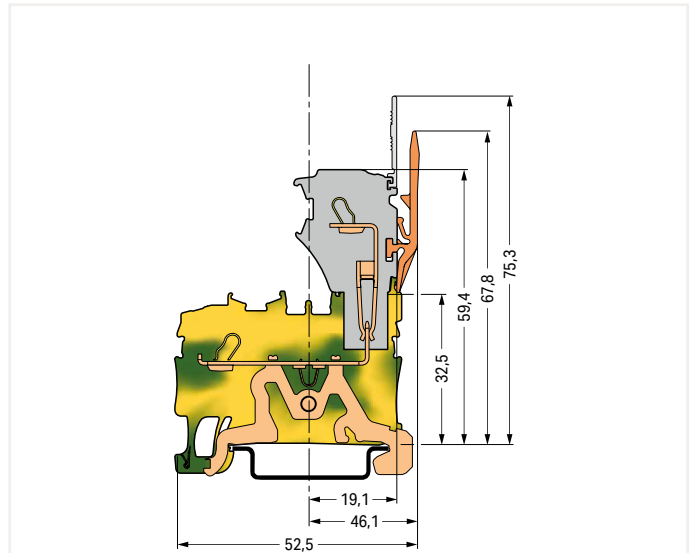

Ground carrier terminal block

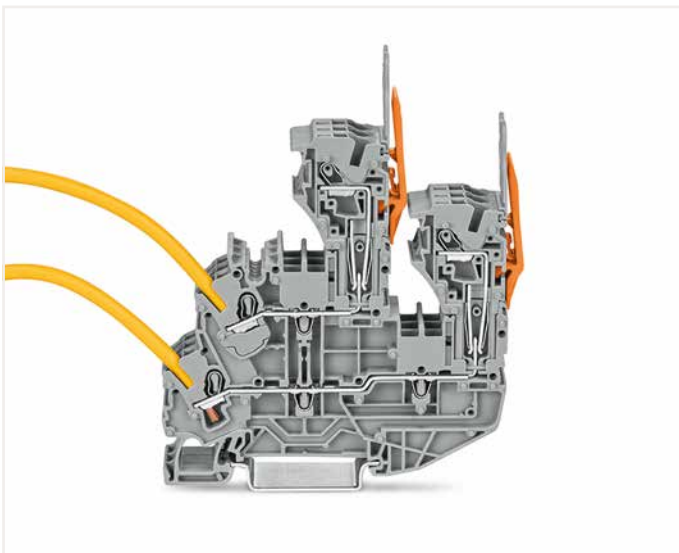

1-conductor female plug
Double-deck carrier terminal blocks can be commoned via 2000 Series Push-In Type Jumper Bars and tested via 859-500 Test Pin.

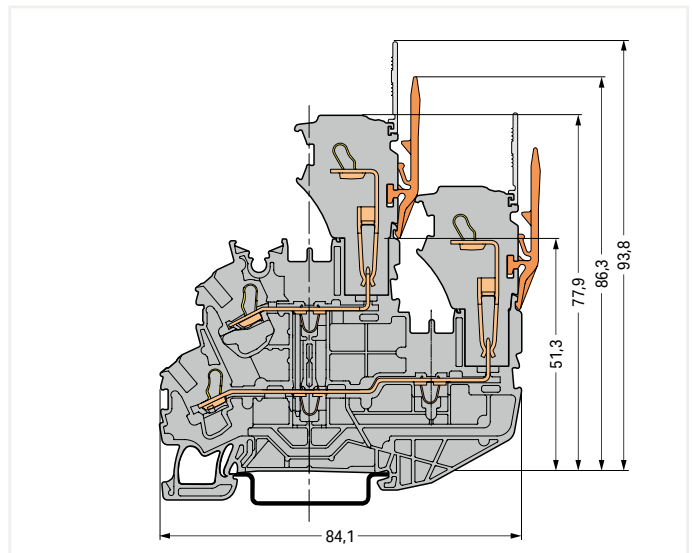

Double-deck carrier terminal block

Female Plug for Self-Assembly X-COM®S-SYSTEM



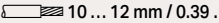

2.5 (4) mm²; 2022 Series

Technical Data

0.25 ... 2.5 (4) mm ² ❶	22 ... 12 AWG
690 V/6 kV/3 ❷	600 V, 20 A ❸
I _N 24 A (32 A) ❸	600 V, 20 A ❸
Terminal block width: 5.2 mm / 0.205 inch	
 10 ... 12 mm / 0.39 ... 0.47 inch	



1-conductor end module; codable

Color	Item No.	Pack. Unit
 gray	2022-181	250
 blue	2022-184	250
 orange	2022-182	250
 green-yellow	2022-187	250

1-conductor center module; codable

 gray	2022-171	250
 blue	2022-174	250
 orange	2022-172	250
 green-yellow	2022-177	250

1-conductor base module; with integrated end plate; codable

 gray	2022-161	250
 blue	2022-164	250
 orange	2022-162	250
 green-yellow	2022-167	250

Accessories; for female plugs

Appropriate marking systems:
WMB/WMB Inline/Marking strips

Insulation stop; 5 pcs/strip; 0.25 ... 0.5 mm²

 light gray	2002-171	200 (25)
--	----------	----------

Insulation stop; 5 pcs/strip; 0.75 ... 1 mm²

 dark gray	2002-172	200 (25)
---	----------	----------

Protective warning marker; with black high-voltage symbol; for 5 terminal blocks

 yellow	2002-115	100 (25)
--	----------	----------

Locking lever; 4.8 mm wide

 orange	2022-142	100 (25)
gray	2022-141	100 (25)

Locking lever; 9.6 mm wide

 orange	2022-152	100 (25)
gray	2022-151	100 (25)

Carrier with 6 coding pins; for coding female plugs

 orange	2022-100	100 (25)
--	----------	----------

❶ Conductor range: 0.25 ... 4 mm² "s+f-st";
Push-in termination: 1 ... 4 mm² "s" and 1 ... 2.5 mm² "insulated ferrules, 12 mm"
Depending on the conductor characteristic, a conductor with a smaller cross section can also be inserted via push-in termination.

❷ 690 V = rated voltage
6 kV = rated impulse voltage
3 = pollution degree
(see Section 14)

❸ Current-carrying capacity curves upon request

Note:

According to EN 61984, pluggable connectors without a current interrupting capacity must not be mated or unmated when live or under load.

Approvals and corresponding ratings,
visit www.wago.com

Accessories; for female plugs

Appropriate marking systems:
WMB/WMB Inline/Marking strips

Strain relief plate; gray

 35 mm wide	734-326	100 (25)
6 mm wide	734-327	100 (25)
12.5 mm wide	734-328	100 (25)
25 mm wide	734-329	100 (25)
55 mm wide	734-430	50 (25)
75 mm wide	734-431	50 (25)

WMB Inline, plain; 1,500 WMB markers (5 mm)/reel; 5 ... 5.2 mm stretchable

 white	2009-115	1
---	----------	---

Marking strip; plain; 11 mm wide; 50 m reel

 white	2009-110	1
---	----------	---

WMB marking card; white; 10 strips with 10 markers/card; 5 ... 5.2 mm stretchable

 plain	793-5501	5
---	----------	---

WMB marking card; plain; 10 strips with 10 markers/card; 5 ... 5.2 mm stretchable

 yellow	793-5501/000-002	5
red	793-5501/000-005	5
blue	793-5501/000-006	5
gray	793-5501/000-007	5
orange	793-5501/000-012	5
light green	793-5501/000-017	5
green	793-5501/000-023	5
violet	793-5501/000-024	5

Customizing Modular Female Plugs

WAGO's modular X-COM®S-SYSTEM female plugs can be customized for applications requiring varying numbers of poles (e.g., when designing prototypes).

Modules and Pole Numbers

A customized X-COM®S-SYSTEM female plug consists of:

- One base module with an integrated end plate
- Up to 13 center modules (corresponding to a 15-pole female plug = maximum pole number)
- One end module

Intended Use

According to EN 61984, pluggable connectors without a current interrupting capacity must not be mated or unmated when live or under load.

Mounting

The appropriate mounting tool shall be used in order to guarantee that the individual modules are properly attached to each other without damaging the locking latches.

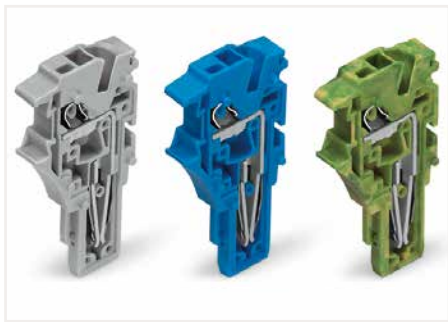

End module



Center module



Base module

Example: 5-Pole, 1-Conductor Female Plug

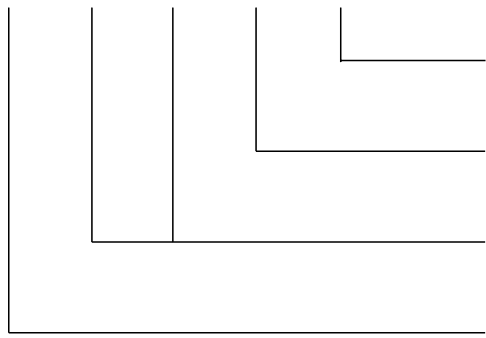

Base module with integrated end plate
2022-167

Center module
2022-174

Center modules
2022-171

End module
2022-181

Pre-Assembled 1-Conductor Female Plug X-COM®S-SYSTEM 2.5 (4) mm²; 2022 Series

Technical Data

0.25 ... 2.5 (4) mm ² ❶	22 ... 12 AWG
690 V/6 kV/3 ❷	600 V, 20 A ❸
I _N 24 A (32 A) ❸	600 V, 20 A ❹
Module width: 5.2 mm / 0.205 inch	
10 ... 12 mm / 0.39 ... 0.47 inch	

Technical Data

0.25 ... 2.5 (4) mm ² ❶	22 ... 12 AWG
690 V/6 kV/3 ❷	600 V, 20 A ❸
I _N 24 A (32 A) ❸	600 V, 20 A ❹
Module width: 5.2 mm / 0.205 inch	
10 ... 12 mm / 0.39 ... 0.47 inch	

Technical Data

0.25 ... 2.5 (4) mm ² ❶	22 ... 12 AWG
690 V/6 kV/3 ❷	600 V, 20 A ❸
I _N 24 A (32 A) ❸	600 V, 20 A ❹
Module width: 5.2 mm / 0.205 inch	
10 ... 12 mm / 0.39 ... 0.47 inch	

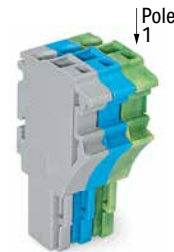
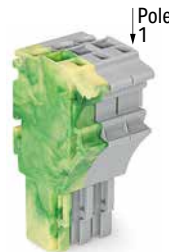

1-conductor female plug; with ground base module (green-yellow); fits into carrier terminal blocks; codable

Pole No.	Item No.	Pack. Unit
3	2022-103/000-036	100
4	2022-104/000-036	100
5	2022-105/000-036	50
6	2022-106/000-036	50
7	2022-107/000-036	50
8	2022-108/000-036	50
9	2022-109/000-036	50
10	2022-110/000-036	25
11	2022-111/000-036	25
12	2022-112/000-036	25
13	2022-113/000-036	25
14	2022-114/000-036	25
15	2022-115/000-036	25

1-conductor female plug; with ground end module (green-yellow); fits into carrier terminal blocks; codable

Pole No.	Item No.	Pack. Unit
3	2022-103/000-037	100
4	2022-104/000-037	100
5	2022-105/000-037	50
6	2022-106/000-037	50
7	2022-107/000-037	50
8	2022-108/000-037	50
9	2022-109/000-037	50
10	2022-110/000-037	25
11	2022-111/000-037	25
12	2022-112/000-037	25
13	2022-113/000-037	25
14	2022-114/000-037	25
15	2022-115/000-037	25

1-conductor female plug; with ground base module (green-yellow); fits into carrier terminal blocks; codable

Pole No.	Item No.	Pack. Unit
3	2022-103/000-038	100
4	2022-104/000-038	100
5	2022-105/000-038	50
6	2022-106/000-038	50
7	2022-107/000-038	50
8	2022-108/000-038	50
9	2022-109/000-038	50
10	2022-110/000-038	25
11	2022-111/000-038	25
12	2022-112/000-038	25
13	2022-113/000-038	25
14	2022-114/000-038	25
15	2022-115/000-038	25

Accessories; for female plugs

Appropriate marking systems: WMB/WMB Inline/Marking strips

Insulation stop; 5 pcs/strip; 0.25 ... 0.5 mm²

light gray	2002-171	200 (25)
------------	----------	----------

Insulation stop; 5 pcs/strip; 0.75 ... 1 mm²

dark gray	2002-172	200 (25)
-----------	----------	----------

Protective warning marker; with black high-voltage symbol; for 5 terminal blocks

yellow	2002-115	100 (25)
--------	----------	----------

Locking lever; 4.8 mm wide

orange	2022-142	100 (25)
gray	2022-141	100 (25)

Locking lever; 9.6 mm wide

orange	2022-152	100 (25)
gray	2022-151	100 (25)

Carrier with 6 coding pins; for coding female plugs

orange	2022-100	100 (25)
--------	----------	----------

Strain relief plate; gray

35 mm wide	734-326	100 (25)
6 mm wide	734-327	100 (25)
12.5 mm wide	734-328	100 (25)
25 mm wide	734-329	100 (25)
55 mm wide	734-430	50 (25)
75 mm wide	734-431	50 (25)

WMB Inline, plain; 1,500 WMB markers (5 mm)/reel; 5 ... 5.2 mm stretchable

white	2009-115	1
-------	----------	---

Marking strip; plain; 11 mm wide; 50 m reel

white	2009-110	1
-------	----------	---

WMB marking card; white; 10 strips with 10 markers/card; 5 ... 5.2 mm stretchable

plain	793-5501	5
-------	----------	---

WMB marking card; plain; 10 strips with 10 markers/card; 5 ... 5.2 mm stretchable

yellow	793-5501/000-002	5
red	793-5501/000-005	5
blue	793-5501/000-006	5
gray	793-5501/000-007	5
orange	793-5501/000-012	5
light green	793-5501/000-017	5
green	793-5501/000-023	5
violet	793-5501/000-024	5

Technical Data

0.25 ... 2.5 (4) mm² ❶ | 22 ... 12 AWG

690 V/6 kV/3 ❷ | 600 V, 20 A ❸

I_N 24 A (32 A) ❸ | 600 V, 20 A ❸

Module width: 5.2 mm / 0.205 inch

10 ... 12 mm / 0.39 ... 0.47 inch

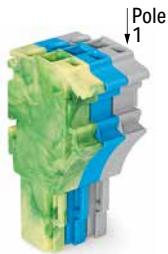

❶ Conductor range: 0.25 ... 4 mm² "s+f-st";
Push-in termination: 1 ... 4 mm² "s" and 1 ... 2.5 mm²
"insulated ferrules, 12 mm"
Depending on the conductor characteristic, a conductor with a smaller cross section can also be inserted via push-in termination.

❷ 690 V = rated voltage
6 kV = rated impulse voltage
3 = pollution degree
(see Section 14)

❸ Current-carrying capacity curves upon request

Note:

According to EN 61984, pluggable connectors without a current interrupting capacity must not be mated or unmated when live or under load.

Approvals and corresponding ratings, visit www.wago.com

1-conductor female plug; with ground end module (green-yellow); fits into carrier terminal blocks; codable

Pole No.	Item No.	Pack. Unit
3	2022-103/000-039	100
4	2022-104/000-039	100
5	2022-105/000-039	50
6	2022-106/000-039	50
7	2022-107/000-039	50
8	2022-108/000-039	50
9	2022-109/000-039	50
10	2022-110/000-039	25
11	2022-111/000-039	25
12	2022-112/000-039	25
13	2022-113/000-039	25
14	2022-114/000-039	25
15	2022-115/000-039	25

1-Conductor Female Plug X-COM®S-SYSTEM; with Lateral Locking Lever and Strain Relief Plate 2.5 (4) mm²; 2022 Series

Technical Data	
0.25 ... 2.5 (4) mm ² ❶	22 ... 12 AWG
690 V/6 kV/3 ❷	600 V, 20 A ❸
I _N 24 A (32 A) ❸	600 V, 20 A ❸
Module width: 5.2 mm / 0.205 inch	
10 ... 12 mm / 0.39 ... 0.47 inch	

Technical Data	
0.25 ... 2.5 (4) mm ² ❶	22 ... 12 AWG
690 V/6 kV/3 ❷	600 V, 20 A ❸
I _N 24 A (32 A) ❸	600 V, 20 A ❸
Module width: 5.2 mm / 0.205 inch	
10 ... 12 mm / 0.39 ... 0.47 inch	

Technical Data	
0.25 ... 2.5 (4) mm ² ❶	22 ... 12 AWG
690 V/6 kV/3 ❷	600 V, 20 A ❸
I _N 24 A (32 A) ❸	600 V, 20 A ❸
Module width: 5.2 mm / 0.205 inch	
10 ... 12 mm / 0.39 ... 0.47 inch	

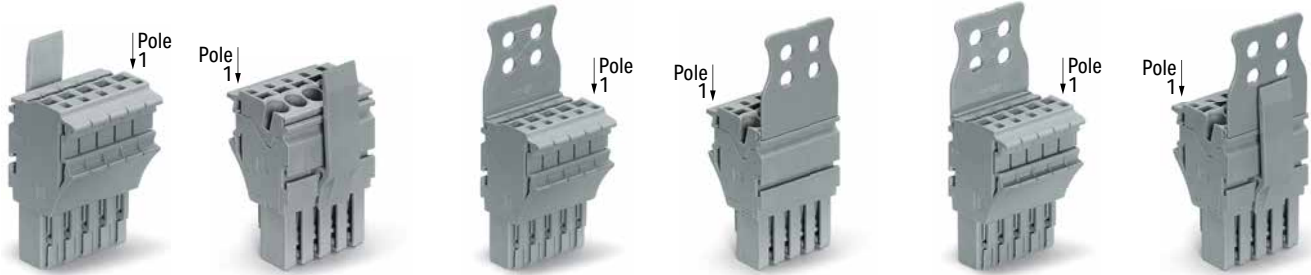

1-conductor female plug; with locking lever; fits into carrier terminal blocks; codable; gray

Pole No.	Item No.	Pack. Unit
○ 1	2022-101/122-000	200
○ 2	2022-102/122-000	100
○ 3	2022-103/123-000	100
○ 4	2022-104/123-000	50
○ 5	2022-105/123-000	50
○ 6	2022-106/123-000	50
○ 7	2022-107/123-000	25
○ 8	2022-108/123-000	25
○ 9	2022-109/123-000	25
○ 10	2022-110/123-000	25
○ 11	2022-111/126-000	25
○ 12	2022-112/126-000	20
○ 13	2022-113/126-000	20
○ 14	2022-114/126-000	10
○ 15	2022-115/127-000	10

1-conductor female plug; with strain relief plate; fits into carrier terminal blocks; codable; gray

Pole No.	Item No.	Pack. Unit
○ 1	2022-101/132-000	200
○ 2	2022-102/132-000	100
○ 3	2022-103/133-000	100
○ 4	2022-104/133-000	50
○ 5	2022-105/134-000	50
○ 6	2022-106/134-000	50
○ 7	2022-107/135-000	25
○ 8	2022-108/135-000	25
○ 9	2022-109/135-000	25
○ 10	2022-110/135-000	25
○ 11	2022-111/136-000	25
○ 12	2022-112/136-000	20
○ 13	2022-113/136-000	20
○ 14	2022-114/136-000	10
○ 15	2022-115/137-000	10

1-conductor female plug; with strain relief plate and locking lever; fits into carrier terminal blocks; codable; gray

Pole No.	Item No.	Pack. Unit
○ 1	2022-101/142-000	200
○ 2	2022-102/142-000	100
○ 3	2022-103/143-000	100
○ 4	2022-104/143-000	50
○ 5	2022-105/144-000	50
○ 6	2022-106/144-000	50
○ 7	2022-107/145-000	25
○ 8	2022-108/145-000	25
○ 9	2022-109/145-000	25
○ 10	2022-110/145-000	25
○ 11	2022-111/146-000	25
○ 12	2022-112/146-000	20
○ 13	2022-113/146-000	20
○ 14	2022-114/146-000	10
○ 15	2022-115/147-000	10

1-conductor female plug; with locking lever; fits into carrier terminal blocks; codable

● 1 blue	2022-101/122-006	200
● 1 green-yellow	2022-101/122-016	200

1-conductor female plug; with strain relief plate; fits into carrier terminal blocks; codable

● 1 blue	2022-101/132-006	200
● 1 green-yellow	2022-101/132-016	200

1-conductor female plug; with strain relief plate and locking lever; fits into carrier terminal blocks; codable

● 1 blue	2022-101/142-006	200
● 1 green-yellow	2022-101/142-016	200

Accessories; for female plugs

Appropriate marking systems: WMB/WMB Inline/Marking strips

Insulation stop; 5 pcs/strip; 0.25 ... 0.5 mm²

light gray	2002-171	200 (25)
------------	----------	----------

Insulation stop; 5 pcs/strip; 0.75 ... 1 mm²

dark gray	2002-172	200 (25)
-----------	----------	----------

Protective warning marker; with black high-voltage symbol; for 5 terminal blocks

yellow	2002-115	100 (25)
--------	----------	----------

Carrier with 6 coding pins; for coding female plugs

orange	2022-100	100 (25)
--------	----------	----------

WMB Inline, plain; 1,500 WMB markers (5 mm)/reel; 5 ... 5.2 mm stretchable

white	2009-115	1
-------	----------	---

Marking strip; plain; 11 mm wide; 50 m reel

white	2009-110	1
-------	----------	---

WMB marking card; white; 10 strips with 10 markers/card; 5 ... 5.2 mm stretchable

plain	793-5501	5
-------	----------	---

WMB marking card; plain; 10 strips with 10 markers/card; 5 ... 5.2 mm stretchable

yellow	793-5501/000-002	5
red	793-5501/000-005	5
blue	793-5501/000-006	5
gray	793-5501/000-007	5
orange	793-5501/000-012	5
light green	793-5501/000-017	5
green	793-5501/000-023	5
violet	793-5501/000-024	5

- ❶ Conductor range: 0.25 ... 4 mm² "s+f-st";
Push-in termination: 1 ... 4 mm² "s" and 1 ... 2.5 mm²
"insulated ferrules, 12 mm"
Depending on the conductor characteristic, a conductor with a smaller cross section can also be inserted via push-in termination.
- ❷ 690 V = rated voltage
6 kV = rated impulse voltage
3 = pollution degree
(see Section 14)
- ❸ Current-carrying capacity curves upon request

Note:
According to EN 61984, pluggable connectors without a current interrupting capacity must not be mated or unmated when live or under load.

Approvals and corresponding ratings, visit www.wago.com

Strain Relief Plate (SRP), Gray			Assembled		Locking Lever (LL), Gray				Assembled		SRP and LL, Gray
SRP			Item No. Suffix	Pole No.	Quantity	1-Way	2-Way	Item No. Suffix	Item No. Suffix		
Item No.	Color	Width									
734-327	gray	6mm	/132-0xx	1 to 2	1	/122-0xx	–	/142-0xx			
734-328	gray	12.5mm	/133-0xx	3 to 4	1	–	/123-0xx	/143-0xx			
734-329	gray	25mm	/134-0xx	5 to 6	1	–	/123-0xx	/144-0xx			
734-326	gray	35mm	/135-0xx	7 to 10	1	–	/123-0xx	/145-0xx			
734-430	gray	55mm	/136-0xx	11 to 14	2	–	/126-0xx	/146-0xx			
734-431	gray	75mm	/137-0xx	15	2	–	/127-0xx	/147-0xx			

For colored female plugs, the item number suffix "xx" must be replaced by the blue "-006" and the green-yellow "-016" color suffix.

Dimensions of locking levers

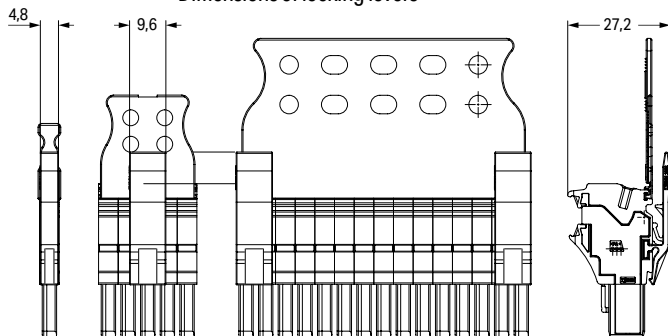

Description	Color	Item No.	Suffix No.
1-conductor female plug	gray	2022-101	none
1- to 15-pole	blue	to	/000-006
	green-yellow	2022-115	/000-016

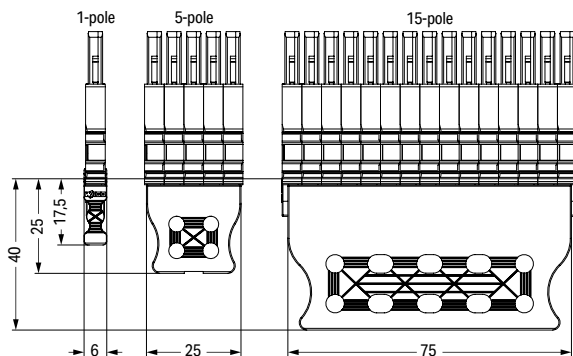
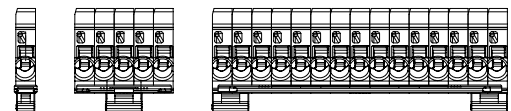

Dimensions of strain relief plates

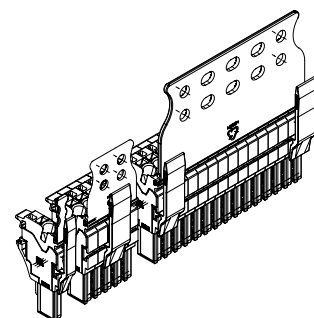

1-Conductor/1-Pin, 2-Conductor/1-Pin and 2-Conductor/2-Pin Carrier Terminal Block X-COM®S-SYSTEM; for Ex nA Applications 2.5 (4) mm²; 2022 Series

Technical Data

0.25 ... 2.5 (4) mm ² ①	22 ... 12 AWG
630 V ②	600 V, 20 A ③
I _N 20 A	600 V, 20 A ④
Terminal block width: 5.2 mm / 0.205 inch	
 10 ... 12 mm / 0.39 ... 0.47 inch	

Technical Data

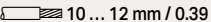
0.25 ... 2.5 (4) mm ² ①	22 ... 12 AWG
630 V ②	600 V, 20 A ③
I _N 20 A	600 V, 20 A ④
Terminal block width: 5.2 mm / 0.205 inch	
 10 ... 12 mm / 0.39 ... 0.47 inch	

Technical Data

0.25 ... 2.5 (4) mm ² ①	22 ... 12 AWG
630 V ②	600 V, 20 A ③
I _N 20 A	600 V, 20 A ④
Terminal block width: 5.2 mm / 0.205 inch	
 10 ... 12 mm / 0.39 ... 0.47 inch	

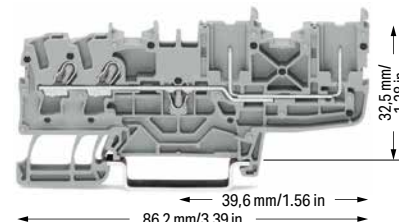
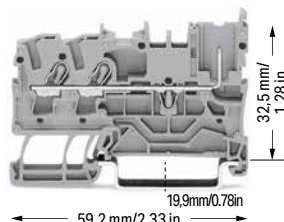
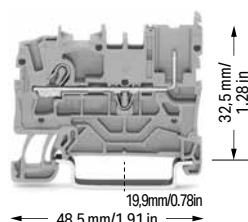

1-conductor/1-pin carrier terminal block; suitable for Ex nA applications

Color	Item No.	Pack. Unit
○ gray	2022-1201/999-953	100
● blue	2022-1204/999-953	100

2-conductor/1-pin carrier terminal block; suitable for Ex nA applications

Color	Item No.	Pack. Unit
○ gray	2022-1301/999-953	100
● blue	2022-1304/999-953	100

2-conductor/2-pin carrier terminal block; suitable for Ex nA applications

Color	Item No.	Pack. Unit
○ gray	2022-1401/999-953	50
● blue	2022-1404/999-953	50

1-conductor/1-pin ground carrier terminal block; suitable for Ex nA applications

Color	Item No.	Pack. Unit
● green-yellow	2022-1207/999-953	100

2-conductor/1-pin ground carrier terminal block; suitable for Ex nA applications

Color	Item No.	Pack. Unit
● green-yellow	2022-1307/999-953	100

2-conductor/2-pin ground carrier terminal block; suitable for Ex nA applications

Color	Item No.	Pack. Unit
● green-yellow	2022-1407/999-953	50

Accessories; item-specific

End and intermediate plate; 1 mm thick

Color	Item No.	Pack. Unit
orange	2022-1292	100 (25)
gray	2022-1291	100 (25)

Accessories; item-specific

End and intermediate plate; 1 mm thick

Color	Item No.	Pack. Unit
orange	2022-1392	100 (25)
gray	2022-1391	100 (25)

Accessories; item-specific

End and intermediate plate; 1 mm thick

Color	Item No.	Pack. Unit
orange	2022-1492	100 (25)
gray	2022-1491	100 (25)

Accessories; 2022 Series

Appropriate marking systems: WMB/WMB Inline/Marking strips

Insulation stop; 5 pcs/strip; 0.25 ... 0.5 mm²

Color	Item No.	Pack. Unit
light gray	2002-171	200 (25)

Insulation stop; 5 pcs/strip; 0.75 ... 1 mm²

Color	Item No.	Pack. Unit
dark gray	2002-172	200 (25)

Protective warning marker; with black high-voltage symbol; for 5 terminal blocks

Color	Item No.	Pack. Unit
yellow	2002-115	100 (25)

Push-in type jumper bar; insulated; I_N 25 A; light gray

Way	Item No.	Pack. Unit
2-way	2002-402	25
3-way	2002-403	25
4-way	2002-404	25
5-way	2002-405	25
6-way	2002-406	25
7-way	2002-407	25
8-way	2002-408	25
9-way	2002-409	25
10-way	2002-410	25

Push-in type jumper bar; insulated; I_N 25 A; light gray

Way	Item No.	Pack. Unit
1 to 3	2002-433	25
1 to 4	2002-434	25
1 to 5	2002-435	25
1 to 6	2002-436	25
1 to 7	2002-437	25
1 to 8	2002-438	25
1 to 9	2002-439	25
1 to 10	2002-440	25

Staggered jumper; insulated; I_N 25 A; light gray

Way	Item No.	Pack. Unit
2-way	2002-472	25
3-way	2002-473	25
4-way	2002-474	25
5-way	2002-475	25
6-way	2002-476	25
7-way	2002-477	25
8-way	2002-478	25
9-way	2002-479	25
10-way	2002-480	25
11-way	2002-481	25
12-way	2002-482	25

Push-in type wire jumper; insulated; 1.5 mm² conductor cross-section; I_N 18 A

Length (L)	Item No.	Pack. Unit
L = 60 mm	2009-412	100 (10)
L = 110 mm	2009-414	100 (10)
L = 250 mm	2009-416	100 (10)

Carrier with 6 coding pins; for coding female plugs

Color	Item No.	Pack. Unit
orange	2022-100	100 (25)

Test pin; 1 mm Ø

Item No.	Pack. Unit
859-500	1

1-conductor female plug; with shorter locking lever; suitable for Ex nA applications; fits into carrier terminal blocks; codable

Color	Item No.	Pack. Unit
gray	2022-103/999-953	100

WMB Inline, plain; 1,500 WMB markers (5 mm)/reel; 5 ... 5.2 mm stretchable

Color	Item No.	Pack. Unit
white	2009-115	1

Marking strip; plain; 11 mm wide; 50 m reel

Color	Item No.	Pack. Unit
white	2009-110	1

WMB marking card; white; 10 strips with 10 markers/card; 5 ... 5.2 mm stretchable

Color	Item No.	Pack. Unit
plain	793-5501	5

WMB marking card; plain; 10 strips with 10 markers/card; 5 ... 5.2 mm stretchable

Color	Item No.	Pack. Unit
yellow	793-5501/000-002	5
red	793-5501/000-005	5
blue	793-5501/000-006	5
gray	793-5501/000-007	5
orange	793-5501/000-012	5
light green	793-5501/000-017	5
green	793-5501/000-023	5
violet	793-5501/000-024	5

- 1 Conductor range: 0.25 ... 4 mm² "s+f-st";
Push-in termination: 1 ... 4 mm² "s" and 1 ... 2.5 mm²
"insulated ferrules, 12 mm"
Depending on the conductor characteristic, a conductor with a smaller cross section can also be inserted via push-in termination.
- 2 630 V = rated voltage for use in Zone 2 hazardous areas, "nA" type of protection (see Section 14)

Note:

When used as intended, female plugs must not be connected/disconnected when live or under load.

Please observe the application notes:
Jumpers, from page 152
Marking, from page 588

Approvals and corresponding ratings,
visit www.wago.com



630 V = rated voltage for use in Zone 2 hazardous areas, "nA" type of protection

"n" refers to an ignition protection class in Zone 2:
This zone covers areas in which a dangerous, explosive atmosphere consisting of gases, vapors or dust is unlikely to exist and will only persist for a short period if it does.

"A" means: non-sparking (function modules without relays/switches)

Ex marking:
"Ex" sign and extended item number ".../999-953" are printed on the side of both carrier terminal blocks and female plugs with Ex approval.
Shorter locking lever (factory-mounted) makes accidental disconnection more difficult.

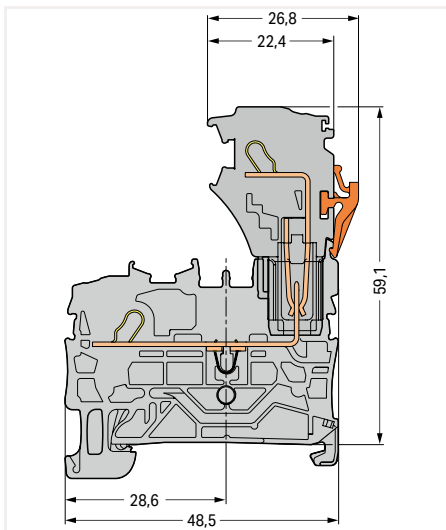

Carrier terminal block

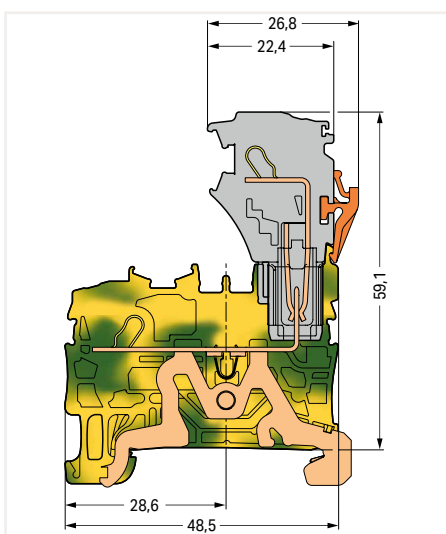

Ground carrier terminal block

1-Conductor/1-Pin Double-Deck Carrier Terminal Block X-COM®S-SYSTEM; for Ex nA Applications

2.5 (4) mm²; 2022 Series

Technical Data

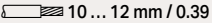
0.25 ... 2.5 (4) mm ² ①	22 ... 12 AWG
630 V ②	600 V; 20 A ③
I _N 20 A	600 V; 20 A ④
Terminal block width: 5.2 mm / 0.205 inch	
 10 ... 12 mm / 0.39 ... 0.47 inch	

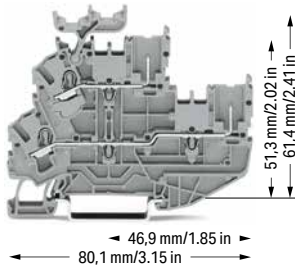

1-conductor/1-pin double-deck carrier terminal block; through/through terminal block; with marker carrier; gray housing; suitable for Ex nA applications

	Item No.	Pack. Unit
<input type="radio"/> L/L	2022-2231/999-953	50
<input type="radio"/> N/L	2022-2232/999-953	50
<input type="radio"/> L/N	2022-2233/999-953	50

Technical Data

0.25 ... 2.5 (4) mm ² ①	22 ... 12 AWG
630 V ②	600 V; 20 A ③
I _N 20 A	600 V; 20 A ④
Terminal block width: 5.2 mm / 0.205 inch	
 10 ... 12 mm / 0.39 ... 0.47 inch	

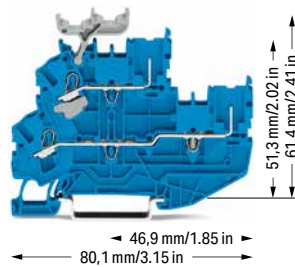

1-conductor/1-pin double-deck carrier terminal block; through/through terminal block; with marker carrier; blue housing; suitable for Ex nA applications

	Item No.	Pack. Unit
<input checked="" type="radio"/> N/N	2022-2234/999-953	50

Technical Data

0.25 ... 2.5 (4) mm ² ①	22 ... 12 AWG
Terminal block width: 5.2 mm / 0.205 inch	
 10 ... 12 mm / 0.39 ... 0.47 inch	

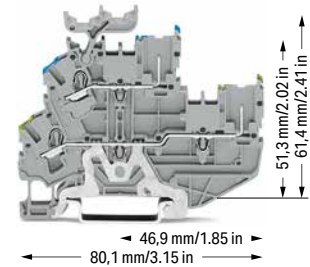

1-conductor/1-pin double-deck carrier terminal block; ground conductor/through terminal block; with marker carrier; gray housing; for Ex nA applications

	Item No.	Pack. Unit
<input type="radio"/> PE/N	2022-2247/999-953	50
<input type="radio"/> PE/L	2022-2257/999-953	50

1-conductor/1-pin double-deck carrier terminal block; through/through terminal block; without marker carrier; gray housing; for Ex nA applications

<input type="radio"/> L/L	2022-2201/999-953	50
<input type="radio"/> N/L	2022-2202/999-953	50
<input type="radio"/> L/N	2022-2203/999-953	50

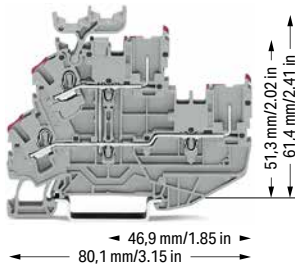

1-conductor/1-pin double-deck carrier terminal block; through/through terminal block; without marker carrier; blue housing; for Ex nA applications

<input checked="" type="radio"/> N/N	2022-2204/999-953	50
--------------------------------------	-------------------	----

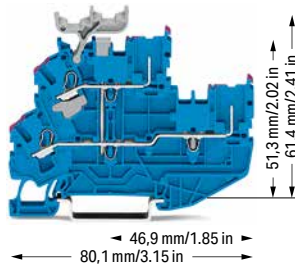

1-conductor/1-pin double-deck carrier terminal block; ground conductor/through terminal block; without marker carrier; gray housing; for Ex nA applications

<input type="radio"/> PE/N	2022-2217/999-953	50
<input type="radio"/> PE/L	2022-2227/999-953	50

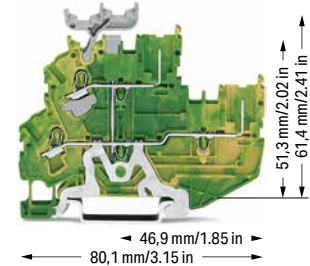

2-conductor/2-pin double-deck carrier terminal block; 2-conductor/2-pin through terminal block; with marker carrier, internally commoned; violet conductor entry; gray housing; for Ex nA applications

	Item No.	Pack. Unit
<input type="radio"/> L	2022-2238/999-953	50

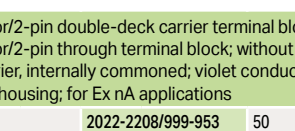

2-conductor/2-pin double-deck carrier terminal block; 2-conductor/2-pin through terminal block; with marker carrier, internally commoned; violet conductor entry; blue housing; for Ex nA applications

	Item No.	Pack. Unit
<input checked="" type="radio"/> N	2022-2239/999-953	50

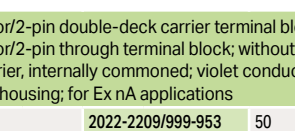

2-conductor/2-pin double-deck carrier block; 2-conductor/2-pin ground conductor block; with marker carrier, internally commoned; green-yellow housing; for Ex nA applications

	Item No.	Pack. Unit
<input checked="" type="radio"/> PE	2022-2237/999-953	50

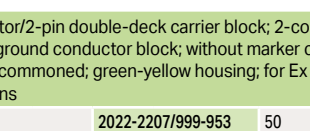

2-conductor/2-pin double-deck carrier terminal block; 2-conductor/2-pin through terminal block; without marker carrier, internally commoned; violet conductor entry; gray housing; for Ex nA applications

<input type="radio"/> L	2022-2208/999-953	50
-------------------------	-------------------	----

2-conductor/2-pin double-deck carrier terminal block; 2-conductor/2-pin through terminal block; without marker carrier, internally commoned; violet conductor entry; blue housing; for Ex nA applications

<input checked="" type="radio"/> N	2022-2209/999-953	50
------------------------------------	-------------------	----

2-conductor/2-pin double-deck carrier block; 2-conductor/2-pin ground conductor block; without marker carrier, internally commoned; green-yellow housing; for Ex nA applications

<input checked="" type="radio"/> PE	2022-2207/999-953	50
-------------------------------------	-------------------	----

1 Conductor range: 0.25 ... 4 mm² "s+f-st";
Push-in termination: 1 ... 4 mm² "s" and 1 ... 2.5 mm²
"insulated ferrules, 12 mm"
Depending on the conductor characteristic, a conductor with a smaller cross section can also be inserted via push-in termination.

2 630 V = rated voltage for use in Zone 2 hazardous areas, "nA" type of protection (see Section 14) with double-deck vertical jumper,

Note:

When used as intended, female plugs must not be connected/disconnected when live or under load.

Please observe the application notes:
Jumpers, from page 152
Marking, from page 588

Approvals and corresponding ratings, visit www.wago.com

Accessories; 2022 Series

Appropriate marking systems:
WMB/WMB Inline/Marking strips

End and intermediate plate; 1 mm thick

	orange	2022-2292	100 (25)
	gray	2022-2291	100 (25)

Insulation stop; 5 pcs/strip; 0.25 ... 0.5 mm²

	light gray	2002-171	200 (25)
---	------------	----------	----------

Insulation stop; 5 pcs/strip; 0.75 ... 1 mm²

	dark gray	2002-172	200 (25)
---	-----------	----------	----------

Protective warning marker; with black high-voltage symbol; for 5 terminal blocks

	yellow	2002-115	100 (25)
---	--------	----------	----------

Push-in type jumper bar; insulated; I_N 25 A; light gray

	2-way	2002-402	25
	3-way	2002-403	25
	4-way	2002-404	25
	5-way	2002-405	25
	6-way	2002-406	25
	7-way	2002-407	25
	8-way	2002-408	25
	9-way	2002-409	25
	10-way	2002-410	25

Push-in type jumper bar; insulated; I_N 25 A; light gray

	1 to 3	2002-433	25
	1 to 4	2002-434	25
	1 to 5	2002-435	25
	1 to 6	2002-436	25
	1 to 7	2002-437	25
	1 to 8	2002-438	25
	1 to 9	2002-439	25
	1 to 10	2002-440	25

Double-deck vertical jumper; insulated; I_N 24 A

	light gray	2002-492	100 (25)
	orange	2002-492/000-012	100 (25)

Accessories; 2022 Series

Appropriate marking systems:
WMB/WMB Inline/Marking strips

Adjacent jumper for continuous commoning; insulated; I_N 25 A, light gray

	2-way	2002-400	25
---	-------	----------	----

Adjacent jumper for continuous commoning; insulated; I_N 25 A; 1 to 3

	light gray	2002-423	25
	red	2002-423/000-005	25
	blue	2002-423/000-006	25

Adjacent jumper for continuous commoning; insulated; I_N 25 A, light gray

	5-way	2002-415	25
---	-------	----------	----

Carrier with 6 coding pins; for coding female plugs

	orange	2022-100	100 (25)
---	--------	----------	----------

Test pin; 1 mm Ø

		859-500	1
---	--	---------	---

1-conductor female plug; with shorter locking lever; suitable for Ex nA applications; fits into carrier terminal blocks; codable

	gray	2022-103/999-953	100
---	------	------------------	-----

WMB Inline, plain; 1,500 WMB markers (5 mm)/reel; 5 ... 5.2 mm stretchable

	white	2009-115	1
---	-------	----------	---

Marking strip; plain; 11 mm wide; 50 m reel

	white	2009-110	1
---	-------	----------	---

WMB marking card; white; 10 strips with 10 markers/card; 5 ... 5.2 mm stretchable

	plain	793-5501	5
---	-------	----------	---

WMB marking card; plain; 10 strips with 10 markers/card; 5 ... 5.2 mm stretchable

	yellow	793-5501/000-002	5
	red	793-5501/000-005	5
	blue	793-5501/000-006	5
	gray	793-5501/000-007	5
	orange	793-5501/000-012	5
	light green	793-5501/000-017	5
	green	793-5501/000-023	5
	violet	793-5501/000-024	5

Double-deck marker carrier; pivoting

	gray	2002-121	50 (25)
---	------	----------	---------

Screwless end stop; for DIN-35 rail; 6 mm wide

	gray	249-116	100 (25)
---	------	---------	----------

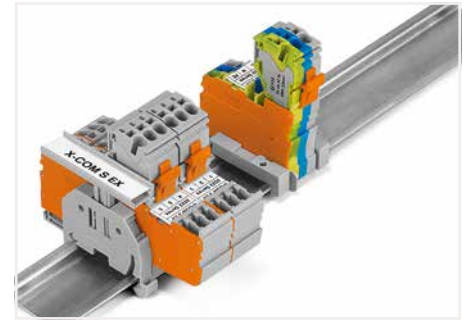

Group marking with height-adjustable group marker carrier (2009-163)

1-Conductor Female Plug X-COM®S-SYSTEM; for Ex nA Applications 2.5 (4) mm²; 2022 Series

Technical Data

0.25 ... 2.5 (4) mm² ① | 22 ... 12 AWG

630 V ② | 600 V, 20 A 

I_N 20 A | 600 V, 20 A 

Module width: 5.2 mm / 0.205 inch

 10 ... 12 mm / 0.39 ... 0.47 inch

① Conductor range: 0.25 ... 4 mm² "s+f-st";
Push-in termination: 1 ... 4 mm² "s" and 1 ... 2.5 mm²
"insulated ferrules, 12 mm"
Depending on the conductor characteristic, a conductor with a smaller cross section can also be inserted via push-in termination.

② 630 V = rated voltage for use in Zone 2 hazardous areas, "nA" type of protection (see Section 14)

Approvals and corresponding ratings, visit www.wago.com

Accessories; for female plugs

Appropriate marking systems:
WMB/WMB Inline/Marking strips

Insulation stop; 5 pcs/strip; 0.25 ... 0.5 mm²

light gray 2002-171 200 (25)



Insulation stop; 5 pcs/strip; 0.75 ... 1 mm²

dark gray 2002-172 200 (25)



Protective warning marker; with black high-voltage symbol; for 5 terminal blocks

yellow 2002-115 100 (25)



Carrier with 6 coding pins; for coding female plugs

orange 2022-100 100 (25)



Strain relief plate; gray

35 mm wide 734-326 100 (25)

6 mm wide 734-327 100 (25)

12.5 mm wide 734-328 100 (25)

25 mm wide 734-329 100 (25)

55 mm wide 734-430 50 (25)

75 mm wide 734-431 50 (25)



WMB Inline, plain; 1,500 WMB markers (5 mm)/reel; 5 ... 5.2 mm stretchable

white 2009-115 1



Marking strip; plain; 11 mm wide; 50 m reel

white 2009-110 1



WMB marking card; white; 10 strips with 10 markers/card; 5 ... 5.2 mm stretchable

plain 793-5501 5



WMB marking card; plain; 10 strips with 10 markers/card; 5 ... 5.2 mm stretchable

yellow 793-5501/000-002 5

red 793-5501/000-005 5

blue 793-5501/000-006 5

gray 793-5501/000-007 5

orange 793-5501/000-012 5

light green 793-5501/000-017 5

green 793-5501/000-023 5

violet 793-5501/000-024 5

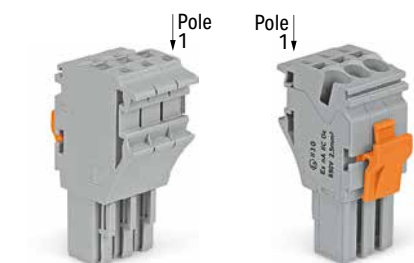

Dimensions (in mm):

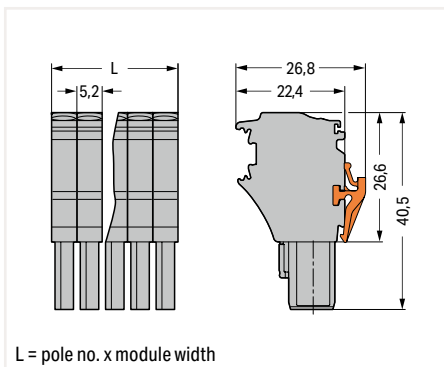

L = pole no. x module width

1-conductor female plug; with shorter locking lever; suitable for Ex nA applications; fits into carrier terminal blocks; codable; gray

According to EN 61984, pluggable connectors without a current interrupting capacity must not be mated or unmated when live or under load.

Pole No.	Item No.	Pack. Unit
○ 2	2022-102/999-953	200
○ 3	2022-103/999-953	100
○ 4	2022-104/999-953	100
○ 5	2022-105/999-953	50
○ 6	2022-106/999-953	50
○ 7	2022-107/999-953	50
○ 8	2022-108/999-953	50



Each female plug is supplied with a locking lever.

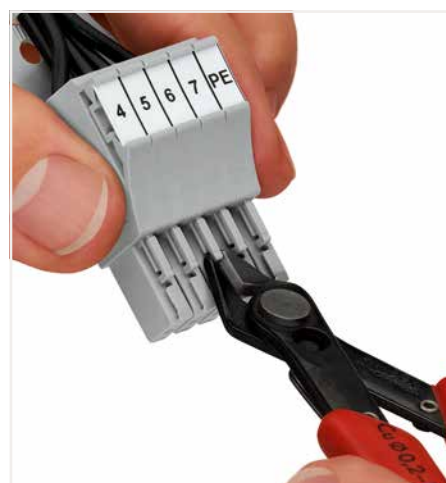

Coding a female plug: remove coding finger using a suitable tool.

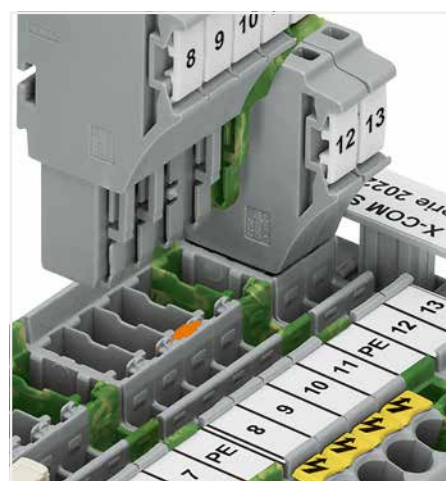

Insert a coding pin (2022-100) into the corresponding location of the carrier terminal block.

Pre-Assembled 1-Conductor Female Plug X-COM®S-SYSTEM; for Ex nA Applications 2.5 (4) mm²; 2022 Series

Technical Data

0.25 ... 2.5 (4) mm ² ①	22 ... 12 AWG
630 V ②	600 V, 20 A
I _N 20 A	600 V, 20 A
Module width: 5.2 mm / 0.205 inch	
10 ... 12 mm / 0.39 ... 0.47 inch	

Technical Data

0.25 ... 2.5 (4) mm ² ①	22 ... 12 AWG
630 V ②	600 V, 20 A
I _N 20 A	600 V, 20 A
Module width: 5.2 mm / 0.205 inch	
10 ... 12 mm / 0.39 ... 0.47 inch	

① Conductor range: 0.25 ... 4 mm² "s+f-st"; Push-in termination: 1 ... 4 mm² "s" and 1 ... 2.5 mm² "insulated ferrules, 12 mm"
Depending on the conductor characteristic, a conductor with a smaller cross section can also be inserted via push-in termination.

② 630 V = rated voltage for use in Zone 2 hazardous areas, "nA" type of protection (see Section 14)

Note:

According to EN 61984, pluggable connectors without a current interrupting capacity must not be mated or unmated when live or under load.

Approvals and corresponding ratings, visit www.wago.com

2



1-conductor female plug; with shorter locking lever; with ground base module (green-yellow); fits into carrier terminal blocks; codable

Pole No.	Item No.	Pack. Unit
3	2022-103/000-038/999-953	100
4	2022-104/000-038/999-953	100
5	2022-105/000-038/999-953	50
6	2022-106/000-038/999-953	50

1-conductor female plug; with shorter locking lever; with ground end module (green-yellow); fits into carrier terminal blocks; codable

Pole No.	Item No.	Pack. Unit
3	2022-103/000-039/999-953	100
4	2022-104/000-039/999-953	100
5	2022-105/000-039/999-953	50
6	2022-106/000-039/999-953	50

Accessories; for female plugs

Appropriate marking systems: WMB/WMB Inline/Marking strips

Insulation stop; 5 pcs/strip; 0.25 ... 0.5 mm²

light gray 2002-171 200 (25)



Insulation stop; 5 pcs/strip; 0.75 ... 1 mm²

dark gray 2002-172 200 (25)



Protective warning marker; with black high-voltage symbol; for 5 terminal blocks

yellow 2002-115 100 (25)



Carrier with 6 coding pins; for coding female plugs

orange 2022-100 100 (25)



Strain relief plate; gray

35 mm wide 734-326 100 (25)

6 mm wide 734-327 100 (25)

12.5 mm wide 734-328 100 (25)

25 mm wide 734-329 100 (25)

55 mm wide 734-430 50 (25)

75 mm wide 734-431 50 (25)



WMB Inline, plain; 1,500 WMB markers (5 mm)/reel; 5 ... 5.2 mm stretchable

white 2009-115 1



Marking strip; plain; 11 mm wide; 50 m reel

white 2009-110 1



WMB marking card; white; 10 strips with 10 markers/card; 5 ... 5.2 mm stretchable

plain 793-5501 5



WMB marking card; plain; 10 strips with 10 markers/card; 5 ... 5.2 mm stretchable

yellow 793-5501/000-002 5

red 793-5501/000-005 5

blue 793-5501/000-006 5

gray 793-5501/000-007 5

orange 793-5501/000-012 5

light green 793-5501/000-017 5

green 793-5501/000-023 5

violet 793-5501/000-024 5

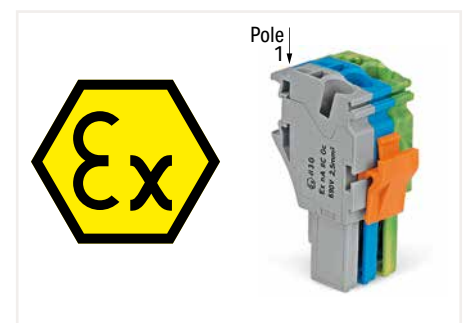

Ex marking:



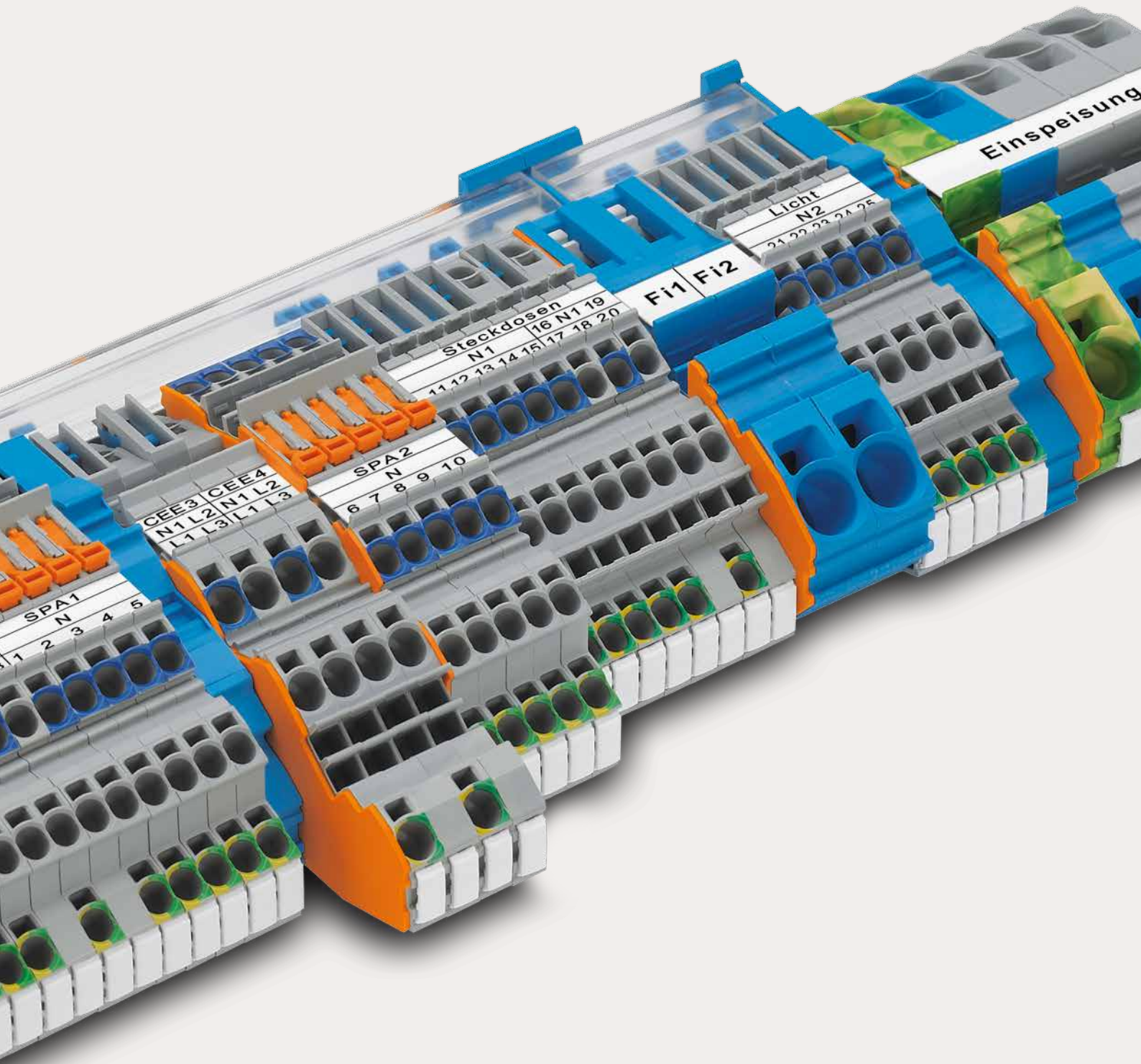



"Ex" sign and extended item number ".../999-953" are printed on the side of both carrier terminal blocks and female plugs with Ex approval. Shorter locking lever (factory-mounted) makes accidental disconnection more difficult.



WAGO Installation Rail-Mount Terminal Blocks TOPJOB® S

WAGO Installation Rail-Mount Terminal Blocks TOPJOB® S

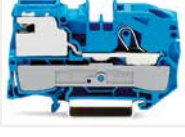
Front-Entry Wiring

			Page
	Multilevel Installation Terminal Blocks; with N-Disconnect Slide Links 0.25 ... 2.5 (4) mm ² (22 ... 12 AWG)	2003 Series	202
	Multilevel Installation Terminal Blocks; with Internal N-Disconnection 0.25 ... 2.5 (4) mm ² (22 ... 12 AWG)	2003 Series	204
	Double-Fuse Plugs on Carrier Terminal Blocks	2003 Series	208
	Multilevel Installation Terminal Blocks; with N-Disconnect Slide Links 0.5 ... 4 (6) mm ² (20 ... 10 AWG)	2005 Series	210
	N-Disconnect Terminal Blocks and Power Distribution Disconnect Terminal Blocks 0.5 ... 16 (25 "f-st") mm ² (20 ... 4 AWG)	2002/2006/2016 Series	212
	Supply Terminal Blocks for Distribution Boxes 0.5 ... 16 (25 "f-st") mm ² (20 ... 4 AWG)	2016 Series	214

Installation Rail-Mount Terminal Blocks TOPJOB® S

Installation

3



Inserting a conductor via push-in termination. Solid conductors with cross-sections from either one size above, or up to two sizes below, the rated cross-section can be simply pushed in – no tools needed.



Inserting a conductor via operating tool. Connecting fine-stranded conductors without ferrules, or small cross-sectional conductors that cannot be pushed in, is performed similarly to the original CAGE CLAMP® – just use an operating tool.

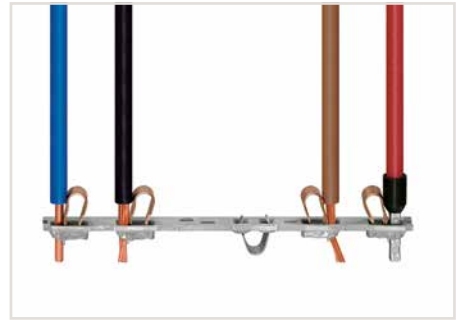

All conductor types at a glance

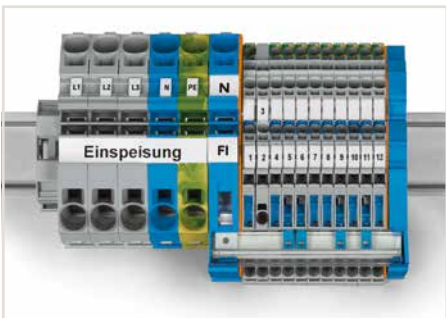

Mounting busbars on busbar carriers: Insert busbar ends onto large busbar carriers (2009-305) or onto supply terminal blocks with an integrated busbar carrier.

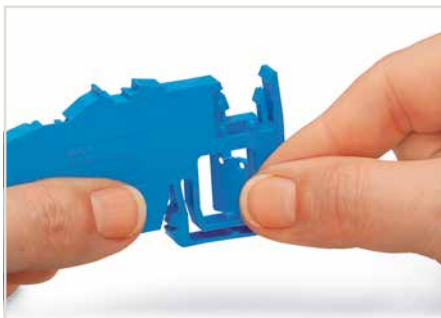

Removing the separator plate from the busbar carrier or from the N-disconnect terminal block.

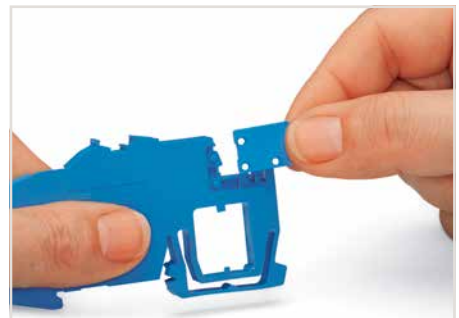

Inserting the separator plate into the busbar carrier to protect the N-busbar against accidental contact.



Inserting separator plate removed from N-disconnect terminal block.

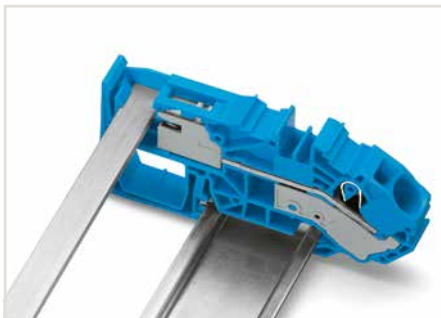

Touch-proof N-busbar via inserted separator plate

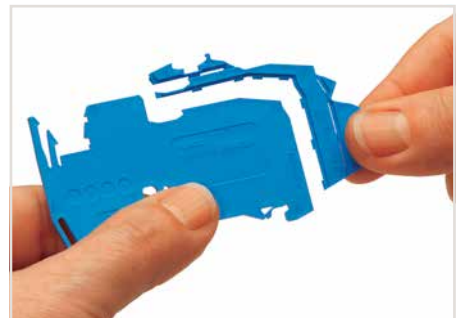

Perforations make it possible to fit the carrier to all Installation Rail-Mount Terminal Blocks TOPJOB® S using a single part.



The compact busbar carrier (1.5 mm thick), which is placed every 200 mm, provides additional busbar support for longer assemblies.

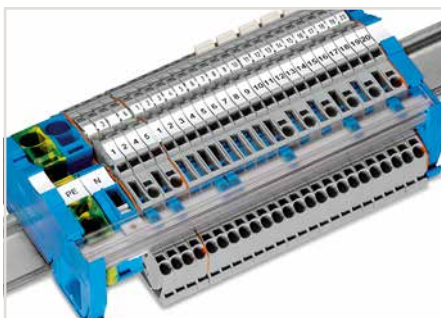

The busbar transparent cover (Item No. 777-303) protects the busbar against accidental contact and makes it easy to see which terminal blocks are connected to the busbar.

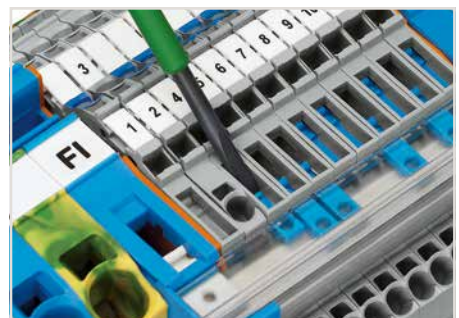

Tool-operated N-disconnect slide link



Push-in CAGE CLAMP® terminates the following copper conductors: solid



stranded



fine-stranded, also with tinned single strands

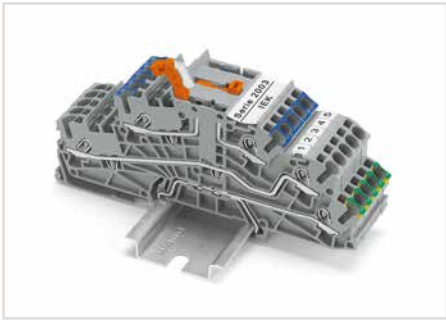

N-potential disconnection via N-knife disconnect within a terminal block assembly without a busbar.

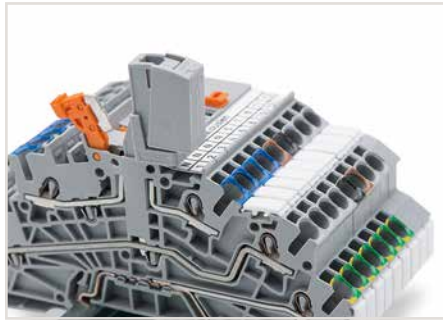

For multilevel installation terminal blocks with internal N-disconnection, test plug adapters can be inserted into the free vertical test slot when the N-potential is disconnected.

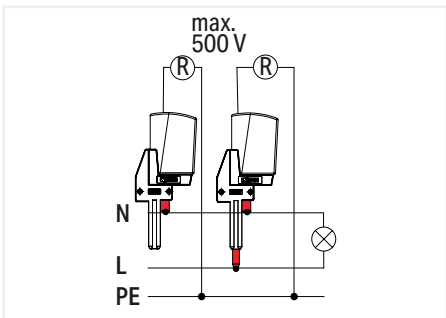

Test plug adapters for both individual N-potential measurement and insulation resistance measurement of the connected N- and L-potentials are available.

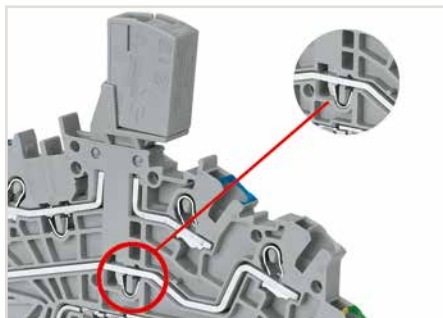

Multilevel installation terminal block fitted with an N/L-test plug adapter for quick and safe insulation resistance measurement of the connected N- and L-potentials

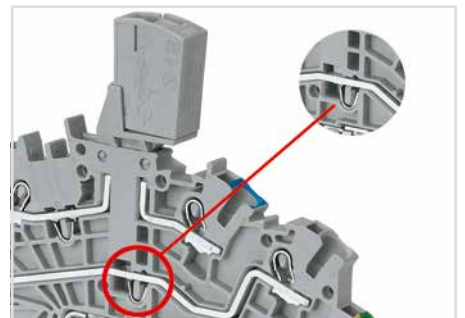

Multilevel installation terminal block fitted with an N-test plug adapter for insulation resistance measurement of the N-potential

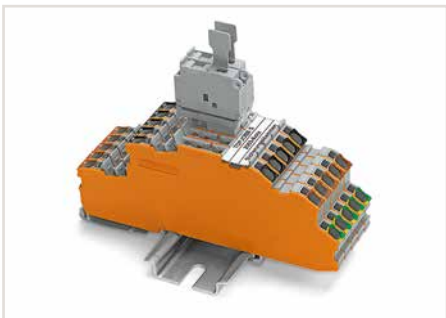

Single-fuse plugs can be used in combination with 1 mm thick end and intermediate plates on carrier terminal blocks without an N-knife disconnect.



Double-fuse plugs with 5 x 25 mm glass cartridge fuses can be used on carrier terminal blocks without an N-knife disconnect in standard terminal block width.



Commoning two potentials in one single jumper slot via extremely slim staggered jumpers.

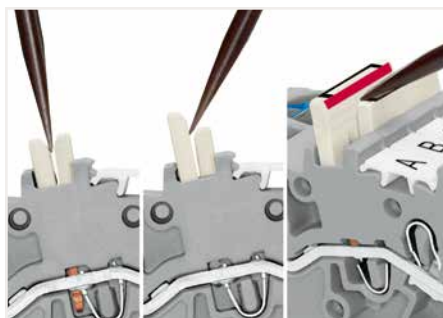

Insert the operating tool between the staggered jumpers, then lift up the jumper.



fine-stranded, tip-bonded



fine-stranded, with ferrule (gastight crimped)



fine-stranded, with pin terminal (gastight crimped)

Multilevel Installation Terminal Block TOPJOB® S; with N-Disconnect Slide Link

2.5 (4) mm²; 2003 Series

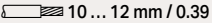
Technical Data	
0.25 ... 2.5 (4) mm ² ①	22 ... 12 AWG
250 V/4 kV/3; 32 A (32 A) ②	
400 V/6 kV/3; 32 A (32 A) ②	
Terminal block width: 5.2 mm / 0.205 inch	
 10 ... 12 mm / 0.39 ... 0.47 inch	

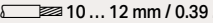
Technical Data	
0.25 ... 2.5 (4) mm ² ①	22 ... 12 AWG
400 V/6 kV/3 ②	
I _N 32 A	
Terminal block width: 5.2 mm / 0.205 inch	
 10 ... 12 mm / 0.39 ... 0.47 inch	

- ① Conductor range: 0.25 ... 4 mm² "s+f-st"; Push-in termination: 1 ... 4 mm² "s" and 1 ... 2.5 mm² "insulated ferrules, 12 mm"
Depending on the conductor characteristic, a conductor with a smaller cross section can also be inserted via push-in termination.
- ② 250 V / 400 V = rated voltage
4 kV / 6 kV = rated impulse voltage
3 = pollution degree (see Section 14)
250 V/4 kV potential – ground
400 V/6 kV potential – potential

Please observe the application notes:
Jumpers, from page 152
Testing accessories, from page 151
Marking, from page 588

Approvals and corresponding ratings, visit www.wago.com

3

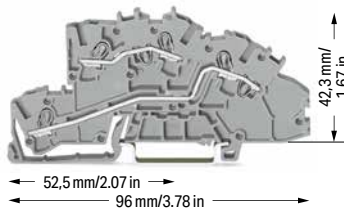
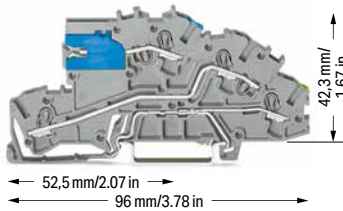

Multilevel installation terminal block; with N-disconnect slide link; gray

	Item No.	Pack. Unit
○ NT/L/PE	2003-7641	50

Multilevel installation terminal block; gray

	Item No.	Pack. Unit
○ L/L	2003-7642	50
○ N/L	2003-7649	50

Accessories; 2003 Series

Appropriate marking systems:
WMB/WMB Inline/Marking strips

Lock-out; prevents reclosing of slide link; snap-on type

	orange	2003-7300	100 (25)
---	--------	-----------	----------

Insulation stop; 5 pcs/strip; 0.25 ... 0.5 mm²

	light gray	2002-171	200 (25)
--	------------	----------	----------

Insulation stop; 5 pcs/strip; 0.75 ... 1 mm²

	dark gray	2002-172	200 (25)
---	-----------	----------	----------

Push-in type jumper bar; insulated; I_N 25 A; light gray

	2-way	2002-402	25
	3-way	2002-403	25
	4-way	2002-404	25
	5-way	2002-405	25
	6-way	2002-406	25
	7-way	2002-407	25
	8-way	2002-408	25
	9-way	2002-409	25
	10-way	2002-410	25



Push-in type jumper bar; insulated; I_N 25 A; light gray

	1 to 3	2002-433	25
	1 to 4	2002-434	25
	1 to 5	2002-435	25
	1 to 6	2002-436	25
	1 to 7	2002-437	25
	1 to 8	2002-438	25
	1 to 9	2002-439	25
	1 to 10	2002-440	25

Adjacent jumper for continuous commoning; insulated; I_N 25 A, light gray

	2-way	2002-400	25
---	-------	----------	----

Adjacent jumper for continuous commoning; insulated; I_N 25 A; 1 to 3

	light gray	2002-423	25
	red	2002-423/000-005	25
	blue	2002-423/000-006	25

Adjacent jumper for continuous commoning; insulated; I_N 25 A, light gray

	5-way	2002-415	25
---	-------	----------	----

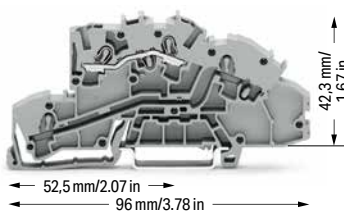
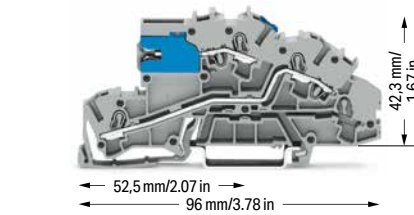

Multilevel installation terminal block; with N-disconnect slide link; gray

	Item No.	Pack. Unit
○ NT/L	2003-7640	50
○ LT/L	2003-7659	50

Multilevel installation terminal block; gray

	Item No.	Pack. Unit
○ L	2003-7650	50
○ N	2003-7651	50

Multilevel installation terminal block; gray

○ N/L/PE	2003-7646	50
○ L/L/PE	2003-7645	50

Accessories; 2003 Series

Appropriate marking systems: WMB/WMB Inline/Marking strips

End and intermediate plate; 0.8 mm thick

	orange	2003-7692	100 (25)
--	--------	-----------	----------

Busbar carrier; not suitable as an end stop; snaps onto DIN-35 rail; 1.5 mm thick

	blue	2009-304	100 (25)
--	------	----------	----------

Busbar carrier; with end stop function and detachable separator plate; snaps onto DIN-35 rail; 7.5 mm thick

	blue	2009-305	25
--	------	----------	----

Busbar cover; 1000 mm long

	transparent	777-303	1
--	-------------	---------	---

Busbar; tin-plated; 1000 mm long; copper (10 x 3) mm

	I _N 140 A	210-133	1
---	----------------------	---------	---

N-supply terminal block; I_N 76 A; 16 mm²; 12 mm wide

	blue	2016-7714	20
---	------	-----------	----

Ground supply terminal block; 16 mm²; 12 mm wide

	green-yellow	2016-7607	20
---	--------------	-----------	----

Connector; for busbar; with blue cover; 2.5 ... 16 mm²

	blue	210-281	100 (50)
---	------	---------	----------

Connector; for busbar; 2.5 ... 35 mm²

	unplated	209-105	50
---	----------	---------	----

Accessories; 2003 Series

Appropriate marking systems: WMB/WMB Inline/Marking strips

Staggered jumper; insulated; I _N 25 A; light gray			
	2-way	2002-472	25
	3-way	2002-473	25
	4-way	2002-474	25
	5-way	2002-475	25
	6-way	2002-476	25
	7-way	2002-477	25
	8-way	2002-478	25
	9-way	2002-479	25
	10-way	2002-480	25
	11-way	2002-481	25
	12-way	2002-482	25

Customized staggered jumper; insulated; with contact lugs broken off at the factory and circuit printing; I _N 25 A; light gray			
	1-3	2002-473/011-000	25
	1-3-5	2002-475/011-000	25
	1-3-5-7	2002-477/011-000	25
	1-3-5-7-9	2002-479/011-000	25
	1-3-5-7-9-11	2002-481/011-000	25

Push-in type wire jumper; insulated; 1.5 mm ² conductor cross-section; I _N 18 A			
	L = 60 mm	2009-412	100 (10)
	L = 110 mm	2009-414	100 (10)
	L = 250 mm	2009-416	100 (10)

Test plug adapter; for 4 mm Ø test plug			
	gray	2009-174	100 (25)

Banana plug; for 4 mm socket diameter; color mixed; 10 x orange, white, black, blue, yellow; max. 42 V			
		215-111	50

Testing tap; for max. 2.5 mm ²			
	gray	2009-182	100 (25)

Test plug; with 500 mm cable; 2 mm Ø; max. 42 V			
	red	210-136	50

Test plug; with 500 mm cable; 2.3 mm Ø; max. 42 V			
	yellow	210-137	50

Operating tool; 3.5 mm and 2.5 mm blade width; for Installation Terminal Blocks TOPJOB® S			
		2009-309	1

Operating tool; 3.5 mm and 5.5 mm blade width; for Installation Terminal Blocks TOPJOB® S			
		2009-310	1

WMB Inline, plain; 1,500 WMB markers (5 mm)/reel; 5 ... 5.2 mm stretchable			
	white	2009-115	1

Marking strip; plain; 11 mm wide; 50 m reel			
	white	2009-110	1

WMB marking card; white; 10 strips with 10 markers/card; 5 ... 5.2 mm stretchable			
	plain	793-5501	5

WMB marking card; plain; 10 strips with 10 markers/card; 5 ... 5.2 mm stretchable			
	yellow	793-5501/000-002	5
	red	793-5501/000-005	5
	blue	793-5501/000-006	5
	gray	793-5501/000-007	5
	orange	793-5501/000-012	5
	light green	793-5501/000-017	5
	green	793-5501/000-023	5
	violet	793-5501/000-024	5

Screwless end stop; for DIN-35 rail; 6 mm wide			
	gray	249-116	100 (25)

Screwless end stop; for DIN-35 rail; 10 mm wide			
	gray	249-117	50 (25)

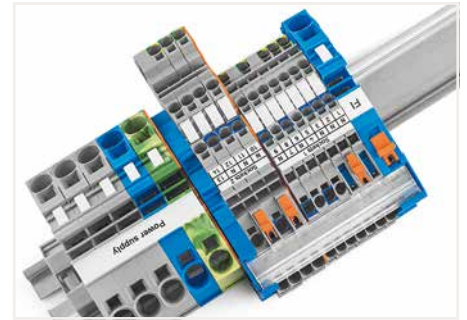

TOPJOB® S – Terminal Blocks for Every Application

- Push-in termination of solid conductors in small distribution boards saves time and money.
- Operating errors can be prevented as all Terminal Blocks for building installations are equipped with push-in connection technology.
- The use of standard accessories reduces order-processing and warehousing costs.
- The busbar position is the same, making Installation Terminal Blocks TOPJOB® S compatible with standard Installation Terminal Blocks TOPJOB®.

For the construction and operation of power installations in fire-prone, hazardous locations or public buildings – such as conference centers, stores, hospitals, schools, theaters or hotels – the DIN VDE 0100-710 or DIN VDE 0100-718 standards shall be observed. DIN VDE 0100-482 shall also be observed for fire-prone, hazardous locations. These VDE regulations mandate that every neutral conductor must be provided with a disconnection device so, e.g., insulation resistance measurement is possible for every circuit without disconnecting the N-conductor. WAGO's N-disconnect terminal blocks meet this requirement.

Application note:

N-disconnect slide links, used in installation terminal blocks, consist of switch contacts that are opened and then closed again as part of regular circuit testing. To guarantee a reliable connection, a corrosion-resistant contact area is required on the N-busbar.

Historically, uninsulated copper busbars that have been cleaned/stripped of any possible corrosion prior to install can be used in dry, pollution-free locations.

According to DIN VDE 0100-520 (VDE 0100, Part 520), installation equipment exposed to contamination or corrosive substances (e.g., water) that promote corrosion or deterioration, must be protected or made of a corrosion- or wear-resistant material. In these cases, tinned copper busbars guarantee a reliable connection.

WAGO only offers tinned copper busbars.

Multilevel Installation Terminal Block TOPJOB® S; with Internal N-Disconnection

2.5 (4) mm²; 2003 Series

Technical Data	
0.25 ... 2.5 (4) mm ² ①	22 ... 12 AWG
250 V/4 kV/3; 20 A (25 A) ②	
400 V/6 kV/3; 20 A (25 A) ②	
Terminal block width: 5.2 mm / 0.205 inch	
 10 ... 12 mm / 0.39 ... 0.47 inch	

Technical Data	
0.25 ... 2.5 (4) mm ² ①	22 ... 12 AWG
400 V/6 kV/3 ②	
I _N 24 A (28 A)	
Terminal block width: 5.2 mm / 0.205 inch	
 10 ... 12 mm / 0.39 ... 0.47 inch	

Technical Data	
0.25 ... 2.5 (4) mm ² ①	22 ... 12 AWG
250 V/4 kV/3; 24 A (28 A) ②	
400 V/6 kV/3; 24 A (28 A) ②	
Terminal block width: 5.2 mm / 0.205 inch	
 10 ... 12 mm / 0.39 ... 0.47 inch	

3

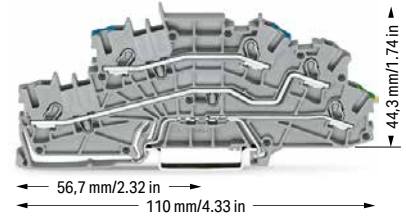
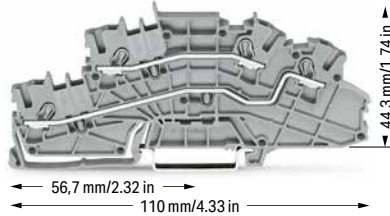
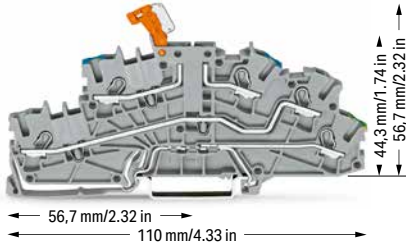



Multilevel installation terminal block; with pivoting knife disconnect; gray		
	Item No.	Pack. Unit
<input type="radio"/> NTi/L/PE	2003-6641	50
<input type="radio"/> LTi/L/PE	2003-6644	50

Multilevel installation terminal block; gray		
	Item No.	Pack. Unit
<input type="radio"/> L/L	2003-6642	50
<input type="radio"/> N/L	2003-6649	50

Multilevel installation terminal block; gray		
	Item No.	Pack. Unit
<input type="radio"/> N/L/PE	2003-6646	50
<input type="radio"/> L/L/PE	2003-6645	50

Accessories; item-specific

N/L-test plug adapter; for vertical test slot; gray			
		Item No.	Pack. Unit
	2-pole	2003-499	100 (25)

N-test plug adapter; for vertical test slot; gray			
		Item No.	Pack. Unit
	1-pole	2003-500	100 (25)

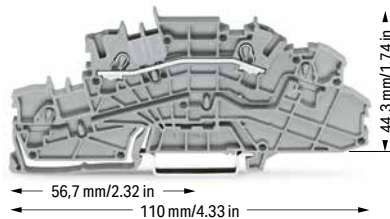

Multilevel installation terminal block; gray		
	Item No.	Pack. Unit
<input type="radio"/> L	2003-6650	50
<input type="radio"/> N	2003-6651	50

Accessories; 2003 Series

Appropriate marking systems: WMB/WMB Inline/Marking strips

End and intermediate plate; 0.8 mm thick			
		Item No.	Pack. Unit
	orange	2003-6692	100 (25)

Insulation stop; 5 pcs/strip; 0.25 ... 0.5 mm ²			
		Item No.	Pack. Unit
	light gray	2002-171	200 (25)

Insulation stop; 5 pcs/strip; 0.75 ... 1 mm ²			
		Item No.	Pack. Unit
	dark gray	2002-172	200 (25)

Push-in type jumper bar; insulated; I _N 25 A; light gray			
		Item No.	Pack. Unit
	2-way	2002-402	25
	3-way	2002-403	25
	4-way	2002-404	25
	5-way	2002-405	25
	6-way	2002-406	25
	7-way	2002-407	25
	8-way	2002-408	25
	9-way	2002-409	25
	10-way	2002-410	25

Push-in type jumper bar; insulated; I _N 25 A; light gray			
		Item No.	Pack. Unit
	1 to 3	2002-433	25
	1 to 4	2002-434	25
	1 to 5	2002-435	25
	1 to 6	2002-436	25
	1 to 7	2002-437	25
	1 to 8	2002-438	25
	1 to 9	2002-439	25
	1 to 10	2002-440	25

Push-in type wire jumper; insulated; 1.5 mm ² conductor cross-section; I _N 18 A			
		Item No.	Pack. Unit
	L = 60 mm	2009-412	100 (10)
	L = 110 mm	2009-414	100 (10)
	L = 250 mm	2009-416	100 (10)

1 Conductor range: 0.25 ... 4 mm² "s+f-st"; Push-in termination: 1 ... 4 mm² "s" and 1 ... 2.5 mm² "insulated ferrules, 12 mm"
Depending on the conductor characteristic, a conductor with a smaller cross section can also be inserted via push-in termination.

2 250 V / 400 V = rated voltage
4 kV / 6 kV = rated impulse voltage
3 = pollution degree
(see Section 14)
250 V/4 kV potential – ground
400 V/6 kV potential – potential

Please observe the application notes:
Jumpers, from page 152
Testing accessories, from page 151
Marking, from page 588

Approvals and corresponding ratings, visit www.wago.com

Accessories; 2003 Series

Appropriate marking systems:
WMB/WMB Inline/Marking strips

Staggered jumper; insulated; I_N 25 A; light gray

	2-way	2002-472	25
	3-way	2002-473	25
	4-way	2002-474	25
	5-way	2002-475	25
	6-way	2002-476	25
	7-way	2002-477	25
	8-way	2002-478	25
	9-way	2002-479	25
	10-way	2002-480	25
	11-way	2002-481	25
	12-way	2002-482	25

Customized staggered jumper; insulated; with contact lugs broken off at the factory and circuit printing; I_N 25 A; light gray

	1-3	2002-473/011-000	25
	1-3-5	2002-475/011-000	25
	1-3-5-7	2002-477/011-000	25
	1-3-5-7-9	2002-479/011-000	25
	1-3-5-7-9-11	2002-481/011-000	25

Adjacent jumper for continuous commoning; insulated; I_N 25 A, light gray

	2-way	2002-400	25
---	-------	----------	----

Adjacent jumper for continuous commoning; insulated; I_N 25 A; 1 to 3

	light gray	2002-423	25
	red	2002-423/000-005	25
	blue	2002-423/000-006	25

Adjacent jumper for continuous commoning; insulated; I_N 25 A, light gray

	5-way	2002-415	25
---	-------	----------	----

Test plug adapter; for 4 mm Ø test plug

	gray	2009-174	100 (25)
---	------	----------	----------

Banana plug; for 4 mm socket diameter; color mixed; 10 x orange, white, black, blue, yellow; max. 42 V

	215-111	50
---	---------	----

Testing tap; for max. 2.5 mm²

	gray	2009-182	100 (25)
---	------	----------	----------

Accessories; 2003 Series

Appropriate marking systems:
WMB/WMB Inline/Marking strips

WMB Inline, plain; 1,500 WMB markers (5 mm)/reel; 5 ... 5.2 mm stretchable

	white	2009-115	1
---	-------	----------	---

Marking strip; plain; 11 mm wide; 50 m reel

	white	2009-110	1
---	-------	----------	---

WMB marking card; white; 10 strips with 10 markers/card; 5 ... 5.2 mm stretchable

	plain	793-5501	5
---	-------	----------	---

WMB marking card; plain; 10 strips with 10 markers/card; 5 ... 5.2 mm stretchable

	yellow	793-5501/000-002	5
	red	793-5501/000-005	5
	blue	793-5501/000-006	5
	gray	793-5501/000-007	5
	orange	793-5501/000-012	5
	light green	793-5501/000-017	5
	green	793-5501/000-023	5
	violet	793-5501/000-024	5

Screwless end stop; for DIN-35 rail; 6 mm wide

	gray	249-116	100 (25)
---	------	---------	----------

Screwless end stop; for DIN-35 rail; 10 mm wide

	gray	249-117	50 (25)
---	------	---------	---------

Operating tool; 3.5 mm and 2.5 mm blade width; for Installation Terminal Blocks TOPJOB® S

	2009-309	1
---	----------	---

Operating tool; 3.5 mm and 5.5 mm blade width; for Installation Terminal Blocks TOPJOB® S

	2009-310	1
---	----------	---

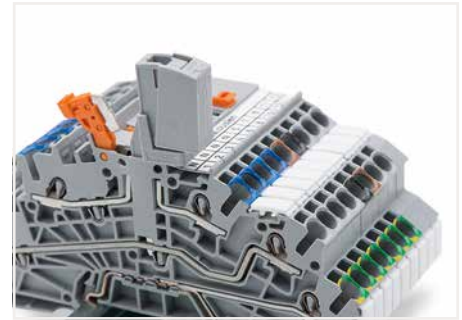

For multilevel installation terminal blocks with internal N-disconnection, test plug adapters can be inserted into the free vertical test slot when the N-potential is disconnected.

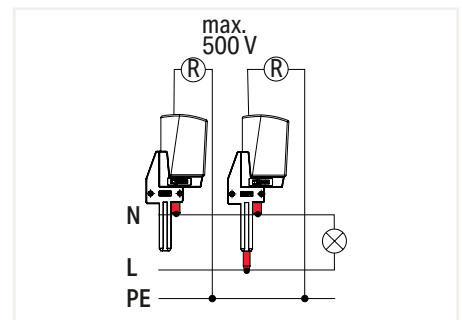

Test plug adapters for both individual N-potential measurement and insulation resistance measurement of the connected N- and L-potentials are available.

Multilevel Installation Terminal Block TOPJOB® S

2.5 (4) mm²; 2003 Series

Technical Data

0.25 ... 2.5 (4) mm² ① | 22 ... 12 AWG
 250 V/4 kV/3; 10 A ②
 400 V/6 kV/3; 10 A ②
 Terminal block width: 5.2 mm / 0.205 inch
 10 ... 12 mm / 0.39 ... 0.47 inch

Technical Data

0.25 ... 2.5 (4) mm² ① | 22 ... 12 AWG
 250 V/4 kV/3; 10 A ②
 400 V/6 kV/3; 10 A ②
 Terminal block width: 5.2 mm / 0.205 inch
 10 ... 12 mm / 0.39 ... 0.47 inch

① Conductor range: 0.25 ... 4 mm² "s+f-st";
 Push-in termination: 1 ... 4 mm² "s" and 1 ... 2.5 mm² "insulated ferrules, 12 mm"
 Depending on the conductor characteristic, a conductor with a smaller cross section can also be inserted via push-in termination.

② 250 V / 400 V = rated voltage
 4 kV / 6 kV = rated impulse voltage
 3 = pollution degree
 (see Section 14)
 250 V/4 kV potential – ground
 400 V/6 kV potential – potential











Please observe the application notes:
 Jumpers, from page 152
 Testing accessories, from page 151
 Marking, from page 588

Approvals and corresponding ratings, visit www.wago.com

Accessories; 2003 Series

Appropriate marking systems:
 WMB/WMB Inline/Marking strips

Staggered jumper; insulated; I_N 25 A; light gray

	2-way	2002-472	25
	3-way	2002-473	25
	4-way	2002-474	25
	5-way	2002-475	25
	6-way	2002-476	25
	7-way	2002-477	25
	8-way	2002-478	25
	9-way	2002-479	25
	10-way	2002-480	25
	11-way	2002-481	25
	12-way	2002-482	25



Customized staggered jumper; insulated; with contact lugs broken off at the factory and circuit printing; I_N 25 A; light gray

	1-3	2002-473/011-000	25
	1-3-5	2002-475/011-000	25
	1-3-5-7	2002-477/011-000	25
	1-3-5-7-9	2002-479/011-000	25
	1-3-5-7-9-11	2002-481/011-000	25

Adjacent jumper for continuous commoning; insulated; I_N 25 A, light gray

	2-way	2002-400	25
---	-------	----------	----

Adjacent jumper for continuous commoning; insulated; I_N 25 A; 1 to 3

	light gray	2002-423	25
	red	2002-423/000-005	25
	blue	2002-423/000-006	25

Adjacent jumper for continuous commoning; insulated; I_N 25 A, light gray

	5-way	2002-415	25
---	-------	----------	----

Test plug adapter; for 4 mm Ø test plug

	gray	2009-174	100 (25)
---	------	----------	----------

Banana plug; for 4 mm socket diameter; color mixed; 10 x orange, white, black, blue, yellow; max. 42 V

		215-111	50
---	--	---------	----

Testing tap; for max. 2.5 mm²

	gray	2009-182	100 (25)
---	------	----------	----------

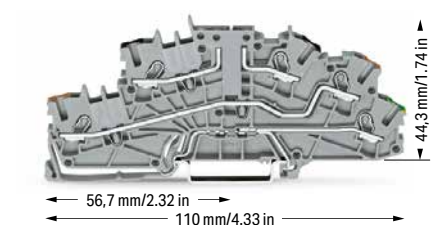
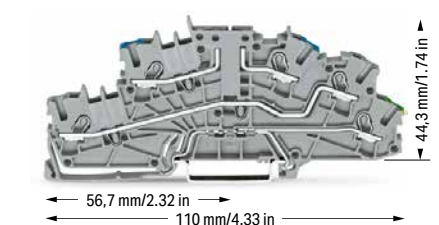

Multilevel installation terminal block; carrier terminal block without knife disconnect; gray
 Maximum current depends on accessories used.

	Item No.	Pack. Unit
	2003-6640	50

Multilevel installation terminal block; carrier terminal block without knife disconnect; black upper-deck, brown middle-deck, green-yellow lower-deck printing
 Maximum current depends on accessories used.

	Item No.	Pack. Unit
	2003-6643	50

Multilevel installation terminal block; carrier terminal block without knife disconnect; blue middle-deck; green-yellow lower-deck printing; gray

	2003-6661	50
--	-----------	----

Multilevel installation terminal block; carrier terminal block without knife disconnect; brown upper-deck, black middle-deck, green-yellow lower-deck printing

	2003-6660	50
---	-----------	----

Accessories; 2003 Series

Appropriate marking systems: WMB/WMB Inline/Marking strips

N/L-test plug adapter; for vertical test slot; gray

	2-pole	2003-499	100 (25)
--	--------	----------	----------

N-test plug adapter; for vertical test slot; gray

	1-pole	2003-500	100 (25)
--	--------	----------	----------

End and intermediate plate; 0.8 mm thick

	orange	2003-6692	100 (25)
--	--------	-----------	----------

Fuse plug with pull-tab; for 5 x 20 mm glass cartridge fuse Electrical ratings are given by the fuse.

	gray	2004-911	50
--	------	----------	----

End and intermediate plate; only for use with fuse plugs; 1 mm thick

	orange	2003-6693	100 (25)
--	--------	-----------	----------

Double-fuse plug; for 5 x 20 mm glass cartridge fuse Electrical ratings are given by the fuse.

	gray	2003-911	25
--	------	----------	----



End and intermediate plate; 1 mm thick; only for use with double-fuse plugs

	orange	2003-6694	100 (25)
---	--------	-----------	----------

Push-in type jumper bar; insulated; I_N 25 A; light gray

	2-way	2002-402	25
	3-way	2002-403	25
	4-way	2002-404	25
	5-way	2002-405	25
	6-way	2002-406	25
	7-way	2002-407	25
	8-way	2002-408	25
	9-way	2002-409	25
	10-way	2002-410	25

Push-in type jumper bar; insulated; I_N 25 A; light gray

	1 to 3	2002-433	25
	1 to 4	2002-434	25
	1 to 5	2002-435	25
	1 to 6	2002-436	25
	1 to 7	2002-437	25
	1 to 8	2002-438	25
	1 to 9	2002-439	25
	1 to 10	2002-440	25

Push-in type wire jumper; insulated; 1.5 mm² conductor cross-section; I_N 18 A

	L = 60 mm	2009-412	100 (10)
	L = 110 mm	2009-414	100 (10)
	L = 250 mm	2009-416	100 (10)

Accessories; 2003 Series

Appropriate marking systems:
WMB/WMB Inline/Marking strips

WMB Inline, plain; 1,500 WMB markers (5 mm)/reel;
5 ... 5.2 mm stretchable

white 2009-115 1

Marking strip; plain; 11 mm wide; 50 m reel

white 2009-110 1

WMB marking card; white; 10 strips with 10 markers/card;
5 ... 5.2 mm stretchable

plain 793-5501 5

WMB marking card; plain; 10 strips with 10 markers/card;
5 ... 5.2 mm stretchable

	yellow	793-5501/000-002	5
	red	793-5501/000-005	5
	blue	793-5501/000-006	5
	gray	793-5501/000-007	5
	orange	793-5501/000-012	5
	light green	793-5501/000-017	5
	green	793-5501/000-023	5
	violet	793-5501/000-024	5

Screwless end stop; for DIN-35 rail; 6 mm wide

gray 249-116 100 (25)

Screwless end stop; for DIN-35 rail; 10 mm wide

gray 249-117 50 (25)

Operating tool; 3.5 mm and 2.5 mm blade width; for
Installation Terminal Blocks TOPJOB® S

2009-309 1

Operating tool; 3.5 mm and 5.5 mm blade width; for
Installation Terminal Blocks TOPJOB® S

2009-310 1

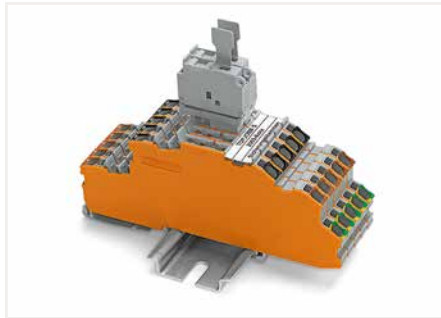

Single-fuse plugs can be used in combination with 1 mm thick end and intermediate plates on carrier terminal blocks without an N-knife disconnect.

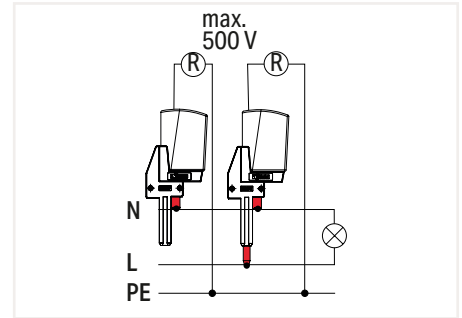

Test plug adapters for both individual N-potential measurement and insulation resistance measurement of the connected N- and L-potentials are available.

3

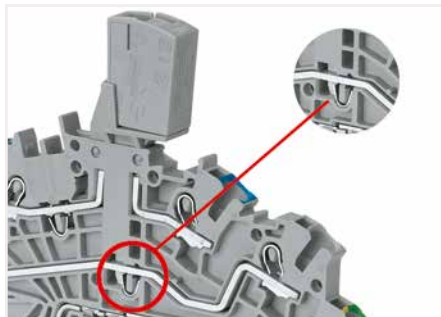

Multilevel installation terminal block fitted with an N/L-test plug adapter for quick and safe insulation resistance measurement of the connected N- and L-potentials

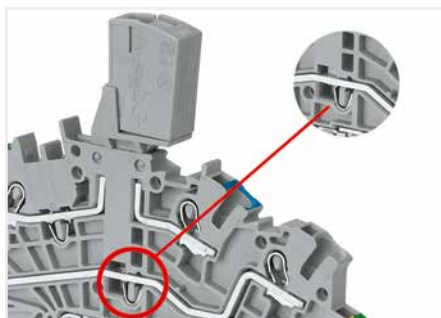

Multilevel installation terminal block fitted with an N-test plug adapter for insulation resistance measurement of the N-potential

Double-Fuse Plug TOPJOB® S on Carrier Terminal Block 2.5 (4) mm² 2003 Series

Technical Data

250 V / I_n 6.3 A

Plug width: 10.4 mm / 0.409 inch



Technical Data

250 V / I_n 6.3 A

Plug width: 10.4 mm / 0.409 inch



Length for 2002-1661 – 66.5 mm / 2.62 inch
2-conductor carrier terminal block

Length for 2002-1761 – 76.8 mm / 3.02 inch
3-conductor carrier terminal block

Length for 2002-1861 – 87.5 mm / 3.45 inch
4-conductor carrier terminal block

Length for 2002-1961 – 72.9 mm / 2.87 inch
2-conductor carrier terminal block with additional jumper slot

Length for 2002-2961 – 108 mm / 4.25 inch
Double-deck carrier terminal block

Length for 2003-6640 – 110 mm / 4.33 inch
Multilevel Installation Terminal Block

Approvals and corresponding ratings, visit www.wago.com

Accessories; for fuse plugs

Appropriate marking systems:
WMB/Marking strips

Multilevel installation terminal block;
0.25 ... 2.5 (4) mm² / 22 ... 12 AWG
Terminal block width: 5.2 mm / 0.205 inch

N/L/PE 2003-6640 50



Multilevel installation terminal block;
0.25 ... 2.5 (4) mm² / 22 ... 12 AWG
Terminal block width: 5.2 mm / 0.205 inch

L/N/PE 2003-6661 50



Multilevel installation terminal block;
0.25 ... 2.5 (4) mm² / 22 ... 12 AWG
Terminal block width: 5.2 mm / 0.205 inch

P2/P1/PE 2003-6643 50



Multilevel installation terminal block;
0.25 ... 2.5 (4) mm² / 22 ... 12 AWG
Terminal block width: 5.2 mm / 0.205 inch

P1/P2/PE 2003-6660 50



End and intermediate plate; 0.8 mm thick

orange 2003-6692 100 (25)



End and intermediate plate; 1 mm thick; only for use with double-fuse plugs

orange 2003-6694 100 (25)



WMB marking card; white; 10 strips with 10 markers/card; 5 ... 5.2 mm stretchable

plain 793-5501 5



WMB marking card; plain; 10 strips with 10 markers/card; 5 ... 5.2 mm stretchable

yellow 793-5501/000-002 5

red 793-5501/000-005 5

blue 793-5501/000-006 5

gray 793-5501/000-007 5

orange 793-5501/000-012 5

light green 793-5501/000-017 5

green 793-5501/000-023 5

violet 793-5501/000-024 5

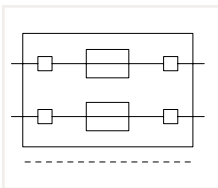

Double-fuse plug; for 5 x 20 mm glass cartridge fuse
Electrical ratings are given by the fuse.

Color	Item No.	Pack. Unit
○ gray	2003-911	50

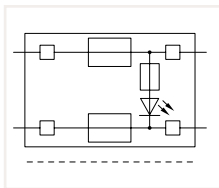

Double-fuse plug; for 5 x 20 mm glass cartridge fuse; with LED; gray
Electrical ratings are given by the fuse and blown fuse indication. Leakage current in case of a blown fuse: LED 0.25 mA

○ 230 V	Item No.	Pack. Unit
	2003-911/1000-923	50

Accessories; for fuse plugs

Appropriate marking systems: WMB/Marking strips

2-conductor carrier terminal block;
0.25 ... 2.5 (4) mm² / 22 ... 12 AWG
Terminal block width: 5.2 mm / 0.205 inch

gray 2002-1661 50



2-conductor carrier terminal block;
0.25 ... 2.5 (4) mm² / 22 ... 12 AWG
Terminal block width: 5.2 mm / 0.205 inch

gray 2002-1961 50



End and intermediate plate; 1 mm thick

orange 2002-1692 100 (25)

gray 2002-1691 100 (25)



End and intermediate plate; 1 mm thick

orange 2002-1992 100 (25)

gray 2002-1991 100 (25)



3-conductor carrier terminal block;
0.25 ... 2.5 (4) mm² / 22 ... 12 AWG
Terminal block width: 5.2 mm / 0.205 inch

gray 2002-1761 50



Double-deck carrier terminal block;
0.25 ... 2.5 (4) mm² / 22 ... 12 AWG
Terminal block width: 5.2 mm / 0.205 inch

L/L 2002-2961 50



End and intermediate plate; 1 mm thick

orange 2002-1792 100 (25)

gray 2002-1791 100 (25)



Double-deck carrier terminal block;
0.25 ... 2.5 (4) mm² / 22 ... 12 AWG
Terminal block width: 5.2 mm / 0.205 inch

L/N 2002-2963 50



4-conductor carrier terminal block;
0.25 ... 2.5 (4) mm² / 22 ... 12 AWG
Terminal block width: 5.2 mm / 0.205 inch

gray 2002-1861 50



Double-deck carrier terminal block;
0.25 ... 2.5 (4) mm² / 22 ... 12 AWG
Terminal block width: 5.2 mm / 0.205 inch

L/L 2002-2941 50



End and intermediate plate; 1 mm thick

orange 2002-1892 100 (25)

gray 2002-1891 100 (25)



End and intermediate plate; 1 mm thick

orange 2002-2992 100 (25)

gray 2002-2991 100 (25)



End plate for fuse terminal blocks; 2 mm thick

orange 2002-992 100 (25)

gray 2002-991 100 (25)



Shorting link; 5 x 20 mm; allows the fuse plug to be used as a disconnect plug

I_n 6.3 A 281-503 250 (25)





Double-fuse plugs with 5 x 25 mm glass cartridge fuses can be used on carrier terminal blocks without an N-knife disconnect in standard terminal block width.

Glass cartridge fuses 5 x 20				
Series Item No.	Overload and short circuit protection		Short circuit protection only	
	Individual argmt.	Group argmt.	Individual argmt.	Group argmt.
Fuse terminal blocks				
2003-911				
2003-911/.....	1.6 W	1.6 W	2.5 W	2.5 W

When selecting glass cartridge fuses, make sure that the maximum power loss listed below is not exceeded. The power loss is determined according to IEC or EN 60947-7-3/VDE 0611-6 at 23°C. The temperature rise of the terminal blocks must be checked according to their application and mounting. Higher ambient temperatures represent an additional impact on fuse cartridges. Therefore, in such applications, the rated current must be reduced if necessary. More details are available from the manufacturers.

Multilevel Installation Terminal Block TOPJOB® S; with N-Disconnect Slide Link

4 (6) mm²; 2005 Series

Technical Data	
0.5 ... 4 (6) mm ² ①	20 ... 10 AWG
250 V/4 kV/3; 36 A (36 A) ②	
400 V/6 kV/3; 36 A (36 A) ②	
Terminal block width: 6.2 mm / 0.244 inch	
11 ... 13 mm / 0.43 ... 0.51 inch	

Technical Data	
0.5 ... 4 (6) mm ² ①	20 ... 10 AWG
400 V/6 kV/3 ②	
I _N 36 A	
Terminal block width: 6.2 mm / 0.244 inch	
11 ... 13 mm / 0.43 ... 0.51 inch	

① Conductor range: 0.5 ... 6 mm² "s+f-st"; Push-in termination: 1.5 ... 6 mm² "s" and 1.5 ... 4 mm² "insulated ferrules; 12 mm"
Depending on the conductor characteristic, a conductor with a smaller cross section can also be inserted via push-in termination.

② 250 V/400 V = rated voltage
4 kV/6 kV = rated impulse voltage
3 = pollution degree (see Section 14)
250 V/4 kV potential – ground
400 V/6 kV potential – potential

Please observe the application notes:
Testing accessories, from page 151
Marking, from page 588

Approvals and corresponding ratings, visit www.wago.com

3

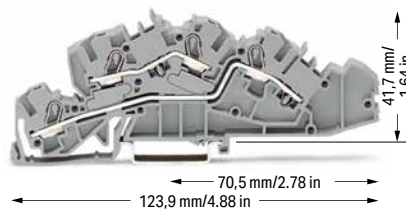
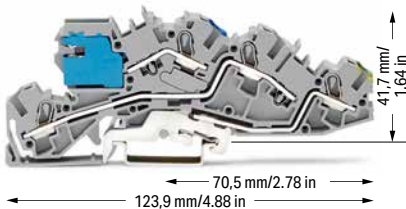

Multilevel installation terminal block; with N-disconnect slide link; gray

	Item No.	Pack. Unit
○ N/L/PE	2005-7641	50

Multilevel installation terminal block; gray

	Item No.	Pack. Unit
○ L/L	2005-7642	50
○ N/L	2005-7649	50

Accessories; 2005 Series

Appropriate marking systems:
WMB/Marking strips

Insulation stop; 5 pcs/strip; 0.25 ... 0.5 mm²

light gray	2004-171	200 (25)
------------	----------	----------

Insulation stop; 5 pcs/strip; 0.75 ... 1 mm²

dark gray	2004-172	200 (25)
-----------	----------	----------

Push-in type jumper bar; insulated; I_N 32 A; light gray

2-way	2004-402	25
3-way	2004-403	25
4-way	2004-404	25
5-way	2004-405	25
6-way	2004-406	25
7-way	2004-407	25
8-way	2004-408	25
9-way	2004-409	25
10-way	2004-410	25

Push-in type jumper bar; insulated; I_N 32 A; light gray

1 to 3	2004-433	25
1 to 4	2004-434	25
1 to 5	2004-435	25
1 to 6	2004-436	25
1 to 7	2004-437	25
1 to 8	2004-438	25
1 to 9	2004-439	25
1 to 10	2004-440	25

Test plug adapter; for 4 mm Ø test plug

gray	2009-174	100 (25)
------	----------	----------

Banana plug; for 4 mm socket diameter; color mixed; 10 x orange, white, black, blue, yellow; max. 42 V

	215-111	50
--	---------	----

Testing tap; for max. 2.5 mm²

gray	2009-182	100 (25)
------	----------	----------

Test plug; with 500 mm cable; 2 mm Ø; max. 42 V

red	210-136	50
-----	---------	----

Test plug; with 500 mm cable; 2.3 mm Ø; max. 42 V

	210-137	50
--	---------	----

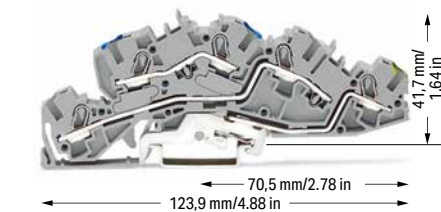

Multilevel installation terminal block; with N-disconnect slide link; gray

	Item No.	Pack. Unit
○ N/L/PE	2005-7646	50

Multilevel installation terminal block; gray

	Item No.	Pack. Unit
○ L/L/PE	2005-7645	50

Accessories; 2005 Series

Appropriate marking systems: WMB/Marking strips

End and intermediate plate; 1 mm thick

orange	2005-7692	100 (25)
--------	-----------	----------



Busbar carrier; not suitable as an end stop; snaps onto DIN-35 rail; 1.5 mm thick

blue	2009-304	100 (25)
------	----------	----------



Busbar carrier; with end stop function and detachable separator plate; snaps onto DIN-35 rail; 7.5 mm thick

blue	2009-305	25
------	----------	----



Busbar cover; 1000 mm long

transparent	777-303	1
-------------	---------	---



Busbar; tin-plated; 1000 mm long; copper (10 x 3) mm

I _N 140 A	210-133	1
----------------------	---------	---



Lock-out; prevents reclosing of slide link; snap-on type

orange	2005-7300	100 (25)
--------	-----------	----------



N-supply terminal block; I_N 76 A; 16 mm²; 12 mm wide

blue	2016-7714	20
------	-----------	----



Ground supply terminal block; 16 mm²; 12 mm wide

green-yellow	2016-7607	20
--------------	-----------	----



Connector; for busbar; with blue cover; 2.5 ... 16 mm²

blue	210-281	100 (50)
------	---------	----------



Connector; for busbar; 2.5 ... 35 mm²

unplated	209-105	50
----------	---------	----



Accessories; 2005 Series

Appropriate marking systems:
WMB/Marking strips

Marking strip; plain; 11 mm wide; 50 m reel

white 2009-110 1

WMB marking card; white; 10 strips with 10 markers/card; 5 ... 5.2 mm stretchable

plain 793-5501 5

WMB marking card; plain; 10 strips with 10 markers/card; 5 ... 5.2 mm stretchable

yellow	793-5501/000-002	5
red	793-5501/000-005	5
blue	793-5501/000-006	5
gray	793-5501/000-007	5
orange	793-5501/000-012	5
light green	793-5501/000-017	5
green	793-5501/000-023	5
violet	793-5501/000-024	5

Screwless end stop; for DIN-35 rail; 6 mm wide

gray 249-116 100 (25)

**Screwless end stop; for DIN-35 rail; 10 mm wide**

gray 249-117 50 (25)

**Operating tool; 3.5 mm and 2.5 mm blade width; for Installation Terminal Blocks TOPJOB® S**

2009-309 1

**Operating tool; 3.5 mm and 5.5 mm blade width; for Installation Terminal Blocks TOPJOB® S**

2009-310 1

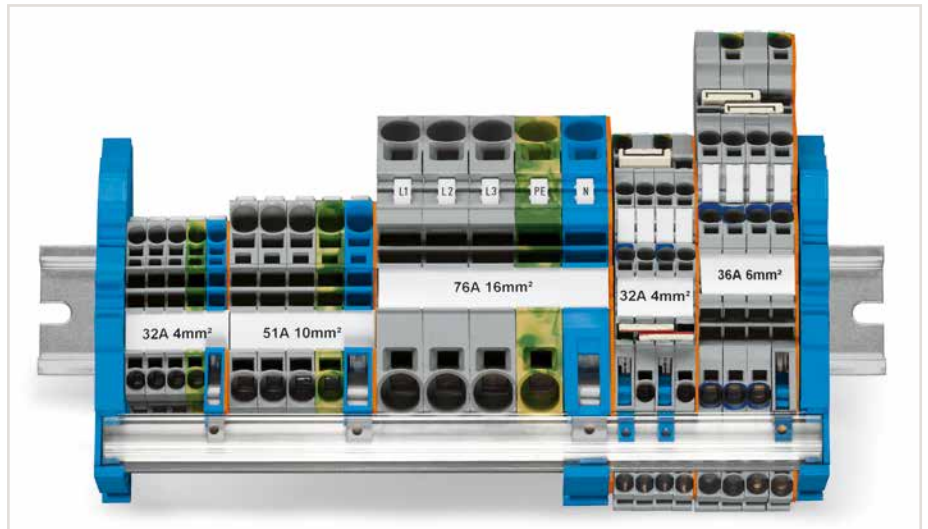
**Application note:**

N-disconnect slide links, used in installation terminal blocks, consist of switch contacts that are opened and then closed again as part of regular circuit testing. To guarantee a reliable connection, a corrosion-resistant contact area is required on the N-busbar.

Historically, uninsulated copper busbars that have been cleaned/stripped of any possible corrosion prior to install can be used in dry, pollution-free locations.

According to DIN VDE 0100-520 (VDE 0100, Part 520), installation equipment exposed to contamination or corrosive substances (e.g., water) that promote corrosion or deterioration, must be protected or made of a corrosion- or wear-resistant material. In these cases, tinned copper busbars guarantee a reliable connection.

WAGO only offers tinned copper busbars.

N-Disconnect Terminal Block and Power Distribution Disconnect Terminal Block TOPJOB® S 2002 Series; 2006 Series; 2010 Series; 2016 Series

Technical Data	
0.25 ... 2.5 (4) mm ² ①	22 ... 12 AWG
250 V/4 kV/3 ⑤	
I _N 32 A	
Terminal block width: 5.2 mm / 0.205 inch	
 10 ... 12 mm / 0.39 ... 0.47 inch	

Technical Data	
0.5 ... 6 (10) mm ² ②	20 ... 8 AWG
250 V/4 kV/3 ⑤	
I _N 51 A	
Terminal block width: 7.5 mm / 0.295 inch	
 13 ... 15 mm / 0.51 ... 0.59 inch	

Technical Data	
0.5 ... 10 (16) mm ² ③	20 ... 6 AWG
250 V/4 kV/3 ⑤	
I _N 57 A	
Terminal block width: 10 mm / 0.394 inch	
 17 ... 19 mm / 0.67 ... 0.91 inch	

3

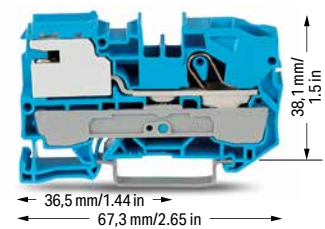
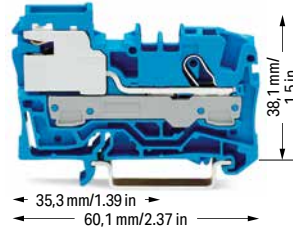
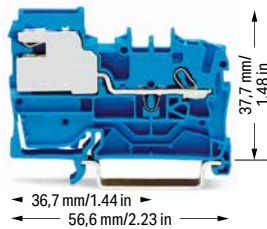



1-conductor N-disconnect terminal block		
Color	Item No.	Pack. Unit
 blue	2002-7114	50

1-conductor N-disconnect terminal block		
Color	Item No.	Pack. Unit
 blue	2006-7114	50

1-conductor N-disconnect terminal block		
Color	Item No.	Pack. Unit
 blue	2010-7114	25

1-conductor power distribution disconnect terminal block		
Color	Item No.	Pack. Unit
 gray	2002-7111	50

1-conductor power distribution disconnect terminal block		
Color	Item No.	Pack. Unit
 gray	2006-7111	50

1-conductor power distribution disconnect terminal block		
Color	Item No.	Pack. Unit
 gray	2010-7111	25

Appropriate through and ground conductor terminal blocks, see page 50

Appropriate through and ground conductor terminal blocks, see page 56

Appropriate through and ground conductor terminal blocks, see page 57

Accessories; item-specific			
End and intermediate plate; 0.8 mm thick			
Color	Item No.	Pack. Unit	
 orange	2002-7192	100 (25)	

Accessories; item-specific			
End and intermediate plate; 1 mm thick			
Color	Item No.	Pack. Unit	
 orange	2006-7192	100 (25)	

Accessories; item-specific			
End and intermediate plate; 1 mm thick			
Color	Item No.	Pack. Unit	
 orange	2010-7192	100 (25)	

Lock-out; prevents reclosing of slide link; snap-on type			
Color	Item No.	Pack. Unit	
 orange	2005-7300	100 (25)	

Lock-out; prevents reclosing of slide link; snap-on type			
Color	Item No.	Pack. Unit	
 orange	2006-7300	100 (25)	

Lock-out; prevents reclosing of slide link; snap-on type			
Color	Item No.	Pack. Unit	
 orange	2006-7300	100 (25)	

Accessories; for N-conductor and power distribution disconnect terminal blocks
Appropriate marking systems: WMB/Marking strips

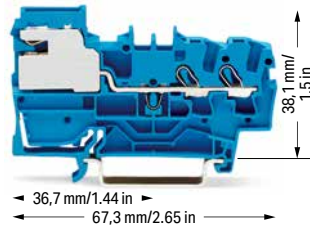

Busbar carrier; not suitable as an end stop; snaps onto DIN-35 rail; 1.5 mm thick		
Color	Item No.	Pack. Unit
 blue	2009-304	100 (25)

Test plug; with 500 mm cable; 2 mm Ø; max. 42 V		
Color	Item No.	Pack. Unit
 red	210-136	50

Busbar carrier; with end stop function and detachable separator plate; snaps onto DIN-35 rail; 7.5 mm thick		
Color	Item No.	Pack. Unit
 blue	2009-305	25

Test plug; with 500 mm cable; 2.3 mm Ø; max. 42 V		
Color	Item No.	Pack. Unit
 yellow	210-137	50

2-conductor N-disconnect terminal block		
Color	Item No.	Pack. Unit
 blue	2002-7214	50

Busbar; tin-plated; 1000 mm long; copper (10 x 3) mm		
I _N	Item No.	Pack. Unit
140 A	210-133	1

Marking strip; plain; 11 mm wide; 50 m reel		
Color	Item No.	Pack. Unit
 white	2009-110	1

2-conductor power distribution disconnect terminal block		
Color	Item No.	Pack. Unit
 gray	2002-7211	50

Busbar cover; 1000 mm long		
Color	Item No.	Pack. Unit
transparent	777-303	1

WMB marking card; white; 10 strips with 10 markers/card; 5 ... 5.2 mm stretchable		
Color	Item No.	Pack. Unit
plain	793-5501	5

Accessories; item-specific			
End and intermediate plate; 0.8 mm thick			
Color	Item No.	Pack. Unit	
 orange	2002-7292	100 (25)	

Connector; for busbar; 2.5 ... 35 mm ²		
Color	Item No.	Pack. Unit
unplated	209-105	1

Lock-out; prevents reclosing of slide link; snap-on type			
Color	Item No.	Pack. Unit	
 orange	2005-7300	100 (25)	

Connector; for busbar; with blue cover; 2.5 ... 16 mm ²		
Color	Item No.	Pack. Unit
blue	210-281	100 (50)

Technical Data

0.5 ... 16 (25 "f-st") mm² ③ | 20 ... 4 AWG

250 V/4 kV/3 ⑤

I_N 65 A

Terminal block width: 12 mm / 0.472 inch

18 ... 20 mm / 0.71 ... 0.79 inch

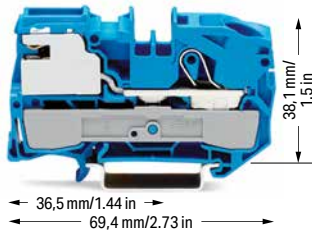

1-conductor N-disconnect terminal block

Color	Item No.	Pack. Unit
● blue	2016-7114	25

1-conductor power distribution disconnect terminal block

○ gray	2016-7111	25
--------	-----------	----

Appropriate through and ground conductor terminal blocks, see page 58

Accessories; item-specific

End and intermediate plate; 1 mm thick

orange	2016-7192	100 (25)
--------	-----------	----------

Lock-out; prevents reclosing of slide link; snap-on type

orange	2006-7300	100 (25)
--------	-----------	----------

- Conductor range: 0.25 ... 4 mm² "s+f-st";
Push-in termination: 1 ... 4 mm² "s" and 1 ... 2.5 mm² "insulated ferrules; 12 mm"
Depending on the conductor characteristic, a conductor with a smaller cross section can also be inserted via push-in termination.
 - Conductor range: 0.5 ... 10 mm² "s+f-st";
Push-in termination: 2.5 ... 10 mm² "s" and 2.5 ... 6 mm² "insulated ferrules; 12 mm"
Depending on the conductor characteristic, a conductor with a smaller cross section can also be inserted via push-in termination.
 - Conductor range: 0.5 ... 16 mm² "s+f-st";
Push-in termination: 4 ... 16 mm² "s" and 4 ... 10 mm² "insulated ferrules; 18 mm"
Depending on the conductor characteristic, a conductor with a smaller cross section can also be inserted via push-in termination.
 - Conductor range: 0.5 ... 16 mm² "s+f-st", 25 mm² "f-st";
Push-in termination: 6 ... 16 mm² "s" and 6 ... 16 mm² "insulated ferrules; 18 mm"
Depending on the conductor characteristic, a conductor with a smaller cross section can also be inserted via push-in termination.
 - 250 V = rated voltage
4 kV = rated impulse voltage
3 = pollution degree
(see Section 14)
- Approvals and corresponding ratings, visit www.wago.com

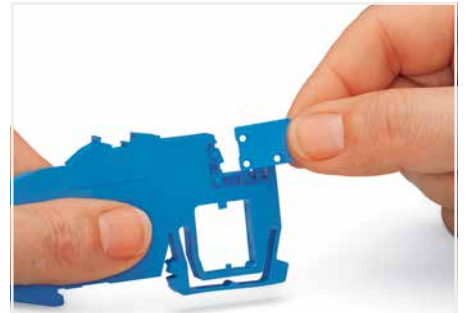

Inserting the separator plate into the busbar carrier to protect the N-busbar against accidental contact.

3

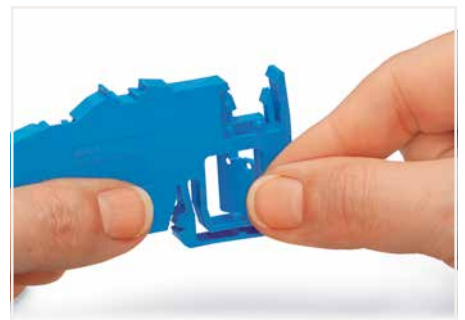

Removing the separator plate from the busbar carrier or from the N-disconnect terminal block.



Inserting separator plate removed from N-disconnect terminal block.

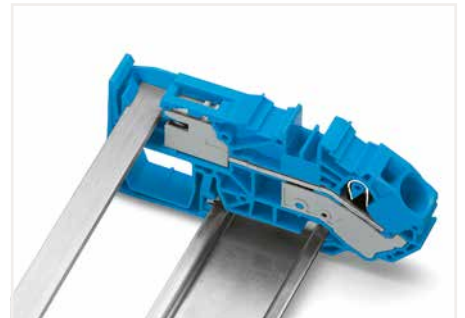

Touch-proof N-busbar via inserted separator plate

N-conductor disconnect terminal blocks:

For the construction and operation of power installations in fire-prone, hazardous locations or public buildings – such as conference centers, stores, hospitals, schools, theaters or hotels – the DIN VDE 0100-710 or DIN VDE 0100-718 standards shall be observed. DIN VDE 0100-482 shall also be observed for fire-prone, hazardous locations. These VDE regulations mandate that every neutral conductor must be provided with a disconnection device so, e.g., insulation testing is possible for every circuit without disconnecting the N-conductor. WAGO's N-disconnect terminal blocks meet this requirement.

Power distribution disconnect terminal blocks:

According to DIN VDE 0100-710, "Requirements for operating facilities, rooms and special installations – medical facilities," equipotential bonding conductors shall be run on a potential equalization busbar. The potential equalization busbar and the protective ground conductor busbar must be mounted in a common housing and be connected to each other using a disconnectable copper conductor of minimum 16 mm² (6 AWG). Furthermore, all equipotential bonding conductors must be connected to the potential equalization busbar and clearly arranged so they can be disconnected individually and accessed at any time. Depending on their function, they must be provided with captive marking. WAGO's power distribution disconnect terminal blocks meet these requirements.

PUSH-IN CAGE CLAMP®

Supply Terminal Block for Distribution Boxes/Ground/N-Disconnect and Power Distribution Disconnect Terminal Block TOPJOB® S

16 (25 "f-st") mm²; 2016 Series

Technical Data

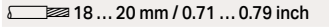
0.5 ... 16 (25 "f-st") mm² ① | 20 ... 4 AWG
 800 V/8 kV/3 ②
 I_N 76 A
 Terminal block width: 12 mm / 0.472 inch
 18 ... 20 mm / 0.71 ... 0.79 inch

Technical Data

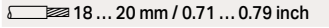
0.5 ... 16 (25 "f-st") mm² ① | 20 ... 4 AWG
 250 V/4 kV/3 ③
 I_N 76 A
 Terminal block width: 12 mm / 0.472 inch
 18 ... 20 mm / 0.71 ... 0.79 inch

① Conductor range: 0.5 ... 16 mm² "s+f-st", 25 mm² "f-st"; Push-in termination: 6 ... 16 mm² "s" and 6 ... 16 mm² "insulated ferrules; 18 mm"
 Depending on the conductor characteristic, a conductor with a smaller cross section can also be inserted via push-in termination.

② 800 V = rated voltage
 8 kV = rated impulse voltage
 3 = pollution degree
 (see Section 14)



③ 250 V = rated voltage
 4 kV = rated impulse voltage
 3 = pollution degree
 (see Section 14)

Approvals and corresponding ratings, visit www.wago.com

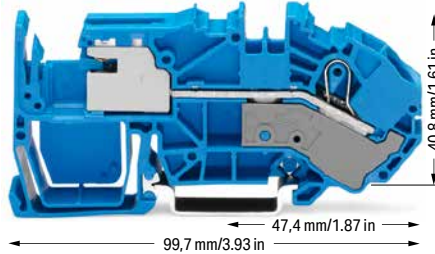
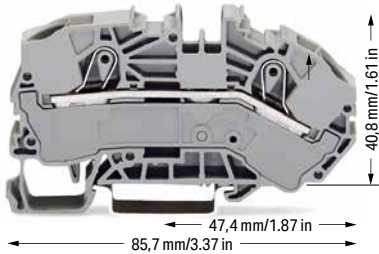
3



2-conductor supply terminal block for distribution boxes

Color	Item No.	Pack. Unit
 gray	2016-7601	20
 blue	2016-7604	20

1-conductor N-disconnect terminal block

Color	Item No.	Pack. Unit
 blue	2016-7714	20

2-conductor ground terminal block



15 mm high DIN-35 rails shall be used for a current load higher than 76 A!
 green-yellow 2016-7607 20

1-conductor power distribution disconnect terminal block

Color	Item No.	Pack. Unit
 gray	2016-7711	20

Accessories; item-specific

End and intermediate plate; 1 mm thick

 orange	2016-7692	100 (25)
 gray	2016-7691	100 (25)

Accessories; item-specific

End and intermediate plate; 1 mm thick

 orange	2016-7792	100 (25)
--	-----------	----------

Lock-out; prevents reclosing of slide link; snap-on type

 orange	2006-7300	100 (25)
--	-----------	----------

Accessories; 2016 Series

Appropriate marking systems: WMB/Marking strips

Push-in type jumper bar; insulated; I_N 41 A; light gray

 2-way	2016-402	25
3-way	2016-403	25
4-way	2016-404	25
5-way	2016-405	25

Test plug adapter; for 4 mm Ø test plug

 gray	2009-174	100 (25)
--	----------	----------

Push-in type jumper bar; insulated; I_N 41 A; light gray

 1 to 3	2016-433	25
1 to 4	2016-434	25
1 to 5	2016-435	25

Testing tap; for max. 2.5 mm²

 gray	2009-182	100 (25)
--	----------	----------

Protective warning marker; with black high-voltage symbol; for 5 terminal blocks

 yellow	2016-115	100 (25)
---	----------	----------

Test plug; with 500 mm cable; 2 mm Ø; max. 42 V

 red	210-136	50
---	---------	----

Finger guard; touch-proof cover protects unused conductor entries

 yellow	2016-100	100 (25)
---	----------	----------

Test plug; with 500 mm cable; 2.3 mm Ø; max. 42 V

 yellow	210-137	50
--	---------	----

Busbar; tin-plated; 1000 mm long; copper (10 x 3) mm

 I _N 140 A	210-133	1
---	---------	---

Marking strip; plain; 11 mm wide; 50 m reel

 white	2009-110	1
---	----------	---

Busbar cover; 1000 mm long

 transparent	777-303	1
--	---------	---

WMB marking card; white; 10 strips with 10 markers/card; 5 ... 5.2 mm stretchable

 plain	793-5501	5
---	----------	---

N-conductor disconnect terminal blocks:

For the construction and operation of power installations in fire-prone, hazardous locations or public buildings – such as conference centers, stores, hospitals, schools, theaters or hotels – the DIN VDE 0100-710 or DIN VDE 0100-718 standards shall be observed. DIN VDE 0100-482 shall also be observed for fire-prone, hazardous locations. These VDE regulations mandate that every neutral conductor must be provided with a disconnection device so, e.g., insulation testing is possible for every circuit without disconnecting the N-conductor. WAGO's N-disconnect terminal blocks meet this requirement.

Power distribution disconnect terminal blocks:

According to DIN VDE 0100-710, "Requirements for operating facilities, rooms and special installations – medical facilities," equipotential bonding conductors shall be run on a potential equalization busbar. The potential equalization busbar and the protective ground conductor busbar must be mounted in a common housing and be connected to each other using a disconnectable copper conductor of minimum 16 mm² (6 AWG). Furthermore, all equipotential bonding conductors must be connected to the potential equalization busbar and clearly arranged so they can be disconnected individually and accessed at any time. Depending on their function, they must be provided with captive marking. WAGO's power distribution disconnect terminal blocks meet these requirements.

Supply Terminal Blocks Assembly TOPJOB® S

3

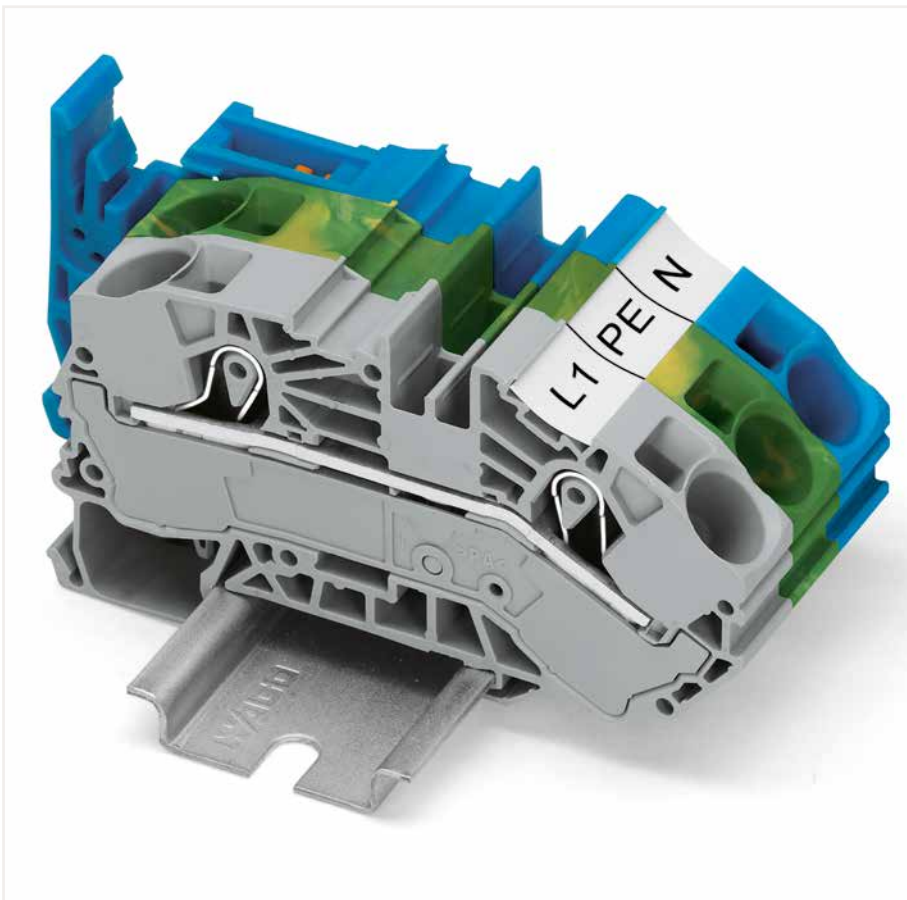

With an angled conductor entry, the 2016 Series Supply Terminal Blocks simplify the wiring of solid conductors in distribution boxes. Solid conductors of the largest cross-section can be connected easily, enabling the distribution box cover to fit without interfering with the conductors.



WAGO High-Current Rail-Mount Terminal Blocks

WAGO High-Current Rail-Mount Terminal Blocks

Side-Entry Wiring

			Page
	Through Terminal Blocks and Ground Conductor Terminal Blocks 6 ... 35 mm ² (10 ... 2 AWG)	285 Series	220
	Power Taps; for 35 mm² (2 AWG) Terminal Blocks 0.2 ... 6 mm ² (24 ... 10 AWG)	285 Series	220
	Through Terminal Blocks and Ground Conductor Terminal Blocks 10 ... 50 (70) mm ² (8 ... 1/0 AWG)	285 Series	224
	Power Taps; for 50 mm² (1/0 AWG) Terminal Blocks 0.2 ... 6 mm ² (24 ... 10 AWG)	285 Series	224
	Through Terminal Blocks; with Mounting Flanges 10 ... 50 (70) mm ² (8 ... 1/0 AWG)	285 Series	225
	Through Terminal Blocks and Ground Conductor Terminal Blocks 25 ... 95 mm ² (4 ... 4/0 AWG)	285 Series	226
	Power Taps; for 95 mm² (4/0 AWG) Terminal Blocks 0.2 ... 10 (16) mm ² (24 ... 8 AWG)	285 Series	226
	Through Terminal Blocks; with Mounting Flanges 25 ... 95 mm ² (4 ... 4/0 AWG)	285 Series	227
	Through Terminal Blocks and Ground Conductor Terminal Blocks 50 ... 185 mm ² (1/0 AWG ... 350 kcmil)	285 Series	228
	Power Taps; for 185 mm² (350 kcmil) Terminal Blocks 0.2 ... 10 (16) mm ² (24 ... 8 AWG)	285 Series	228
	Through Terminal Blocks; with Mounting Flanges 50 ... 185 mm ² (1/0 AWG ... 350 kcmil)	285 Series	229

High-Current Rail-Mount Terminal Blocks; 35 mm² 285 Series Description and Installation

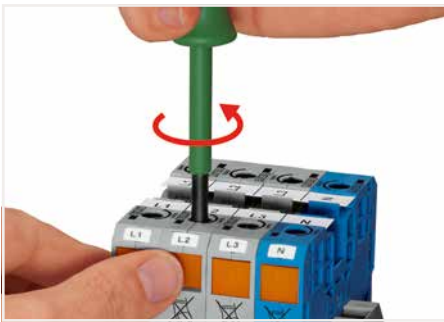

Conductor termination – step 1:
Rotate the operating tool (5.5 mm blade width) counter-clockwise. Next, push in the orange locking tab. The clamp is locked open for hands-free wiring.

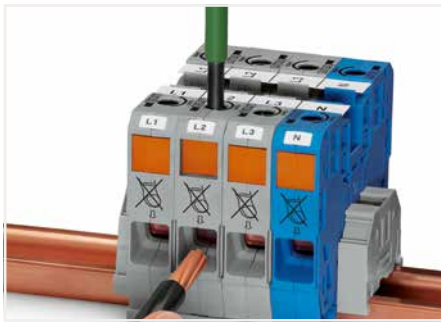

Conductor termination – step 2:
Insert a stripped conductor into the clamping unit until it hits backstop. Hold in this position.

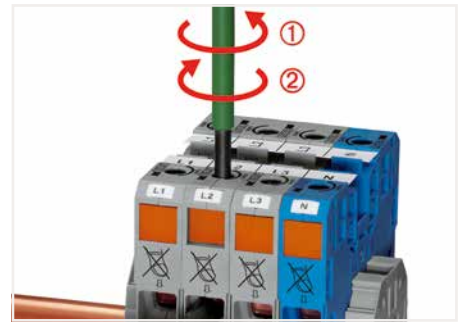

Conductor termination – step 3:
A short counter-clockwise rotation closes the clamp, securing the conductor ①. When unlocked, allow operating tool to rotate clockwise ② to securely terminate the conductor.

4



The power tap is inserted into the jumper contact slot. It can be fitted with a strain relief plate.



Testing



Testing with test plug adapter (283-404).



High-current rail-mount terminal blocks, 35 mm² (2 AWG) and 50 mm² (2/0 AWG)



POWER CAGE CLAMP
terminates the following
copper conductors:
solid



stranded



fine-stranded,
also with tinned
single strands

POWER CAGE CLAMP®



Commoning adjacent terminal blocks using a centrally positioned push-in jumper.



Slide the marking strip laterally to remove the jumper.



Commoning 35 mm² (2 AWG) POWER CAGE CLAMP Terminal Blocks with 10/16 mm² (8/6 AWG) 2010 and 2016 Series Terminal Blocks TOPJOB® S using step-down jumpers (not valid for 2016-76xx and 2016-77xx).

4



Step-down jumpers common terminal blocks of different sizes, without losing a conductor clamping point. This can be beneficial on long conductor runs where voltage drop can be a problem. A large conductor can be easily connected to smaller conductors at the distribution point.

Step-down jumpers are simply pushed down for full insertion, similar to adjacent jumpers. Commoning may be made in either direction using the special thin end plate to cover the open side. Additional through terminal blocks having a smaller cross-section may be commoned using adjacent jumpers.

In this case, pay attention that:
The total current of the outgoing circuits does not exceed the nominal current of the step-down jumper.



Side-entry wiring means that even larger conductors, which have limited flexibility, can be easily connected.



WMB markers or self-adhesive, printable marking strips can be accommodated on 35, 50 and 95 mm² high-current terminal blocks.



Marker carrier for marking strip or 2 x WMB markers for 285-13x, 285-15x and 285-19x terminal blocks



fine-stranded, with ferrule (gastight crimped)



High-Current, Through/Ground Conductor and Ex Terminal Block 35 mm²; 285 Series

Technical Data	
6 ... 35 mm ²	10 ... 2 AWG
1000 V/8 kV/3 ①	600 V, 115 A VA
I _N 125 A	600 V, 115 A CE
Terminal block width: 16 mm / 0.63 inch	
25 mm / 0.98 inch	

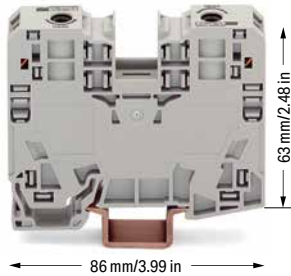

Technical Data	
0.2 ... 6 mm ²	24 ... 10 AWG
800 V/8 kV/3 ②	600 V, 30 A VA
I _N 32 A	600 V, 32 A CE
Module width: 8 mm / 0.315 inch	
12 ... 13 mm / 0.47 ... 0.51 inch	



- ① 1000 V = rated voltage
8 kV = rated impulse voltage
3 = pollution degree
(see Section 14)
- ② 800 V = rated voltage
8 kV = rated impulse voltage
3 = pollution degree
(see Section 14)
- ③ Terminal blocks with an Ex mark are suitable for Ex e II applications.
880 V, 101 A
1 jumper, 75 A
(see Section 14)

Please observe the application notes:
Step-down jumpers, see page 219
Marking, from page 588

Approvals and corresponding ratings,
visit www.wago.com

4

2-conductor through terminal block; only for DIN 35 x 15 rail		
Color	Item No.	Pack. Unit
gray	285-135	15
blue	285-134	15
light gray CE	285-935 ③	15
dark gray/yellow	285-131	15

Power tap; for 35 mm ² high-current terminal blocks		
Color	Item No.	Pack. Unit
gray	285-427	5

Accessories; for high-current terminal blocks
Appropriate marking systems:
WMB/WMB Inline/Marking strips

Copper DIN-rail; per EN 60715; 35 x 15 mm; 2.3 mm thick; 2 m long			
unslotted	210-198	10	

Marking strip; plain; 11 mm wide; 50 m reel		
white	2009-110	1

2-conductor ground terminal block; only suitable for DIN 35 x 15 rail; 2.3 mm thick		
green-yellow	285-137	15
green-yellow CE	285-137/999-950 ③	15

Accessories; item-specific			
Strain relief plate; gray			
1-pole	769-410	100 (25)	

WMB marking card; white; 10 strips with 10 markers/card; for 5 ... 17.5 mm terminal block width		
plain	793-501	5

Accessories; item-specific			
Adjacent jumper; insulated; I _N 85 A			
gray	285-435	50 (25)	

Test plug; with 500 mm cable; 2 mm Ø; max. 42 V		
red	210-136	50

WMB marking card; white; 10 strips with 10 markers/card; 5 ... 5.2 mm stretchable		
plain	793-5501	5

Step-down jumper; insulated; I _N 90 A		
gray	285-430	50 (25)

WMB marking card; white; 10 strips with 10 markers/card; for 5 ... 17.5 mm terminal block width		
plain	793-501	5

Marker carrier; for POWER CAGE CLAMP 35/50/95 mm ² ; 10.4 mm wide		
gray	285-442	25

Protective warning marker; with a black high-voltage symbol		
yellow	285-420	100 (25)

WMB marking card; white; 10 strips with 10 markers/card; 5 ... 5.2 mm stretchable		
plain	793-5501	5

Screwless end stop; for DIN-35 rail; 14 mm wide		
gray	249-197	10

Finger guard; touch-proof cover protects unused conductor entries		
yellow	285-421	100 (25)

Test plug adapter; 11.6 mm wide; for 4 mm Ø test plug; for 1.5 ... 16 mm ² terminal blocks		
gray	283-404	25

Three-phase set; with 35 mm ² high-current terminal blocks		
three-phase set	285-139	1

Power tap; I _N 24 A; with 500 mm cable; for 16 mm ² (283/783 Series) and 35 mm ² (285/785 Series) rail-mount terminal blocks		
gray	283-407	25

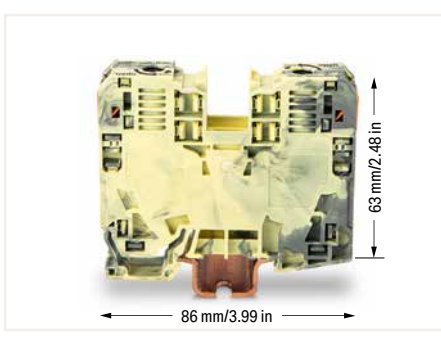

2-conductor through terminal block, dark gray/yellow (285-131), for ground connection without contact to the DIN-rail



Always push voltage tap (283-407) down into the terminal block until fully inserted!

Operating tool with a partially insulated shaft; type 3; (5.5 x 0.8) mm blade		
operating tool	210-721	1

High-Current Rail-Mount Terminal Blocks; 50 ... 185 mm²

285 Series

Description and Installation



Conductor termination – step 1:
Rotate the T-wrench counter-clockwise to the stop ①. Next, push in the orange locking tab. The clamp is locked open for hands-free wiring.



Conductor termination – step 2:
Insert a stripped conductor into the clamping unit until it hits backstop. Hold in this position.



Conductor termination – step 3:
A short counter-clockwise rotation ② releases the tab. When unlocked, the T-wrench rotates clockwise, securely clamping the conductor.

4



For the optimal clamping force:

- Bend conductor.
- Cut conductor to length (conductor end must be straight).
- Stripping a conductor.



Always observe the printed strip length!



Grounding foot:
Ground conductor terminal blocks (limited to max. 120 mm²/250 kcmil per EN 60947-7-2) must be snapped onto a 2.3 mm thick copper DIN-rail.



Protective warning marker may indicate:
Notice: Power is still on even after switching off the main switch!



Risk of injury!
Do not insert fingers in the conductor entry!



Yellow, detachable finger guards provide touch-proof safety by shielding jumper contact slots and/or unused conductor entries.



POWER CAGE CLAMP
terminates the following
copper conductors:
solid



stranded



fine-stranded,
also with tinned
single strands



Commoning with an adjacent jumper: insert the jumper above the conductor entry hole – prior to conductor termination. The nominal cross-section remains unchanged.

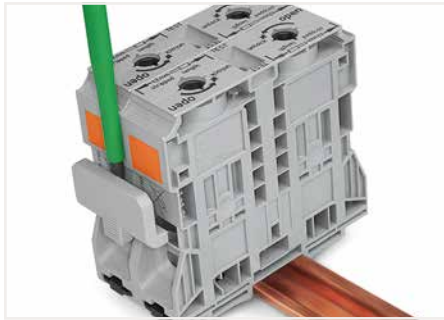

Removing jumper via operating tool.



Reliably and easily tap directly into the power supply. Insert the unwired tap before opening the clamping unit.

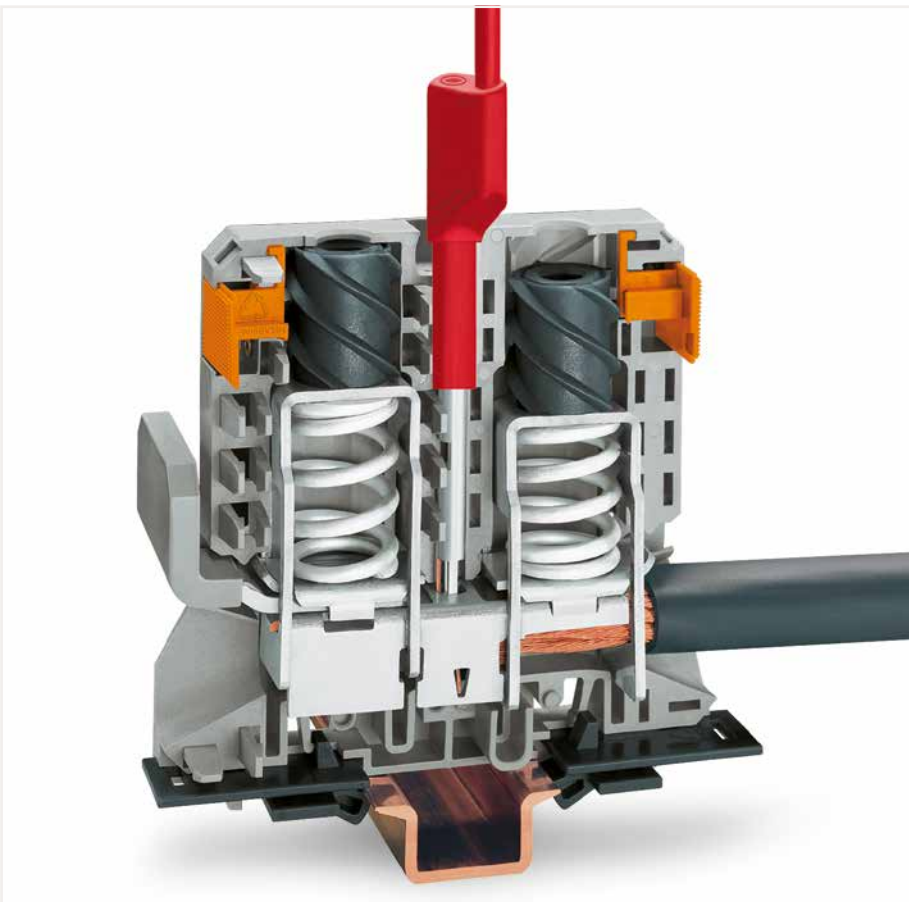

Testing via touch-proof 4 mm Ø test plugs (not available from WAGO, but offered by industry suppliers such as, Multi-Contact Deutschland GmbH).



Testing



WMB markers or self-adhesive, printable marking strips can be accommodated on 35, 50 and 95 mm² high-current terminal blocks.

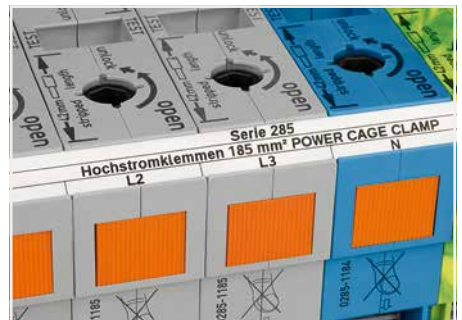

In addition to WMB markers, marking strips can be directly applied to 185 mm² (350 kcmil) high-current terminal blocks.



fine-stranded, with ferrule (gastight crimped)



High-Current, Through/Ground Conductor and Ex Terminal Block 50 (70 "f-st") mm²; 285 Series

Technical Data	
10 ... 50 (70 "f-st") mm ²	8 ... 1/0 AWG
1000 V/8 kV/3 ①	600 V, 150 A
I _N 150 A	600 V, 150 A
Terminal block width: 20 mm / 0.787 inch	
30 mm / 1.18 inch	

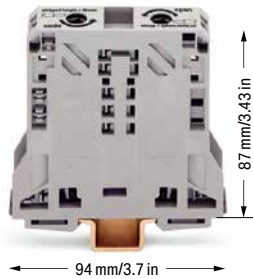

Technical Data	
0.2 ... 6 mm ²	24 ... 10 AWG
1000 V/8 kV/3 ①	600 V, 30 A
I _N 41 A	600 V, 41 A
Module width: 16 mm / 0.63 inch	
12 ... 13 mm / 0.47 ... 0.51 inch	



- ① 1000 V = rated voltage
8 kV = rated impulse voltage
3 = pollution degree
(see Section 14)
 - ② Terminal blocks with an Ex mark are suitable for Ex e II applications.
880 V, 134 A
(see Section 14)
- Adjacent jumpers (285-450) can only be removed or inserted when the clamp is closed.
- Approvals and corresponding ratings, visit www.wago.com

Accessories; for high-current terminal blocks
Appropriate marking systems:
WMB/WMB Inline/Marking strips

Marking strip; plain; 11 mm wide; 50 m reel		
white	2009-110	1

WMB marking card; white; 10 strips with 10 markers/card; for 5 ... 17.5 mm terminal block width		
plain	793-501	5

WMB marking card; white; 10 strips with 10 markers/card; 5 ... 5.2 mm stretchable		
plain	793-5501	5

Marker carrier; for POWER CAGE CLAMP 35/50/95 mm ² ; 10.4 mm wide		
gray	285-442	25

4

2-conductor through terminal block; only for DIN 35 x 15 rail

Color	Item No.	Pack. Unit
gray	285-150	5
blue	285-154	5
light gray	285-950 ②	5
dark gray/yellow	285-151	5

2-conductor ground terminal block; only suitable for DIN 35 x 15 rail; 2.3 mm thick; copper

green-yellow	285-157	5
green-yellow	285-157/999-950 ②	5

Accessories; item-specific

Adjacent jumper; insulated; I_N 150 A, for 1 jumper; I_N 130 A, for 2 ... 4 jumpers

gray	285-450	100 (25)
------	---------	----------

Protective warning marker; with a black high-voltage symbol

yellow	285-440	50 (25)
--------	---------	---------

Protective warning marker; with a black high-voltage symbol

yellow	285-449	25
--------	---------	----

Finger guard; touch-proof cover protects unused conductor entries and jumper slots

yellow	285-441	100 (25)
--------	---------	----------

Three-phase set; with 50 mm² high-current terminal blocks

three-phase set	285-159	1
-----------------	---------	---

Copper DIN-rail; per EN 60715; 35 x 15 mm; 2.3 mm thick; 2 m long

unslotted	210-198	10
-----------	---------	----

Screwless end stop; for DIN-35 rail; 14 mm wide

gray	249-197	10
------	---------	----

T-wrench with a partially insulated shaft

T-wrench	285-172	1
----------	---------	---

Power tap; for 50 mm² high-current terminal blocks

gray	285-447	5
------	---------	---

Accessories; item-specific

Protective warning marker; with black high-voltage symbol; for 5 terminal blocks

yellow	282-415	50 (25)
--------	---------	---------

WMB marking card; white; 10 strips with 10 markers/card; for 5 ... 17.5 mm terminal block width

plain	793-501	5
-------	---------	---

WMB marking card; white; 10 strips with 10 markers/card; 5 ... 5.2 mm stretchable

plain	793-5501	5
-------	----------	---

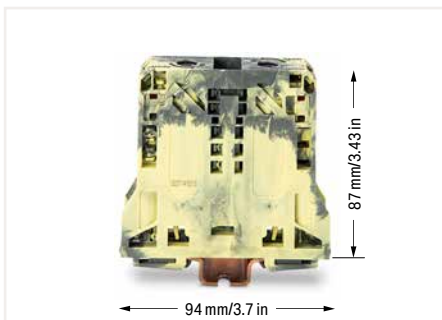

2-conductor through terminal block, dark gray/yellow (285-151), for ground connection without contact to the DIN-rail



Marker carrier for marking strip or 2 x WMB markers for 285-13x, 285-15x and 285-19x terminal blocks

High-Current Through and Ex Terminal Block; with Mounting Flanges

50 (70 "f-st") mm²; 285 Series

Technical Data	
10 ... 50 (70 "f-st") mm ²	8 ... 1/0 AWG
1000 V/8 kV/3 ①	
I _N 150 A	
Terminal block width: 20 mm / 0.787 inch	
30 mm / 1.18 inch	

Technical Data	
10 ... 50 (70 "f-st") mm ²	8 ... 1/0 AWG
1000 V/8 kV/3 ①	
I _N 150 A	
Terminal block width: 20 mm / 0.787 inch	
30 mm / 1.18 inch	

- ① 1000 V = rated voltage
8 kV = rated impulse voltage
3 = pollution degree
(see Section 14)
 - ② Terminal blocks with an Ex mark are suitable for Ex e II applications.
880 V, 134 A
(see Section 14)
- Adjacent jumpers (285-450) can only be removed or inserted when the clamp is closed.
- Approvals and corresponding ratings, visit www.wago.com

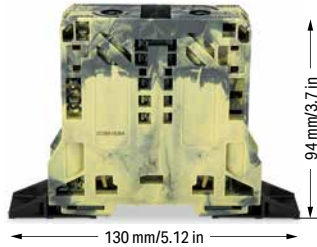

2-conductor through terminal block; with mounting flanges		
Color	Item No.	Pack. Unit
gray	285-141	5
blue	285-144	5
light gray ②	285-143 ②	5

2-conductor through terminal block; with mounting flanges		
Color	Item No.	Pack. Unit
dark gray/yellow	285-147	5
dark gray/yellow ②	285-147/999-950 ②	5

Accessories; for high-current terminal blocks
Appropriate marking systems: WMB/WMB Inline/Marking strips

Adjacent jumper; insulated; I _N 150 A, for 1 jumper; I _N 130 A, for 2 ... 4 jumpers		
Color	Item No.	Pack. Unit
gray	285-450	100 (25)

Marking strip; plain; 11 mm wide; 50 m reel		
Color	Item No.	Pack. Unit
white	2009-110	1

Block-to-block connector; for 50 mm ² high-current terminal blocks		
Color	Item No.	Pack. Unit
orange	285-448	50 (25)

WMB marking card; white; 10 strips with 10 markers/card; for 5 ... 17.5 mm terminal block width		
Color	Item No.	Pack. Unit
plain	793-501	5

Protective warning marker; with a black high-voltage symbol		
Color	Item No.	Pack. Unit
yellow	285-440	50 (25)

WMB marking card; white; 10 strips with 10 markers/card; 5 ... 5.2 mm stretchable		
Color	Item No.	Pack. Unit
plain	793-5501	5

Protective warning marker; with a black high-voltage symbol		
Color	Item No.	Pack. Unit
yellow	285-449	25

Marker carrier; for POWER CAGE CLAMP 35/50/95 mm ² ; 10.4 mm wide		
Color	Item No.	Pack. Unit
gray	285-442	25

Finger guard; touch-proof cover protects unused conductor entries and jumper slots		
Color	Item No.	Pack. Unit
yellow	285-441	100 (25)

Three-phase set; with 50 mm ² high-current terminal blocks		
Item No.	Pack. Unit	
285-148	1	

Power tap; for 50 mm ² high-current terminal blocks		
Color	Item No.	Pack. Unit
gray	285-447	5

T-wrench with a partially insulated shaft		
Item No.	Pack. Unit	
285-172	1	



Optionally, insert block-to-block connector (285-448) into housing slot.



Align and snap high-current, through terminal blocks together.

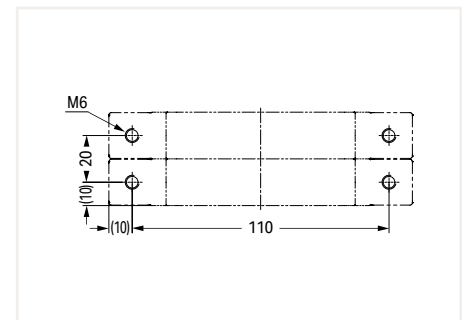

Dimensions (in mm):
Drill hole separation distance



High-Current, Through/Ground Conductor and Ex Terminal Block

95 mm²; 285 Series

Technical Data

25 ... 95 mm ²	4 ... 4/0 AWG
1000 V/8 kV/3 ②	600 V, 200 A
I _N 232 A	600 V, 210 A
Terminal block width: 25 mm / 0.984 inch	
35 mm / 1.38 inch	

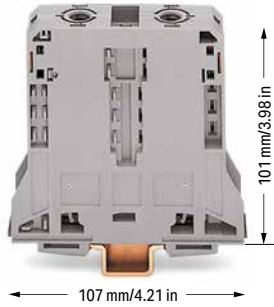

2-conductor through terminal block; only for DIN 35 x 15 rail

Color	Item No.	Pack. Unit
gray	285-195	5
blue	285-194	5
light gray	285-995 ③	5
dark gray/yellow	285-191	5

2-conductor ground terminal block; only suitable for DIN 35 x 15 rail; 2.3 mm thick; copper

green-yellow	285-197	5
green-yellow	285-197/999-950 ③	5

Accessories; item-specific

Adjacent jumper; insulated; I_N 232 A, for 1 jumper; I_N 192 A, for 2 ... 4 jumpers

gray	285-495	25
------	---------	----

Protective warning marker; with a black high-voltage symbol

yellow	285-170	50 (25)
--------	---------	---------

Protective warning marker; with a black high-voltage symbol

yellow	285-175	25
--------	---------	----

Finger guard; touch-proof cover protects unused conductor entries and jumper slots

yellow	285-169	25
--------	---------	----

Three-phase set; with 95 mm² high-current terminal blocks

three-phase set	285-199	1
-----------------	---------	---

Copper DIN-rail; per EN 60715; 35 x 15 mm; 2.3 mm thick; 2 m long

unslotted	210-198	10
-----------	---------	----

Screwless end stop; for DIN-35 rail; 14 mm wide

gray	249-197	10
------	---------	----

T-wrench with a partially insulated shaft

T-wrench	285-172	1
----------	---------	---

Technical Data

0.2 ... 10 (16) mm ² ①	24 ... 8 AWG
1000 V/8 kV/3 ②	600 V, 50 A
I _N 57 A	
Module width: 20 mm / 0.787 inch	
12 ... 13 mm / 0.47 ... 0.51 inch	



Power tap; for 95 mm² high-current terminal blocks

Color	Item No.	Pack. Unit
gray	285-407	5

Accessories; item-specific

Protective warning marker; with black high-voltage symbol; for 5 terminal blocks

yellow	284-415	50 (25)
--------	---------	---------

WMB marking card; white; 10 strips with 10 markers/card; for 5 ... 17.5 mm terminal block width

plain	793-501	5
-------	---------	---

WMB marking card; white; 10 strips with 10 markers/card; 5 ... 5.2 mm stretchable

plain	793-5501	5
-------	----------	---

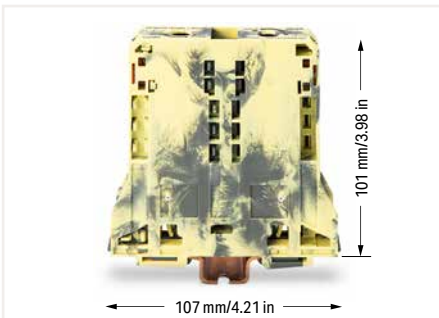

2-conductor through terminal block, dark gray/yellow (285-191), for ground connection without contact to the DIN-rail

① Power tap; for 95 mm² high-current terminal blocks
Max. conductor size: 16 mm²

② 1000 V = rated voltage
8 kV = rated impulse voltage
3 = pollution degree
(see Section 14)

③ Terminal blocks with an Ex mark are suitable for Ex e II applications.
25 ... 95 mm² / 4 ... 4/0 AWG
880 V, 211 A
1 jumper, 211 A
2 ... 4 jumpers, 175 A
35 ... 70 mm² / 2 ... 2/0 AWG
for ground conductor terminal blocks
(see Section 14)

Approvals and corresponding ratings,
visit www.wago.com

Accessories; for high-current terminal blocks

Appropriate marking systems:
WMB/WMB Inline/Marking strips

Marking strip; plain; 11 mm wide; 50 m reel

white	2009-110	1
-------	----------	---

WMB marking card; white; 10 strips with 10 markers/card; for 5 ... 17.5 mm terminal block width

plain	793-501	5
-------	---------	---

WMB marking card; white; 10 strips with 10 markers/card; 5 ... 5.2 mm stretchable

plain	793-5501	5
-------	----------	---

Marker carrier; for POWER CAGE CLAMP 35/50/95 mm²; 10.4 mm wide

gray	285-442	25
------	---------	----



Marker carrier for marking strip or 2 x WMB markers for 285-13x, 285-15x and 285-19x terminal blocks

High-Current Through Terminal Block; with Mounting Flanges

95 mm²; 285 Series

Technical Data	
25 ... 95 mm ²	4 ... 4/0 AWG
1000 V/8 kV/3 ①	
I _N 232 A	
Terminal block width: 25 mm / 0.984 inch	
35 mm / 1.38 inch	

Technical Data	
25 ... 95 mm ²	4 ... 4/0 AWG
1000 V/8 kV/3 ①	
I _N 232 A	
Terminal block width: 25 mm / 0.984 inch	
35 mm / 1.38 inch	

① 1000 V = rated voltage
8 kV = rated impulse voltage
3 = pollution degree
(see Section 14)

Approvals and corresponding ratings, visit www.wago.com

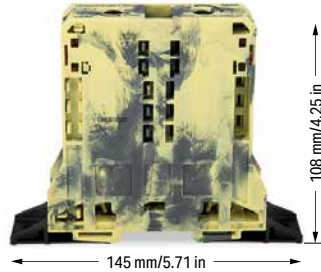

2-conductor through terminal block; with mounting flanges		
Color	Item No.	Pack. Unit
gray	285-181	5
blue	285-184	5

2-conductor through terminal block; with mounting flanges		
Color	Item No.	Pack. Unit
dark gray/yellow	285-187	5

Accessories; for high-current terminal blocks
Appropriate marking systems: WMB/WMB Inline/Marking strips

Adjacent jumper; insulated; I _N 232 A, for 1 jumper; I _N 192 A, for 2 ... 4 jumpers		
gray	285-495	25



Marking strip; plain; 11 mm wide; 50 m reel		
white	2009-110	1



Block-to-block connector; for 95 mm ² high-current terminal blocks		
orange	285-168	50 (25)



WMB marking card; white; 10 strips with 10 markers/card; for 5 ... 17.5 mm terminal block width		
plain	793-501	5



Protective warning marker; with a black high-voltage symbol		
yellow	285-170	25



WMB marking card; white; 10 strips with 10 markers/card; 5 ... 5.2 mm stretchable		
plain	793-5501	5



Protective warning marker; with a black high-voltage symbol		
yellow	285-175	25



Marker carrier; for POWER CAGE CLAMP 35/50/95 mm ² ; 10.4 mm wide		
gray	285-442	25



Finger guard; touch-proof cover protects unused conductor entries and jumper slots		
yellow	285-169	25



Three-phase set; with 95 mm ² high-current terminal blocks		
	285-188	1



Power tap; for 95 mm ² high-current terminal blocks		
	285-407	5



T-wrench with a partially insulated shaft		
	285-172	1



Optionally, insert block-to-block connector (285-168) into housing slot.



Align and snap high-current, through terminal blocks together.

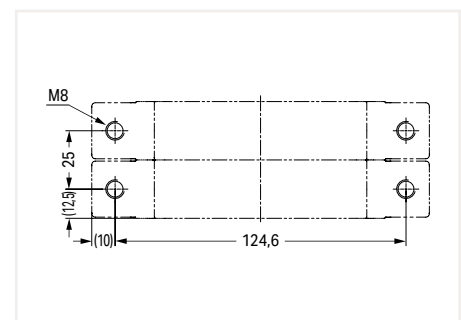

Dimensions (in mm):
Drill hole separation distance



High-Current Through and Ground Conductor Terminal Block 185 mm²; 285 Series

Technical Data

50 ... 185 mm² ❶ | 1/0 AWG ... 350 kcmil
1000 VAC/DC/1500 VDC/12 kV/3 ❸
I_N 353 A
Terminal block width: 32 mm / 1.26 inch
45 ... 47 mm / 1.77 ... 1.85 inch



Technical Data

0.2 ... 10 (16) mm² ❷ | 24 ... 8 AWG
1000 V/8 kV/3 ❹
I_N 57 A
Module width: 20 mm / 0.787 inch
12 ... 13 mm / 0.47 ... 0.51 inch



- ❶ 50 ... 120 mm² / 1/0 AWG ... 250 kcmil for ground conductor terminal blocks (285-1187)
- ❷ Power tap; for 185 mm² high-current terminal blocks. Max. conductor size: 16 mm²
- ❸ 1000 VAC/DC
1500 VDC = rated voltage
12 kV = rated impulse voltage
3 = pollution degree (see Section 14)
- ❹ 1000 V = rated voltage
8 kV = rated impulse voltage
3 = pollution degree (see Section 14)
- ❺ Terminal blocks with an Ex mark are suitable for Ex e II applications.
50 ... 185 mm² / 1/0 AWG ... 350 kcmil
1000 V, 250 A
1 jumper, 236 A
50 ... 120 mm² / 1/0 AWG ... 250 kcmil for ground conductor terminal blocks (see Section 14)

Approvals and corresponding ratings, visit www.wago.com

Accessories; for high-current terminal blocks

Appropriate marking systems:
WMB/WMB Inline/Marking strips

Marking strip; plain; 11 mm wide; 50 m reel

white	2009-110	1
-------	----------	---

WMB marking card; white; 10 strips with 10 markers/card; for 5 ... 17.5 mm terminal block width

plain	793-501	5
-------	---------	---

WMB marking card; white; 10 strips with 10 markers/card; 5 ... 5.2 mm stretchable

plain	793-5501	5
-------	----------	---

Marker carrier; for POWER CAGE CLAMP 35/50/95 mm²; 10.4 mm wide

gray	285-442	25
------	---------	----

2-conductor through terminal block; only for DIN 35 x 15 rail

Color	Item No.	Pack. Unit
gray	285-1185	5
blue	285-1184	5
light gray ❸	285-1189 ❺	5
dark gray/yellow	285-1181	5

2-conductor ground terminal block; only suitable for DIN 35 x 15 rail; 2.3 mm thick; copper

green-yellow	285-1187	5
green-yellow ❸	285-1187/999-950 ❺	5

Accessories; item-specific

Adjacent jumper; insulated; I_N 309 A for 1 jumper

gray	285-1171	25
------	----------	----

Protective warning marker; with a black high-voltage symbol

yellow	285-1177	50 (25)
--------	----------	---------

Protective warning marker; with a black high-voltage symbol

yellow	285-1176	25
--------	----------	----

Finger guard; touch-proof cover protects unused conductor entries and jumper slots

yellow	285-1178	25
--------	----------	----

Three-phase set; with 185 mm² high-current terminal blocks

	285-1169	1
--	----------	---

Copper DIN-rail; per EN 60715; 35 x 15 mm; 2.3 mm thick; 2 m long

unslotted	210-198	10
-----------	---------	----

Screwless end stop; for DIN-35 rail; 14 mm wide

gray	249-197	10
------	---------	----

T-wrench with a partially insulated shaft

	285-172	1
--	---------	---

Power tap; for 185 mm² high-current terminal blocks

Color	Item No.	Pack. Unit
gray	285-1175	5

Accessories; item-specific

Protective warning marker; with black high-voltage symbol; for 5 terminal blocks

yellow	284-415	50 (25)
--------	---------	---------

WMB marking card; white; 10 strips with 10 markers/card; for 5 ... 17.5 mm terminal block width

plain	793-501	5
-------	---------	---

WMB marking card; white; 10 strips with 10 markers/card; 5 ... 5.2 mm stretchable

plain	793-5501	5
-------	----------	---



Tapping directly into the power supply.

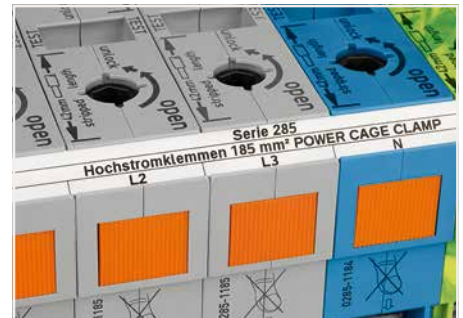

In addition to WMB markers, marking strips can be directly applied to 185 mm² (350 kcmil) high-current terminal blocks.

High-Current Through Terminal Block; with Mounting Flanges 185 mm²; 285 Series

Technical Data	
50 ... 185 mm ²	1/0 AWG ... 350 kcmil
1000 VAC/DC / 1500 VDC / 12 kV / 3 ①	
I _N 353 A	
Terminal block width: 32 mm / 1.26 inch	
45 ... 47 mm / 1.77 ... 1.85 inch	

Technical Data	
50 ... 185 mm ²	1/0 AWG ... 350 kcmil
1000 VAC/DC / 1500 VDC / 12 kV / 3 ①	
I _N 353 A	
Terminal block width: 32 mm / 1.26 inch	
45 ... 47 mm / 1.77 ... 1.85 inch	

- ① 1000 VAC/DC
1500 VDC = rated voltage
12 kV = rated impulse voltage
3 = pollution degree
(see Section 14)
- ② Terminal blocks with an Ex mark are suitable for Ex e II applications.
50 ... 185 mm² / 1/0 AWG ... 350 kcmil
1000 V, 250 A
1 jumper, 236 A
(see Section 14)

Approvals and corresponding ratings, visit www.wago.com

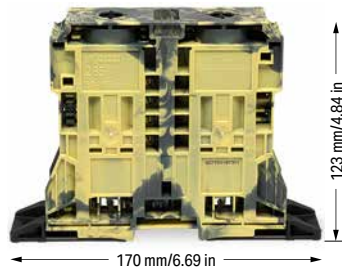

2-conductor through terminal block; with mounting flanges		
Color	Item No.	Pack. Unit
gray	285-1161	4
blue	285-1164	4
light gray ②	285-1163 ②	4

2-conductor through terminal block; with mounting flanges		
Color	Item No.	Pack. Unit
dark gray/yellow	285-1167	4
dark gray/yellow ②	285-1167/999-950 ②	4



Optionally, insert block-to-block connector (285-1179) into housing slot.

Accessories; for high-current terminal blocks

Appropriate marking systems: WMB/WMB Inline/Marking strips

Adjacent jumper; insulated; I _N 309 A for 1 jumper			
Color	Item No.	Pack. Unit	
gray	285-1171	25	

Marking strip; plain; 11 mm wide; 50 m reel			
Color	Item No.	Pack. Unit	
white	2009-110	1	

Block-to-block connector; for 185 mm ² high-current terminal blocks			
Color	Item No.	Pack. Unit	
orange	285-1179	50 (25)	

WMB marking card; white; 10 strips with 10 markers/card; for 5 ... 17.5 mm terminal block width			
Color	Item No.	Pack. Unit	
plain	793-501	5	

Protective warning marker; with a black high-voltage symbol			
Color	Item No.	Pack. Unit	
yellow	285-1177	50 (25)	

WMB marking card; white; 10 strips with 10 markers/card; 5 ... 5.2 mm stretchable			
Color	Item No.	Pack. Unit	
plain	793-5501	5	

Protective warning marker; with a black high-voltage symbol			
Color	Item No.	Pack. Unit	
yellow	285-1176	25	

Finger guard; touch-proof cover protects unused conductor entries and jumper slots			
Color	Item No.	Pack. Unit	
yellow	285-1178	25	

Three-phase set; with 185 mm ² high-current terminal blocks			
Item No.	Pack. Unit		
285-1165	1		

Power tap; for 185 mm ² high-current terminal blocks			
Item No.	Pack. Unit		
285-1175	5		

T-wrench with a partially insulated shaft			
Item No.	Pack. Unit		
285-172	1		

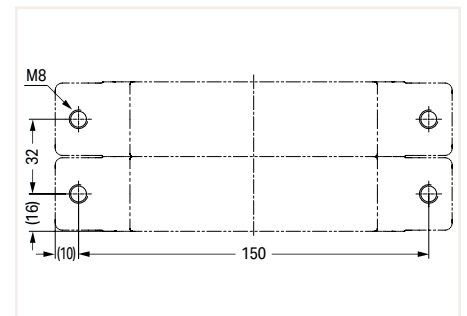

Dimensions (in mm):
Drill hole separation distance



Secure the terminal block to a mounting plate using two M8 cylinder-head screws and appropriate washers.

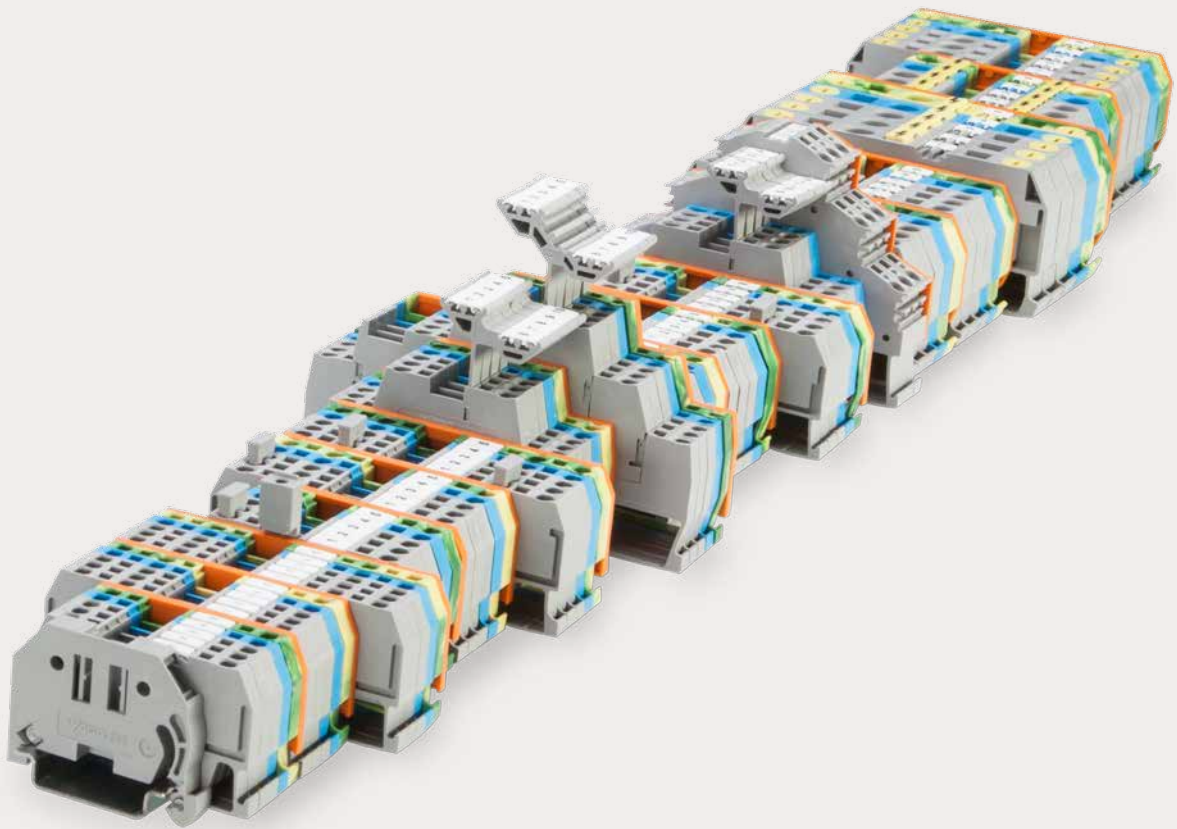

WAGO Rail-Mount Terminal Blocks Classic

WAGO Rail-Mount Terminal Blocks Classic

WAGO Installation Rail-Mount Terminal Blocks TOPJOB® Classic

Front-Entry Wiring

			Page
	Through/Ground Conductor/Shield Conductor and Ex Terminal Blocks 0.08 ... 35 mm ² (28 ... 2 AWG) Distribution Terminal Blocks 10 mm ² (8 AWG) / 35 mm ² (2 AWG)	279 ... 285/880 Series 284 Series	234
	Multilevel Rail-Mount Terminal Blocks 1.5/2.5/4 mm ² (16/12 AWG)	279/280/281 Series	248
	TOPJOB® Classic Through/Ground Conductor/Shield Conductor and Ex Terminal Blocks 0.08 ... 35 mm ² (28 ... 2 AWG)	780 ... 785 Series	267
	Disconnect/Test Terminal Blocks 0.08 ... 4 mm ² (28 ... 12 AWG) and 0.2 ... 6 mm ² (24 ... 10 AWG)	280/281/282 Series	276
	Disconnect/Ground Conductor Disconnect and Fuse Terminal Blocks 0.2 ... 6 mm ² (24 ... 10 AWG)	282 Series	292
	Fused Disconnect Terminal Blocks with a Pivoting Fuse Holder 0.08 ... 4 mm ² (28 ... 12 AWG)	281 Series	298
	Fuse Plugs on Carrier Terminal Blocks	281/280 Series	302
	Sensor and Actuator Terminal Blocks 0.08 ... 2.5 mm ² (28 ... 12 AWG)	280 Series	312
	Diode and LED Terminal Blocks 0.08 ... 4 mm ² (28 ... 12 AWG)	279/280/281 Series	328
	Multilevel Diode and LED Terminal Blocks 0.08 ... 4 mm ² (28 ... 12 AWG)	280/281 Series	334
	Diode and LED Modules	280 Series	338
	Accessories for Rail-Mount Terminal Blocks		342

Rail-Mount Terminal Blocks Classic

279 ... 285 and 880 Series

Description and Installation

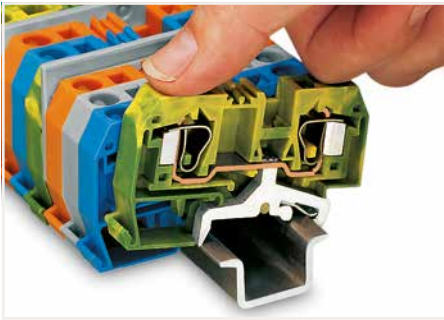

By snapping a ground conductor terminal block onto the DIN-rail, a direct electrical connection is automatically made to the rail.



Quick assembly keys prevent reverse mounting.



Removing a terminal block from the assembly.

5

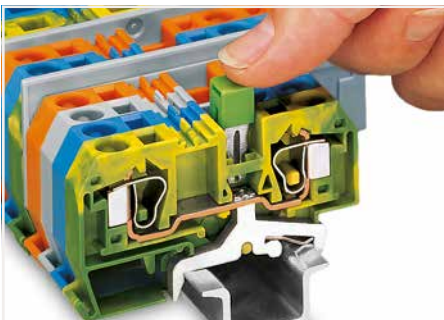

Commoning ground conductor terminal blocks with through terminal blocks is possible in one direction only (via rear side of terminal block) using adjacent jumpers. Recommends using yellow-green adjacent jumpers in addition to the required marking of these blocks.

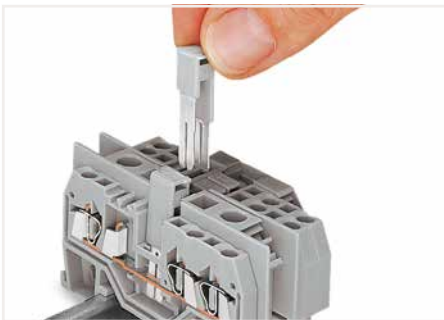

Commoning terminal blocks of different sizes via step-down jumpers.



Steel DIN-rails are not suited for PEN (ground and N-conductor) applications per EN 60947-7-2 (VDE 0611, Part 3).

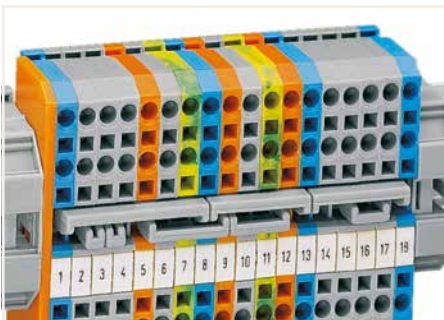

Staggered jumpers for sophisticated circuit requirements – push jumpers down until fully inserted.



880 Series Terminal Blocks have an additional test slot for the 2-pole voltage tester.



Protective warning markers inserted into the operating slots



CAGE CLAMP® terminates the following copper conductors: solid



stranded



fine-stranded, also with tinned single strands



CAGE CLAMP® connection
Inserting a conductor.



CAGE CLAMP® connection
Inserting a conductor.
With ferruled conductors, it is necessary to use a terminal block one size larger than the conductor's nominal cross section.



Testing with a test plug.
(picture shows a test plug fitted with CAGE CLAMP®)

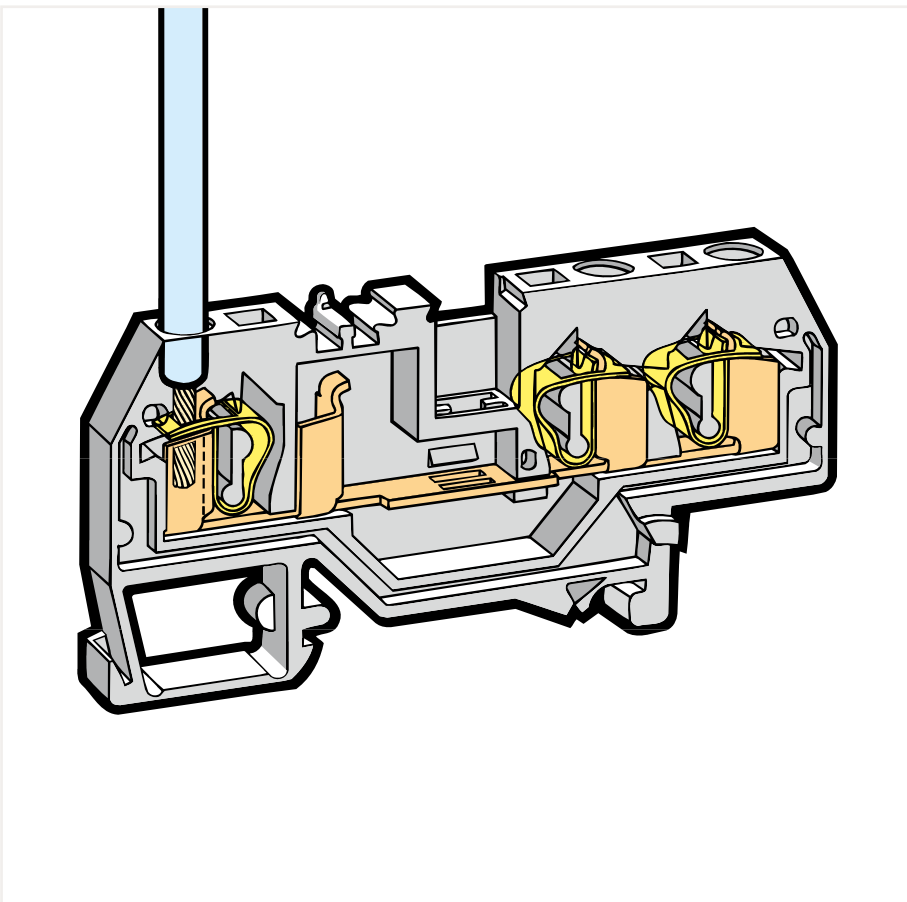

L-type test plug modules fitted with CAGE CLAMP®

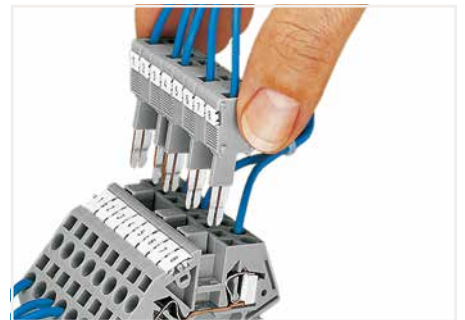

B-type test plug modules fitted with CAGE CLAMP®

5



Labeling via WMB Multi Marking System.

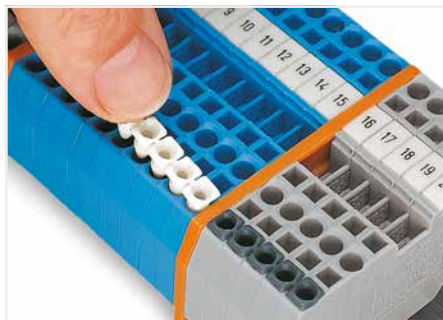

Inserting insulation stops.



Testing with a test plug.
(picture shows 209-170 Test Plug Adapter)



fine-stranded,
tip-bonded



fine-stranded,
with ferrule
(gastight crimped)



fine-stranded,
with pin terminal
(gastight crimped)

Through/Ground Conductor/Shield Conductor/Ex and Double-Potential Terminal Block 1.5 mm²; 279 Series

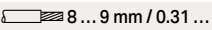
Technical Data	
0.08 ... 1.5 mm ²	28 ... 16 AWG
800 V/8 kV/3 ①	600 V, 10 A ②
I _N 18 A	600 V, 10 A ③
Terminal block width: 4 mm / 0.157 inch	
 8 ... 9 mm / 0.31 ... 0.35 inch	

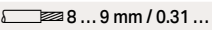
Technical Data	
0.08 ... 1.5 mm ²	28 ... 16 AWG
800 V/8 kV/3 ①	600 V, 10 A ②
I _N 18 A	600 V, 10 A ③
Terminal block width: 4 mm / 0.157 inch	
 8 ... 9 mm / 0.31 ... 0.35 inch	

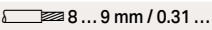
Technical Data	
0.08 ... 1.5 mm ²	28 ... 16 AWG
800 V/8 kV/3 ①	600 V, 10 A ②
I _N 18 A	600 V, 10 A ③
Terminal block width: 4 mm / 0.157 inch	
 8 ... 9 mm / 0.31 ... 0.35 inch	

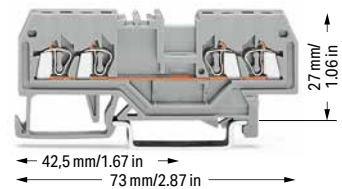
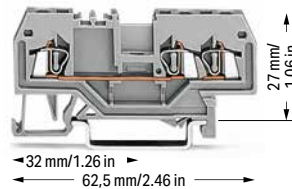
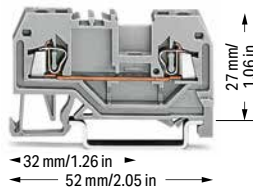

2-conductor through terminal block

Color	Item No.	Pack. Unit
gray	279-901	100
blue	279-904 ②	100
orange	279-902	100
red	279-903	100
black	279-905	100
yellow	279-906	100
light gray ③	279-992 ③	100

3-conductor through terminal block

Color	Item No.	Pack. Unit
gray	279-681	100
blue	279-684 ②	100
orange	279-682	100
red	279-683	100
black	279-685	100
yellow	279-686	100
light gray ③	279-993 ③	100

4-conductor through terminal block

Color	Item No.	Pack. Unit
gray	279-831	100
blue	279-834 ②	100
orange	279-832	100
red	279-833	100
black	279-835	100
yellow	279-836	100
light gray ③	279-994 ③	100

2-conductor ground terminal block

green-yellow	279-907	100
green-yellow ③	279-907/999-950 ③	100

3-conductor ground terminal block

green-yellow	279-687	100
green-yellow ③	279-687/999-950 ③	100

4-conductor ground terminal block

green-yellow	279-837	100
green-yellow ③	279-837/999-950 ③	100

4-conductor shield terminal block

white	279-838	100
-------	---------	-----

Other terminal blocks with the same profile:

Diode	279-915/281-410	Page 328
-------	-----------------	----------

Other terminal blocks with the same profile:



Diode	279-673/281-410	Page 328
LED	279-674/281-434	Page 328

Other terminal blocks with the same profile:

Diode	279-815/281-410	Page 328
LED	279-809/281-434	Page 328
Double-potential	279-826	Page 235

Accessories; item-specific

End and intermediate plate; 2 mm thick

 orange	279-328	100 (25)
 gray	279-325	100 (25)
 light gray	279-330	100 (25)

Separator; oversized; 2 mm thick



 orange	279-329	100 (25)
 gray	279-326	100 (25)
 light gray	279-331	100 (25)

Ex e/Ex i separator; orange; 3 mm thick

 90 mm	209-190	50 (25)
 120 mm	209-191	50 (25)

Accessories; item-specific

End and intermediate plate; 2 mm thick

 orange	279-339	100 (25)
 gray	279-308	100 (25)
 light gray	279-341	100 (25)

Separator; oversized; 2 mm thick

 orange	279-340	100 (25)
 gray	279-309	100 (25)
 light gray	279-342	100 (25)

Ex e/Ex i separator; orange; 3 mm thick

 120 mm	209-191	50 (25)
--	---------	---------

Accessories; item-specific

End and intermediate plate; 2 mm thick

 orange	279-346	100 (25)
 gray	279-344	100 (25)
 light gray	279-348	100 (25)

Separator; oversized; 2 mm thick

 orange	279-347	100 (25)
 gray	279-345	100 (25)
 light gray	279-349	100 (25)

Ex e/Ex i separator; orange; 3 mm thick

 120 mm	209-191	50 (25)
--	---------	---------

Step-down cover plate; 1 mm thick

 gray	284-336	100 (25)
 orange	284-346	100 (25)

Accessories; 279 Series

Appropriate marking systems: WMB/WMB Inline/WFB

Insulation stop; 0.08 ... 0.2 mm² "s" (0.14 mm² "f-st"); 5 pcs/strip

 white	279-470	200 (25)
---	---------	----------

Insulation stop; 0.25 mm²; 5 pcs/strip

 dark gray	279-471	200 (25)
---	---------	----------

Adjacent jumper; insulated; I_N 15 A

 gray	279-402	200 (25)
 yellow-green	279-422	200 (25)

Alternate jumper; insulated; I_N 15 A

 gray	279-409	100 (25)
--	---------	----------

Technical Data

0.08 ... 1.5 mm ²	28 ... 16 AWG
800 V/8 kV/3 ①	600 V, 10 A ②
I _N 18 A	600 V, 10 A ③
Terminal block width: 4 mm / 0.157 inch	
8 ... 9 mm / 0.31 ... 0.35 inch	

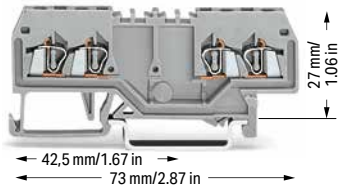

Double-potential terminal block; with double, center marking level

Color	Item No.	Pack. Unit
○ gray	279-826	100
○ light gray ④	279-995 ⑤	100

- ① 800 V = rated voltage
8 kV = rated impulse voltage
3 = pollution degree
(see Section 14)
- ② Terminal blocks with a blue insulated housing are suitable for Ex i applications.
- ③ Terminal blocks with an Ex mark are suitable for Ex e II applications.
0.2 ... 1.5 mm² / 24 ... 16 AWG
550 V; 15 A
(see Section 14)

Please observe the application notes:
Insulation stop, page 346
Push-in type wire jumper, page 349
Step-down jumper, page 250
Comb-style jumper bar, page 347
Marking, from page 588

Approvals and corresponding ratings, visit www.wago.com

Accessories; 279 Series

Appropriate marking systems:
WMB/WMB Inline/WFB

Push-in type wire jumper; insulated; 0.75 mm² conductor cross section; I_N 9 A

	L = 60 mm	249-125	100 (10)
	L = 110 mm	249-126	100 (10)
	L = 250 mm	249-127	100 (10)

Step-down jumper; insulated; commons 10/6 mm² (8/10 AWG) down to 4/2.5/1.5 mm² (12/14/16 AWG); I_N 15 A

	gray	284-414	50 (25)
--	------	---------	---------

Cover plate; 1 mm thick; for 2-, 3- and 4-conductor terminal blocks

	gray	284-334	100 (25)
	orange	284-344	100 (25)

Comb-style jumper bar; insulated; I_N = I_N of terminal block

	2-way	279-482	200 (25)
	3-way	279-483	200 (25)

Accessories; item-specific

End and intermediate plate; 2 mm thick

	orange	279-346	100 (25)
	gray	279-344	100 (25)
	light gray	279-348	100 (25)

Separator; oversized; 2 mm thick

	orange	279-347	100 (25)
	gray	279-345	100 (25)
	light gray	279-349	100 (25)

Comb-style jumper bar; insulated; I_N = I_N of terminal block

	10-way	279-490	50 (25)
--	--------	---------	---------

Alternate comb-style jumper bar; insulated; I_N = I_N of terminal block

	2-way	279-492	200 (25)
--	-------	---------	----------

Operating tool; insulated

	2-way	279-432	1
	3-way	279-433	1

Operating tool; insulated

	10-way	279-440	1
--	--------	---------	---

Protective warning marker; with black high-voltage symbol; for 5 terminal blocks

	yellow	279-415	100 (25)
--	--------	---------	----------

Test plug adapter; 8.3 mm wide; for 4 mm Ø test plug; for 1.5 ... 10 mm² terminal blocks

	gray	209-170	50 (25)
--	------	---------	---------

Test plug adapter; 5 mm wide; for 210-137 Test Plug (2.3 mm Ø); for 1.5 ... 4 mm² terminal blocks

	gray	280-404	100 (25)
--	------	---------	----------

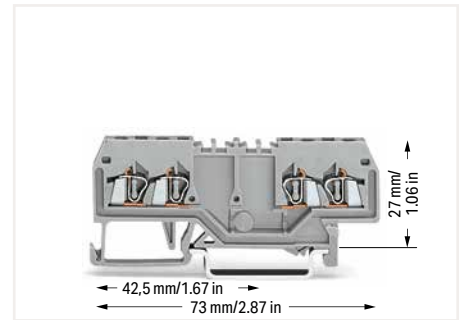

Notice: These double-potential terminal blocks cannot be commoned via adjacent jumpers!
Front-entry double-potential terminal blocks are space savers.
Two independent feedthrough circuits are placed in one insulated housing on one level in just 4 mm. This achieves a width of just 2 mm versus standard through terminal blocks.
Input and output of a circuit are placed on the same side of the terminal block. Both circuits can be individually marked according to input and output.

For technical data and accessories, see www.wago.com



Marking directly on the terminal block via WMB markers.



Terminal block marking with double marker carriers (209-128)
Terminal blocks with side marking (see online catalog at www.wago.com)

Through/Ground Conductor/Shield Conductor/Ex and Double-Potential Terminal Block 2.5 mm²; 280 Series

Technical Data	
0.08 ... 2.5 mm ²	28 ... 12 AWG*
800 V/8 kV/3 ①	600 V, 20 A ②
I _N 24 A	600 V, 25 A ③
Terminal block width: 5 mm / 0.197 inch	
8 ... 9 mm / 0.31 ... 0.35 inch	

Technical Data	
0.08 ... 2.5 mm ²	28 ... 12 AWG*
800 V/8 kV/3 ①	600 V, 20 A ②
I _N 24 A	600 V, 15 A ③
Terminal block width: 5 mm / 0.197 inch	
8 ... 9 mm / 0.31 ... 0.35 inch	

Technical Data	
0.08 ... 2.5 mm ²	28 ... 12 AWG*
800 V/8 kV/3 ①	600 V, 20 A ②
I _N 20 A	600 V, 25 A ③
Terminal block width: 5 mm / 0.197 inch	
8 ... 9 mm / 0.31 ... 0.35 inch	

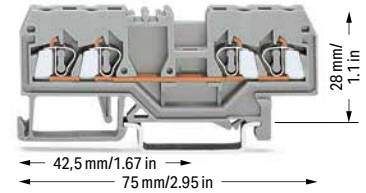
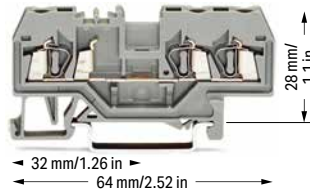
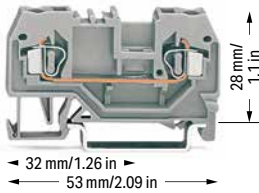

2-conductor through terminal block		
Color	Item No.	Pack. Unit
○ gray	280-901	100
● blue	280-904 ②	100
● orange	280-902	100
● red	280-903	100
● black	280-905	100
● yellow	280-906	100
○ light gray ⑤	280-992 ③	100

3-conductor through terminal block		
Color	Item No.	Pack. Unit
○ gray	280-681	100
● blue	280-684 ②	100
● orange	280-650	100
● red	280-653	100
● black	280-671	100
● yellow	280-672	100
○ light gray ⑤	280-993 ③	100

4-conductor through terminal block		
Color	Item No.	Pack. Unit
○ gray	280-833	100
● blue	280-834 ②	100
● orange	280-835	100
● red	280-830	100
● black	280-831	100
● yellow	280-832	100
○ light gray ⑤	280-994 ③	100

2-conductor ground terminal block		
Color	Item No.	Pack. Unit
● green-yellow	280-907	100
● green-yellow ⑤	280-907/999-950 ④	100

3-conductor ground terminal block		
Color	Item No.	Pack. Unit
● green-yellow	280-687	100
● green-yellow ⑤	280-687/999-950 ④	100

4-conductor ground terminal block		
Color	Item No.	Pack. Unit
● green-yellow	280-837	100
● green-yellow ⑤	280-837/999-950 ④	100

4-conductor shield terminal block		
Color	Item No.	Pack. Unit
○ white	280-838	100

Other terminal blocks with the same profile:		
Diode	Item No.	Page
Diode	280-915/281-410	Page 330
Disconnect	280-912	Page 278
Carrier	280-916	Page 304

Other terminal blocks with the same profile:		
Diode	Item No.	Page
Diode	280-673/281-410	Page 330
Disconnect	280-683	Page 278
Carrier	280-610	Page 304

Other terminal blocks with the same profile:		
Diode	Item No.	Page
Diode	280-815/281-410	Page 330
LED	280-809/281-434	Page 330
Disconnect	280-836	Page 278
Disc./test	280-829	Page 278
Carrier	280-816	Page 304
Double-potential	280-826	Page 237

Accessories; item-specific		
End and intermediate plate; 2.5 mm thick		
orange	280-309	100 (25)
gray	280-308	100 (25)
light gray	280-356	100 (25)
Separator; oversized; 2 mm thick		
orange	280-311	100 (25)
gray	280-310	100 (25)
light gray	280-357	100 (25)
Ex e/Ex i separator; orange; 3 mm thick		
90 mm	209-190	50 (25)
120 mm	209-191	50 (25)

Accessories; item-specific		
End and intermediate plate; 2.5 mm thick		
orange	280-326	100 (25)
gray	280-324	100 (25)
light gray	280-358	100 (25)
Separator; oversized; 2 mm thick		
orange	280-346	100 (25)
gray	280-344	100 (25)
light gray	280-359	100 (25)
Ex e/Ex i separator; orange; 3 mm thick		
120 mm	209-191	50 (25)

Accessories; item-specific		
End and intermediate plate; 2.5 mm thick		
orange	280-315	100 (25)
gray	280-314	100 (25)
light gray	280-352	100 (25)
Separator; oversized; 2 mm thick		
orange	280-335	100 (25)
gray	280-334	100 (25)
light gray	280-353	100 (25)
Ex e/Ex i separator; orange; 3 mm thick		
120 mm	209-191	50 (25)

Spacer with same profile; for 2-conductor terminal blocks of horizontal type; 5 mm thick		
Color	Item No.	Pack. Unit
orange	280-902/056-000	100 (25)

Spacer with same profile; for 3-conductor terminal blocks of horizontal type; 5 mm thick		
Color	Item No.	Pack. Unit
orange	280-650/056-000	100 (25)

Spacer with same profile; for 4-conductor terminal blocks of horizontal type; 5 mm thick		
Color	Item No.	Pack. Unit
orange	280-835/056-000	100 (25)

Step-down cover plate; 1 mm thick		
Color	Item No.	Pack. Unit
gray	284-336	100 (25)
orange	284-346	100 (25)

5

Technical Data

0.08 ... 2.5 mm ²	28 ... 12 AWG*
800 V/8 kV/3 ①	600 V, 20 A ②
I _N 24 A	600 V, 25 A ③
Terminal block width: 5 mm / 0.197 inch	
 8 ... 9 mm / 0.31 ... 0.35 inch	

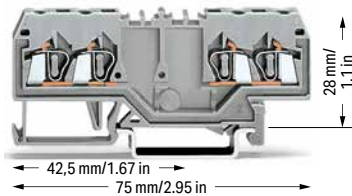

Double-potential terminal block; with double, center marking level

Color	Item No.	Pack. Unit
○ gray	280-826	100
○ light gray ③	280-995 ③	100







Notice: These double-potential terminal blocks cannot be commoned via adjacent jumpers!
Front-entry double-potential terminal blocks are space savers.

Two independent feedthrough circuits are placed in one insulated housing on one level in just 5 mm. This achieves a width of just 2.5 mm versus standard through terminal blocks.

Input and output of a circuit are placed on the same side of the terminal block. Both circuits can be individually marked according to input and output.

For technical data and accessories, see www.wago.com

Accessories; item-specific

End and intermediate plate; 2.5 mm thick		
	orange 280-315	100 (25)
	gray 280-314	100 (25)
	light gray 280-352	100 (25)
Separator; oversized; 2 mm thick		
	orange 280-335	100 (25)
	gray 280-334	100 (25)
	light gray 280-353	100 (25)

* 12 AWG: THHN, THWN

- 800 V = rated voltage
8 kV = rated impulse voltage
3 = pollution degree
(see Section 14)
- Terminal blocks with a blue insulated housing are suitable for Ex i applications.
- Terminal blocks with an Ex mark are suitable for Ex e II applications.
0.2 ... 2.5 mm²/24 ... 12 AWG*
550 V
23 A, for 2-conductor terminal blocks
22 A, for 3-conductor terminal blocks
20 A, for 4-conductor terminal blocks
(see Section 14)
Using staggered jumpers reduces the maximum rated voltage to 275 V.

Please observe the application notes:
Insulation stop, page 346
Jumpers, from page 348
Step-down jumper, page 250
Comb-style jumper bar, page 347
Testing accessories, from page 342
Marking, from page 588

Approvals and corresponding ratings, visit www.wago.com

Accessories; 280 Series

Appropriate marking systems:
WMB/WMB Inline/WFB

Insulation stop; 0.08 ... 0.2 mm² "s" (0.14 mm² "f-st"); 5 pcs/strip

	white	280-470	200 (25)
---	-------	---------	----------

Insulation stop; 0.25 ... 0.5 mm²; 5 pcs/strip

	light gray	280-471	200 (25)
---	------------	---------	----------

Insulation stop; 0.75 ... 1 mm²; 5 pcs/strip

	dark gray	280-472	200 (25)
---	-----------	---------	----------

Protective warning marker; with black high-voltage symbol; for 5 terminal blocks

	yellow	280-415	100 (25)
---	--------	---------	----------

Adjacent jumper; insulated; I_N = I_N terminal block

	gray	280-402	200 (25)
	yellow-green	280-422	200 (25)

Alternate jumper, insulated; I_N = I_N terminal block

	gray	280-409	100 (25)
---	------	---------	----------

Staggered jumper; insulated; 5 mm wide; I_N 24 A

	1 to 2	780-452	100 (25)
	1 to 3	780-453	100 (25)
	1 to 4	780-454	100 (25)
	1 to 5	780-455	50 (25)
	1 to 6	780-456	50 (25)
	1 to 7	780-457	50 (25)
	1 to 8	780-458	50 (25)

Push-in type wire jumper; insulated; 0.75 mm² conductor cross section; I_N 9 A

	L = 60 mm	249-125	100 (10)
	L = 110 mm	249-126	100 (10)
	L = 250 mm	249-127	100 (10)



Accessories; 280 Series

Appropriate marking systems:
WMB/WMB Inline/WFB

Step-down jumper; insulated; commons 10/6 mm² (8/10 AWG) down to 4/2.5/1.5 mm² (12/14/16 AWG); I_N 15 A

	gray	284-414	50 (25)
---	------	---------	---------

Cover plate; 1 mm thick; for 2-, 3- and 4-conductor terminal blocks

	gray	284-334	100 (25)
	orange	284-344	100 (25)

Comb-style jumper bar; insulated; I_N = I_N of terminal block

	2-way	280-482	200 (25)
	3-way	280-483	200 (25)



Comb-style jumper bar; insulated; I_N = I_N of terminal block

	10-way	280-490	50 (25)
---	--------	---------	---------

Alternate comb-style jumper bar; insulated; I_N = I_N of terminal block

	2-way	280-492	200 (25)
---	-------	---------	----------

Operating tool; insulated

	2-way	280-432	1
	3-way	280-433	1

Operating tool; insulated

	10-way	280-440	1
---	--------	---------	---

Test plug module; snaps together; 5 mm wide

	gray	280-418	100 (25)
---	------	---------	----------

Spacer module; snaps together; 5 mm wide

	gray	280-419	100 (25)
---	------	---------	----------

Test plug adapter; 8.3 mm wide; for 4 mm Ø test plug; for 1.5 ... 10 mm² terminal blocks

	gray	209-170	50 (25)
---	------	---------	---------

Banana plug; for 4 mm socket diameter; color mixed; 10 x orange, white, black, blue, yellow; max. 42 V

		215-111	50
---	--	---------	----

Test plug adapter; 5 mm wide; for 210-137 Test Plug (2.3 mm Ø); for 1.5 ... 4 mm² terminal blocks

	gray	280-404	100 (25)
---	------	---------	----------

Test plug adapter; 6 mm wide; with CAGE CLAMP®; for 0.08 ... 2.5 mm²

	I _N 24 A	281-407	100 (25)
---	---------------------	---------	----------

Test plug; with 500 mm cable; 2 mm Ø; max. 42 V

	red	210-136	50
---	-----	---------	----

Through/Ground Conductor/Shield Conductor and Ex Terminal Block

2.5 mm²; 280 Series

Technical Data

0.08 ... 2.5 mm ²	28 ... 12 AWG*
800 V/8 kV/3 ①	600 V, 20 A ②
I _N 24 A	
Terminal block width: 5 mm / 0.197 inch	
 8 ... 9 mm / 0.31 ... 0.35 inch	

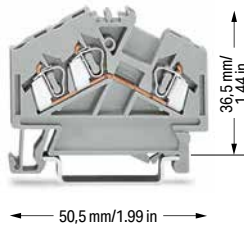

3-conductor through terminal block

Color	Item No.	Pack. Unit
gray	280-641	100
blue	280-651 ②	100
orange	280-654	100
light gray ③	280-998 ③	100

3-conductor ground terminal block

green-yellow	280-637	100
green-yellow ③	280-637/999-950 ③	100

3-conductor shield terminal block

white	280-640	100
-------	---------	-----

Accessories; 280 Series

Appropriate marking systems:
WMB/WMB Inline/WFB

End and intermediate plate; 2.5 mm thick

 orange	280-313	100 (25)
gray	280-312	100 (25)
light gray	280-354	100 (25)

Separator; oversized; 2 mm thick

 orange	280-318	100 (25)
gray	280-348	100 (25)
light gray	280-355	100 (25)

Ex e/Ex i separator; orange; 3 mm thick

 120 mm	209-191	50 (25)
---	---------	---------

Spacer with same profile; for 3- and 4-conductor terminal blocks (angled type); 5 mm thick

 orange	280-654/056-000	100 (25)
---	-----------------	----------

Insulation stop; 0.08 ... 0.2 mm² "s" (0.14 mm² "f-st"); 5 pcs/strip

 white	280-470	200 (25)
--	---------	----------

Insulation stop; 0.25 ... 0.5 mm²; 5 pcs/strip

 light gray	280-471	200 (25)
---	---------	----------

Insulation stop; 0.75 ... 1 mm²; 5 pcs/strip

 dark gray	280-472	200 (25)
--	---------	----------

* 12 AWG: THHN, THWN

- 800 V = rated voltage
8 kV = rated impulse voltage
3 = pollution degree
(see Section 14)
- Terminal blocks with a blue insulated housing are suitable for Ex i applications.
- Terminal blocks with an Ex mark are suitable for Ex e II applications.
0.2 ... 2.5 mm² / 24 ... 12 AWG*
550 V; 23 A
(see Section 14)
Using staggered jumpers reduces the maximum rated voltage to 275 V.
- Please observe the application notes:
Insulation stop, page 346
Jumpers, from page 348
Comb-style jumper bar, page 347
Testing accessories, from page 342
Marking, from page 588

Approvals and corresponding ratings,
visit www.wago.com

Accessories; 280 Series

Appropriate marking systems:
WMB/WMB Inline/WFB

Adjacent jumper; insulated; I_N = I_N terminal block

 gray	280-402	200 (25)
yellow-green	280-422	200 (25)

Alternate jumper; insulated; I_N = I_N terminal block

 gray	280-409	100 (25)
--	---------	----------

Staggered jumper; insulated; 5 mm wide; I_N 24 A

 1 to 2	780-452	100 (25)
1 to 3	780-453	100 (25)
1 to 4	780-454	100 (25)
1 to 5	780-455	50 (25)
1 to 6	780-456	50 (25)
1 to 7	780-457	50 (25)
1 to 8	780-458	50 (25)

Push-in type wire jumper; insulated; 0.75 mm² conductor cross section; I_N 9 A

 L = 60 mm	249-125	100 (10)
L = 110 mm	249-126	100 (10)
L = 250 mm	249-127	100 (10)

Comb-style jumper bar; insulated; I_N = I_N of terminal block

 2-way	280-482	200 (25)
3-way	280-483	200 (25)

Comb-style jumper bar; insulated; I_N = I_N of terminal block

 10-way	280-490	50 (25)
--	---------	---------

Alternate comb-style jumper bar; insulated; I_N = I_N of terminal block

 2-way	280-492	200 (25)
---	---------	----------

Operating tool; insulated

 2-way	280-432	1
3-way	280-433	1
10-way	280-440	1

Protective warning marker; with black high-voltage symbol; for 5 terminal blocks

 yellow	280-415	100 (25)
--	---------	----------

Accessories; 280 Series

Appropriate marking systems:
WMB/WMB Inline/WFB

Test plug module; snaps together; 5 mm wide

 gray	280-418	100 (25)
--	---------	----------

Spacer module; snaps together; 5 mm wide

 gray	280-419	100 (25)
--	---------	----------

Test plug adapter; 8.3 mm wide; for 4 mm Ø test plug; for 1.5 ... 10 mm² terminal blocks

 gray	209-170	50 (25)
--	---------	---------

Banana plug; for 4 mm socket diameter; color mixed; 10 x orange, white, black, blue, yellow; max. 42 V

 215-111	50
---	----

Test plug adapter; 5 mm wide; for 210-137 Test Plug (2.3 mm Ø); for 1.5 ... 4 mm² terminal blocks

 gray	280-404	100 (25)
--	---------	----------

Test plug adapter; 6 mm wide; with CAGE CLAMP®; for 0.08 ... 2.5 mm²

 I _N 24 A	281-407	100 (25)
---	---------	----------

Test plug; with 500 mm cable; 2 mm Ø; max. 42 V

 red	210-136	50
---	---------	----

Test plug; with 500 mm cable; 2.3 mm Ø; max. 42 V

 yellow	210-137	50
--	---------	----

WMB Inline, plain; 1,500 WMB markers (5 mm)/reel; 5 ... 5.2 mm stretchable

 white	2009-115	1
---	----------	---

WMB marking card; white; 10 strips with 10 markers/card; stretchable 5 ... 5.2 mm

 plain	793-5501	5
---	----------	---

WMB marking card; plain; 10 strips with 10 markers/card; stretchable 5 ... 5.2 mm

 yellow	793-5501/000-002	5
red	793-5501/000-005	5
blue	793-5501/000-006	5
gray	793-5501/000-007	5
orange	793-5501/000-012	5
light green	793-5501/000-017	5
green	793-5501/000-023	5
violet	793-5501/000-024	5

Screwless end stop; for DIN-35 rail; 6 mm wide

 gray	249-116	100 (25)
--	---------	----------

Through and Ex Terminal Block 2.5 mm²; 280 Series

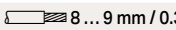
Technical Data	
0.08 ... 2.5 mm ²	28 ... 12 AWG*
800 V/8 kV/3 ①	600 V, 20 A ②
I _N 24 A	600 V, 25 A ③
Terminal block width: 5 mm / 0.197 inch	
 8 ... 9 mm / 0.31 ... 0.35 inch	

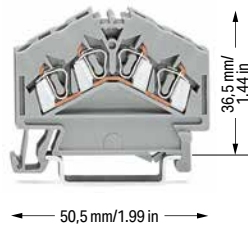

4-conductor through terminal block
Notice: These terminal blocks cannot be commoned using adjacent jumpers.

Color	Item No.	Pack. Unit
gray	280-646	100
blue	280-656 ②	100
orange	280-946	100
light gray ③	280-996 ③	100

Accessories; 280 Series
Appropriate marking systems:
WMB/WMB Inline/WFB

End and intermediate plate; 2.5 mm thick

orange	280-313	100 (25)
gray	280-312	100 (25)
light gray	280-354	100 (25)

Separator; oversized; 2 mm thick

orange	280-318	100 (25)
gray	280-348	100 (25)
light gray	280-355	100 (25)

Ex e/Ex i separator; orange; 3 mm thick

120 mm	209-191	50 (25)
--------	---------	---------

Spacer with same profile; for 3- and 4-conductor terminal blocks (angled type); 5 mm thick

orange	280-654/056-000	100 (25)
--------	-----------------	----------

Insulation stop; 0.08 ... 0.2 mm² "s" (0.14 mm² "f-st"); 5 pcs/strip

white	280-470	200 (25)
-------	---------	----------

Insulation stop; 0.25 ... 0.5 mm²; 5 pcs/strip

light gray	280-471	200 (25)
------------	---------	----------

Insulation stop; 0.75 ... 1 mm²; 5 pcs/strip

dark gray	280-472	200 (25)
-----------	---------	----------

Protective warning marker; with black high-voltage symbol; for 5 terminal blocks

yellow	280-415	100 (25)
--------	---------	----------

* 12 AWG: THHN, THWN

① 800 V = rated voltage
8 kV = rated impulse voltage
3 = pollution degree
(see Section 14)

② Terminal blocks with a blue insulated housing are suitable for Ex i applications.

③ Terminal blocks with an Ex mark are suitable for Ex e II applications.
0.2 ... 2.5 mm² / 24 ... 12 AWG*
550 V; 23 A
(see Section 14)

Please observe the application notes:
Insulation stop, page 346
Comb-style jumper bar, page 347
Testing accessories, from page 342
Marking, from page 588

Approvals and corresponding ratings, visit www.wago.com

Accessories; 280 Series

Appropriate marking systems:
WMB/WMB Inline/WFB

Comb-style jumper bar; insulated; I_N = I_N of terminal block

2-way	280-482	200 (25)
3-way	280-483	200 (25)

Comb-style jumper bar; insulated; I_N = I_N of terminal block

10-way	280-490	50 (25)
--------	---------	---------

Alternate comb-style jumper bar; insulated; I_N = I_N of terminal block

2-way	280-492	200 (25)
-------	---------	----------

Operating tool; insulated

2-way	280-432	1
3-way	280-433	1

Operating tool; insulated

10-way	280-440	1
--------	---------	---

Test plug module; snaps together; 5 mm wide

gray	249-141	100 (25)
------	---------	----------

WMB Inline, plain; 1,500 WMB markers (5 mm)/reel; 5 ... 5.2 mm stretchable

white	2009-115	1
-------	----------	---

WMB marking card; white; 10 strips with 10 markers/card; stretchable 5 ... 5.2 mm

plain	793-5501	5
-------	----------	---

WMB marking card; plain; 10 strips with 10 markers/card; stretchable 5 ... 5.2 mm

yellow	793-5501/000-002	5
red	793-5501/000-005	5
blue	793-5501/000-006	5
gray	793-5501/000-007	5
orange	793-5501/000-012	5
light green	793-5501/000-017	5
green	793-5501/000-023	5
violet	793-5501/000-024	5

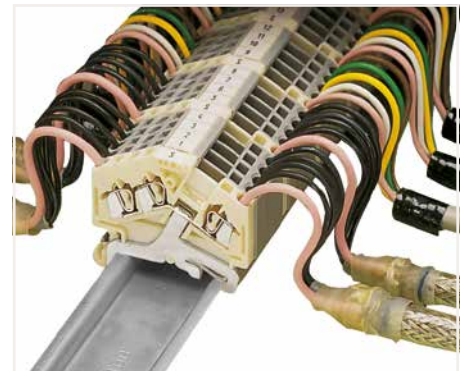

Application example for shield conductor terminal blocks

Shielded control cables are becoming an increasingly common solution to external signal interference. Front-entry shield conductor terminal blocks are ideal for connecting braided cables. Like front-entry ground conductor terminal blocks, they are equipped with a grounding foot for direct electrical connection to the rail, however they differ significantly by their white insulated housing. Shield conductor terminal blocks for front-entry wiring can be directly mounted beside signal-conductor terminal blocks, providing excellent deflection of interfering signals.

Through and Ground Conductor Terminal Block; Suited for Specialty 12 AWG Conductors with Ferrule (216-206); Terminal Block Width: 5 mm 4 mm²; 880 Series

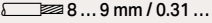
Technical Data	
0.08 ... 4 mm ²	28 ... 12 AWG
800 V/8 kV/3 ①	600 V, 20 A, I_N
I_N 25 A	
Terminal block width: 5 mm / 0.197 inch	
 8 ... 9 mm / 0.31 ... 0.35 inch	

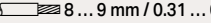
Technical Data	
0.08 ... 4 mm ²	28 ... 12 AWG
800 V/8 kV/3 ①	600 V, 20 A, I_N
I_N 25 A	
Terminal block width: 5 mm / 0.197 inch	
 8 ... 9 mm / 0.31 ... 0.35 inch	

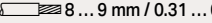
Technical Data	
0.08 ... 4 mm ²	28 ... 12 AWG
800 V/8 kV/3 ①	600 V, 20 A, I_N
I_N 20 A	
Terminal block width: 5 mm / 0.197 inch	
 8 ... 9 mm / 0.31 ... 0.35 inch	

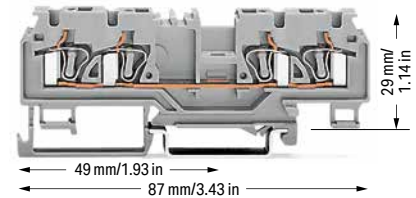
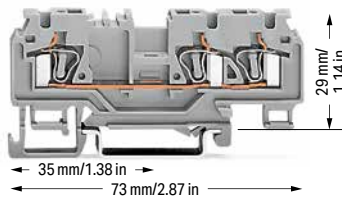
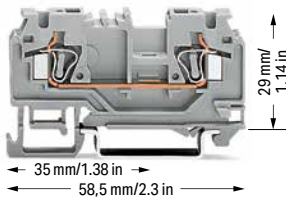

2-conductor through terminal block; no shield contact; with test slot for 2 and 2.3 mm Ø test plugs; for specialty conductors; 4.4 mm insulation diameter (max.)

Color	Item No.	Pack. Unit
gray	880-901/999-940	100
blue	880-904/999-940 ②	100
orange	880-902/999-940	100

3-conductor through terminal block; no shield contact; with test slot for 2 and 2.3 mm Ø test plugs; for specialty conductors; 4.4 mm insulation diameter (max.)

Color	Item No.	Pack. Unit
gray	880-681/999-940	100
blue	880-684/999-940 ②	100
orange	880-682/999-940	100

4-conductor through terminal block; no shield contact; with test slot for 2 and 2.3 mm Ø test plugs; for specialty conductors; 4.4 mm insulation diameter (max.)

Color	Item No.	Pack. Unit
gray	880-831/999-940	100
blue	880-834/999-940 ②	100
orange	880-832/999-940	100

2-conductor through terminal block; with shield contact

3-conductor through terminal block; with shield contact

4-conductor through terminal block; with shield contact

2-conductor ground terminal block		
green-yellow	880-907/999-940	100

3-conductor ground terminal block		
green-yellow	880-687/999-940	100

4-conductor ground terminal block		
green-yellow	880-837/999-940	100

Accessories; item-specific

End and intermediate plate; 2.5 mm thick

orange	880-328	100 (25)
gray	880-325	100 (25)

Accessories; item-specific

End and intermediate plate; 2.5 mm thick

orange	880-339	100 (25)
gray	880-308	100 (25)

Accessories; item-specific

End and intermediate plate; 2.5 mm thick

orange	880-346	100 (25)
gray	880-344	100 (25)

Separator; oversized; 2 mm thick

orange	880-329	100 (25)
gray	880-326	100 (25)

Separator; oversized; 2 mm thick

orange	880-340	100 (25)
gray	880-309	100 (25)

Separator; oversized; 2 mm thick

orange	880-347	100 (25)
gray	880-345	100 (25)

Accessories; 880 Series

Appropriate marking systems: WMB/WMB Inline/Mini-WSB/Mini-WSB Inline/WFB

Insulation stop; 0.08 ... 0.2 mm² "s" (0.14 mm² "f-st"); 5 pcs/strip

white	280-470	200 (25)
-------	---------	----------

Staggered jumper; insulated; 5 mm wide; I_N 24 A

1 to 2	780-452	100 (25)
1 to 3	780-453	100 (25)
1 to 4	780-454	100 (25)
1 to 5	780-455	50 (25)
1 to 6	780-456	50 (25)
1 to 7	780-457	50 (25)
1 to 8	780-458	50 (25)

Operating tool; insulated

2-way	280-432	1
3-way	280-433	1

Insulation stop; 0.25 ... 0.5 mm²; 5 pcs/strip

light gray	280-471	200 (25)
------------	---------	----------

Push-in type wire jumper; insulated; 0.75 mm² conductor cross section; I_N 9 A

L = 60 mm	249-125	100 (10)
L = 110 mm	249-126	100 (10)
L = 250 mm	249-127	100 (10)

Operating tool; insulated

10-way	280-440	1
--------	---------	---

Insulation stop; 0.75 ... 1 mm²; 5 pcs/strip

dark gray	280-472	200 (25)
-----------	---------	----------

Comb-style jumper bar; insulated; $I_N = I_N$ of terminal block

2-way	280-482	200 (25)
3-way	280-483	200 (25)

Test plug module; snaps together; 5 mm wide

gray	280-418	100 (25)
------	---------	----------

Protective warning marker; with black high-voltage symbol; for 5 terminal blocks

yellow	280-415	100 (25)
--------	---------	----------

Comb-style jumper bar; insulated; $I_N = I_N$ of terminal block

10-way	280-490	50 (25)
--------	---------	---------

Spacer module; snaps together; 5 mm wide

gray	280-419	100 (25)
------	---------	----------

Adjacent jumper; insulated; $I_N = I_N$ terminal block

gray	280-402	200 (25)
yellow-green	280-422	200 (25)

Alternate comb-style jumper bar; insulated; $I_N = I_N$ of terminal block

2-way	280-492	200 (25)
-------	---------	----------

Test plug adapter; 8.3 mm wide; for 4 mm Ø test plug; for 1.5 ... 10 mm² terminal blocks

gray	209-170	50 (25)
------	---------	---------

- ① 800 V = rated voltage
8 kV = rated impulse voltage
3 = pollution degree

with shield contact
400 V/6 kV/3
300 V/10 A
(see Section 14)

- ② Terminal blocks with a blue insulated housing are suitable for Ex i applications.

Please observe the application notes:
Insulation stop, page 346
Jumpers, from page 348
Comb-style jumper bar, page 347
Testing accessories, from page 342
Marking, from page 588

Approvals and corresponding ratings, visit www.wago.com

Accessories; 880 Series

Appropriate marking systems:
WMB/WMB Inline/Mini-WSB/Mini-WSB Inline/WFB

Banana plug; for 4 mm socket diameter; color mixed; 10 x orange, white, black, blue, yellow; max. 42 V



215-111 50

Test plug adapter; 5 mm wide; for 210-137 Test Plug (2.3 mm Ø); for 1.5 ... 4 mm² terminal blocks



gray 280-404 100 (25)

Test plug adapter; 6 mm wide; with CAGE CLAMP®; for 0.08 ... 2.5 mm²



I_N 24 A 281-407 100 (25)

Test plug; with 500 mm cable; 2 mm Ø; max. 42 V



red 210-136 50

Test plug; with 500 mm cable; 2.3 mm Ø; max. 42 V



yellow 210-137 50

WMB Inline, plain; 1,500 WMB markers (5 mm)/reel; 5 ... 5.2 mm stretchable



white 2009-115 1

WMB marking card; white; 10 strips with 10 markers/card; stretchable 5 ... 5.2 mm



plain 793-5501 5

WMB marking card; plain; 10 strips with 10 markers/card; stretchable 5 ... 5.2 mm



yellow	793-5501/000-002	5
red	793-5501/000-005	5
blue	793-5501/000-006	5
gray	793-5501/000-007	5
orange	793-5501/000-012	5
light green	793-5501/000-017	5
green	793-5501/000-023	5
violet	793-5501/000-024	5

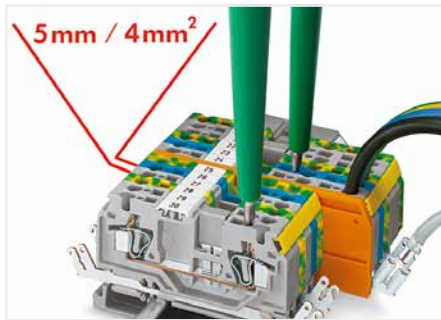

Features:

- 2-, 3- and 4-conductor terminal blocks, just 5 mm wide
- Conductor cross sections up to 4 mm² (per VDE 0281) or 12 AWG with ferrule (Item No. 216-206)
- 2.5 mm² rubber-insulated conductors, with outer diameter up to 4.4 mm
- Shield contact, solder/quick-connect contact 6.3 (2 x 2.8) mm
- Test plug, red, 2 mm Ø
- Test plug, yellow, 2.3 mm Ø
- WMB markers
- Mini-WSB markers, on both sides
- Commoning with WAGO jumper systems

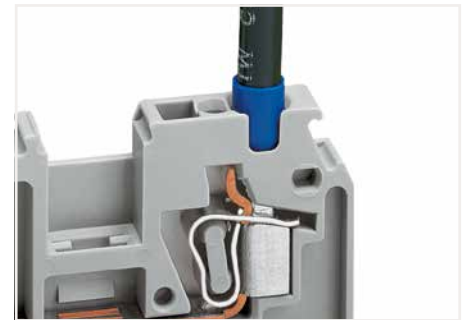

Using a 12 AWG conductor with ferrule.
Item No. 216-206

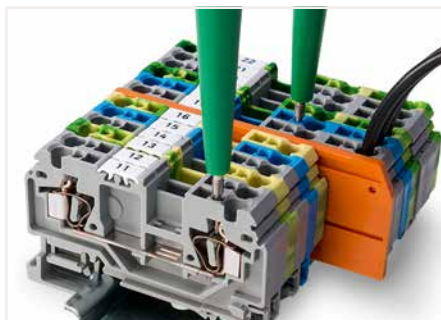

880 Series Terminal Blocks have an additional test slot for the 2-pole voltage tester.

Sold & Serviced By:

 **ELECTROMATE**

Toll Free Phone (877) SERV098
www.electromate.com
sales@electromate.com

Through/Ground Conductor/Shield Conductor and Ex Terminal Block 4 mm²; 281 Series

Technical Data	
0.08 ... 4 mm ²	28 ... 12 AWG
800 V/8 kV/3 ①	600 V, 20 A ②
I _N 32 A	600 V, 25 A ③
Terminal block width: 6 mm / 0.236 inch	
9 ... 10 mm / 0.35 ... 0.39 inch	

Technical Data	
0.08 ... 4 mm ²	28 ... 12 AWG
800 V/8 kV/3 ①	600 V, 20 A ②
I _N 32 A	600 V, 25 A ③
Terminal block width: 6 mm / 0.236 inch	
9 ... 10 mm / 0.35 ... 0.39 inch	

Technical Data	
0.08 ... 4 mm ²	28 ... 12 AWG
800 V/8 kV/3 ①	600 V, 20 A ②
I _N 26 A	600 V, 25 A ③
Terminal block width: 6 mm / 0.236 inch	
9 ... 10 mm / 0.35 ... 0.39 inch	

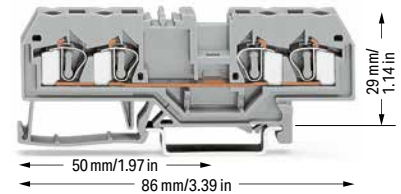
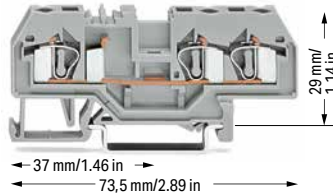
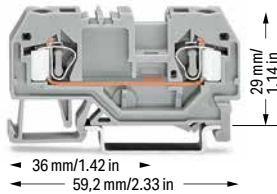

2-conductor through terminal block		
Color	Item No.	Pack. Unit
gray	281-901	50
blue	281-904 ②	50
orange	281-902	50
red	281-903	50
black	281-905	50
yellow	281-906	50
light gray ⑤	281-992 ③	50

3-conductor through terminal block		
Color	Item No.	Pack. Unit
gray	281-681	50
blue	281-684 ②	50
orange	281-678	50
red	281-679	50
black	281-685	50
yellow	281-686	50
light gray ⑤	281-993 ③	50

4-conductor through terminal block		
Color	Item No.	Pack. Unit
gray	281-652	50
blue	281-654 ②	50
orange	281-653	50
red	281-663	50
black	281-664	50
yellow	281-668	50
light gray ⑤	281-994 ③	50

2-conductor ground terminal block		
green-yellow	281-907	50
green-yellow ⑤	281-907/999-950 ③	50

3-conductor ground terminal block		
green-yellow	281-687	50
green-yellow ⑤	281-687/999-950 ③	50

4-conductor ground terminal block		
green-yellow	281-657	50
green-yellow ⑤	281-657/999-950 ③	50

4-conductor shield terminal block		
white	281-658	50

Other terminal blocks with the same profile:		
Diode	281-915/281-410	Page 332
Disconnect	281-912	Page 280
Carrier	281-916	Page 248

Other terminal blocks with the same profile:		
Diode	281-673/281-410	Page 332
Disconnect	281-683	Page 280
Carrier	281-610	Page 248

Other terminal blocks with the same profile:		
Diode	281-665/281-410	Page 332
Disconnect	281-659	Page 280
Disc./test	281-666	Page 280
Carrier	281-656	Page 302

Accessories; item-specific			
End and intermediate plate; 2.5 mm thick			
orange	281-329	100 (25)	
gray	281-328	100 (25)	
light gray	281-349	100 (25)	
Separator; oversized; 2 mm thick			
orange	281-331	100 (25)	
gray	281-330	100 (25)	
light gray	281-350	100 (25)	
Ex e/Ex i separator; orange; 3 mm thick			
90 mm	209-190	50 (25)	
120 mm	209-191	50 (25)	

Accessories; item-specific			
End and intermediate plate; 2.5 mm thick			
orange	281-326	100 (25)	
gray	281-324	100 (25)	
light gray	281-355	100 (25)	
Separator; oversized; 2 mm thick			
orange	281-346	100 (25)	
gray	281-344	100 (25)	
light gray	281-356	100 (25)	
Ex e/Ex i separator; orange; 3 mm thick			
120 mm	209-191	50 (25)	

Accessories; item-specific			
End and intermediate plate; 2.5 mm thick			
orange	281-335	100 (25)	
gray	281-334	100 (25)	
light gray	281-345	100 (25)	
Separator; oversized; 2 mm thick			
orange	281-339	100 (25)	
gray	281-338	100 (25)	
light gray	281-347	100 (25)	
Ex e/Ex i separator; orange; 3 mm thick			
120 mm	209-191	50 (25)	
Step-down cover plate; 1 mm thick			
gray	284-336	100 (25)	
orange	284-346	100 (25)	

Accessories; 281 Series

Appropriate marking systems: WMB/WMB Inline/WFB

Insulation stop; 0.08 ... 0.2 mm ² "s" (0.14 mm ² "f-st"); 5 pcs/strip		
white	281-470	200 (25)

Insulation stop; 0.25 ... 0.5 mm ² ; 5 pcs/strip		
light gray	281-471	200 (25)

Insulation stop; 0.75 ... 1.5 mm ² ; 5 pcs/strip		
dark gray	281-472	200 (25)

Technical Data

0.08 ... 4 mm ²	28 ... 12 AWG
800 V/8 kV/3 ①	600 V, 20 A ②
I _N 32 A	600 V, 25 A ③
Terminal block width: 6 mm / 0.236 inch	
9 ... 10 mm / 0.35 ... 0.39 inch	

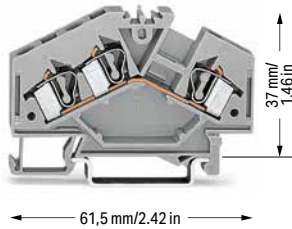

3-conductor through terminal block

Color	Item No.	Pack. Unit
gray	281-631	100
blue	281-651 ②	100
light gray ③	281-998 ③	100

3-conductor ground terminal block

green-yellow	281-637	100
green-yellow ③	281-637/999-950 ③	100

Accessories; item-specific

End and intermediate plate; 2.5 mm thick

orange	281-313	100 (25)
gray	281-312	100 (25)
light gray	281-357	100 (25)

Separator; oversized; 2 mm thick

orange	281-318	100 (25)
gray	281-348	100 (25)
light gray	281-358	100 (25)

Protective warning marker; with black high-voltage symbol; for 5 terminal blocks

yellow	281-415	100 (25)
--------	---------	----------

① 800 V = rated voltage
8 kV = rated impulse voltage
3 = pollution degree
(see Section 14)

② Terminal blocks with a blue insulated housing are suitable for Ex i applications.

③ Terminal blocks with an Ex mark are suitable for Ex e II applications.
0.2 ... 4 mm² / 24 ... 12 AWG
550 V; 30 A
(see Section 14)
Using staggered jumpers reduces the maximum rated voltage to 275 V.

Please observe the application notes:
Insulation stop, page 346
Jumpers, from page 348
Comb-style jumper bar, page 347
Testing accessories, from page 342
Marking, from page 588

Approvals and corresponding ratings, visit www.wago.com

Accessories; 281 Series

Appropriate marking systems:
WMB/WMB Inline/WFB

Adjacent jumper; insulated; I_N = I_N terminal block

gray	281-402	200 (25)
yellow-green	281-422	200 (25)

Alternate jumper, insulated; I_N = I_N terminal block

gray	281-409	100 (25)
------	---------	----------

Staggered jumper; insulated; 6 mm wide; I_N 32 A

1 to 2	781-452	100 (25)
1 to 3	781-453	100 (25)
1 to 4	781-454	100 (25)
1 to 5	781-455	50 (25)
1 to 6	781-456	50 (25)

Push-in type wire jumper; insulated; 0.75 mm² conductor cross section; I_N 9 A

L = 60 mm	249-125	100 (10)
L = 110 mm	249-126	100 (10)
L = 250 mm	249-127	100 (10)

Step-down jumper; insulated; commons 10/6 mm² (8/10 AWG) down to 6/4 mm² (10/12 AWG); I_N 30 A

gray	284-413	50 (25)
------	---------	---------

Cover plate; 1 mm thick; for 2-, 3- and 4-conductor terminal blocks

gray	284-334	100 (25)
orange	284-344	100 (25)

Comb-style jumper bar; insulated; I_N = I_N of terminal block

2-way	281-482	100 (25)
3-way	281-483	100 (25)
5-way	281-485	100 (25)
10-way	281-490	50 (25)

Alternate comb-style jumper bar; insulated; I_N = I_N of terminal block

2-way	281-492	100 (25)
-------	---------	----------

Operating tool; insulated

2-way	280-432	1
3-way	280-433	1
5-way	281-440	1

Accessories; 281 Series

Appropriate marking systems:
WMB/WMB Inline/WFB

Test plug module; snaps together; 5 mm wide

gray	281-418	100 (25)
------	---------	----------

Spacer module; snaps together; 5 mm wide

gray	281-419	100 (25)
------	---------	----------

Test plug adapter; 8.3 mm wide; for 4 mm Ø test plug; for 1.5 ... 10 mm² terminal blocks

gray	209-170	50 (25)
------	---------	---------

Banana plug; for 4 mm socket diameter; color mixed; 10 x orange, white, black, blue, yellow; max. 42 V

	215-111	50
--	---------	----

Test plug adapter; 5 mm wide; for 210-137 Test Plug (2.3 mm Ø); for 1.5 ... 4 mm² terminal blocks

gray	280-404	100 (25)
------	---------	----------

Test plug adapter; 6 mm wide; with CAGE CLAMP®; for 0.08 ... 2.5 mm²

I _N 24 A	281-407	100 (25)
---------------------	---------	----------

Test plug; with 500 mm cable; 2 mm Ø; max. 42 V

red	210-136	50
-----	---------	----

Test plug; with 500 mm cable; 2.3 mm Ø; max. 42 V

yellow	210-137	50
--------	---------	----

WMB Inline, plain; 1,500 WMB markers (5 mm)/reel; 5 ... 5.2 mm stretchable

white	2009-115	1
-------	----------	---

WMB marking card; white; 10 strips with 10 markers/card; stretchable 5 ... 5.2 mm

plain	793-5501	5
-------	----------	---

WMB marking card; plain; 10 strips with 10 markers/card; stretchable 5 ... 5.2 mm

yellow	793-5501/000-002	5
red	793-5501/000-005	5
blue	793-5501/000-006	5
gray	793-5501/000-007	5
orange	793-5501/000-012	5
light green	793-5501/000-017	5
green	793-5501/000-023	5
violet	793-5501/000-024	5

Screwless end stop; for DIN-35 rail; 6 mm wide

gray	249-116	100 (25)
------	---------	----------

Through/Ground Conductor and Ex Terminal Block 6 mm²; 282 Series

Technical Data	
0.2 ... 6 mm ²	24 ... 10 AWG
800 V/8 kV/3 ①	600 V, 30 A ②
I _N 41 A	600 V, 40 A ③
Terminal block width: 8 mm / 0.315 inch	
12 ... 13 mm / 0.47 ... 0.51 inch	

Technical Data	
0.2 ... 6 mm ²	24 ... 10 AWG
800 V/8 kV/3 ①	600 V, 30 A ②
I _N 41 A	600 V, 40 A ③
Terminal block width: 8 mm / 0.315 inch	
12 ... 13 mm / 0.47 ... 0.51 inch	

- ① 800 V = rated voltage
8 kV = rated impulse voltage
3 = pollution degree
(see Section 14)
- ② Terminal blocks with a blue insulated housing are suitable for Ex i applications.
- ③ Terminal blocks with an Ex mark are suitable for Ex e II applications.
0.5 ... 6 mm² / 20 ... 10 AWG
550 V; 39 A
35 A jumper
(see Section 14)

Please observe the application notes:
Step-down jumper, page 250
Test plug module, page 345
Marking, from page 588

Approvals and corresponding ratings,
visit www.wago.com

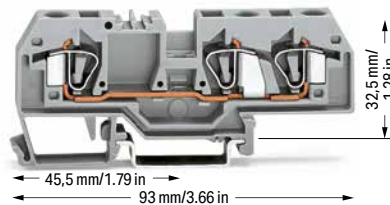
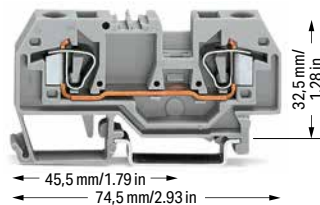

2-conductor through terminal block		
Color	Item No.	Pack. Unit
gray	282-901	50
blue	282-904 ②	50
orange	282-902	50
light gray ③	282-992 ③	50

3-conductor through terminal block		
Color	Item No.	Pack. Unit
gray	282-681	25
blue	282-684 ②	25
orange	282-682	25
light gray ③	282-993 ③	50

2-conductor ground terminal block		
green-yellow	282-907	50
green-yellow ③	282-907/999-950 ③	50

3-conductor ground terminal block		
green-yellow	282-687	25
green-yellow ③	282-687/999-950 ③	50

Accessories; item-specific

End and intermediate plate; 2.5 mm thick		
orange	282-328	100 (25)
gray	282-325	100 (25)
light gray	282-330	100 (25)

Accessories; item-specific

End and intermediate plate; 2.5 mm thick		
orange	282-339	100 (25)
gray	282-308	100 (25)
light gray	282-341	100 (25)

Separator; oversized; 2 mm thick		
orange	282-329	100 (25)
gray	282-326	100 (25)
light gray	282-331	100 (25)

Separator; oversized; 2 mm thick		
orange	282-340	100 (25)
gray	282-309	100 (25)
light gray	282-342	100 (25)

Step-down cover plate; 1 mm thick		
gray	282-357	100 (25)
orange	282-367	100 (25)

Step-down cover plate; 1 mm thick		
gray	282-358	100 (25)
orange	282-368	100 (25)

Accessories; 282 Series

Appropriate marking systems: WMB/WMB Inline/WFB

Ex e/Ex i separator; orange; 3 mm thick		
120 mm	209-191	50 (25)

Step-down jumper; insulated; commons 10/6 mm ² (8/10 AWG) down to 6/4 mm ² (10/12 AWG); I _N 30 A		
gray	284-413	50 (25)

Protective warning marker; with black high-voltage symbol; for 5 terminal blocks		
yellow	282-415	100 (25)

Test plug adapter; 8.3 mm wide; for 4 mm Ø test plug; for 1.5 ... 10 mm ² terminal blocks		
gray	209-170	50 (25)

Adjacent jumper; insulated; I _N 41 A		
gray	282-402	100 (25)
yellow-green	282-422	100 (25)

Banana plug; for 4 mm socket diameter; color mixed; 10 x orange, white, black, blue, yellow; max. 42 V		
	215-111	50

Alternate jumper; insulated; I _N 41 A		
gray	282-409	100 (25)

B-type test plug module; snaps together; 8 mm wide		
gray	709-310	100 (25)

Step-down jumper; insulated; commons 10/6 mm ² (8/10 AWG) down to 4/2.5/1.5 mm ² (12/14/16 AWG); I _N 15 A		
gray	284-414	50 (25)

B-type spacer module; snaps together; 5 mm wide		
gray	709-311	100 (25)

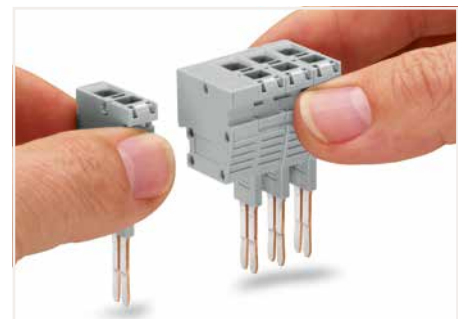

Snapping test plug and spacer modules together to assemble a multi-pole test plug module (max. 10 poles) for 8 mm terminal block width.

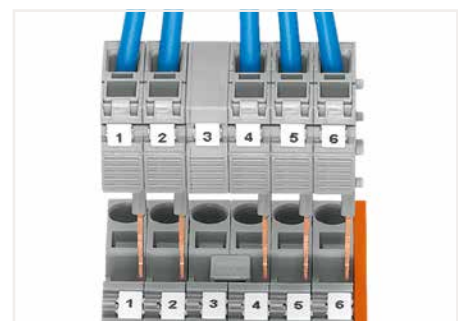

The test plug modules are directly plugged into the jumper contact slot of the current bar (picture shows 282 Series).

Through/Ground Conductor and Ex Terminal Block 10 mm²; 284 Series

Technical Data	
0.2 ... 10 mm ²	24 ... 8 AWG
800 V/8 kV/3 ①	600 V, 50 A ②
I _N 57 A	600 V, 54 A ③
Terminal block width: 10 mm / 0.394 inch	
12 ... 13 mm / 0.47 ... 0.51 inch	

Technical Data	
0.2 ... 10 mm ²	24 ... 8 AWG
800 V/8 kV/3 ①	600 V, 50 A ②
I _N 57 A	600 V, 54 A ③
Terminal block width: 10 mm / 0.394 inch	
12 ... 13 mm / 0.47 ... 0.51 inch	

- ① 800 V = rated voltage
8 kV = rated impulse voltage
3 = pollution degree
(see Section 14)
- ② Terminal blocks with an Ex mark are suitable for Ex e II applications.
0.5 ... 10 mm² / 20 ... 8 AWG
550 V; 53 A
(see Section 14)

Please observe the application notes:
Step-down jumper, page 250
Test plug module, page 345
Marking, from page 588

Approvals and corresponding ratings, visit www.wago.com

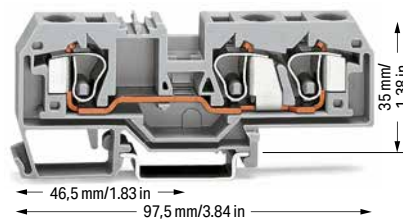
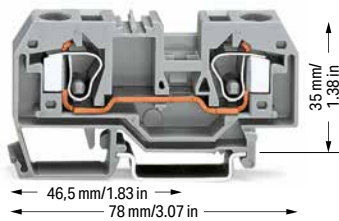

2-conductor through terminal block		
Color	Item No.	Pack. Unit
gray	284-901	25
blue	284-904	25
orange	284-902	25
light gray ②	284-992 ②	25

3-conductor through terminal block		
Color	Item No.	Pack. Unit
gray	284-681	25
blue	284-684	25
orange	284-682	25
light gray ②	284-993 ②	25

2-conductor ground terminal block		
green-yellow	284-907	25
green-yellow ②	284-907/999-950 ②	25

3-conductor ground terminal block		
green-yellow	284-687	25
green-yellow ②	284-687/999-950 ②	25

Accessories; item-specific

End and intermediate plate; 2.5 mm thick			
orange	284-328	100 (25)	
gray	284-325	100 (25)	
light gray	284-330	100 (25)	

Accessories; item-specific

End and intermediate plate; 2.5 mm thick			
orange	284-339	100 (25)	
gray	284-308	100 (25)	
light gray	284-341	100 (25)	

Separator; oversized; 2 mm thick			
orange	284-329	100 (25)	
gray	284-326	100 (25)	
light gray	284-331	100 (25)	

Separator; oversized; 2 mm thick			
orange	284-340	100 (25)	
gray	284-309	100 (25)	
light gray	284-342	100 (25)	

Step-down cover plate; 1 mm thick			
gray	284-357	100 (25)	
orange	284-367	100 (25)	

Step-down cover plate; 1 mm thick			
gray	284-358	100 (25)	
orange	284-368	100 (25)	

Accessories; 282 Series

Appropriate marking systems: WMB/WMB Inline/WFB

Protective warning marker; with black high-voltage symbol; for 5 terminal blocks			
yellow	284-415	50 (25)	

Step-down jumper; insulated; commons 10/6 mm ² (8/10 AWG) down to 6/4 mm ² (10/12 AWG); I _N 30 A			
gray	284-413	50 (25)	

Finger guard; touch-proof cover protects unused conductor entries			
yellow	284-400	100 (25)	

Test plug adapter; 8.3 mm wide; for 4 mm Ø test plug; for 1.5 ... 10 mm ² terminal blocks			
gray	209-170	50 (25)	

Adjacent jumper; insulated; I _N 57 A			
gray	284-402	100 (25)	
yellow-green	284-422	100 (25)	

Banana plug; for 4 mm socket diameter; color mixed; 10 x orange, white, black, blue, yellow; max. 42 V			
	215-111	50	

Alternate jumper; insulated; I _N 57 A			
gray	284-409	50 (25)	

B-type test plug module; snaps together; 8 mm wide			
gray	709-310	100 (25)	

Step-down jumper; insulated; commons 10/6 mm ² (8/10 AWG) down to 4/2.5/1.5 mm ² (12/14/16 AWG); I _N 15 A			
gray	284-414	50 (25)	

B-type spacer plate; snaps together; 2 mm wide			
gray	709-312	100 (25)	

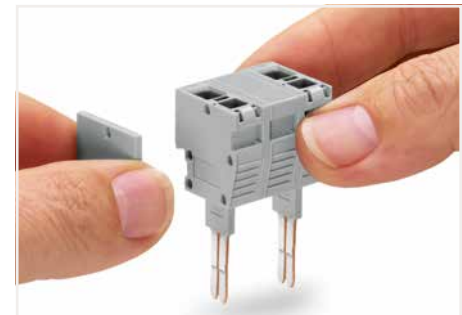

Snapping test plug and spacer modules (each with a spacer plate) together to assemble a multi-pole test plug module (max. 10 poles) for 10 mm terminal block width.



The test plug modules are directly plugged into the jumper contact slot of the current bar (picture shows 284 Series).



Finger guard seals an unused conductor entry.

5

Through/Ground Conductor and Ex Terminal Block 16 mm²; 283 Series

Technical Data	
0.2 ... 16 mm ²	24 ... 6 AWG
800 V/8 kV/3 ①	600 V, 65 A ②
I _N 76 A	600 V, 70 A ②
Terminal block width: 12 mm / 0.472 inch	
16 ... 17 mm / 0.63 ... 0.67 inch	

- ① 800 V = rated voltage
8 kV = rated impulse voltage
3 = pollution degree
(see Section 14)
- ② Terminal blocks with an Ex mark are suitable for Ex e II applications.
0.5 ... 16 mm² / 20 ... 6 AWG
550 V; 68 A
63 A jumper
(see Section 14)

Please observe the application notes:
Step-down jumper, page 250
Marking, from page 588

Approvals and corresponding ratings,
visit www.wago.com

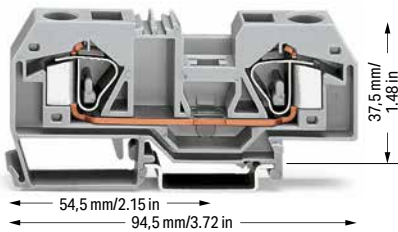

2-conductor through terminal block		
Color	Item No.	Pack. Unit
gray	283-901	20
blue	283-904	20
orange	283-902	20
light gray ②	283-992 ②	20

2-conductor ground terminal block		
green-yellow	283-907	20
green-yellow ②	283-907/999-950 ②	20

Accessories; 283 Series
Appropriate marking systems:
WMB/WMB InLine/WFB

End and intermediate plate; 2.5 mm thick		
orange	283-328	50 (25)
gray	283-325	50 (25)
light gray	283-330	50 (25)

Protective warning marker; with black high-voltage symbol; for 5 terminal blocks		
orange	283-329	50 (25)
gray	283-326	50 (25)
light gray	283-331	50 (25)

Protective warning marker; with black high-voltage symbol; for 5 terminal blocks		
yellow	283-415	50 (25)

Finger guard; touch-proof cover protects unused conductor entries		
yellow	283-400	100 (25)

Adjacent jumper; insulated; I _N 70 A		
gray	283-402	50 (25)
yellow-green	283-422	50 (25)

Alternate jumper; insulated; I _N 76 A		
gray	283-409	50 (25)

Step-down jumper; insulated; commons 16 mm ² (6 AWG) down to 4 mm ² (12 AWG); I _N 32 A		
gray	283-414	50 (25)

Step-down cover plate; 1 mm thick		
gray	283-357	100 (25)
orange	283-367	100 (25)

Accessories; 283 Series
Appropriate marking systems:
WMB/WMB InLine/WFB

Test plug adapter; 8.3 mm wide; for 4 mm Ø test plug; for 1.5 ... 10 mm² terminal blocks

gray	283-404	25
------	---------	----

Banana plug; for 4 mm socket diameter; color mixed; 10 x orange, white, black, blue, yellow; max. 42 V

	215-111	50
--	---------	----

Power tap; I_N 24 A; with 500 mm cable; for 16 mm² (283/783 Series) and 35 mm² (285/785 Series) rail-mount terminal blocks

gray	283-407	25
------	---------	----

Screwless end stop; for DIN-35 rail; 6 mm wide

gray	249-116	100 (25)
------	---------	----------

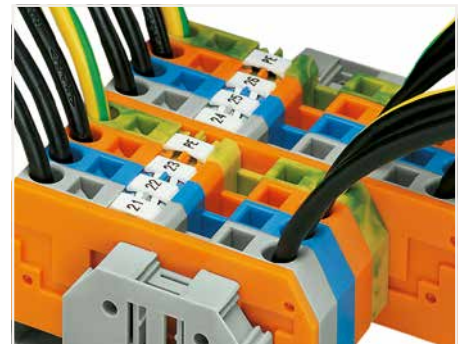

The markers are not covered by the wiring when marking terminal blocks in center position.



Always push voltage tap (283-407) down into the terminal block until fully inserted!

5

Through/Ground Conductor and Ex Terminal Block 16 mm²; 283 Series

Technical Data

0.2 ... 16 mm ²	24 ... 6 AWG
800 V/8 kV/3 ①	600 V, 65 A ②
I _N 76 A	600 V, 70 A ③
Terminal block width: 12 mm / 0.472 inch	
16 ... 17 mm / 0.63 ... 0.67 inch	

- 800 V = rated voltage
8 kV = rated impulse voltage
3 = pollution degree
(see Section 14)
- Terminal blocks with an Ex mark are suitable for Ex e II applications.
0.5 ... 16 mm² / 20 ... 6 AWG
550 V; 68 A
(see Section 14)

Please observe the application notes:
Marking, from page 588

Approvals and corresponding ratings,
visit www.wago.com

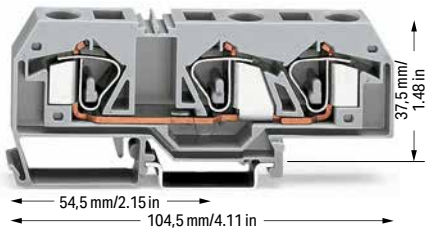

3-conductor through terminal block

Notice: This terminal block cannot be commoned with adjacent jumpers.

Color	Item No.	Pack. Unit
gray	283-671	20
blue	283-674	20
orange	283-672	20
light gray ④	283-998 ②	20

3-conductor ground terminal block

Notice: This terminal block cannot be commoned with adjacent jumpers.

green-yellow	283-677	20
green-yellow ④	283-677/999-950 ②	20



Finger guard seals an unused conductor entry.

Accessories; 283 Series

Appropriate marking systems:
WMB/WMB Inline/WFB

End and intermediate plate; 2.5 mm thick

orange	283-352	50 (25)
gray	283-350	50 (25)
light gray	283-354	50 (25)

Protective warning marker; with black high-voltage symbol; for 5 terminal blocks

orange	283-353	50 (25)
gray	283-351	50 (25)
light gray	283-355	50 (25)

Protective warning marker; with black high-voltage symbol; for 5 terminal blocks

yellow	283-415	50 (25)
--------	---------	---------

Finger guard; touch-proof cover protects unused conductor entries

yellow	283-400	100 (25)
--------	---------	----------

Screwless end stop; for DIN-35 rail; 6 mm wide

gray	249-116	100 (25)
------	---------	----------

Screwless end stop; for DIN-35 rail; 10 mm wide

gray	249-117	50 (25)
------	---------	---------

Through/Ground Conductor and Ex Terminal Block 35 mm²; 285 Series

Technical Data

6 ... 35 mm ²	8 ... 2 AWG
1000 V/8 kV/3 ①	600 V, 115 A ^②
I _N 125 A	600 V, 120 A ^③
Terminal block width: 16 mm / 0.63 inch	
23 mm / 0.91 inch	

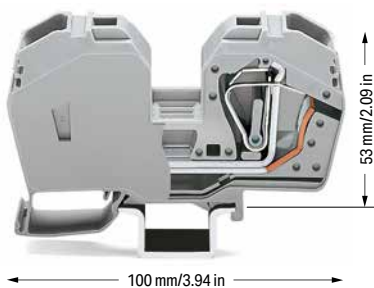

- 1000 V = rated voltage
8 kV = rated impulse voltage
3 = pollution degree
(see Section 14)
 - Terminal blocks with an Ex mark are suitable for Ex e II applications.
6 ... 35 mm² / 8 ... 2 AWG
880 V; 85 A
6 ... 25 mm² / 8 ... 4 AWG
for ground conductor terminal blocks
(see Section 14)
- Please observe the application notes:
Marking, from page 588
- Approvals and corresponding ratings,
visit www.wago.com



Terminating a 35 mm² (2 AWG) conductor –

5

2-conductor through terminal block; with integrated end plate; only for DIN 35 x 15 rail

Color	Item No.	Pack. Unit
gray	285-635	15
blue	285-634	15
light gray ④	285-992 ②	15

2-conductor ground terminal block; with integrated end plate; only for DIN 35 x 15 rail

green-yellow	285-637	15
green-yellow ④	285-637/999-950 ②	15

Accessories; 285 Series

Appropriate marking systems:
WMB/WMB Inline/WFB

Adjacent jumper; insulated; I_N 85 A

	gray	285-435	50 (25)
--	------	---------	---------

Step-down jumper; insulated; I_N 90 A

	gray	285-430	50 (25)
--	------	---------	---------

Protective warning marker; with a black high-voltage symbol

	yellow	285-416	100 (25)
--	--------	---------	----------

Finger guard; touch-proof cover protects unused conductor entries

	yellow	285-401	100 (25)
--	--------	---------	----------

Power tap; I_N 24 A; with 500 mm cable; for 16 mm² (283/783 Series) and 35 mm² (285/785 Series) rail-mount terminal blocks

	gray	283-407	25
--	------	---------	----

Screwless end stop; for DIN-35 rail; 6 mm wide

	gray	249-116	100 (25)
--	------	---------	----------

Screwless end stop; for DIN-35 rail; 6 mm wide

	gray	249-117	50 (25)
--	------	---------	---------



Protective warning markers inserted into the operating slots

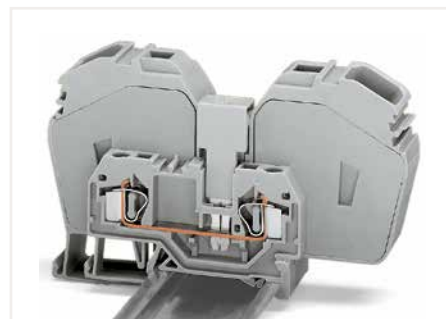

Commoning a 285 Series terminal block (35 mm²/ 2 AWG) with a 281 Series terminal block (4 mm²/ 12 AWG) using a step-down jumper (283-414).



Finger guard seals an unused conductor entry.

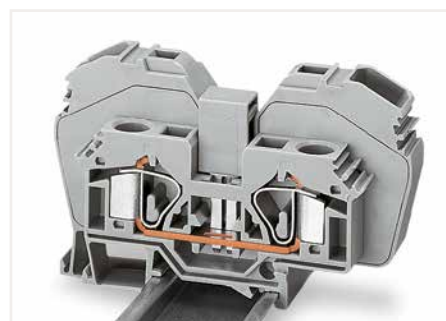

The following 285 Series Through Terminal Blocks can be commoned with 283 Series Through Terminal Blocks: 285-635 or 285-634 with 283-601 or 283-604 (terminal blocks with side marking, visit www.wago.com)
Adjacent jumper required: 285-435

Please note that the nominal current of the adjacent jumper must not exceed 63 A.

Distribution Terminal Block; 3 x 10 mm² CAGE CLAMP® Connection and 1 x 35 mm² Screw Clamp Connection

284 Series

Technical Data

0.2 ... 10 mm ² ①	24 ... 8 AWG
6 ... 35 mm ² ②	10 ... 2 AWG
800 V/8 kV/3 ③	
I _N 125 A	
Terminal block width: 17.5 mm / 0.689 inch	
12 ... 14 mm / 0.47 ... 0.55 inch	

- ① CAGE CLAMP® connection
 - ② Screw-type connection
 - ③ 800 V = rated voltage
8 kV = rated impulse voltage
3 = pollution degree (see Section 14)
 - ④ Individual arrangement: 125 A
Two jumpers combined in one clamping unit: 100 A
- Please observe the application notes:
Marking, from page 588
- Approvals and corresponding ratings,
visit www.wago.com

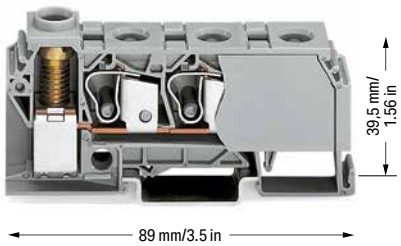

Terminating a 35 mm² (2 AWG) conductor – screw clamp connection, side-entry wiring

Distribution terminal block; with 3 x CAGE CLAMP® connection (10 mm²/8 AWG); 1 x screw clamp connection (35 mm²/2 AWG) and 3.5 Nm screw torque

Color	Item No.	Pack. Unit
○ gray	284-621	15
● blue	284-624	15

Accessories; distribution terminal block

Appropriate marking system:
WMB

Adjacent jumper; insulated; I_N 125 A; for 1 jumper;
I_N 100 A; for 2 jumpers

gray	284-412 ④	100 (25)
------	-----------	----------



Screwless end stop; for DIN-35 rail; 6 mm wide

gray	249-116	100 (25)
------	---------	----------



Screwless end stop; for DIN-35 rail; 10 mm wide

gray	249-117	50 (25)
------	---------	---------



Terminating a 10 mm² (8 AWG) conductor – CAGE CLAMP® connection, front-entry wiring.



Commoning with comb-style jumper bar.

5

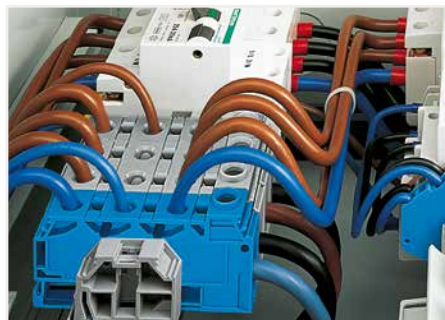

Side-entry distribution terminal block with screw clamp connection (35 mm²/2 AWG) and front-entry CAGE CLAMP® connection (3 x 10 mm²/8 AWG) snaps onto
This terminal block snaps onto DIN-35 rail – it is enclosed on both sides and requires no end or intermediate plate.

When connecting 3 x 10 mm² (8 AWG) conductors on the distribution side, make sure that the nominal current of 125 A is not exceeded.

Step-Down Jumpers; for Front-Entry Through Terminal Blocks up to 16 mm² Installation



Step-down jumper from 10/6 mm² (8/10 AWG) to 4/2.5/1.5 mm² (12/14/16 AWG)
I_N 15 A, Item No. 284-414



Step-down jumper from 10/6 mm² (8/10 AWG) to 6/4 mm² (10/12 AWG)
I_N 30 A, Item No. 284-413



Step-down jumper from 16 mm² (6 AWG) to 4 mm² (12 AWG)
I_N 32 A, Item No. 283-414

5

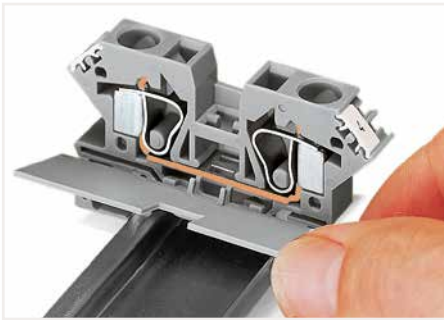

Snapping a cover plate onto open side of terminal block.

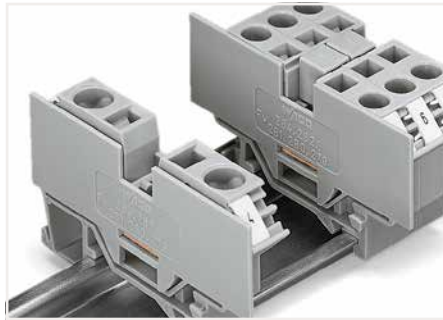

A cover plate must also be snapped onto the other side of the larger terminal block.



Commoning terminal blocks of different sizes – step down. Push down the step-down jumper until fully inserted.

Step-down jumpers common terminal blocks of different sizes, without losing a conductor clamping point. This can be beneficial on long conductor runs where voltage drop can be a problem. A large conductor can be easily connected to smaller conductors at the distribution point.

Step-down jumpers are simply pushed for full insertion, similar to adjacent jumpers. Commoning may be made in either direction using the special thin end plate to cover the open side. Additional through terminal blocks having a smaller cross section may be commoned using adjacent jumpers.

In this case, pay attention that:

- The total current of the outgoing circuits does not exceed the nominal current of the step-down jumper.
- The standard or special thin cover plate is installed on the open side of the larger block.



Note: Jumpers are marked with suitable terminal block sizes for correct installation.

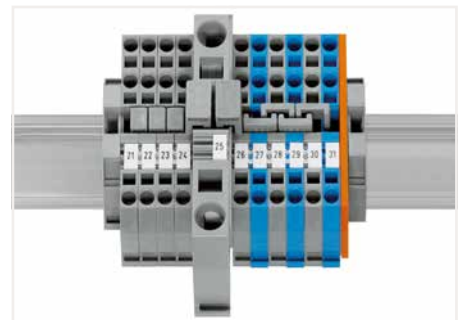

Commoning from 16 mm²/6 AWG (283 Series) to 4 mm²/12 AWG (281 Series) rail-mount terminal blocks via step-down jumpers.

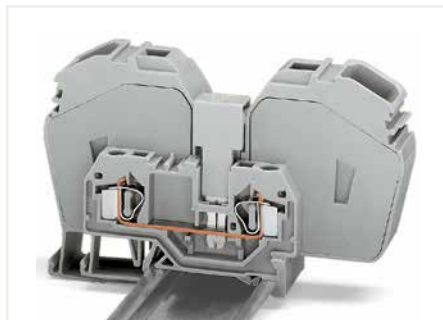

Commoning a 285 Series terminal block (35 mm²/ 2 AWG) with a 281 Series terminal block (4 mm²/ 12 AWG) using a step-down jumper (283-414).

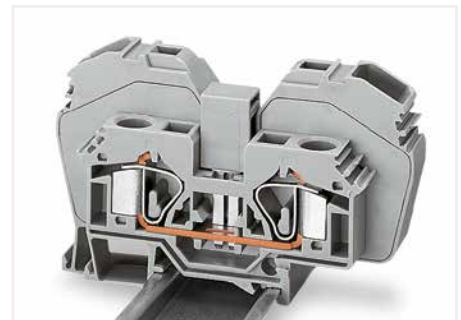

The following 285 Series Through Terminal Blocks can be commoned with 283 Series Through Terminal Blocks: 285-635 or 285-634 with 283-601 or 283-604 (terminal blocks with side marking, visit www.wago.com)
Adjacent jumper required: 285-435

Please note that the nominal current of the adjacent jumper must not exceed 63 A.

Assembly Examples

Step-Down Jumpers; for Front-Entry Through Terminal Blocks

Terminal blocks with side marking, visit www.wago.com

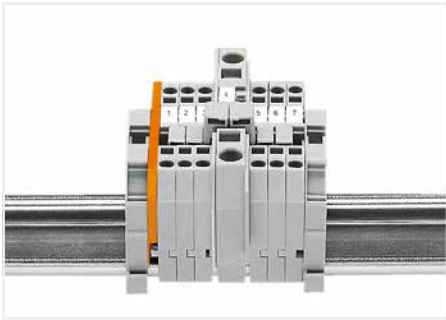

Commoning from 6 mm²/10 AWG (282 Series) to 1.5 mm²/16 AWG (279 Series) rail-mount terminal blocks via step-down jumpers.



Commoning from 10 mm²/8 AWG (284 Series) to 6 mm²/10 AWG (282 Series) rail-mount terminal blocks via step-down jumpers.

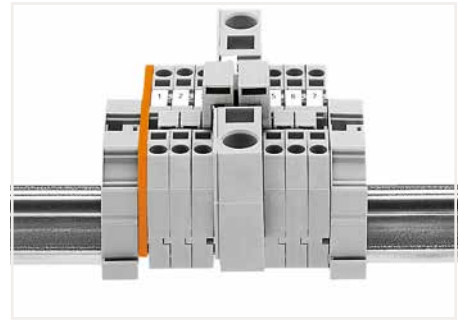

Commoning from 16 mm²/6 AWG (283 Series) to 4 mm²/12 AWG (281 Series) rail-mount terminal blocks via step-down jumpers.

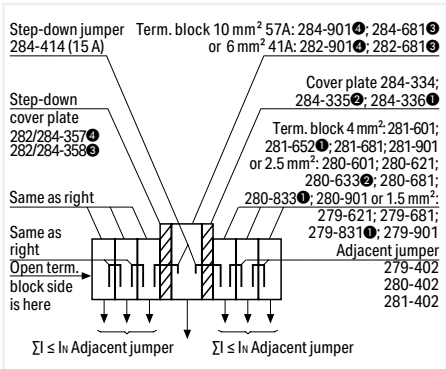

Assembly example: Commoning from 10/6 mm² (8/10 AWG) to 4/2.5/1.5 mm² (12/14/16 AWG) rail-mount terminal blocks via step-down jumper (284-414).

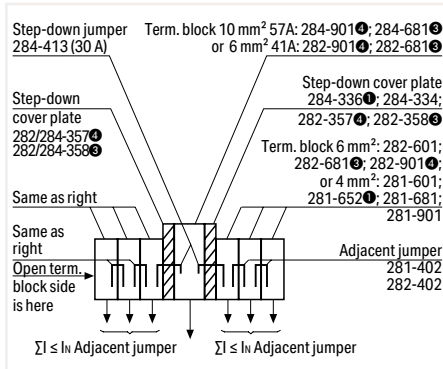

Assembly example: Commoning from 10/6 mm² (8/10 AWG) to 6 mm² (10 AWG) rail-mount terminal blocks via step-down jumper (284-413).

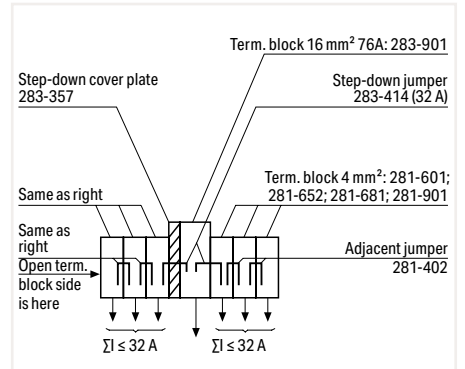

Assembly example: Commoning from 16 mm²/6 AWG to 4 mm²/12 AWG rail-mount terminal blocks via step-down jumper (283-414).

5



Commoning from 6 mm²/10 AWG (282 Series) to 1.5 mm²/16 AWG (279 Series) rail-mount terminal blocks via step-down jumpers.



Commoning from 10 mm²/8 AWG (284 Series) to 6 mm²/10 AWG (282 Series) rail-mount terminal blocks via step-down jumpers.

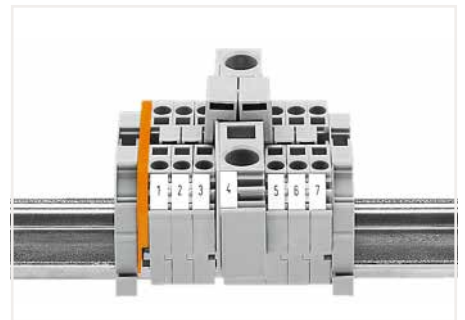

Commoning from 16 mm²/6 AWG (283 Series) to 4 mm²/12 AWG (281 Series) rail-mount terminal blocks via step-down jumpers.

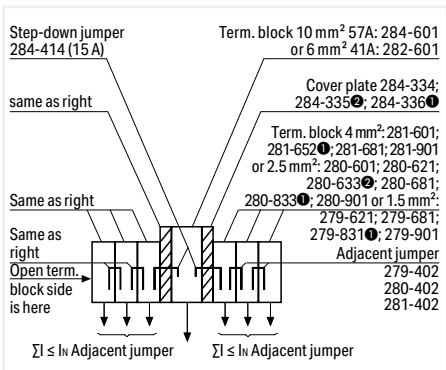

Assembly example: Commoning from 10/6 mm² (8/10 AWG) to 4/2.5/1.5 mm² (12/14/16 AWG) rail-mount terminal blocks via step-down jumper (284-414).

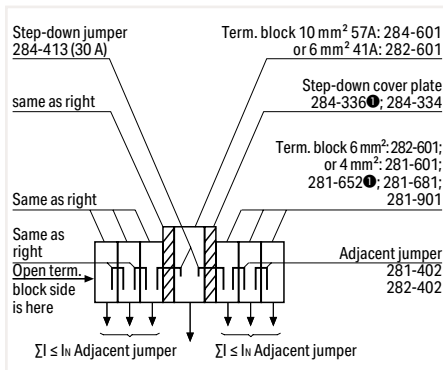

Assembly example: Commoning from 10/6 mm² (8/10 AWG) to 6 mm² (10 AWG) rail-mount terminal blocks via step-down jumper (284-413).

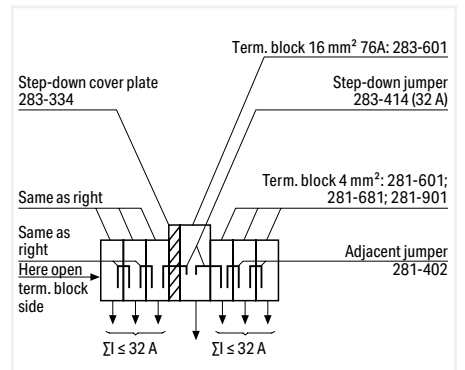

Assembly example: Commoning from 16 mm²/6 AWG to 4 mm²/12 AWG rail-mount terminal blocks via step-down jumper (283-414).

Double-Deck Terminal Block 1.5 mm²; 279 Series

Technical Data	
0.08 ... 1.5 mm ²	28 ... 16 AWG
500 V/6 kV/3 ①	300 V, 10 A ②
I _N 18 A	
Terminal block width: 4 mm / 0.157 inch	
8 ... 9 mm / 0.31 ... 0.35 inch	

Technical Data	
0.08 ... 1.5 mm ²	28 ... 16 AWG
500 V/6 kV/3 ①	300 V, 10 A ②
I _N 18 A	
Terminal block width: 4 mm / 0.157 inch	
8 ... 9 mm / 0.31 ... 0.35 inch	

Technical Data	
0.08 ... 1.5 mm ²	28 ... 16 AWG
500 V/6 kV/3 ①	300 V, 10 A ②
I _N 18 A	
Terminal block width: 4 mm / 0.157 inch	
8 ... 9 mm / 0.31 ... 0.35 inch	

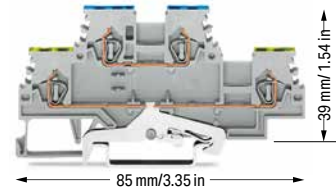
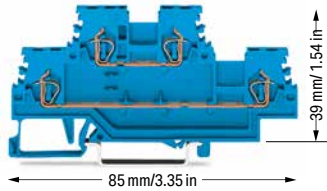
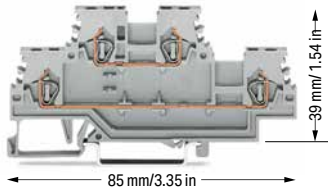

Double-deck terminal block; through/through terminal block; gray housing

	Item No.	Pack. Unit
<input type="radio"/> L/L	279-501	50
<input type="radio"/> N/L	279-512	50
<input type="radio"/> L/N	279-513	50

Double-deck terminal block; through/through terminal block; blue housing

	Item No.	Pack. Unit
<input checked="" type="radio"/> N/N	279-504 ②	50

Double-deck terminal block; ground conductor/through terminal block; gray housing

	Item No.	Pack. Unit
<input type="radio"/> PE/N	279-517	50
<input type="radio"/> PE/L	279-527	50

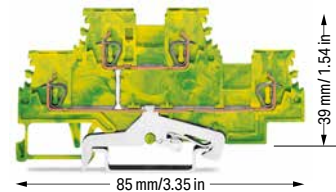
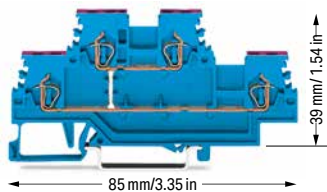
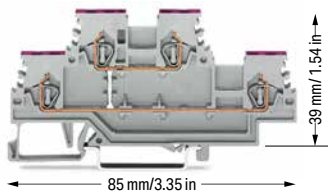

Double-deck terminal block; 4-conductor through terminal block; internally commoned; violet conductor entry; gray housing

	Item No.	Pack. Unit
<input type="radio"/> L	279-508	50

Double-deck terminal block; 4-conductor through terminal block; internally commoned; violet conductor entry; blue housing

	Item No.	Pack. Unit
<input checked="" type="radio"/> N	279-509 ②	50

Double-deck terminal block; 4-conductor ground terminal block; internally commoned; green-yellow housing

	Item No.	Pack. Unit
<input checked="" type="radio"/> PE	279-507	50

5

- ❶ 500 V = rated voltage
6 kV = rated impulse voltage
3 = pollution degree
(see Section 14)
 - ❷ Terminal blocks with a blue insulated housing are suitable for Ex i applications.
- Please observe the application notes:
Insulation stop, page 346
Comb-style jumper bar, page 347
Marking, from page 588
- Approvals and corresponding ratings,
visit www.wago.com

Accessories; 279 Series

Appropriate marking systems:
WMB/WMB Inline/WFB

End and intermediate plate; 2 mm thick

	orange	279-519	200 (25)
	gray	279-518	

Insulation stop; 0.08 ... 0.2 mm² "s" (0.14 mm² "f-st"); 5 pcs/strip

	white	279-470	200 (25)
---	-------	---------	----------

Insulation stop; 0.25 mm²; 5 pcs/strip

	dark gray	279-471	200 (25)
---	-----------	---------	----------

Protective warning marker; with black high-voltage symbol; for 5 terminal blocks

	yellow	279-415	100 (25)
---	--------	---------	----------

Adjacent jumper; insulated; I_N 15 A

	gray	279-402	200 (25)
	yellow-green	279-422	200 (25)

Alternate jumper; insulated; I_N 15 A

	gray	279-409	100 (25)
---	------	---------	----------

Comb-style jumper bar; insulated; I_N = I_N of terminal block

	2-way	279-482	200 (25)
	3-way	279-483	200 (25)

Comb-style jumper bar; insulated; I_N = I_N of terminal block

	10-way	279-490	50 (25)
---	--------	---------	---------

Alternate comb-style jumper bar; insulated; I_N = I_N of terminal block

	2-way	279-492	200 (25)
---	-------	---------	----------

Operating tool; insulated

	2-way	279-432	1
	3-way	279-433	1

Operating tool; insulated

	10-way	279-440	1
---	--------	---------	---

Double-deck marker carrier

	gray	279-529	50 (25)
---	------	---------	---------

Accessories; 279 Series

Appropriate marking systems:
WMB/WMB Inline/Marking Strips

WMB Inline; plain; 2,000 WMB markers (4 mm)/reel; stretchable 4 ... 4.2 mm

	white	2009-114	1
---	-------	----------	---

WMB marking card; white; 10 strips with 10 markers/card; stretchable 4 ... 4.2 mm

	plain	793-4501	5
---	-------	----------	---

WMB marking card; plain; 10 strips with 10 markers/card; stretchable 4 ... 4.2 mm

	yellow	793-4501/000-002	5
	red	793-4501/000-005	5
	blue	793-4501/000-006	5
	gray	793-4501/000-007	5
	orange	793-4501/000-012	5
	light green	793-4501/000-017	5
	green	793-4501/000-023	5
	violet	793-4501/000-024	5

Screwless end stop; for DIN-35 rail; 6 mm wide

	gray	249-116	100 (25)
---	------	---------	----------

Screwless end stop; for DIN-35 rail; 10 mm wide

	gray	249-117	50 (25)
---	------	---------	---------

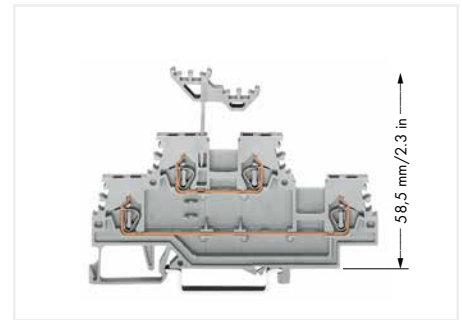

Double-deck marker carrier
(height including marker carrier)

Double- and Triple-Deck Terminal Blocks 280 and 281 Series Description and Installation

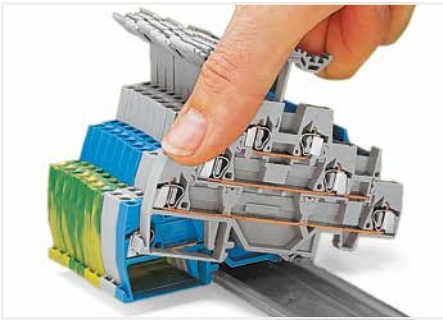

Snapping a terminal block onto the DIN-rail.

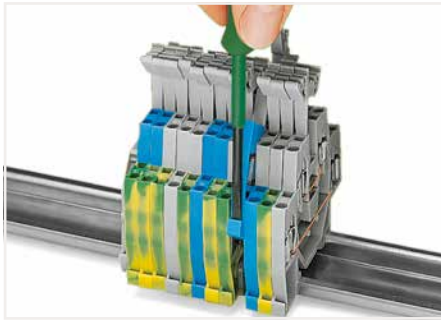

Removing a terminal block from the assembly.

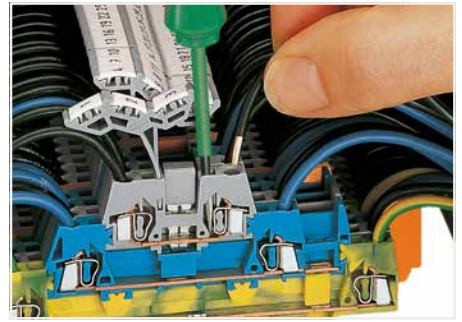

CAGE CLAMP® connection
Inserting a conductor.
With ferruled conductors, it is necessary to use a terminal block one size smaller than the conductor's nominal cross section.

5

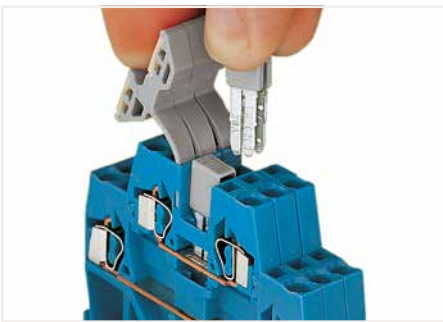

Commoning using an adjacent jumper (280-402).
push jumpers down until fully inserted.

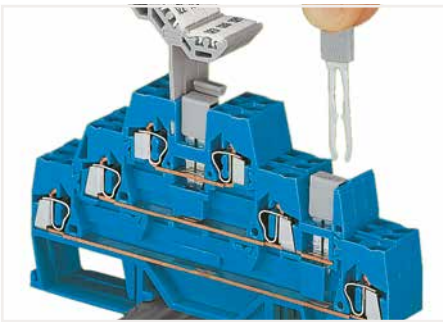

Combining vertical and adjacent jumpers.

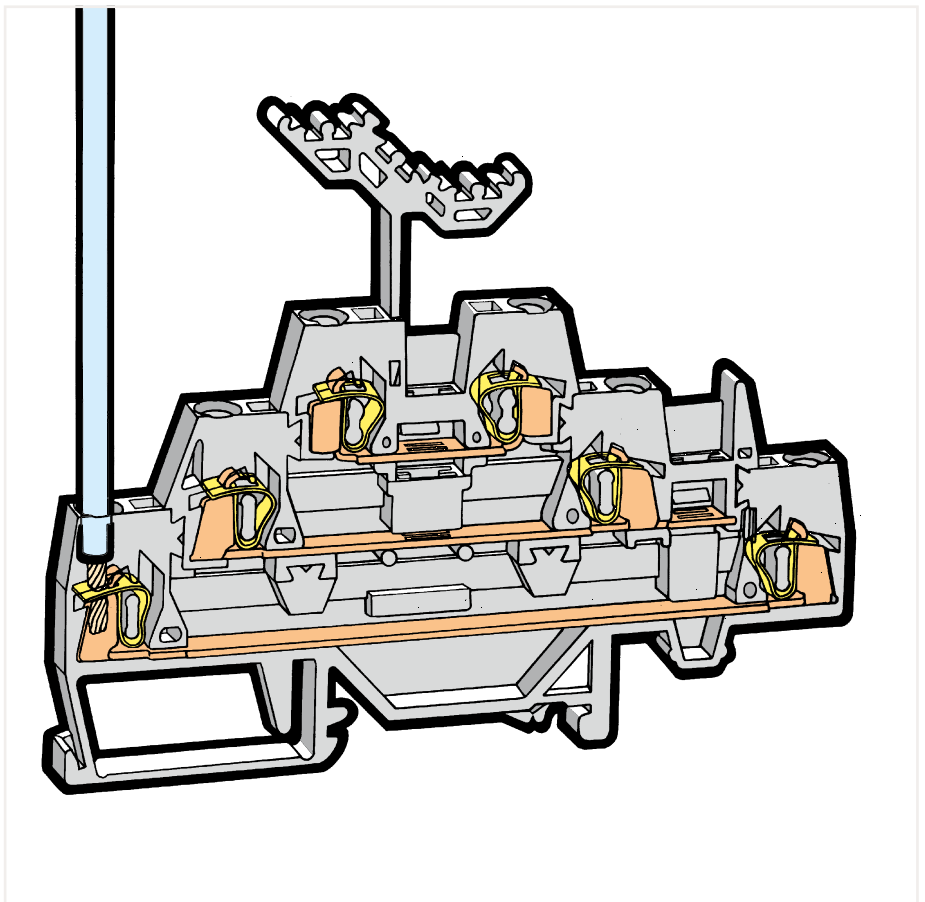

Labeling via WMB Multi Marking System.

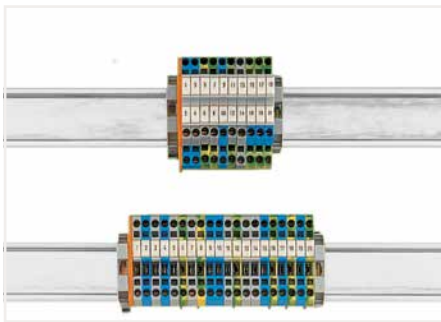

Use 50 % less rail space with double-deck terminal blocks.

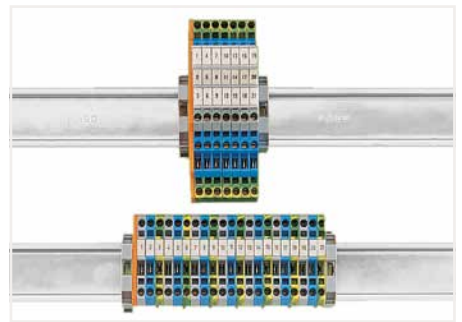

Use 67 % less rail space with triple-deck terminal blocks.



CAGE CLAMP® terminates the following copper conductors:
solid



stranded



fine-stranded,
also with tinned
single strands

For aluminum conductors, see notes in Section 14.

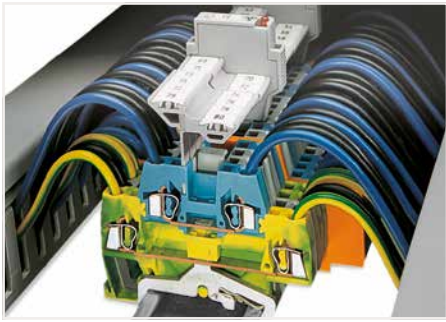

Example of a mixed assembly with double-deck terminal blocks. The 280 Series Double-Deck Terminal Blocks are available with decks of same or different color according to their function. This is an additional visual aid during wiring, service or maintenance.



Double-deck terminal blocks accommodate two circuits of different potentials on two decks; different circuits can be differentiated by color coding either deck (280 Series). The lower deck is wider than the upper for ease of wiring.

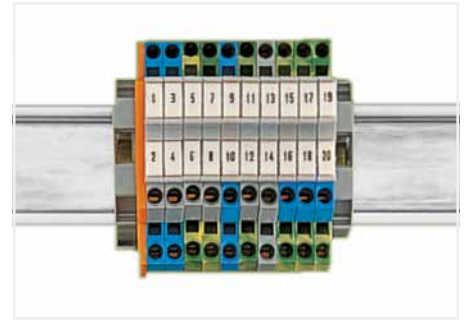

With a terminal block width of just 5 mm, an effective width of just 2.5 mm for terminal blocks of same or different potentials can be realized for conductors ranging 0.08 mm² ... 2.5 mm² (28 ... 14 AWG).

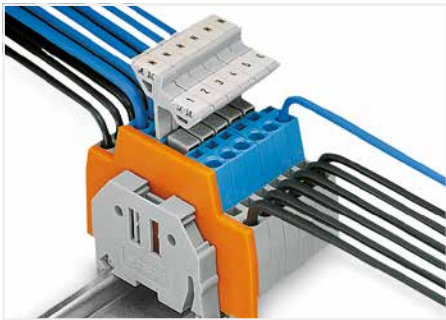

Double-deck terminal blocks used as control conductor terminal blocks (e.g., for magnetic valves) with the upper deck commoned.

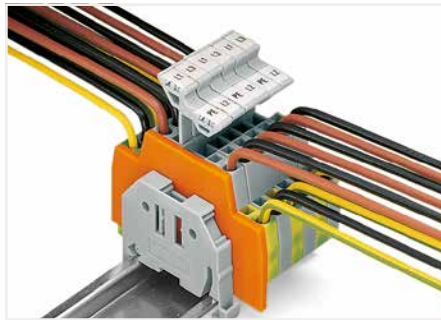

Double-deck terminal blocks used for connecting a three-phase motor.

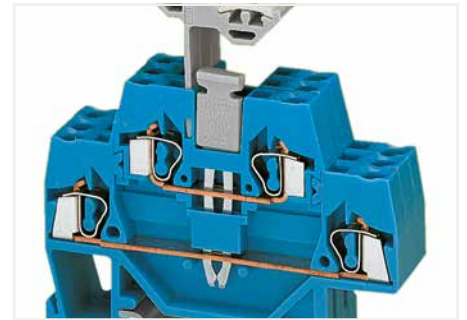

Commoning with a vertical jumper (281-421). Push vertical jumper down until fully inserted.

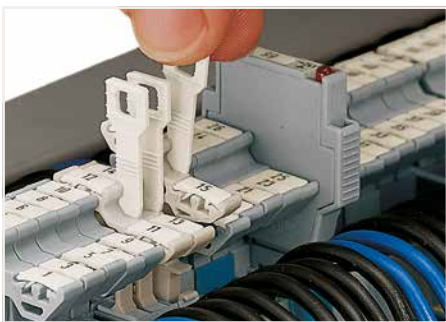

Pulling the disconnect tab.

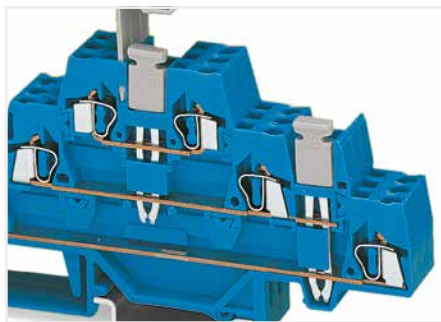

A vertical jumper allows commoning of the upper and lower levels, providing a 6-conductor feedthrough terminal block in one housing. Two adjacent triple-deck terminal blocks may be commoned together on the same level using a push-in adjacent jumper.

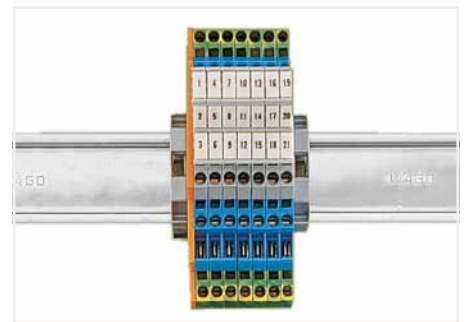

Double-deck (triple-deck) terminal blocks accommodate two (three) circuits of different potentials on two (three) decks; different circuits can be differentiated by color coding either deck (280 Series). The lower deck is wider than the upper for ease of wiring.



fine-stranded, tip-bonded



fine-stranded, with ferrule (gastight crimped)



fine-stranded, with pin terminal (gastight crimped)

Double-Deck Terminal Block 2.5 mm²; 280 Series

Technical Data	
0.08 ... 2.5 mm ²	28 ... 12 AWG*
500 V/6 kV/3 ①	300 V, 15 A ②
I _N 20 A	300 V, 20 A ③
Terminal block width: 5 mm / 0.197 inch	
8 ... 9 mm / 0.31 ... 0.35 inch	

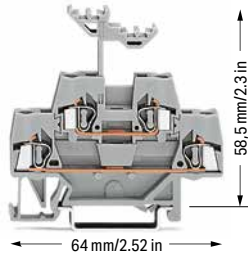

Double-deck terminal block; through/through terminal block

Color	Item No.	Pack. Unit
○ gray	280-519	50
● blue	280-529 ②	50

Other terminal blocks with the same profile:		
Diode	280-940/281-410	Page 334
LED	280-943/281-434	Page 334

Accessories; item-specific			
End and intermediate plate; 2.5 mm thick			
orange	280-341	100 (25)	
gray	280-340	100 (25)	

Accessories; item-specific			
Intermediate plate; 1.1 mm thick			
orange	280-366	100 (25)	

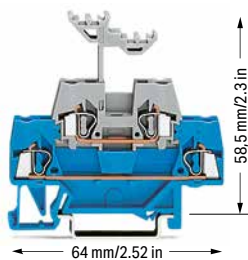

Double-deck terminal block; through/through terminal block

Color	Item No.	Pack. Unit
blue/gray	280-523	50
gray/blue	280-533	50

Accessories; item-specific			
End and intermediate plate; 2.5 mm thick			
orange	280-341	100 (25)	
gray	280-340	100 (25)	

Accessories; item-specific			
Intermediate plate; 1.1 mm thick			
orange	280-366	100 (25)	

Technical Data	
0.08 ... 2.5 mm ²	28 ... 12 AWG*
500 V/6 kV/3 ①	300 V, 15 A ②
I _N 20 A	300 V, 20 A ③
Terminal block width: 5 mm / 0.197 inch	
8 ... 9 mm / 0.31 ... 0.35 inch	

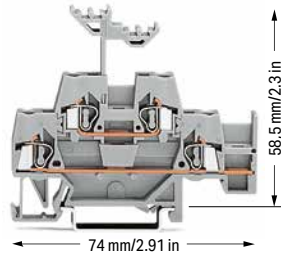

Double-deck terminal block; through/through terminal block; with slot for adjacent jumper

Color	Item No.	Pack. Unit
○ gray	280-520	50
● blue	280-530 ②	50

Accessories; item-specific			
End and intermediate plate; 2.5 mm thick			
orange	280-343	100 (25)	
gray	280-342	100 (25)	

Accessories; item-specific			
Intermediate plate; 1.1 mm thick			
orange	280-369	100 (25)	

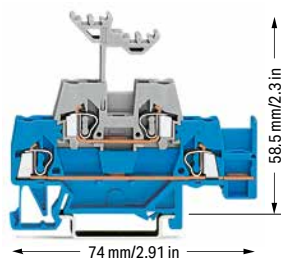

Double-deck terminal block; through/through terminal block; with slot for adjacent jumper

Color	Item No.	Pack. Unit
○ blue/gray	280-524	50
● gray/blue	280-534	50

Accessories; item-specific			
End and intermediate plate; 2.5 mm thick			
orange	280-343	100 (25)	
gray	280-342	100 (25)	

Accessories; item-specific			
Intermediate plate; 1.1 mm thick			
orange	280-369	100 (25)	

Technical Data	
0.08 ... 2.5 mm ²	28 ... 12 AWG*
500 V/6 kV/3 ①	300 V, 20 A ③
I _N 20 A	300 V, 20 A ③
Terminal block width: 5 mm / 0.197 inch	
8 ... 9 mm / 0.31 ... 0.35 inch	

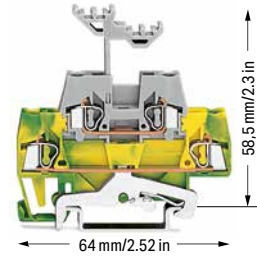

Double-deck terminal block; ground conductor/through terminal block

Color	Item No.	Pack. Unit
green-yellow/gray	280-527	50
green-yellow/blue	280-537	50

Accessories; item-specific			
End and intermediate plate; 2.5 mm thick			
orange	280-341	100 (25)	
gray	280-340	100 (25)	

Accessories; item-specific			
Intermediate plate; 1.1 mm thick			
orange	280-366	100 (25)	

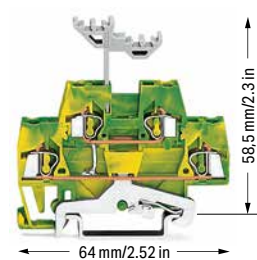

Double-deck terminal block; 4-conductor ground terminal block; internally commoned

Color	Item No.	Pack. Unit
● green-yellow	280-517	50

Accessories; item-specific			
End and intermediate plate; 2.5 mm thick			
orange	280-341	100 (25)	
gray	280-340	100 (25)	

Accessories; item-specific			
Intermediate plate; 1.1 mm thick			
orange	280-366	100 (25)	

Technical Data	
0.08 ... 2.5 mm ²	28 ... 12 AWG*
400 V/6 kV/3 ①	300 V, 15 A ②
I _N 10 A	300 V, 20 A ③
Terminal block width: 5 mm / 0.197 inch	
8 ... 9 mm / 0.31 ... 0.35 inch	

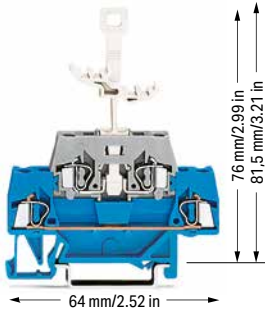

Double-deck terminal block; through/disconnect terminal block

Color	Item No.	Pack. Unit
blue/gray	280-525	50
○ gray/gray	280-521	50

Accessories; item-specific

End and intermediate plate; 2.5 mm thick			
orange	280-341	100 (25)	
gray	280-340	100 (25)	

Intermediate plate; 1.1 mm thick

orange	280-366	100 (25)
--------	---------	----------

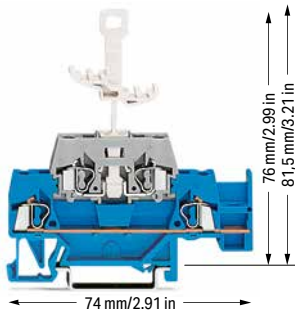

Double-deck terminal block; through/disconnect terminal block; with slot for adjacent jumper

Color	Item No.	Pack. Unit
blue/gray	280-526	50
○ gray/gray	280-522	50

Accessories; item-specific

End and intermediate plate; 2.5 mm thick			
orange	280-343	100 (25)	
gray	280-342	100 (25)	

Intermediate plate; 1.1 mm thick

orange	280-369	100 (25)
--------	---------	----------

Technical Data	
0.08 ... 2.5 mm ²	28 ... 12 AWG*
500 V/6 kV/3 ①	300 V, 15 A ②
I _N 20 A	300 V, 20 A ③
Terminal block width: 5 mm / 0.197 inch	
8 ... 9 mm / 0.31 ... 0.35 inch	

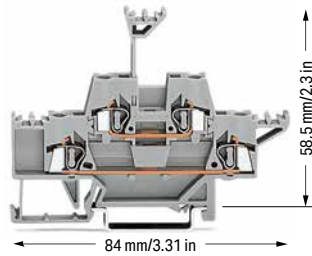

Double-deck terminal block; through/through terminal block; with additional marking options on both terminal block sides

Color	Item No.	Pack. Unit
○ gray	280-513	50

Accessories; item-specific

End and intermediate plate; 2.5 mm thick			
orange	280-341	100 (25)	
gray	280-340	100 (25)	

Intermediate plate; 1.1 mm thick

orange	280-366	100 (25)
--------	---------	----------

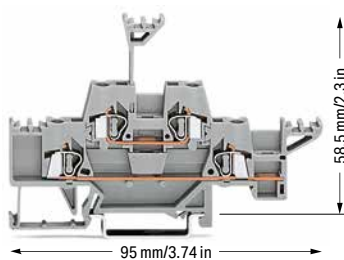

Double-deck terminal block; through/through terminal block; with additional marking options on both terminal block sides; with slot for adjacent jumper

Color	Item No.	Pack. Unit
○ gray	280-543	50

Accessories; item-specific

End and intermediate plate; 2.5 mm thick			
orange	280-343	100 (25)	
gray	280-342	100 (25)	

Intermediate plate; 1.1 mm thick

orange	280-369	100 (25)
--------	---------	----------

*12 AWG: THHN, THWN

① 500 V / 400 V = rated voltage
6 kV = rated impulse voltage
3 = pollution degree (see Section 14)

② Terminal blocks with a blue insulated housing are suitable for Ex i applications.

Please observe the application notes:
Insulation stop, page 346
Comb-style jumper bar, page 347
Marking, from page 588

Approvals and corresponding ratings, visit www.wago.com

Accessories; 280 Series

Appropriate marking systems:
WMB/WMB Inline

Insulation stop; 0.08 ... 0.2 mm² "s" (0.14 mm² "f-st"); 5 pcs/strip

white	280-470	200 (25)
-------	---------	----------

Insulation stop; 0.25 ... 0.5 mm²; 5 pcs/strip

light gray	280-471	200 (25)
------------	---------	----------

Insulation stop; 0.75 ... 1 mm²; 5 pcs/strip

dark gray	280-472	200 (25)
-----------	---------	----------

Adjacent jumper; insulated; I_N = I_N terminal block

gray	280-402	200 (25)
yellow-green	280-422	200 (25)

Alternate jumper; insulated; I_N = I_N terminal block

gray	280-409	100 (25)
------	---------	----------

Vertical jumper; insulated; I_N 24 A

gray	281-421	200 (25)
------	---------	----------

Comb-style jumper bar; insulated; I_N = I_N of terminal block

2-way	280-482	200 (25)
3-way	280-483	200 (25)

Comb-style jumper bar; insulated; I_N = I_N of terminal block

10-way	280-490	50 (25)
--------	---------	---------

Alternate comb-style jumper bar; insulated; I_N = I_N of terminal block

2-way	280-492	200 (25)
-------	---------	----------

Operating tool; insulated

2-way	280-432	1
3-way	280-433	1

Operating tool; insulated

10-way	280-440	1
--------	---------	---

Screwless end stop; for DIN-35 rail; 6 mm wide

gray	249-116	100 (25)
------	---------	----------

Double- and Triple-Deck Carrier Terminal Block for Fuse Plugs 2.5 mm²; 280 Series

Technical Data

0.08 ... 2.5 mm ²	28 ... 12 AWG*
400 V/6 kV/3 ①②	300 V, 15 A ③
I _N 10 A (20 A)	300 V, 20 A ④
Terminal block width: 5 mm / 0.197 inch	
8 ... 9 mm / 0.31 ... 0.35 inch	

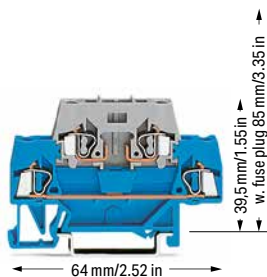

Double-deck terminal block; through/carrier terminal block for fuse plugs

Color	Item No.	Pack. Unit
blue/gray	280-531	50
○ gray/gray	280-514	50

Technical Data

0.08 ... 2.5 mm ²	28 ... 12 AWG*
400 V/6 kV/3 ①②	300 V, 15 A ③
I _N 10 A (20 A)	300 V, 20 A ④
Terminal block width: 5 mm / 0.197 inch	
8 ... 9 mm / 0.31 ... 0.35 inch	

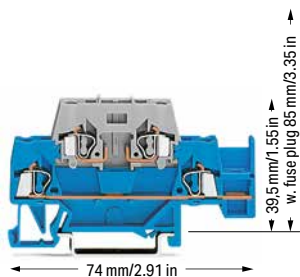

Double-deck terminal block; through/carrier terminal block for fuse plugs; with slot for adjacent jumper

Color	Item No.	Pack. Unit
blue/gray	280-532	50
○ gray/gray	280-891	50

Technical Data

0.08 ... 2.5 mm ²	28 ... 12 AWG*
400 V/6 kV/3 ①②	
I _N 10 A (10 A)	
Terminal block width: 5 mm / 0.197 inch	
8 ... 9 mm / 0.31 ... 0.35 inch	

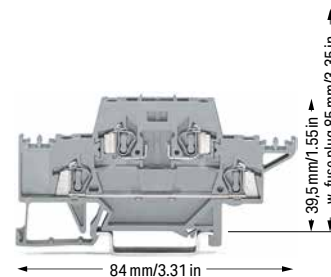

Double-deck terminal block; through/carrier terminal block for fuse plugs

Color	Item No.	Pack. Unit
○ gray/gray	280-528	50

5

Accessories; item-specific

End and intermediate plate; 2.5 mm thick

orange	280-341	100 (25)
gray	280-340	100 (25)

Intermediate plate; 1.1 mm thick

orange	280-366	100 (25)
--------	---------	----------

Accessories; item-specific

End and intermediate plate; 2.5 mm thick

orange	280-343	100 (25)
gray	280-342	100 (25)

Intermediate plate; 1.1 mm thick

orange	280-369	100 (25)
--------	---------	----------

Adjacent jumper; insulated; I_N = I_N terminal block

gray	280-402	200 (25)
------	---------	----------

Alternate jumper; insulated; I_N = I_N terminal block

gray	280-409	100 (25)
------	---------	----------

Accessories; item-specific

End and intermediate plate; 2.5 mm thick

orange	280-341	100 (25)
gray	280-340	100 (25)

Intermediate plate; 1.1 mm thick

orange	280-366	100 (25)
--------	---------	----------

Accessories

Appropriate marking system for fuse plugs:
WSB quick marking system

Insulation stop; 0.08 ... 0.2 mm² "s" (0.14 mm² "f-st"); 5 pcs/strip

white	280-470	200 (25)
-------	---------	----------

Insulation stop; 0.25 ... 0.5 mm²; 5 pcs/strip

light gray	280-471	200 (25)
------------	---------	----------

Insulation stop; 0.75 ... 1 mm²; 5 pcs/strip

dark gray	280-472	200 (25)
-----------	---------	----------

Fuse plug with pull-tab; 6 mm wide

	281-511	50
--	---------	----

Fuse plug with pull-tab; 6 mm wide

	281-512	50
--	---------	----

Fuse plug with pull-tab; 24 VAC/DC; with LED; 6 mm wide

	281-512/281-501	50
--	-----------------	----

Comb-style jumper bar; insulated; I_N = I_N of terminal block

2-way	280-482	200 (25)
3-way	280-483	200 (25)

Alternate comb-style jumper bar; insulated; I_N = I_N of terminal block

2-way	280-492	200 (25)
-------	---------	----------

Operating tool; insulated

2-way	280-432	1
3-way	280-433	1

Technical Data

0.08 ... 2.5 mm ²	28 ... 12 AWG*
400 V/6 kV/3 ①②	300 V, 15 A ③
I _N 20 A (20 A)	300 V, 20 A ④
Terminal block width: 5 mm / 0.197 inch	
8 ... 9 mm / 0.31 ... 0.35 inch	

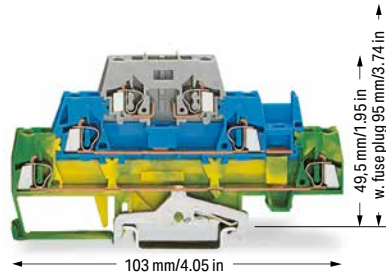

Triple-deck terminal block; ground conductor/through-carrier terminal block for fuse plugs

Color	Item No.	Pack. Unit
green-yellow/blue/gray	280-510	50

Triple-deck terminal block; through/through/carrier terminal block for fuse plugs

Color	Item No.	Pack. Unit
gray/gray/gray	280-889	50

Accessories; item-specific

End and intermediate plate; 2.5 mm thick

Color	Item No.	Pack. Unit
orange	280-304	50 (25)
gray	280-303	50 (25)

Intermediate plate; 1.1 mm thick

Color	Item No.	Pack. Unit
orange	280-336	50 (25)

Adjacent jumper; insulated; I_N = I_N terminal block

Color	Item No.	Pack. Unit
gray	280-402	200 (25)

Alternate jumper; insulated; I_N = I_N terminal block

Color	Item No.	Pack. Unit
gray	280-409	100 (25)

Vertical jumper; insulated; I_N 24 A

Color	Item No.	Pack. Unit
gray	281-421	200 (25)

WSB marking card; for fuse plugs (281-5.); white; 4 mm wide WSB markers

Item No.	Item No.	Pack. Unit
F1, ..., F10 (10x)	209-787	5
F11, ..., F20 (10x)	209-700/209-124	5
F21, ..., F30 (10x)	209-700/209-125	5
F31, ..., F40 (10x)	209-700/209-126	5
F41, ..., F50 (10x)	209-700/209-127	5

*12 AWG: THHN, THWN

- 500 V / 400 V = rated voltage
6 kV = rated impulse voltage
3 = pollution degree (see Section 14)

- Electrical ratings are given by the fuse or LED nominal voltage (see page 292).

Please observe the application notes:
Insulation stop, page 346
Comb-style jumper bar, page 347
Marking, from page 588

Approvals and corresponding ratings, visit www.wago.com

Accessories

Appropriate marking system for fuse plugs:
WSB quick marking system

WSB marking card; white, 10 strips with 10 markers/card; 4 mm wide WSB markers

Color	Item No.	Pack. Unit
plain	209-701	5

WSB marking card; plain; 10 strips with 10 markers/card; 4 mm wide WSB markers

Color	Item No.	Pack. Unit
yellow	209-701/000-002	5
red	209-701/000-005	5
blue	209-701/000-006	5
gray	209-701/000-007	5
orange	209-701/000-012	5
light green	209-701/000-017	5
green	209-701/000-023	5
violet	209-701/000-024	5

Screwless end stop; for DIN-35 rail; 6 mm wide

Color	Item No.	Pack. Unit
gray	249-116	100 (25)

Screwless end stop; for DIN-35 rail; 10 mm wide

Color	Item No.	Pack. Unit
gray	249-117	50 (25)

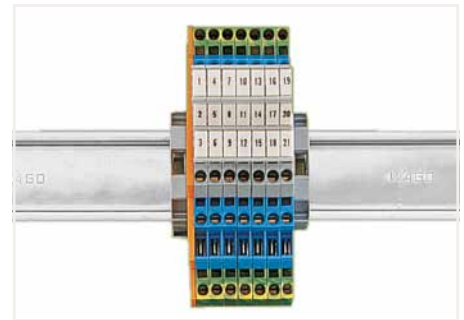

Double-deck (triple-deck) terminal blocks accommodate two (three) circuits of different potentials on two (three) decks; different circuits can be differentiated by color coding either deck (280 Series). The lower deck is wider than the upper for ease of wiring.

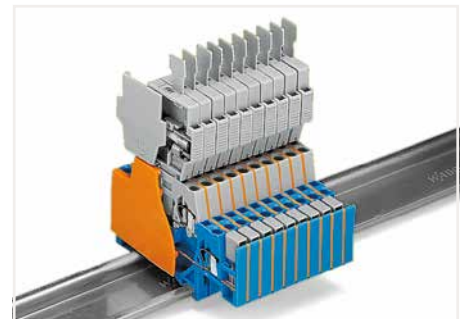

When double-deck terminal blocks are used with a fuse plug (6 mm wide) in the receptacle (top) level, the extra width can be compensated for the 280 Series (5 mm wide) via an intermediate plate (1.1 mm thick). If required, this special intermediate plate still allows commoning on the lower level via push-in adjacent jumpers (280-402).

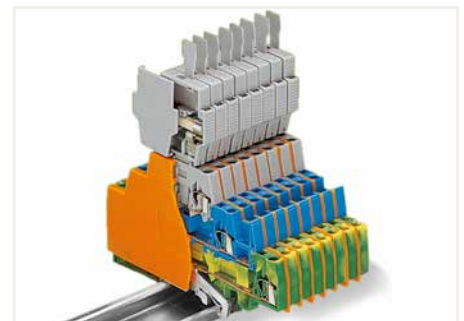

When triple-deck terminal blocks are used with a fuse plug (6 mm wide) in the receptacle (top) level, the extra width can be compensated for the 280 Series (5 mm wide) via an intermediate plate (1.1 mm thick).

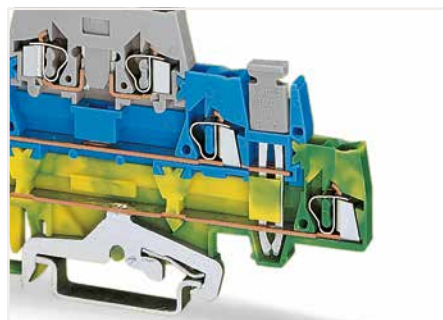

Grounding to DIN-rail:
Connecting N-level to ground level via vertical jumper.

Double-Deck Terminal Block

4 mm²; 281 Series

Technical Data	
0.08 ... 4 mm²	28 ... 12 AWG
500 V/6 kV/3 ①	600 V, 20 A ②
I _N 26 A	600 V, 25 A ③
Terminal block width: 6 mm / 0.236 inch	
9 ... 10 mm / 0.35 ... 0.39 inch	

Technical Data	
0.08 ... 4 mm²	28 ... 12 AWG
500 V/6 kV/3 ①	600 V, 20 A ②
I _N 26 A	600 V, 25 A ③
Terminal block width: 6 mm / 0.236 inch	
9 ... 10 mm / 0.35 ... 0.39 inch	

- ① 500 V = rated voltage
6 kV = rated impulse voltage
3 = pollution degree
(see Section 14)
 - ② Terminal blocks with a blue insulated housing are suitable for Ex i applications.
- Please observe the application notes:
Insulation stop, page 346
Comb-style jumper bar, page 347
Marking, from page 588
- Approvals and corresponding ratings, visit www.wago.com

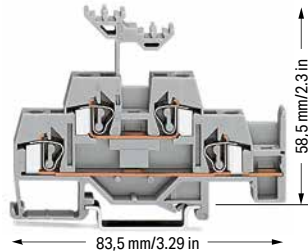
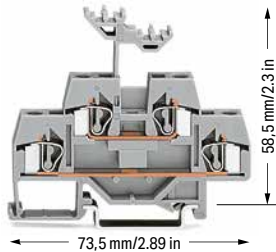

Double-deck terminal block; through/through terminal block		
Color	Item No.	Pack. Unit
○ gray	281-619	50
● blue	281-629 ②	50

Double-deck terminal block; through/through terminal block; with slot for adjacent jumper		
Color	Item No.	Pack. Unit
○ gray	281-620	50
● blue	281-630 ②	50

Other terminal blocks with the same profile:		
Diode	281-633/281-410	Page 336
LED	281-634/281-434	Page 336

Accessories; item-specific			
End and intermediate plate; 2.5 mm thick			
	orange	281-341	100 (25)
	gray	281-340	100 (25)

Accessories; item-specific			
End and intermediate plate; 2.5 mm thick			
	orange	281-343	100 (25)
	gray	281-342	100 (25)



The flexible marker carrier, which is placed above the wiring level, can be pushed aside during wiring or commoning. The carrier has two staggered levels for WMB markers that perfectly align with the terminal block decks.

Accessories; 281 Series
Appropriate marking systems: WMB/WMB Inline

Insulation stop; 0.08 ... 0.2 mm² "s" (0.14 mm² "f-st"); 5 pcs/strip			
	white	281-470	200 (25)

Alternate comb-style jumper bar; insulated; I _N = I _N of terminal block			
	2-way	281-492	100 (25)

Insulation stop; 0.25 ... 0.5 mm²; 5 pcs/strip			
	light gray	281-471	200 (25)

Operating tool; insulated			
	2-way	280-432	1
	3-way	280-433	1
	5-way	281-440	1

Insulation stop; 0.75 ... 1.5 mm²; 5 pcs/strip			
	dark gray	281-472	200 (25)

Screwless end stop; for DIN-35 rail; 6 mm wide			
	gray	249-116	100 (25)

Adjacent jumper; insulated; I _N = I _N terminal block			
	gray	281-402	200 (25)
	yellow-green	281-422	200 (25)

Screwless end stop; for DIN-35 rail; 10 mm wide			
	gray	249-117	50 (25)

Alternate jumper; insulated; I _N = I _N terminal block			
	gray	281-409	100 (25)

Vertical jumper; insulated; I _N 24 A			
	gray	281-421	200 (25)

Comb-style jumper bar; insulated; I _N = I _N of terminal block			
	2-way	281-482	100 (25)
	3-way	281-483	100 (25)
	5-way	281-485	100 (25)
	10-way	281-490	50 (25)

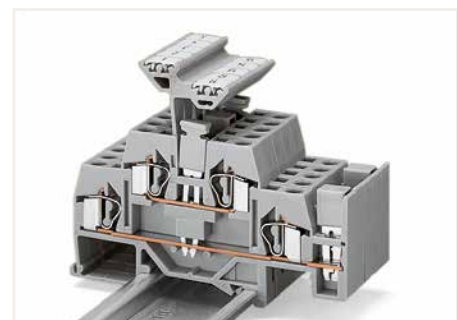

A vertical jumper allows commoning of upper and lower level, giving a 4-conductor commoned through terminal block in one housing. Two adjacent terminals may be commoned together on the same level using a push-in adjacent jumper.

Triple-Deck Terminal Block

2.5 mm²; 280 Series

Technical Data

0.08 ... 2.5 mm ²	28 ... 12 AWG*
500 V/6 kV/3 ①	300 V, 15 A ②
I _N 20 A	300 V, 20 A ③
Terminal block width: 5 mm / 0.197 inch	
8 ... 9 mm / 0.31 ... 0.35 inch	

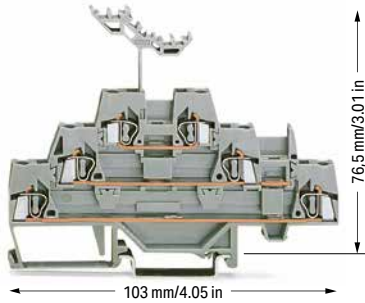

Triple-deck terminal block; through/through/through terminal block

Color	Item No.	Pack. Unit
○ gray	280-549	40
● blue	280-551	40

Accessories; item-specific

End and intermediate plate; 2.5 mm thick

orange	280-304	50 (25)
gray	280-303	50 (25)

Intermediate plate; 1.1 mm thick

orange	280-336	50 (25)
--------	---------	---------



Technical Data

0.08 ... 2.5 mm ²	28 ... 12 AWG*
500 V/6 kV/3 ①	300 V, 15 A ②
I _N 20 A	300 V, 20 A ③
Terminal block width: 5 mm / 0.197 inch	
8 ... 9 mm / 0.31 ... 0.35 inch	

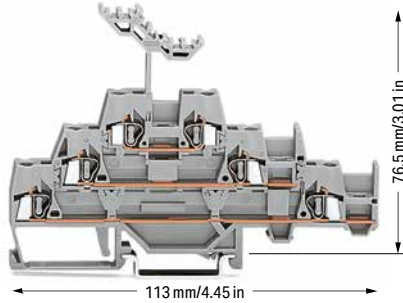

Triple-deck terminal block; through/through/through terminal block; with slot for adjacent jumper on lower level

Color	Item No.	Pack. Unit
○ gray	280-550	40

Accessories; item-specific

End and intermediate plate; 2.5 mm thick

orange	280-306	50 (25)
gray	280-305	50 (25)

Intermediate plate; 1.1 mm thick

orange	280-339	50 (25)
--------	---------	---------



Technical Data

0.08 ... 2.5 mm ²	28 ... 12 AWG*
500 V/6 kV/3 ①	300 V, 20 A ③
I _N 20 A	300 V, 20 A ③
Terminal block width: 5 mm / 0.197 inch	
8 ... 9 mm / 0.31 ... 0.35 inch	

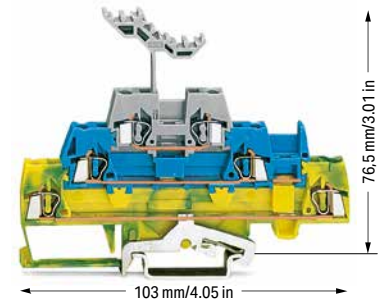

Triple-deck terminal block; ground conductor/through/through terminal block

Color	Item No.	Pack. Unit
green-yellow/blue/gray	280-547	40
green-yellow/gray/gray	280-557	40

Accessories; item-specific

End and intermediate plate; 2.5 mm thick

orange	280-304	50 (25)
gray	280-303	50 (25)

Intermediate plate; 1.1 mm thick

orange	280-336	50 (25)
--------	---------	---------

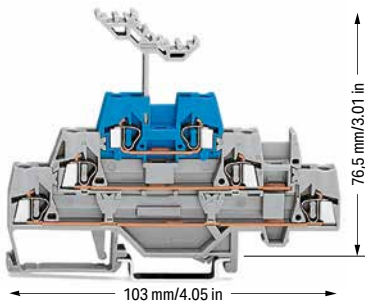

Triple-deck terminal block; through/through/through terminal block

Color	Item No.	Pack. Unit
gray/gray/blue	280-552	40

Accessories; item-specific

End and intermediate plate; 2.5 mm thick

orange	280-304	50 (25)
gray	280-303	50 (25)

Intermediate plate; 1.1 mm thick

orange	280-336	50 (25)
--------	---------	---------

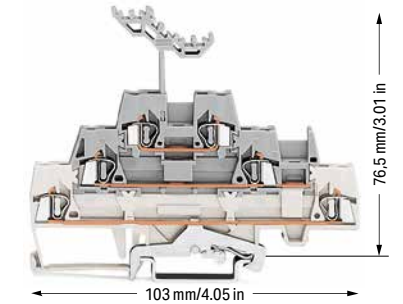

Triple-deck terminal block; shield conductor/through/through terminal block

Color	Item No.	Pack. Unit
white/gray/gray	280-548	40
white/blue/gray	280-558	40

Accessories; item-specific

End and intermediate plate; 2.5 mm thick

orange	280-304	50 (25)
gray	280-303	50 (25)

Intermediate plate; 1.1 mm thick

orange	280-336	50 (25)
--------	---------	---------

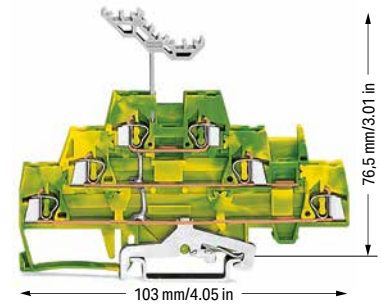

Triple-deck terminal block; 6-conductor ground terminal block; internally commoned

Color	Item No.	Pack. Unit
● green-yellow	280-597	40

Accessories; item-specific

End and intermediate plate; 2.5 mm thick

orange	280-304	50 (25)
gray	280-303	50 (25)

Intermediate plate; 1.1 mm thick

orange	280-336	50 (25)
--------	---------	---------



*12 AWG: THHN, THWN

1 500 V = rated voltage
6 kV = rated impulse voltage
3 = pollution degree
(see Section 14)

Please observe the application notes:
Insulation stop, page 346
Comb-style jumper bar, page 347
Marking, from page 588

Approvals and corresponding ratings,
visit www.wago.com

Accessories; 280 Series
Appropriate marking systems:
WMB/WMB Inline

Insulation stop; 0.08 ... 0.2 mm² "s" (0.14 mm² "f-st"); 5 pcs/strip

white	280-470	200 (25)
-------	---------	----------

Insulation stop; 0.25 ... 0.5 mm²; 5 pcs/strip

light gray	280-471	200 (25)
------------	---------	----------

Insulation stop; 0.75 ... 1 mm²; 5 pcs/strip

dark gray	280-472	200 (25)
-----------	---------	----------

Adjacent jumper; insulated; I_N = I_N terminal block

gray	280-402	200 (25)
yellow-green	280-422	200 (25)

Alternate jumper; insulated; I_N = I_N terminal block

gray	280-409	100 (25)
------	---------	----------

Vertical jumper; insulated; I_N 24 A

gray	281-421	200 (25)
------	---------	----------

Comb-style jumper bar; insulated; I_N = I_N of terminal block

2-way	280-482	200 (25)
3-way	280-483	200 (25)

Comb-style jumper bar; insulated; I_N = I_N of terminal block

10-way	280-490	50 (25)
--------	---------	---------

Alternate comb-style jumper bar; insulated; I_N = I_N of terminal block

2-way	280-492	200 (25)
-------	---------	----------

Operating tool; insulated

2-way	280-432	1
3-way	280-433	1

Operating tool; insulated

10-way	280-440	1
--------	---------	---

Screwless end stop; for DIN-35 rail; 6 mm wide

gray	249-116	100 (25)
------	---------	----------

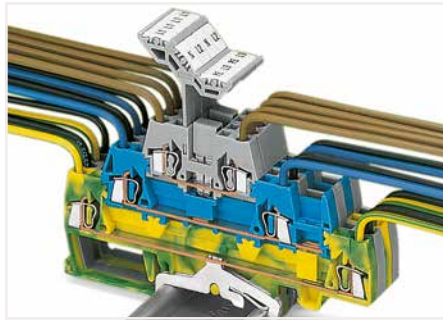

Three-conductor power circuit with additional branch circuit tapping

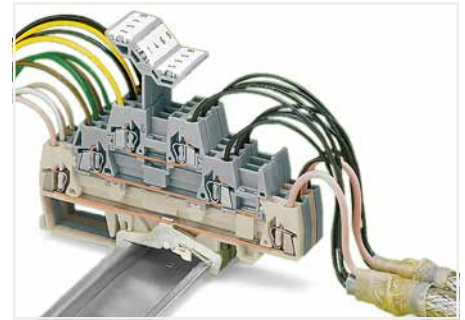

Shielded twisted pair cables

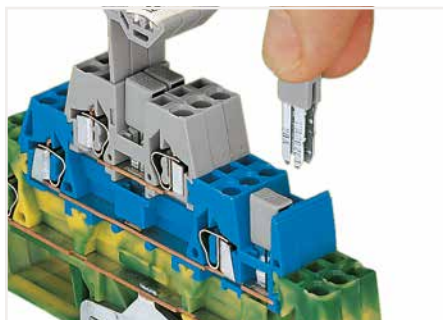

Triple-deck terminal blocks accommodate three circuits of different potentials on three decks; different circuits can be differentiated by color coding either deck (280 Series).

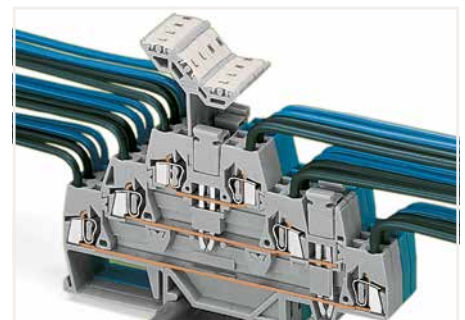

Commoning with vertical and adjacent jumpers.

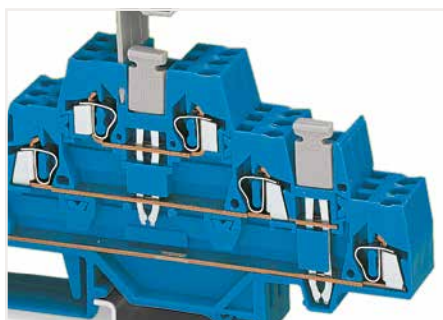

A vertical jumper allows commoning of the upper and lower levels, providing a 6-conductor feedthrough terminal block in one housing. Two adjacent triple-deck terminal blocks may be commoned together on the same level using a push-in adjacent jumper.

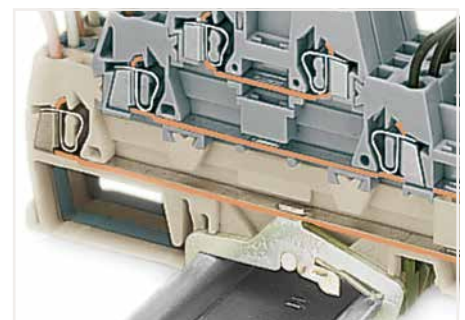

Both ground and shield conductor terminal blocks have a contact foot in the bottom level, automatically establishing direct contact to the DIN-rail or busbar. The flexible marker carrier, which is placed above the wiring level, can be pushed aside during wiring. The carrier has two staggered levels for WMB markers that perfectly align with the terminal block decks. With a terminal block width of just 5 mm, an effective width of just 1.67 mm for terminal blocks of same or different potentials can be realized for conductors ranging 0.08 mm² ... 2.5 mm² (28 ... 14 AWG).

Quadruple-Deck Rail-Mount Terminal Block for Electric Motor Wiring

4 mm²; 281 Series

Technical Data	
0.08 ... 4 mm ²	28 ... 12 AWG
400 V/6 kV/3	600 V, 20 A
I _N 20 A (2.5 mm ²)	300 V, 25 A
I _N 25 A (4 mm ²)	
Terminal block width: 6 mm / 0.236 inch	
8 ... 9 mm / 0.31 ... 0.35 inch	

Technical Data	
0.08 ... 4 mm ²	28 ... 12 AWG
400 V/6 kV/3	600 V, 20 A
I _N 20 A (2.5 mm ²)	300 V, 25 A
I _N 25 A (4 mm ²)	
Terminal block width: 6 mm / 0.236 inch	
8 ... 9 mm / 0.31 ... 0.35 inch	

Technical Data	
0.08 ... 4 mm ²	28 ... 12 AWG
400 V/6 kV/3	600 V, 20 A
I _N 20 A (2.5 mm ²)	300 V, 25 A
I _N 25 A (4 mm ²)	
Terminal block width: 6 mm / 0.236 inch	
8 ... 9 mm / 0.31 ... 0.35 inch	

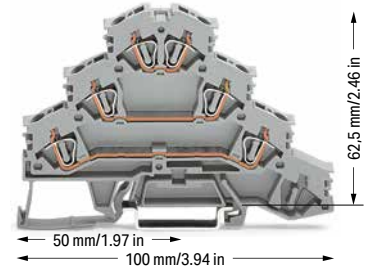
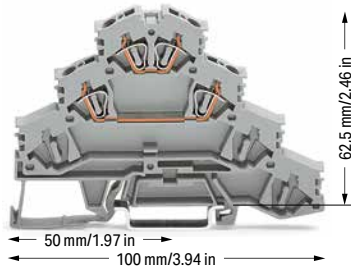
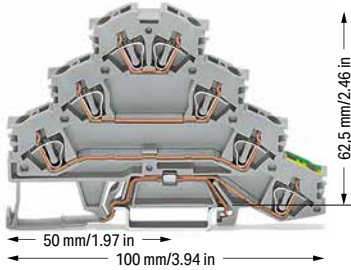

Quadruple-deck rail-mount terminal block; Rail-mount terminal block for electric motor wiring; gray		
	Item No.	Pack. Unit
L1 - L2 - L3 - PE	281-530	50

Quadruple-deck rail-mount terminal block; Rail-mount terminal block for electric motor wiring; gray		
	Item No.	Pack. Unit
L1 - L2	281-531	50

Quadruple-deck rail-mount terminal block; Rail-mount terminal block for electric motor wiring; gray		
	Item No.	Pack. Unit
L1 - L2 - L3	281-532	50

Accessories; 281 Series

End and intermediate plate; 1 mm thick			
	orange	281-366	100 (25)
	gray	281-365	100 (25)

	white	281-470	200 (25)
--	-------	---------	----------

Insulation stop; 0.25 ... 0.5 mm ² ; 5 pcs/strip			
	light gray	281-471	200 (25)

Insulation stop; 0.75 ... 1.5 mm ² ; 5 pcs/strip			
	dark gray	281-472	200 (25)

Comb-style jumper bar; insulated; I _N = I _N of terminal block			
	2-way	281-482	100 (25)
	3-way	281-483	100 (25)
	5-way	281-485	100 (25)
	10-way	281-490	50 (25)

Alternate comb-style jumper bar; insulated; I _N = I _N of terminal block			
	2-way	281-492	100 (25)

Operating tool; insulated			
	2-way	280-432	1
	3-way	280-433	1
	5-way	281-440	1

Test plug; with 500 mm cable; 2 mm Ø; max. 42 V			
	red	210-137	50

Test plug; with 500 mm cable; 2.3 mm Ø; max. 42 V			
	yellow	210-137	50

Appropriate marking systems: WMB/Marking strips

Marking strip; plain; 7.5 mm wide; 50 m reel			
	translucent	709-177	1

WMB marking card; white; 10 strips with 10 markers/card; stretchable 5 ... 5.2 mm			
	plain	793-5501	5

WMB marking card; plain; 10 strips with 10 markers/card; stretchable 5 ... 5.2 mm			
	yellow	793-5501/000-002	5
	red	793-5501/000-005	5
	blue	793-5501/000-006	5
	gray	793-5501/000-007	5
	orange	793-5501/000-012	5
	light green	793-5501/000-017	5
	green	793-5501/000-023	5
	violet	793-5501/000-024	5

Screwless end stop; for DIN-35 rail; 6 mm wide			
	gray	249-116	100 (25)

Screwless end stop; for DIN-35 rail; 10 mm wide			
	gray	249-117	50 (25)

- 1 400 V = rated voltage
- 6 kV = rated impulse voltage
- 3 = pollution degree
- (see Section 14)

Please observe the application notes:
Insulation stop, page 346
Comb-style jumper bar, page 347
Marking, from page 588

Approvals and corresponding ratings,
visit www.wago.com

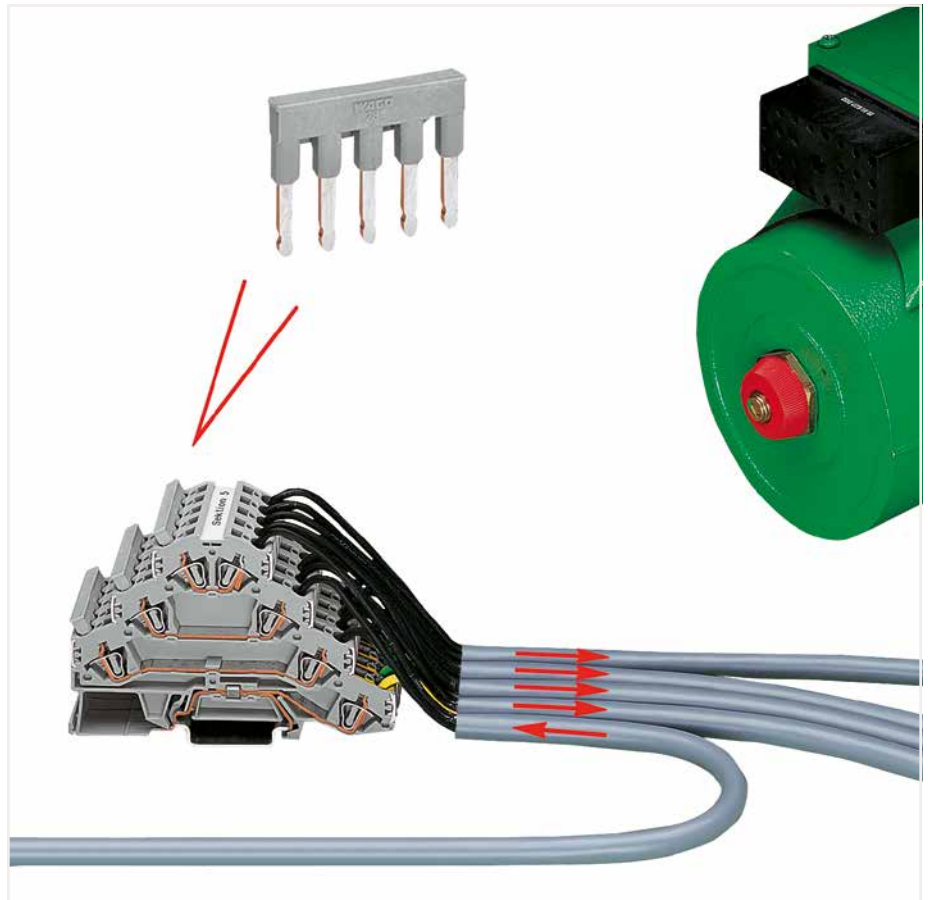

5



In addition to rail-mount terminal blocks for electric motor wiring, special versions are also available:

- Version **without** ground contact and only two potentials: These terminal blocks were custom designed to support additional functions, such as engine brakes or temperature sensors. Sharing a common profile, this terminal block version can be put next to the appropriate electric motor wiring terminal block without using intermediate plates. That makes the rail assembly easier to understand and wire. This also prevents wiring errors as no conductor entry is unused.
- Version **without** ground contact and with three potentials:

Clearly designated clamping units are the primary advantage to this terminal block design. When using devices with protective insulation, for example, there are no open ground clamping units that could create confusion.



Commoning using comb-style jumper bars.
Push comb-style jumper bars down until fully inserted.



Testing with voltage tester.



Marking clamping points via WMB Multi Marking System.
Marking groups via marking strips (709-177).

Rail-Mount Terminal Blocks TOPJOB® Classic

780 ... 785 Series

Description and Installation

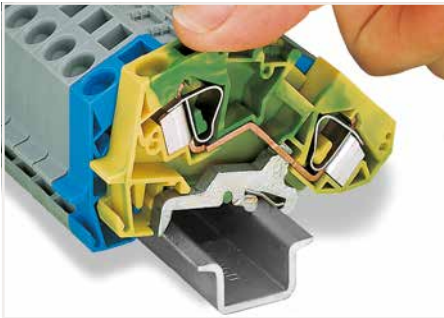

By snapping a ground conductor terminal block onto the DIN-rail, a direct electrical connection is automatically made to the rail.



Removing a terminal block from the assembly.

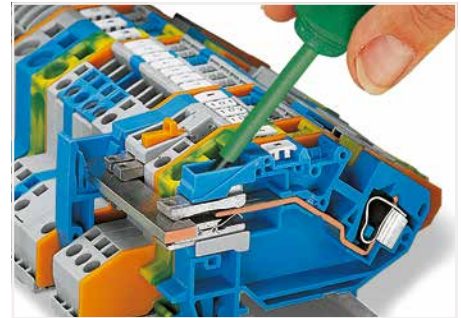

Operating an N-disconnect slide link.

5



Commoning ground conductor terminal blocks with through terminal blocks is possible in one direction only (via rear side of terminal block) using adjacent jumpers. Recommends using yellow-green adjacent jumpers in addition to the required marking of these blocks.



Staggered jumpers for sophisticated circuit requirements – push jumpers down until fully inserted.

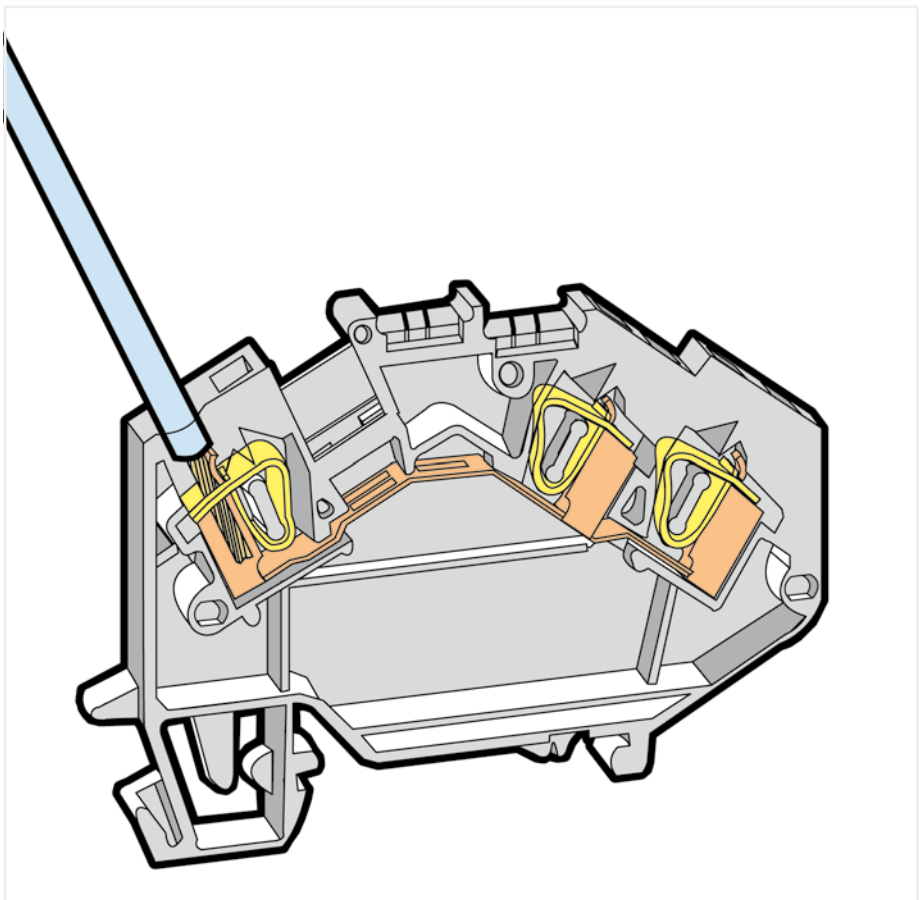

Test plug module assembly – combining test plug and spacer modules.



Insulation stop:
Prevents the conductor insulation from being pushed into the clamping unit.
(Available for terminal blocks up to 4 mm²/12 AWG)



Labeling via WMB Multi markers and WFB continuous marking strips.

Through/Ground Conductor/Shield Conducto and Ex Terminal Block TOPJOB® Classic 2.5 mm²; 780 Series

Technical Data	
0.08 ... 2.5 mm ²	28 ... 12 AWG*
1000 V/8 kV/3 ①	600 V, 20 A ②
I _N 24 A	600 V, 20 A ③
Terminal block width: 5 mm / 0.197 inch	
8 ... 9 mm / 0.31 ... 0.35 inch	

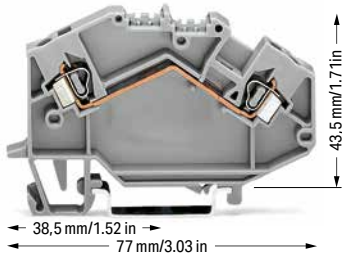

Technical Data	
0.08 ... 2.5 mm ²	28 ... 12 AWG*
1000 V/8 kV/3 ①	600 V, 20 A ②
I _N 24 A	600 V, 25 A ③
Terminal block width: 5 mm / 0.197 inch	
8 ... 9 mm / 0.31 ... 0.35 inch	

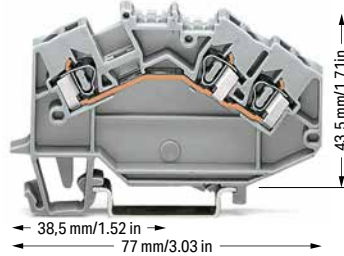

2-conductor through terminal block		
Color	Item No.	Pack. Unit
gray	780-601	50
blue	780-604 ②	50
orange	780-602	50
light gray ③	780-992 ④	50

3-conductor through terminal block		
Color	Item No.	Pack. Unit
gray	780-631	50
blue	780-651 ②	50
orange	780-654	50
light gray ③	780-993 ④	50

2-conductor ground terminal block		
green-yellow	780-607	50
green-yellow ③	780-607/999-950 ④	50

3-conductor ground terminal block		
green-yellow	780-637	50
green-yellow ③	780-637/999-950 ④	50

3-conductor shield terminal block		
white	780-640	50

Other terminal blocks with the same profile:		
N-disconnect	780-613	Page 271

Accessories; 780 Series Appropriate marking systems: WMB/WMB Inline/WFB

End and intermediate plate; 1.5 mm thick		
orange	780-317	100 (25)

Ex e/Ex i separator; orange; 3 mm thick		
125.5 mm	209-192	50 (25)

Insulation stop; 0.08 ... 0.2 mm ² "s" (0.14 mm ² "f-st"); 5 pcs/strip		
white	280-470	200 (25)

Insulation stop; 0.25 ... 0.5 mm ² ; 5 pcs/strip		
light gray	280-471	200 (25)

Insulation stop; 0.75 ... 1 mm ² ; 5 pcs/strip		
dark gray	280-472	200 (25)

Protective warning marker; with black high-voltage symbol; for 5 terminal blocks		
yellow	280-415	100 (25)

Adjacent jumper; insulated; I _N = I _N terminal block		
gray	280-402	200 (25)
yellow-green	280-422	200 (25)

Alternate jumper; insulated; I _N = I _N terminal block		
gray	280-409	100 (25)

Staggered jumper; insulated; 5 mm wide; I _N 24 A		
1 to 2	780-452	100 (25)
1 to 3	780-453	100 (25)
1 to 4	780-454	100 (25)
1 to 5	780-455	50 (25)
1 to 6	780-456	50 (25)
1 to 7	780-457	50 (25)
1 to 8	780-458	50 (25)

Push-in type wire jumper; insulated; 0.75 mm ² conductor cross section; I _N 9 A		
L = 60 mm	249-125	100 (10)
L = 110 mm	249-126	100 (10)
L = 250 mm	249-127	100 (10)

Comb-style jumper bar; insulated; I _N = I _N of terminal block		
2-way	280-482	200 (25)
3-way	280-483	200 (25)
10-way	280-490	50 (25)

Alternate comb-style jumper bar; insulated; I _N = I _N of terminal block		
2-way	280-492	200 (25)

Operating tool; insulated		
2-way	280-432	1
3-way	280-433	1
10-way	280-440	1

*12 AWG: THHN, THWN

① 1000 V = rated voltage
8 kV = rated impulse voltage
3 = pollution degree (see Section 14)

② Terminal blocks with a blue insulated housing are suitable for Ex i applications.

③ Terminal blocks with an Ex mark are suitable for Ex e II applications.
0.2 ... 2.5 mm² / 24 ... 12 AWG*
690 V; 23 A (see Section 14)
Using staggered jumpers reduces the maximum rated voltage to 275 V.

Please observe the application notes:
Insulation stop, page 346
Jumpers, from page 348
Comb-style jumper bar, page 347
Testing accessories, from page 342
Marking, from page 588

Approvals and corresponding ratings, visit www.wago.com

Accessories; 780 Series

Appropriate marking systems:
WMB/WMB Inline/WFB

Test plug module; snaps together; 5 mm wide

gray	280-418	100 (25)
------	---------	----------

Spacer module; snaps together; 5 mm wide

gray	280-419	100 (25)
------	---------	----------

Test plug adapter; 8.3 mm wide; for 4 mm Ø test plug; for 1.5 ... 10 mm² terminal blocks

gray	209-170	50 (25)
------	---------	---------

Banana plug; for 4 mm socket diameter; color mixed; 10 x orange, white, black, blue, yellow; max. 42 V

	215-111	50
--	---------	----

Test plug adapter; 5 mm wide; for 210-137 Test Plug (2.3 mm Ø); for 1.5 ... 4 mm² terminal blocks

gray	280-404	100 (25)
------	---------	----------

Test plug adapter; 6 mm wide; with CAGE CLAMP®; for 0.08 ... 2.5 mm²

I _N 24 A	281-407	100 (25)
---------------------	---------	----------

Test plug; with 500 mm cable; 2.3 mm Ø; max. 42 V

yellow	210-137	50
--------	---------	----

Operating tool; specialty blade; for all TOPJOB® terminal blocks

	777-310	1
--	---------	---

Screwless end stop; for DIN-35 rail; 6 mm wide

gray	249-116	100 (25)
------	---------	----------

Through/Ground Conductor and Ex Terminal Block TOPJOB® Classic 4 mm²; 781 Series

Technical Data

0.08 ... 4 mm ²	28 ... 12 AWG
1000 V/8 kV/3 ①	600 V, 20 A ②
I _N 32 A	600 V, 20 A ③
Terminal block width: 6 mm / 0.236 inch	
9 ... 10 mm / 0.35 ... 0.39 inch	

Technical Data

0.08 ... 4 mm ²	28 ... 12 AWG
1000 V/8 kV/3 ①	600 V, 20 A ②
I _N 32 A	600 V, 20 A ③
Terminal block width: 6 mm / 0.236 inch	
9 ... 10 mm / 0.35 ... 0.39 inch	

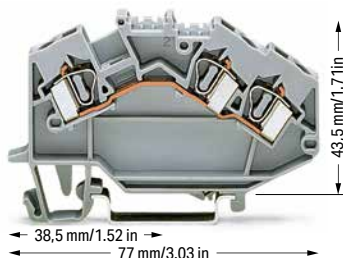

2-conductor through terminal block

Color	Item No.	Pack. Unit
gray	781-601	50
blue	781-604 ②	50
light gray ③	781-992 ③	50

3-conductor through terminal block

Color	Item No.	Pack. Unit
gray	781-631	50
blue	781-651 ②	50
light gray ③	781-993 ③	50

2-conductor ground terminal block

green-yellow	781-607	50
green-yellow ③	781-607/999-950 ③	50

3-conductor ground terminal block

green-yellow	781-637	50
green-yellow ③	781-637/999-950 ③	50

Other terminal blocks with the same profile:

N-disconnect	781-613	Page 271
Potential	781-623	Page 271

Other terminal blocks with the same profile:

N-disconnect	781-643	Page 271
Potential	781-653	Page 271

Accessories; 781 Series

Appropriate marking systems: WMB/WMB Inline/WFB

End and intermediate plate; 1.5 mm thick

orange	780-317	100 (25)
--------	---------	----------

Ex e/Ex i separator; orange; 3 mm thick

125.5 mm	209-192	50 (25)
----------	---------	---------

Insulation stop; 0.08 ... 0.2 mm² "s" (0.14 mm² "f-st"); 5 pcs/strip

white	281-470	200 (25)
-------	---------	----------

Insulation stop; 0.25 ... 0.5 mm²; 5 pcs/strip

light gray	281-471	200 (25)
------------	---------	----------

Insulation stop; 0.75 ... 1.5 mm²; 5 pcs/strip

dark gray	281-472	200 (25)
-----------	---------	----------

Protective warning marker; with black high-voltage symbol; for 5 terminal blocks

yellow	281-415	100 (25)
--------	---------	----------

Adjacent jumper; insulated; I_N = I_N terminal block

gray	281-402	200 (25)
yellow-green	281-422	200 (25)

Alternate jumper; insulated; I_N = I_N terminal block

gray	281-409	100 (25)
------	---------	----------

Staggered jumper; insulated; 6 mm wide; I_N 32 A

1 to 2	781-452	100 (25)
1 to 3	781-453	100 (25)
1 to 4	781-454	100 (25)
1 to 5	781-455	50 (25)
1 to 6	781-456	50 (25)

Push-in type wire jumper; insulated; 0.75 mm² conductor cross section; I_N 9 A

L = 60 mm	249-125	100 (10)
L = 110 mm	249-126	100 (10)
L = 250 mm	249-127	100 (10)

Comb-style jumper bar; insulated; I_N = I_N of terminal block

2-way	281-482	100 (25)
3-way	281-483	100 (25)
5-way	281-485	100 (25)
10-way	281-490	50 (25)

Alternate comb-style jumper bar; insulated; I_N = I_N of terminal block

2-way	281-492	100 (25)
-------	---------	----------

Operating tool; insulated

2-way	280-432	1
3-way	280-433	1
5-way	281-440	1

① 1000 V = rated voltage
8 kV = rated impulse voltage
3 = pollution degree
(see Section 14)

② Terminal blocks with a blue insulated housing are suitable for Ex i applications.

③ Terminal blocks with an Ex mark are suitable for Ex e II applications.
0.2 ... 4 mm² / 24 ... 12 AWG
690 V
30 A, for 2-conductor terminal blocks
27 A, for 3-conductor terminal blocks
(see Section 14)
Using staggered jumpers reduces the maximum rated voltage to 275 V.

Please observe the application notes:

- Insulation stop, page 346
- Jumpers, from page 348
- Comb-style jumper bar, page 347
- Testing accessories, from page 342
- Marking, from page 588

Approvals and corresponding ratings, visit www.wago.com

Accessories; 781 Series

Appropriate marking systems:
WMB/WMB Inline/WFB

Test plug module; snaps together; 6 mm wide

gray	280-418	100 (25)
------	---------	----------

Spacer module; snaps together; 5 mm wide

gray	280-419	100 (25)
------	---------	----------

Test plug adapter; 8.3 mm wide; for 4 mm Ø test plug; for 1.5 ... 10 mm² terminal blocks

gray	209-170	50 (25)
------	---------	---------

Banana plug; for 4 mm socket diameter; color mixed; 10 x orange, white, black, blue, yellow; max. 42 V

	215-111	50
--	---------	----

Test plug adapter; 5 mm wide; for 210-137 Test Plug (2.3 mm Ø); for 1.5 ... 4 mm² terminal blocks

gray	280-404	100 (25)
------	---------	----------

Test plug adapter; 6 mm wide; with CAGE CLAMP®; for 0.08 ... 2.5 mm²

I _N 24 A	281-407	100 (25)
---------------------	---------	----------

Test plug; with 500 mm cable; 2.3 mm Ø; max. 42 V

yellow	210-137	50
--------	---------	----

Operating tool; specialty blade; for all TOPJOB® terminal blocks

	777-310	1
--	---------	---

Screwless end stop; for DIN-35 rail; 6 mm wide

gray	249-116	100 (25)
------	---------	----------

5

Through/Ground Conductor and Ex Terminal Block TOPJOB® Classic

6 mm²; 782 Series and 10 (16) mm²; 784 Series

Technical Data

0.2 ... 6 mm ²	24 ... 10 AWG
1000 V/8 kV/3 ②	600 V, 30 A ③
I _N 41 A	600 V, 25 A ④
Terminal block width: 8 mm / 0.315 inch	
 12 ... 13 mm / 0.47 ... 0.51 inch	

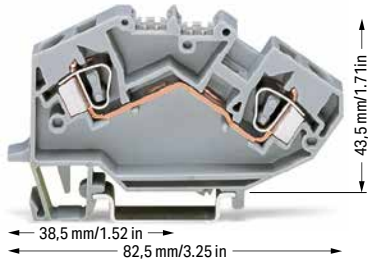

2-conductor through terminal block

Color	Item No.	Pack. Unit
gray	782-601	25
blue	782-604 ③	25
light gray ④	782-992 ④	50

2-conductor ground terminal block

green-yellow	782-607	25
green-yellow ④	782-607/999-950 ④	25

Other terminal blocks with the same profile:

N-disconnect	782-613	Page 272
Potential	782-623	Page 272

Accessories; item-specific

Adjacent jumper; insulated; I_N 41 A

 gray	282-402	100 (25)
yellow-green	282-422	100 (25)

Alternate jumper; insulated; I_N 41 A

 gray	282-409	100 (25)
--	---------	----------

Protective warning marker; with black high-voltage symbol; for 5 terminal blocks

 yellow	282-415	100 (25)
--	---------	----------

B-type test plug module; snaps together; 8 mm wide

 gray	709-310	100 (25)
--	---------	----------

B-type spacer module; snaps together; 8 mm wide

 gray	709-311	100 (25)
--	---------	----------

Technical Data

0.2 ... 10 (16) mm ² ①	24 ... 6 AWG
1000 V/8 kV/3 ②	600 V, 50 A ③
I _N 57 A	600 V, 35 A ④
Terminal block width: 10 mm / 0.394 inch	
 12 ... 13 mm / 0.47 ... 0.51 inch	

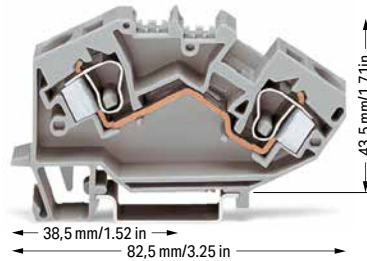

2-conductor through terminal block

Color	Item No.	Pack. Unit
gray	784-601	25
blue	784-604 ③	25
light gray ④	784-992 ⑤	25

2-conductor ground terminal block

green-yellow	784-607	25
green-yellow ④	784-607/999-950 ⑤	25

Other terminal blocks with the same profile:

N-disconnect	784-613	Page 272
Potential	784-623	Page 272

Accessories; item-specific

Adjacent jumper; insulated; I_N 57 A

 gray	284-402	100 (25)
yellow-green	284-422	100 (25)

Alternate jumper; insulated; I_N 57 A

 orange	284-409	50 (25)
--	---------	---------

Protective warning marker; with black high-voltage symbol; for 5 terminal blocks

 yellow	284-415	50 (25)
--	---------	---------

B-type test plug module; snaps together; 8 mm wide

 gray	709-310	100 (25)
--	---------	----------

B-type spacer module; snaps together; 8 mm wide

 gray	709-311	100 (25)
--	---------	----------

B-type spacer plate; snaps together; 2 mm wide

 gray	709-312	100 (25)
--	---------	----------

Finger guard; touch-proof cover protects unused conductor entries

 yellow	284-400	100 (25)
--	---------	----------

- Max. conductor cross section: 16 mm²
- 1000 V = rated voltage
8 kV = rated impulse voltage
3 = pollution degree
(see Section 14)
- Terminal blocks with a blue insulated housing are suitable for Ex i applications.
- Terminal blocks with an Ex mark are suitable for Ex e II applications.
0.2 ... 6 mm² / 24 ... 10 AWG
690 V; 39 A
(see Section 14)
- Terminal blocks with an Ex mark are suitable for Ex e II applications.
0.2 ... 10 mm²/24 ... 8 AWG
690 V; 53 A
(see Section 14)

Please observe the application notes:
Test plug module, page 345
Marking, from page 588

Approvals and corresponding ratings,
visit www.wago.com

Accessories

Appropriate marking systems:
WMB/WMB Inline/WFB

End and intermediate plate; 1.5 mm thick

orange 782-317 100 (25)

Ex e/Ex i separator; orange; 3 mm thick

125.5 mm 209-192 50 (25)

Test plug adapter; 8.3 mm wide; for 4 mm Ø test plug; for 1.5 ... 10 mm² terminal blocks

gray 209-170 50 (25)

Banana plug; for 4 mm socket diameter; color mixed; 10 x orange, white, black, blue, yellow; max. 42 V

215-111 50

Busbar carrier; with end stop function and detachable separator plate; snaps onto DIN-35 rail; 8 mm thick

blue 777-305 25

WFB continuous marking strip; 1000 mm long

transparent 210-612 10

Carrier for WFB continuous marking strip; snaps into marker slot

gray 209-185 200 (25)

Operating tool; specialty blade; for all TOPJOB® terminal blocks

777-310 1

Screwless end stop; for DIN-35 rail; 6 mm wide

gray 249-116 100 (25)

Through/Ground Conductor and Ex Terminal Block TOPJOB® Classic

16 mm²; 783 Series and 35 mm²; 785 Series

Technical Data	
0.2 ... 16 mm²	24 ... 6 AWG
1000 V/8 kV/3 ①	600 V, 65 A ②
I _N 76 A	600 V, 50 A ③
Terminal block width: 12 mm / 0.472 inch	
16 ... 17 mm / 0.63 ... 0.67 inch	

Technical Data	
6 ... 35 mm²	8 ... 2 AWG
1000 V/8 kV/3 ①	600 V, 115 A ②
I _N 125 A	600 V, 125 A ③
Terminal block width: 16 mm / 0.63 inch	
23 mm / 0.91 inch	

- ① 1000 V = rated voltage
8 kV = rated impulse voltage
3 = pollution degree
(see Section 14)
- ② Terminal blocks with a blue insulated housing are suitable for Ex i applications.
- ③ Terminal blocks with an Ex mark are suitable for Ex e II applications.
0.2 ... 6 mm² / 24 ... 10 AWG
690 V; 39 A
(see Section 14)
- ④ Terminal blocks with an Ex mark are suitable for Ex e II applications.
0.2 ... 10 mm²/24 ... 8 AWG
690 V; 53 A
(see Section 14)

Please observe the application notes:
Marking, from page 588

Approvals and corresponding ratings,
visit www.wago.com

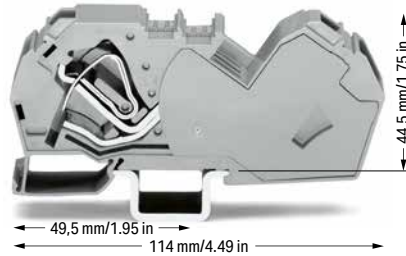
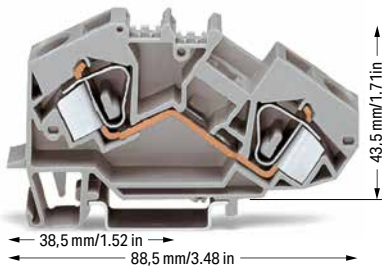

2-conductor through terminal block		
Color	Item No.	Pack. Unit
gray	783-601	25
blue	783-604 ②	25
light gray ③	783-992 ③	25

2-conductor through terminal block		
Color	Item No.	Pack. Unit
gray	785-601	25
blue	785-604	25

2-conductor ground terminal block		
green-yellow	783-607	25
green-yellow ③	783-607/999-950 ③	25

2-conductor ground terminal block		
green-yellow	785-607	25

Other terminal blocks with the same profile:		
N-disconnect	783-613	Page 272
Potential	783-623	Page 272

Other terminal blocks with the same profile:		
N-disconnect	785-613	Page 273
Potential	785-623	Page 273

Accessories; item-specific		
End and intermediate plate; 1.5 mm thick		
orange	783-317	100 (25)

Accessories; item-specific		
Adjacent jumper; insulated; I _N 85 A		
gray	284-402	50 (25)

Protective warning marker; with black high-voltage symbol; for 5 terminal blocks		
yellow	283-415	50 (25)

Protective warning marker; with black high-voltage symbol; for 5 terminal blocks		
yellow	285-416	50 (25)

Finger guard; touch-proof cover protects unused conductor entries		
yellow	283-400	100 (25)

Finger guard; touch-proof cover protects unused conductor entries		
yellow	285-401	100

Adjacent jumper; insulated; I _N 70 A		
gray	283-402	100 (25)
yellow-green	283-422	100 (25)

Power tap; IN 24 A; with 500 mm cable; for 16 mm² (283/783 Series) and 35 mm² (285/785 Series) rail-mount terminal blocks		
gray	283-407	25

Alternate jumper; insulated; I _N 76 A		
gray	283-409	100 (25)

Power tap; IN 24 A; with 500 mm cable; for 16 mm² (283/783 Series) and 35 mm² (285/785 Series) rail-mount terminal blocks		
gray	283-407	25

Accessories

Appropriate marking systems:
WMB/WMB Inline/WFB

Test plug adapter; 8.3 mm wide; for 4 mm Ø test plug; for 1.5 ... 10 mm² terminal blocks

gray	283-404	25
------	---------	----

Banana plug; for 4 mm socket diameter; color mixed; 10 x orange, white, black, blue, yellow; max. 42 V

	215-111	50
--	---------	----

Busbar carrier; with end stop function and detachable separator plate; snaps onto DIN-35 rail; 8 mm thick

blue	777-305	25
------	---------	----

WFB continuous marking strip; 1000 mm long

transparent	210-612	10
-------------	---------	----

Carrier for WFB continuous marking strip; snaps into marker slot

gray	209-185	200 (25)
------	---------	----------

WMB marking card; white; 10 strips with 10 markers/card; for 5 ... 17.5 mm terminal block width

plain	793-501	5
-------	---------	---

WMB marking card; white; 10 strips with 10 markers/card; stretchable 5 ... 5.2 mm

plain	793-5501	5
-------	----------	---

Operating tool; specialty blade; for all TOPJOB® terminal blocks

	777-310	1
--	---------	---

Screwless end stop; for DIN-35 rail; 6 mm wide

gray	249-116	100 (25)
------	---------	----------

5

N-Disconnect Terminal Block and Power Distribution Disconnect Terminal Block

TOPJOB® Classic

2.5 mm²; 780 Series and 4 mm²; 781 Series

Technical Data	
0.08 ... 2.5 mm ²	28 ... 12 AWG*
400 V/6 kV/3 ①	600 V, 20 A ②
I _N 24 A	
Terminal block width: 5 mm / 0.197 inch	
8 ... 9 mm / 0.31 ... 0.35 inch	

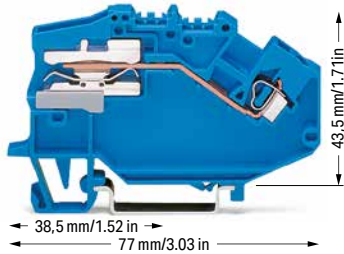

1-conductor N-disconnect terminal block		
Color	Item No.	Pack. Unit
● blue	780-613 ②	50

Other terminal blocks with the same profile:		
Through	780-601	Page 267

Technical Data	
0.08 ... 4 mm ²	28 ... 12 AWG
400 V/6 kV/3 ①	600 V, 20 A ②
I _N 32 A	
Terminal block width: 6 mm / 0.236 inch	
9 ... 10 mm / 0.35 ... 0.39 inch	



1-conductor power distribution disconnect terminal block		
Color	Item No.	Pack. Unit
● blue	781-613 ②	50

1-conductor power distribution disconnect terminal block		
○ gray	781-623 ③	50

Other terminal blocks with the same profile:		
Through	781-601	Page 268

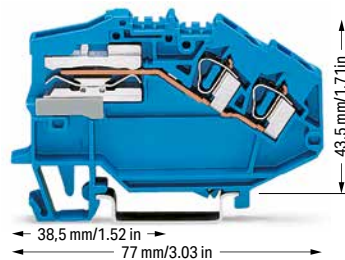

2-conductor N-disconnect terminal block		
Color	Item No.	Pack. Unit
● blue	781-643 ②	50

2-conductor power distribution disconnect terminal block		
○ gray	781-653 ③	50

Other terminal blocks with the same profile:		
Through	781-631	Page 268

*12 AWG: THHN, THWN

- ① 400 V = rated voltage
6 kV = rated impulse voltage
3 = pollution degree (see Section 14)
 - ② See page 273
 - ③ See page 273
- Approvals and corresponding ratings, visit www.wago.com

Accessories
Appropriate marking systems:
WMB/WMB Inline/WFB

End and intermediate plate; 1.5 mm thick		
orange	780-317	100 (25)



Busbar carrier; not suitable as an end stop; snaps onto DIN-35 rail; 1.5 mm thick		
blue	780-321	100 (25)



Busbar carrier; with end stop function and detachable separator plate; snaps onto DIN-35 rail; 8 mm thick		
blue	777-305	25



Busbar; tin-plated; 1000 mm long; copper (10 x 3) mm		
I _N 140 A	210-133	1



Busbar cover; 1000 mm long		
transparent	777-303	1



Connector; for busbar; with blue cover; 2.5 ... 16 mm ²		
blue	210-281	100 (50)



Connector; for busbar; 2.5 ... 35 mm ²		
unplated	209-105	50



Lock-out; prevents reclosing of slide link; snap-on type		
orange	777-300	100 (25)



Step-down test plug; from 4 mm socket to 2 mm plug; max. 42 V		
red	210-297	100 (25)



Test plug; with 500 mm cable; 2.3 mm Ø; max. 42 V		
yellow	210-137	50



Operating tool; specialty blade; for all TOPJOB® terminal blocks		
	777-310	1



Screwless end stop; for DIN-35 rail; 6 mm wide		
gray	249-116	100 (25)



N-Disconnect Terminal Block and Power Distribution Disconnect Terminal Block

TOPJOB® Classic

6 mm²; 782 Series and 10 (16) mm²; 784 Series and 16 mm²; 783 Series and 35 mm²; 785 Series

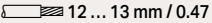
Technical Data	
0.2 ... 6 mm ²	24 ... 10 AWG
400 V/6 kV/3 ②	600 V, 30 A ③
I _N 41 A	
Terminal block width: 8 mm / 0.315 inch	
 12 ... 13 mm / 0.47 ... 0.51 inch	

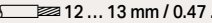
Technical Data	
0.2 ... 10 (16) mm ² ①	24 ... 6 AWG
400 V/6 kV/3 ②	
I _N 57 A	
Terminal block width: 10 mm / 0.394 inch	
 12 ... 13 mm / 0.47 ... 0.51 inch	

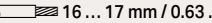
Technical Data	
0.2 ... 16 mm ²	24 ... 6 AWG
400 V/6 kV/3 ②	600 V, 65 A ③
I _N 68 A	
Terminal block width: 12 mm / 0.472 inch	
 16 ... 17 mm / 0.63 ... 0.67 inch	

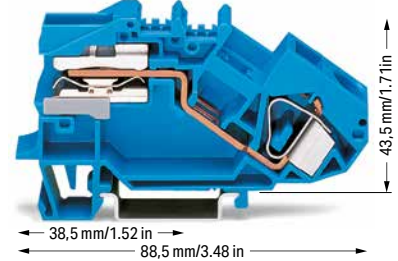
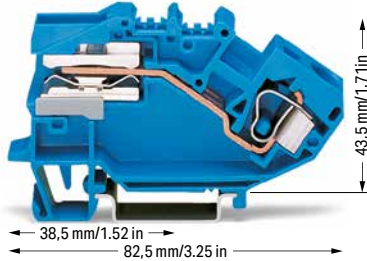
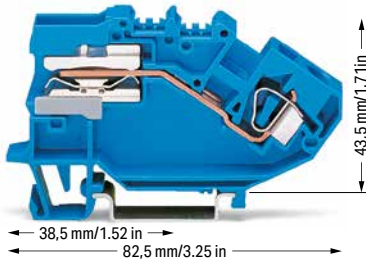



1-conductor N-disconnect terminal block		
Color	Item No.	Pack. Unit
 blue	782-613	25

1-conductor N-disconnect terminal block		
Color	Item No.	Pack. Unit
 blue	784-613	25

1-conductor N-disconnect terminal block		
Color	Item No.	Pack. Unit
 blue	783-613	25

1-conductor power distribution disconnect terminal block		
Color	Item No.	Pack. Unit
 gray	782-623	25

1-conductor power distribution disconnect terminal block		
Color	Item No.	Pack. Unit
 gray	784-623	25

1-conductor power distribution disconnect terminal block		
Color	Item No.	Pack. Unit
 gray	783-623	25

Other terminal blocks with the same profile:		
Through	Item No.	Page
Through	782-601	Page 269

Other terminal blocks with the same profile:		
Through	Item No.	Page
Through	784-601	Page 269

Other terminal blocks with the same profile:		
Through	Item No.	Page
Through	783-601	Page 270

Accessories; item-specific			
Busbar carrier; not suitable as an end stop; snaps onto DIN-35 rail; 1.5 mm thick			
Color	Item No.	Pack. Unit	Image
blue	782-321	100 (25)	

Accessories; item-specific			
Busbar carrier; not suitable as an end stop; snaps onto DIN-35 rail; 1.5 mm thick			
Color	Item No.	Pack. Unit	Image
blue	782-321	100 (25)	

Accessories; item-specific			
Busbar carrier; not suitable as an end stop; snaps onto DIN-35 rail; 1.5 mm thick			
Color	Item No.	Pack. Unit	Image
blue	783-321	100 (25)	

Accessories

Busbar carrier; with end stop function and detachable separator plate; snaps onto DIN-35 rail; 8 mm thick			
Color	Item No.	Pack. Unit	Image
blue	777-305	25	

Step-down test plug; from 4 mm socket to 2 mm plug; max. 42 V			
Color	Item No.	Pack. Unit	Image
red	210-297	100 (25)	

Operating tool; specialty blade; for all TOPJOB® terminal blocks			
Color	Item No.	Pack. Unit	Image
orange	777-310	1	

Busbar; tin-plated; 1000 mm long; copper (10 x 3) mm			
I _N	Item No.	Pack. Unit	Image
140 A	210-133	1	

Test plug; with 500 mm cable; 2.3 mm Ø; max. 42 V			
Color	Item No.	Pack. Unit	Image
yellow	210-137	50	

Screwless end stop; for DIN-35 rail; 6 mm wide			
Color	Item No.	Pack. Unit	Image
gray	249-116	100 (25)	

Busbar cover; 1000 mm long			
Color	Item No.	Pack. Unit	Image
transparent	777-303	1	

WMB marking card; white; 10 strips with 10 markers/card; for 5 ... 17.5 mm terminal block width			
Color	Item No.	Pack. Unit	Image
plain	793-501	5	

Connector; for busbar; with blue cover; 2.5 ... 16 mm ²			
Color	Item No.	Pack. Unit	Image
blue	210-281	100 (50)	

WMB marking card; white; 10 strips with 10 markers/card; stretchable 5 ... 5.2 mm			
Color	Item No.	Pack. Unit	Image
plain	793-5501	5	

Connector; for busbar; 2.5 ... 35 mm ²			
Color	Item No.	Pack. Unit	Image
unplated	209-105	50	

WFB continuous marking strip; 1000 mm long			
Color	Item No.	Pack. Unit	Image
transparent	210-612	10	

Lock-out; prevents reclosing of slide link; snap-on type			
Color	Item No.	Pack. Unit	Image
orange	782-300	100 (25)	

Carrier for WFB continuous marking strip; snaps into marker slot			
Color	Item No.	Pack. Unit	Image
gray	209-185	200 (25)	

Technical Data

6 ... 35 mm² | 8 ... 2 AWG

400 V/6 kV/3 ②

I_N 125 A | 600 V, 125 A[Ⓢ]

Terminal block width: 16 mm / 0.63 inch

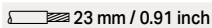
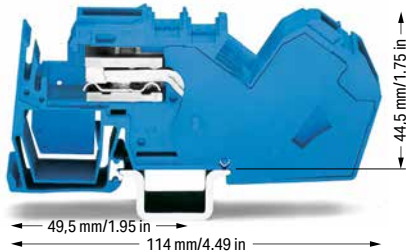
 23 mm / 0.91 inch

1-conductor N-disconnect terminal block

Color	Item No.	Pack. Unit
● blue	785-613	15

1-conductor power distribution disconnect terminal block

○ gray	785-623	15
--------	---------	----

Other terminal blocks with the same profile:

Through	783-601	Page 270
---------	---------	----------

Accessories; item-specific

Busbar carrier; not suitable as an end stop; snaps onto DIN-35 rail; 1.5 mm thick

blue	783-321	100 (25)
------	---------	----------

① Max. conductor cross section: 16 mm²② 400 V = rated voltage
6 kV = rated impulse voltage
3 = pollution degree
(see Section 14)

③ See column 5 (bottom)

④ See column 6 (bottom)

Approvals and corresponding ratings,
visit www.wago.com

The 35 mm² (2 AWG) terminal blocks are the latest addition to WAGO TOPJOB®, the professional range of rail-mount terminal blocks for building installations. These terminal blocks, which include an end plate, are just 16 mm wide. Their compact design allows them to fit into standard distribution boxes. The lower conductor entry angle makes it much easier to terminate 35 mm² (2 AWG) conductors.

Furthermore, the N-busbar holder is integrated into the terminal block, eliminating separate holders.

5

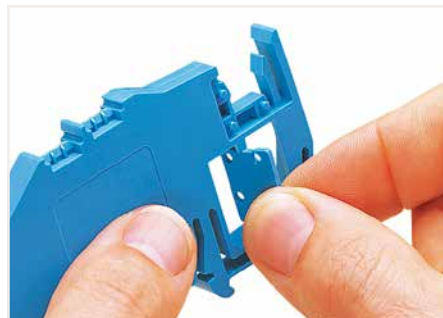

Removing the separator plate from the busbar carrier or from the N-disconnect terminal block.

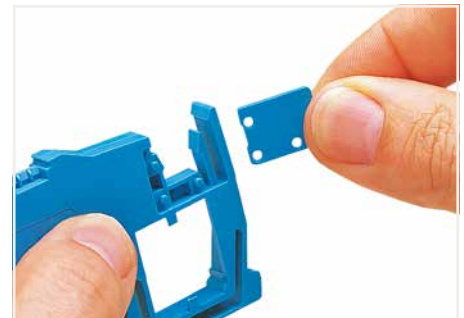

Inserting the separator plate into the busbar carrier to protect the N-busbar against accidental contact.

N-conductor disconnect terminal blocks:

For the construction and operation of power installations in fire-prone, hazardous locations or public buildings – such as conference centers, stores, hospitals, schools, theaters or hotels – the DIN VDE 0100-710 or DIN VDE 0100-718 standards shall be observed. DIN VDE 0100-482 shall also be observed for fire-prone, hazardous locations. These VDE regulations mandate that every neutral conductor must be provided with a disconnection device so, e.g., insulation testing is possible for every circuit without disconnecting the N-conductor. WAGO's N-disconnect terminal blocks meet this requirement.

Power distribution disconnect terminal blocks:

According to DIN VDE 0100-710, "Requirements for operating facilities, rooms and special installations – medical facilities," equipotential bonding conductors shall be run on a potential equalization busbar. The potential equalization busbar and the protective ground conductor busbar must be mounted in a common housing and be connected to each other using a disconnectable copper conductor of minimum 16 mm² (6 AWG). Furthermore, all equipotential bonding conductors must be connected to the potential equalization busbar and clearly arranged so they can be disconnected individually and accessed at any time. Depending on their function, they must be provided with captive marking. WAGO's power distribution disconnect terminal blocks meet these requirements.

Disconnect/Test Terminal Blocks; with a Pivoting Knife Disconnect

280 Series

Description and Installation

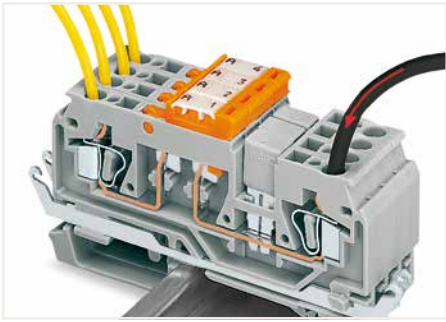

Power distribution using an adjacent jumper – knife disconnect used to disconnect individual outputs.



Pivoting a knife disconnect.

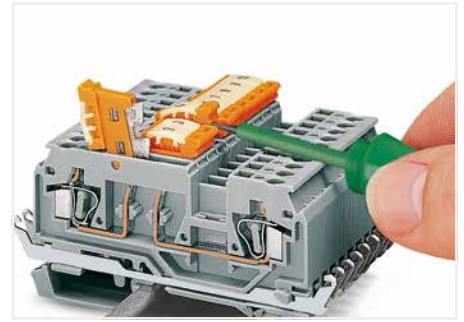

Pivoting knife disconnect clearly indicates circuit state by defined, notched positions "ON" ↔ "OFF."

5

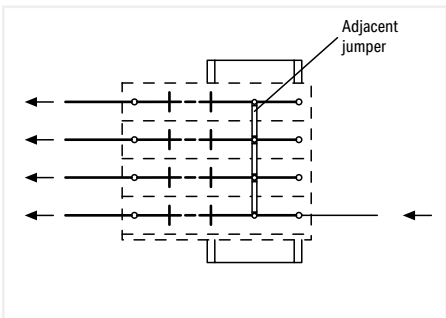
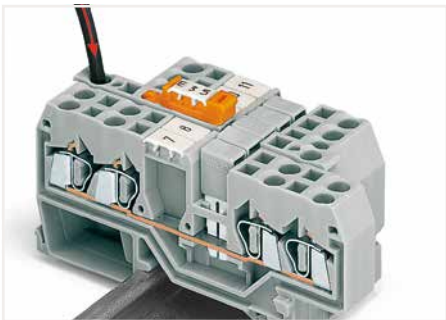

Diagram of the assembly as shown in the picture above



Power distribution using disconnect link in supply line – disconnection of all outputs.

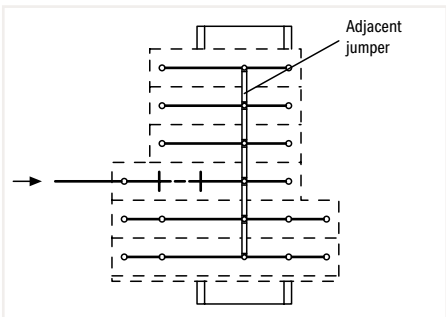
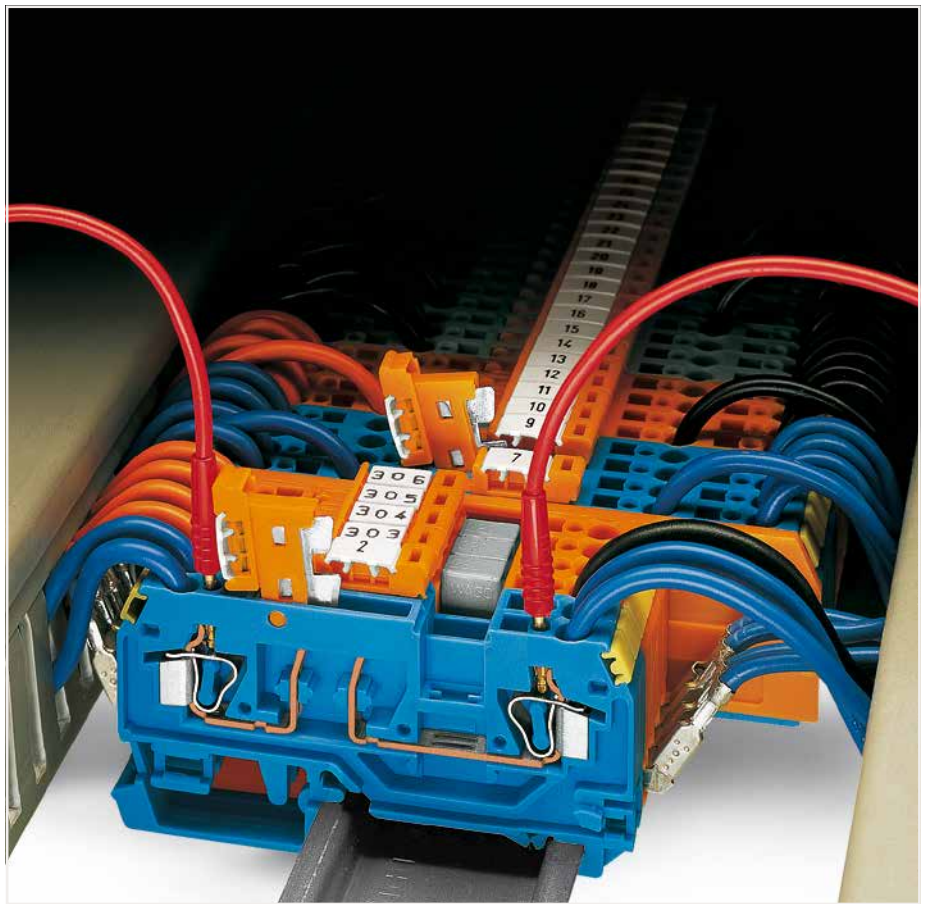
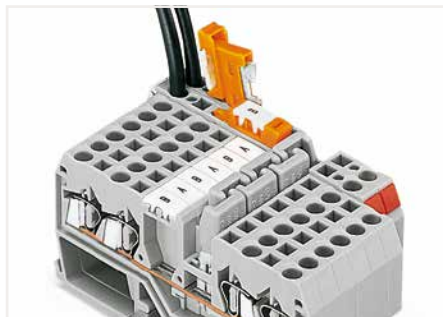

Diagram of the assembly as shown in the picture above



Staggered jumpers for sophisticated circuit requirements – push jumpers down until fully inserted.

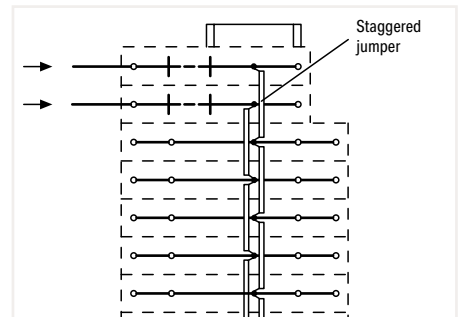

Diagram of the assembly as shown in the picture on the left



CAGE CLAMP® terminates the following copper conductors: solid



stranded



fine-stranded, also with tinned single strands

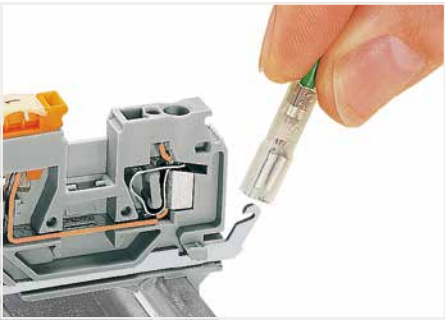

Shield contact via (2.5 x 0.8) mm solder/crimp quick disconnect terminal



Testing with voltage tester.



Terminal block marking: with WMB (center position) and Mini-WSB markers (on the sides)

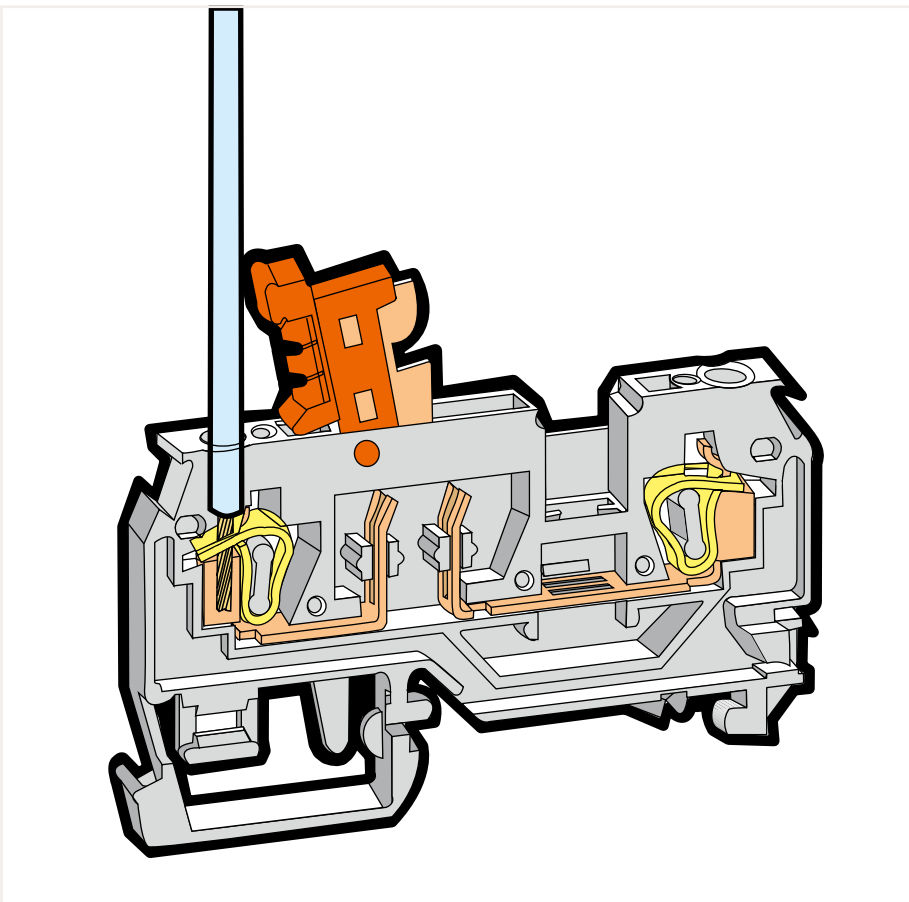

5



fine-stranded, tip-bonded



fine-stranded, with ferrule (gastight crimped)



fine-stranded, with pin terminal (gastight crimped)

2-Conductor Disconnect/Test Terminal Block without/with Shield Contact 2.5 mm²; 280 Series

Technical Data

0.08 ... 2.5 mm ²	28 ... 12 AWG*
400 V/6 kV/3 ①	600 V, 15 A ②
I _N 16 A	300 V, 15 A ③
Terminal block width: 5 mm / 0.197 inch	
8 ... 9 mm / 0.31 ... 0.35 inch	

Technical Data

0.08 ... 2.5 mm ²	28 ... 12 AWG*
250 V/4 kV/3 ①	600 V, 15 A ②
I _N 16 A	300 V, 15 A ③
Terminal block width: 5 mm / 0.197 inch	
8 ... 9 mm / 0.31 ... 0.35 inch	

*12 AWG: THHN, THWN

- ① 400 V / 250 V = rated voltage
6 kV / 4 kV = rated impulse voltage
3 = pollution degree (see Section 14)

- ② Terminal blocks with a blue insulated housing are suitable for Ex i applications.

Please observe the application notes:
Insulation stop, page 346
Jumpers, from page 348
Comb-style jumper bar, page 347
Testing accessories, from page 342
Marking, from page 588

Approvals and corresponding ratings, visit www.wago.com

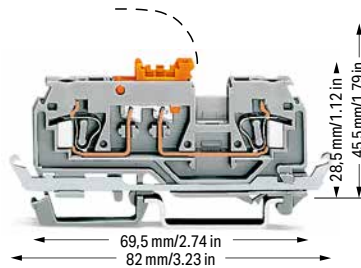
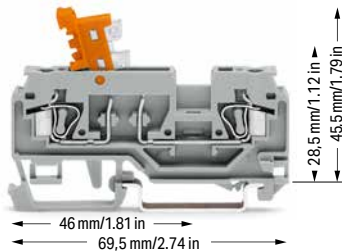

2-conductor disconnect/test terminal block; with test slots for 2 and 2.3 mm Ø test plugs; with pivoting knife disconnect
Gray terminal block housing
Orange disconnect link

Color	Item No.	Pack. Unit
gray	280-870	100

Gray terminal block housing Gray disconnect link	gray	280-868	100
---	------	---------	-----

Blue terminal block housing Orange disconnect link	blue	280-876 ②	100
---	------	-----------	-----

Orange terminal block housing Orange disconnect link	orange	280-879	100
---	--------	---------	-----

2-conductor disconnect/test terminal block; with test slots for 2 and 2.3 mm Ø test plugs; with pivoting knife disconnect
Gray terminal block housing
Orange disconnect link

Color	Item No.	Pack. Unit
gray	280-871	100

Gray terminal block housing Gray disconnect link	gray	280-869	100
---	------	---------	-----

Orange terminal block housing Orange disconnect link	blue	280-880	100
---	------	---------	-----

Accessories; 280 Series

Appropriate marking systems: WMB/WMB Inline/WFB

End and intermediate plate; 2.5 mm thick	orange	280-371	100 (25)
	gray	280-374	100 (25)

Insulation stop; 0.08 ... 0.2 mm ² "s" (0.14 mm ² "f-st"); 5 pcs/strip	white	280-470	200 (25)
--	-------	---------	----------

Insulation stop; 0.25 ... 0.5 mm ² ; 5 pcs/strip	light gray	280-471	200 (25)
---	------------	---------	----------

Insulation stop; 0.75 ... 1 mm ² ; 5 pcs/strip	dark gray	280-472	200 (25)
---	-----------	---------	----------

Protective warning marker; with black high-voltage symbol; for 5 terminal blocks	yellow	280-415	100 (25)
--	--------	---------	----------

Adjacent jumper; insulated; I _N = I _N terminal block	gray	280-402	200 (25)
	yellow-green	280-422	200 (25)

Alternate jumper; insulated; I _N = I _N terminal block	gray	280-409	100 (25)
---	------	---------	----------

Staggered jumper; insulated; 5 mm wide; I_N 24 A

1 to 2	780-452	100 (25)
1 to 3	780-453	100 (25)
1 to 4	780-454	100 (25)
1 to 5	780-455	50 (25)
1 to 6	780-456	50 (25)
1 to 7	780-457	50 (25)
1 to 8	780-458	50 (25)

Push-in type wire jumper; insulated; 0.75 mm² conductor cross section; I_N 9 A

L = 60 mm	249-125	100 (10)
L = 110 mm	249-126	100 (10)
L = 250 mm	249-127	100 (10)

Comb-style jumper bar; insulated; I _N = I _N of terminal block	2-way	280-482	200 (25)
	3-way	280-483	200 (25)

Comb-style jumper bar; insulated; I_N = I_N of terminal block

10-way	280-490	50 (25)
--------	---------	---------

Alternate comb-style jumper bar; insulated; I_N = I_N of terminal block

2-way	280-492	200 (25)
-------	---------	----------

Accessories; 280 Series

Appropriate marking systems:
WMB/WMB Inline/WFB

Operating tool; insulated	2-way	280-432	1
	3-way	280-433	1

Operating tool; insulated	10-way	280-440	1
---------------------------	--------	---------	---

Test plug module; snaps together; 5 mm wide	gray	280-418	100 (25)
---	------	---------	----------

Spacer module; snaps together; 5 mm wide	gray	280-419	100 (25)
--	------	---------	----------

Test plug adapter; 8.3 mm wide; for 4 mm Ø test plug; for 1.5 ... 10 mm ² terminal blocks	gray	209-170	50 (25)
--	------	---------	---------

Banana plug; for 4 mm socket diameter; color mixed; 10 x orange, white, black, blue, yellow; max. 42 V		215-111	50
--	--	---------	----

Test plug adapter; 5 mm wide; for 210-137 Test Plug (2.3 mm Ø); for 1.5 ... 4 mm ² terminal blocks	gray	280-404	100 (25)
---	------	---------	----------

Test plug; with 500 mm cable; 2 mm Ø; max. 42 V	red	210-136	50
---	-----	---------	----

Test plug; with 500 mm cable; 2.3 mm Ø; max. 42 V	yellow	210-137	50
---	--------	---------	----

WMB marking card; white; 10 strips with 10 markers/card; stretchable 5 ... 5.2 mm	plain	793-5501	5
---	-------	----------	---

Mini-WSB marking card; white; 10 strips with 10 markers/card; 5 mm wide markers	plain	248-501	5
---	-------	---------	---

5

4-Conductor Disconnect/Test Terminal Block without/with Shield Contact

2.5 mm²; 280 Series

Technical Data	
0.08 ... 2.5 mm ²	28 ... 12 AWG*
400 V/6 kV/3 ①	600 V, 15 A ②
I _N 16 A	300 V, 15 A ③
Terminal block width: 5 mm / 0.197 inch	
8 ... 9 mm / 0.31 ... 0.35 inch	

Technical Data	
0.08 ... 2.5 mm ²	28 ... 12 AWG*
250 V/4 kV/3 ①	600 V, 15 A ②
I _N 16 A	300 V, 15 A ③
Terminal block width: 5 mm / 0.197 inch	
8 ... 9 mm / 0.31 ... 0.35 inch	

- *12 AWG: THHN, THWN
- 400 V / 250 V = rated voltage
6 kV / 4 kV = rated impulse voltage
3 = pollution degree (see Section 14)
 - Terminal blocks with a blue insulated housing are suitable for Ex i applications.
- Please observe the application notes:
Insulation stop, page 346
Comb-style jumper bar, page 347
Marking, from page 588
- Approvals and corresponding ratings, visit www.wago.com

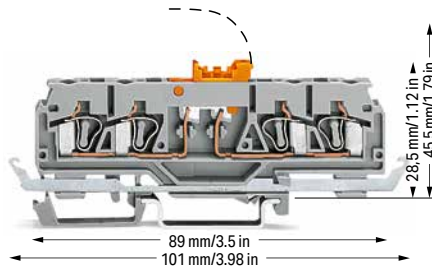
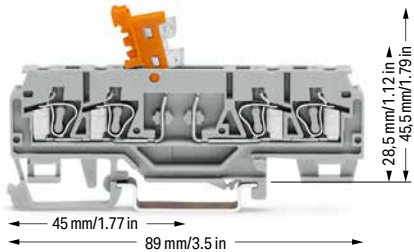

4-conductor disconnect/test terminal block; with test slots for 2 and 2.3 mm Ø test plugs; with pivoting knife disconnect		
Gray terminal block housing		
Orange disconnect link		
Color	Item No.	Pack. Unit
○ gray	280-874	100

4-conductor disconnect/test terminal block; with test slots for 2 and 2.3 mm Ø test plugs; with pivoting knife disconnect		
Gray terminal block housing		
Orange disconnect link		
Color	Item No.	Pack. Unit
○ gray	280-875	100

Gray terminal block housing		
Gray disconnect link		
Color	Item No.	Pack. Unit
○ gray	280-881	100

Gray terminal block housing		
Gray disconnect link		
Color	Item No.	Pack. Unit
○ gray	280-882	100

Blue terminal block housing		
Orange disconnect link		
Color	Item No.	Pack. Unit
● blue	280-885 ②	100

Orange terminal block housing		
Orange disconnect link		
Color	Item No.	Pack. Unit
● blue	280-884	100

Orange terminal block housing		
Orange disconnect link		
Color	Item No.	Pack. Unit
● orange	280-883	100

Accessories; 280 Series

Appropriate marking systems: WMB/WMB Inline/WFB

End and intermediate plate; 2.5 mm thick			
orange	280-373	100 (25)	
gray	280-376	100 (25)	

Alternate comb-style jumper bar; insulated; I _N = I _N of terminal block			
	2-way	280-492	200 (25)

Insulation stop; 0.08 ... 0.2 mm ² "s" (0.14 mm ² "f-st"); 5 pcs/strip			
white	280-470	200 (25)	

Operating tool; insulated			
	2-way	280-432	1
	3-way	280-433	1

Insulation stop; 0.25 ... 0.5 mm ² ; 5 pcs/strip			
light gray	280-471	200 (25)	

Operating tool; insulated			
	10-way	280-440	1

Insulation stop; 0.75 ... 1 mm ² ; 5 pcs/strip			
dark gray	280-472	200 (25)	

Test plug; with 500 mm cable; 2 mm Ø; max. 42 V			
red	210-136	50	

Protective warning marker; with black high-voltage symbol; for 5 terminal blocks			
yellow	280-415	100 (25)	

Test plug; with 500 mm cable; 2.3 mm Ø; max. 42 V			
yellow	210-137	50	

Comb-style jumper bar; insulated; I _N = I _N of terminal block			
	2-way	280-482	200 (25)
	3-way	280-483	200 (25)

Screwless end stop; for DIN-35 rail; 6 mm wide			
gray	249-116	100 (25)	

Comb-style jumper bar; insulated; I _N = I _N of terminal block			
	10-way	280-490	50 (25)

5

Disconnect/Test Terminal Block; with Disconnect Tab

2.5 mm²; 280 Series

Technical Data	
0.08 ... 2.5 mm ²	28 ... 12 AWG*
400 V/6 kV/3 ①	300 V, 15 A ②
I _N 10 A	300 V, 15 A ③
Terminal block width: 5 mm / 0.197 inch	
8 ... 9 mm / 0.31 ... 0.35 inch	

Technical Data	
0.08 ... 2.5 mm ²	28 ... 12 AWG*
400 V/6 kV/3 ①	300 V, 15 A ②
I _N 10 A	600 V, 15 A ③
Terminal block width: 5 mm / 0.197 inch	
8 ... 9 mm / 0.31 ... 0.35 inch	

Technical Data	
0.08 ... 2.5 mm ²	28 ... 12 AWG*
400 V/6 kV/3 ①	300 V, 15 A ②
I _N 10 A	600 V, 15 A ③
Terminal block width: 5 mm / 0.197 inch	
8 ... 9 mm / 0.31 ... 0.35 inch	

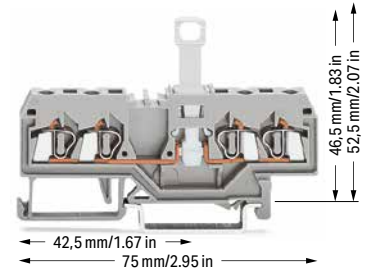
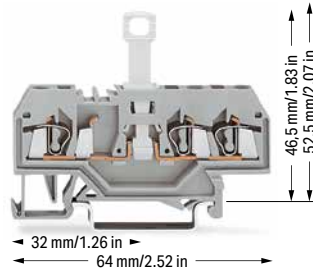
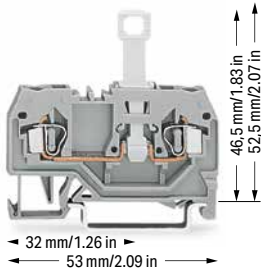

2-conductor disconnect terminal block; with disconnect tab

Color	Item No.	Pack. Unit
○ gray	280-912	50
● blue	280-914	50
● orange	280-913	50

3-conductor disconnect terminal block; with disconnect tab

Color	Item No.	Pack. Unit
○ gray	280-683	50

4-conductor disconnect terminal block; with disconnect tab

Color	Item No.	Pack. Unit
○ gray	280-836	50
● blue	280-839	50
● orange	280-805	50

Other terminal blocks with the same profile:

Through	280-901	Page 236
---------	---------	----------

Other terminal blocks with the same profile:

Through	280-681	Page 236
---------	---------	----------

Other terminal blocks with the same profile:

Through	280-833	Page 236
---------	---------	----------

Accessories; item-specific

End and intermediate plate; 2.5 mm thick

orange	280-309	100 (25)
gray	280-308	100 (25)
light gray	280-356	100 (25)

Separator; oversized; 2 mm thick

orange	280-311	100 (25)
gray	280-310	100 (25)
light gray	280-357	100 (25)

Accessories; item-specific

End and intermediate plate; 2.5 mm thick

orange	280-326	100 (25)
gray	280-324	100 (25)
light gray	280-358	100 (25)

Separator; oversized; 2 mm thick

orange	280-346	100 (25)
gray	280-344	100 (25)
light gray	280-359	100 (25)

Accessories; item-specific

End and intermediate plate; 2.5 mm thick

orange	280-315	100 (25)
gray	280-314	100 (25)
light gray	280-352	100 (25)

Separator; oversized; 2 mm thick

orange	280-335	100 (25)
gray	280-334	100 (25)
light gray	280-353	100 (25)

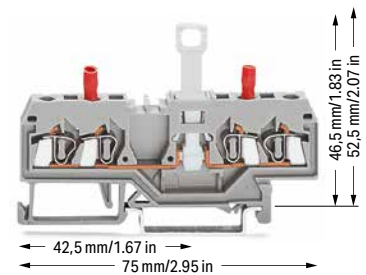

2-conductor disconnect/test terminal block; with disconnect tab; with integrated test sockets

Color	Item No.	Pack. Unit
○ gray	280-829	50

Accessories; item-specific

End and intermediate plate; 2.5 mm thick

orange	280-315	100 (25)
gray	280-314	100 (25)
light gray	280-352	100 (25)

Separator; oversized; 2 mm thick

orange	280-335	100 (25)
gray	280-334	100 (25)
light gray	280-353	100 (25)

*12 AWG: THHN, THWN

- ① 400 V = rated voltage
6 kV = rated impulse voltage
3 = pollution degree
(see Section 14)

Please observe the application notes:
Insulation stop, page 346
Comb-style jumper bar, page 347
Marking, from page 588

Approvals and corresponding ratings,
visit www.wago.com

Accessories; 280 Series

Appropriate marking systems:
WMB/WMB Inline/WFB

Insulation stop; 0.08 ... 0.2 mm² "s" (0.14 mm² "f-st"); 5 pcs/strip

	white	280-470	200 (25)
---	-------	---------	----------

Insulation stop; 0.25 ... 0.5 mm²; 5 pcs/strip

	light gray	280-471	200 (25)
---	------------	---------	----------

Insulation stop; 0.75 ... 1 mm²; 5 pcs/strip

	dark gray	280-472	200 (25)
--	-----------	---------	----------

Protective warning marker; with black high-voltage symbol; for 5 terminal blocks

	yellow	280-415	100 (25)
---	--------	---------	----------

Comb-style jumper bar; insulated; I_N = I_N of terminal block

	2-way	280-482	200 (25)
	3-way	280-483	200 (25)
	10-way	280-490	50 (25)

Alternate comb-style jumper bar; insulated; I_N = I_N of terminal block

	2-way	280-492	200 (25)
---	-------	---------	----------

Operating tool; insulated

	2-way	280-432	1
	3-way	280-433	1
	10-way	280-440	1

Disconnect lock; for disconnect tab used on disconnect terminal blocks (280/281 and 769 Series)

	red	709-170	200 (25)
---	-----	---------	----------

Test socket; insulated; 2 mm Ø

	red	209-107	
---	-----	---------	--

Test socket; insulated; 2.3 mm Ø

	yellow	209-108	100 (25)
---	--------	---------	----------

Test plug; with 500 mm cable; 2 mm Ø; max. 42 V

	red	210-136	50
---	-----	---------	----

Test plug; with 500 mm cable; 2.3 mm Ø; max. 42 V

	yellow	210-137	50
---	--------	---------	----

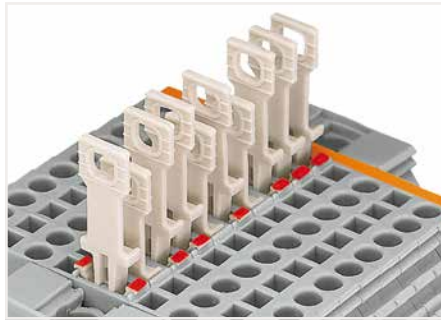

Disconnect terminal block with colored tab to indicate the switching status (red = disconnected)



Commoning front-entry disconnect terminal blocks via comb-style jumper bar using a 10-pole operating tool.

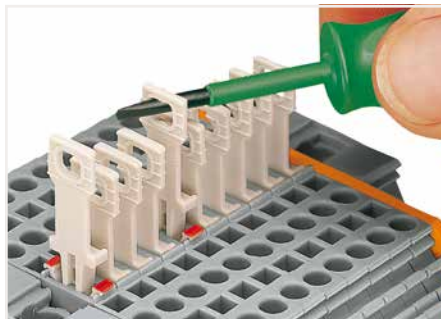

Pulling the disconnect tab via operating tool.



Pulling the disconnect tab by hand.

Disconnect/Test Terminal Block; with Disconnect Tab 4 mm²; 281 Series

Technical Data	
0.08 ... 4 mm ²	28 ... 12 AWG
400 V/6 kV/3 ①	300 V, 15 A ②
I _N 10 A	300 V, 15 A ③
Terminal block width: 6 mm / 0.236 inch	
9 ... 10 mm / 0.35 ... 0.39 inch	

Technical Data	
0.08 ... 4 mm ²	28 ... 12 AWG
400 V/6 kV/3 ①	300 V, 15 A ②
I _N 10 A	600 V, 15 A ③
Terminal block width: 6 mm / 0.236 inch	
9 ... 10 mm / 0.35 ... 0.39 inch	

Technical Data	
0.08 ... 4 mm ²	28 ... 12 AWG
400 V/6 kV/3 ①	300 V, 15 A ②
I _N 10 A	600 V, 15 A ③
Terminal block width: 6 mm / 0.236 inch	
9 ... 10 mm / 0.35 ... 0.39 inch	

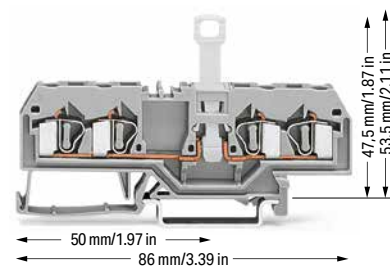
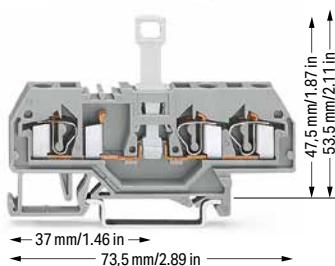
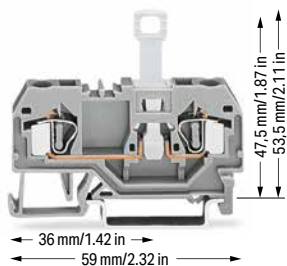

2-conductor disconnect terminal block; with disconnect tab

Color	Item No.	Pack. Unit
○ gray	281-912	50

3-conductor disconnect terminal block; with disconnect tab

Color	Item No.	Pack. Unit
○ gray	281-683	50

4-conductor disconnect terminal block; with disconnect tab

Color	Item No.	Pack. Unit
○ gray	281-659	50
● blue	281-660	50

Other terminal blocks with the same profile:

Through	Item No.	Page 242
	281-901	

Other terminal blocks with the same profile:

Through	Item No.	Page 242
	281-681	

Other terminal blocks with the same profile:

Through	Item No.	Page 242
	281-652	

Accessories; item-specific

End and intermediate plate; 2.5 mm thick

orange	281-329	100 (25)
gray	281-328	100 (25)
light gray	281-349	100 (25)

Accessories; item-specific

End and intermediate plate; 2.5 mm thick

orange	281-326	100 (25)
gray	281-324	100 (25)
light gray	281-355	100 (25)

Accessories; item-specific

End and intermediate plate; 2.5 mm thick

orange	281-335	100 (25)
gray	281-334	100 (25)
light gray	281-345	100 (25)

Separator; oversized; 2 mm thick

orange	281-331	100 (25)
gray	281-330	100 (25)
light gray	281-350	100 (25)

Separator; oversized; 2 mm thick

orange	281-346	100 (25)
gray	281-344	100 (25)
light gray	281-356	100 (25)

Separator; oversized; 2 mm thick

orange	281-339	100 (25)
gray	281-338	100 (25)
light gray	281-347	100 (25)

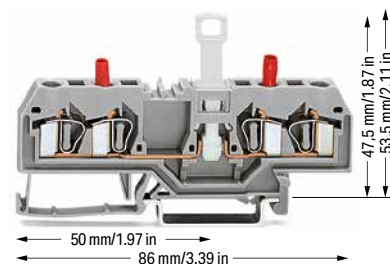

2-conductor disconnect/test terminal block; with disconnect tab; with integrated test sockets

Color	Item No.	Pack. Unit
○ gray	281-666	50

Accessories; item-specific

End and intermediate plate; 2.5 mm thick

orange	281-335	100 (25)
gray	281-334	100 (25)
light gray	281-345	100 (25)

Separator; oversized; 2 mm thick

orange	281-339	100 (25)
gray	281-338	100 (25)
light gray	281-347	100 (25)

① 400 V = rated voltage
6 kV = rated impulse voltage
3 = pollution degree
(see Section 14)

Please observe the application notes:
Insulation stop, page 346
Comb-style jumper bar, page 347
Marking, from page 588

Approvals and corresponding ratings,
visit www.wago.com

Accessories; 281 Series

Appropriate marking systems:
WMB/WMB Inline/WFB

Insulation stop; 0.08 ... 0.2 mm² "s" (0.14 mm² "f-st"); 5 pcs/strip

	white	281-470	200 (25)
---	-------	---------	----------

Insulation stop; 0.25 ... 0.5 mm²; 5 pcs/strip

	light gray	281-471	200 (25)
---	------------	---------	----------

Insulation stop; 0.75 ... 1.5 mm²; 5 pcs/strip

	dark gray	281-472	200 (25)
---	-----------	---------	----------

Protective warning marker; with black high-voltage symbol; for 5 terminal blocks

	yellow	281-415	100 (25)
---	--------	---------	----------

Comb-style jumper bar; insulated; I_N = I_N of terminal block

	2-way	281-482	100 (25)
	3-way	281-483	100 (25)
	5-way	281-485	100 (25)
	10-way	281-490	50 (25)

Alternate comb-style jumper bar; insulated; I_N = I_N of terminal block

	2-way	281-492	100 (25)
---	-------	---------	----------

Operating tool; insulated

	2-way	280-432	1
	3-way	280-433	1
	10-way	281-440	1

Disconnect lock; for disconnect tab used on disconnect terminal blocks (280/281 and 769 Series)

	red	709-170	200 (25)
---	-----	---------	----------

Test socket; insulated; 2 mm Ø

	red	209-107	
---	-----	---------	--

Test socket; insulated; 2.3 mm Ø

	yellow	209-108	100 (25)
---	--------	---------	----------

Test plug; with 500 mm cable; 2 mm Ø; max. 42 V

	red	210-136	50
---	-----	---------	----

Test plug; with 500 mm cable; 2.3 mm Ø; max. 42 V

	yellow	210-137	50
---	--------	---------	----

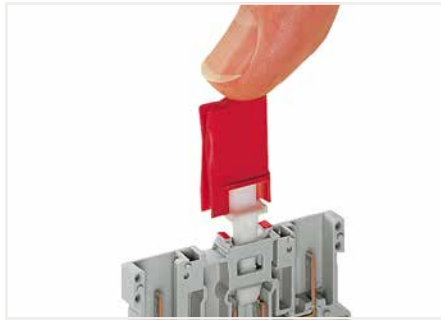

Installing a disconnect lock on the terminal block's disconnect tab (picture shows a 2-pin disconnect carrier terminal block, 769 Series).



Unlocking a disconnect lock.



Removing a disconnect lock.

5



Double Safety:
The disconnect tab has been designed for maximum operational safety.

As soon as the disconnect tab is in the disconnect position, it can be protected against unintentional reconnection by using the disconnect lock. Only through intentional and focused use of a tool, can the disconnect lock be removed and the circuit reconnected.

- Features/Benefits:**
- Easy to use
 - Install/remove disconnect lock with just one hand
 - Clearly identify disconnect tab position
 - Higher safety
 - Intentional effort is required to reconnect the circuit

Disconnect/Test Terminal Blocks; for Current and Voltage Transformer Circuits

282 Series

Description and Installation

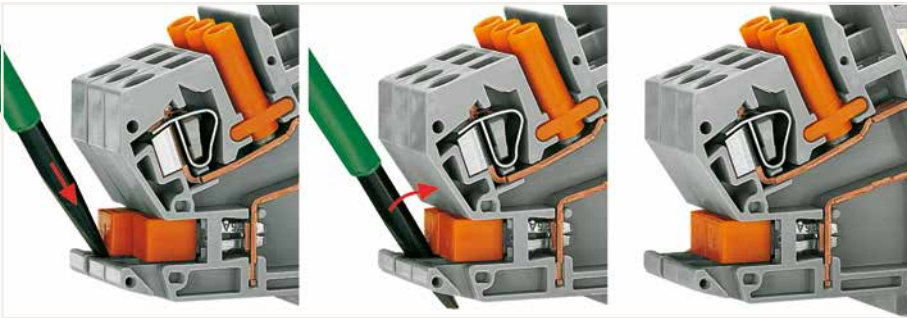

Inserting an insulated, touch-proof adjacent jumper into the protected shorting position.



Terminal strip permanently prepared for current transformer circuits.

5



Lock-out snaps into one of two notched positions, preventing accidental operation of the disconnect link.



Snapping a transparent locking cover onto 1-8 disconnect links:
 a) Mechanically lock several links for multi-pole switching applications
 b) Protect markers

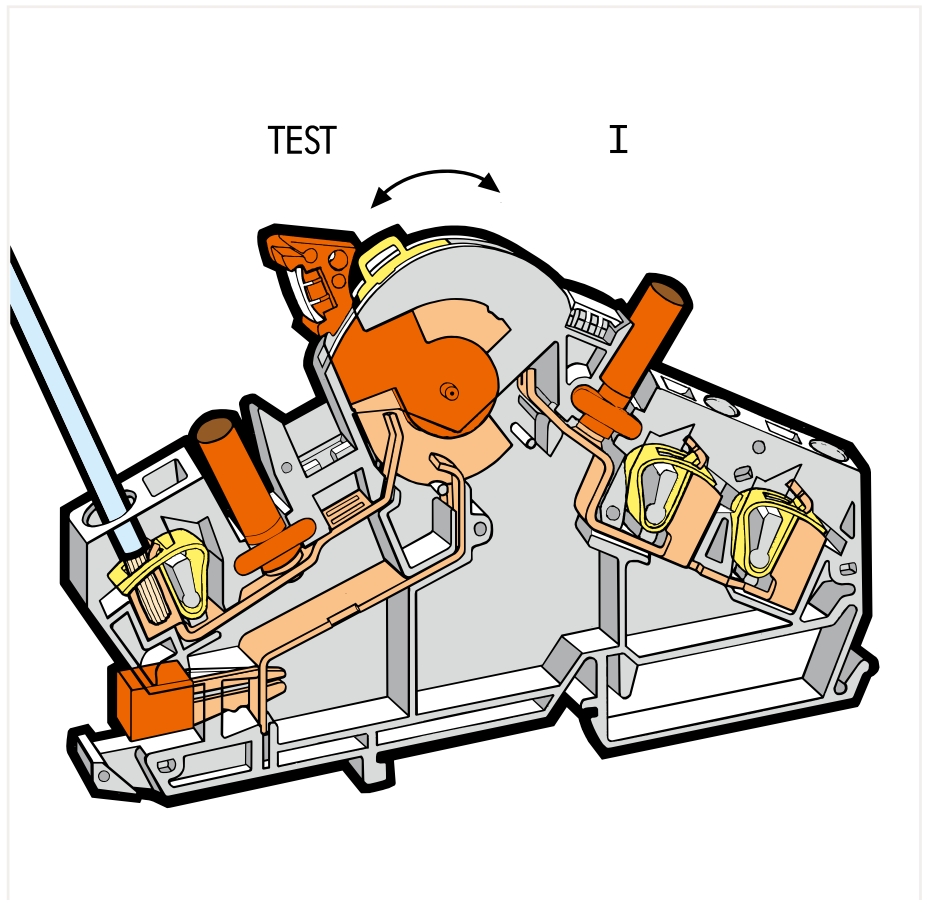

Interlocking link mechanically locks multiple links for multi-pole switching applications.



Touch-proof test sockets for touch-proof 4 mm Ø test plugs (not available from WAGO, but are offered by industry suppliers such as, Fabrikat Multi-Contact)



Labeling via WMB Multi Marking System.



CAGE CLAMP® terminates the following copper conductors:
 solid



stranded



fine-stranded, also with tinned single strands

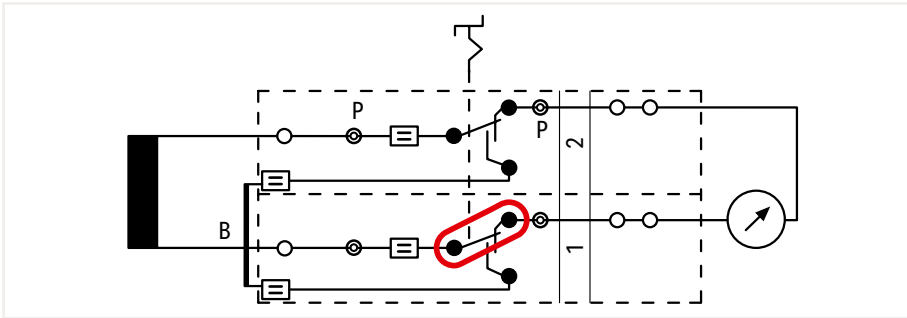

Disconnect link in notched "I" position
 In "I" operating position, the measurement device is connected to the transformer.

B = shunting jumper, P = test socket

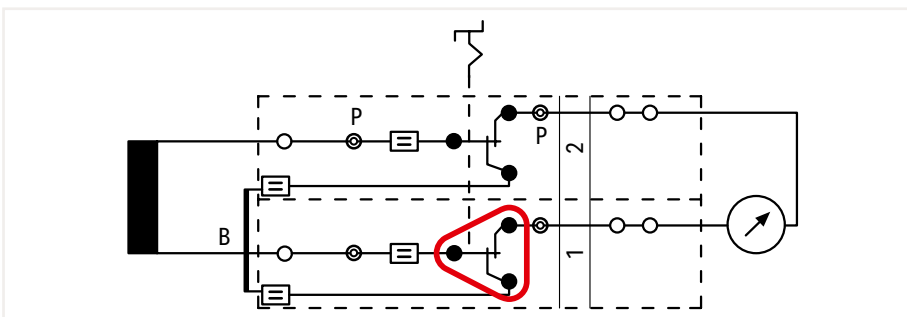
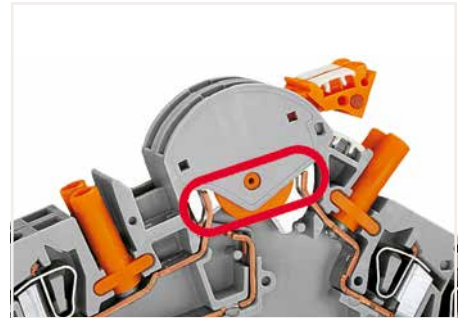

Disconnect link in transition from "I" to "TEST" (terminal blocks 1 + 2)
 The transformer is not disconnected from the measurement device, yet the shorting path is activated by moving the disconnect link from "I" to "TEST."

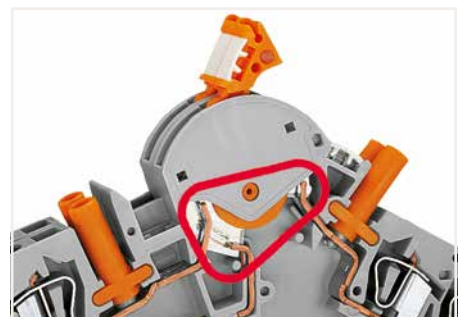

5

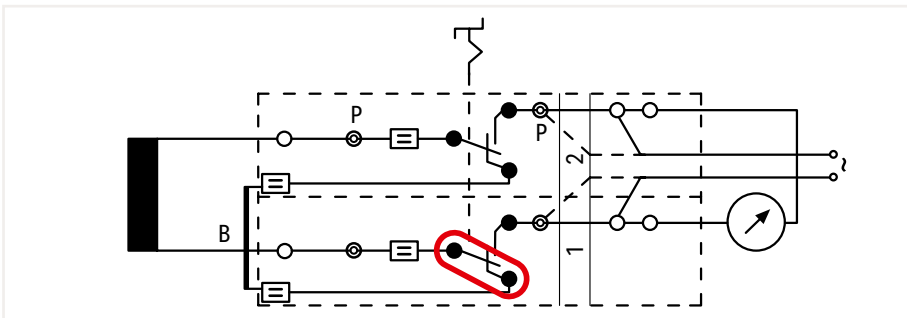

Disconnect link in notched "TEST" position (terminal blocks 1 + 2)
 The measurement device/relay is electrically disconnected from the transformer. If required, external voltage can be applied to the measurement device/relay via the test socket, or the 2nd CAGE CLAMP® connection.

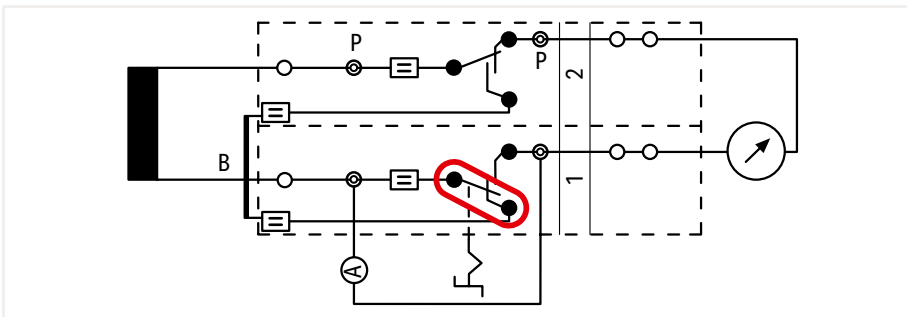
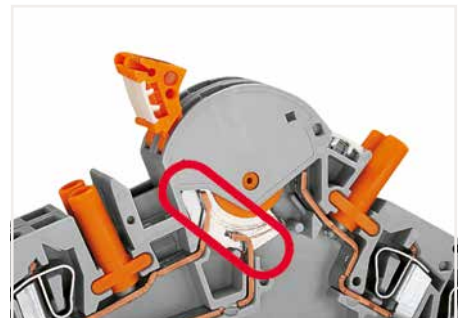

Disconnect link in notched position "I" (terminal block 2) Disconnect link in notched position "TEST" (terminal block 1) – measurement testing
 Before moving the disconnect link of terminal block 1 into the notched "TEST" position, the reference current meter must be inserted into the test socket of terminal block 1.

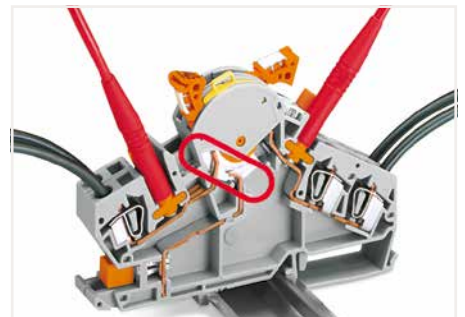

fine-stranded,
tip-bonded



fine-stranded,
with ferrule
(gastight crimped)



fine-stranded,
with pin terminal
(gastight crimped)

Circuit Configuration Examples

5

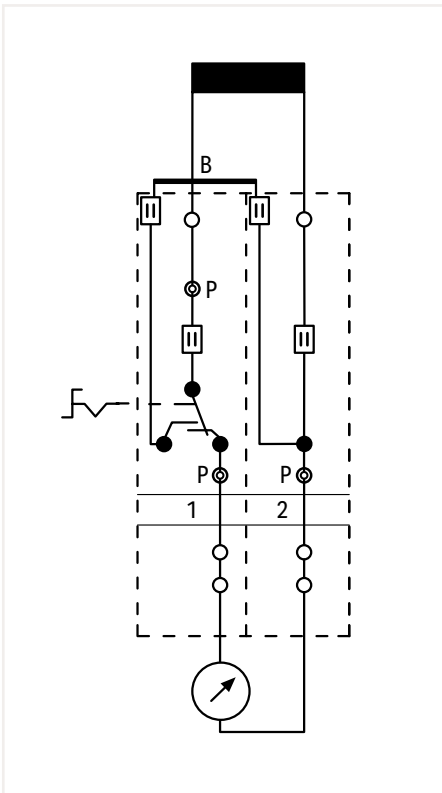

Measuring set for a single-phase current transformer (without measurement testing)



- Terminal blocks required:
- 1 x disconnect/test terminal block (282-870)
 - 1 x through terminal block (282-865)
 - 1 x jumper, orange (282-424)
 - 1 x end plate, orange (282-386)
 - In addition: locking cover, lock-out

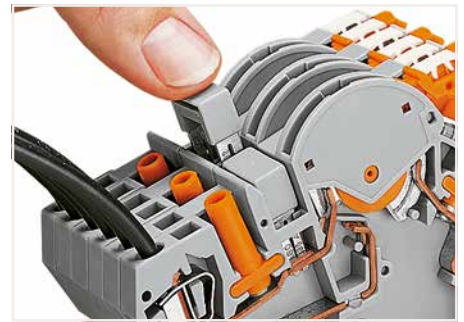

Additional commoning possible with circuit-related adjacent jumpers or testing option via test plug adapter (209-170) on transformer side.

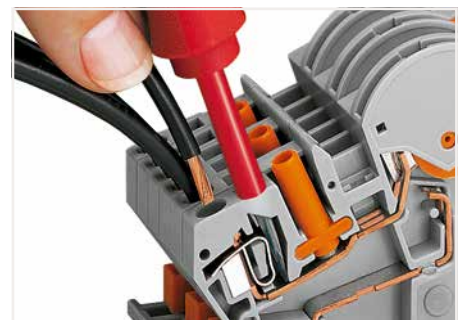

CAGE CLAMP® connection
Inserting a conductor via operating tool (5.5 x 0.8 mm blade).

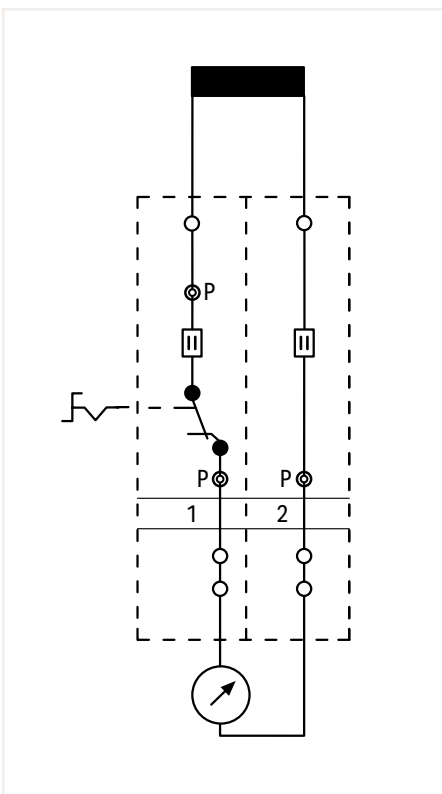

Measuring set for a single-phase voltage transformer



- Terminal blocks required:
- 1 x disconnect/test terminal block (282-860)
 - 1 x through terminal block (282-866)
 - 1 x end plate, orange (282-386)
 - In addition: locking cover, lock-out



A lock-out seal can be used on the disconnect link in notched "I" position.



Additional CAGE CLAMP® connection on the measurement device side, e.g., when connecting wire commoning chains or applying an external voltage.

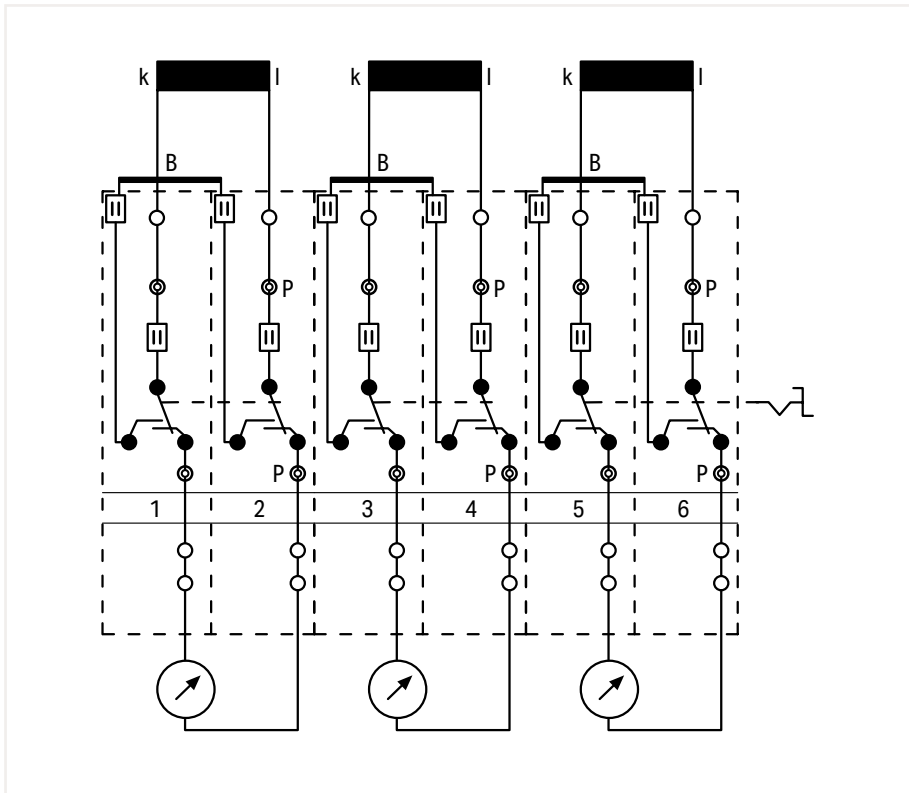

Measuring set for a three-phase current transformer
 Pairs of disconnect links are interconnected via interlocking link or locking cover.
 Measurement testing is performed after the interlocking is released.

B = shorting jumper, P = test socket

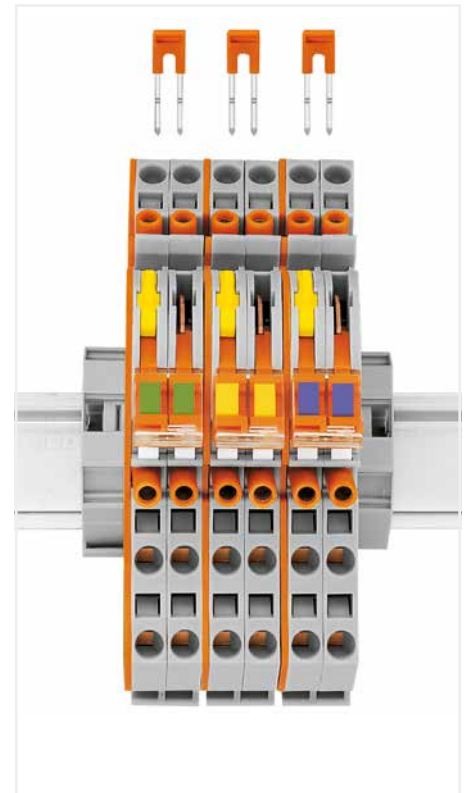

- Terminal blocks required:
- 6 x disconnect/test terminal block (282-870)
 - 3 x jumper, orange (282-424)
 - 3 x end plate, orange (282-386)
 - In addition: interlocking link, locking cover, lock-out

5

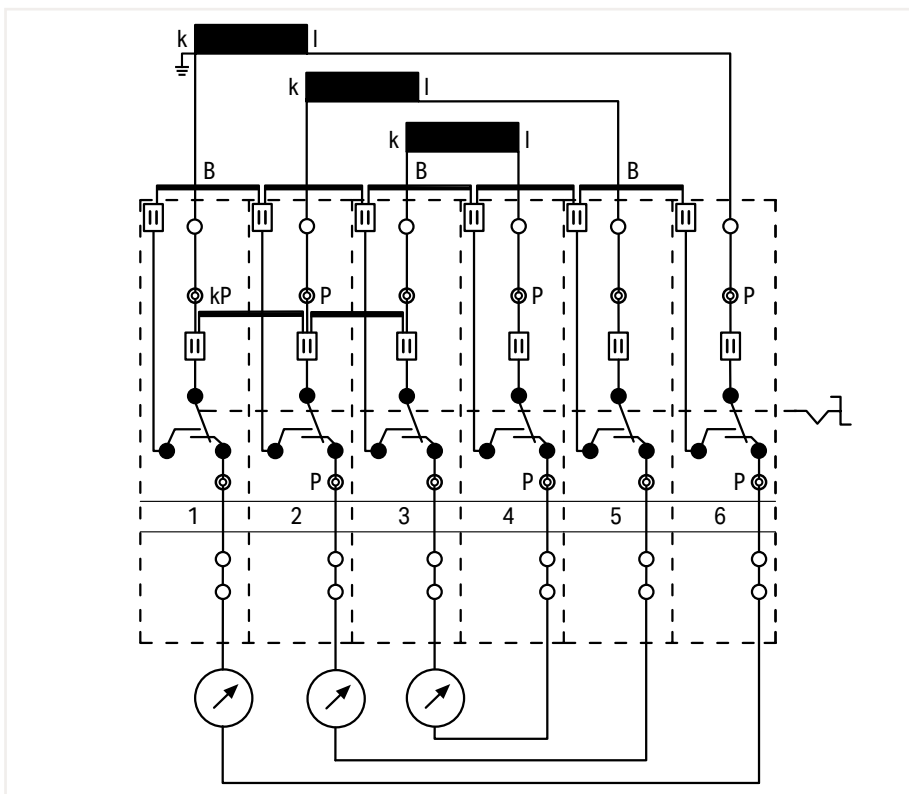

Measuring set for a three-phase current transformer with 'Y' point
 All six disconnect links are interconnected via interlocking link.

kP = 'Y' point jumper



- Terminal blocks required:
- 6 x disconnect/test terminal block (282-870)
 - 5 x jumper, orange (282-424)
 - 2 x jumper, gray (282-402)
 - 1 x end plate, orange (282-386)
 - In addition: interlocking link, locking cover, lock-out

Disconnect/Test Terminal Block, Through/Ground Conductor Terminal Block; for Current and Voltage Transformer Circuits 6 mm²; 282 Series

Technical Data

0.2 ... 6 mm ²	24 ... 10 AWG
500 V/6 kV/3 ①	600 V, 30 A ②
I _N 30 A	300 V, 5 A ③
Terminal block width: 8 mm / 0.315 inch	
12 ... 13 mm / 0.47 ... 0.51 inch	

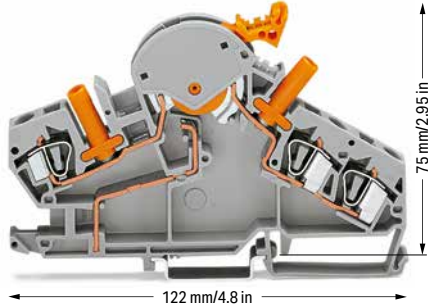

Technical Data

0.2 ... 6 mm ²	24 ... 10 AWG
500 V/6 kV/3 ①	600 V, 30 A ②
I _N 30 A	300 V, 5 A ③
Terminal block width: 8 mm / 0.315 inch	
12 ... 13 mm / 0.47 ... 0.51 inch	

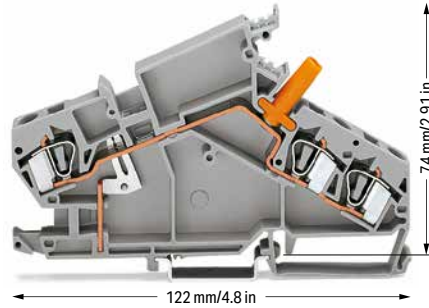

Technical Data

0.2 ... 6 mm ²	24 ... 10 AWG
500 V/6 kV/3 ①	600 V, 30 A ②
I _N 30 A	300 V, 5 A ③
Terminal block width: 8 mm / 0.315 inch	
12 ... 13 mm / 0.47 ... 0.51 inch	

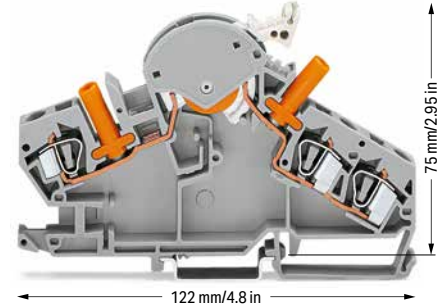

Disconnect/test terminal block; with touch-proof test sockets; for 4 mm Ø test plugs; e.g., for current transformer circuits; orange disconnect link

Color	Item No.	Pack. Unit
○ gray	282-870 ② ③	20

Through terminal block; with touch-proof test socket; for 4 mm Ø test plugs; e.g., for current transformer circuits

Color	Item No.	Pack. Unit
○ gray	282-865 ③	20

Disconnect/test terminal block; with touch-proof test sockets; for 4 mm Ø test plugs; e.g., for voltage transformer circuits; light gray disconnect link

Color	Item No.	Pack. Unit
○ gray	282-860 ② ③	20

Accessories; item-specific

End and separator plate; 1.5 mm thick; without lock-out seal option

	orange	282-386	50 (10)
	gray	282-391	50 (10)

Accessories; item-specific

End and intermediate plate; 1.5 mm thick

	orange	282-385	50 (10)
	gray	282-390	50 (10)

Accessories; item-specific

End and separator plate; 1.5 mm thick; without lock-out seal option

	orange	282-386	50 (10)
	gray	282-391	50 (10)

End and separator plate; 1.5 mm thick; with lock-out seal option

	orange	282-387	50 (10)
	gray	282-392	50 (10)

WMB marking card; 10 strips with 10 markers/card; stretchable 5 ... 5.2 mm; yellow

	k/I (50x)	794-5553/000-002	5
---	-----------	------------------	---

End and separator plate; 1.5 mm thick; with lock-out seal option

	orange	282-387	50 (10)
	gray	282-392	50 (10)

Lock-out device; for disconnect link

	yellow	282-384	100 (20)
--	--------	---------	----------

Lock-out device; for disconnect link

	yellow	282-384	100 (20)
---	--------	---------	----------

Locking cover; mechanically locks multiple links; transparent

	1-pole	282-881	50 (10)
	2-pole	282-882	50 (10)
	3-pole	282-883	50 (10)
	4-pole	282-884	50 (10)
	5-pole	282-885	50 (10)
	6-pole	282-886	50 (10)
	7-pole	282-887	50 (10)
	8-pole	282-888	50 (10)

Locking cover; mechanically locks multiple links; transparent

	1-pole	282-881	50 (10)
	2-pole	282-882	50 (10)
	3-pole	282-883	50 (10)
	4-pole	282-884	50 (10)
	5-pole	282-885	50 (10)
	6-pole	282-886	50 (10)
	7-pole	282-887	50 (10)
	8-pole	282-888	50 (10)

Interlocking link; mechanically locks multiple links; 1 m long

	transparent	210-254	1
--	-------------	---------	---

Interlocking link; mechanically locks multiple links; 1 m long

	transparent	210-254	1
---	-------------	---------	---

Adjacent jumper; insulated; I_N 41 A

	orange	282-424	100 (25)
--	--------	---------	----------

WMB marking card; 10 strips with 10 markers/card; stretchable 5 ... 5.2 mm; blue

	U/V (50x)	794-5554/000-006	5
---	-----------	------------------	---

WMB marking card; 10 strips with 10 markers/card; stretchable 5 ... 5.2 mm; yellow

	k/I (50x)	794-5553/000-002	5
--	-----------	------------------	---

Technical Data

0.2 ... 6 mm ²	24 ... 10 AWG
500 V/6 kV/3 ①	600 V, 30 A ②
I _N 30 A	300 V, 5 A ③
Terminal block width: 8 mm / 0.315 inch	
12 ... 13 mm / 0.47 ... 0.51 inch	

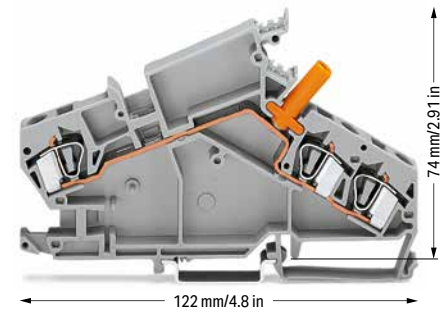

Through terminal block; with touch-proof test socket; for 4 mm Ø test plugs; e.g., for voltage transformer circuits

Color	Item No.	Pack. Unit
○ gray	282-866 ③	20

Accessories; item-specific

End and intermediate plate; 1.5 mm thick

Color	Item No.	Pack. Unit
orange	282-385	50 (10)
gray	282-390	50 (10)

WMB marking card; 10 strips with 10 markers/card; stretchable 5 ... 5.2 mm; blue

U/V (50x)	Item No.	Pack. Unit
	794-5554/000-006	5

Technical Data

0.2 ... 6 mm ²	24 ... 10 AWG
Terminal block width: 8 mm / 0.315 inch	
12 ... 13 mm / 0.47 ... 0.51 inch	

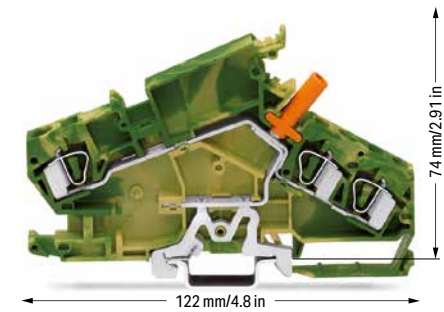

Ground conductor terminal block; with touch-proof test socket; for 4 mm Ø test plugs; e.g., for voltage transformer circuits

Color	Item No.	Pack. Unit
○ gray	282-868 ③	20

Accessories; item-specific

End and intermediate plate; 1.5 mm thick

Color	Item No.	Pack. Unit
orange	282-385	50 (10)
gray	282-390	50 (10)

① 500 V = rated voltage
6 kV = rated impulse voltage
3 = pollution degree
(see Section 14)

② Max. height when rotating the disconnect link (incl. locking cover): 92 mm/3.62 inch

③ For operating stickers, please refer to our online catalog:
• for 282-870: Item No. 210-412
• for 282-865: Item No. 210-415
• for 282-860: Item No. 210-414
• for 282-866: Item No. 210-413

Approvals and corresponding ratings, visit www.wago.com

Accessories; 282 Series

Appropriate marking systems:
WMB/WMB Inline/WFB

Protective warning marker; with black high-voltage symbol; for 5 terminal blocks

Color	Item No.	Pack. Unit
yellow	282-415	100 (25)

Adjacent jumper; insulated; I_N 41 A

Color	Item No.	Pack. Unit
gray	282-402	100 (25)
yellow-green	282-422	100 (25)

Alternate jumper; insulated; I_N 41 A

Color	Item No.	Pack. Unit
gray	282-409	100 (25)

Wire commoning chain; insulated; 4 connections; 3 x 110 mm; I_N 24 A

Color	Item No.	Pack. Unit
black	709-110	1

Wire commoning chain; insulated; 3 connections; 2 x 120 mm; I_N 24 A

Color	Item No.	Pack. Unit
black	709-111	1

Wire commoning chain; insulated; 3 connections; 2 x 170 mm; I_N 24 A

Color	Item No.	Pack. Unit
black	709-112	1

Group marker carrier; e.g., for 282 Series; angled

Color	Item No.	Pack. Unit
gray	209-144	50 (25)

WMB marking card; white; 10 strips with 10 markers/card; for 5 ... 17.5 mm terminal block width

Color	Item No.	Pack. Unit
plain	793-501	5

WMB marking card; plain; 10 strips with 10 markers/card; for 5 ... 17.5 mm terminal block width

Color	Item No.	Pack. Unit
yellow	793-501/000-002	5
red	793-501/000-005	5
blue	793-501/000-006	5
gray	793-501/000-007	5
orange	793-501/000-012	5
light green	793-501/000-017	5
green	793-501/000-023	5
violet	793-501/000-024	5

Transverse Switching Terminal Blocks and Longitudinal Switching Disconnect Terminal Blocks

282 Series

Description and Installation



Transverse switching terminal blocks
Left: Adjacent jumper for commoning of switching lever
Right: Commoning with orange jumper

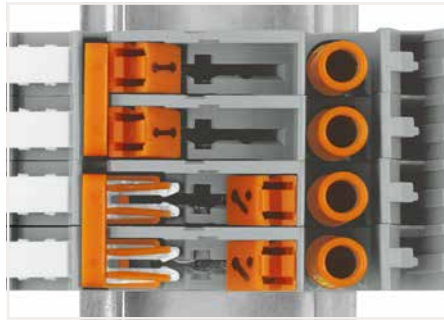

Switch positions
Left: closed
Right: open

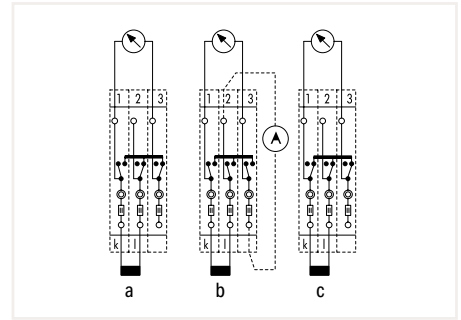

Current transformer circuit with transverse switching terminal blocks
a = Normal operation b = Transformer short circuit
c = Transformer short circuit

5



Testing via touch-proof 4 mm Ø test plugs (not available from WAGO, but offered by industry suppliers such as, Multi-Contact Deutschland GmbH).

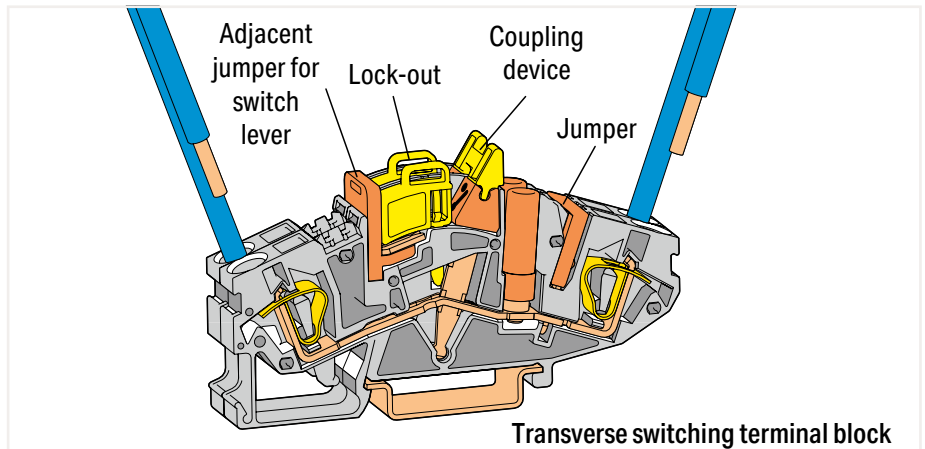

CAGE CLAMP® connection
Inserting a conductor.

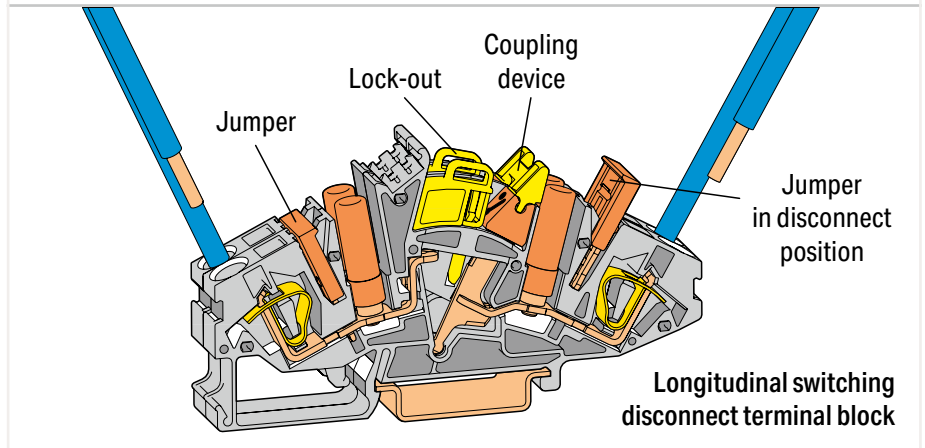

Inserting a lock-out.



Longitudinal switching disconnect terminal blocks

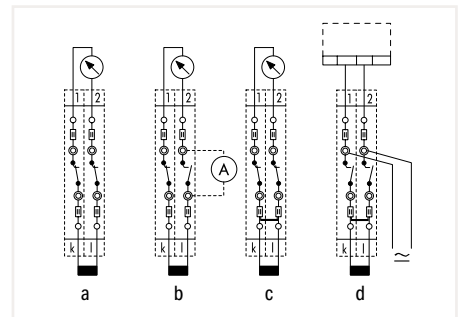

Current transformer circuit with longitudinal switching disconnect terminal blocks
a = Normal operation b = Measured value test
c = Transformer short circuit d = Relay test



CAGE CLAMP® terminates the following copper conductors:
solid



stranded



fine-stranded, also with tinned single strands

Jumpers with Safety Lid; for Longitudinal Switching Disconnect Terminal Blocks 282 Series



Jumper with safety lid
Jumper in pre-locked position

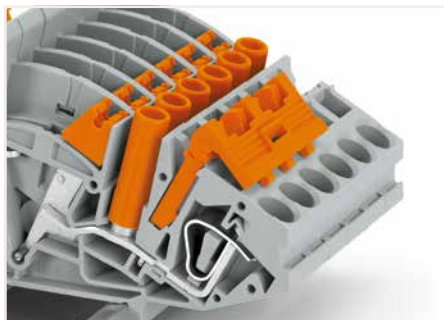

Jumper with safety lid
Longitudinal switching disconnect terminal blocks with inserted jumper, including safety lid



Jumper with safety lid
Jumper with raised safety lid



Jumper with safety lid
Removing a jumper via safety lid.



fine-stranded,
tip-bonded



fine-stranded,
with ferrule
(gastight crimped)



fine-stranded,
with pin terminal
(gastight crimped)

Transverse Switching Terminal Block, Longitudinal Switching Disconnect Terminal Block and Through Terminal Block (e.g., for Current Transformer Circuits) 6 mm²; 282 Series

Technical Data	
0.2 ... 6 mm ²	24 ... 10 AWG
500 V/6 kV/3 ①	600 V, 30 A ②
I _N 30 A	300 V, 36 A ③
Terminal block width: 8 mm / 0.315 inch	
12 ... 13 mm / 0.47 ... 0.51 inch	

Technical Data	
0.2 ... 6 mm ²	24 ... 10 AWG
500 V/6 kV/3 ①	600 V, 30 A ②
I _N 30 A	300 V, 36 A ③
Terminal block width: 8 mm / 0.315 inch	
12 ... 13 mm / 0.47 ... 0.51 inch	

Technical Data	
0.2 ... 6 mm ²	24 ... 10 AWG
500 V/6 kV/3 ①	
I _N 30 A	
Terminal block width: 8 mm / 0.315 inch	
12 ... 13 mm / 0.47 ... 0.51 inch	

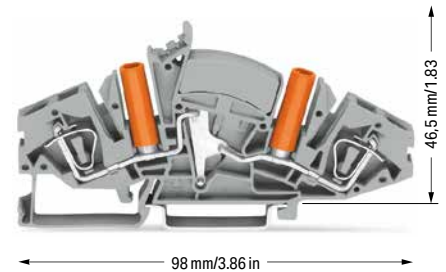
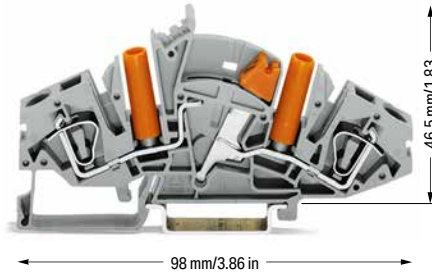
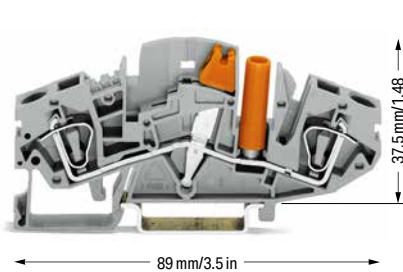

2-conductor disconnect/test terminal block; transverse switching; with touch-proof test socket; for 4 mm Ø test plug

Color	Item No.	Pack. Unit
○ gray	282-811 ②	20

2-conductor disconnect/test terminal block; longitudinal switching; with touch-proof test sockets; for 4 mm Ø test plugs

Color	Item No.	Pack. Unit
○ gray	282-821 ②	20

2-conductor through terminal block; with touch-proof test sockets; for 4 mm Ø test plugs

Color	Item No.	Pack. Unit
○ gray	282-841	20

Accessories; item-specific

End and separator plate; 1.5 mm thick

orange	282-366	50 (10)
gray	282-361	50 (10)

Accessories; item-specific

End and separator plate; 1.5 mm thick

orange	282-365	50 (10)
gray	282-360	50 (10)

Accessories; item-specific

End and separator plate; 1.5 mm thick

orange	282-365	50 (10)
gray	282-360	50 (10)

Locking cover; mechanically locks multiple links; transparent

2-way	282-442	50 (10)
3-way	282-443	50 (10)
4-way	282-444	50 (10)
5-way	282-445	50 (10)
6-way	282-446	50 (10)

Accessories; 282 Series

Lock-out device; for disconnect link

yellow	282-370	100 (25)
--------	---------	----------

Coupling device; mechanically locks multiple links; yellow

2-way	282-372	50 (10)
3-way	282-373	50 (10)
4-way	282-374	50 (10)

Protective warning marker; with black high-voltage symbol; for 5 terminal blocks

yellow	282-415	100 (20)
--------	---------	----------

Jumper; insulated; I_N 30 A; orange

2-way	282-432	50 (10)
3-way	282-433	50 (10)
4-way	282-434	50 (10)
5-way	282-435	50 (10)
6-way	282-436	50 (10)
7-way	282-437	50 (10)
8-way	282-438	50 (10)
9-way	282-439	50 (10)
10-way	282-440	50 (10)

Jumper with safety lid; insulated; I_N 30 A; orange

2-way	282-432/100-000	50 (10)
3-way	282-433/100-000	50 (10)
4-way	282-434/100-000	50 (10)

Appropriate marking systems: WMB/WMB Inline/WFB

Jumper; insulated; I_N 30 A; orange

1-3-5	282-435/011-000	50 (10)
1-4-5	282-435/301-000	50 (10)
1-3-4-5	282-435/300-000	50 (10)
1-2-4-6	282-436/301-000	50 (10)
1-4-6	282-436/304-000	50 (10)
1-3-5-7	282-437/011-000	50 (10)
1-4-7	282-437/012-000	50 (10)
1-2-5-8	282-438/300-000	50 (10)
1-4-7-8	282-438/301-000	50 (10)
1-3-5-7-9	282-439/011-000	50 (10)

Collective jumper carrier; for DIN-35 rail; compatible with jumpers for transverse switching terminal block (282-811) and longitudinal switching disconnect terminal block (282-821)

gray	282-369	25
------	---------	----

WMB marking card; 10 strips with 10 markers/card; stretchable 5 ... 5.2 mm; yellow

k/l (50x)	794-5553/000-002	5
-----------	------------------	---

WMB marking card; 10 strips with 10 markers/card; stretchable 5 ... 5.2 mm; blue

U/V (50x)	794-5554/000-006	5
-----------	------------------	---

WMB marking card; white; 10 strips with 10 markers/card; stretchable 5 ... 5.2 mm

plain	793-5501	5
-------	----------	---

WMB marking card; plain; 10 strips with 10 markers/card; stretchable 5 ... 5.2 mm

yellow	793-5501/000-002	5
red	793-5501/000-005	5
blue	793-5501/000-006	5
gray	793-5501/000-007	5
orange	793-5501/000-012	5
light green	793-5501/000-017	5
green	793-5501/000-023	5
violet	793-5501/000-024	5

Screwless end stop; for DIN-35 rail; 6 mm wide

gray	249-116	100 (25)
------	---------	----------

Screwless end stop; for DIN-35 rail; 10 mm wide

gray	249-117	50 (25)
------	---------	---------

Technical Data

0.2 ... 6 mm ²	24 ... 10 AWG
500 V/6 kV/3 ①	
I _N 30 A	
Terminal block width: 8 mm / 0.315 inch	
12 ... 13 mm / 0.47 ... 0.51 inch	

- ① 500 V = rated voltage
6 kV = rated impulse voltage
3 = pollution degree
(see Section 14)
 - ② Max. height when rotating the disconnect link (incl. locking cover): 45 mm / 1.77 inch
For operating stickers, please refer to our online catalog:
 - for 282-811: Item No. 210-424
 - for 282-821: Item No. 210-423
- Approvals and corresponding ratings, visit www.wago.com

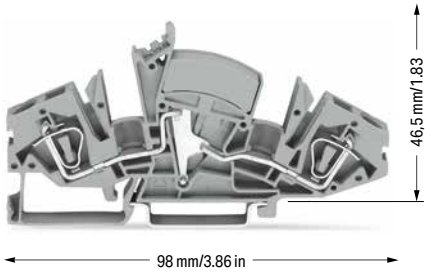

2-conductor through terminal block; without test sockets

Color	Item No.	Pack. Unit
○ gray	282-841/049-000	20

Accessories; item-specific

End and separator plate; 1.5 mm thick		
	orange 282-365	50 (10)
	gray 282-360	50 (10)

Disconnect Terminal Block and Ground Conductor Disconnect Terminal Block and Through Terminal Block of Same Profile

6 mm²; 282 Series

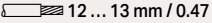
Technical Data	
0.2 ... 6 mm ²	24 ... 10 AWG
400 V/6 kV/3 ①	600 V, 30 A ②
I _N 30 A	300 V, 35 A ③
Terminal block width: 8 mm / 0.315 inch	
 12 ... 13 mm / 0.47 ... 0.51 inch	

Technical Data	
0.2 ... 6 mm ²	24 ... 10 AWG
800 V/8 kV/3 ①	600 V, 30 A ②
I _N 41 A	600 V, 35 A ③
Terminal block width: 8 mm / 0.315 inch	
 12 ... 13 mm / 0.47 ... 0.51 inch	

Technical Data	
0.2 ... 6 mm ²	24 ... 10 AWG
Terminal block width: 16 mm / 0.63 inch	
 12 ... 13 mm / 0.47 ... 0.51 inch	

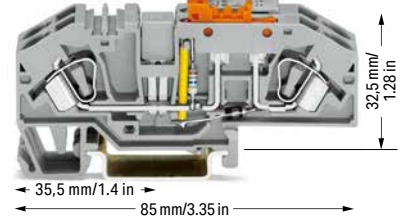
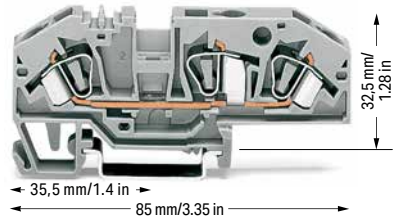
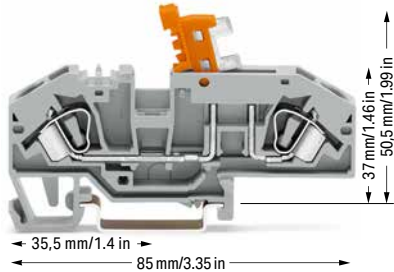

2-conductor disconnect terminal block; with test point; orange disconnect link

Color	Item No.	Pack. Unit
○ gray	282-697	25
● blue	282-695	25

3-conductor through terminal block; with test point; same profile as disconnect terminal blocks

Color	Item No.	Pack. Unit
○ gray	282-699	25
● blue	282-694	25

Ground conductor disconnect terminal block; with test point; orange disconnect link; gray

	Item No.	Pack. Unit
○ 24 V	282-640	12
○ 48 V	282-641	12
○ 120 V	282-638	12
○ 230 V	282-639	12

Other terminal blocks with the same profile:

Through	282-699	Page 292
---------	---------	----------

Other terminal blocks with the same profile:

Disconnect	282-697	Page 292
Ground cond. disc.	282-640	Page 292
Fuse	282-696	Page 294

Other terminal blocks with the same profile:

Through	282-699	Page 292
---------	---------	----------

Accessories; item-specific

Adjacent jumper; insulated; I_N 41 A

	gray	282-402	100 (25)
---	------	---------	----------

Accessories; item-specific

Adjacent jumper; insulated; I_N 41 A

	gray	282-402	100 (25)
---	------	---------	----------

Alternate jumper; insulated; I_N 41 A

	gray	282-409	100 (25)
---	------	---------	----------

Alternate jumper; insulated; I_N 41 A

	gray	282-409	100 (25)
---	------	---------	----------

Test plug adapter; 8.3 mm wide; for 4 mm Ø test plug; for 1.5 ... 10 mm² terminal blocks

	gray	209-170	50 (25)
---	------	---------	---------

Test plug adapter; 8.3 mm wide; for 4 mm Ø test plug; for 1.5 ... 10 mm² terminal blocks

	gray	209-170	50 (25)
---	------	---------	---------

Accessories; 282 Series

Appropriate marking systems: WMB/WMB Inline/WFB

End plate; 2 mm thick

	orange	282-333	100 (25)
	gray	282-334	100 (25)

Protective warning marker; with black high-voltage symbol; for 5 terminal blocks

	yellow	282-415	100 (25)
---	--------	---------	----------

Screwless end stop; for DIN-35 rail; 6 mm wide

	gray	249-116	100 (25)
---	------	---------	----------

Screwless end stop; for DIN-35 rail; 10 mm wide

	gray	249-117	50 (25)
---	------	---------	---------

- 1 400 V / 800 V = rated voltage
- 6 kV / 8 kV = rated impulse voltage
- 3 = pollution degree (see Section 14)

Approvals and corresponding ratings, visit www.wago.com



Ground conductor disconnect terminal block – top view

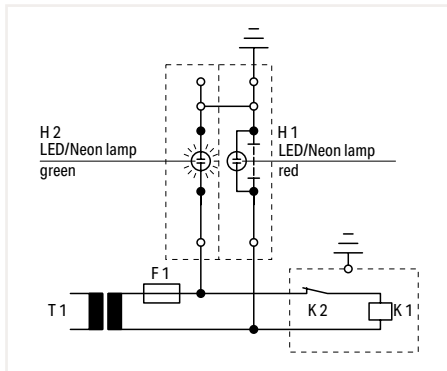

Operating condition
Slide link closed, auxiliary circuit grounded, green LED/neon lamp illuminates.

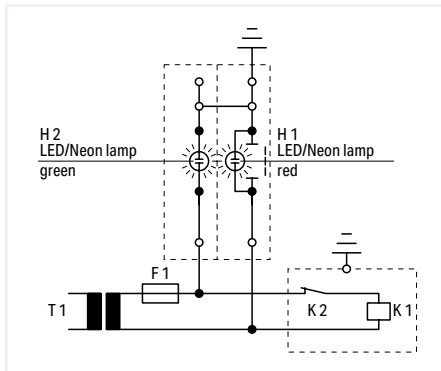

Test condition – no grounding
Slide link open, auxiliary circuit not grounded.

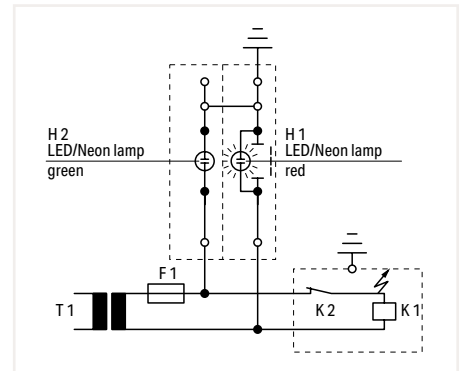

Test condition – grounding
Slide link open, auxiliary circuit not grounded, red LED/neon lamp illuminates.

5



Testing via conductor entry.



Testing via jumper contact slot.

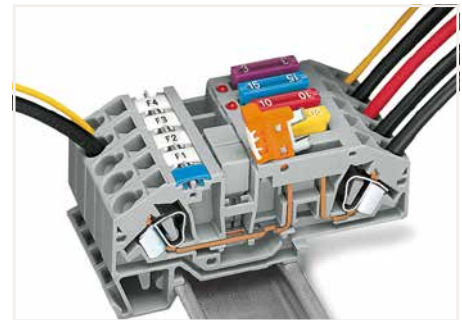

Power supply via disconnect link – disconnecting all outputs.

IEC 60204/DIN VDE 0113 "Safety of machinery – Electrical equipment of machines – Part 1: General requirements," Section 9.4.3.1:

Ground faults on control circuits must not cause unintentional starting, hazardous movements, or prevent stopping of the machine.

In order to fulfill this requirement, a connection to the protective bonding circuit must be provided in accordance with Section 8.2 and the devices must be connected as described in Section 9.1.4. Control circuits fed from a transformer and not connected to the protective bonding circuit must be provided with an insulation monitoring device (e.g., residual current device), which either indicates a ground fault or interrupts the circuit automatically after a ground fault.

In the case of electronic circuits, the connection of one side of the control circuit to the protective bonding circuit in accordance with Section 9.1.4 can prevent unintentional operation. When this does not help, or if due to other reasons that electronic circuits cannot be connected to the protective bonding circuit, other measures must be taken to achieve the same level of safety.

Multipole control switches that interrupt all live conductors must be used where the control circuit is directly connected between the phase conductors of the supply or between a phase conductor and a neutral conductor, which is either not grounded or grounded through a high impedance. This is required for starting or stopping machine functions, which can cause a hazardous situation including: damaging the machine or halting work in progress in the event of unintentional starting or failure to stop.

Fuse Terminal Block for Automotive Blade-Style Fuses

6 mm²; 282 Series

Technical Data	
0.2 ... 6 mm ²	24 ... 10 AWG
400 V/6 kV/3 ① ②	12 V, 30 A
I _N 25 A (30 A) ③	12 V, 30 A
Terminal block width: 8 mm / 0.315 inch	
12 ... 13 mm / 0.47 ... 0.51 inch	

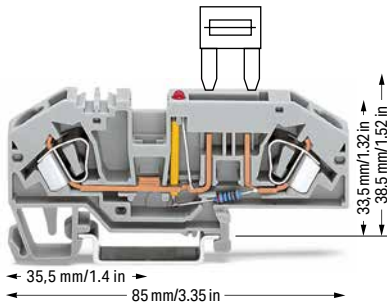

282-698/281-429

282-698/281-449

Technical Data	
0.2 ... 6 mm ²	24 ... 10 AWG
400 V/6 kV/3 ① ②	24 V, 30 A
I _N 25 A (30 A) ③	24 V, 30 A
Terminal block width: 8 mm / 0.315 inch	
12 ... 13 mm / 0.47 ... 0.51 inch	

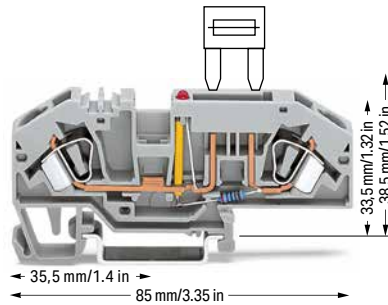

282-698/281-413

282-698/281-434

Technical Data	
0.2 ... 6 mm ²	24 ... 10 AWG
400 V/6 kV/3 ① ②	600 V, 30 A
I _N 25 A (30 A) ③	24 V, 30 A
Terminal block width: 8 mm / 0.315 inch	
12 ... 13 mm / 0.47 ... 0.51 inch	

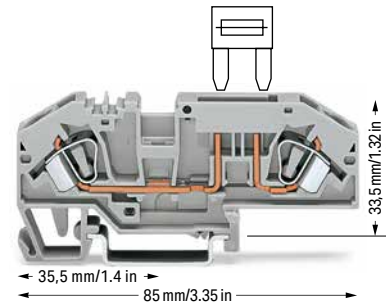

282-696

5

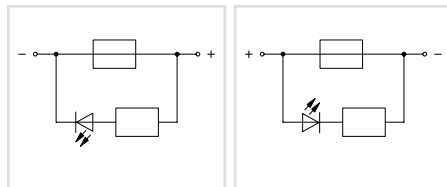

2-conductor fuse terminal block for automotive blade-style fuses; 12 V; with test point; with blown fuse indication by LED; LED power consumption: 4.8 mA
Electrical ratings are given by the fuse and blown fuse indication. Blade-style fuses: Observe touch-proof protection for 42 V and higher voltages!

Color	Item No.	Pack. Unit
gray	282-698/281-429	25
gray	282-698/281-449	25

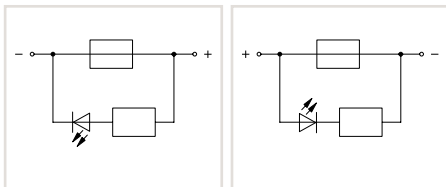

2-conductor fuse terminal block for automotive blade-style fuses; 24 V; with test point; with blown fuse indication by LED; LED power consumption: 4.8 mA
Electrical ratings are given by the fuse and blown fuse indication. Blade-style fuses: Observe touch-proof protection for 42 V and higher voltages!

Color	Item No.	Pack. Unit
gray	282-698/281-413	25
gray	282-698/281-434	25

2-conductor fuse terminal block for automotive blade-style fuses; with test point; without blown fuse indication; Electrical ratings are given by the fuse. Blade-style fuses: Observe touch-proof protection for 42 V and higher voltages!

Color	Item No.	Pack. Unit
gray	282-696	25

Other terminal blocks with the same profile:
Through [282-699](#) Page 292

Accessories; 282 Series

Appropriate marking systems: WMB/Marking strips

End plate; 2 mm thick

gray	282-333	100 (25)
orange	282-334	100 (25)

Adjacent jumper; insulated; I_N 41 A

gray	282-402	100 (25)
yellow-green	282-422	100 (25)

Alternate jumper; insulated; I_N 41 A

gray	282-409	100 (25)
------	---------	----------

Test plug adapter; 8.3 mm wide; for 4 mm Ø test plug; for 1.5 ... 10 mm² terminal blocks

gray	209-170	50 (25)
------	---------	---------

Screwless end stop; for DIN-35 rail; 6 mm wide

gray	249-116	100 (25)
------	---------	----------

Screwless end stop; for DIN-35 rail; 10 mm wide

gray	249-117	50 (25)
------	---------	---------

- ❶ 400 V = rated voltage
6 kV = rated impulse voltage
3 = pollution degree
 - ❷ Electrical ratings are given by the fuse (see page 308).
 - ❸ LED power consumption: 4.8 mA
- Blade-style fuses are not offered by WAGO.
Thermal automotive circuit breakers are not offered by WAGO.
WAGO recommends automotive circuit breakers from ETA.
- Please observe the application notes:
Marking, from page 588
- Approvals and corresponding ratings,
visit www.wago.com

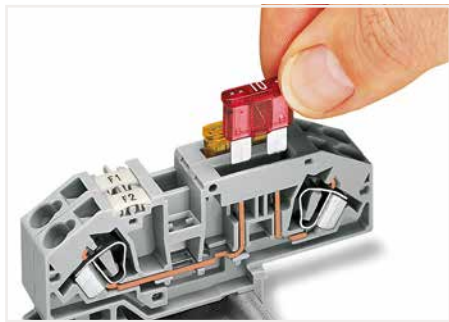

Inserting a fuse.



Blown fuse indication by LED

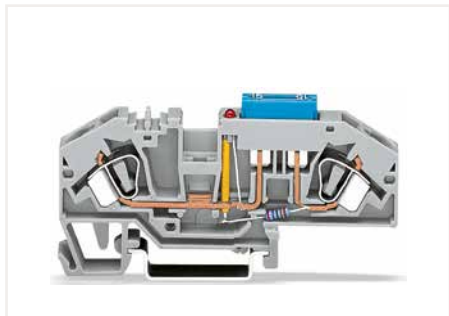

2-conductor fuse terminal block with mini-automotive blade-style fuse

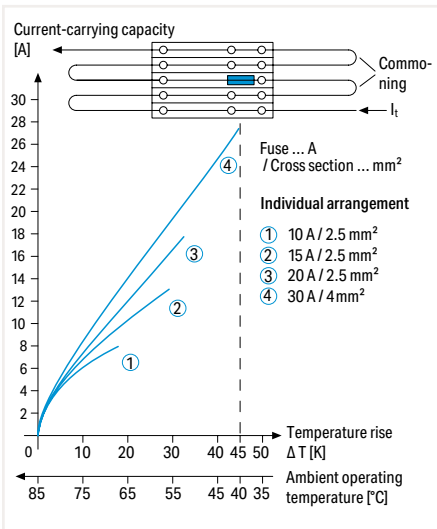

Application Notes on Fuse Terminal Blocks
Diagram: Individual arrangement

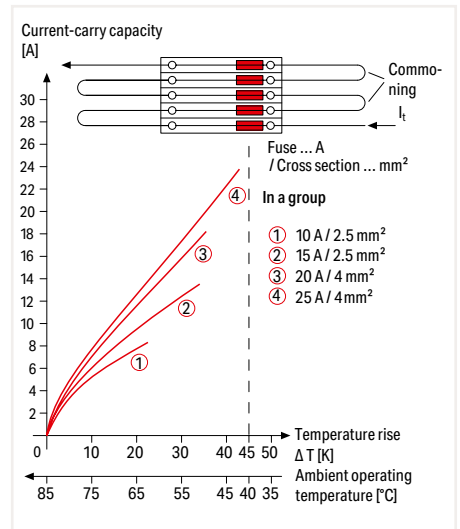

Application Notes on Fuse Terminal Blocks
Diagram: Block arrangement

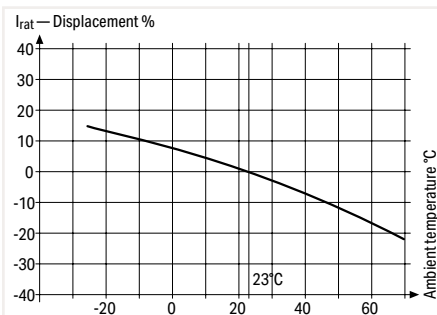

Application Notes on Fuse Terminal Blocks
Nominal current ratings for fuse cartridges are defined differently in international standards. This is why the recommended continuous current-carrying capacity of the fuses is a max. 80% of their nominal current according to DIN 72581/Part 3 (for a surrounding air temperature of 23°C).
Selecting the correct fuse cartridge is important for product safety within applications, as well as for fuse cartridge service life and reliability. Fuse cartridges will only operate perfectly as protection components (break-off point) if they are properly selected and used as intended (i.e., according to the state of the technology and valid specifications, as well as data sheet characteristics), according to basic safety requirements (i.e., persons, animals and property must be protected against hazards).

Information from the mini-automotive, blade-type fuse manufacturers

Derating T _{amb} / °C	%	F _T
-25	14	0.877
-20	13	0.885
-15	12	0.893
-10	11	0.901
-5	10	0.909
0	9	0.917
5	8	0.926
10	6	0.943
15	4	0.962
20	2	0.980
23	0	1.000
30	-2	1.020
35	-4	1.042
40	-6	1.064
45	-8	1.087
50	-10	1.111
55	-13	1.149
60	-16	1.190
65	-19	1.235
70	-22	1.282

With regard to product safety, fuse cartridges must generally be tested both under normal and faulty operating conditions within your application.

Fused Disconnect Terminal Blocks with a Pivoting Fuse Holder; for Glass Cartridge Fuses

282 Series

Description and Installation



Blown fuse indication by LED or neon lamp



Fuse replacement:
Before replacing a fuse, pivot the fuse holder into the locked open position.

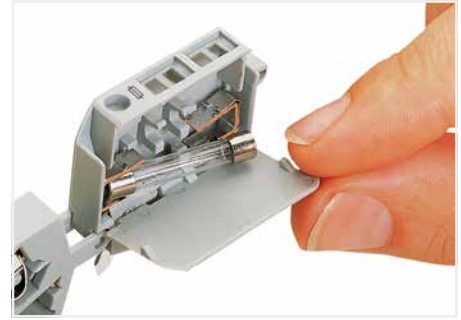

Fuse replacement:
One end of the fuse is automatically ejected from the holder when opening the cover.

5



CAGE CLAMP® connection
Inserting a conductor.
With ferruled conductors, it is necessary to use a terminal block one size smaller than the conductor's nominal cross section.

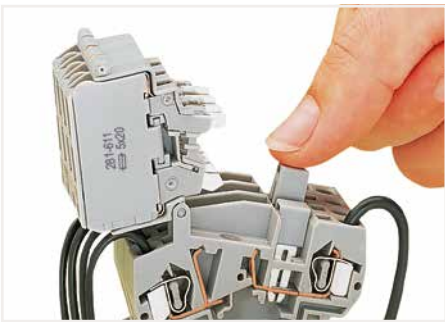
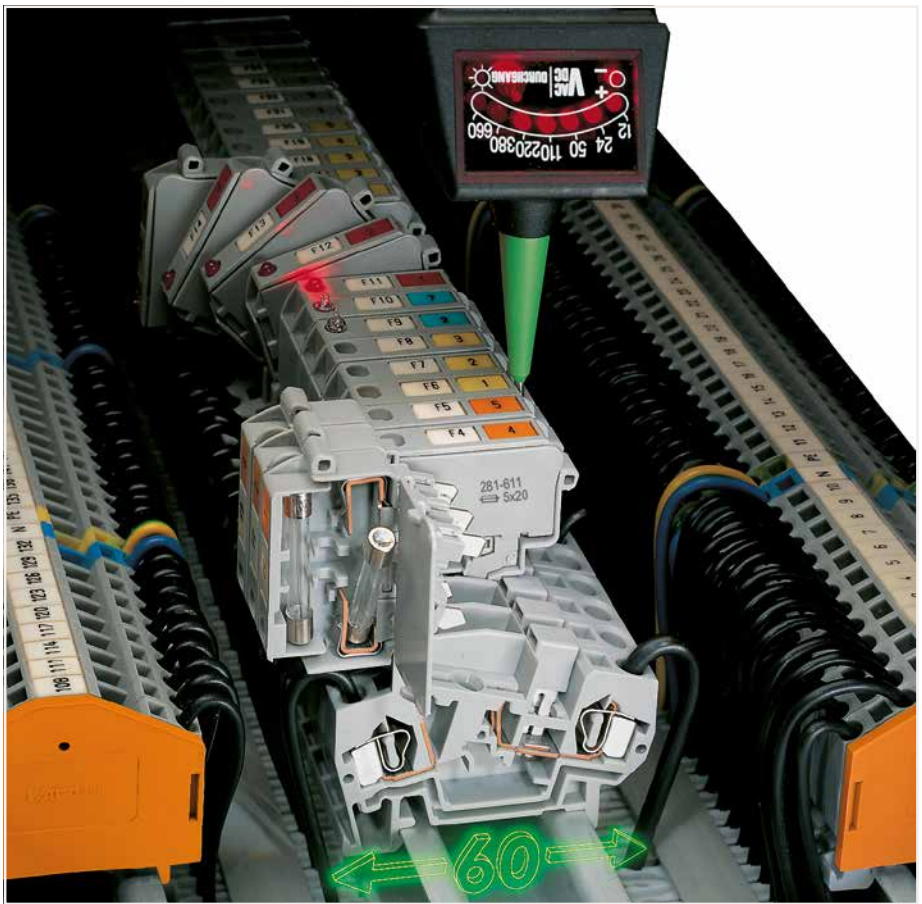

Commoning
Distributing current to several fuse-protected circuits via insulated push-in type jumpers.

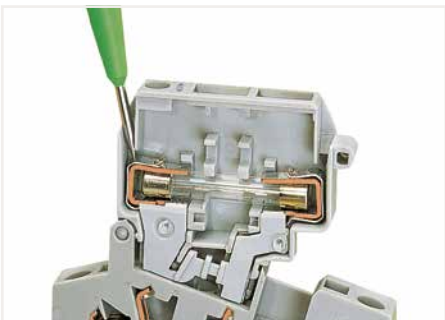

Voltage test, either at input or output with fuse holder in closed position (live)



Through test with fuse holder in open position (no voltage)



Voltage test at input in the test slot of the current bar



CAGE CLAMP® terminates the following copper conductors: solid



stranded



fine-stranded, also with tinned single strands

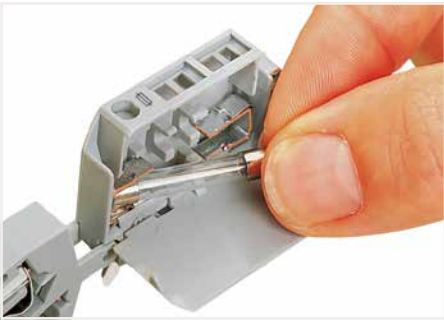

Fuse replacement:
Easily removing a fuse by hand.



Fuse replacement:
Insert a new fuse and snap the cover closed.



Storing a spare fuse (fuse holder without blown fuse indication).

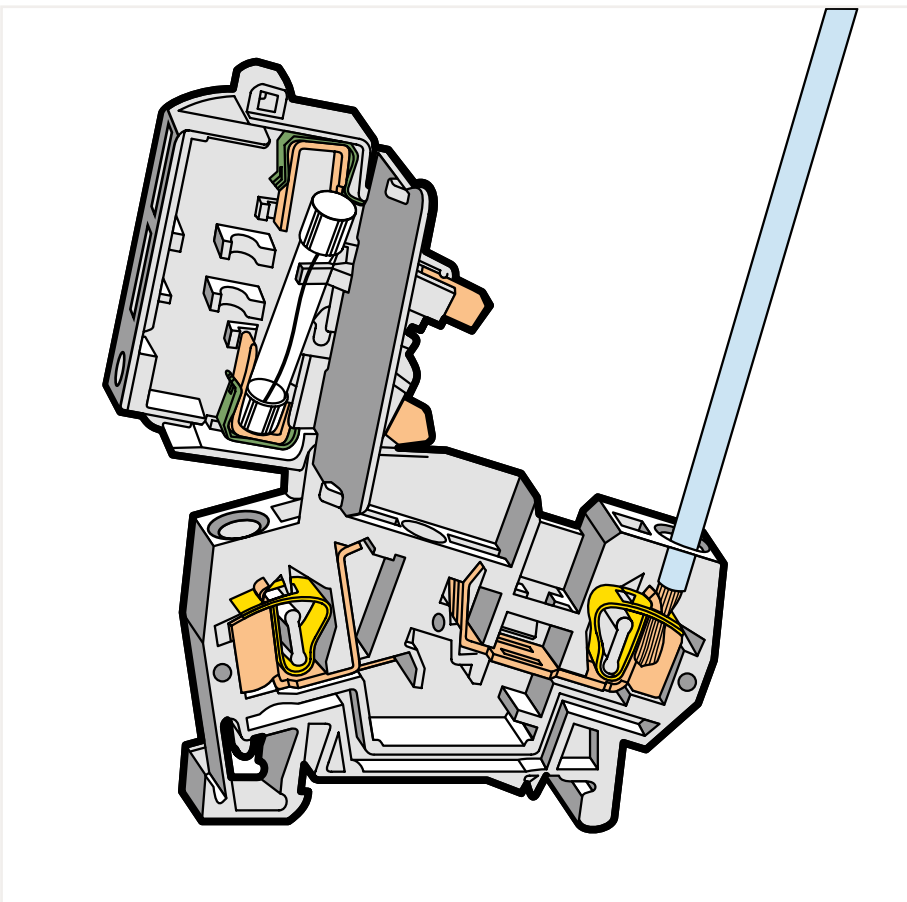

Touch-proof protection in all positions of the fuse holder



Fuse holder will remain safely locked open in vertical assemblies.

5



Testing voltage at the output via separate test slot.



Measuring current between jumper slot and separate test slot.

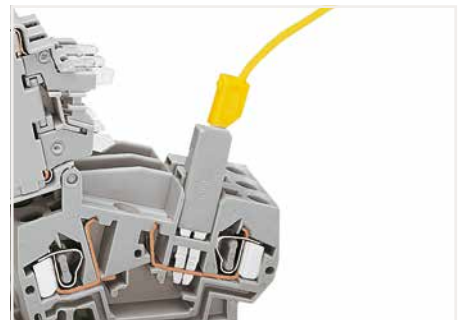

Testing voltage (input side) via test plug adapter (280-404, shown) or test plug (281-407).



fine-stranded,
tip-bonded



fine-stranded,
with ferrule
(gastight crimped)



fine-stranded,
with pin terminal
(gastight crimped)

Fused Disconnect Terminal Block with a Pivoting Fuse Holder; for 5 x 20 mm, 5 x 25 mm and 5 x 30 mm Glass Cartridge Fuses 4 mm²; 281 Series

Technical Data	
0.08 ... 4 mm ²	28 ... 12 AWG
800 V/8 kV/3 ① ②	600 V, 10 A
I _N 10 A	600 V, 10 A
Terminal block width: 8 mm / 0.315 inch	
9 ... 10 mm / 0.35 ... 0.39 inch	

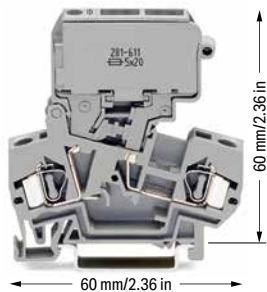

Dimensions (in mm):

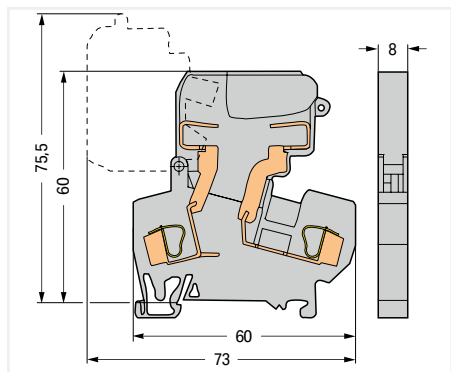

Fused disconnect terminal block with a pivoting fuse holder; for 5 x 20 mm glass cartridge fuse; without blown fuse indication
Electrical ratings are given by the fuse.

Color	Item No.	Pack. Unit
gray	281-611	50
orange	281-616	50

Technical Data	
0.08 ... 4 mm ²	28 ... 12 AWG
800 V/8 kV/3 ① ②	30 V, 10 A
I _N 10 A	230 V, 10 A
Terminal block width: 8 mm / 0.315 inch	
9 ... 10 mm / 0.35 ... 0.39 inch	

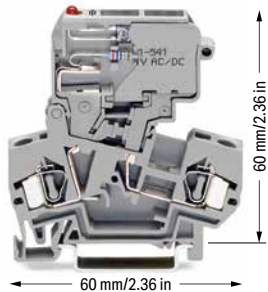

Dimensions (in mm):

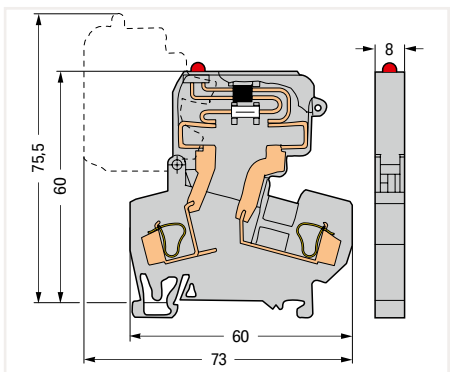

Fused disconnect terminal block with a pivoting fuse holder; for 5 x 20 mm glass cartridge fuse; with blown fuse indication by LED; gray
Electrical ratings are given by the fuse and blown fuse indication. Leakage current in case of a blown fuse: LED 6 mA

	Item No.	Pack. Unit
15 ... 30 V	281-611/281-541	50
30 ... 65 V	281-611/281-542	50

Technical Data	
0.08 ... 4 mm ²	28 ... 12 AWG
800 V/8 kV/3 ① ②	220 V, 10 A
I _N 10 A	230 V, 10 A
Terminal block width: 8 mm / 0.315 inch	
9 ... 10 mm / 0.35 ... 0.39 inch	

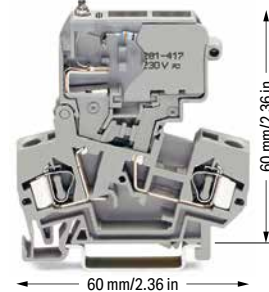

Dimensions (in mm):

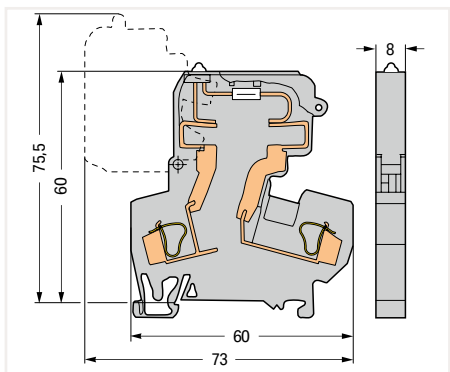

Fused disconnect terminal block with a pivoting fuse holder; for 5 x 20 mm glass cartridge fuse; with blown fuse indication by neon lamp; gray
Electrical ratings are given by the fuse and blown fuse indication. Leakage current in case of a blown fuse: Neon lamp < 0.4 mA

	Item No.	Pack. Unit
230 V	281-611/281-417	50
120 V	281-611/281-418	50

Fused disconnect terminal block with a pivoting fuse holder; for 5 x 25 mm glass cartridge fuse; without blown fuse indication Electrical ratings are given by the fuse.		
gray	281-612	50

Fused disconnect terminal block with a pivoting fuse holder; for 5 x 25 mm glass cartridge fuse; with blown fuse indication by LED; gray Electrical ratings are given by the fuse and blown fuse indication. Leakage current in case of a blown fuse: LED 6 mA		
15 ... 30 V	281-612/281-541	50
30 ... 65 V	281-612/281-542	50

Fused disconnect terminal block with a pivoting fuse holder; for 5 x 25 mm glass cartridge fuse; with blown fuse indication by neon lamp; gray Electrical ratings are given by the fuse and blown fuse indication. Leakage current in case of a blown fuse: Neon lamp < 0.4 mA		
230 V	281-612/281-417	50
120 V	281-612/281-418	50

Fused disconnect terminal block with a pivoting fuse holder; for 5 x 30 mm glass cartridge fuse; without blown fuse indication Electrical ratings are given by the fuse.		
gray	281-622	50

Fused disconnect terminal block with a pivoting fuse holder; for 5 x 30 mm glass cartridge fuse; with blown fuse indication by LED; gray Electrical ratings are given by the fuse and blown fuse indication. Leakage current in case of a blown fuse: LED 6 mA		
15 ... 30 V	281-622/281-541	50
30 ... 65 V	281-622/281-542	50

Fused disconnect terminal block with a pivoting fuse holder; for 5 x 30 mm glass cartridge fuse; with blown fuse indication by neon lamp; gray Electrical ratings are given by the fuse and blown fuse indication. Leakage current in case of a blown fuse: Neon lamp < 0.4 mA		
230 V	281-622/281-417	50
120 V	281-622/281-418	50

Glass cartridge fuses are available upon request.

Glass cartridge fuses are available upon request.

Glass cartridge fuses are available upon request.

Technical Data

0.08 ... 4 mm ²	28 ... 12 AWG
800 V/8 kV/3 ①	600 V, 16 A ②
I _N 16 A	
Terminal block width: 8 mm / 0.315 inch	
9 ... 10 mm / 0.35 ... 0.39 inch	



Dimensions (in mm):

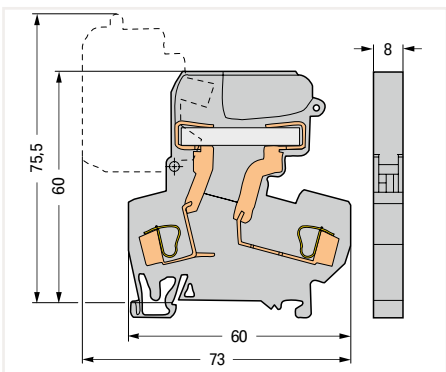

2-conductor disconnect terminal block

Color	Item No.	Pack. Unit
gray	281-624	100
orange	281-672	100

- ① 800 V = rated voltage
8 kV = rated impulse voltage
3 = pollution degree
(see Section 14)
 - ② Electrical ratings are given by the fuse (see page 308).
- Please observe the application notes:
Marking, from page 588
- Approvals and corresponding ratings,
visit www.wago.com

Accessories; 281 Series

Appropriate marking systems:
WMB/WMB Inline/WFB

End and intermediate plate; 2.5 mm thick

gray	281-309	100 (25)
orange	281-311	100 (25)

Adjacent jumper; insulated; I_N = I_N terminal block

gray	281-402	200 (25)
------	---------	----------

Collective carrier for adjacent jumpers

gray	209-100	50 (25)
------	---------	---------

Push-in type wire jumper; insulated; 0.75 mm² conductor cross section; I_N 9 A

L = 60 mm	249-125	100 (10)
L = 110 mm	249-126	100 (10)
L = 250 mm	249-127	100 (10)

Test plug adapter; 5 mm wide; for 210-137 Test Plug (2.3 mm Ø); for 1.5 ... 4 mm² terminal blocks

gray	280-404	100 (25)
------	---------	----------

Test plug adapter; 6 mm wide; with CAGE CLAMP®; for 0.08 ... 2.5 mm²

I _N 24 A	281-407	100 (25)
---------------------	---------	----------

Test plug; with 500 mm cable; 2.3 mm Ø; max. 42 V

yellow	210-137	50
--------	---------	----

Interlocking link; mechanically locks multiple links; 1 m long

transparent	210-254	1
-------------	---------	---

Screwless end stop; for DIN-35 rail; 6 mm wide

gray	249-116	100 (25)
------	---------	----------

Screwless end stop; for DIN-35 rail; 10 mm wide

gray	249-117	50 (25)
------	---------	---------



Fused disconnect or disconnect terminal blocks with a width of 8 mm can be assembled adjacently. At the end of an assembly or if there is no adjacent fused disconnect or disconnect terminal block, an end or intermediate plate must be used.



All fuse holders are printed with correct fuse size.

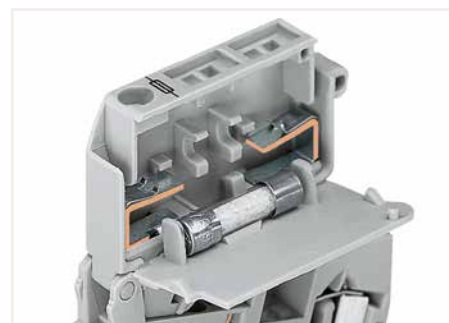

5 x 20 mm, 5 x 25 mm and 1/4" x 1" fuse holders are fitted with stops on the inside of the cover.

5

Sold & Serviced By:

 Toll Free Phone (877) SERV098
www.electromate.com
sales@electromate.com

Fused Disconnect Terminal Block with a Pivoting Fuse Holder; for 1/4" x 1" and 1/4" x 1 1/4" Glass Cartridge Fuses 4 mm²; 281 Series

Technical Data	
0.08 ... 4 mm ²	28 ... 12 AWG
800 V/8 kV/3 ① ②	600 V, 10 A
I _N 10 A	600 V, 10 A
Terminal block width: 10 mm / 0.394 inch	
9 ... 10 mm / 0.35 ... 0.39 inch	



Dimensions (in mm):

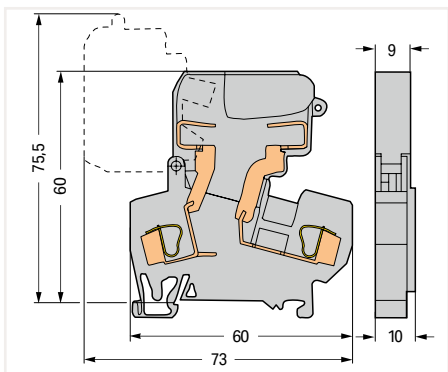

Fused disconnect terminal block with a pivoting fuse holder; for 1/4" x 1" glass cartridge fuse; without blown fuse indication
Electrical ratings are given by the fuse.

Color	Item No.	Pack. Unit
gray	281-613	50

Fused disconnect terminal block with a pivoting fuse holder; for 1/4" x 1 1/4" glass cartridge fuse; without blown fuse indication
Electrical ratings are given by the fuse.

gray	281-623	50
------	---------	----

Glass cartridge fuses are available upon request.

Technical Data	
0.08 ... 4 mm ²	28 ... 12 AWG
800 V/8 kV/3 ① ②	30 V, 10 A
I _N 10 A	30 V, 10 A
Terminal block width: 10 mm / 0.394 inch	
9 ... 10 mm / 0.35 ... 0.39 inch	



Dimensions (in mm):

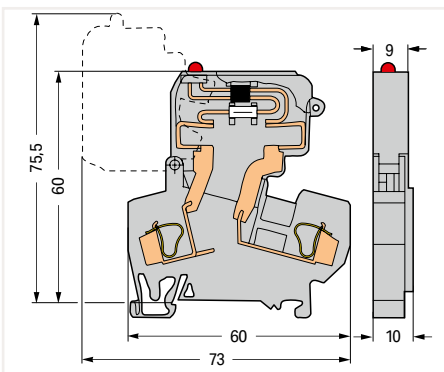

Fused disconnect terminal block with a pivoting fuse holder; for 1/4" x 1" glass cartridge fuse; with blown fuse indication by LED; gray
Electrical ratings are given by the fuse and blown fuse indication. Leakage current in case of a blown fuse: LED 6 mA

	Item No.	Pack. Unit
15 ... 30 V	281-613/281-541	50
30 ... 65 V	281-613/281-542	50

Fused disconnect terminal block with a pivoting fuse holder; for 1/4" x 1 1/4" glass cartridge fuse; with blown fuse indication by LED; gray
Electrical ratings are given by the fuse and blown fuse indication. Leakage current in case of a blown fuse: LED 6 mA

15 ... 30 V	281-623/281-541	50
30 ... 65 V	281-623/281-542	50

Glass cartridge fuses are available upon request.

Technical Data	
0.08 ... 4 mm ²	28 ... 12 AWG
800 V/8 kV/3 ① ②	220 V, 10 A
I _N 10 A	100 V, 10 A
Terminal block width: 10 mm / 0.394 inch	
9 ... 10 mm / 0.35 ... 0.39 inch	

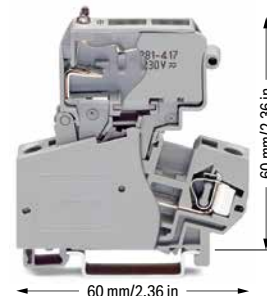

Dimensions (in mm):

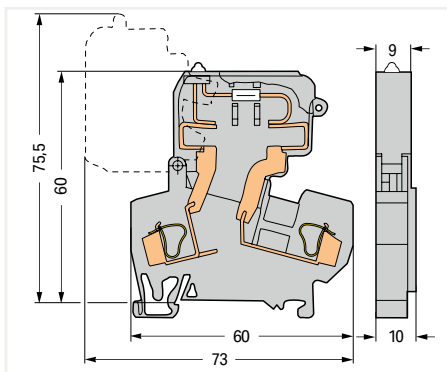

Fused disconnect terminal block with a pivoting fuse holder; for 1/4" x 1" glass cartridge fuse; with blown fuse indication by neon lamp; gray
Electrical ratings are given by the fuse and blown fuse indication. Leakage current in case of a blown fuse: Neon lamp < 0.4 mA

	Item No.	Pack. Unit
230 V	281-613/281-417	50
120 V	281-613/281-418	50

Fused disconnect terminal block with a pivoting fuse holder; for 1/4" x 1 1/4" glass cartridge fuse; with blown fuse indication by neon lamp; gray
Electrical ratings are given by the fuse and blown fuse indication. Leakage current in case of a blown fuse: Neon lamp < 0.4 mA

230 V	281-623/281-417	50
120 V	281-623/281-418	50

Glass cartridge fuses are available upon request.

- 1 800 V = rated voltage
8 kV = rated impulse voltage
3 = pollution degree
(see Section 14)
 - 2 Electrical ratings are given by the fuse (see page 308).
- Please observe the application notes:
Marking, from page 588
- Approvals and corresponding ratings,
visit www.wago.com





An intermediate plate is supplied with all 10 mm wide fused disconnect terminal blocks. At the end of an assembly or if there is no adjacent fused disconnect terminal block, an end or intermediate plate must be used.

Accessories; 281 Series

Appropriate marking systems:
WMB/WMB Inline/WFB

End and intermediate plate; 2.5 mm thick

	gray	281-309	100 (25)
	orange	281-311	100 (25)

Adjacent jumper; insulated; I_N = I_N terminal block

	gray	281-402	200 (25)
---	------	---------	----------

Collective carrier for adjacent jumpers

	gray	209-100	50 (25)
---	------	---------	---------

Push-in type wire jumper; insulated; 0.75 mm² conductor cross section; I_N 9 A

	L = 60 mm	249-125	100 (10)
	L = 110 mm	249-126	100 (10)
	L = 250 mm	249-127	100 (10)

Test plug adapter; 5 mm wide; for 210-137 Test Plug (2.3 mm Ø); for 1.5 ... 4 mm² terminal blocks

	gray	280-404	100 (25)
---	------	---------	----------

Test plug adapter; 6 mm wide; with CAGE CLAMP®; for 0.08 ... 2.5 mm²

	I _N 24 A	281-407	100 (25)
---	---------------------	---------	----------

Test plug; with 500 mm cable; 2.3 mm Ø; max. 42 V

	yellow	210-137	50
---	--------	---------	----

Interlocking link; mechanically locks multiple links; 1 m long

	transparent	210-254	1
---	-------------	---------	---

Screwless end stop; for DIN-35 rail; 6 mm wide

	gray	249-116	100 (25)
---	------	---------	----------

Screwless end stop; for DIN-35 rail; 10 mm wide

	gray	249-117	50 (25)
---	------	---------	---------

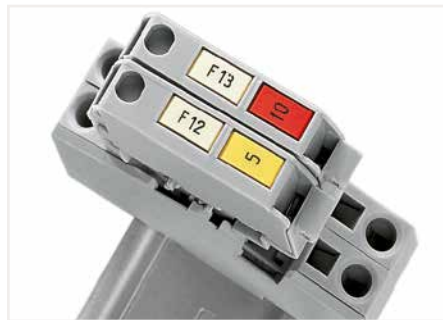

Each fuse holder features two marker slots for custom WMB Multi markers (example shows 8 mm wide terminal blocks).



Ganging several fuse holders with an interlocking link (example shows 8 mm wide terminal blocks).

Sold & Serviced By:

 Toll Free Phone (877) SERV098
www.electromate.com
sales@electromate.com

Fuse Plug on Carrier Terminal Block 4 mm² 281 Series

Technical Data

250 V / I_N 6,3 A ⁴
Plug width: 6 mm / 0.236 inch



281-511

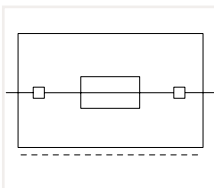

Fuse plug with pull-tab; for 5 x 20 mm and 5 x 25 mm glass cartridge fuses; 6 mm wide
Electrical ratings are given by the fuse.

Color	Item No.	Pack. Unit
○ gray	281-511	50

Technical Data

250 V / I_N 6,3 A ⁴
Plug width: 6 mm / 0.236 inch



281-512

281-512/281-501

281-512/281-418

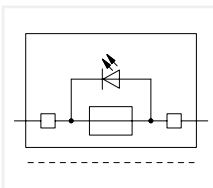

Fuse plug with pull-tab; for 5 x 20 mm and 5 x 25 mm glass cartridge fuses; with LED; 24 VAC/DC; 6 mm wide
Electrical ratings are given by the fuse and blown fuse indication. Leakage current in case of a blown fuse: LED 5 ... 20 mA

Color	Item No.	Pack. Unit
○ gray	281-512/281-501	50

Fuse plug with pull-tab; for 5 x 20 mm and 5 x 25 mm glass cartridge fuses; with hole for one LED (for self-assembly); 6 mm wide; gray
Electrical ratings are given by the fuse and blown fuse indication.

○ gray	281-512	50
--------	---------	----

Fuse plug with pull-tab; for 5 x 20 mm and 5 x 25 mm glass cartridge fuses; with neon lamp; 120 VAC/DC; 6 mm wide
Electrical ratings are given by the fuse and blown fuse indication. Leakage current in case of a blown fuse: Neon lamp < 0.4 mA

○ gray	281-512/281-418	50
--------	-----------------	----

Fuse plug with pull-tab; for 5 x 20 mm and 5 x 25 mm glass cartridge fuses; with neon lamp; 230 VAC/DC; 6 mm wide
Electrical ratings are given by the fuse and blown fuse indication. Leakage current in case of a blown fuse: Neon lamp < 0.4 mA

○ gray	281-512/281-417	50
--------	-----------------	----

Accessories; for fuse plugs

Appropriate marking systems: 4 mm wide WSB for plug and WMB for terminal block

2-conductor carrier terminal block;
0.08 ... 4 mm² / 28 ... 12 AWG
Terminal block width: 6 mm / 0.236 inch

gray	281-916	50
------	---------	----



4-conductor carrier terminal block;
0.08 ... 4 mm² / 28 ... 12 AWG
Terminal block width: 6 mm / 0.236 inch

gray	281-656	50
------	---------	----



End and intermediate plate; 2.5 mm thick

orange	281-329	100 (25)
gray	281-328	100 (25)



End and intermediate plate; 2.5 mm thick

orange	281-335	100 (25)
gray	281-334	100 (25)



3-conductor carrier terminal block;
0.08 ... 4 mm² / 28 ... 12 AWG
Terminal block width: 6 mm / 0.236 inch

gray	281-610	50
------	---------	----



Wire commoning chain; insulated; 50 connections; I_N 8 A

black	210-103	5
-------	---------	---



End and intermediate plate; 2.5 mm thick

orange	281-326	100 (25)
gray	281-324	100 (25)



Wire commoning chain; insulated; 50 connections; I_N 8 A

blue	210-123	5
------	---------	---



⁴ Electrical ratings are given by the fuse or LED nominal voltage (see page 308).

Please observe the application notes:
Marking, from page 588

Approvals and corresponding ratings,
visit www.wago.com

Accessories; for fuse plugs

Appropriate marking systems:
4 mm wide WSB for plug and WMB for terminal block

Comb-style jumper bar; insulated; I_N = I_N of terminal block

2-way	281-482	100 (25)
3-way	281-483	100 (25)
5-way	281-485	100 (25)
10-way	281-490	50 (25)



Alternate comb-style jumper bar; insulated; I_N = I_N of terminal block

2-way	281-492	100 (25)
-------	---------	----------



Operating tool; insulated

2-way	280-432	1
3-way	280-433	1
5-way	281-440	1



Shorting link; 5 x 20 mm; allows the fuse plug to be used as a disconnect plug

I _N 6.3 A	281-503	250 (25)
----------------------	---------	----------



WSB marking card; white; 10 strips with 10 markers/card; 4 mm wide WSB markers

plain	209-701	5
-------	---------	---



WSB marking card; plain; 10 strips with 10 markers/card; 4 mm wide WSB markers

yellow	209-701/000-002	5
red	209-701/000-005	5
blue	209-701/000-006	5
gray	209-701/000-007	5
orange	209-701/000-012	5
light green	209-701/000-017	5
green	209-701/000-023	5
violet	209-701/000-024	5



WSB marking card; for fuse plugs (281-5..); white; 4 mm wide WSB markers

F1, ..., F10 (10x)	209-787	5
F11, ..., F20 (10x)	209-700/209-124	5
F21, ..., F30 (10x)	209-700/209-125	5
F31, ..., F40 (10x)	209-700/209-126	5
F41, ..., F50 (10x)	209-700/209-127	5



WMB marking card; white; 10 strips with 10 markers/card; stretchable 5 ... 5.2 mm

plain	793-5501	5
-------	----------	---



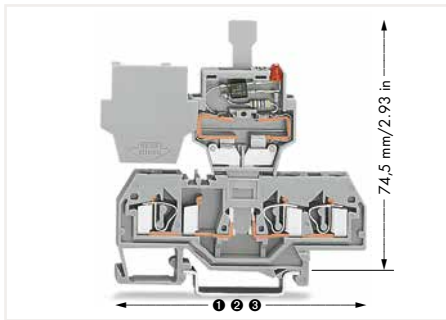

Length of carrier terminal blocks with a fuse plug:

- ❶ 59 mm / 2.32 inch for 281-916
- ❷ 73.5 mm / 2.89 inch for 281-610
- ❸ 86 mm / 3.39 inch for 281-656

Terminal blocks with side marking, visit www.wago.com



Using fuse plugs with rail-mount terminal blocks for control circuit protection is highly advantageous because the function and wiring levels are separated:

- No additional cost for assembly and wiring
- No risk of accidental contact with live parts when disconnecting the fuse plug
- The fuse plug is completely separated from the carrier terminal block when replacing a fuse – away from current carrying parts
- The fuse plug can be removed by service personnel
- No unintentional reclosing of the circuit by another person
- Quickly exchange a fuse by using a prepared “stand-by plug”

Fuse plug features for quick and safe applications:

- Optional LED indicates blown fuse
- Top-of-unit marking slot provides clear carrier terminal block identification
- Two test slots with touch contacts
- Terminal blocks/plugs provide high-density wiring in a width of just 6 mm
- May be used as a disconnect plug in combination with a shorting link

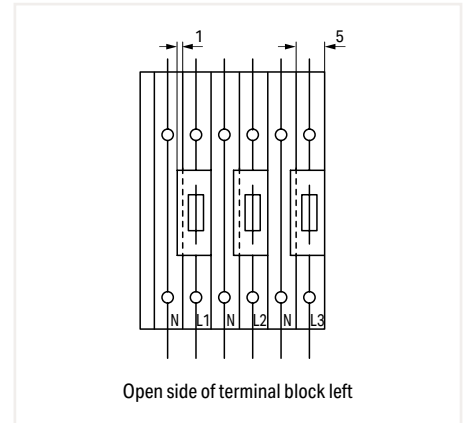

When a corresponding neutral circuit is adjacent to the fuse plug, a 5 mm wide space-saving terminal block may be used, as a 6 mm wide fuse plug may overlap the terminal block (see diagram).

For example, 5 mm (0.197 inch) wide carrier terminal blocks can be used with an end plate.

Fuse Plug on Carrier Terminal Block 2.5 mm² 280 Series

Technical Data

125 V / I_N 5 A ④

Plug width: 5 mm / 0.197 inch



280-850

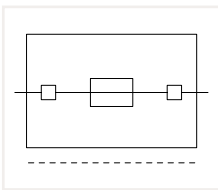

Fuse plug; with soldered miniature fuse; 5 mm wide; gray
Electrical ratings are given by the fuse.

	Item No.	Pack. Unit
○ 250 mA FF	280-850	100
○ 500 mA FF	280-852	100
○ 1 A FF	280-854	100
○ 2 A FF	280-856	100

Technical Data

125 V / I_N 5 A ④

Plug width: 5 mm / 0.197 inch



280-850/281-413

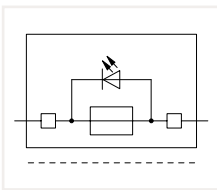

Fuse plug; with soldered miniature fuse; with additional indicator lamp; red LED; 15 ... 30 VDC; 5 mm wide; gray
Electrical ratings are given by the fuse and blown fuse indication. Leakage current in case of a blown fuse: LED 5 ... 20 mA

	Item No.	Pack. Unit
○ 250 mA FF	280-850/281-413	100
○ 500 mA FF	280-852/281-413	100
○ 1 A FF	280-854/281-413	100
○ 2 A FF	280-856/281-413	100

*12 AWG: THHN, THWN

④ Electrical ratings are given by the fuse or LED nominal voltage (see page 308).

Please observe the application notes:
Marking, from page 588

Approvals and corresponding ratings,
visit www.wago.com

Accessories; for fuse plugs

Appropriate marking system:
WMB

WMB marking card; white; 10 strips with 10 markers/card; stretchable 5 ... 5.2 mm

	plain	793-5501	5
--	-------	----------	---

WMB marking card; plain; 10 strips with 10 markers/card; stretchable 5 ... 5.2 mm

	yellow	793-5501/000-002	5
	red	793-5501/000-005	5
	blue	793-5501/000-006	5
	gray	793-5501/000-007	5
	orange	793-5501/000-012	5
	light green	793-5501/000-017	5
	green	793-5501/000-023	5
	violet	793-5501/000-024	5

Accessories; for fuse plugs

Appropriate marking system: WMB

2-conductor carrier terminal block;
0.08 ... 2.5 mm² / 28 ... 12 AWG*
Terminal block width: 5 mm / 0.197 inch

gray	280-916	100
------	---------	-----



End and intermediate plate; 2.5 mm thick

orange	280-309	100 (25)
gray	280-308	100 (25)



3-conductor carrier terminal block;
0.08 ... 2.5 mm² / 28 ... 12 AWG*
Terminal block width: 5 mm / 0.197 inch

gray	280-610	100
------	---------	-----



End and intermediate plate; 2.5 mm thick

orange	280-326	100 (25)
gray	280-324	100 (25)



4-conductor carrier terminal block;
0.08 ... 2.5 mm² / 28 ... 12 AWG*
Terminal block width: 5 mm / 0.197 inch

gray	280-816	100
------	---------	-----



End and intermediate plate; 2.5 mm thick

orange	280-315	100 (25)
gray	280-314	100 (25)



Comb-style jumper bar; insulated; I_N = I_N of terminal block

2-way	280-482	200 (25)
3-way	280-483	200 (25)



Comb-style jumper bar; insulated; I_N = I_N of terminal block

10-way	280-490	50 (25)
--------	---------	---------



Alternate comb-style jumper bar; insulated; I_N = I_N of terminal block

2-way	280-492	200 (25)
-------	---------	----------



Operating tool; insulated

2-way	280-432	1
3-way	280-433	1



Operating tool; insulated

10-way	280-440	1
--------	---------	---



Wire commoning chain; insulated; 50 connections; I_N 8 A

black	210-103	5
-------	---------	---



Wire commoning chain; insulated; 50 connections; I_N 8 A

blue	210-123	5
------	---------	---



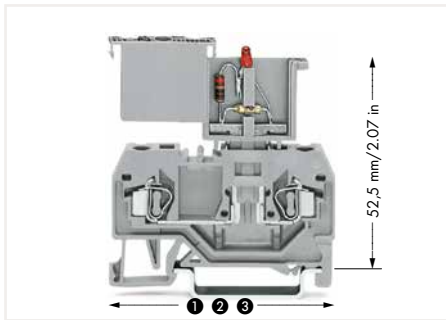

Length of carrier terminal blocks with a fuse plug:

- ❶ 53 mm / 2.09 inch for 280-916
- ❷ 64 mm / 2.52 inch for 280-610
- ❸ 75 mm / 2.95 inch for 280-816

Terminal blocks with side marking, visit www.wago.com

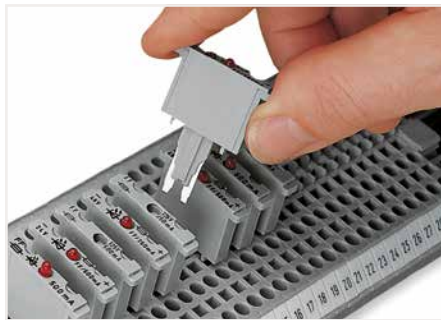

Using fuse plugs with rail-mount terminal blocks (280/281 and 769 Series) for control circuit protection is highly advantageous because the function and wiring levels are separated:

- No additional cost for assembly and wiring
- No risk of accidental contact with live parts when disconnecting the fuse plug
- Quick plug replacement in case of a blown fuse
- The fuse plug can be removed by service personnel
- No unintentional reclosing of the circuit by another person
- Terminal blocks/plugs provide ultra high-density wiring in a width of just 5 mm
- Optional LED indicates blown fuse

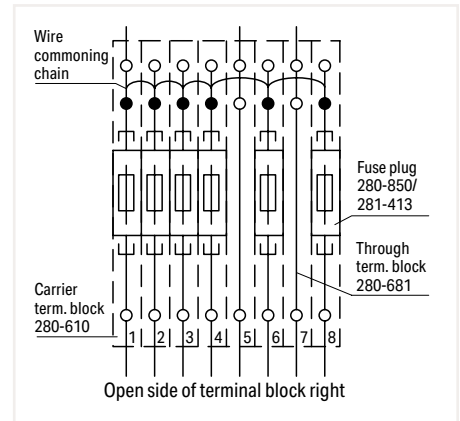

Fuse protection of individual outputs – supply via wire commoning chain

Fuse Terminal Block for 10 x 38 mm (1 3/32" x 1 1/2") Cylindrical Fuses and Class CC Fuses 16 mm²; 811 Series

Technical Data

2.5 ... 16 mm ²	14 ... 6 AWG
1000 VDC, 32 A	1000 VDC, 30 AⓈ

Terminal block width: 17.5 mm / 0.689 inch

12 ... 13 mm / 0.47 ... 0.51 inch

Technical Data

2.5 ... 16 mm ²	14 ... 6 AWG
690 VAC, 32 A	600 VAC, 30 AⓈ
1000 VDC, 32 A	750 VAC, 30 AⓈ
	1000 VDC, 30 AⓈⓈ

Terminal block width: 17.5 mm / 0.689 inch

12 ... 13 mm / 0.47 ... 0.51 inch

Technical Data

2.5 ... 16 mm ²	14 ... 6 AWG
	600 V, 30 AⓈ
	600 V, 30 AⓈ

Terminal block width: 17.5 mm / 0.689 inch

12 ... 13 mm / 0.47 ... 0.51 inch



Dimensions (in mm):

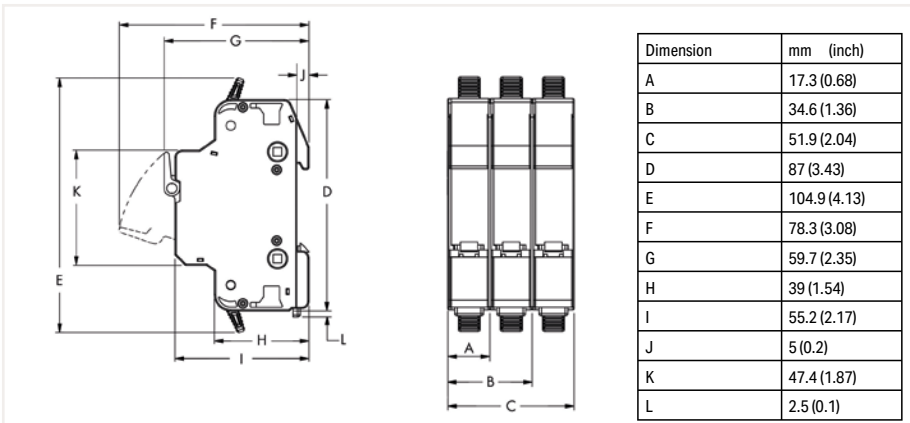

Fuse terminal block for 10 x 38 mm (1 3/32" x 1 1/2") cylindrical fuses; for photovoltaic applications; without blown fuse indication; for DIN-35 rail per EN 60715; light gray

Pole No.	Item No.	Pack. Unit
○ 1-pole	811-316	12

Fuse terminal block for 10 x 38 mm (1 3/32" x 1 1/2") cylindrical fuses; without blown fuse indication; for DIN-35 rail per EN 60715; light gray

Pole No.	Item No.	Pack. Unit
○ 1-pole	811-310	12
○ 2-pole	811-320	6
○ 3-pole	811-330	4

Fuse terminal block for class CC fuses; without blown fuse indication; for DIN-35 rail per EN 60715; light gray

Pole No.	Item No.	Pack. Unit
○ 1-pole	811-410	12
○ 2-pole	811-420	6
○ 3-pole	811-430	4

Fuse terminal block for 10 x 38 mm (1 3/32" x 1 1/2") cylindrical fuses; for photovoltaic applications; with blown fuse indication; 230 ... 1000 VDC; for DIN-35 rail; light gray

○ 1-pole	811-317	12
----------	---------	----

Fuse terminal block for 10 x 38 mm (1 3/32" x 1 1/2") cylindrical fuses; with blown fuse indication; 90 ... 600 VAC; 115 ... 600 VDC; for DIN-35 rail; light gray

○ 1-pole	811-311	12
○ 2-pole	811-321	6
○ 3-pole	811-331	4

Fuse terminal block for class CC fuses; with blown fuse indication; 90 ... 600 VAC; 115 ... 600 VDC; for DIN-35 rail; light gray

○ 1-pole	811-411	12
○ 2-pole	811-421	6
○ 3-pole	811-431	4

Fuse terminal block for 10 x 38 mm (1 3/32" x 1 1/2") cylindrical fuses; with blown fuse indication; 24 VDC; for DIN-35 rail; light gray

○ 1-pole	811-314	12
----------	---------	----

Fuse terminal block for class CC fuses; with blown fuse indication; 24 VDC; for DIN-35 rail; light gray

○ 1-pole	811-414	12
----------	---------	----

Accessories; 811 Series

Appropriate marking systems: WMB/Marking strips

Supply module; 35 mm²; 600 VAC; 1000 VDC

	811-471	16 (4)
--	---------	--------

Coupling kit; for 12 poles

	811-612	1
--	---------	---

Marker carrier; for POWER CAGE CLAMP 35/50/95 mm²; 10.4 mm wide

	gray	285-442	25
--	------	---------	----

Test plug; with 500 mm cable; 2 mm Ø; max. 42 V

	red	210-136	50
--	-----	---------	----

Screwless end stop; for DIN-35 rail; 6 mm wide

	gray	249-116	100 (25)
--	------	---------	----------

WMB Inline, plain; 1,500 WMB markers (5 mm)/reel; 5 ... 5.2 mm stretchable

	white	2009-115	1
--	-------	----------	---

Cylindrical fuses are not offered by WAGO. Temperature range: -35 ... +85 °C
Electrical ratings are given by the fuse and blown fuse indication.

Please observe the application notes:
Marking, from page 588

Approvals and corresponding ratings,
visit www.wago.com

Accessories; 811 Series

Appropriate marking systems:
WMB/Marking strips

Push-in type jumper bar; insulated; I_n 63 A



2-way	811-472	50 (10)
3-way	811-473	40 (10)
4-way	811-474	40 (10)
5-way	811-475	40 (10)
6-way	811-476	30 (10)
7-way	811-477	20 (10)
8-way	811-478	20 (10)
9-way	811-479	20 (10)
10-way	811-480	20 (10)
11-way	811-481	20 (10)
12-way	811-482	20 (10)

WMB marking card; white; 10 strips with 10 markers/card; stretchable 5 ... 5.2 mm

plain	793-5501	5
-------	----------	---

WMB marking card; plain; 10 strips with 10 markers/card; stretchable 5 ... 5.2 mm



yellow	793-5501/000-002	5
red	793-5501/000-005	5
blue	793-5501/000-006	5
gray	793-5501/000-007	5
orange	793-5501/000-012	5
light green	793-5501/000-017	5
green	793-5501/000-023	5
violet	793-5501/000-024	5

Twin ferrule only for 811 Series; insulated; 12 mm long



Sleeve for 2 x 2.5 mm ² / 14 AWG	216-545	100
Sleeve for 2 x 4 mm ² / 12 AWG	216-546	100
Sleeve for 2 x 6 mm ² / 10 AWG	216-547	100

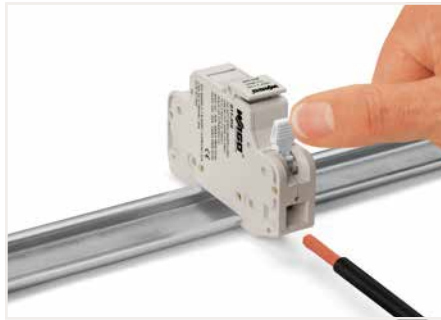

CAGE CLAMP® connection
Inserting a conductor.
Opening the clamping unit via integrated lever.



Terminating ferruled conductors up to 10 mm² (8 AWG).



Inserting a fuse.



Removing a terminal block from the DIN-rail.



Open and close lever via operating tool.



Marker carriers (285-442) for continuous marking strips



WMB marking location for convenient identification



Jumper bar for quick and convenient commoning



Creating a 2- or 3-pole fuse terminal block via coupling kit.

Application Notes on Terminal Blocks for Glass Cartridge Fuses

Terminal Blocks for Glass Cartridge Fuses Tested per IEC or EN 60947-7-3/VDE 0611-6

When selecting glass cartridge fuses, make sure that the maximum power loss listed below is not exceeded.

The power loss is determined according to IEC or EN 60947-7-3/VDE 0611-6 at 23°C.

The temperature rise of the terminal blocks must be checked according to their application and mounting.

Higher ambient temperatures represent an additional impact on fuse cartridges. Therefore, in such applications, the rated current must be reduced if necessary.

More details are available from the manufacturers.

Glass Cartridge Fuses (5 x 20 mm)

Series Item No.	Overload and Short-Circuit Protection		Short-Circuit Protection Only	
	Individual Arrangement	Block Arrangement	Individual Arrangement	Block Arrangement
Fuse terminal blocks (with screw cap), front-entry (5 x 20 mm)				
282-122	2.5 W	2.5 W	4 W	4 W
282-124				
Fused disconnect terminal block with a pivoting fuse holder for glass cartridge fuses (5 x 20 mm)				
281-611	2.5 W	1.6 W	4 W	4 W
281-616				
281-611/281-541				
281-611/281-542				
281-611/281-417				
281-611/281-418				
Fuse plugs for glass cartridge fuses (5 x 20 mm)				
281-511	2.5 W	1.6 W	4 W	4 W
281-512				
281-512/281-501				
281-512/281-418				
281-512/281-417				

5

Glass Cartridge Fuses (6.3 x 32 mm)

Series Item No.	Overload and Short-Circuit Protection		Short-Circuit Protection Only	
	Individual Arrangement	Block Arrangement	Individual Arrangement	Block Arrangement
Fuse terminal blocks (with screw cap), front-entry (1/4" x 1 1/4" ≈ 6.3 x 32 mm)				
282-128 282-128/281-418 282-128/281-413 282-128/281-417	2.5 W	2.5 W	4 W	4 W
Fused disconnect terminal block with a pivoting fuse holder for glass cartridge fuses (1/4" x 1 1/4" ≈ 6.3 x 32 mm)				
281-623 281-623/281-541 281-623/281-542 281-623/281-417 281-623/281-418	2.5 W	1.6 W	4 W	2.5 W

Individually arranged fuse terminal blocks

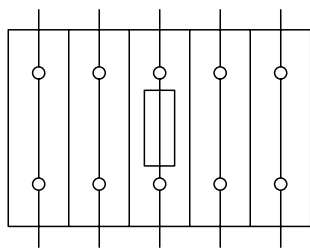

Terminal block assembly including one fuse terminal block and through terminal blocks

Fuse terminal block in a group

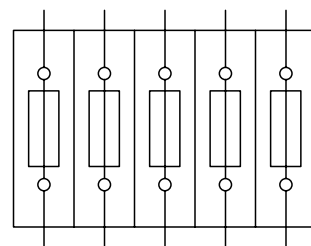

Terminal block assembly including five fuse terminal blocks

Sensor Terminal Blocks and Actuator Terminal Blocks

280 Series

Description and Installation

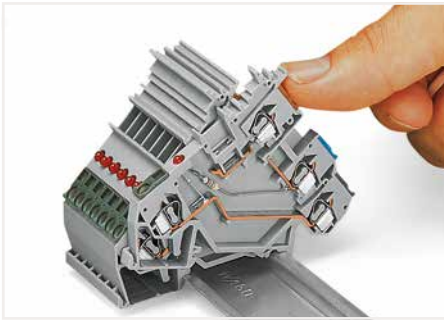

Snapping a terminal block onto the DIN-rail. Terminal blocks with a grounding foot automatically establish a direct contact to the rail.

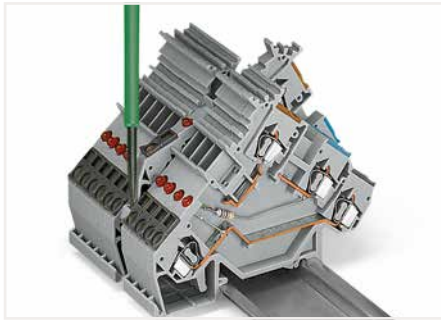

Removing a terminal block from the DIN-rail. Notice: Remove jumper contacts first.

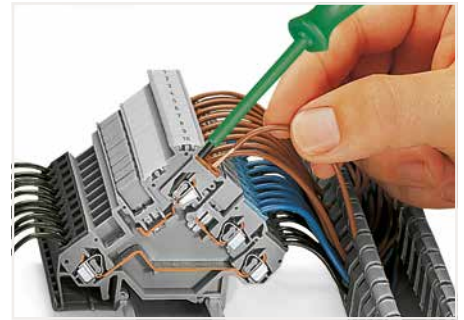

CAGE CLAMP® connection
Inserting a conductor via straight operating tool (210-720).

5

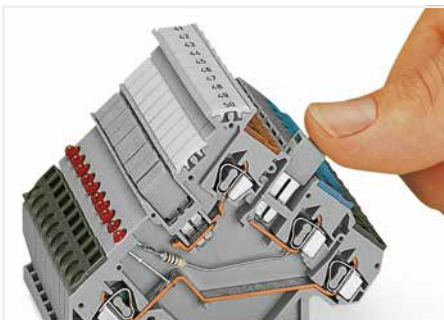

Commoning using an adjacent jumper (280-402). Push jumper down until fully inserted.

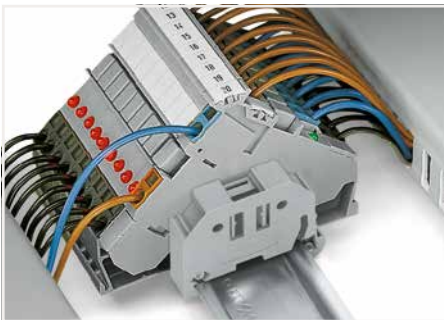
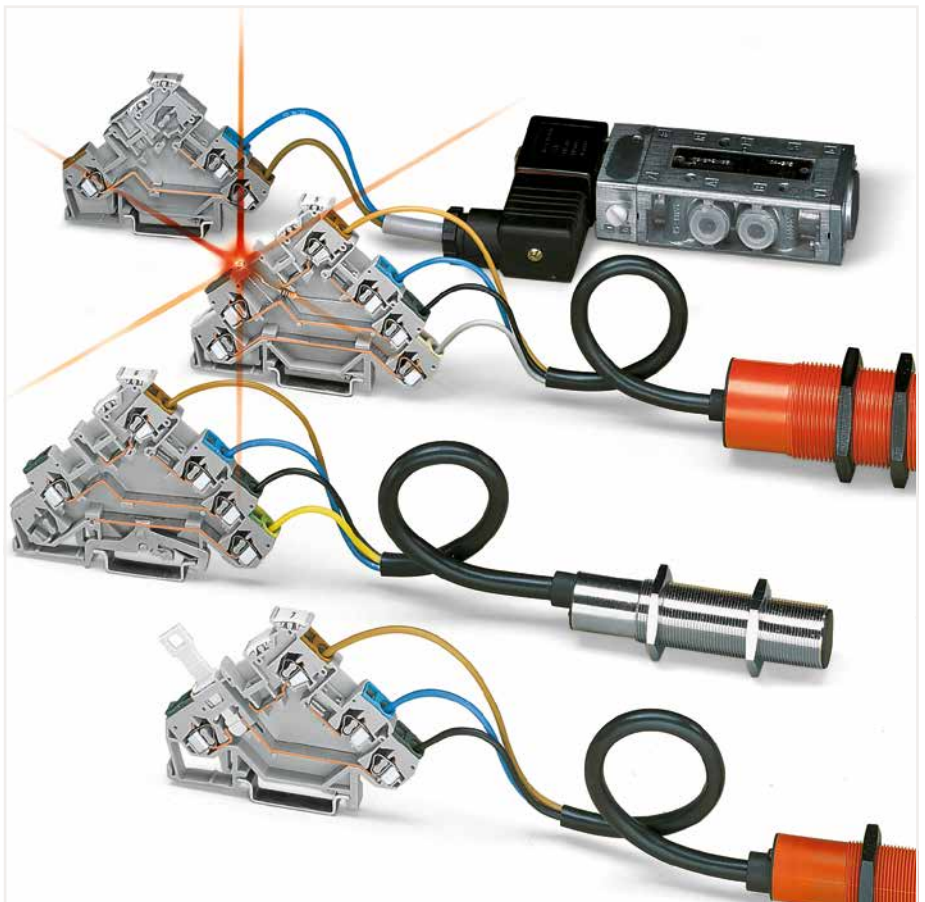

Sensor terminal blocks
Power supply from control panel side



Sensor terminal blocks
Power supply from sensor side



Actuator terminal block; with shield connection; with a thermocouple



CAGE CLAMP® terminates the following copper conductors: solid



stranded



fine-stranded, also with tinned single strands

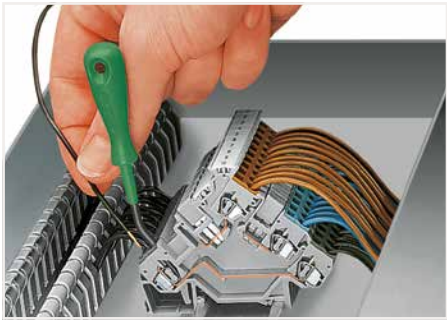

CAGE CLAMP® connection
Inserting a conductor via angled operating tool (210-658).

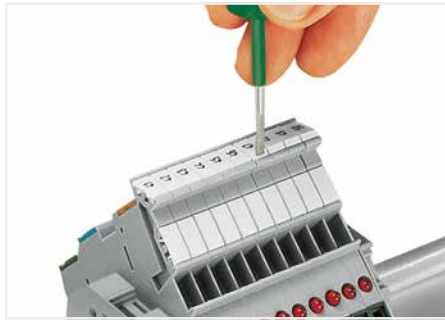

Labeling via WMB Multi Marking System.

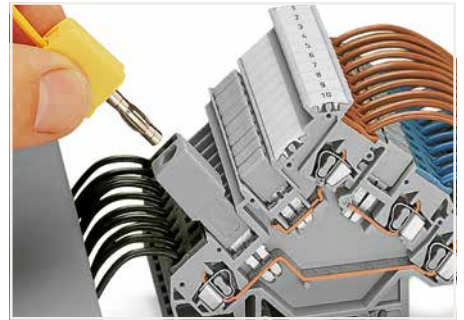

Testing via banana plug and test plug adapter (209-170).

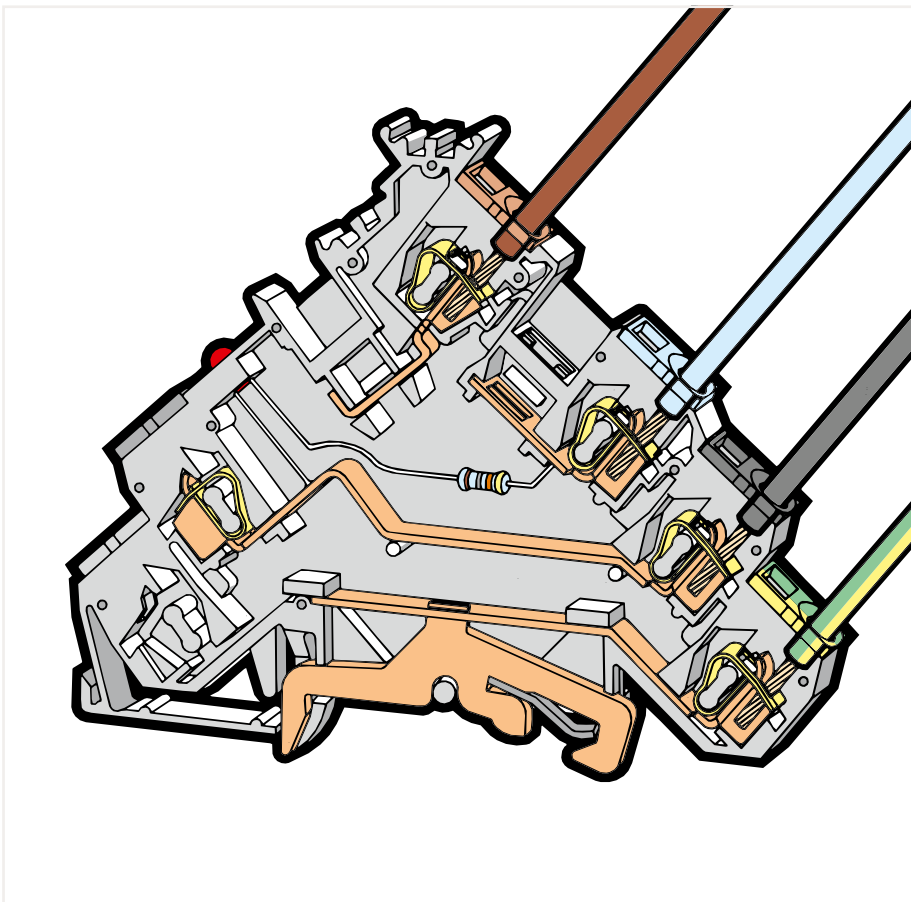

Testing via voltage tester directly on the current bar.



Actuator terminal blocks with fuse holders (281-511) – intermediate plates are required!



Actuator terminal block with thermocouple

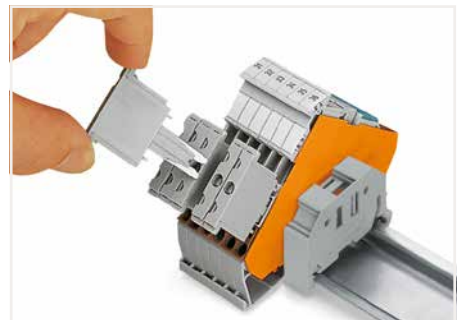

Actuator terminal blocks with component plugs (280 801)



fine-stranded,
tip-bonded



fine-stranded,
with ferrule
(gastight crimped)



fine-stranded,
with pin terminal
(gastight crimped)

Sensor terminal block; for 3-conductor sensors 2.5 mm²; 280 Series

Technical Data	
0.08 ... 2.5 mm ²	28 ... 12 AWG*
400 V/6 kV/3 ①	300 V, 15 A ②
I _N 20 A	300 V, 15 A ③
Terminal block width: 5 mm / 0.197 inch	
8 ... 9 mm / 0.31 ... 0.35 inch	

Technical Data	
0.08 ... 2.5 mm ²	28 ... 12 AWG*
250 V/4 kV/3 ①	300 V, 6 A ②
I _N 6 A	300 V, 15 A ③
Terminal block width: 5 mm / 0.197 inch	
8 ... 9 mm / 0.31 ... 0.35 inch	

Technical Data	
0.08 ... 2.5 mm ²	28 ... 12 AWG*
400 V/6 kV/3 ①	300 V, 10 A ②
I _N 10 A	300 V, 15 A ③
Terminal block width: 5 mm / 0.197 inch	
8 ... 9 mm / 0.31 ... 0.35 inch	

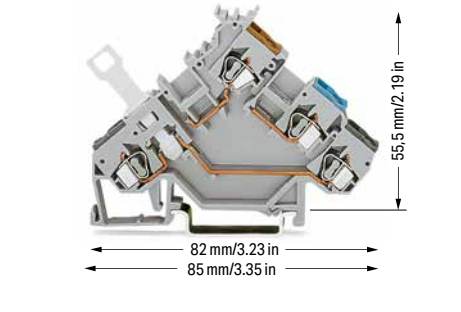
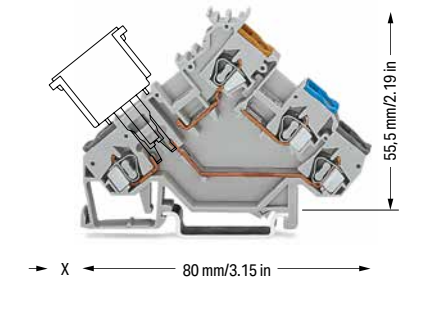
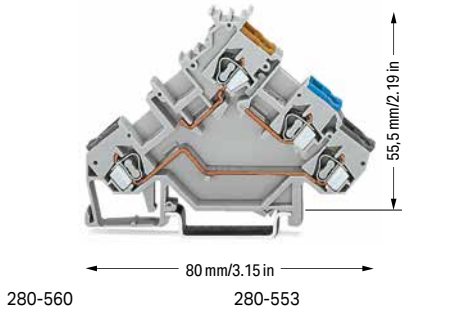

Sensor terminal block		
Color	Item No.	Pack. Unit
gray	280-560	50
gray	280-553	50

Sensor terminal block; for component plugs		
Color	Item No.	Pack. Unit
gray	280-561 ③	50

Sensor disconnect terminal block; for signal interruption		
Color	Item No.	Pack. Unit
gray	280-563	50

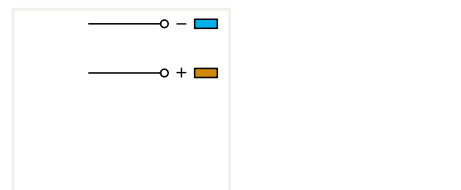
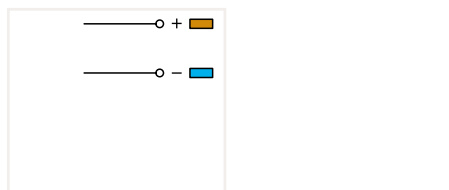
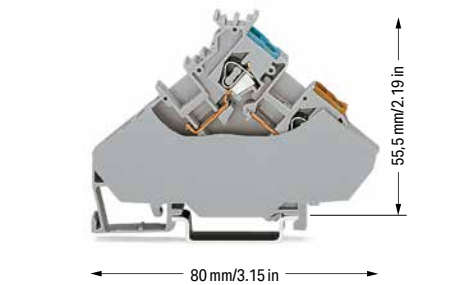
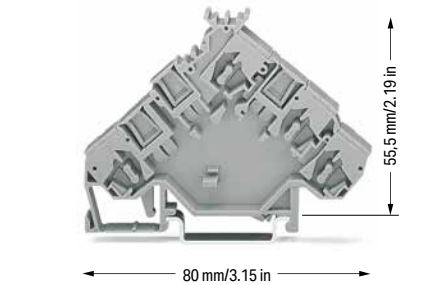
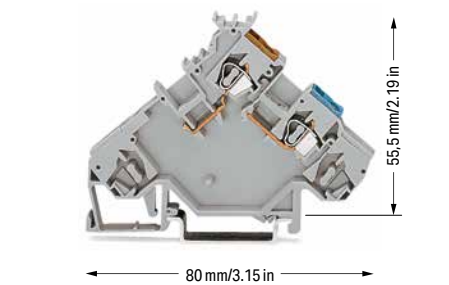

Sensor supply terminal block; power supply from sensor side		
Color	Item No.	Pack. Unit
gray	280-564	10

Spacer; same profile as 3-conductor sensor terminal blocks or corresponding actuator terminal blocks Spacers with the same profile clearly differentiate between sensor or actuator terminal groups, e.g., of different power supply.		
Color	Item No.	Pack. Unit
gray	280-559	50

Sensor supply terminal block; power supply from control panel side; with end plate Terminal block width: 6 mm / 0.236 inch		
Color	Item No.	Pack. Unit
gray	280-567	20

Technical Data	
400 V/6 kV/3	I _N 20 A

5

*12 AWG: THHN, THWN

- 1 400 V / 250 V = rated voltage
6 kV / 4 kV = rated impulse voltage
3 = pollution degree
(see Section 14)
- 2 Electrical ratings are given by the fuse plug or empty component plug housing.
- 3 Empty component plug housings, see Full Line Catalog, Interface Modules, Volume 4
x = 12 mm/0.472 inch
Fuse plug (280-850), see page 304
x = 20 mm/0.787 inch

Please observe the application notes:
Insulation stop, see page 346
Marking, from page 588

Approvals and corresponding ratings,
visit www.wago.com





Sensor terminal block paired with a 3-conductor sensor

Accessories; 280 Series

Appropriate marking system:
WMB

End and intermediate plate; 1 mm thick; for triple-deck terminal blocks

	orange	280-321	100 (25)
	gray	280-319	100 (25)

Insulation stop; 0.08 ... 0.2 mm² "s" (0.14 mm² "f-st"); 5 pcs/strip

	white	280-470	200 (25)
---	-------	---------	----------

Insulation stop; 0.25 ... 0.5 mm²; 5 pcs/strip

	light gray	280-471	200 (25)
---	------------	---------	----------

Insulation stop; 0.75 ... 1 mm²; 5 pcs/strip

	dark gray	280-472	200 (25)
---	-----------	---------	----------

Adjacent jumper; insulated; I_N = I_N terminal block

	gray	280-402	200 (25)
---	------	---------	----------

Screwless end stop; for DIN-35 rail; 6 mm wide

	gray	249-116	100 (25)
---	------	---------	----------

Screwless end stop; for DIN-35 rail; 10 mm wide

	gray	249-116	50 (25)
---	------	---------	---------

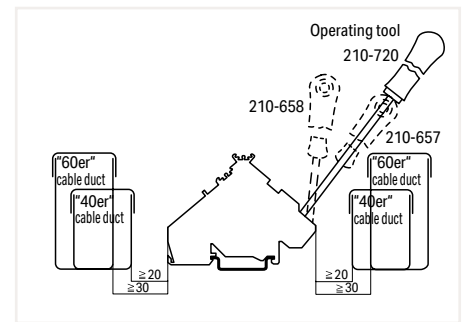

Min. mounting distance – terminal blocks to cable duct

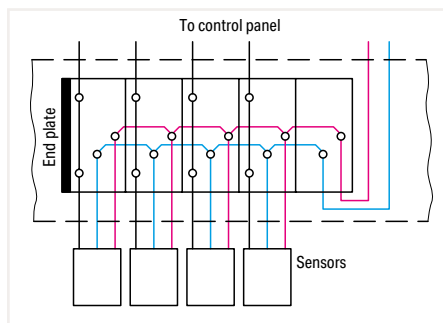

Power supply from sensor side

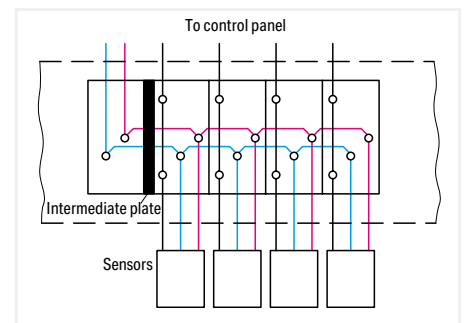

Power supply from control panel side

Sensor LED Terminal Block; for 3-Conductor Sensors

2.5 mm²; 280 Series

Technical Data

0.08 ... 2.5 mm ²	28 ... 12 AWG*
24 VDC ①	24 V, 15 A
20 A	300 V, 15 A
Terminal block width: 5 mm / 0.197 inch	
8 ... 9 mm / 0.31 ... 0.35 inch	

Technical Data

0.08 ... 2.5 mm ²	28 ... 12 AWG*
24 VDC ①	24 V, 15 A
20 A	300 V, 15 A
Terminal block width: 5 mm / 0.197 inch	
8 ... 9 mm / 0.31 ... 0.35 inch	

*12 AWG: THHN, THWN

① Other voltages are available upon request.

Please observe the application notes:
Insulation stop, see page 346
Marking, from page 588

Approvals and corresponding ratings, visit www.wago.com

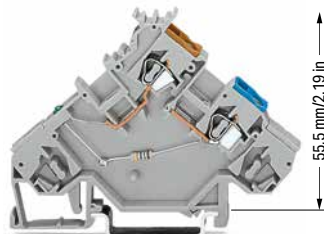
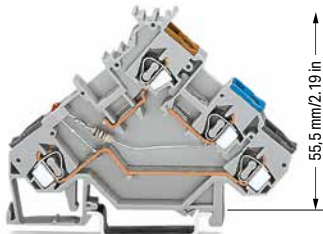

80 mm/3.15 in

80 mm/3.15 in

280-560/281-434

280-561/281-413

280-564/281-483

280-566/281-496

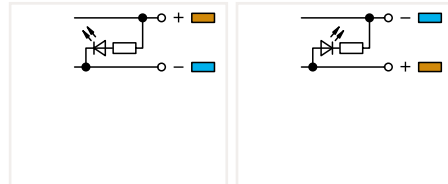
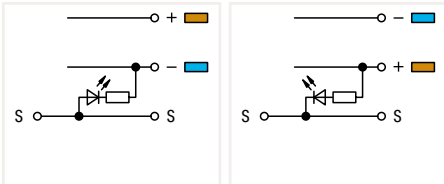

Sensor LED terminal block; for PNP (high-side) switching sensors; red LED; LED power consumption: 4.8 mA

Color	Item No.	Pack. Unit
gray	280-560/281-434	50

Sensor LED supply terminal block; power supply from sensor side; for PNP (high-side) switching sensors; green LED; LED power consumption: 4.8 mA

Color	Item No.	Pack. Unit
gray	280-564/281-483	10

Sensor LED terminal block; for NPN (low-side) switching sensors; red LED; LED power consumption: 4.8 mA

Color	Item No.	Pack. Unit
gray	280-561/281-413	50

Sensor LED supply terminal block; power supply from sensor side; for NPN (low-side) switching sensors; green LED; LED power consumption: 4.8 mA

Color	Item No.	Pack. Unit
gray	280-566/281-496	10

Accessories; 280 Series

Appropriate marking system: WMB

End and intermediate plate; 1 mm thick; for triple-deck terminal blocks

Color	Item No.	Pack. Unit
orange	280-321	100 (25)
gray	280-319	100 (25)

Insulation stop; 0.08 ... 0.2 mm² "s" (0.14 mm² "f-st"); 5 pcs/strip

Color	Item No.	Pack. Unit
white	280-470	200 (25)

Insulation stop; 0.25 ... 0.5 mm²; 5 pcs/strip

Color	Item No.	Pack. Unit
light gray	280-471	200 (25)

Insulation stop; 0.75 ... 1 mm²; 5 pcs/strip

Color	Item No.	Pack. Unit
dark gray	280-472	200 (25)

Adjacent jumper; insulated; I_N = I_N terminal block

Color	Item No.	Pack. Unit
gray	280-402	200 (25)

Screwless end stop; for DIN-35 rail; 6 mm wide

Color	Item No.	Pack. Unit
gray	249-116	100 (25)

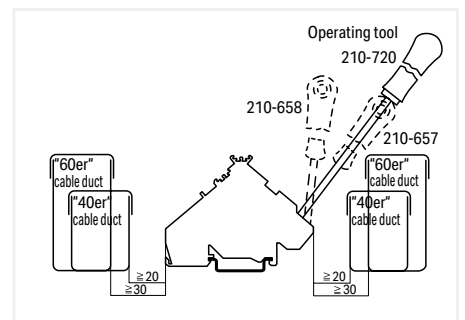
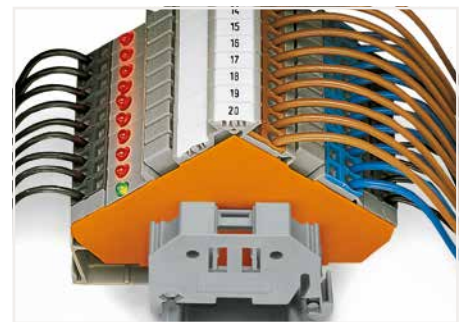

Min. mounting distance – terminal blocks to cable duct

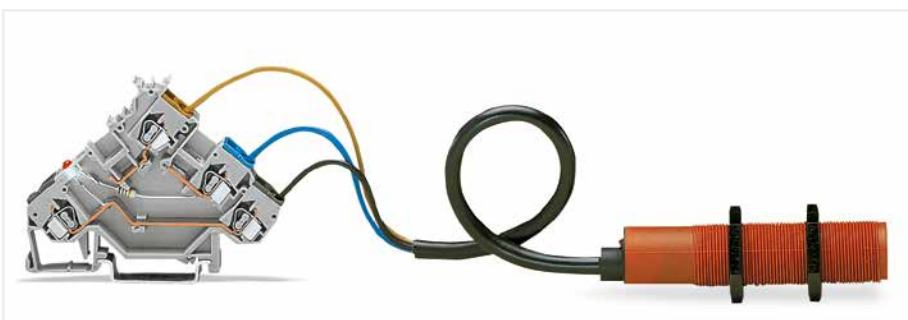

Sensor LED terminal block with a 3-conductor sensor

Sensor LED Terminal Block; for 4-Conductor Sensors

2.5 mm²; 280 Series

Technical Data	
0.08 ... 2.5 mm ²	28 ... 12 AWG*
24 VDC ①	24 V, 15 A
20 A	300 V, 15 A
Terminal block width: 5 mm / 0.197 inch	
8 ... 9 mm / 0.31 ... 0.35 inch	

Technical Data	
0.08 ... 2.5 mm ²	28 ... 12 AWG*
24 VDC ①	24 V, 15 A
20 A	300 V, 15 A
Terminal block width: 5 mm / 0.197 inch	
8 ... 9 mm / 0.31 ... 0.35 inch	

*12 AWG: THHN, THWN

① Other voltages are available upon request.

Please observe the application notes:
Insulation stop, see page 346
Marking, from page 588

Approvals and corresponding ratings, visit www.wago.com

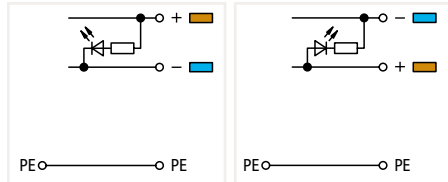
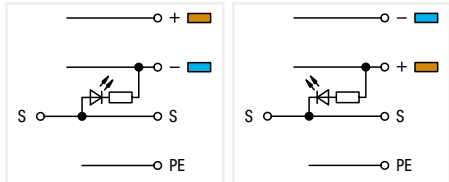
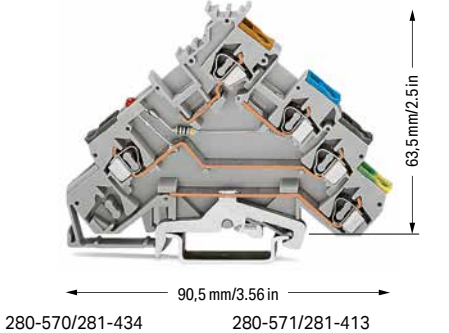

Sensor LED terminal block; for PNP (high-side) switching sensors; red LED; LED power consumption: 4.8 mA

Sensor LED supply terminal block; power supply from sensor side; for PNP (high-side) switching sensors; green LED; LED power consumption: 4.8 mA

Color	Item No.	Pack. Unit
○ gray	280-570/281-434	50

Color	Item No.	Pack. Unit
○ gray	280-574/281-483	10

Sensor LED terminal block; for NPN (low-side) switching sensors; red LED; LED power consumption: 4.8 mA

Sensor LED supply terminal block; power supply from sensor side; for NPN (low-side) switching sensors; green LED; LED power consumption: 4.8 mA

Color	Item No.	Pack. Unit
○ gray	280-571/281-413	50

Color	Item No.	Pack. Unit
○ gray	280-576/281-496	10

Sensor LED supply terminal block; power supply from control panel side; for PNP (high-side) switching sensors; green LED; LED power consumption: 4.8 mA

Color	Item No.	Pack. Unit
○ gray	280-577/281-496	20



5

Accessories; 280 Series

Appropriate marking system: WMB

End and intermediate plate; 1 mm thick; for quadruple-deck terminal blocks

	orange	280-323	100 (25)
	gray	280-320	100 (25)

Insulation stop; 0.25 ... 0.5 mm²; 5 pcs/strip

	light gray	280-471	200 (25)
--	------------	---------	----------

Insulation stop; 0.08 ... 0.2 mm² "s" (0.14 mm² "f-st"); 5 pcs/strip

	white	280-470	200 (25)
--	-------	---------	----------

Insulation stop; 0.75 ... 1 mm²; 5 pcs/strip

	dark gray	280-472	200 (25)
--	-----------	---------	----------

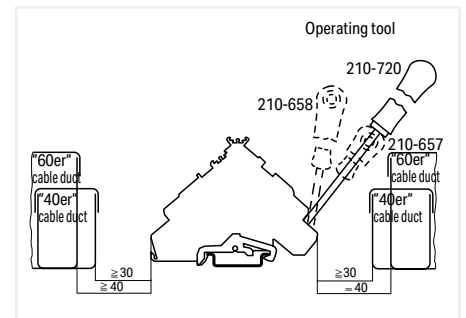

Min. mounting distance – terminal blocks to cable duct

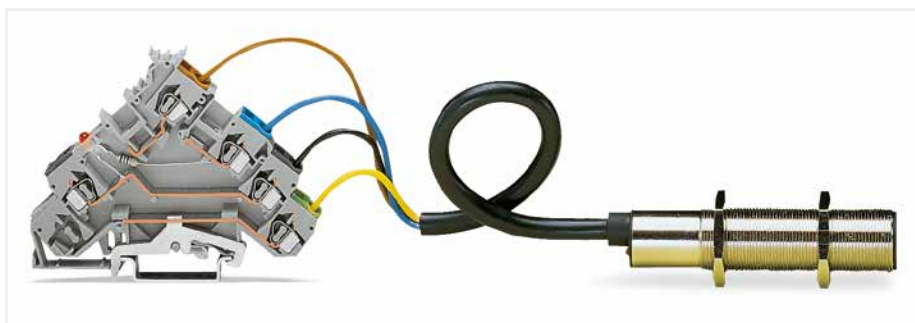

Sensor LED terminal block paired with a 3-conductor sensor (ground connection)

Sensor terminal block; with ground connection; for 3-conductor sensors 2.5 mm²; 280 Series

Technical Data	
0.08 ... 2.5 mm ²	28 ... 12 AWG*
400 V/6 kV/3 ①	300 V, 15 A ②
I _N 20 A	300 V, 15 A ③
Terminal block width: 5 mm / 0.197 inch	
8 ... 9 mm / 0.31 ... 0.35 inch	

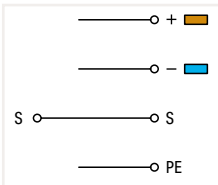
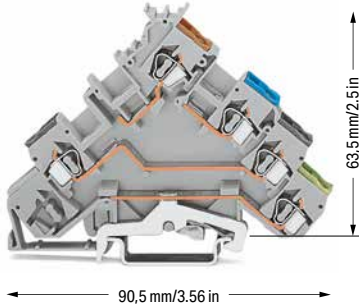

Sensor terminal block; with ground connection

Color	Item No.	Pack. Unit
○ gray	280-570	50

Technical Data	
0.08 ... 2.5 mm ²	28 ... 12 AWG*
250 V/4 kV/3 ①	300 V, 6 A ②
I _N 6 A	300 V, 15 A ③
Terminal block width: 5 mm / 0.197 inch	
8 ... 9 mm / 0.31 ... 0.35 inch	

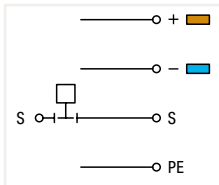
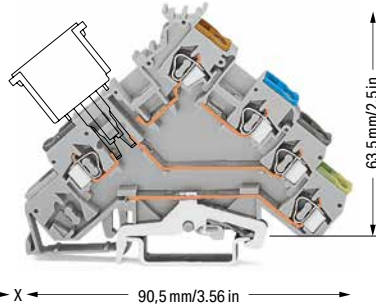

Sensor terminal block; with ground connection; for component plugs

Color	Item No.	Pack. Unit
○ gray	280-571 ④	50

Technical Data	
0.08 ... 2.5 mm ²	28 ... 12 AWG*
400 V/6 kV/3 ①	300 V, 10 A ②
I _N 10 A	300 V, 15 A ③
Terminal block width: 5 mm / 0.197 inch	
8 ... 9 mm / 0.31 ... 0.35 inch	

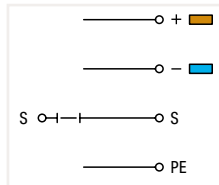
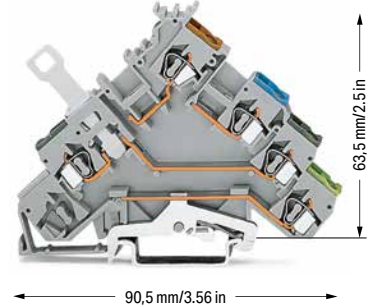

Sensor disconnect terminal block; with ground connection; for signal interruption

Color	Item No.	Pack. Unit
○ gray	280-573	50

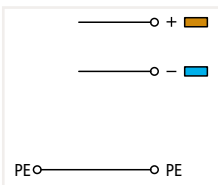
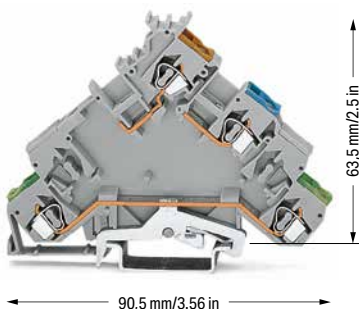

Sensor supply terminal block; with ground connection; power supply from sensor side

Color	Item No.	Pack. Unit
○ gray	280-574	10

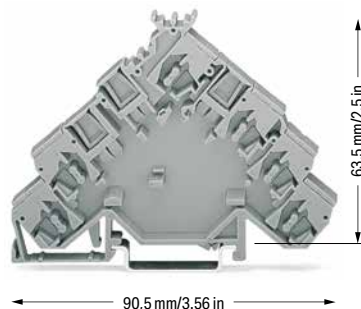

Spacer; same profile as 4-conductor sensor terminal blocks; 3-conductor sensor terminal blocks with ground connection or corresponding actuator terminal blocks. Spacers with the same profile clearly differentiate between sensor or actuator terminal groups, e.g., of different power supply.

Color	Item No.	Pack. Unit
○ gray	280-582	50

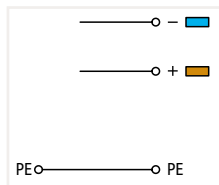
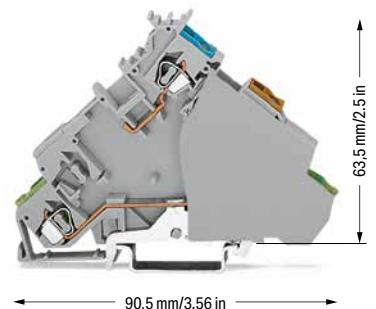

Sensor supply terminal block; with ground connection; power supply from control panel side; with end plate. Terminal block width: 6 mm / 0.236 inch

Color	Item No.	Pack. Unit
○ gray	280-577	20

Technical Data	
400 V/6 kV/3	I _N 20 A

5

*12 AWG: THHN, THWN

- 1 400 V / 250 V = rated voltage
6 kV / 4 kV = rated impulse voltage
3 = pollution degree
(see Section 14)
- 2 Electrical ratings are given by the fuse plug or empty component plug housing.
- 3 Empty component plug housings, see Full Line Catalog, Interface Modules, Volume 4
x = 12 mm/0.472 inch
Fuse plug (280-850), see page 304
x = 20 mm/0.787 inch

Please observe the application notes:
Insulation stop, see page 346
Marking, from page 588

Approvals and corresponding ratings,
visit www.wago.com

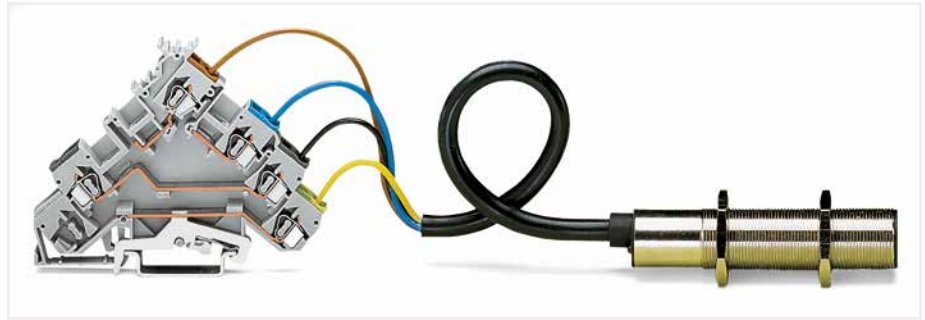

Sensor terminal block paired with a 3-conductor sensor

Accessories; 280 Series

Appropriate marking system:
WMB

End and intermediate plate; 1 mm thick; for quadruple-deck terminal blocks

	orange	280-323	100 (25)
	gray	280-320	100 (25)

Insulation stop; 0.08 ... 0.2 mm² "s" (0.14 mm² "f-st"); 5 pcs/strip

	white	280-470	200 (25)
---	-------	---------	----------

Insulation stop; 0.25 ... 0.5 mm²; 5 pcs/strip

	light gray	280-471	200 (25)
---	------------	---------	----------

Insulation stop; 0.75 ... 1 mm²; 5 pcs/strip

	dark gray	280-472	200 (25)
---	-----------	---------	----------

Adjacent jumper; insulated; I_N = I_N terminal block

	gray	280-402	200 (25)
---	------	---------	----------

Screwless end stop; for DIN-35 rail; 6 mm wide

	gray	249-116	100 (25)
---	------	---------	----------

Screwless end stop; for DIN-35 rail; 10 mm wide

	gray	249-116	50 (25)
---	------	---------	---------

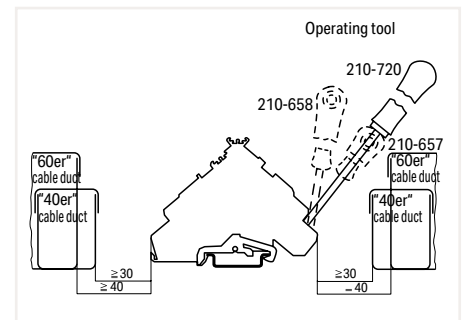

Min. mounting distance – terminal blocks to cable duct

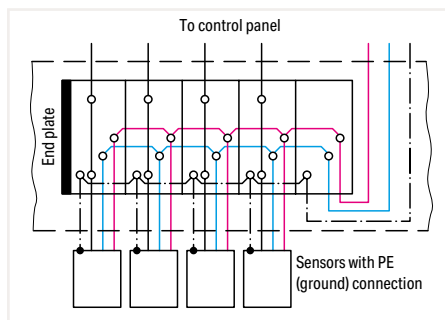

Power supply from sensor side

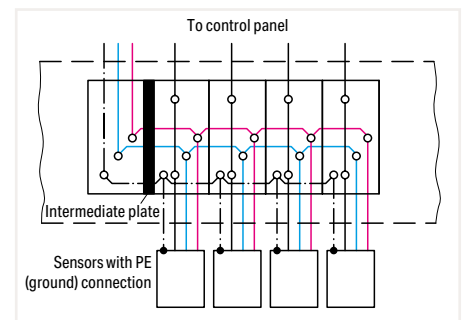

Power supply from control panel side

Sensor terminal block; for 4-conductor sensors 2.5 mm²; 280 Series

Technical Data	
0.08 ... 2.5 mm ²	28 ... 12 AWG*
400 V/6 kV/3 ①	300 V, 15 A ②
I _N 20 A	300 V, 15 A ③
Terminal block width: 5 mm / 0.197 inch	
8 ... 9 mm / 0.31 ... 0.35 inch	

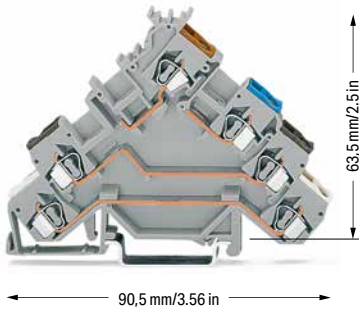

Sensor terminal block

Color	Item No.	Pack. Unit
gray	280-580	50

Technical Data	
0.08 ... 2.5 mm ²	28 ... 12 AWG*
125 V / 5 A ②	300 V, 6 A ③
250 V / 6.3 A ②	300 V, 15 A ③
Terminal block width: 5 mm / 0.197 inch	
8 ... 9 mm / 0.31 ... 0.35 inch	

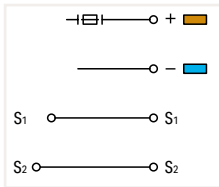
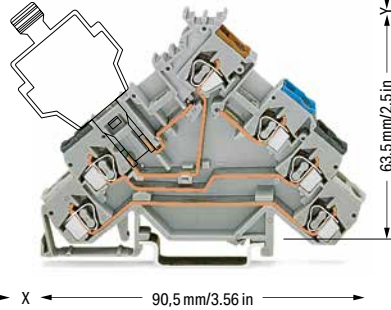

Sensor LED terminal block; for fuse plugs; for PNP (high-side) switching sensors; without end plate

Color	Item No.	Pack. Unit
gray	280-588 ④	50

Technical Data	
0.08 ... 2.5 mm ²	28 ... 12 AWG*
400 V/6 kV/3 ①	24 V, 15 A ②
I _N 10 A	300 V, 15 A ③
Terminal block width: 6 mm / 0.236 inch	
8 ... 9 mm / 0.31 ... 0.35 inch	

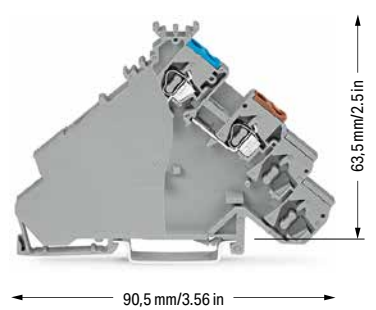

Sensor supply terminal block; power supply from control panel side; with end plate

Color	Item No.	Pack. Unit
gray	280-587	50

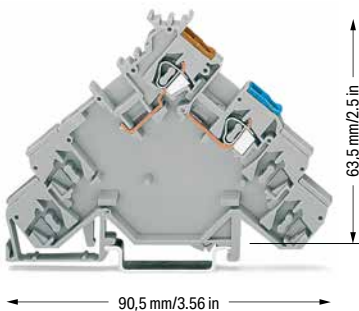

Sensor supply terminal block; power supply from sensor side; without end plate

Color	Item No.	Pack. Unit
gray	280-584	10

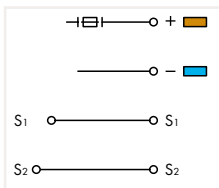
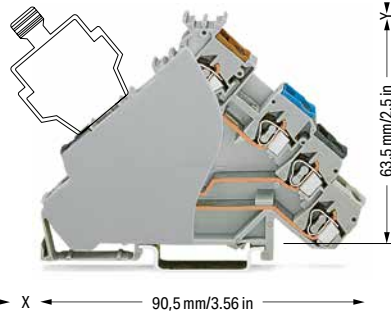

Sensor LED terminal block; for fuse plugs; for PNP (high-side) switching sensors; with gray end plate
Terminal block width: 6 mm / 0.236 inch

Color	Item No.	Pack. Unit
gray	280-588/280-320	50

Sensor LED terminal block; for fuse plugs; for PNP (high-side) switching sensors; with orange end plate
Terminal block width: 6 mm / 0.236 inch

Color	Item No.	Pack. Unit
gray	280-588/280-323	50

5

- *12 AWG: THHN, THWN
 - 1 400 V = rated voltage
6 kV = rated impulse voltage
3 = pollution degree
(see Section 14)
 - 2 Electrical ratings are given by the fuse plug or empty component plug housing.
 - 3 Empty component plug housings, see Full Line Catalog, Interface Modules, Volume 4
x = 12 mm/0.472 inch
Fuse plug (281-511), see page 302
y = 15.5 mm/0.61 inch
x = 10 mm/0.394 inch
- Please observe the application notes:
Insulation stop, see page 346
Marking, from page 588
- Approvals and corresponding ratings,
visit www.wago.com



Sensor terminal block paired with a 4-conductor sensor

Accessories; 280 Series

Appropriate marking system:
WMB

End and intermediate plate; 1 mm thick; for quadruple-deck terminal blocks

	orange	280-323	100 (25)
	gray	280-320	100 (25)

Insulation stop; 0.08 ... 0.2 mm² "s" (0.14 mm² "f-st"); 5 pcs/strip

	white	280-470	200 (25)
---	-------	---------	----------

Insulation stop; 0.25 ... 0.5 mm²; 5 pcs/strip

	light gray	280-471	200 (25)
---	------------	---------	----------

Insulation stop; 0.75 ... 1 mm²; 5 pcs/strip

	dark gray	280-472	200 (25)
---	-----------	---------	----------

Adjacent jumper; insulated; I_N = I_N terminal block

	gray	280-402	200 (25)
---	------	---------	----------

Screwless end stop; for DIN-35 rail; 6 mm wide

	gray	249-116	100 (25)
---	------	---------	----------

Screwless end stop; for DIN-35 rail; 10 mm wide

	gray	249-116	50 (25)
---	------	---------	---------

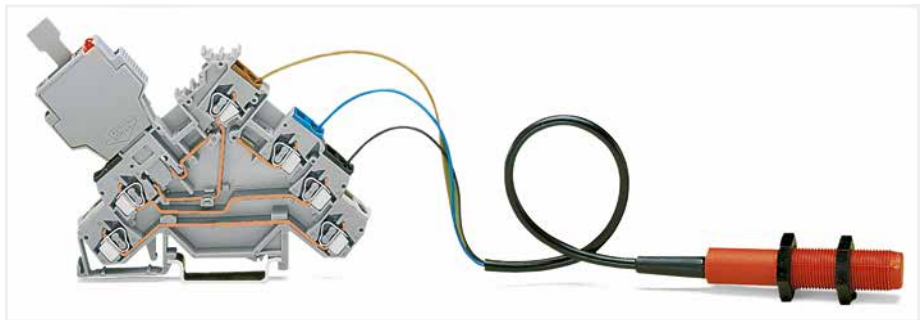

Sensor terminal block (with a fuse plug) paired with a 3-conductor sensor



The fuse plug is 1 mm wider than the terminal block, so an intermediate plate must be installed.

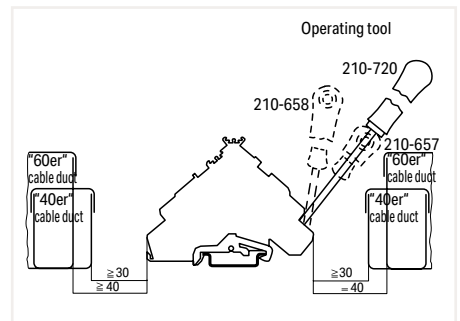

Min. mounting distance – terminal blocks to cable duct

Sensor LED Terminal Block; for 4-Conductor Sensors 2.5 mm²; 280 Series

Technical Data	
0.08 ... 2.5 mm ²	28 ... 12 AWG*
24 VDC ①	24 V, 15 A
20 A	
Terminal block width: 5 mm / 0.197 inch	
8 ... 9 mm / 0.31 ... 0.35 inch	

Technical Data	
0.08 ... 2.5 mm ²	28 ... 12 AWG*
24 VDC ①	24 V, 15 A
20 A	
Terminal block width: 5 mm / 0.197 inch	
8 ... 9 mm / 0.31 ... 0.35 inch	

*12 AWG: THHN, THWN

① Other voltages are available upon request.

Please observe the application notes:
Insulation stop, see page 346
Marking, from page 588

Approvals and corresponding ratings,
visit www.wago.com

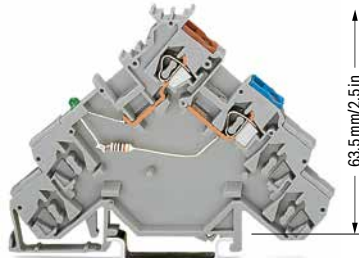
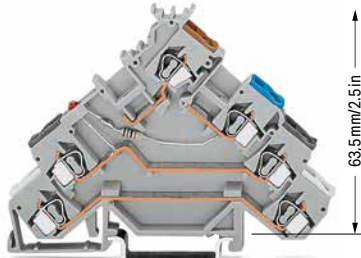

280-580/281-434 280-581/281-413

280-584/281-483 280-586/281-496

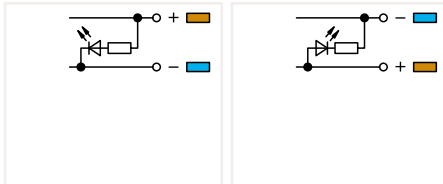
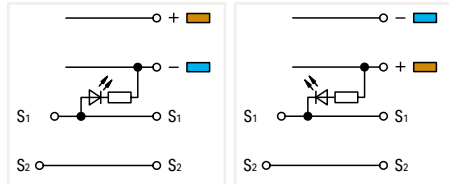

Sensor LED terminal block; for PNP (high-side) switching sensors; red LED; LED power consumption: 4.8 mA

Sensor LED supply terminal block; power supply from sensor side; for PNP (high-side) switching sensors; green LED; LED power consumption: 4.8 mA

Color	Item No.	Pack. Unit
○ gray	280-580/281-434	50

Color	Item No.	Pack. Unit
○ gray	280-584/281-483	10

Sensor LED terminal block; for NPN (low-side) switching sensors; red LED; LED power consumption: 4.8 mA

Sensor LED supply terminal block; power supply from sensor side; for NPN (low-side) switching sensors; green LED; LED power consumption: 4.8 mA

Color	Item No.	Pack. Unit
○ gray	280-581/281-413	50

Color	Item No.	Pack. Unit
○ gray	280-586/281-496	10

Accessories; 280 Series

Appropriate marking system: WMB

End and intermediate plate; 1 mm thick; for quadruple-deck terminal blocks

	orange	280-323	100 (25)
	gray	280-320	100 (25)

Insulation stop; 0.75 ... 1 mm²; 5 pcs/strip

	dark gray	280-472	200 (25)
--	-----------	---------	----------

Insulation stop; 0.08 ... 0.2 mm² "s" (0.14 mm² "f-st"); 5 pcs/strip

	white	280-470	200 (25)
--	-------	---------	----------

Adjacent jumper; insulated; I_N = I_N terminal block

	gray	280-402	200 (25)
--	------	---------	----------

Insulation stop; 0.25 ... 0.5 mm²; 5 pcs/strip

	light gray	280-471	200 (25)
--	------------	---------	----------

Screwless end stop; for DIN-35 rail; 6 mm wide

	gray	249-116	100 (25)
--	------	---------	----------

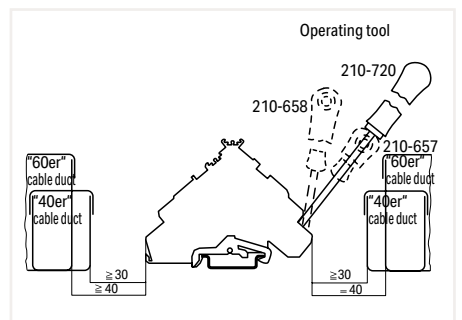

Min. mounting distance – terminal blocks to cable duct



Sensor LED terminal block paired with a 4-conductor sensor

Sold & Serviced By:



Toll Free Phone (877) SERV098
www.electromate.com
sales@electromate.com

Actuator terminal block; for pressure and thermo switches

2.5 mm²; 280 Series

Technical Data	
0.08 ... 2.5 mm ²	28 ... 12 AWG*
400 V/6 kV/3 ①	300 V, 15 A ②
I _N 20 A	300 V, 15 A ③
Terminal block width: 5 mm / 0.197 inch	
8 ... 9 mm / 0.31 ... 0.35 inch	

Technical Data	
0.08 ... 2.5 mm ²	28 ... 12 AWG*
400 V/6 kV/3 ①	300 V, 15 A ②
I _N 20 A	300 V, 15 A ③
Terminal block width: 6 mm / 0.236 inch	
8 ... 9 mm / 0.31 ... 0.35 inch	

*12 AWG: THHN, THWN

- ① 400 V = rated voltage
6 kV = rated impulse voltage
3 = pollution degree (see Section 14)

Please observe the application notes: Insulation stop, see page 346
Marking, from page 588

Approvals and corresponding ratings, visit www.wago.com

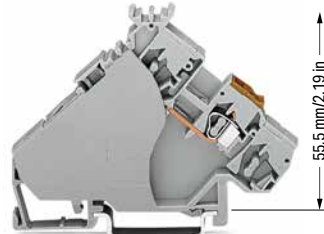
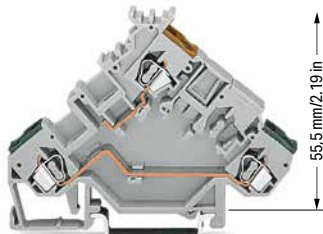

280-555 80 mm/3.15 in
280-554 80 mm/3.15 in

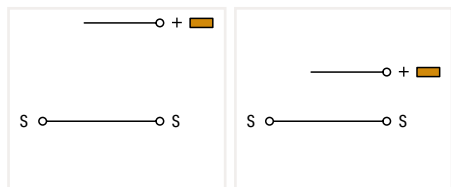

Actuator terminal block

Color	Item No.	Pack. Unit
○ gray	280-555	50

Actuator supply terminal block; in connection with 280-555: power supply from control panel side; in connection with 280-554: power supply from actuator side; with end plate

Color	Item No.	Pack. Unit
○ gray	280-556	20

Actuator terminal block		
○ gray	280-554	50

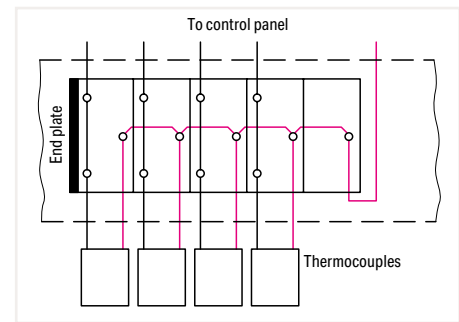

Power supply from actuator side

Accessories; 280 Series

Appropriate marking system: WMB

End and intermediate plate; 1 mm thick; for triple-deck terminal blocks

orange	280-321	100 (25)
gray	280-319	100 (25)

Insulation stop; 0.08 ... 0.2 mm² "s" (0.14 mm² "f-st"); 5 pcs/strip

white	280-470	200 (25)
-------	---------	----------

Insulation stop; 0.25 ... 0.5 mm²; 5 pcs/strip

light gray	280-471	200 (25)
------------	---------	----------

Insulation stop; 0.75 ... 1 mm²; 5 pcs/strip

dark gray	280-472	200 (25)
-----------	---------	----------

Adjacent jumper; insulated; I_N = I_N terminal block

gray	280-402	200 (25)
------	---------	----------

Screwless end stop; for DIN-35 rail; 6 mm wide

gray	249-116	100 (25)
------	---------	----------

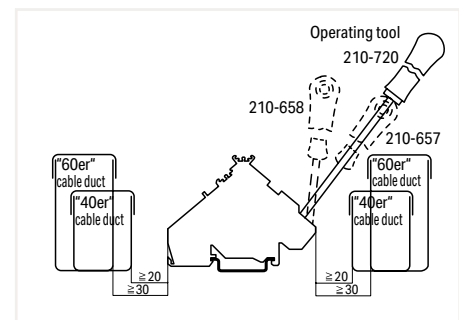

Min. mounting distance – terminal blocks to cable duct



Actuator terminal block with thermocouple

Actuator terminal block; for Magnetic Valves and Servo Motors

2.5 mm²; 280 Series

Technical Data	
0.08 ... 2.5 mm ²	28 ... 12 AWG*
400 V/6 kV/3; 20 A ① ②	300 V, 15 A ③
250 V/4 kV/3; 20 A ① ②	300 V, 15 A ④
Terminal block width: 5 mm / 0.197 inch	
8 ... 9 mm / 0.31 ... 0.35 inch	

Technical Data	
0.08 ... 2.5 mm ²	28 ... 12 AWG*
125 V / 5 A ②	300 V, 6 A ③
250 V / 6.3 A ②	300 V, 15 A ④
Terminal block width: 5 mm / 0.197 inch	
8 ... 9 mm / 0.31 ... 0.35 inch	

Technical Data	
0.08 ... 2.5 mm ²	28 ... 12 AWG*
400 V/6 kV/3 ①	300 V, 10 A ③
I _N 10 A	300 V, 15 A ④
Terminal block width: 5 mm / 0.197 inch	
8 ... 9 mm / 0.31 ... 0.35 inch	

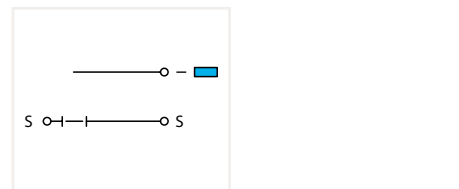
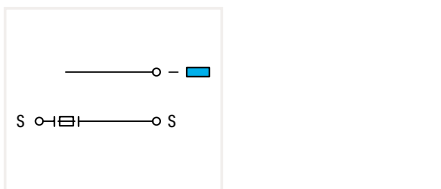
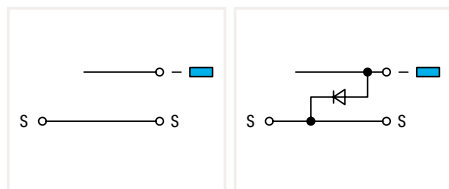
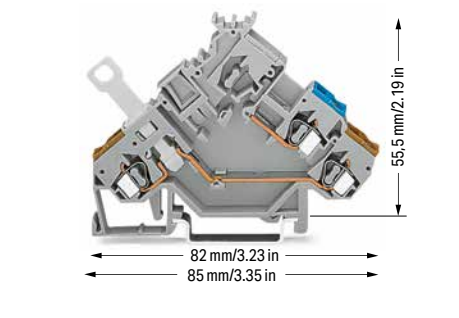
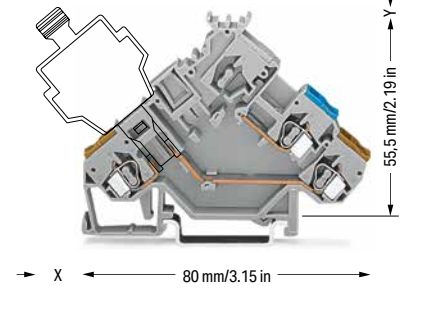
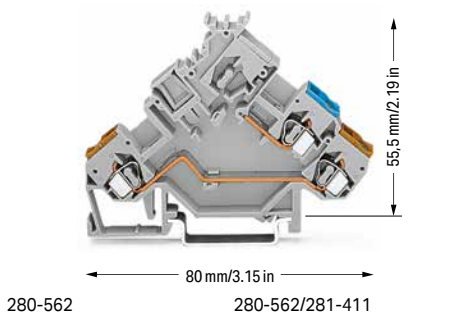

Actuator terminal block		
Color	Item No.	Pack. Unit
○ gray	280-562	50

Actuator terminal block; for fuse plugs; for phase protection; without end plate		
Color	Item No.	Pack. Unit
○ gray	280-565 ④	50

Actuator disconnect terminal block; for phase interruption		
Color	Item No.	Pack. Unit
○ gray	280-566	50

Actuator terminal block; with 1N4007 recovery diode		
Color	Item No.	Pack. Unit
○ gray	280-562/281-411	50

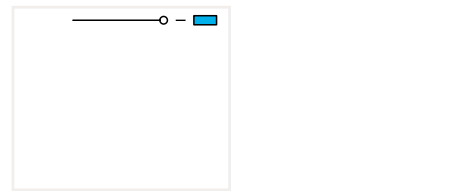
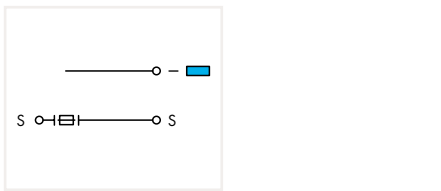
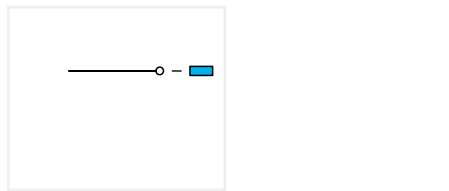
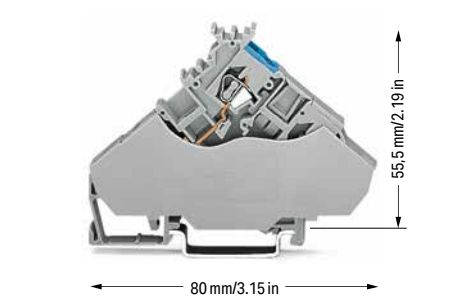
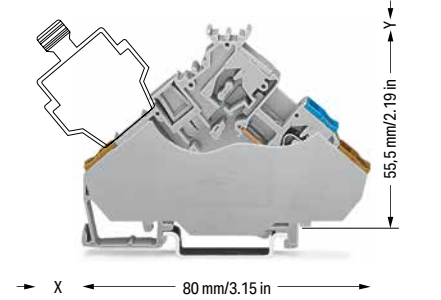
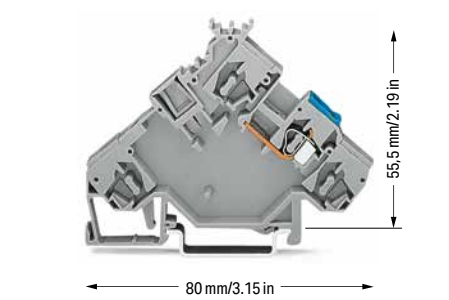

Actuator supply terminal block; power supply from actuator side		
Color	Item No.	Pack. Unit
○ gray	280-592	10

Actuator terminal block; for fuse plugs; for phase protection; with gray end plate		
Terminal block width: 6 mm / 0.236 inch		
Color	Item No.	Pack. Unit
○ gray	280-565/281-319	50

Actuator supply terminal block; power supply from control panel side; with end plate		
Terminal block width: 6 mm / 0.236 inch		
Color	Item No.	Pack. Unit
○ gray	280-568	20

Actuator terminal block; for fuse plugs; for phase protection; with orange end plate		
Terminal block width: 6 mm / 0.236 inch		
Color	Item No.	Pack. Unit
○ gray	280-565/281-321	50

Technical Data	
400 V/6 kV/3	I _N 20 A

5

*12 AWG: THHN, THWN

- 1 400 V / 250 V = rated voltage
6 kV / 4 kV = rated impulse voltage
3 = pollution degree
(see Section 14)
- 2 Electrical ratings are given by the fuse plug or empty component plug housing.
- 3 Empty component plug housings, see Full Line Catalog, Interface Modules, Volume 4
x = 12 mm/0.472 inch
Fuse plug (281-511), see page 302
y = 15.5 mm/0.61 inch
z = 10 mm/0.394 inch

Please observe the application notes:
Insulation stop, see page 346
Marking, from page 588

Approvals and corresponding ratings,
visit www.wago.com



Sensor terminal block paired with a 3-conductor sensor

Accessories; 280 Series

Appropriate marking system:
WMB

End and intermediate plate; 1 mm thick; for triple-deck terminal blocks

orange	280-321	100 (25)
gray	280-319	100 (25)



Insulation stop; 0.08 ... 0.2 mm² "s" (0.14 mm² "f-st"); 5 pcs/strip

white	280-470	200 (25)
-------	---------	----------



Insulation stop; 0.25 ... 0.5 mm²; 5 pcs/strip

light gray	280-471	200 (25)
------------	---------	----------



Insulation stop; 0.75 ... 1 mm²; 5 pcs/strip

dark gray	280-472	200 (25)
-----------	---------	----------



Adjacent jumper; insulated; I_N = I_N terminal block

gray	280-402	200 (25)
------	---------	----------



Screwless end stop; for DIN-35 rail; 6 mm wide

gray	249-116	100 (25)
------	---------	----------



Screwless end stop; for DIN-35 rail; 10 mm wide

gray	249-116	50 (25)
------	---------	---------

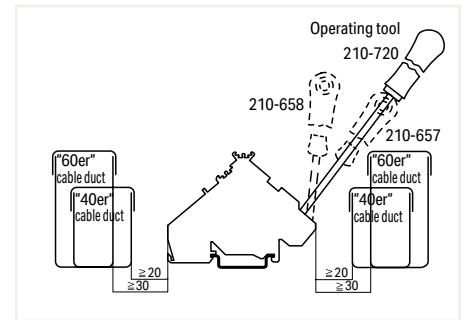

Min. mounting distance – terminal blocks to cable duct

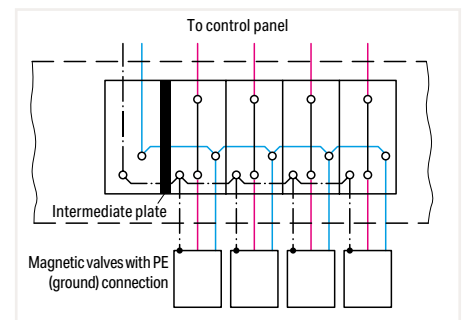
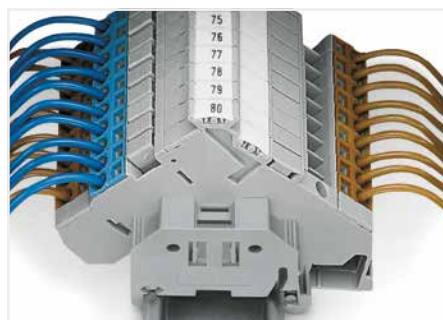

Power supply from control panel side

Actuator terminal block; with ground connection; for magnetic valves and servo motors

2.5 mm²; 280 Series

Technical Data	
0.08 ... 2.5 mm ²	28 ... 12 AWG*
400 V/6 kV/3; 20 A ① ②	300 V, 15 A ③
250 V/4 kV/3; 20 A ① ②	300 V, 15 A ④
Terminal block width: 5 mm / 0.197 inch	
8 ... 9 mm / 0.31 ... 0.35 inch	



90,5 mm/3.56 in

280-572 280-572/281-411

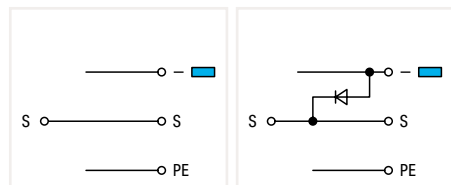

Actuator terminal block; with ground connection		
Color	Item No.	Pack. Unit
○ gray	280-572	50

Actuator terminal block; with ground connection; with 1N4007 recovery diode		
Color	Item No.	Pack. Unit
○ gray	280-572/281-411	50

Technical Data	
0.08 ... 2.5 mm ²	28 ... 12 AWG*
125 V / 5 A ②	300 V, 6 A ③
250 V / 6.3 A ②	300 V, 15 A ④
Terminal block width: 5 mm / 0.197 inch	
8 ... 9 mm / 0.31 ... 0.35 inch	

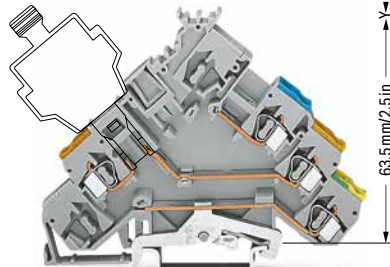

90,5 mm/3.56 in

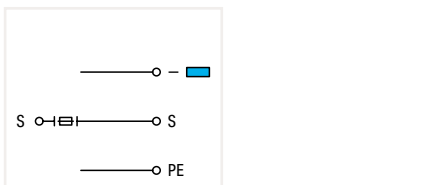

Actuator terminal block; with ground connection; for fuse plugs; for phase protection; without end plate		
Color	Item No.	Pack. Unit
○ gray	280-575 ④	50

Technical Data	
0.08 ... 2.5 mm ²	28 ... 12 AWG*
400 V/6 kV/3 ①	300 V, 10 A ③
I _N 10 A	300 V, 15 A ④
Terminal block width: 5 mm / 0.197 inch	
8 ... 9 mm / 0.31 ... 0.35 inch	

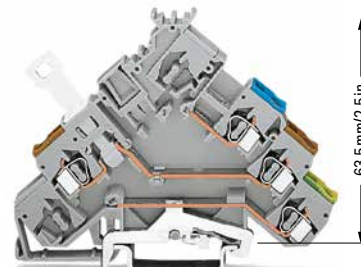

90,5 mm/3.56 in

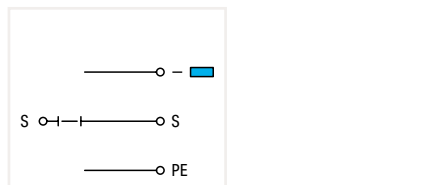

Actuator disconnect terminal block; with ground connection; for phase interruption		
Color	Item No.	Pack. Unit
○ gray	280-576	50

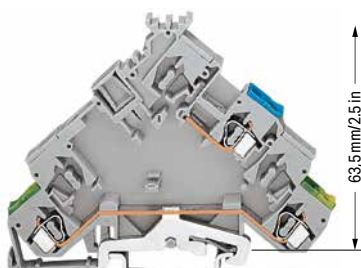

90,5 mm/3.56 in

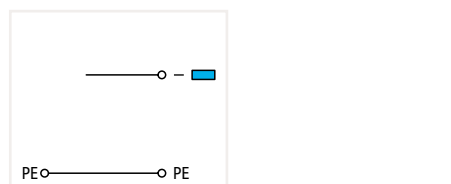

Actuator supply terminal block; with ground connection; power supply from actuator side		
Color	Item No.	Pack. Unit
○ gray	280-593	10

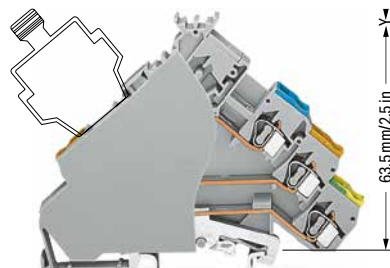

90,5 mm/3.56 in

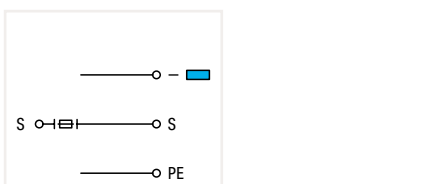

Actuator terminal block; with ground connection; for fuse plugs; for phase protection; with end plate		
Color	Item No.	Pack. Unit
○ gray	280-575/281-320	50

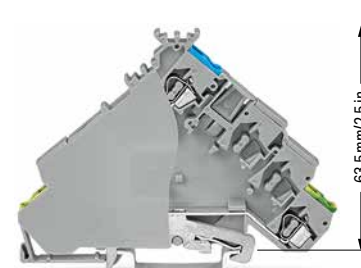

90,5 mm/3.56 in

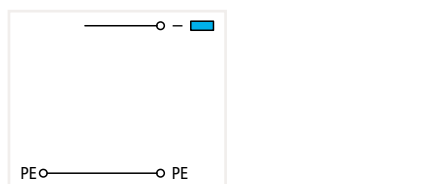

Actuator supply terminal block; with ground connection; power supply from control panel side; with end plate		
Color	Item No.	Pack. Unit
○ gray	280-578	20

Actuator terminal block; with ground connection; for fuse plugs; for phase protection; with orange end plate		
Color	Item No.	Pack. Unit
○ gray	280-575/281-323	50

Technical Data	
400 V/6 kV/3	I _N 20 A

5

*12 AWG: THHN, THWN

1 400 V / 250 V = rated voltage
6 kV / 4 kV = rated impulse voltage
3 = pollution degree
(see Section 14)

2 Electrical ratings are given by the fuse plug or empty component plug housing.

3 Empty component plug housings, see Full Line Catalog, Interface Modules, Volume 4
x = 12 mm/0.472 inch
Fuse plug (281-511), see page 302
x = 15.5 mm/0.61 inch
y = 10 mm/0.394 inch

Please observe the application notes:
Insulation stop, see page 346
Marking, from page 588

Approvals and corresponding ratings,
visit www.wago.com

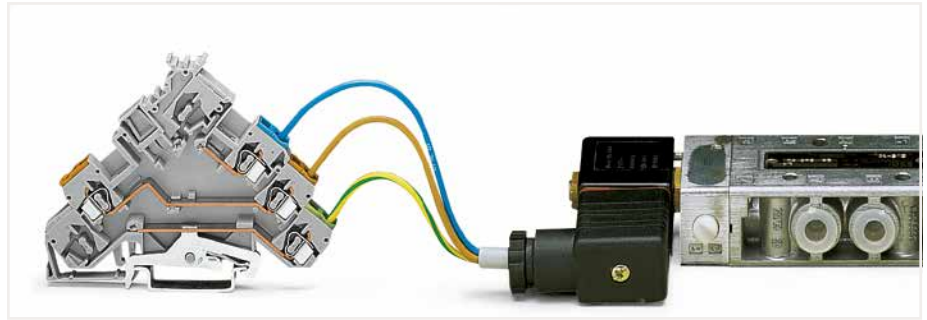

Actuator terminal block (ground connection) paired with a magnetic valve

Accessories; 280 Series

Appropriate marking system:
WMB

End and intermediate plate; 1 mm thick; for quadruple-deck terminal blocks

	orange	280-323	100 (25)
	gray	280-320	100 (25)

Insulation stop; 0.08 ... 0.2 mm² "s" (0.14 mm² "f-st"); 5 pcs/strip

	white	280-470	200 (25)
---	-------	---------	----------

Insulation stop; 0.25 ... 0.5 mm²; 5 pcs/strip

	light gray	280-471	200 (25)
---	------------	---------	----------

Insulation stop; 0.75 ... 1 mm²; 5 pcs/strip

	dark gray	280-472	200 (25)
---	-----------	---------	----------

Adjacent jumper; insulated; I_N = I_N terminal block

	gray	280-402	200 (25)
---	------	---------	----------

Screwless end stop; for DIN-35 rail; 6 mm wide

	gray	249-116	100 (25)
---	------	---------	----------

Screwless end stop; for DIN-35 rail; 10 mm wide

	gray	249-116	50 (25)
---	------	---------	---------

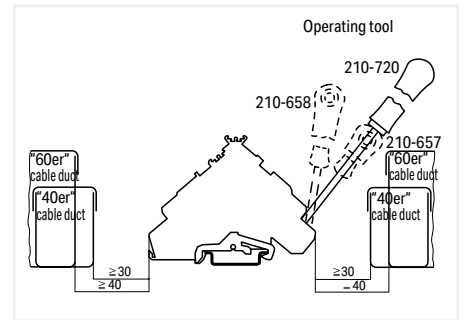
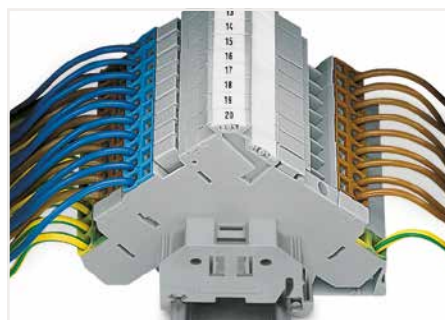

Min. mounting distance – terminal blocks to cable duct

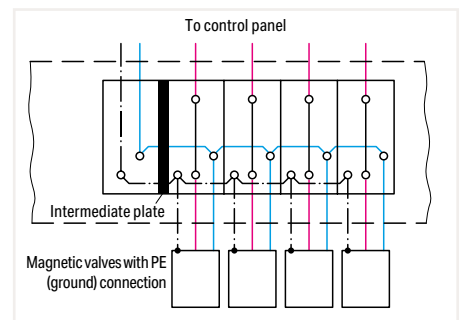

Power supply from control panel side

Actuator LED Terminal Block; with Ground Connection 2.5 mm²; 280 Series

Technical Data	
0.08 ... 2.5 mm ²	28 ... 12 AWG*
24 VDC ①	24 V, 15 A
20 A	300 V, 15 A
Terminal block width: 5 mm / 0.197 inch	
8 ... 9 mm / 0.31 ... 0.35 inch	

Technical Data	
0.08 ... 2.5 mm ²	28 ... 12 AWG*
24 VDC ①	24 V, 15 A
20 A	300 V, 15 A
Terminal block width: 5 mm / 0.197 inch	
8 ... 9 mm / 0.31 ... 0.35 inch	

*12 AWG: THHN, THWN

① Other voltages are available upon request.

Please observe the application notes:
Insulation stop, see page 346
Marking, from page 588

Approvals and corresponding ratings, visit www.wago.com

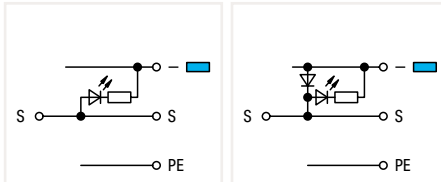
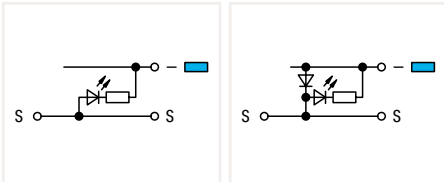
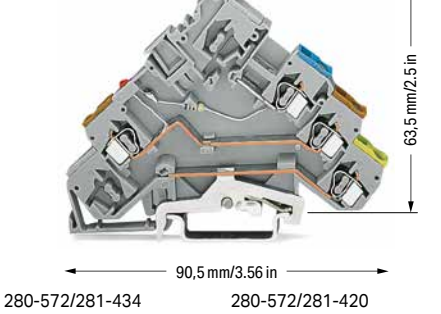
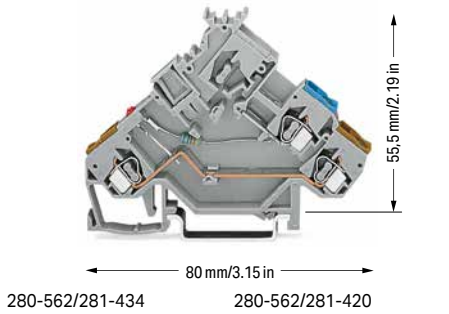

Actuator LED terminal block; red LED; LED power consumption: 4.8 mA

Color	Item No.	Pack. Unit
gray	280-562/281-434	50

Actuator LED terminal block; with ground connection; red LED; LED power consumption: 4.8 mA

Color	Item No.	Pack. Unit
gray	280-572/281-434	50

Actuator LED terminal block; with 1N4007 recovery diode; red LED; LED power consumption: 4.8 mA

gray	280-562/281-420	50
------	-----------------	----

Actuator LED terminal block; with ground connection; with 1N4007 recovery diode; red LED; LED power consumption: 4.8 mA

gray	280-572/281-420	50
------	-----------------	----

Accessories; item-specific

End and intermediate plate; 1 mm thick; for triple-deck terminal blocks

orange	280-321	100 (25)
gray	280-319	100 (25)

Accessories; item-specific

End and intermediate plate; 1 mm thick; for quadruple-deck terminal blocks

orange	280-323	100 (25)
gray	280-320	100 (25)

Accessories; 280 Series

Appropriate marking system: WMB

Insulation stop; 0.08 ... 0.2 mm² "s" (0.14 mm² "f-st"); 5 pcs/strip

white	280-470	200 (25)
-------	---------	----------

Insulation stop; 0.75 ... 1 mm²; 5 pcs/strip

dark gray	280-472	200 (25)
-----------	---------	----------

Insulation stop; 0.25 ... 0.5 mm²; 5 pcs/strip

light gray	280-471	200 (25)
------------	---------	----------

Adjacent jumper; insulated; I_N = I_N terminal block

gray	280-402	200 (25)
------	---------	----------

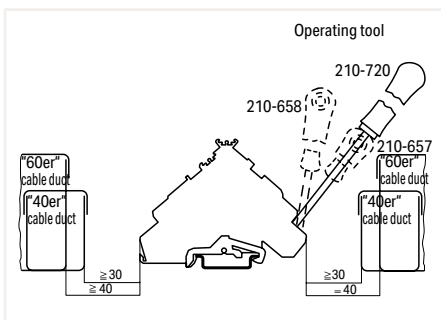
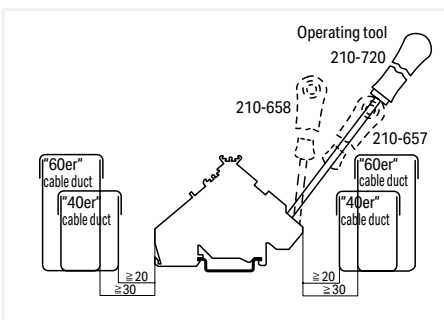
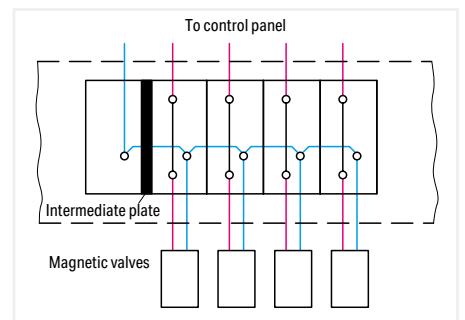
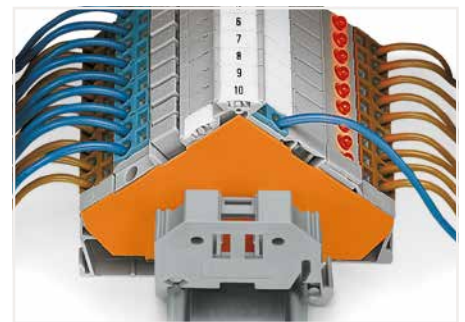

Actuator Terminal Block for Actuators with Shield Connection and Actuators with Shield Conductor Through Contact (e.g., for Thermocouples)

2.5 mm²; 280 Series

Technical Data	
0.08 ... 2.5 mm ²	28 ... 12 AWG*
400 V/6 kV/3 ①	300 V, 15 A ②
I _N 20 A	300 V, 15 A ③
Terminal block width: 5 mm / 0.197 inch	
8 ... 9 mm / 0.31 ... 0.35 inch	



Actuator terminal block; with shield connection

Color	Item No.	Pack. Unit
○ gray	280-585	50

Accessories; item-specific see page 325

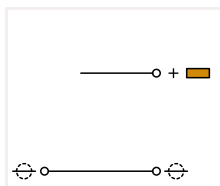
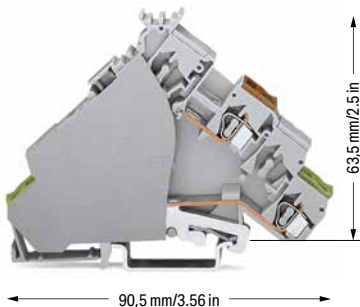

Actuator supply terminal block; with shield connection; power supply from control panel side; with end plate
Terminal block width: 6 mm / 0.236 inch

Color	Item No.	Pack. Unit
○ gray	280-586	10

Accessories; item-specific see page 325

Technical Data	
0.08 ... 2.5 mm ²	28 ... 12 AWG*
400 V/6 kV/3 ①	300 V, 15 A ②
I _N 20 A	
Terminal block width: 5 mm / 0.197 inch	
8 ... 9 mm / 0.31 ... 0.35 inch	

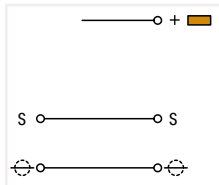

Actuator terminal block; with shield conductor through contact

Color	Item No.	Pack. Unit
○ gray	280-583	50

Accessories; item-specific see page 325

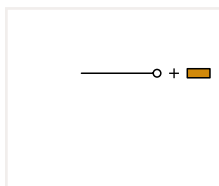
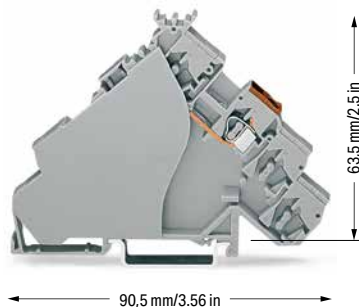

Actuator supply terminal block; power supply from control panel side; with end plate; for actuators with shield conductor through contact
Terminal block width: 6 mm / 0.236 inch

Color	Item No.	Pack. Unit
○ gray	280-515	50

Accessories; item-specific see page 325

*12 AWG: THHN, THWN

- ① 400 V = rated voltage
6 kV = rated impulse voltage
3 = pollution degree (see Section 14)

Please observe the application notes: Insulation stop, see page 346
Marking, from page 588

Approvals and corresponding ratings, visit www.wago.com

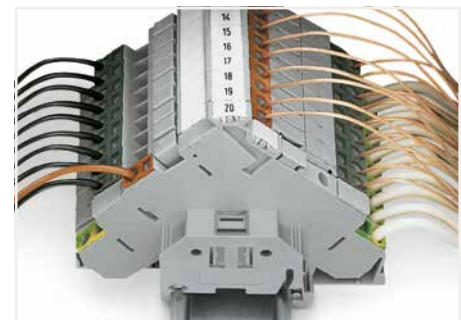

Power supply from control panel side



Power supply from control panel side

Diode Terminal Block and LED Terminal Block

1.5 mm²; 279 Series

Technical Data	
0.08 ... 1.5 mm ²	28 ... 16 AWG
U _N 250 V; U _{RM} 1000 V	
1N4007 – 0.5 A continuous current	
Terminal block width: 4 mm / 0.157 inch	
8 ... 9 mm / 0.31 ... 0.35 inch	

Technical Data	
0.08 ... 1.5 mm ²	28 ... 16 AWG
U _N 250 V; U _{RM} 1000 V	
1N4007 – 0.5 A continuous current	
Terminal block width: 4 mm / 0.157 inch	
8 ... 9 mm / 0.31 ... 0.35 inch	

Technical Data	
0.08 ... 1.5 mm ²	28 ... 16 AWG
24 VDC	
I _F 0.025 A max.	
Terminal block width: 4 mm / 0.157 inch	
8 ... 9 mm / 0.31 ... 0.35 inch	

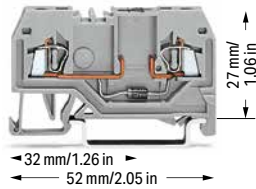

279-915/281-410 279-915/281-411

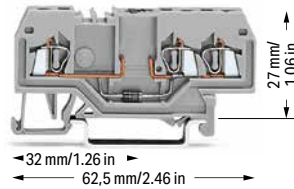

279-673/281-410 279-673/281-411

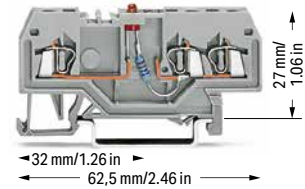

279-674/281-434 279-674/281-413

5

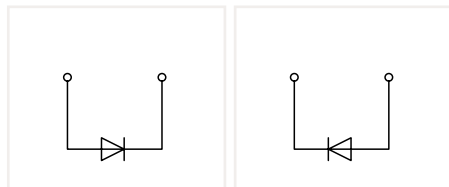

2-conductor diode terminal block; with 1N4007 diode		
Color	Item No.	Pack. Unit
○ gray	279-915/281-410	100
○ gray	279-915/281-411	100

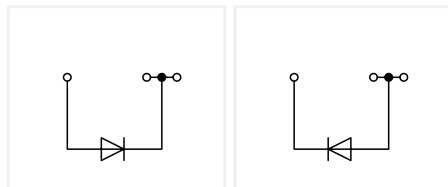

3-conductor diode terminal block; with 1N4007 diode		
Color	Item No.	Pack. Unit
○ gray	279-673/281-410	100
○ gray	279-673/281-411	100

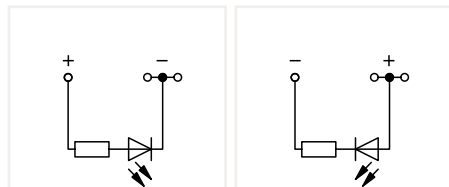

3-conductor LED terminal block; with red LED		
Color	Item No.	Pack. Unit
○ gray	279-674/281-434	100
○ gray	279-674/281-413	100

Other terminal blocks with the same profile:		
Through	279-901	Page 234

Other terminal blocks with the same profile:		
Through	279-681	Page 234

Other terminal blocks with the same profile:		
Through	279-681	Page 234

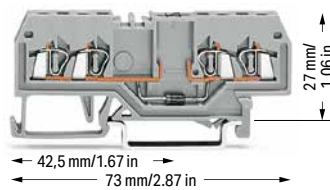

279-815/281-411 279-815/281-410

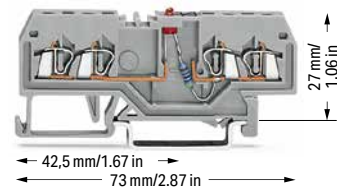

279-809/281-434 279-809/281-413

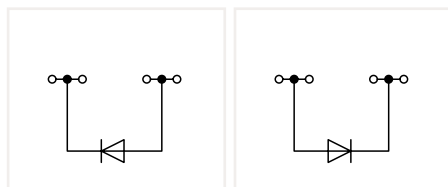

4-conductor diode terminal block; with 1N4007 diode		
Color	Item No.	Pack. Unit
○ gray	279-815/281-411	100
○ gray	279-815/281-410	100

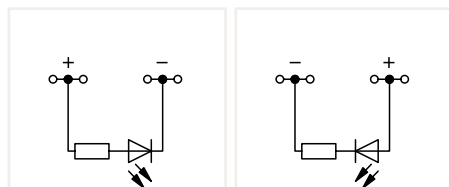

4-conductor LED terminal block; with red LED		
Color	Item No.	Pack. Unit
○ gray	279-809/281-434	100
○ gray	279-809/281-413	100

Other terminal blocks with the same profile:		
Through	279-831	Page 234

Other terminal blocks with the same profile:		
Through	279-831	Page 234

Diode Terminal Blocks and LED Terminal Blocks

Circuit Configuration Examples

Please observe the application notes:
 Insulation stop, page 346
 Comb-style jumper bar, page 347
 Marking, from page 588

Approvals and corresponding ratings,
 visit www.wago.com

Accessories; 279 Series

Appropriate marking system:
 WMB

Insulation stop; 0.08 ... 0.2 mm² "s" (0.14 mm² "f-st"); 5 pcs/strip



white 279-470 200 (25)

Insulation stop; 0.25 mm²; 5 pcs/strip



dark gray 279-471 200 (25)

Comb-style jumper bar; insulated; I_N = I_N of terminal block



2-way 279-482 200 (25)

3-way 279-483 200 (25)

Comb-style jumper bar; insulated; I_N = I_N of terminal block



10-way 279-490 50 (25)

Alternate comb-style jumper bar; insulated; I_N = I_N of terminal block



2-way 279-492 200 (25)

Operating tool; insulated



2-way 279-432 1

3-way 279-433 1

Operating tool; insulated



10-way 279-440 1

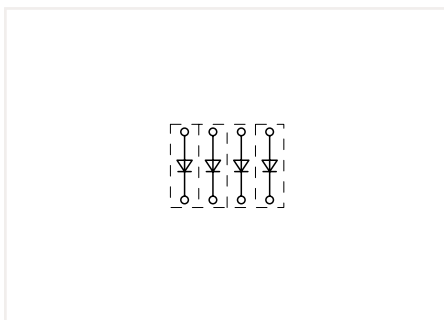

Open diode gates can be created using the following terminal blocks:
 279-915/281-410 or 279-915/281-411

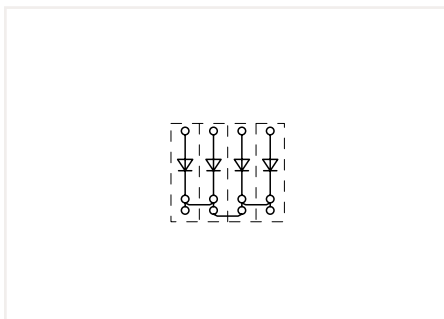

Polarized diode gates with a common cathode can be created using the following terminal blocks:
 279-673/281-410 or 279-673/281-411

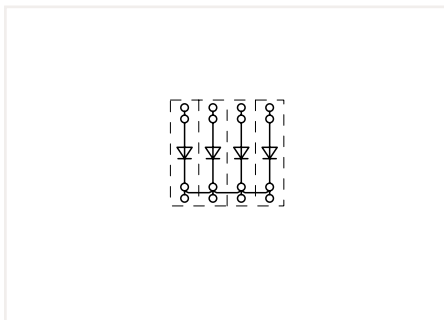

Polarized diode gates with a common cathode can be created using the following terminal blocks:
 279-815/281-410 or 279-815/281-411

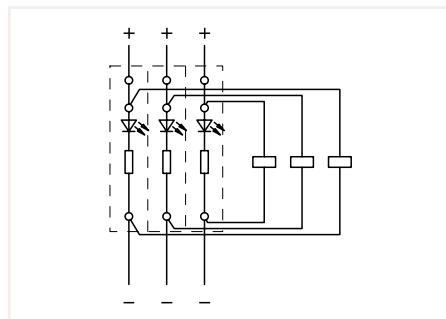

Circuit-related voltage indications can be created using the following terminal blocks:
 279-674/281-434 or 279-674/281-413

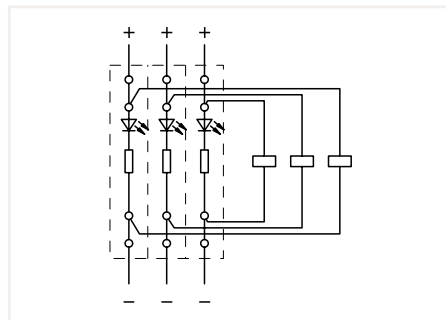

Circuit-related voltage indications can be created using the following terminal blocks:
 279-809/281-434 or 279-809/281-413

Diode Terminal Block and LED Terminal Block

2.5 mm²; 280 Series

Technical Data	
0.08 ... 2.5 mm ²	28 ... 14 AWG
U _N 250 V; U _{RM} 1000 V	
1N4007 – 0.5 A continuous current	
Terminal block width: 5 mm / 0.197 inch	
8 ... 9 mm / 0.31 ... 0.35 inch	

Technical Data	
0.08 ... 2.5 mm ²	28 ... 14 AWG
U _N 250 V; U _{RM} 1000 V	
1N4007 – 0.5 A continuous current	
Terminal block width: 5 mm / 0.197 inch	
8 ... 9 mm / 0.31 ... 0.35 inch	

Technical Data	
0.08 ... 2.5 mm ²	28 ... 14 AWG
24 VDC	
I _F 0.025 A max.	
Terminal block width: 5 mm / 0.197 inch	
8 ... 9 mm / 0.31 ... 0.35 inch	

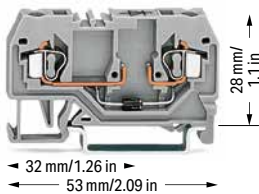

280-915/281-410 280-915/281-411

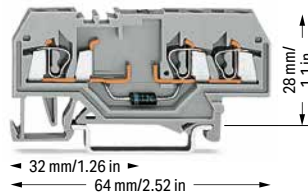

280-673/281-410 280-673/281-411

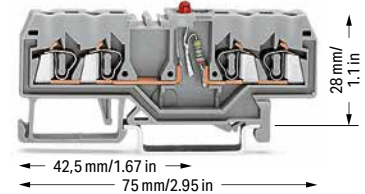

280-809/281-434 280-809/281-413

5

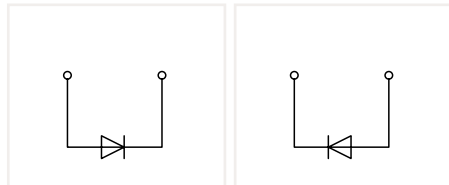

2-conductor diode terminal block; with 1N4007 diode		
Color	Item No.	Pack. Unit
○ gray	280-915/281-410	100
○ gray	280-915/281-411	100

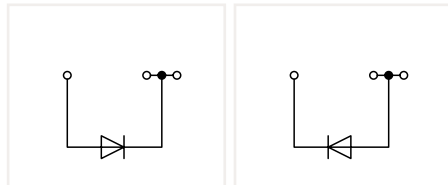

3-conductor diode terminal block; with 1N4007 diode		
Color	Item No.	Pack. Unit
○ gray	280-673/281-410	100
○ gray	280-673/281-411	100

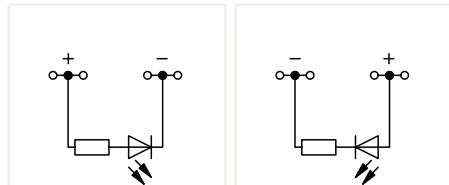

4-conductor LED terminal block; with red LED		
Color	Item No.	Pack. Unit
○ gray	280-809/281-434	100
○ gray	280-809/281-413	100

Other terminal blocks with the same profile:		
Through	280-901	Page 236

Other terminal blocks with the same profile:		
Through	280-681	Page 236

Other terminal blocks with the same profile:		
Through	280-833	Page 236

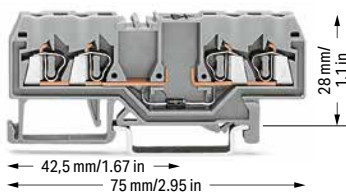

280-815/281-410 280-815/281-411

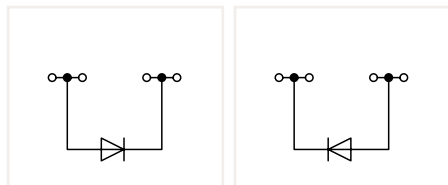

4-conductor diode terminal block; with 1N4007 diode		
Color	Item No.	Pack. Unit
○ gray	280-815/281-410	100
○ gray	280-815/281-411	100

Other terminal blocks with the same profile:		
Through	280-833	Page 236

Diode Terminal Blocks and LED Terminal Blocks

Circuit Configuration Examples

Please observe the application notes:
 Insulation stop, page 346
 Comb-style jumper bar, page 347
 Marking, from page 588

Approvals and corresponding ratings,
 visit www.wago.com

Accessories; 280 Series

Appropriate marking system:
 WMB

Insulation stop; 0.08 ... 0.2 mm² "s" (0.14 mm² "f-st"); 5 pcs/strip

	white	280-470	200 (25)
---	-------	---------	----------

Insulation stop; 0.25 ... 0.5 mm²; 5 pcs/strip

	light gray	280-471	200 (25)
---	------------	---------	----------

Insulation stop; 0.75 ... 1 mm²; 5 pcs/strip

	dark gray	280-472	200 (25)
---	-----------	---------	----------

Comb-style jumper bar; insulated; I_N = I_N of terminal block

	2-way	280-482	200 (25)
	3-way	280-483	200 (25)

Comb-style jumper bar; insulated; I_N = I_N of terminal block

	10-way	280-490	50 (25)
---	--------	---------	---------

Alternate comb-style jumper bar; insulated; I_N = I_N of terminal block

	2-way	280-492	200 (25)
---	-------	---------	----------

Operating tool; insulated

	2-way	280-432	1
	3-way	280-433	1

Operating tool; insulated

	10-way	280-440	1
---	--------	---------	---

Wire commoning chain; insulated; 50 connections; I_N 8 A

	black	210-103	5
---	-------	---------	---

Wire commoning chain; insulated; 50 connections; I_N 8 A

	blue	210-123	5
---	------	---------	---

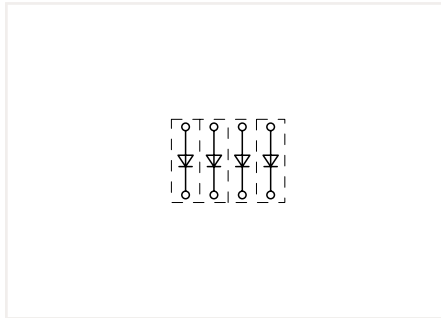

Open diode gates can be created using the following terminal blocks:
 280-915/281-410 or 280-915/281-411

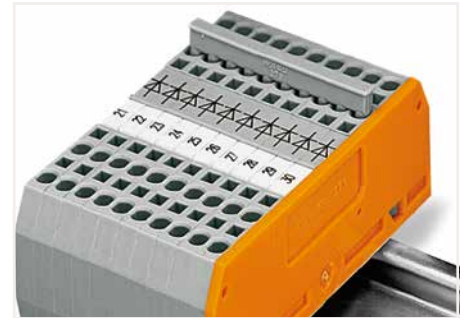

These diode terminal blocks have been specially developed for custom diode circuits, such as lamp test and collective fault signal circuits.

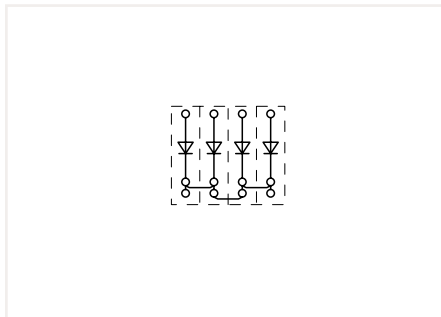

Polarized diode gates with a common cathode can be created using the following terminal blocks:
 280-673/281-410 or 280-673/281-411

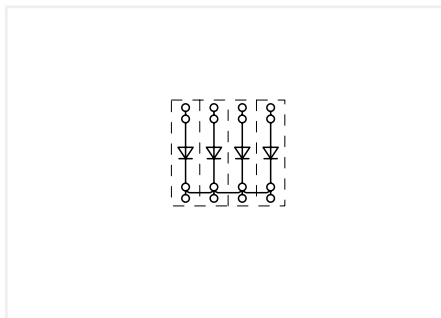

Polarized diode gates with a common cathode can be created using the following terminal blocks:
 280-815/281-410 or 280-815/281-411

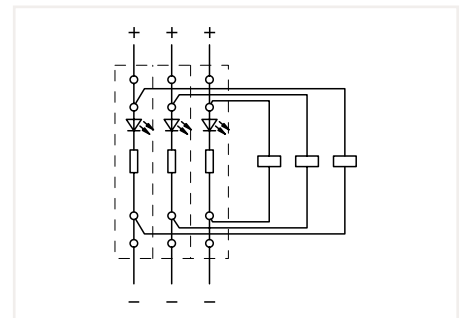

Circuit-related voltage indications can be created using the following terminal blocks:
 280-809/281-434 or 280-809/281-413

Diode Terminal Block

4 mm²; 281 Series

Technical Data	
0.08 ... 4 mm ²	28 ... 12 AWG
U _N 250 V; U _{RM} 1000 V	
Terminal block width: 6 mm / 0.236 inch	
9 ... 10 mm / 0.35 ... 0.39 inch	

Technical Data	
0.08 ... 4 mm ²	28 ... 12 AWG
U _N 250 V; U _{RM} 1000 V	
Terminal block width: 6 mm / 0.236 inch	
9 ... 10 mm / 0.35 ... 0.39 inch	

Technical Data	
0.08 ... 4 mm ²	28 ... 12 AWG
U _N 250 V; U _{RM} 1000 V	
Terminal block width: 6 mm / 0.236 inch	
9 ... 10 mm / 0.35 ... 0.39 inch	

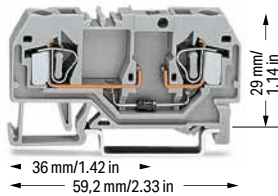

281-915/281-410 281-915/281-411

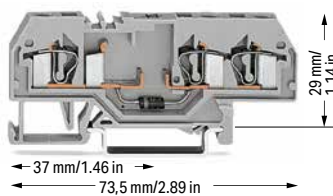

281-673/281-410 281-673/281-411

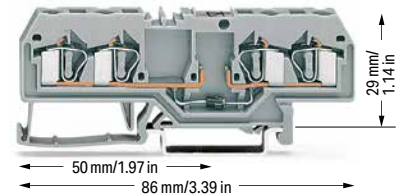

281-665/281-410 281-665/281-410

5

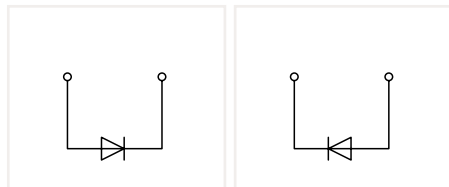

2-conductor diode terminal block; with 1N4007 diode; 0.5 A continuous current		
Color	Item No.	Pack. Unit
○ gray	281-915/281-410	50
○ gray	281-915/281-411	50

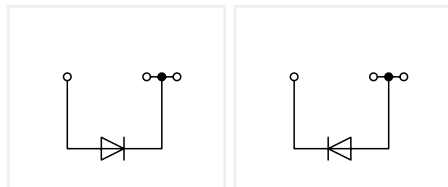

3-conductor diode terminal block; with 1N4007 diode; 0.5 A continuous current		
Color	Item No.	Pack. Unit
○ gray	281-673/281-410	50
○ gray	281-673/281-411	50

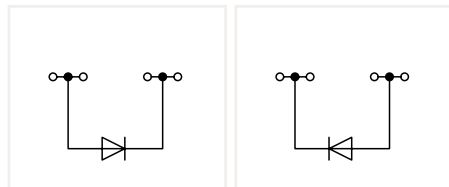

4-conductor diode terminal block; with 1N4007 diode; 0.5 A continuous current		
Color	Item No.	Pack. Unit
○ gray	281-665/281-410	50
○ gray	281-665/281-411	50

2-conductor diode terminal block; with 1N4007 diode; 1.5 A continuous current		
Color	Item No.	Pack. Unit
○ gray	281-915/281-400	50
○ gray	281-915/281-401	50

3-conductor diode terminal block; with 1N4007 diode; 1.5 A continuous current		
Color	Item No.	Pack. Unit
○ gray	281-673/281-400	50
○ gray	281-673/281-401	50

4-conductor diode terminal block; with 1N4007 diode; 1.5 A continuous current		
Color	Item No.	Pack. Unit
○ gray	281-665/281-400	50
○ gray	281-665/281-401	50

Other terminal blocks with the same profile:		
Through	281-901	Page 242

Other terminal blocks with the same profile:		
Through	281-681	Page 242

Other terminal blocks with the same profile:		
Through	280-652	Page 242

Diode Terminal Blocks

Circuit Configuration Examples

Please observe the application notes:
 Insulation stop, page 346
 Comb-style jumper bar, page 347
 Marking, from page 588

Approvals and corresponding ratings,
 visit www.wago.com

Accessories; 281 Series

Appropriate marking system:
 WMB

Insulation stop; 0.08 ... 0.2 mm² "s" (0.14 mm² "f-st"); 5 pcs/strip

	white	281-470	200 (25)
---	-------	---------	----------

Insulation stop; 0.25 ... 0.5 mm²; 5 pcs/strip

	light gray	281-471	200 (25)
---	------------	---------	----------

Insulation stop; 0.75 ... 1.5 mm²; 5 pcs/strip

	dark gray	281-472	200 (25)
---	-----------	---------	----------

Comb-style jumper bar; insulated; I_N = I_N of terminal block

	2-way	281-482	100 (25)
	3-way	281-483	100 (25)
	5-way	281-485	100 (25)
	10-way	281-490	50 (25)

Alternate comb-style jumper bar; insulated; I_N = I_N of terminal block

	2-way	281-492	100 (25)
---	-------	---------	----------

Operating tool; insulated

	2-way	280-432	1
	3-way	280-433	1
	5-way	281-440	1

Wire commoning chain; insulated; 50 connections; I_N 8 A

	black	210-103	5
---	-------	---------	---

Wire commoning chain; insulated; 50 connections; I_N 8 A

	blue	210-123	5
---	------	---------	---

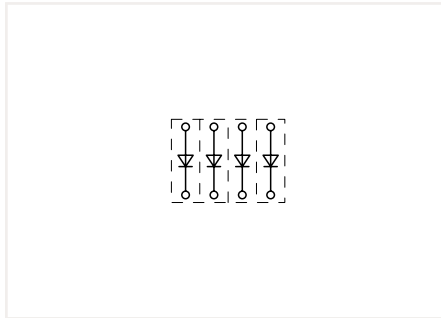

Open diode gates can be created using the following terminal blocks:
 281-915/281-410 or 281-915/281-411

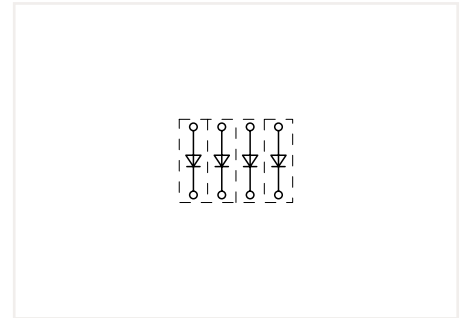

Open diode gates can be created using the following terminal blocks:
 281-915/281-400 or 281-915/281-401

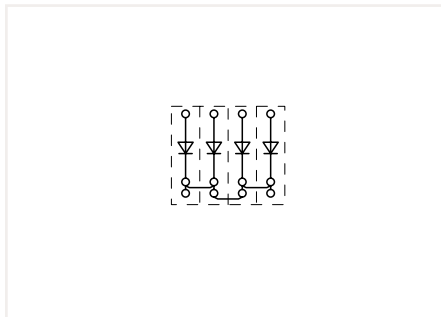

Polarized diode gates with a common cathode can be created using the following terminal blocks:
 281-673/281-410 or 281-673/281-411

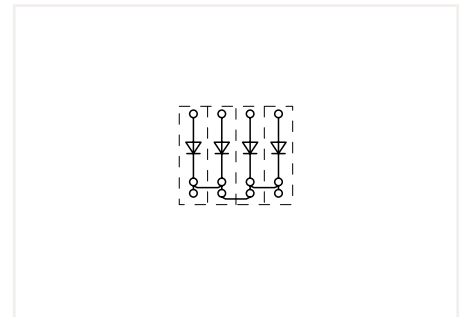

Polarized diode gates with a common cathode can be created using the following terminal blocks:
 281-673/281-400 or 281-673/281-401

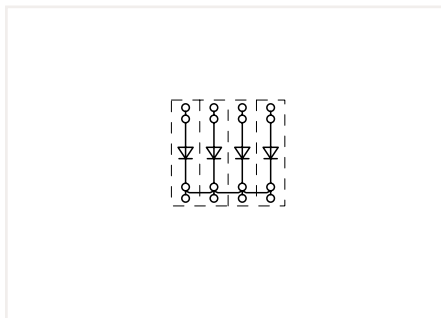

Polarized diode gates with a common cathode can be created using the following terminal blocks:
 281-665/281-410 or 281-665/281-411

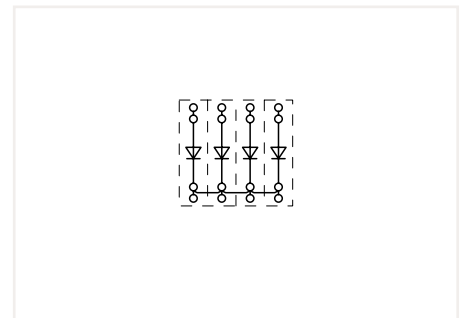

Polarized diode gates with a common cathode can be created using the following terminal blocks:
 281-665/281-400 or 281-665/281-401

5

Sold & Serviced By:



Toll Free Phone (877) SERV098

www.electromate.com

sales@electromate.com

Double-Deck Diode Terminal Block and LED Terminal Block 2.5 mm²; 280 Series

Technical Data

0.08 ... 2.5 mm² | 28 ... 14 AWG

U_N 250 V; U_{RM} 1000 V

1N4007 – 0.5 A continuous current

Terminal block width: 5 mm / 0.197 inch

8 ... 9 mm / 0.31 ... 0.35 inch

Technical Data

0.08 ... 2.5 mm² | 28 ... 14 AWG

U_N 250 V; U_{RM} 1000 V

1N4007 – 0.5 A continuous current

Terminal block width: 5 mm / 0.197 inch

8 ... 9 mm / 0.31 ... 0.35 inch

Technical Data

0.08 ... 2.5 mm² | 28 ... 14 AWG

24 VDC

I_F 0.025 A max.

Terminal block width: 5 mm / 0.197 inch

8 ... 9 mm / 0.31 ... 0.35 inch

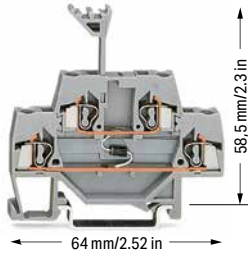

280-940/281-410 280-940/281-411

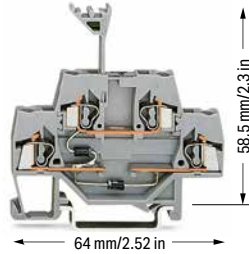

280-941/281-492 280-941/281-491

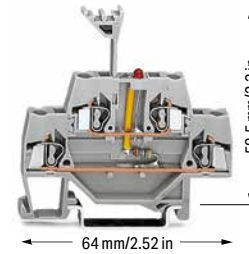

280-943/281-434 280-943/281-413

5

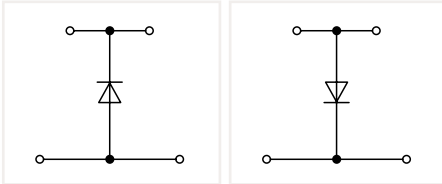

Double-deck diode terminal block; with 1N4007 diode

Color	Item No.	Pack. Unit
○ gray	280-940/281-410	50
○ gray	280-940/281-411	50

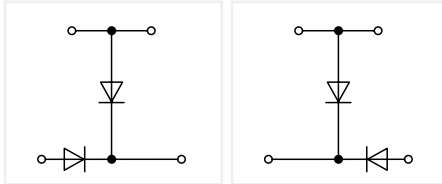

Double-deck diode terminal block; with two 1N4007 diodes

Color	Item No.	Pack. Unit
○ gray	280-941/281-492	50
○ gray	280-941/281-491	50

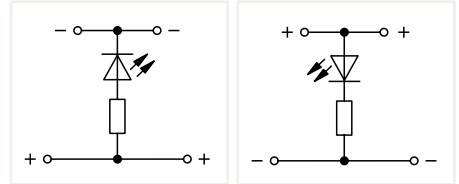

Double-deck LED terminal block; with red LED

Color	Item No.	Pack. Unit
○ gray	280-943/281-434	50
○ gray	280-943/281-413	50

Other terminal blocks with the same profile:

Through 280-519 Page 256

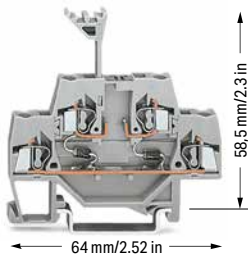

280-942/281-487 280-942/281-488

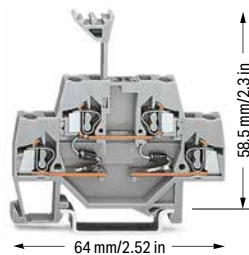

280-941/281-489 280-941/281-490

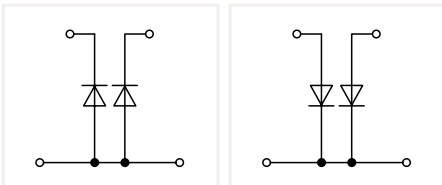

Double-deck diode terminal block; with two 1N4007 diodes

Color	Item No.	Pack. Unit
○ gray	280-942/281-487	50
○ gray	280-942/281-488	50

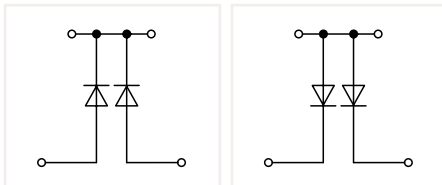

Double-deck diode terminal block; with two 1N4007 diodes

Color	Item No.	Pack. Unit
○ gray	280-941/281-489	50
○ gray	280-941/281-490	50

Double-Deck Diode Terminal Blocks and LED Terminal Blocks Circuit Configuration Examples

Please observe the application notes:
Insulation stop, page 346
Comb-style jumper bar, page 347
Marking, from page 588

Approvals and corresponding ratings,
visit www.wago.com

Accessories; 280 Series

Appropriate marking system:
WMB

End and intermediate plate; 2.5 mm thick

orange	280-341	100 (25)
gray	280-340	100 (25)



Insulation stop; 0.08 ... 0.2 mm² "s" (0.14 mm² "f-st"); 5 pcs/strip

white	280-470	200 (25)
-------	---------	----------



Insulation stop; 0.25 ... 0.5 mm²; 5 pcs/strip

light gray	280-471	200 (25)
------------	---------	----------



Insulation stop; 0.75 ... 1 mm²; 5 pcs/strip

dark gray	280-472	200 (25)
-----------	---------	----------



Comb-style jumper bar; insulated; I_N = I_N of terminal block

2-way	280-482	200 (25)
3-way	280-483	200 (25)



Comb-style jumper bar; insulated; I_N = I_N of terminal block

10-way	280-490	50 (25)
--------	---------	---------



Alternate comb-style jumper bar; insulated; I_N = I_N of terminal block

2-way	280-492	200 (25)
-------	---------	----------



Operating tool; insulated

2-way	280-432	1
3-way	280-433	1



Operating tool; insulated

10-way	280-440	1
--------	---------	---



Wire commoning chain; insulated; 50 connections; I_N 8 A

black	210-103	5
-------	---------	---



Wire commoning chain; insulated; 50 connections; I_N 8 A

blue	210-123	5
------	---------	---

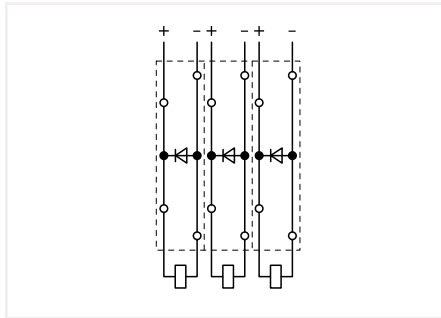

Recovery diodes can be created using the following terminal blocks:
280-940/281-410 or 280-940/281-411

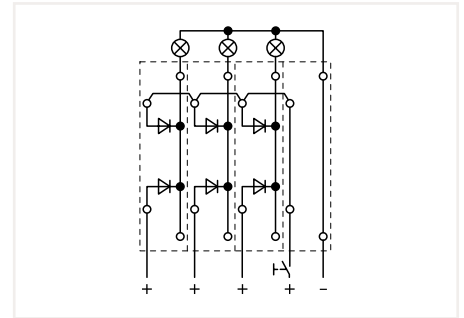

Lamp test circuits can be created using the following terminal blocks:
280-942/281-487 or 280-942/281-488

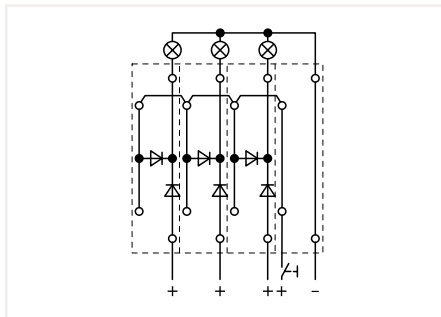

Lamp test circuits can be created using the following terminal blocks:
280-941/281-492 or 280-941/281-491

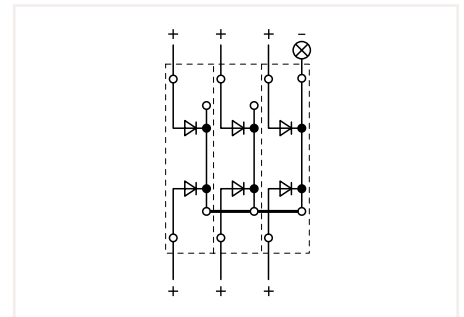

Collective fault signals can be created using the following terminal blocks:
280-941/281-489 or 280-941/281-490

Double-deck diode terminal blocks were specifically developed for custom diode circuits, such as lamp test and collective fault signal circuits. Using LED terminal blocks, monitoring units can be designed, e.g., for control and operating circuits. These terminal blocks provide high-density wiring in a width of just 5 mm.

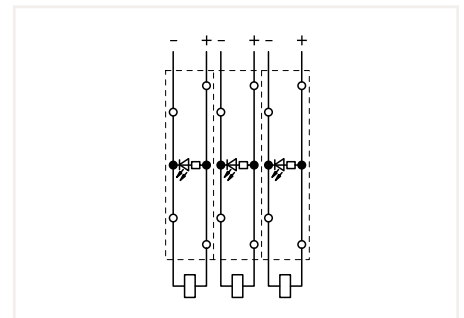

Circuit-related voltage indications can be created using the following terminal blocks:
280-943/281-434 or 280-943/281-413

Double-Deck Diode Terminal Block and LED Terminal Block 4 mm²; 281 Series

Technical Data

0.08 ... 4 mm² | 28 ... 12 AWG
 U_N 250 V; U_{RM} 1000 V
 1N4007 – 0.5 A continuous current
 Terminal block width: 6 mm / 0.236 inch
 9 ... 10 mm / 0.35 ... 0.39 inch

Technical Data

0.08 ... 4 mm² | 28 ... 12 AWG
 U_N 250 V; U_{RM} 1000 V
 1N4007 – 0.5 A continuous current
 Terminal block width: 6 mm / 0.236 inch
 9 ... 10 mm / 0.35 ... 0.39 inch

Technical Data

0.08 ... 4 mm² | 28 ... 12 AWG
 24 VDC
 I_F 0.025 A max.
 Terminal block width: 6 mm / 0.236 inch
 9 ... 10 mm / 0.35 ... 0.39 inch

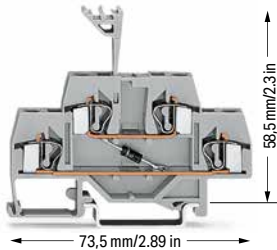

281-633/281-410

281-633/281-411

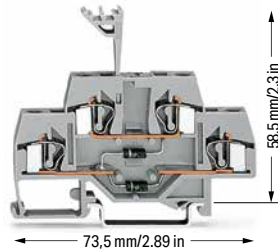

281-635/281-492

281-635/281-491

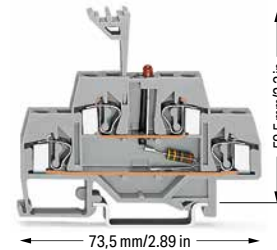

281-634/281-434

281-634/281-413

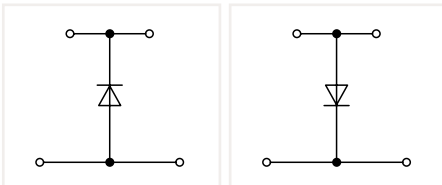

Double-deck diode terminal block; with 1N4007 diode

Color	Item No.	Pack. Unit
○ gray	281-633/281-410	50
○ gray	281-633/281-411	50

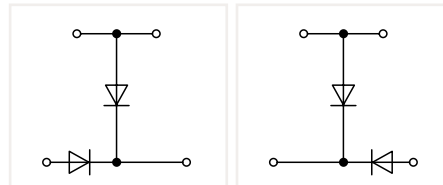

Double-deck diode terminal block; with two 1N4007 diodes

Color	Item No.	Pack. Unit
○ gray	281-635/281-492	50
○ gray	281-635/281-491	50

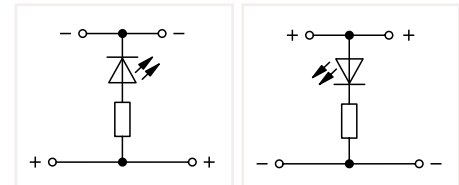

Double-deck LED terminal block; with red LED

Color	Item No.	Pack. Unit
○ gray	281-634/281-434	50
○ gray	281-634/281-413	50

Other terminal blocks with the same profile:

Through [280-519](#) Page 260

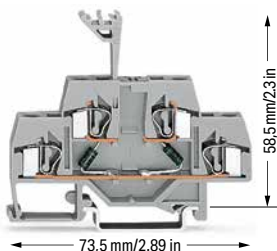

281-636/281-487

281-636/281-488

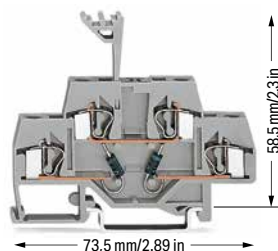

281-635/281-489

281-635/281-490

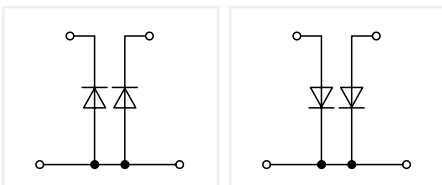

Double-deck diode terminal block; with two 1N4007 diodes

Color	Item No.	Pack. Unit
○ gray	281-636/281-487	50
○ gray	281-636/281-488	50

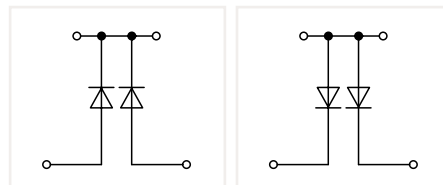

Double-deck diode terminal block; with two 1N4007 diodes

Color	Item No.	Pack. Unit
○ gray	281-635/281-489	50
○ gray	281-635/281-490	50

Double-Deck Diode Terminal Blocks and LED Terminal Blocks Circuit Configuration Examples

Please observe the application notes:
Insulation stop, page 346
Comb-style jumper bar, page 347
Marking, from page 588

Approvals and corresponding ratings,
visit www.wago.com

Accessories; 280 Series

Appropriate marking system:
WMB

End and intermediate plate; 2.5 mm thick

orange	281-341	100 (25)
gray	281-340	100 (25)



Insulation stop; 0.08 ... 0.2 mm² "s" (0.14 mm² "f-st"); 5 pcs/strip

white	281-470	200 (25)
-------	---------	----------



Insulation stop; 0.25 ... 0.5 mm²; 5 pcs/strip

light gray	281-471	200 (25)
------------	---------	----------



Insulation stop; 0.75 ... 1.5 mm²; 5 pcs/strip

dark gray	281-472	200 (25)
-----------	---------	----------



Comb-style jumper bar; insulated; I_N = I_N of terminal block

2-way	281-482	100 (25)
3-way	281-483	100 (25)
5-way	281-485	100 (25)
10-way	281-490	50 (25)



Alternate comb-style jumper bar; insulated; I_N = I_N of terminal block

2-way	280-492	200 (25)
-------	---------	----------



Operating tool; insulated

2-way	280-432	1
3-way	280-433	1
5-way	281-440	1



Wire commoning chain; insulated; 50 connections; I_N 8 A

black	210-103	5
-------	---------	---



Wire commoning chain; insulated; 50 connections; I_N 8 A

blue	210-123	5
------	---------	---

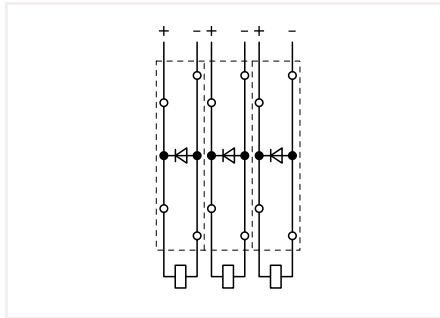

Recovery diodes can be created using the following terminal blocks:
281-633/281-410 or 281-633/281-411

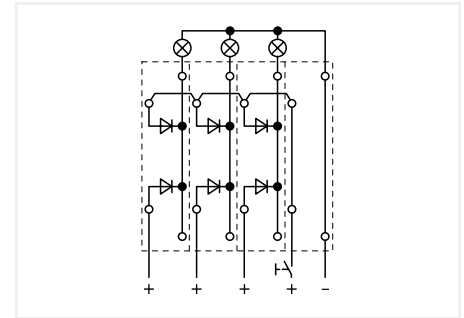

Lamp test circuits can be created using the following terminal blocks:
281-636/281-487 or 281-636/281-488

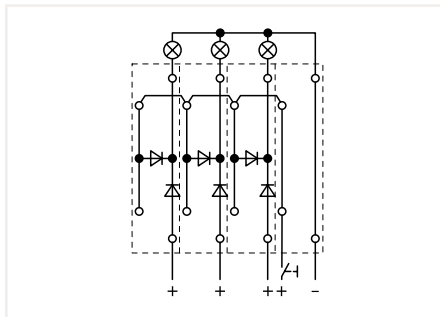

Lamp test circuits can be created using the following terminal blocks:
281-635/281-492 or 281-635/281-491

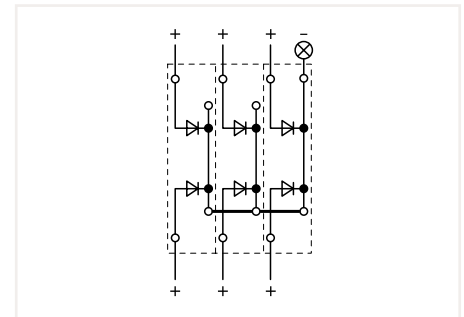

Collective fault signals can be created using the following terminal blocks:
281-635/281-489 or 281-635/281-490

Double-deck diode terminal blocks were specifically developed for custom diode circuits, such as lamp test and collective fault signal circuits. Using LED terminal blocks, monitoring units can be designed, e.g., for control and operating circuits. These terminal blocks provide high-density wiring in a width of just 6 mm.

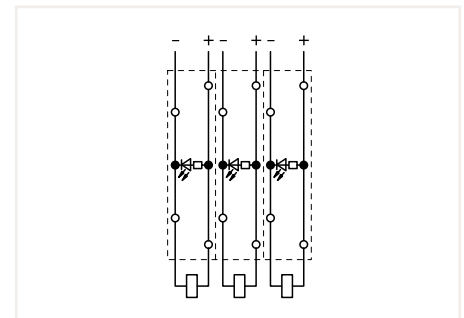

Circuit-related voltage indications can be created using the following terminal blocks:
281-634/281-434 or 281-634/281-413

5

Pluggable Diode Module on Carrier Terminal Block 2.5 mm² 280 Series

Technical Data

U_N 250 V; U_{RM} 1000 V
 I_N 0.5 A
 Plug width: 5 mm / 0.197 inch



*12 AWG: THHN, THWN

Please observe the application notes:
 Insulation stop, page 346
 Comb-style jumper bar, page 347
 Marking, from page 588

Approvals and corresponding ratings, visit www.wago.com

Accessories; 280 Series

Appropriate marking system:
 WMB

Insulation stop; 0.08 ... 0.2 mm² "s" (0.14 mm² "f-st"); 5 pcs/strip

white	280-470	200 (25)
-------	---------	----------

Insulation stop; 0.25 ... 0.5 mm²; 5 pcs/strip

light gray	280-471	200 (25)
------------	---------	----------

Insulation stop; 0.75 ... 1 mm²; 5 pcs/strip

dark gray	280-472	200 (25)
-----------	---------	----------

Comb-style jumper bar; insulated; I_N = I_N of terminal block

2-way	280-482	200 (25)
3-way	280-483	200 (25)

Comb-style jumper bar; insulated; I_N = I_N of terminal block

10-way	280-490	50 (25)
--------	---------	---------

Alternate comb-style jumper bar; insulated; I_N = I_N of terminal block

2-way	280-492	200 (25)
-------	---------	----------

Operating tool; insulated

2-way	280-432	1
3-way	280-433	1

Operating tool; insulated

10-way	280-440	1
--------	---------	---

Wire commoning chain; insulated; 50 connections; I_N 8 A

black	210-103	5
-------	---------	---

Wire commoning chain; insulated; 50 connections; I_N 8 A

blue	210-123	5
------	---------	---

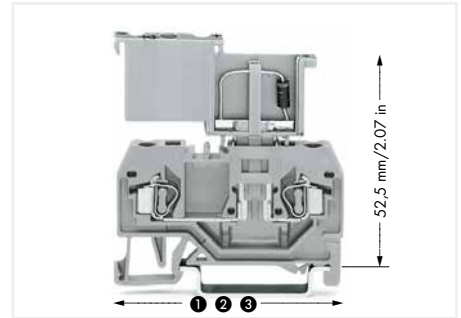

Lengths of carrier terminal blocks with a pluggable diode module:

- ① 53 mm / 2.09 inch for 280-916
- ② 64 mm / 2.52 inch for 280-610
- ③ 75 mm / 2.95 inch for 280-816

280-801/281-411

280-801/281-420

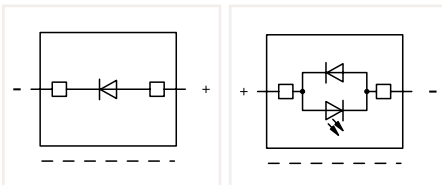

Diode module; with 1N4007 diode; 5 mm wide

Color	Item No.	Pack. Unit
gray	280-801/281-411	100

Diode module; with 1N4007 recovery diode; red LED; 5 mm wide; gray

24 VDC	280-801/281-420	100
48 VDC	280-801/281-421	100

Accessories; Carrier Terminal Blocks

Appropriate marking system:
 WMB

2-conductor carrier terminal block;
 0.08 ... 2.5 mm² / 28 ... 12 AWG*
 Terminal block width: 5 mm / 0.197 inch

gray	280-916	100
------	---------	-----

End and intermediate plate; 2.5 mm thick

orange	280-309	100 (25)
gray	280-308	100 (25)

3-conductor carrier terminal block;
 0.08 ... 2.5 mm² / 28 ... 12 AWG*
 Terminal block width: 5 mm / 0.197 inch

gray	280-610	100
------	---------	-----

End and intermediate plate; 2.5 mm thick

orange	280-326	100 (25)
gray	280-324	100 (25)

4-conductor carrier terminal block;
 0.08 ... 2.5 mm² / 28 ... 12 AWG*
 Terminal block width: 5 mm / 0.197 inch

gray	280-816	100
------	---------	-----

End and intermediate plate; 2.5 mm thick

orange	280-315	100 (25)
gray	280-314	100 (25)

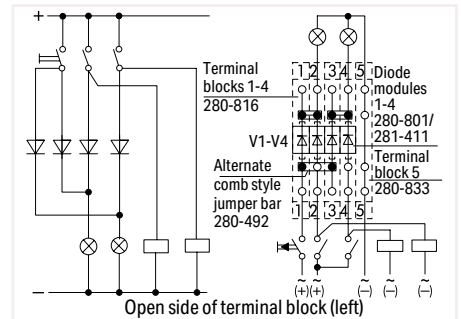

Lamp test circuit with blocking diodes

These diode modules are ideal for custom diode circuits (e.g., lamp test and collective fault signal circuits) and offer the following advantages:

- Separation into functional and wiring levels
- Polarized switching direction
- Quick and easy module replacement
- Terminal blocks/modules provide high-density wiring in a width of just 5 mm

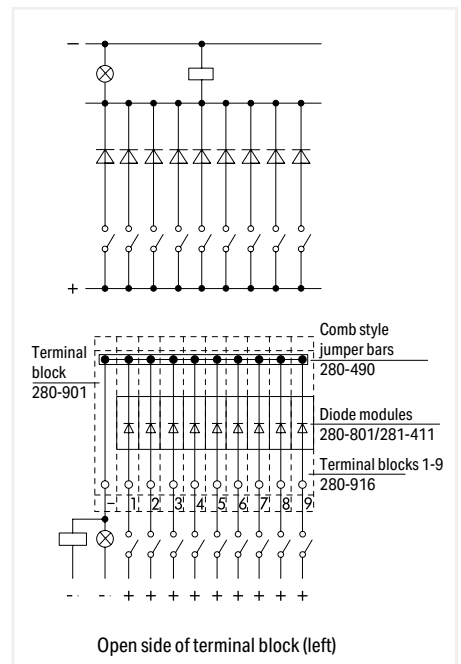

Diode gate for collective fault indication

Pluggable Diode Module on Through Terminal Block 2.5 mm² 280 Series

Technical Data

U_N 250 V; U_{RM} 1000 V

I_N 0.5 A

Plug width: 10 mm / 0.394 inch



280-803/281-411

280-803/281-420

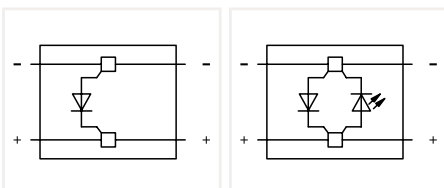

Diode module; with 1N4007 diode; 10 mm wide

Color	Item No.	Pack. Unit
○ gray	280-803/281-411	50

Diode module; with 1N4007 recovery diode; red LED; 10 mm wide; gray

○ 24 VDC	280-803/281-420	50
○ 48 VDC	280-803/281-421	50

Accessories; Through Terminal Blocks

Appropriate marking system:
WMB

2-conductor through terminal block;
0.08 ... 2.5 mm² / 28 ... 12 AWG*
Terminal block width: 5 mm / 0.197 inch



gray	280-901	100
------	---------	-----

End and intermediate plate; 2.5 mm thick

orange	280-309	100 (25)
gray	280-308	100 (25)

3-conductor through terminal block;
0.08 ... 2.5 mm² / 28 ... 12 AWG*
Terminal block width: 5 mm / 0.197 inch



gray	280-681	100
------	---------	-----

End and intermediate plate; 2.5 mm thick

orange	280-326	100 (25)
gray	280-324	100 (25)

4-conductor through terminal block;
0.08 ... 2.5 mm² / 28 ... 12 AWG*
Terminal block width: 5 mm / 0.197 inch



gray	280-833	100
------	---------	-----

End and intermediate plate; 2.5 mm thick

orange	280-315	100 (25)
gray	280-314	100 (25)

*12 AWG: THHN, THWN

Please observe the application notes:
Insulation stop, page 346
Comb-style jumper bar, page 347
Marking, from page 588

Approvals and corresponding ratings,
visit www.wago.com

Accessories; 280 Series

Appropriate marking systems:
WMB/WMB Inline/WFB

2-conductor through terminal block;
0.08 ... 2.5 mm² / 28 ... 12 AWG*
Terminal block width: 5 mm / 0.197 inch



gray	280-101	100
------	---------	-----

End and intermediate plate; 2.5 mm thick



orange	280-302	100 (25)
gray	280-301	100 (25)

Insulation stop; 0.08 ... 0.2 mm² "s" (0.14 mm² "f-st"); 5 pcs/strip



white	280-470	200 (25)
-------	---------	----------

Insulation stop; 0.25 ... 0.5 mm²; 5 pcs/strip



light gray	280-471	200 (25)
------------	---------	----------

Insulation stop; 0.75 ... 1 mm²; 5 pcs/strip



dark gray	280-472	200 (25)
-----------	---------	----------

Adjacent jumper; insulated; $I_N = I_N$ terminal block



gray	280-402	200 (25)
------	---------	----------

Wire commoning chain; insulated; 50 connections; I_N 8 A



black	210-103	5
-------	---------	---

Wire commoning chain; insulated; 50 connections; I_N 8 A



blue	210-123	5
------	---------	---

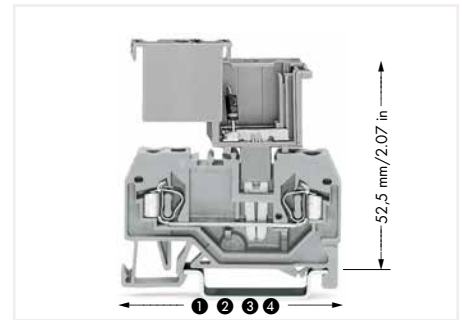

Lengths of through terminal blocks with a pluggable diode module:

- ① 53 mm / 2.09 inch for 280-901
- ② 64 mm / 2.52 inch for 280-681
- ③ 75 mm / 2.95 inch for 280-833
- ④ 45.5 mm / 1.67 inch for 280-101



Similar to push-in type jumpers, these diode modules are simply pushed into the current bar's contact slots of two adjacent through terminal blocks, providing the following advantages:

- Compatibility with all 280 Series Through Terminal Blocks
- Easy retrofits for existing systems
- Separation into functional and wiring levels
- Fast replacement of other functional units

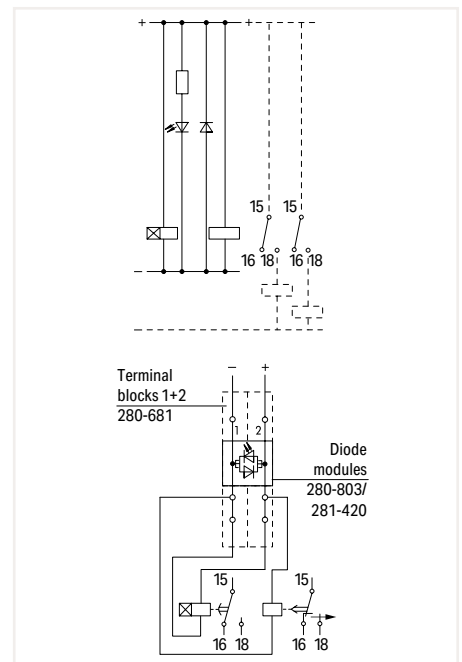

Free-wheeling diode and voltage check

Pluggable LED and Neon Indicator Module on Carrier Terminal Block 2.5 mm² 280 Series

Technical Data

Plug width: 5 mm / 0.197 inch



LED module; with red LED; 5 mm wide; I_N 5.6 mA; I_F 25 mA; gray

	Item No.	Pack. Unit
○ 24 VDC	280-801/281-413	100
○ 48 VDC	280-801/281-414	100

LED module; with red LED; 5 mm wide; I_N 5.6 mA; I_F 25 mA; gray

○ 24 VAC/DC	280-801/281-415	100
○ 48 VAC/VDC	280-801/281-416	100

Neon indicator module; 5 mm wide; I_N 0.5 mA; gray

○ 120 VAC/VDC	280-801/281-418	100
○ 230 VAC/VDC	280-801/281-417	100

Carrier terminal blocks, see page 338

Circuit Diagrams

LED module

	24 VDC	280-801/281-413
	48 VDC	280-801/281-414

LED module

	24 VAC/DC	280-801/281-415
	48 VAC/VDC	280-801/281-416

Neon indicator module

	120 VAC/VDC	280-801/281-418
	230 VAC/VDC	280-801/281-417

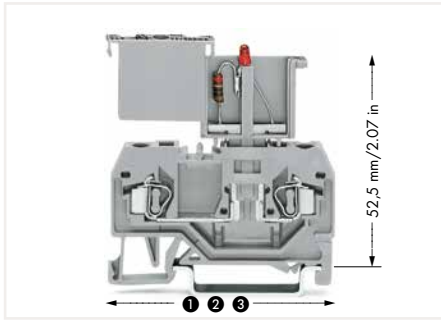

Lengths of carrier terminal blocks with a pluggable diode module:

- ① 53 mm / 2.09 inch for 280-916
- ② 64 mm / 2.52 inch for 280-610
- ③ 75 mm / 2.95 inch for 280-816



The monitoring of control and operating current circuits with LED modules on rail-mount terminal blocks provides several advantages:

- No additional cost for assembly and wiring
- Separation into functional and wiring levels
- Modules can be replaced quickly by other types of modules
- Polarized switching direction
- Terminal blocks/modules provide high-density wiring in a width of just 5 mm

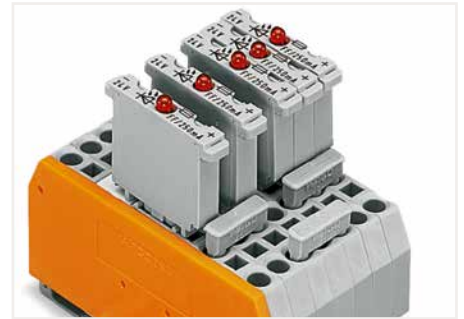

Carrier terminal blocks with component plugs, alternate comb-style jumper bars, 3-way, comb-style jumper bar

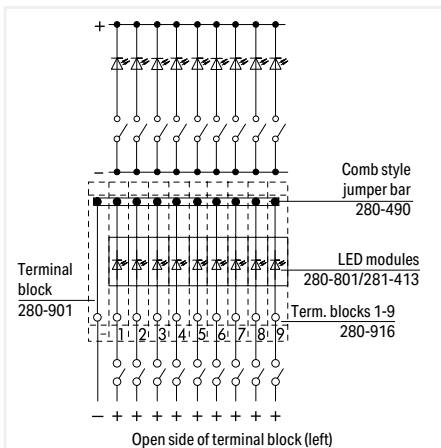

LED gate for collective fault indication – individual display

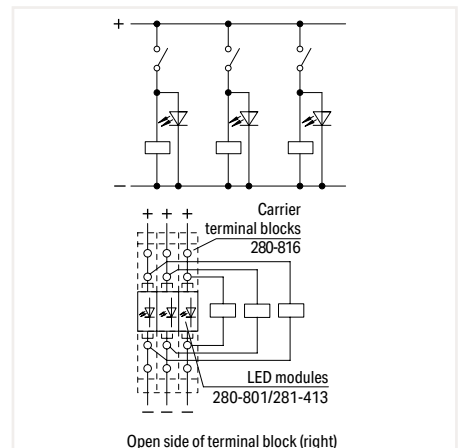

Voltage control assigned to current circuits

5

Pluggable LED and Neon Indicator Module on Through Terminal Block 2.5 mm² 280 Series

Technical Data

Plug width: 10 mm / 0.394 inch

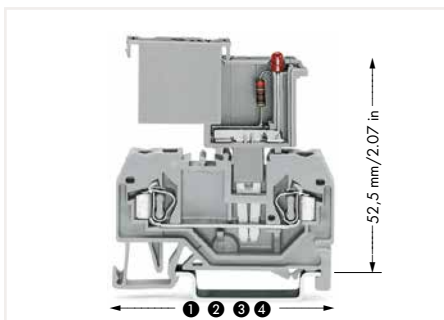

Lengths of through terminal blocks with a pluggable diode module:

- ❶ 53 mm / 2.09 inch for 280-901
- ❷ 64 mm / 2.52 inch for 280-681
- ❸ 75 mm / 2.95 inch for 280-833
- ❹ 45.5 mm / 1.67 inch for 280-101

LED module; with red LED; 10 mm wide; I_N 5.6 mA; I_F 25 mA; gray

	Item No.	Pack. Unit
○ 24 VDC	280-803/281-413	100
○ 48 VDC	280-803/281-414	100

LED module; with red LED; 10 mm wide; I_N 5.6 mA; I_F 25 mA; gray

○ 24 VAC/DC	280-803/281-415	100
○ 48 VAC/VDC	280-803/281-416	100

Neon indicator module; 10 mm wide; I_N 0.5 mA; gray

○ 120 VAC/VDC	280-803/281-418	100
○ 230 VAC/VDC	280-803/281-417	100

Through terminal blocks, see page 339

Circuit Diagrams

LED module

	24 VDC	280-803/281-413
	48 VDC	280-803/281-414

LED module

	24 VAC/DC	280-803/281-415
	48 VAC/VDC	280-803/281-416

Neon indicator module

	120 VAC/VDC	280-803/281-418
	230 VAC/VDC	280-803/281-417



Similar to push-in type jumpers, these LED and neon indicator modules are simply pushed into the current bar's contact slots of two adjacent through terminal blocks, providing the following advantages:

- Compatibility with all 280 Series Through Terminal Blocks
- Easy retrofits for existing systems
- Separation into functional and wiring levels
- Fast replacement of other functional units

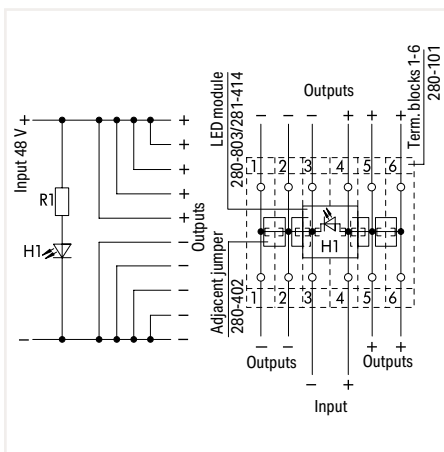

Multiple outputs with indicator lamp

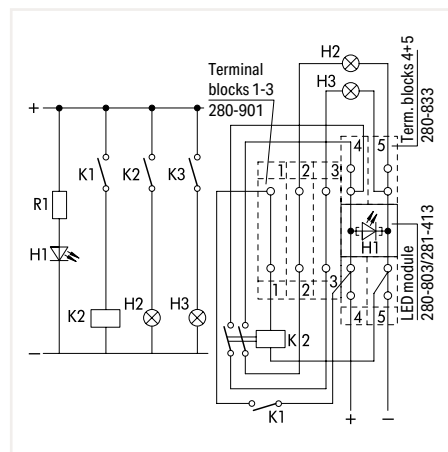

Control unit

L-Type Test Plug Module for Testing 5 mm or 6 mm Wide Rail-Mount Terminal Blocks via Conductor Entry

249 Series

Technical Data	
0.08 ... 1.5 mm ²	28 ... 16 AWG
Test voltage: 630 V	Test current: 6 A
Module width: 5 mm / 0.197 inch	
This test plug is not suitable for Ex e applications.	

Technical Data	
0.08 ... 2.5 mm ²	28 ... 14 AWG
Test voltage: 630 V	Test current: 6 A
Module width: 6 mm / 0.236 inch	
This test plug is not suitable for Ex e applications.	

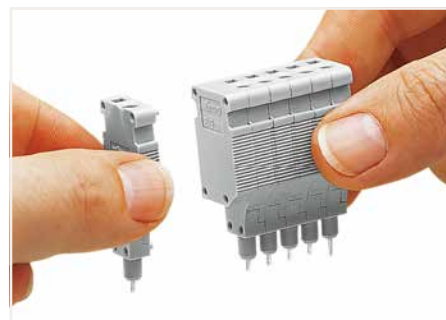

Snapping test plug and spacer modules together to assemble a multipole test plug module (max. 10 poles).



L-type test plug module; with spring-loaded contact pin; center module; snaps together
Module width: 5 mm

Color	Item No.	Pack. Unit
○ gray	249-141	100 (25)

L-type test plug module; with spring-loaded contact pin; center module; snaps together
Module width: 6 mm

Color	Item No.	Pack. Unit
○ gray	249-144	100 (25)

L-type end test plug module; with rigid contact pin; end module; snaps together
Module width: 5 mm

○ gray	249-142	100 (25)
--------	---------	----------

L-type end test plug module; with rigid contact pin; end module; snaps together
Module width: 6 mm

○ gray	249-145	100 (25)
--------	---------	----------

L-type spacer module; snaps together; bridges wired terminal blocks
Module width: 5 mm

○ gray	249-143	100 (25)
--------	---------	----------

L-type spacer module; snaps together; bridges wired terminal blocks
Module width: 6 mm

○ gray	249-146	100 (25)
--------	---------	----------

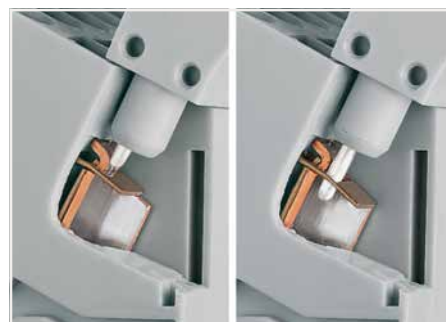

A = Center module with a spring-loaded contact pin
B = End module with a rigid contact pin

Accessories; for L-type test plug modules

Appropriate marking systems: WMB/WMB Inline/Mini-WSB/Mini-WSB Inline

WMB marking card; white; 10 strips with 10 markers/card; stretchable 5 ... 5.2 mm

plain	793-5501	5
-------	----------	---

Mini-WSB marking card; 10 strips with 10 markers/card; 5 mm wide markers

plain	248-501	5
-------	---------	---

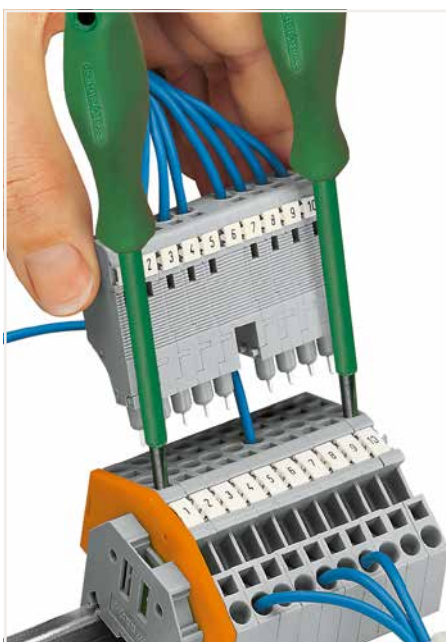

For easily testing terminal block assemblies, WAGO's L-type test plug modules with CAGE CLAMP® may be used on unwired terminal blocks. For testing, the module is assembled with spring-loaded pins in the center positions and rigid pin modules at the ends. The terminal blocks corresponding to the end position modules are opened using operating tools (as shown) – these rigid pins are then held in place by the CAGE CLAMP®. The intermediate pins are spring-loaded and make contact with the current bars of the unwired clamping units. Clamping units needing to remain wired may be skipped by assembling a spacer in the test plug module.

Notice:
Mating direction must be observed (see picture).

CAGE CLAMP® connection
0.08 ... 1.5 mm²; 5 mm wide module
0.08 ... 2.5 mm²; 6 mm wide module

Power must be switched off when installing the test plug adapter. The safety guidelines for working on live installations must be observed.

B-Type Test Plug Module for Testing 5 mm or 6 mm Wide Rail-Mount Terminal Blocks via Jumper Contact Slot in Current Bar 249 Series

Technical Data	
0.08 ... 1.5 mm ²	28 ... 16 AWG
Test voltage: 630 V	Test current: 10 A
Module width: 5 mm / 0.197 inch	
This test plug is not suitable for Ex e applications.	



Technical Data	
0.08 ... 2.5 mm ²	28 ... 14 AWG
Test voltage: 630 V	Test current: 10 A
Module width: 6 mm / 0.236 inch	
This test plug is not suitable for Ex e applications.	

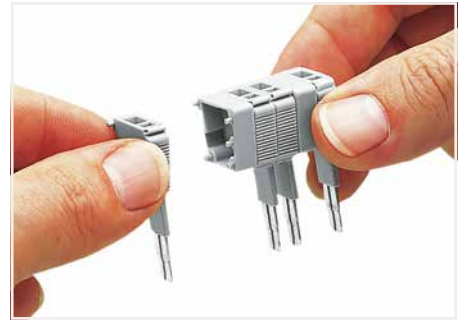

Snapping test plug and spacer modules together to assemble a multipole test plug module (max. 10 poles).

B-type test plug module; snaps together Module width: 5 mm		
Color	Item No.	Pack. Unit
○ gray	249-106	100 (25)

B-type spacer module; snaps together; bridges commoned terminal blocks, Module width: 5 mm		
Color	Item No.	Pack. Unit
○ gray	249-107	100 (25)

B-type test plug module; snaps together Module width: 6 mm		
Color	Item No.	Pack. Unit
○ gray	249-147	100 (25)

B-type spacer module; snaps together; bridges commoned terminal blocks, Module width: 6 mm		
Color	Item No.	Pack. Unit
○ gray	249-148	100 (25)

Accessories; for B-type test plug modules
Appropriate marking systems: WMB/WMB Inline/Mini-WSB/Mini-WSB Inline

WMB Inline, plain; 1,500 WMB markers (5 mm)/reel; 5 ... 5.2 mm stretchable			
Color	Item No.	Pack. Unit	Quantity
white	2009-115	1	1

WMB marking card; white; 10 strips with 10 markers/card; stretchable 5 ... 5.2 mm			
Color	Item No.	Pack. Unit	Quantity
plain	793-5501	5	5

Mini-WSB Inline, plain; 1,700 Mini-WSB markers (5 mm wide) per reel; stretchable 5 ... 5.2 mm			
Color	Item No.	Pack. Unit	Quantity
white	2009-145	1	1

Mini-WSB marking card; 10 strips with 10 markers/card; 5 mm wide markers			
Color	Item No.	Pack. Unit	Quantity
plain	248-501	5	5

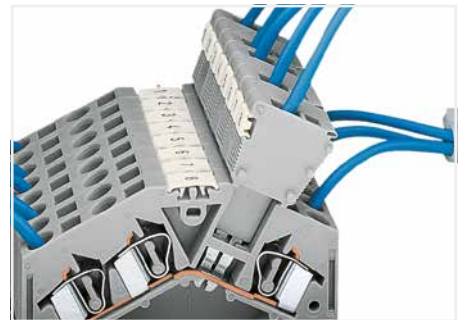

B-type test plugs are directly plugged into the jumper contact slot of the current bar.

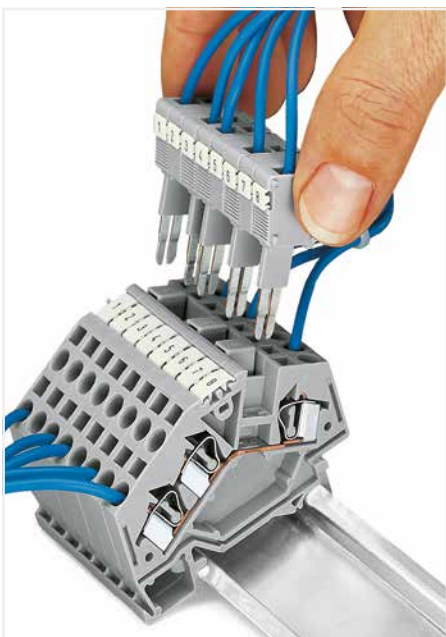

For testing individual circuits, offers a single-pole test plug accessory with CAGE CLAMP® up to 2.5 mm² (14 AWG) for direct contact with the current bar of a terminal block, or 1-pole test plug adapters for 4 mm Ø test plugs.

For serial testing on terminal block assemblies, has developed special multipole (max. 10-pole) modular test plug modules. WAGO's B-type test plug modules with CAGE CLAMP® connection are ideal for testing completely wired terminal blocks – even when using adjacent jumpers. For this testing type, the module assembly exactly matches the terminal block assembly. The test plug modules make direct contact to the jumper contact slots of the terminal blocks to be tested.

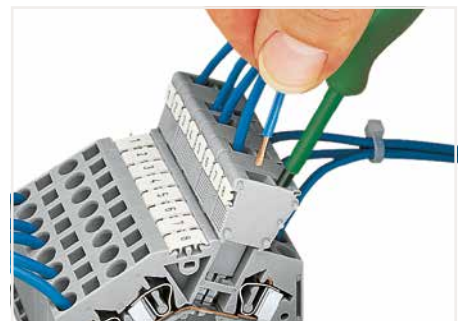

CAGE CLAMP® connection
0.08 ... 1.5 mm²; 5 mm wide module
0.08 ... 2.5 mm²; 6 mm wide module

Power must be switched off when installing the test plug adapter. The safety guidelines for working on live installations must be observed.

Test Plug Module for Testing 5 mm or 6 mm Wide Rail-Mount Terminal Blocks via Jumper Contact Slot in Current Bar

Technical Data	
Test voltage: 400 V	Test current: 6 A
Module width: 5 mm / 0.197 inch	
This test plug is not suitable for Ex e applications.	

Technical Data	
Test voltage: 400 V	Test current: 6 A
Module width: 6 mm / 0.236 inch	
This test plug is not suitable for Ex e applications.	

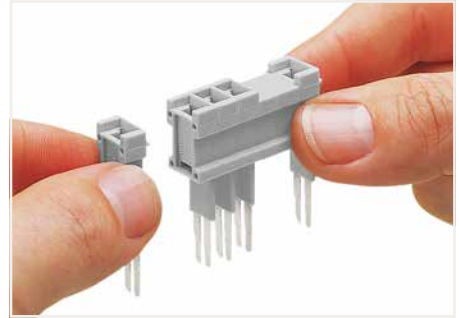

Snapping test plug and spacer modules together to assemble a multipole test plug module.

Test plug module; snaps together Module width: 5 mm		
Color	Item No.	Pack. Unit
○ gray	280-418	100 (25)

Test plug module; snaps together Module width: 6 mm		
Color	Item No.	Pack. Unit
○ gray	281-418	100 (25)

Spacer module; snaps together; bridges terminal blocks Module width: 5 mm		
Color	Item No.	Pack. Unit
○ gray	280-419	100 (25)

Spacer module; snaps together; bridges terminal blocks Module width: 6 mm		
Color	Item No.	Pack. Unit
○ gray	281-419	100 (25)

Accessories; for test plug modules

Test plug; with 500 mm cable; 2 mm Ø; max. 42 V		
	red	210-136 50

Test plug; with 500 mm cable; 2.3 mm Ø; max. 42 V		
	yellow	210-137 50

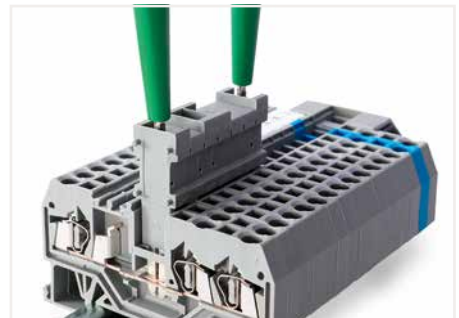

The test plug modules are directly plugged into the jumper contact slot of the current bar.

5

B-Type Test Plug Module for Testing 8 mm or 10 mm Wide Rail-Mount Terminal Blocks via Jumper Contact Slot in Current Bar 709 Series

Technical Data

0.2 ... 6 mm ²	24 ... 10 AWG
Test voltage: 800 V	Test current: 32 A
Module width: 8 mm / 0.315 inch	
This test plug is not suitable for Ex e applications.	

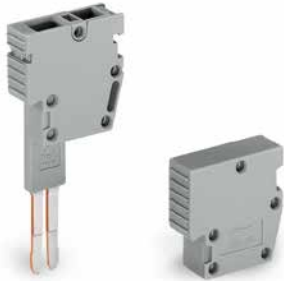

Technical Data

Module width: 2 mm / 0.079 inch
This intermediate plate is not suitable for Ex e applications.

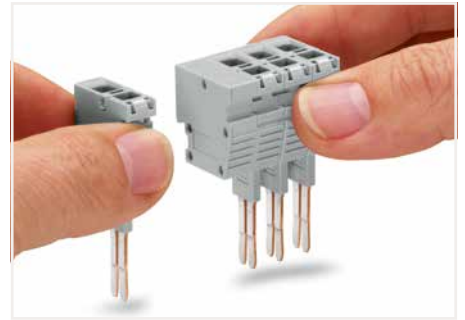

Snapping test plug and spacer modules together to assemble a multi-pole test plug module (max. 10 poles) for 8 mm terminal block width.

B-type test plug module; snaps together
Module width: 8 mm

Color	Item No.	Pack. Unit
○ gray	709-310	100 (25)

B-type spacer plate; snaps together; snaps on B-type test plug modules (709-310) and B-type spacer modules (709-311)
Module width: 2 mm

Color	Item No.	Pack. Unit
○ gray	709-312	100 (25)

B-type spacer module; snaps together; bridges commoned terminal blocks,
Module width: 8 mm

○ gray	709-311	100 (25)
--------	---------	----------

Accessories; item-specific

Strain relief plate; gray; for 8 mm wide terminal blocks

	2-pole	709-322	100 (25)
	4-pole	709-324	100 (25)
	6-pole	709-326	100 (25)

Accessories; item-specific

Strain relief plate; gray; for 10 mm wide terminal blocks

	2-pole	709-332	100 (25)
	4-pole	709-334	100 (25)
	6-pole	709-336	100 (25)

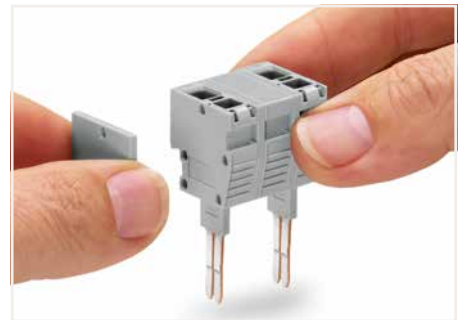

Snapping test plug and spacer modules (each with a spacer plate) together to assemble a multi-pole test plug module (max. 10 poles) for 10 mm terminal block width.



For testing individual circuits, offers a single-pole test plug accessory with CAGE CLAMP® up to 2.5 mm² (14 AWG) for direct contact with the current bar of a terminal block, or 1-pole test plug adapters for 4 mm Ø test plugs.

For serial testing on terminal block assemblies, has developed special multipole (max. 10-pole) modular test plug modules. WAGO's B-type test plug modules with CAGE CLAMP® connection are ideal for testing completely wired terminal blocks – even when using adjacent jumpers. For this testing type, the module assembly exactly matches the terminal block assembly. The test plug modules make direct contact to the jumper contact slots of the terminal blocks to be tested.

Power must be switched off when installing the test plug adapter. The safety guidelines for working on live installations must be observed.



The test plug modules are directly plugged into the jumper contact slot of the current bar (picture shows 284 Series).

Conductor Insulation Stop for Conductors 0.08 ... 1.5 mm² / 28 ... 16 AWG

Technical Data

Terminal block width: 4 mm / 0.157 inch



Technical Data

Terminal block width: 5 mm / 0.197 inch



Technical Data

Terminal block width: 6 mm / 0.236 inch



Insulation stop; 0.08 ... 0.2 mm² "s" (0.14 mm² "f-st"); 5 pcs/strip

Color	Item No.	Pack. Unit
○ white	279-470	200 (25)

Insulation stop; 0.08 ... 0.2 mm² "s" (0.14 mm² "f-st"); 5 pcs/strip

Color	Item No.	Pack. Unit
○ white	280-470	200 (25)

Insulation stop; 0.08 ... 0.2 mm² "s" (0.14 mm² "f-st"); 5 pcs/strip

Color	Item No.	Pack. Unit
○ white	281-470	200 (25)

Insulation stop; 0.25 mm²; 5 pcs/strip

● dark gray	279-471	200 (25)
-------------	---------	----------

Insulation stop; 0.25 ... 0.5 mm²; 5 pcs/strip

○ light gray	280-471	200 (25)
--------------	---------	----------

Insulation stop; 0.25 ... 0.5 mm²; 5 pcs/strip

○ light gray	281-471	200 (25)
--------------	---------	----------

Insulation stop; 0.75 ... 1 mm²; 5 pcs/strip

● dark gray	280-472	200 (25)
-------------	---------	----------

Insulation stop; 0.75 ... 1.5 mm²; 5 pcs/strip

● dark gray	281-472	200 (25)
-------------	---------	----------

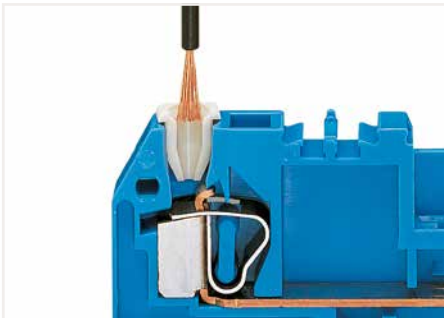

Insert stripped, untwisted conductor into insulation stop.



The problem: Wiring programmable logic controllers and microprocessor-operated control circuits often relies on very small, fine-stranded conductors. These conductors are highly flexible and deform when pushed against the conductor stop in terminal blocks. As a result, the conductor insulation – not the copper conductor – may be clamped, causing intermittent contact or no contact at all. Common to all terminal block types currently offered, this problem creates unnecessary downtime for troubleshooting.

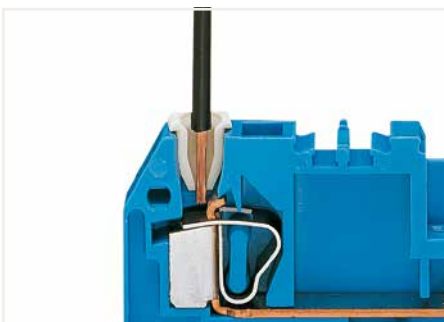

The conductor is bundled.

The solution: An insulation stop for rail-mount terminal blocks. Insulation stops automatically bundle the cores of fine-stranded conductors when inserted into the clamping unit, preventing splaying. This also limits the conductor entry to a defined cross sectional area – ensuring the actual conductor, not the insulation, will enter the clamping unit

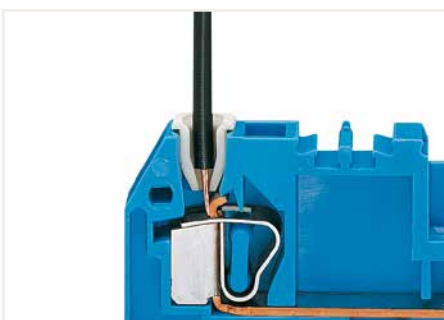

The conductor insulation is prevented from being pushed into the clamping unit by the positive stop.

Insulation stops are available as dividable 5-pole strips for 279, 280/780/870/880 and 281/781 Series Rail-Mount Terminal Blocks.

Insulation stop usage will not affect the conductor strip lengths for the aforementioned rail-mount terminal blocks.

Comb-Style Jumper Bar and Alternate Comb-Style Jumper Bar Operating Tool



Comb-style jumper bar; insulated; $I_N = I_N$ of terminal block; for 279 Series

	Item No.	Pack. Unit
○ 2-way	279-482	200 (25)
○ 3-way	279-483	200 (25)
○ 10-way	279-490	50 (25)



Comb-style jumper bar; insulated; $I_N = I_N$ of terminal block; for 280/769/780/880 Series

	Item No.	Pack. Unit
○ 2-way	280-482	200 (25)
○ 3-way	280-483	200 (25)
○ 10-way	280-490	50 (25)



Comb-style jumper bar; insulated; $I_N = I_N$ of terminal block; for 281/781 Series

	Item No.	Pack. Unit
○ 2-way	281-482	100 (25)
○ 3-way	281-483	100 (25)
○ 5-way	281-485	100 (25)
○ 10-way	281-490	50 (25)

Alternate comb-style jumper bar; insulated; $I_N = I_N$ of terminal block

○ 2-way	279-492	200 (25)
---------	---------	----------

Alternate comb-style jumper bar; insulated; $I_N = I_N$ of terminal block

○ 2-way	280-492	200 (25)
---------	---------	----------

Alternate comb-style jumper bar; insulated; $I_N = I_N$ of terminal block

○ 2-way	281-492	100 (25)
---------	---------	----------

Operating tool; insulated

2-way	279-432	1
3-way	279-433	1
10-way	279-440	1

Operating tool; insulated

2-way	280-432	1
3-way	280-433	1
10-way	280-440	1

Operating tool; insulated

2-way	280-432	1
3-way	280-433	1
5-way	281-440	1

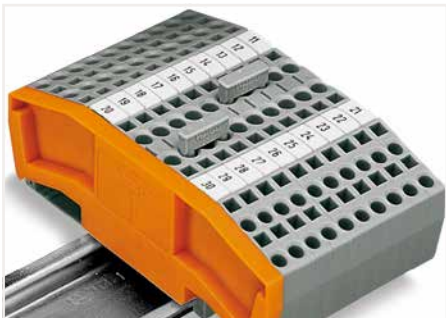

Commoning using comb-style jumper bars. Push comb-style jumper bars down until fully inserted.



4-conductor through terminal blocks, angled type – formation of groups with 3-way, comb-style jumper bars

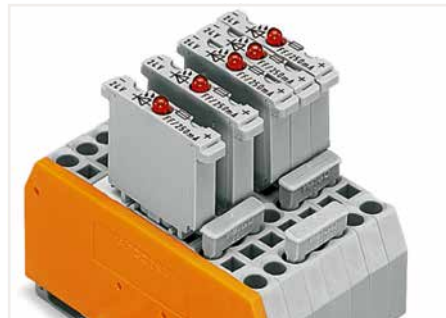

Carrier terminal blocks with component plugs, alternate comb-style jumper bars, 3-way, comb-style jumper bar

5

Sold & Serviced By:



Toll Free Phone (877) SERV098
www.electromate.com
sales@electromate.com

Staggered Jumper

Technical Data

400 V/6 kW/3



❶ Suitable for Ex e II applications
Rated voltage (max.): 275 V
23 A, for 2-conductor terminal blocks
22 A, for 3-conductor terminal blocks
20 A, for 4-conductor terminal blocks
(see Section 14)

❷ Suitable for Ex e II applications
Rated voltage (max.): 275 V; 26 A
(see Section 14)

Staggered jumper; insulated; 5 mm wide; I_n 24 A

	Item No.	Pack. Unit
<input type="radio"/> 1 to 2	780-452 ❶	100 (25)
<input type="radio"/> 1 to 3	780-453 ❶	100 (25)
<input type="radio"/> 1 to 4	780-454 ❶	100 (25)
<input type="radio"/> 1 to 5	780-455 ❶	50 (25)
<input type="radio"/> 1 to 4	780-456 ❶	50 (25)
<input type="radio"/> 1 to 7	780-457 ❶	50 (25)
<input type="radio"/> 1 to 4	780-458 ❶	50 (25)

Staggered jumper; insulated; 6 mm wide; I_n 32 A

<input type="radio"/> 1 to 2	781-452 ❷	100 (25)
<input type="radio"/> 1 to 3	781-453 ❷	100 (25)
<input type="radio"/> 1 to 4	781-454 ❷	100 (25)
<input type="radio"/> 1 to 5	781-455 ❷	50 (25)
<input type="radio"/> 1 to 6	781-456 ❷	50 (25)

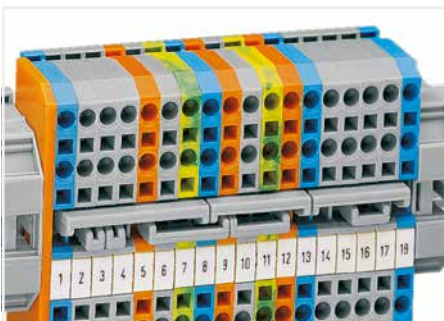

Staggered jumpers for sophisticated circuit requirements
– push jumpers down until fully inserted.

Push-In Type Wire Jumper

Technical Data	
800 V/8 kV/3	
I_n 9 A	

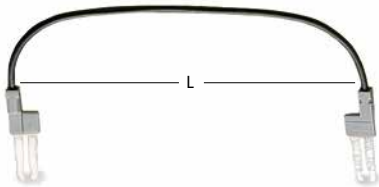

Push-in type wire jumper; insulated; 0.75 mm ² conductor cross section		
	Item No.	Pack. Unit
L = 60 mm	249-125	10

Push-in type wire jumper; insulated; 0.75 mm ² conductor cross section		
L = 110 mm	249-126	10

Push-in type wire jumper; insulated; 0.75 mm ² conductor cross section		
L = 250 mm	249-127	10

Terminal Blocks Series	Wire Jumpers Item No.	"n"
279 (1.5 mm ² /16 AWG)	249-125	13
	249-126	25
	249-127	60
280, 775, 780 (2.5 mm ² /14 AWG) 769, 880 (4 mm ² /12 AWG)	249-125	10
	249-126	20
	249-127	48
281, 781, 776, 777 (4 mm ² /12 AWG)	249-125	9
	249-126	17
	249-127	40

"n" = number of 279, 280/769/780/880 and 281/781 Series Rail-Mount Terminal Blocks that can be skipped with a wire jumper.

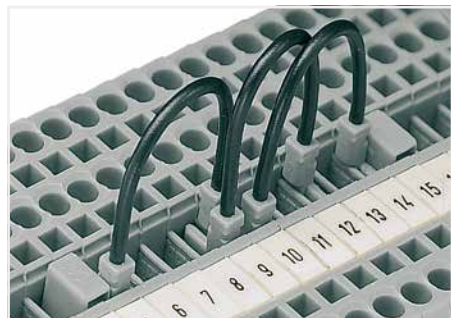

The 280/775/780 and 281/776/777/781 Series Terminal Blocks accept two wire jumpers, allowing the use of commoning chains. Furthermore, the 280/769/775/780/880 and 281/776/777/781 Series allow both wire jumper and adjacent jumper to be simultaneously plugged into a same terminal block.





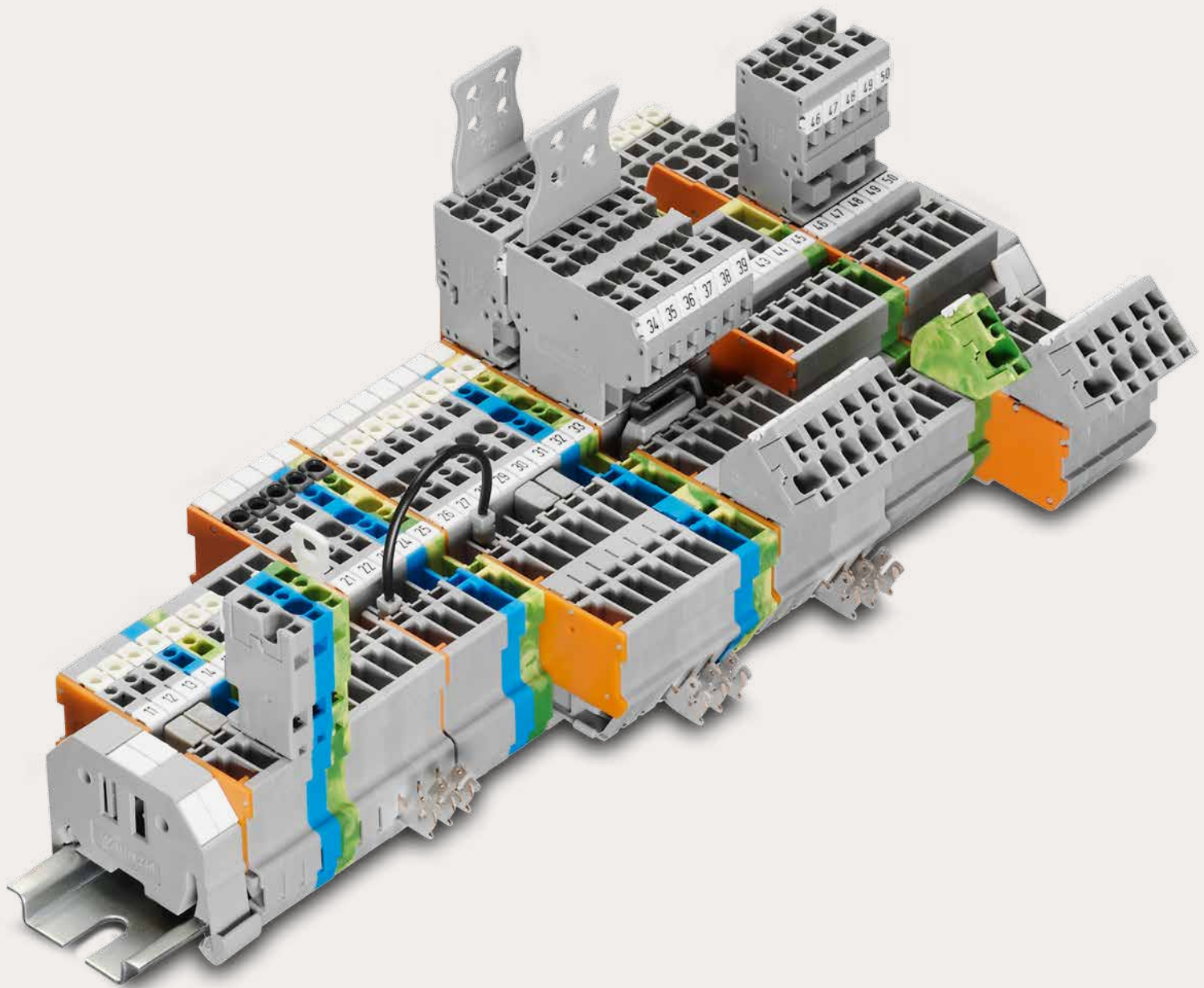

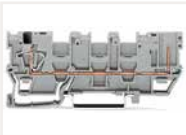
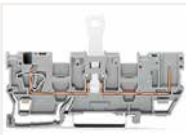

Push-in type wire jumper:
When installing machines or control systems, it is often necessary to make an additional connection between two terminal blocks that are not next to each other on the rail. In such cases, WAGO's touch-proof, push-in type wire jumpers are the ideal solution.

This jumper is compatible with the following rail-mount terminal blocks:
 - 279 Series (1.5 mm²/16 AWG),
 - 280/775/780 Series (2.5 mm²/14 AWG)
 - 281/769/776/777/781 and 880 Series (4 mm²/12 AWG)
 They are available in three conductor lengths (60, 110 and 250 mm), allowing up to 60 terminal blocks to be commoned depending on their width (see table on the right).

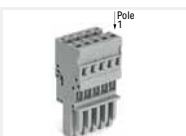

WAGO Rail-Mount Terminal Blocks with a Pluggable Connector X-COM[®]-SYSTEM

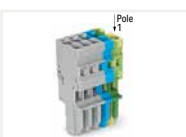
WAGO Rail-Mount Terminal Blocks with a Pluggable Connector X-COM®-SYSTEM Front-Entry Wiring

			Page
	Carrier Terminal Blocks 0.08 ... 4 mm ² (28 ... 12 AWG)	769 Series	358
	Carrier Terminal Blocks; with Three Jumper Positions 0.08 ... 4 mm ² (28 ... 12 AWG)	769 Series	368
	Disconnect Carrier Terminal Blocks; with Two Jumper Positions 0.08 ... 4 mm ² (28 ... 12 AWG)	769 Series	370
	Diode and LED Carrier Terminal Blocks 0.08 ... 4 mm ² (28 ... 12 AWG)	769 Series	372
	Carrier Terminal Blocks for a Pluggable Module 0.08 ... 4 mm ² (28 ... 12 AWG)	769 Series	380
	Double-Deck Carrier Terminal Blocks 0.08 ... 2.5 (4 "f-st") mm ² (28 ... 12 AWG)	870 Series	388
	Male Connectors; with CAGE CLAMP® Connection 0.08 ... 4 mm ² (28 ... 12 AWG)	769 Series	398
	Male Headers; with Solder Pins 0.08 ... 4 mm ² (28 ... 12 AWG)	769 Series	402
	Female Plugs; with/without Lateral Locking Levers 0.08 ... 4 mm ² (28 ... 12 AWG)	769 Series	408
	Female Plugs for Self-Assembly 0.08 ... 4 mm ² (28 ... 12 AWG)	769 Series	412
	Pre-Assembled Female Plugs 0.08 ... 4 mm ² (28 ... 12 AWG)	769 Series	414
	Strain Relief Housings	769 Series	416

COM-bining Connectors and Rail-Mount Terminal Blocks X-COM®-SYSTEM

The X-COM-SYSTEM® is the perfect solution for switchgear and control applications.

X-COM® is designed for a **rated current up to 16/32 A at U_N 500 V and 4 mm² (12 AWG) rated cross section (up to 600 V, 10 A, and 12 AWG UL)**. This offers an alternative to heavy-duty rectangular and circular connectors used in power wiring applications where electrical compliance is more important than a high degree of protection.

X-COM® conveniently enables the use of pre-assembled connector systems and offers the following advantages:

- During manufacturing: Pre-wired subassemblies can be tested before installation.
- During assembly: Pre-assembled pluggable cable harnesses help solve time and space issues on site. Connector systems with protection against mismatching can be handled by installers of all skill levels.
- During maintenance: Subassemblies can be replaced quickly and without errors.

The X-COM®-SYSTEM consists of rail-mount carrier terminal blocks, male connectors and female plugs with different mounting systems, as well as male headers with solder pins. Pin spacing is generally 5 mm (0.197 inch).

Protection Against Mismatching and Accidental Contact

The WAGO-X-COM®-SYSTEM is **fully protected against accidental contact – even when plugs are disconnected**. This dramatically simplifies the planning of power distribution.

Furthermore, the whole system is **100% protected against mismatching**. Its coding, without the loss of any poles, prevents mismatching of male connectors and female plugs having the same number of poles.

Carrier Terminal Blocks

Carrier terminal blocks are available as through terminal blocks, double-deck terminal blocks and ground conductor terminal blocks with automatic contact to the DIN-rail. Carrier terminal blocks with specialty functions are available in disconnect, diode and LED versions. Carrier terminal blocks equipped with an additional socket can accommodate a wide range of pluggable electronic modules (e.g., relays, optocouplers, signal conditioners).

Depending on the type of terminal block, the carrier terminal blocks are equipped with one to three jumper positions for commoning signals via insulated push-in type jumpers.

Applications

X-COM®-SYSTEM connects to:

- Frequency converters
- Thyristor actuators
- Soft start motor controllers
- Motors
- Phase filters
- Power subassemblies
- Power supply units
- Uninterruptible power supply (UPS)
- "Panel-to-door" wiring
- Pluggable high-current, feed-through connections
- Flying leads

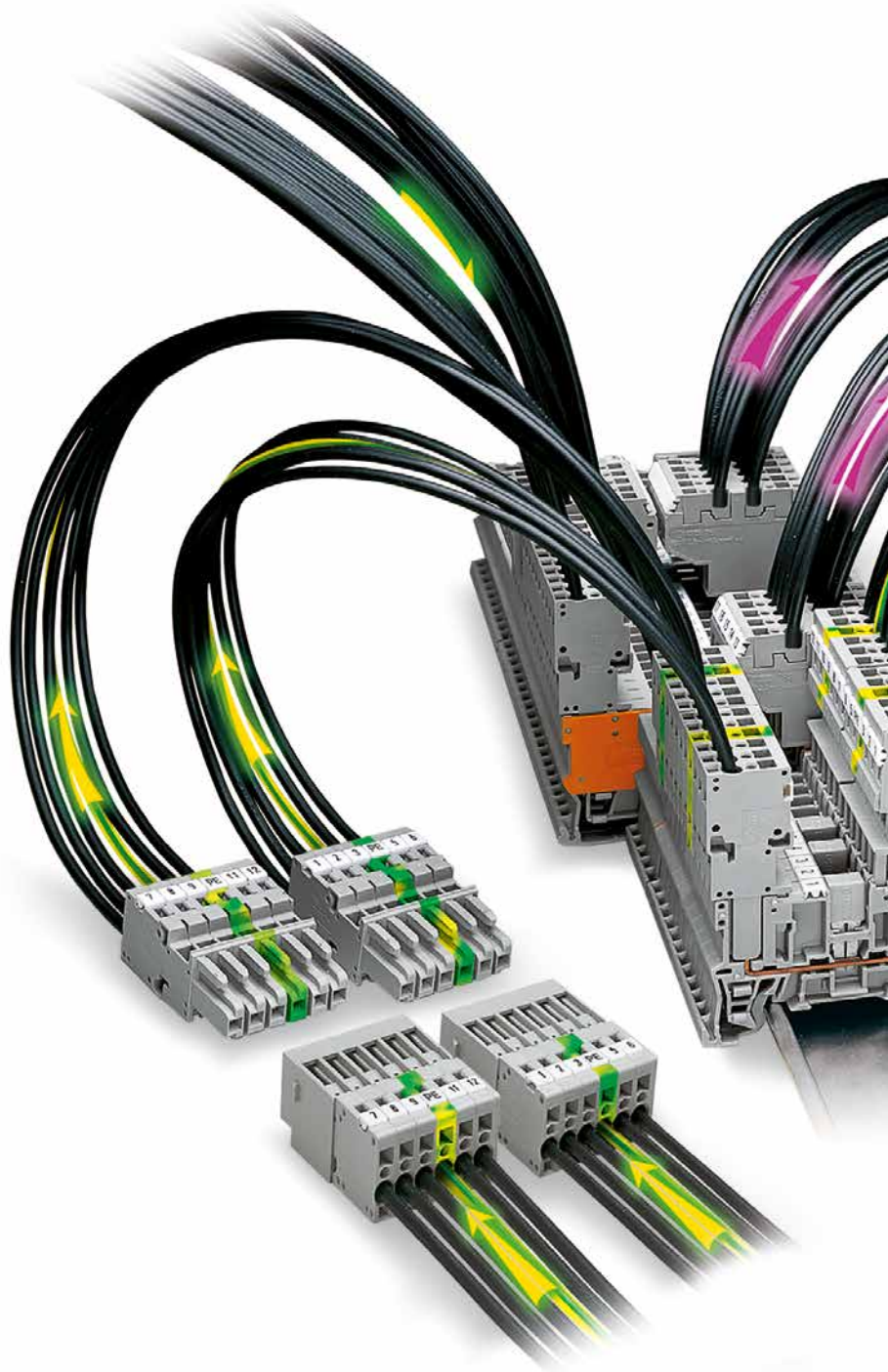

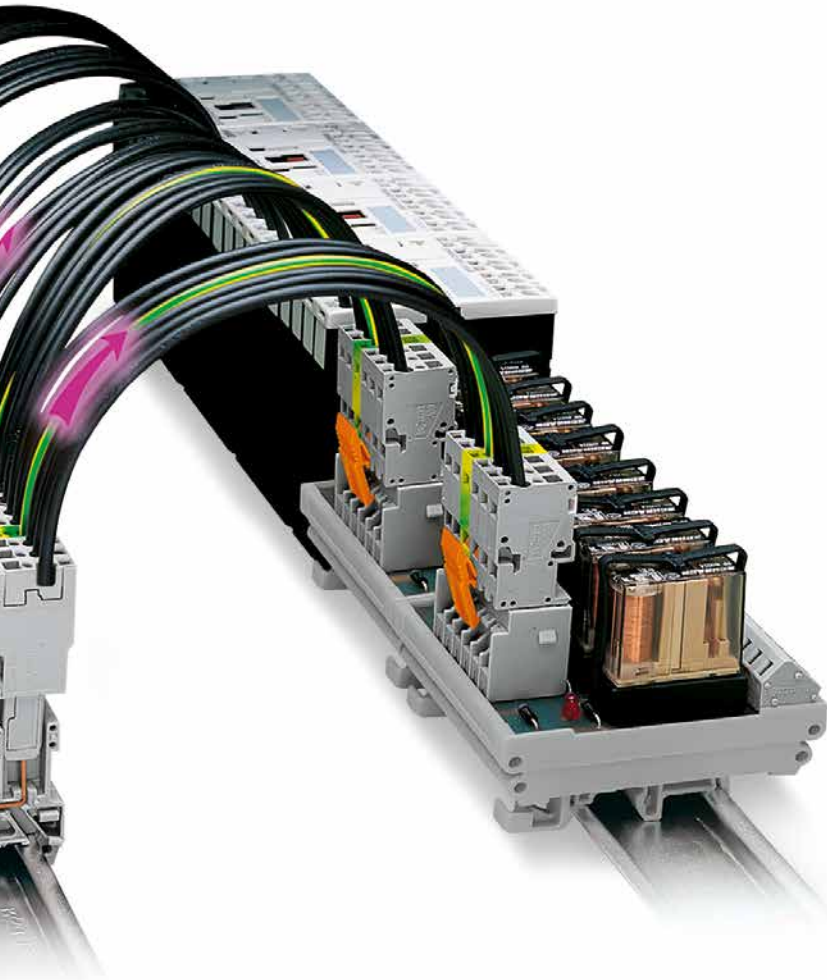

Female Plugs

The mating half of the carrier terminal blocks consists of modular female plugs (1- to 15-pole, 1-/2-conductor, straight/angled). Angled female plugs combined with double-deck terminal blocks offer high-density wiring and reduce overall terminal block height. A jumper slot simplifies potential distribution.

This makes commoning supply lines particularly easy as the power supply of downstream subassemblies is maintained even after female plugs have been removed.

1-Pole Female Plugs

Special 1-pole female plugs can carry the full rated current of the terminal blocks for many applications:

- as test plug adapters
- as connectors for motor lead tests
- for all types of patchboard applications
- for the creation of multipole prototypes
- for phase selection of 230 V loads in a three-phase network without interfering with the wiring
- for single-pole power supply in commercial or recreational vehicles. The grounding of all electrical components is connected through the chassis.

Male Connectors

Male connectors are available with snap-in mounting feet for panel mounting, with mounting flanges for feedthrough applications or without mounting elements for flying leads. Strain relief plates are available as accessories.

Subassemblies on printed circuit boards can be integrated into the system wiring using male headers with solder pins. As a result, parts can be exchanged quickly without wiring errors.

Degree of Protection

Mated: IP20

Unmated: IP20

Temperature range:

-35 ... +100 °C

Sold & Serviced By:

 **ELECTROMATE**

Toll Free Phone (877) SERV098

www.electromate.com

sales@electromate.com

Carrier Terminal Blocks and Female Plugs X-COM®-SYSTEM

769 Series

Description and Installation



Snap individual carrier terminal blocks onto the DIN-rail and slide together.

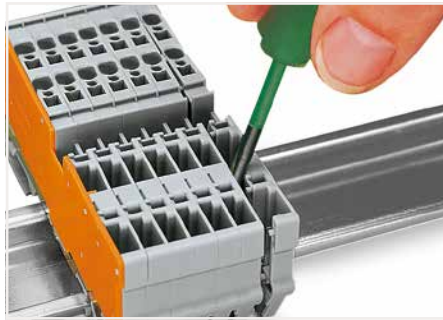

Open the assembly by laterally sliding a block via operating tool and remove terminal block via release lever.

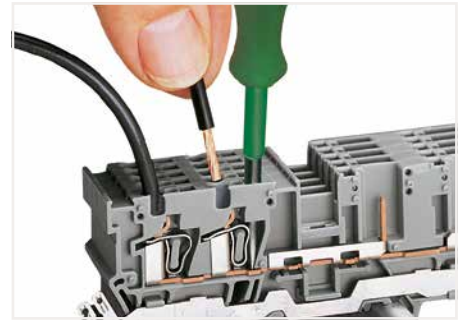

Carrier terminal block: Insert/remove conductor via operating tool (3.5 x 0.5 mm blade).



Coding a female plug by removing coding finger(s) via cutting tool. Do not remove the first and last coding fingers or use an additional locking lever.

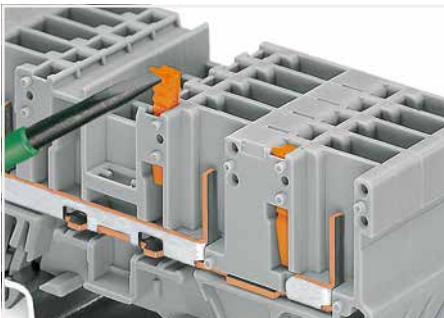

Snap coding pin in proper direction on carrier terminal block. Shown: Coding pin removal from carrier terminal block.

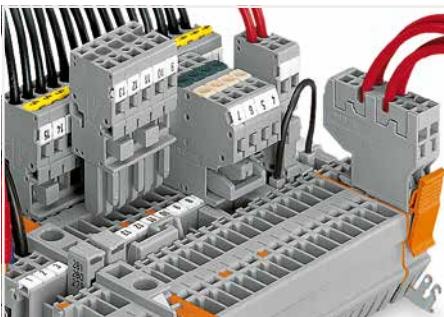
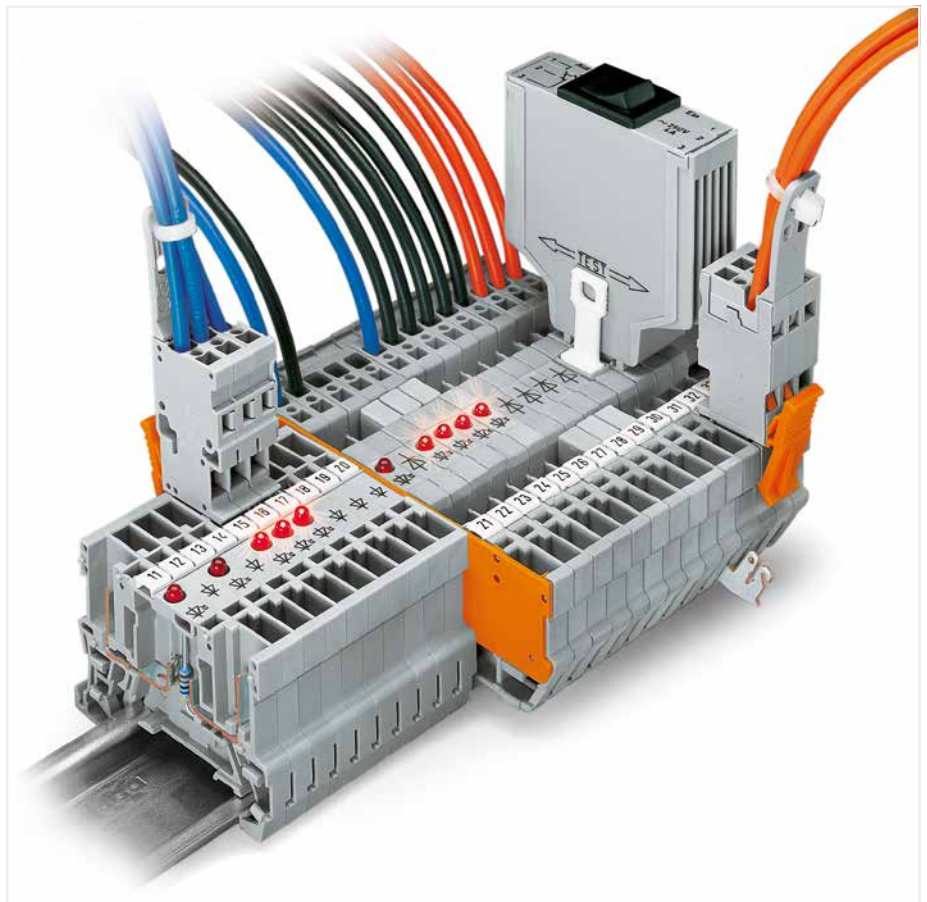

Commoning with adjacent or staggered jumpers – push jumpers down until fully inserted.

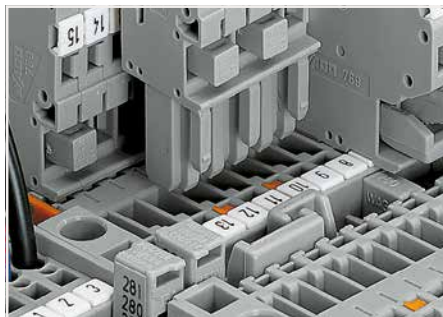

Commoning carrier terminal blocks via staggered jumpers.

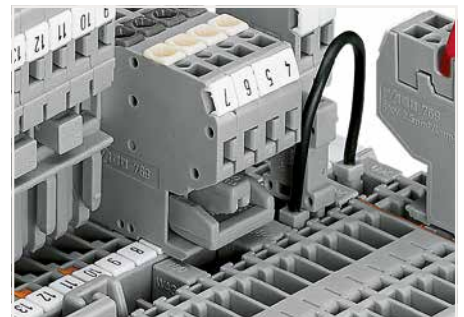

Commoning a 2-conductor female plug via staggered jumper and carrier terminal blocks via adjacent jumpers.



CAGE CLAMP® terminates the following copper conductors: solid



stranded



fine-stranded, also with tinned single strands

For aluminum conductors, see notes in Section 14. With ferruled conductors, it is necessary to use a terminal block one size smaller than the conductor's nominal cross section.

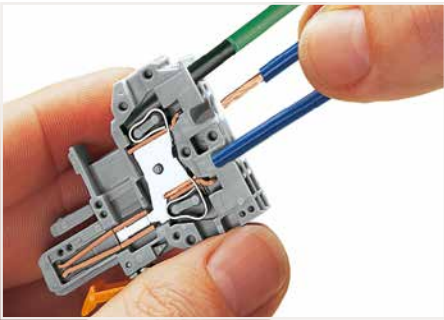

CAGE CLAMP® connection
 Female plug: Inserting/removing a conductor via operating tool.
 Operation 90° to conductor is also possible.
 With ferruled conductors, it is necessary to use a terminal block one size smaller than the conductor's nominal cross section.

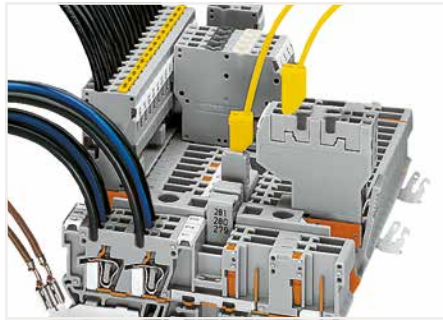

Testing via 2 or 2.3 mm Ø test plugs.

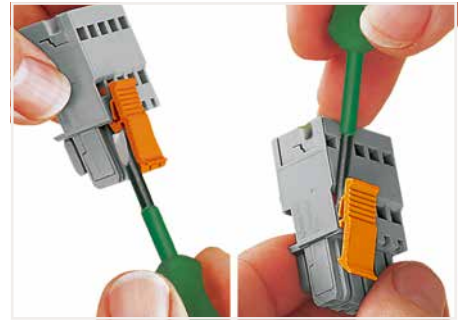

Locking/releasing a lever.

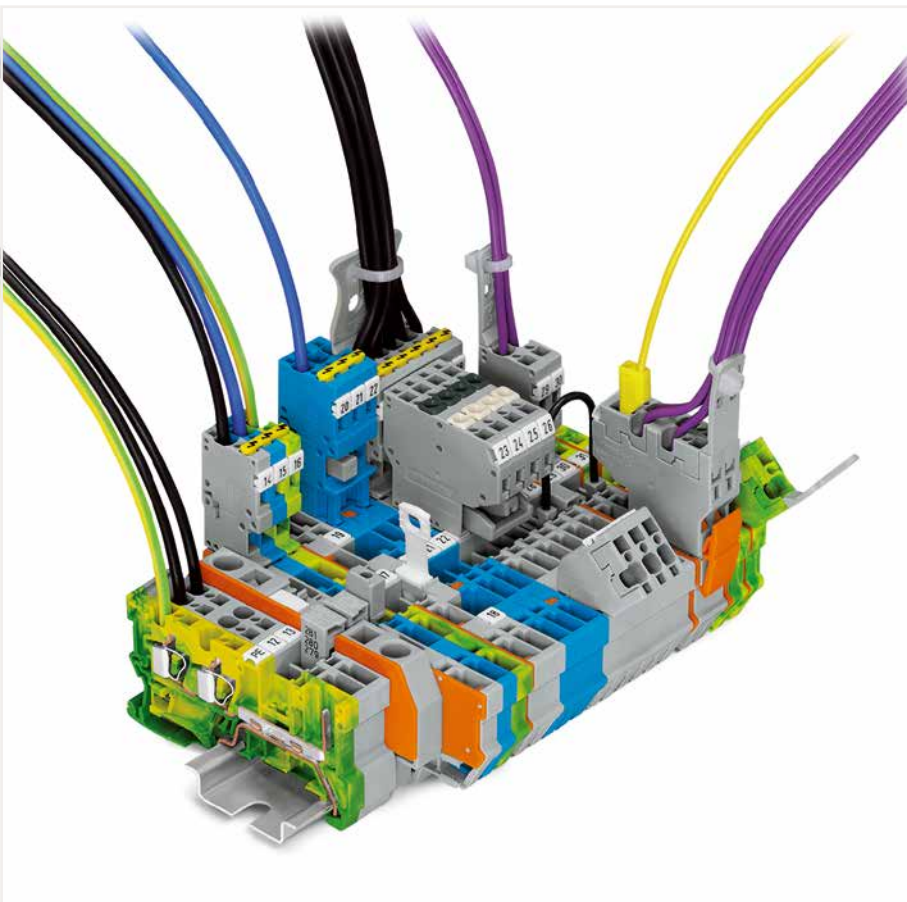

Note: Female plugs used according to the regulations must not be connected/disconnected when live or under load.

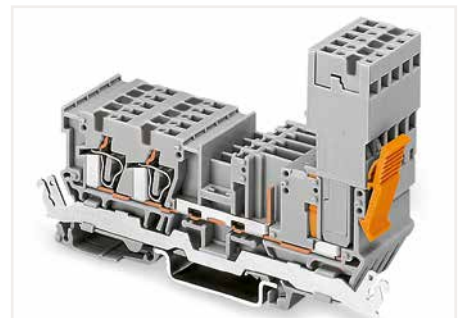

Female plug secured with locking lever on the terminal block side.



Removing a female plug via conductor bundle provided with strain relief plate.

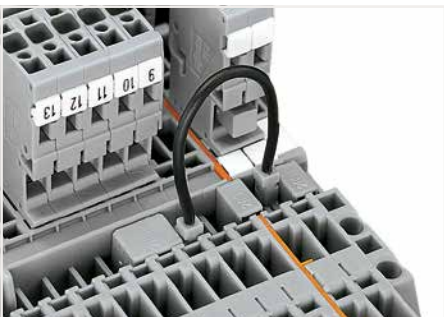

Commoning carrier terminal blocks via push-in type wire jumpers or adjacent jumpers – even over an intermediate plate.

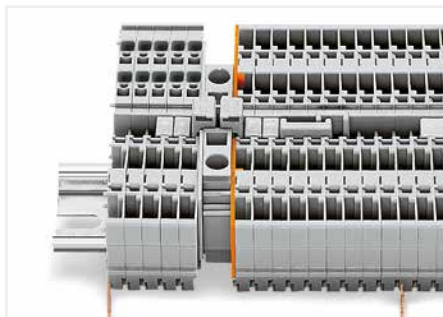

Commoning "supply terminal blocks" (up to 10 mm²/8 AWG) with carrier terminal blocks via step-down jumpers.



Commoning a 1-conductor female plug via miniature adjacent jumpers.



fine-stranded, tip-bonded



fine-stranded, with ferrule (gastight crimped)



fine-stranded, with pin terminal (gastight crimped)

6

Carrier Terminal Blocks, Female Plugs and Male Connectors X-COM®-SYSTEM

769 Series

Product Range Overview



1-conductor/1-pin carrier terminal block
1-conductor female plug; straight*
*1-conductor angled female plug is also possible!

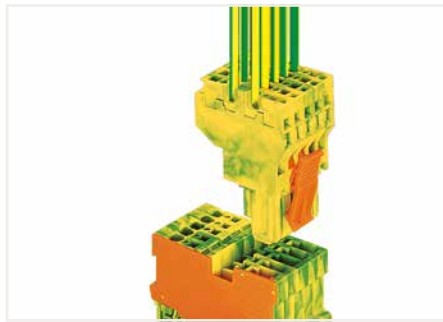

1-conductor/1-pin ground carrier terminal block
2-conductor female plug; green-yellow

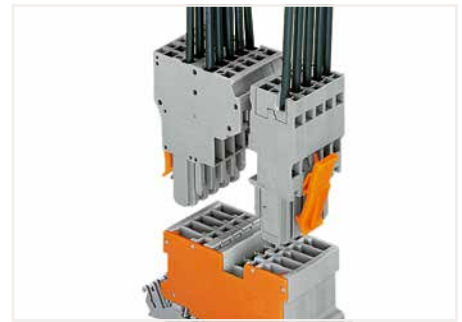

2-pin carrier terminal block; with shield contact
2-conductor female plug
1-conductor female plug; straight*
*1-conductor angled female plug is also possible!

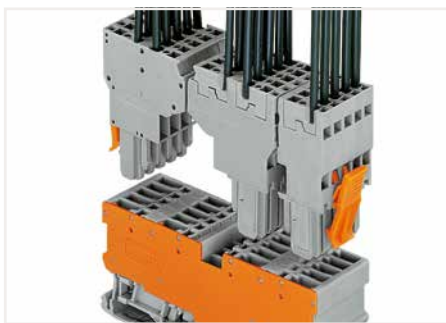

4-pin carrier terminal block
2-conductor female plug
1-conductor female plug; straight



4-pin ground carrier terminal block
1-conductor female plug; straight
2-conductor female plug

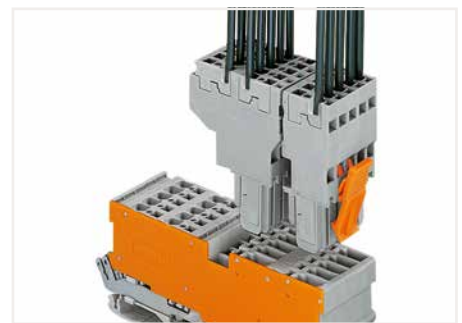

2-conductor/2-pin carrier terminal block; with shield contact
2-conductor female plug
1-conductor female plug; straight



1-conductor/1-pin disconnect carrier terminal block
1-conductor female plug; straight*
*1-conductor angled female plug is also possible!



2-pin diode carrier block
1-conductor female plug; straight*
*1-conductor angled female plug is also possible!



2-pin LED carrier block
1-conductor female plug; straight*
*1-conductor angled female plug is also possible!



2-pin disconnect carrier terminal block; with two jumper positions
1-conductor female plug; straight*
*1-conductor angled female plug is also possible!

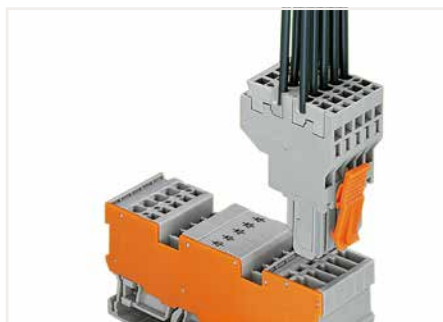

1-conductor/1-pin diode carrier terminal block; with two jumper positions
2-conductor female plug

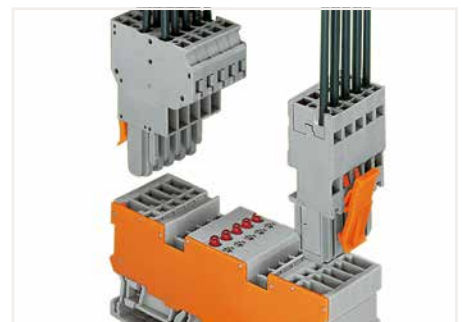

2-pin LED carrier terminal block; with two jumper positions
2-conductor female plug
1-conductor female plug; straight

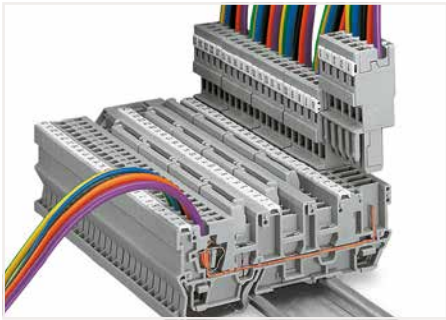

1-conductor/1-pin carrier terminal block; with three jumper positions
1-conductor female plug; straight*
*1-conductor angled female plug is also possible!



Male connector; with CAGE CLAMP® connection
1-conductor female plug; straight

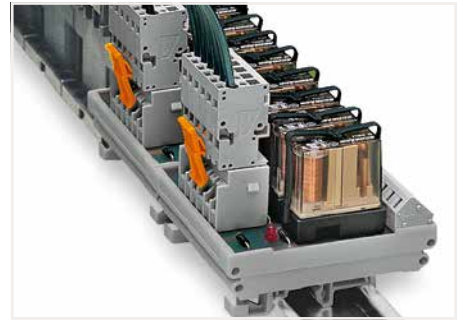

Male header; with straight solder pins and 1-conductor female plug (picture shows a relay module)



1-conductor/1-pin carrier terminal block; with two jumper positions
1-conductor female plug; straight*
Fuse plug; 6 mm wide (every other terminal block)
*1-conductor angled female plug is also possible!

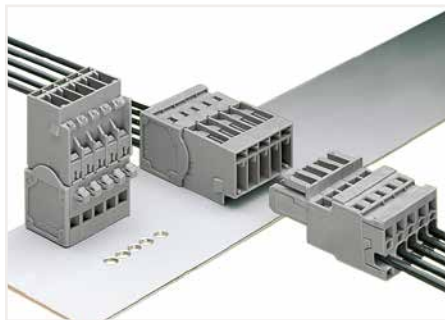

Male connector; with CAGE CLAMP® connection and snap-in mounting feet
1-conductor female plug; straight

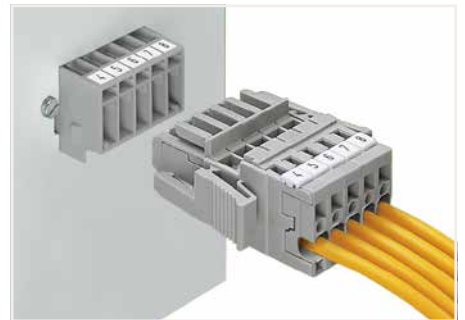

Male header and 1-conductor female plug; with lateral locking levers



2-pin terminal block for pluggable modules; with two jumper positions and separator plate
1-conductor female plug; straight*
Relay plug; 25 mm wide
*1-conductor angled female plug is also possible!

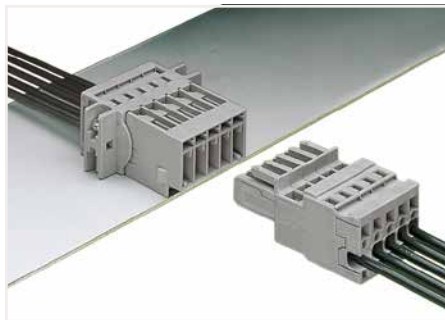

Male connector; with CAGE CLAMP® and mounting flanges
1-conductor female plug; straight

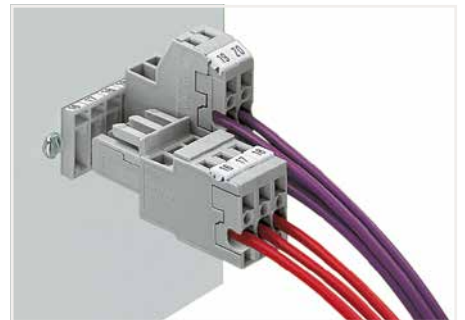

Male header; with feedthrough flanges
1-conductor female plug
2-conductor female plug



1-conductor/1-pin double-deck carrier terminal block
1-conductor female plug; angled*
*1-conductor straight female plug is also possible!



Cable entry into the control cabinet:
The cables are led into the control cabinet with the connected female plugs and are directly plugged onto the carrier terminal blocks.



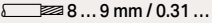

Cable entry in the base of the control cabinet
Separate strain relief, movable IP54 bottom plates sealed with sponge rubber (e.g., by Rittal)

1-Conductor/1-Pin Carrier Terminal Block X-COM®-SYSTEM 4 mm²; 769 Series

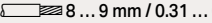
Technical Data	
0.08 ... 4 mm ²	28 ... 12 AWG
500 V/6 kV/3 ①	300 V, 20 A ②
I _N 32 A ②	300 V, 20 A ③
Terminal block width: 5 mm / 0.197 inch	
 8 ... 9 mm / 0.31 ... 0.35 inch	

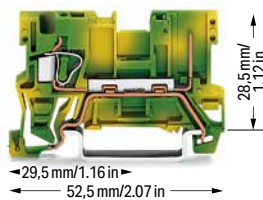
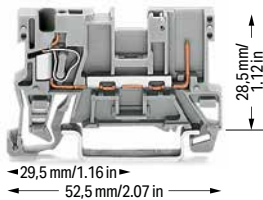
Technical Data	
0.08 ... 4 mm ²	28 ... 12 AWG
Terminal block width: 5 mm / 0.197 inch	
 8 ... 9 mm / 0.31 ... 0.35 inch	





1-conductor/1-pin carrier terminal block		
Color	Item No.	Pack. Unit
 gray	769-176	100
 blue	769-176/000-006	100







1-conductor/1-pin ground carrier terminal block		
Color	Item No.	Pack. Unit
 green-yellow	769-237	100

1-conductor/1-pin carrier terminal block; with shield contact		
 gray	769-231 ①	50



Accessories; item-specific			
Protective warning marker; with black high-voltage symbol; for 5 terminal blocks			
	yellow	280-415	100 (25)

Accessories; 769 Series
Appropriate marking systems: Mini-WSB/Mini-WSB Inline

End and intermediate plate; 1.1 mm thick			
	orange	769-308	100 (25)
	gray	769-307	100 (25)

Staggered jumper; insulated; 5 mm wide; I _N 24 A			
	1 to 2	780-452	100 (25)
	1 to 3	780-453	100 (25)
	1 to 4	780-454	100 (25)
	1 to 5	780-455	50 (25)
	1 to 6	780-456	50 (25)
	1 to 7	780-457	50 (25)
	1 to 8	780-458	50 (25)

Insulation stop; 0.08 ... 0.2 mm ² "s" (0.14 mm ² "f-st"); 5 pcs/strip			
	white	769-470	200 (25)

Push-in type wire jumper; insulated; 0.75 mm ² conductor cross section; I _N 9 A			
	L = 60 mm	249-125	100 (10)
	L = 110 mm	249-126	100 (10)
	L = 250 mm	249-127	100 (10)

Insulation stop; 0.25 ... 0.5 mm ² ; 5 pcs/strip			
	light gray	769-471	200 (25)

Insulation stop; 0.75 ... 1 mm ² ; 5 pcs/strip			
	dark gray	769-472	200 (25)

Test plug module; snaps together; 5 mm wide			
	gray	280-418	100 (25)

Coding pin; for coding female plugs			
	orange	769-435	100 (25)

Spacer module; snaps together; 5 mm wide			
	gray	280-419	100 (25)

Adjacent jumper; insulated; I _N = I _N terminal block			
	gray	280-402	200 (25)

Test plug; with 500 mm cable; 2 mm Ø; max. 42 V			
	red	210-136	50

Alternate jumper; insulated; I _N = I _N terminal block			
	gray	280-409	100 (25)

Test plug; with 500 mm cable; 2 mm Ø; max. 42 V			
	yellow	210-137	50

① 500 V = rated voltage
6 kV = rated impulse voltage
3 = pollution degree
250 V/4 kV/3 = Nominal voltage with shield contact (see Section 14)



② See current-carrying capacity curve on page 417 and upon request

Please observe the application notes:
Insulation stop, page 346
Jumpers, from page 348
Testing accessories, from page 343
Marking, from page 589

Approvals and corresponding ratings, visit www.wago.com

Accessories; 769 Series
Appropriate marking systems: Mini-WSB/Mini-WSB Inline

Test plug adapter; 5 mm wide; for 210-137 Test Plug (2.3 mm Ø); for 1.5 ... 4 mm ² terminal blocks			
	gray	280-404	100 (25)







Pin cover; with Mini-WSB marker slot			
	gray	769-438	100 (25)
	orange	769-439	100 (25)

1-connector female plug; straight			
	gray	769-101	200

1-conductor female plug; angled			
	gray	769-101/022-000	200

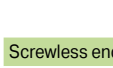
2-conductor female plug			
	gray	769-121	100

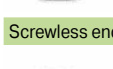
Mini-WSB marking card; white; 10 strips with 10 markers/card; 5 mm wide markers			
	plain	248-501	5

Mini-WSB marking card; plain; 10 strips with 10 markers/card; 5 mm wide markers			
	yellow	248-501/000-002	5
	red	248-501/000-005	5
	blue	248-501/000-006	5
	gray	248-501/000-007	5
	orange	248-501/000-012	5
	light green	248-501/000-017	5
	green	248-501/000-023	5
	violet	248-501/000-024	5

Screwless end stop; for DIN-35 rail; 6 mm wide			
	gray	249-116	100 (25)

Screwless end stop; for DIN-35 rail; 10 mm wide			
	gray	249-117	50 (25)

1-Conductor/1-Pin Carrier Terminal Blocks and 1-/2-Conductor Female Plugs X-COM®-SYSTEM Assembly Types



1-conductor female plug
Carrier terminal blocks can be commoned via 280 and 780 Series Jumpers and tested using a test plug adapter (280-4..).

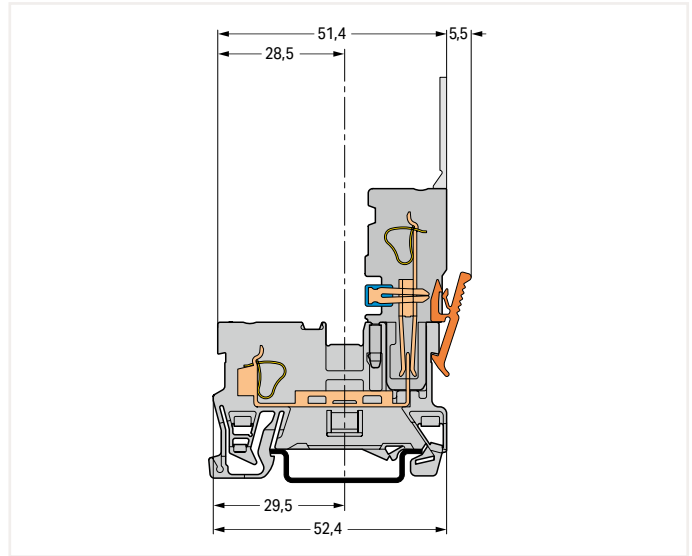

Carrier terminal block



2-conductor female plug
Carrier terminal blocks can only be commoned via 280 Series Adjacent and Alternate Jumpers.

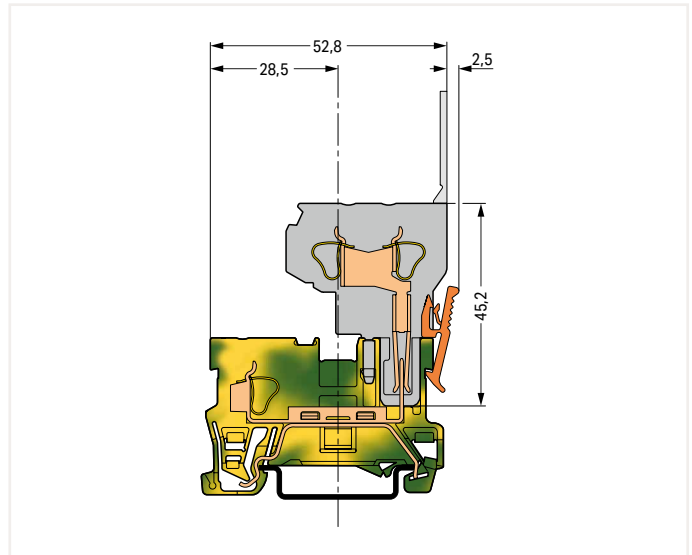

Ground carrier terminal block

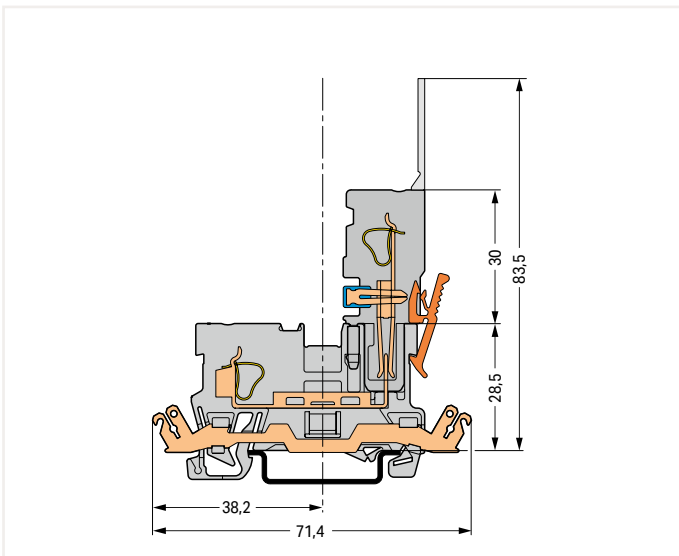

Carrier terminal block; with shield contact

6

2-Pin Carrier Terminal Block X-COM®-SYSTEM 769 Series

Technical Data	
500 V/6 kV/3 ①	300 V, 20 A ②
I _N 32 A ②	300 V, 20 A ③
Terminal block width: 5 mm / 0.197 inch	

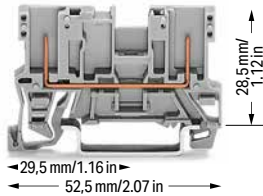

2-Pin Carrier Terminal Block		
Color	Item No.	Pack. Unit
○ gray	769-156	100

2-pin carrier terminal block; with shield contact		
Color	Item No.	Pack. Unit
○ gray	769-221 ①	50

Technical Data	
Terminal block width: 5 mm / 0.197 inch	

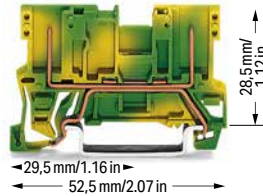

2-pin ground carrier terminal block		
Color	Item No.	Pack. Unit
● green-yellow	769-227	100

① 500 V = rated voltage
6 kV = rated impulse voltage
3 = pollution degree
250 V/4 kV/3 = Nominal voltage with shield contact (see Section 14)

② See current-carrying capacity curve and upon request

Please observe the application notes:
Jumpers, from page 348
Testing accessories, from page 343
Marking, from page 589

Approvals and corresponding ratings, visit www.wago.com

Accessories; 769 Series

Appropriate marking systems:
Mini-WSB/Mini-WSB Inline

Screwless end stop; for DIN-35 rail; 6 mm wide		
Color	Item No.	Pack. Unit
gray	249-116	100 (25)



Screwless end stop; for DIN-35 rail; 10 mm wide		
Color	Item No.	Pack. Unit
gray	249-117	50 (25)



Accessories; 769 Series

Appropriate marking systems: Mini-WSB/Mini-WSB Inline

End and intermediate plate; 1.1 mm thick		
Color	Item No.	Pack. Unit
orange	769-306	100 (25)
gray	769-305	100 (25)



Test plug; with 500 mm cable; 2 mm Ø; max. 42 V		
Color	Item No.	Pack. Unit
yellow	210-137	50



Coding pin; for coding female plugs		
Color	Item No.	Pack. Unit
orange	769-435	100 (25)



Test plug adapter; 5 mm wide; for 210-137 Test Plug (2.3 mm Ø); for 1.5 ... 4 mm² terminal blocks		
Color	Item No.	Pack. Unit
gray	280-404	100 (25)



Adjacent jumper; insulated; I _N = I _N terminal block		
Color	Item No.	Pack. Unit
gray	280-402	200 (25)



Pin cover; with Mini-WSB marker slot		
Color	Item No.	Pack. Unit
gray	769-438	100 (25)
orange	769-439	100 (25)



Alternate jumper; insulated; I _N = I _N terminal block		
Color	Item No.	Pack. Unit
gray	280-409	100 (25)



1-conductor female plug; straight		
Color	Item No.	Pack. Unit
gray	769-101	200



Staggered jumper; insulated; 5 mm wide; I _N 24 A		
Configuration	Item No.	Pack. Unit
1 to 2	780-452	100 (25)
1 to 3	780-453	100 (25)
1 to 4	780-454	100 (25)
1 to 5	780-455	50 (25)
1 to 6	780-456	50 (25)
1 to 7	780-457	50 (25)
1 to 8	780-458	50 (25)



1-conductor female plug; angled		
Color	Item No.	Pack. Unit
gray	769-101/022-000	200



Push-in type wire jumper; insulated; 0.75 mm² conductor cross section; I _N 9 A		
Length (L)	Item No.	Pack. Unit
L = 60 mm	249-125	100 (10)
L = 110 mm	249-126	100 (10)
L = 250 mm	249-127	100 (10)



2-conductor female plug		
Color	Item No.	Pack. Unit
gray	769-121	100



Mini-WSB marking card; white; 10 strips with 10 markers/ card; 5 mm wide markers		
Color	Item No.	Pack. Unit
plain	248-501	5



Test plug module; snaps together; 5 mm wide		
Color	Item No.	Pack. Unit
gray	280-418	100 (25)



Mini-WSB marking card; plain; 10 strips with 10 markers/ card; 5 mm wide markers		
Color	Item No.	Pack. Unit
yellow	248-501/000-002	5
red	248-501/000-005	5
blue	248-501/000-006	5
gray	248-501/000-007	5
orange	248-501/000-012	5
light green	248-501/000-017	5
green	248-501/000-023	5
violet	248-501/000-024	5



Spacer module; snaps together; 5 mm wide		
Color	Item No.	Pack. Unit
gray	280-419	100 (25)



6

2-Pin Carrier Terminal Blocks and 1-/2-Conductor Female Plugs X-COM®-SYSTEM Assembly Types



1-Conductor Female Plugs
Carrier terminal blocks can be commoned via 280 and 780 Series Jumpers and tested using a test plug adapter (280-4.).

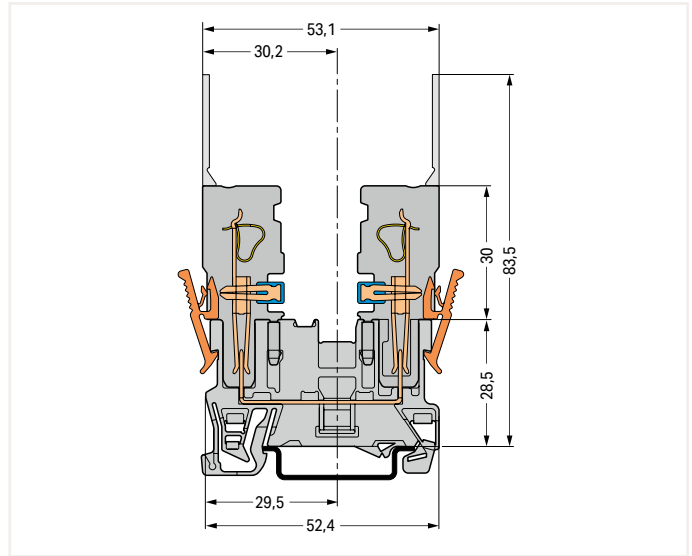

Carrier terminal block



1- and 2-Conductor Female Plug
Carrier terminal blocks can only be commoned via 280 Series Adjacent and Alternate Jumpers.

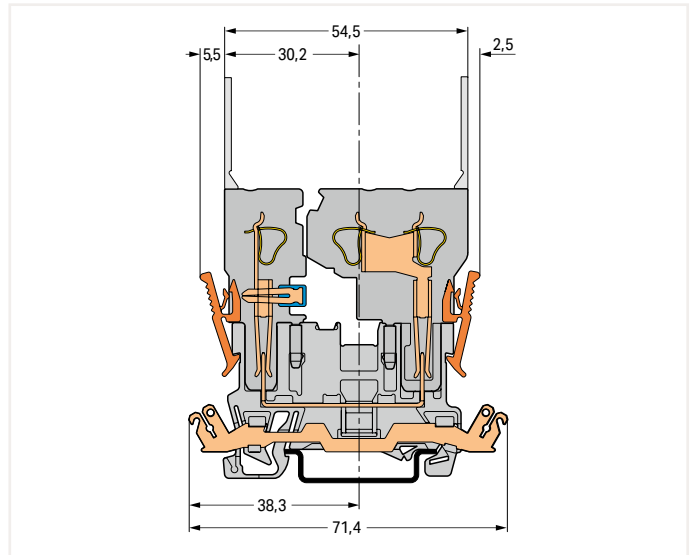

Carrier terminal block; with shield contact



2- and 1-Conductor Female Plug
Carrier terminal blocks can be commoned via 280 and 780 Series Jumpers.

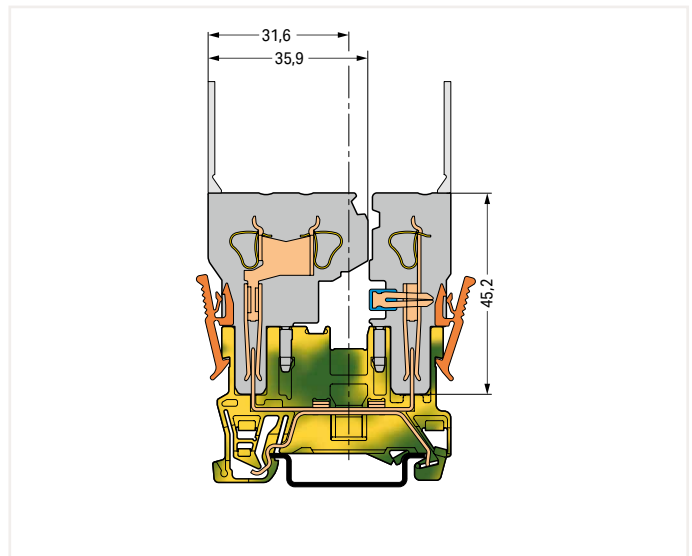

Ground carrier terminal block

6

2-Conductor/2-Pin Carrier Terminal Block X-COM®-SYSTEM 4 mm²; 769 Series

Technical Data

0.08 ... 4 mm ²	28 ... 12 AWG
500 V/6 kV/3 ①	300 V, 20 A ②
I _N 32 A ②	300 V, 20 A ③
Terminal block width: 5 mm / 0.197 inch	
8 ... 9 mm / 0.31 ... 0.35 inch	

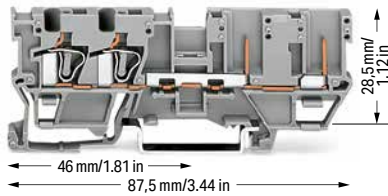

2-conductor/2-pin carrier terminal block

Color	Item No.	Pack. Unit
gray	769-171	50
blue	769-171/000-006	50

2-conductor/2-pin carrier terminal block; with shield contact

gray	769-211 ①	50
------	-----------	----

Accessories; item-specific

Protective warning marker; with black high-voltage symbol; for 5 terminal blocks

yellow	280-415	100 (25)
--------	---------	----------

Accessories; 769 Series

Appropriate marking systems: Mini-WSB/Mini-WSB Inline

End and intermediate plate; 1.1 mm thick

orange	769-304	100 (25)
gray	769-303	100 (25)

Insulation stop; 0.08 ... 0.2 mm² "s" (0.14 mm² "f-st"); 5 pcs/strip

white	769-470	200 (25)
-------	---------	----------

Insulation stop; 0.25 ... 0.5 mm²; 5 pcs/strip

light gray	769-471	200 (25)
------------	---------	----------

Insulation stop; 0.75 ... 1 mm²; 5 pcs/strip

dark gray	769-472	200 (25)
-----------	---------	----------

Coding pin; for coding female plugs

orange	769-435	100 (25)
--------	---------	----------

Adjacent jumper; insulated; I_N = I_N terminal block

gray	280-402	200 (25)
------	---------	----------

Alternate jumper; insulated; I_N = I_N terminal block

gray	280-409	100 (25)
------	---------	----------

Technical Data

0.08 ... 4 mm ²	28 ... 12 AWG
Terminal block width: 5 mm / 0.197 inch	
8 ... 9 mm / 0.31 ... 0.35 inch	

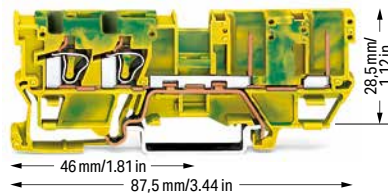

2-conductor/2-pin ground carrier terminal block

Color	Item No.	Pack. Unit
green-yellow	769-217	50

- 500 V = rated voltage
6 kV = rated impulse voltage
3 = pollution degree
250 V/4 kV/3 = Nominal voltage with shield contact (see Section 14)

- See current-carrying capacity curve on page 418 and upon request

Note: 1-conductor angled female plugs cannot be used.

Please observe the application notes:
Insulation stop, page 346
Jumpers, from page 348
Testing accessories, from page 342
Marking, from page 589

Approvals and corresponding ratings, visit www.wago.com

Accessories; 769 Series

Appropriate marking systems:
Mini-WSB/Mini-WSB Inline

Test plug adapter; 5 mm wide; for 210-137 Test Plug (2.3 mm Ø); for 1.5 ... 4 mm² terminal blocks

gray	280-404	100 (25)
------	---------	----------

Pin cover; with Mini-WSB marker slot

gray	769-438	100 (25)
orange	769-439	100 (25)

1-connector female plug; straight

gray	769-101	200
------	---------	-----

2-conductor female plug

gray	769-121	100
------	---------	-----

Mini-WSB marking card; white; 10 strips with 10 markers/card; 5 mm wide markers

plain	248-501	5
-------	---------	---

Mini-WSB marking card; plain; 10 strips with 10 markers/card; 5 mm wide markers

yellow	248-501/000-002	5
red	248-501/000-005	5
blue	248-501/000-006	5
gray	248-501/000-007	5
orange	248-501/000-012	5
light green	248-501/000-017	5
green	248-501/000-023	5
violet	248-501/000-024	5

Screwless end stop; for DIN-35 rail; 6 mm wide

gray	249-116	100 (25)
------	---------	----------

Screwless end stop; for DIN-35 rail; 10 mm wide

gray	249-117	50 (25)
------	---------	---------

2-Conductor/2-Pin Carrier Terminal Blocks and 1-/2-Conductor Female Plugs X-COM®-SYSTEM Assembly Types

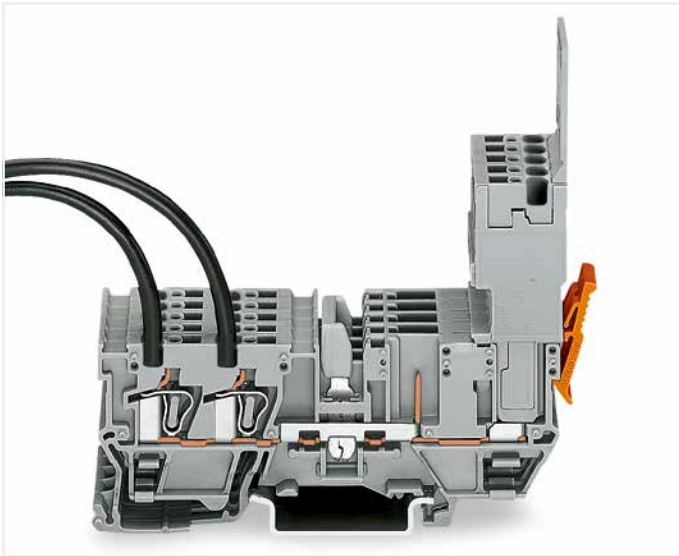

1-conductor female plug
Carrier terminal blocks can be commoned via 280 and 780 Series Jumpers and tested using a test plug adapter (280-4..).

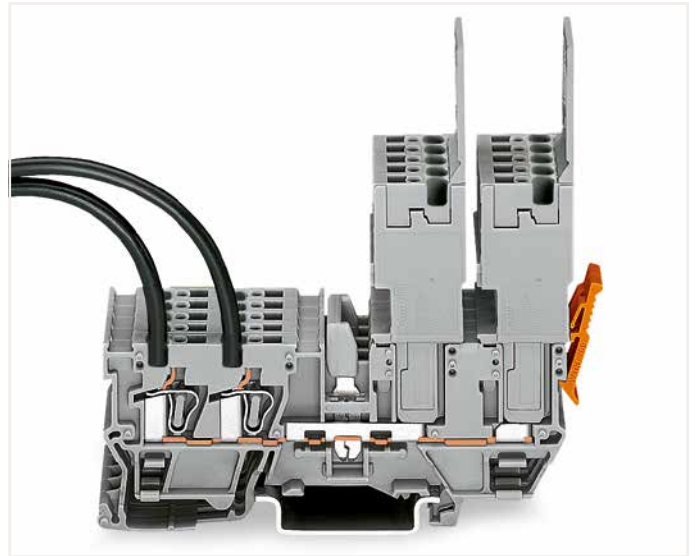

2 x 1-conductor female plugs
Carrier terminal blocks can be commoned via 280 and 780 Series Jumpers and tested using a test plug adapter (280-4..).

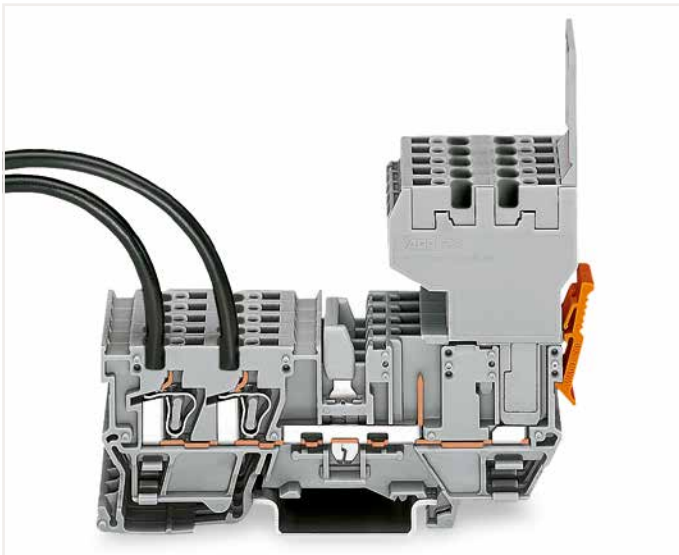

2-conductor female plug
Carrier terminal blocks can be commoned via 280 and 780 Series Jumpers and tested using a test plug adapter (280-4..).

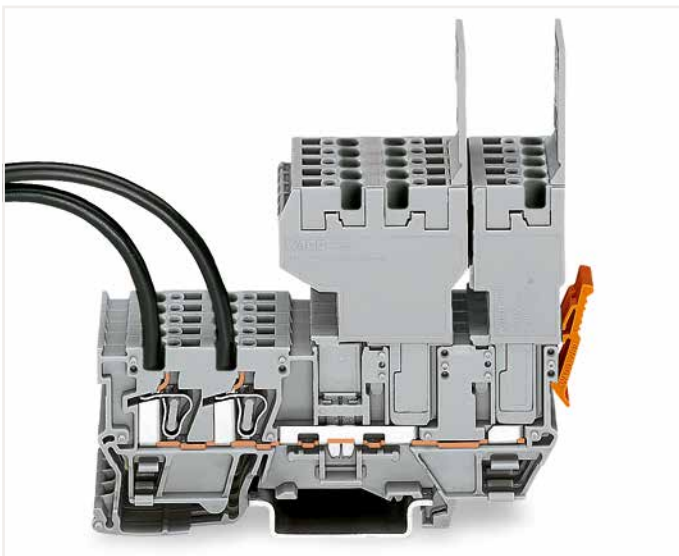
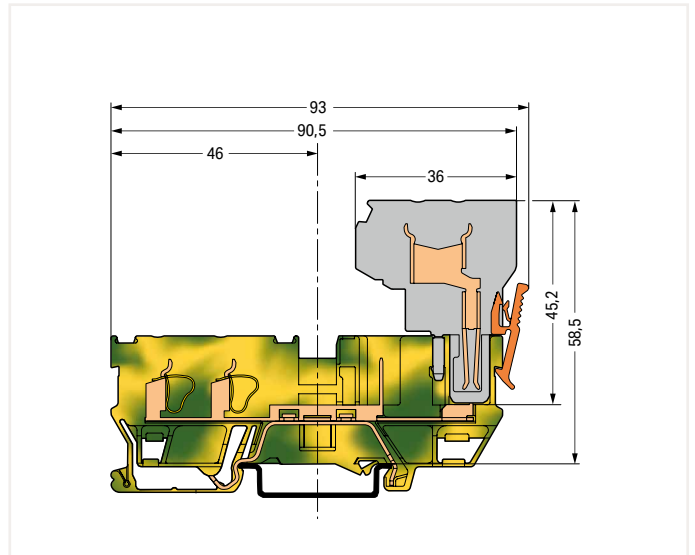

1- and 2-Conductor Female Plug
Carrier terminal blocks can only be commoned via 280 Series Adjacent and Alternate Jumpers.

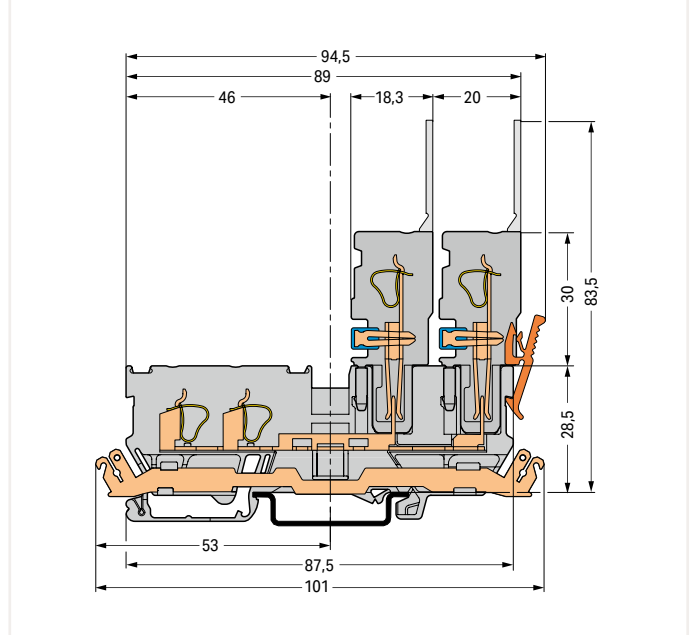

Ground carrier terminal block
Carrier terminal block; with shield contact

4-Pin Carrier Terminal Block X-COM®-SYSTEM 769 Series

Technical Data

500 V/6 kV/3 ①	300 V, 20 A ②
I _N 32 A ②	300 V, 20 A ②
Terminal block width: 5 mm / 0.197 inch	

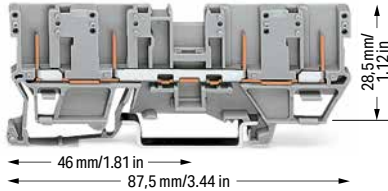

4-pin carrier terminal block		
Color	Item No.	Pack. Unit
○ gray	769-151	50

4-pin carrier terminal block; with shield contact		
Color	Item No.	Pack. Unit
○ gray	769-201 ①	50

Technical Data

Terminal block width: 5 mm / 0.197 inch

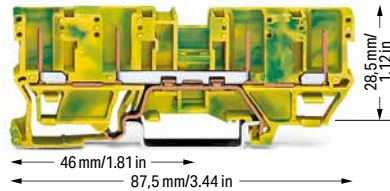

4-pin ground carrier terminal block		
Color	Item No.	Pack. Unit
● green-yellow	769-207	50

- ① 500 V = rated voltage
6 kV = rated impulse voltage
3 = pollution degree
250 V/4 kV/3 = Nominal voltage with shield contact (see Section 14)

- ② See current-carrying capacity curve on page 418 and upon request

Note: 1-conductor angled female plugs cannot be used.

Please observe the application notes:
Jumpers, from page 348
Testing accessories, from page 343
Marking, from page 589

Approvals and corresponding ratings, visit www.wago.com

6

Accessories; 769 Series

Appropriate marking systems: Mini-WSB/Mini-WSB Inline

End and intermediate plate; 1.1 mm thick		
Color	Item No.	Pack. Unit
orange	769-302	100 (25)
gray	769-301	100 (25)

Coding pin; for coding female plugs		
Color	Item No.	Pack. Unit
orange	769-435	100 (25)

Adjacent jumper; insulated; I _N = I _N terminal block		
Color	Item No.	Pack. Unit
gray	280-402	200 (25)

Alternate jumper; insulated; I _N = I _N terminal block		
Color	Item No.	Pack. Unit
gray	280-409	100 (25)

Staggered jumper; insulated; 5 mm wide; I _N 24 A		
Item No.	Item No.	Pack. Unit
1 to 2	780-452	100 (25)
1 to 3	780-453	100 (25)
1 to 4	780-454	100 (25)
1 to 5	780-455	50 (25)
1 to 6	780-456	50 (25)
1 to 7	780-457	50 (25)
1 to 8	780-458	50 (25)

Push-in type wire jumper; insulated; 0.75 mm ² conductor cross section; I _N 9 A		
Length	Item No.	Pack. Unit
L = 60 mm	249-125	100 (10)
L = 110 mm	249-126	100 (10)
L = 250 mm	249-127	100 (10)

Test plug module; snaps together; 5 mm wide		
Color	Item No.	Pack. Unit
gray	280-418	100 (25)

Spacer module; snaps together; 5 mm wide		
Color	Item No.	Pack. Unit
gray	280-419	100 (25)

Test plug; with 500 mm cable; 2 mm Ø; max. 42 V		
Color	Item No.	Pack. Unit
yellow	210-137	50

Test plug adapter; 5 mm wide; for 210-137 Test Plug (2.3 mm Ø); for 1.5 ... 4 mm ² terminal blocks		
Color	Item No.	Pack. Unit
gray	280-404	100 (25)

Pin cover; with Mini-WSB marker slot		
Color	Item No.	Pack. Unit
gray	769-438	100 (25)
orange	769-439	100 (25)

1-connector female plug; straight		
Color	Item No.	Pack. Unit
gray	769-101	200

2-conductor female plug		
Color	Item No.	Pack. Unit
gray	769-121	100

Mini-WSB marking card; white; 10 strips with 10 markers/card; 5 mm wide markers		
Color	Item No.	Pack. Unit
plain	248-501	5

Mini-WSB marking card; plain; 10 strips with 10 markers/card; 5 mm wide markers		
Color	Item No.	Pack. Unit
yellow	248-501/000-002	5
red	248-501/000-005	5
blue	248-501/000-006	5
gray	248-501/000-007	5
orange	248-501/000-012	5
light green	248-501/000-017	5
green	248-501/000-023	5
violet	248-501/000-024	5

Screwless end stop; for DIN-35 rail; 6 mm wide		
Color	Item No.	Pack. Unit
gray	249-116	100 (25)

Screwless end stop; for DIN-35 rail; 10 mm wide		
Color	Item No.	Pack. Unit
gray	249-117	50 (25)

4-Pin Carrier Terminal Blocks and 1-/2-Conductor Female Plugs X-COM®-SYSTEM Assembly Types



4 x 1-conductor female plugs
Carrier terminal blocks can be commoned via 280 and 780 Series Jumpers and tested using a test plug adapter (280-4..).



2 x 2-conductor female plugs
Carrier terminal blocks can be commoned via 280 and 780 Series Jumpers and tested using a test plug adapter (280-4..).

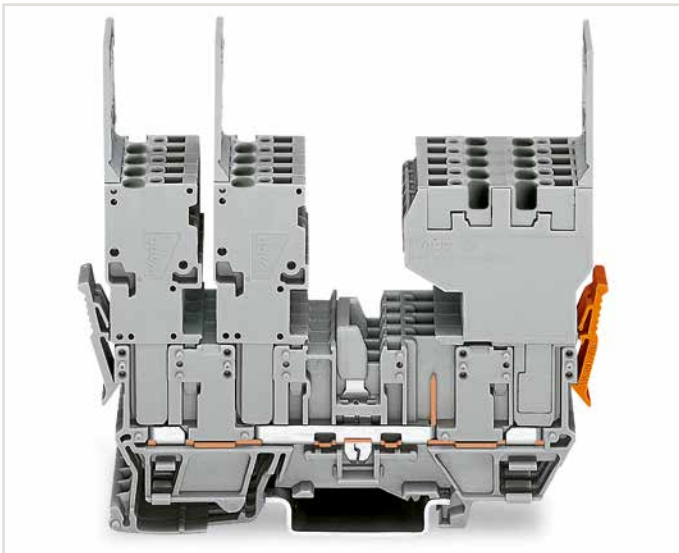

2 x 1-conductor female plug (left), 1 x 2-conductor female plug (right), may be reversed – carrier terminal blocks can be commoned via 280 and 780 Series Jumpers and tested using a test plug adapter (280-4..).

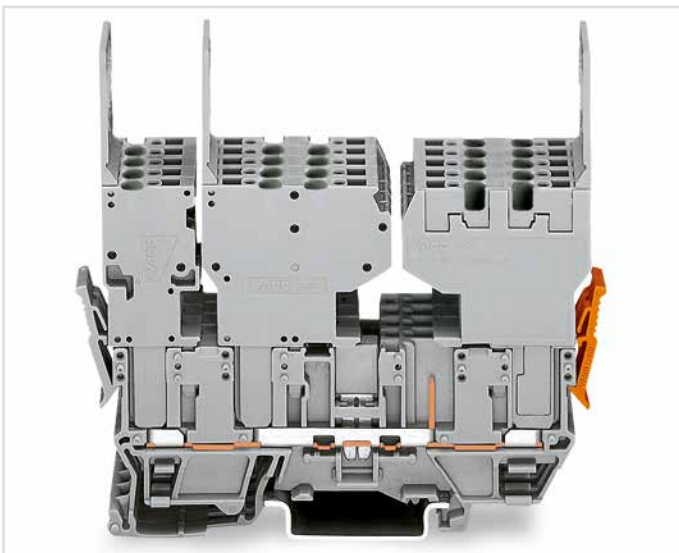
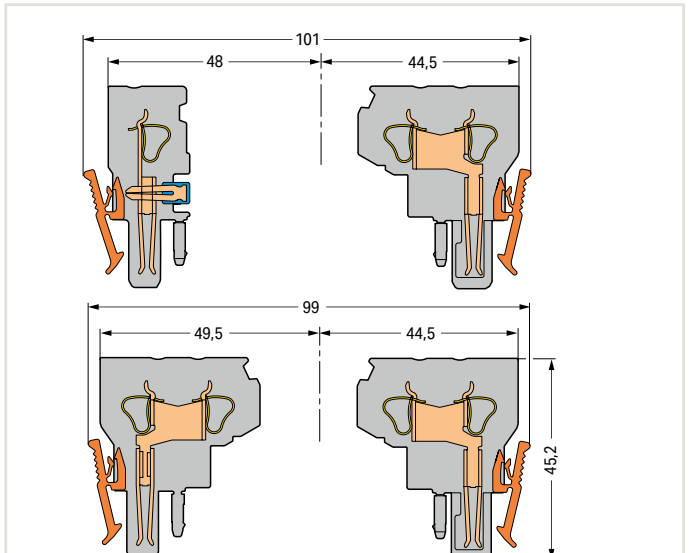

1-conductor and 2-conductor female plugs (left), 2-conductor female plug (right), may be reversed – carrier terminal blocks can only be commoned via 280 Series Adjacent and Alternate Jumpers.

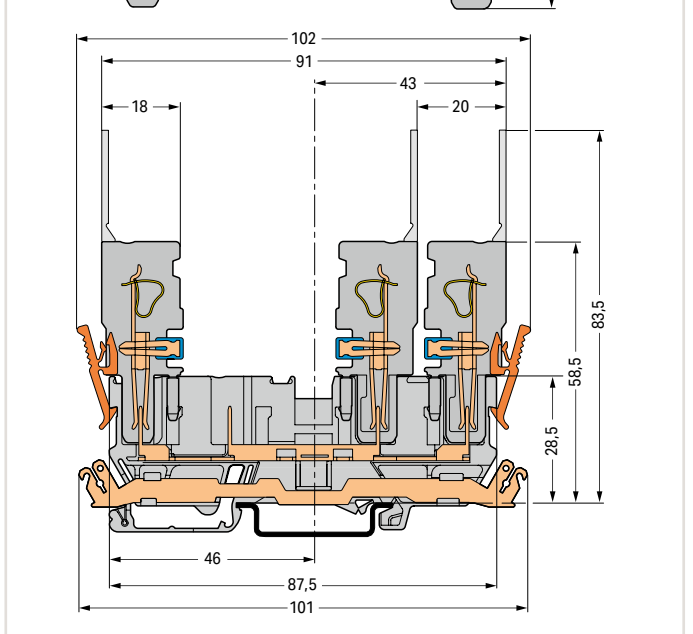

Carrier terminal block; with shield contact

2-Conductor/1-Pin Carrier Terminal Block X-COM®-SYSTEM 4 mm²; 769 Series

Technical Data

0.08 ... 4 mm ²	28 ... 12 AWG
500 V/6 kV/3 ①	300 V, 20 A ②
I _N 32 A ②	300 V, 20 A ③
Terminal block width: 5 mm / 0.197 inch	
8 ... 9 mm / 0.31 ... 0.35 inch	

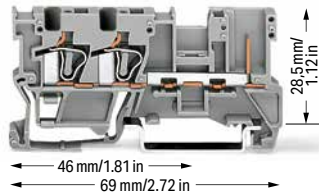

2-Conductor/1-Pin Carrier Terminal Block

Color	Item No.	Pack. Unit
gray	769-251	50
blue	769-251/000-006	50

Technical Data

0.08 ... 4 mm ²	28 ... 12 AWG
Terminal block width: 5 mm / 0.197 inch	
8 ... 9 mm / 0.31 ... 0.35 inch	

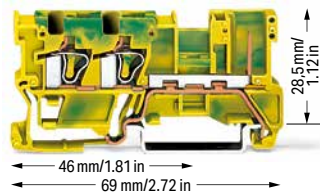

1-conductor/1-pin ground carrier terminal block

Color	Item No.	Pack. Unit
green-yellow	769-257	50

- ① 500 V = rated voltage
6 kV = rated impulse voltage
3 = pollution degree
(see Section 14)

- ② Current-carrying capacity curves upon request

Please observe the application notes:
Insulation stop, page 346
Jumpers, from page 348
Testing accessories, from page 342
Marking, from page 589

Approvals and corresponding ratings,
visit www.wago.com

Accessories; 769 Series

Appropriate marking systems:
Mini-WSB/Mini-WSB Inline

Pin cover; with Mini-WSB marker slot

gray	769-438	100 (25)
orange	769-439	100 (25)

1-connector female plug; straight

gray	769-101	200
------	---------	-----

1-conductor female plug; angled

gray	769-101/022-000	200
------	-----------------	-----

2-conductor female plug

gray	769-121	100
------	---------	-----

Mini-WSB marking card; white; 10 strips with 10 markers/ card; 5 mm wide markers

plain	248-501	5
-------	---------	---

Mini-WSB marking card; plain; 10 strips with 10 markers/ card; 5 mm wide markers

yellow	248-501/000-002	5
red	248-501/000-005	5
blue	248-501/000-006	5
gray	248-501/000-007	5
orange	248-501/000-012	5
light green	248-501/000-017	5
green	248-501/000-023	5
violet	248-501/000-024	5

Screwless end stop; for DIN-35 rail; 6 mm wide

gray	249-116	100 (25)
------	---------	----------

Screwless end stop; for DIN-35 rail; 10 mm wide

gray	249-117	50 (25)
------	---------	---------

6

Accessories; item-specific

Protective warning marker; with black high-voltage symbol; for 5 terminal blocks

yellow	280-415	100 (25)
--------	---------	----------



Accessories; 769 Series

Appropriate marking systems: Mini-WSB/Mini-WSB Inline

End and intermediate plate; 1.1 mm thick

orange	769-321	100 (25)
gray	769-320	100 (25)



Insulation stop; 0.08 ... 0.2 mm² "s" (0.14 mm² "f-st"); 5 pcs/strip

white	769-470	200 (25)
-------	---------	----------



Insulation stop; 0.25 ... 0.5 mm²; 5 pcs/strip

light gray	769-471	200 (25)
------------	---------	----------



Insulation stop; 0.75 ... 1 mm²; 5 pcs/strip

dark gray	769-472	200 (25)
-----------	---------	----------



Coding pin; for coding female plugs

orange	769-435	100 (25)
--------	---------	----------



Adjacent jumper; insulated; I_N = I_N terminal block

gray	280-402	200 (25)
------	---------	----------



Alternate jumper; insulated; I_N = I_N terminal block

gray	280-409	100 (25)
------	---------	----------



Push-in type wire jumper; insulated; 0.75 mm² conductor cross section; I_N 9 A

L = 60 mm	249-125	100 (10)
L = 110 mm	249-126	100 (10)
L = 250 mm	249-127	100 (10)



Staggered jumper; insulated; 5 mm wide; I_N 24 A

1 to 2	780-452	100 (25)
1 to 3	780-453	100 (25)
1 to 4	780-454	100 (25)
1 to 5	780-455	50 (25)
1 to 6	780-456	50 (25)
1 to 7	780-457	50 (25)
1 to 8	780-458	50 (25)



Test plug module; snaps together; 5 mm wide

gray	280-418	100 (25)
------	---------	----------



Spacer module; snaps together; 5 mm wide

gray	280-419	100 (25)
------	---------	----------



B-type test plug module; snaps together; 5 mm wide

gray	249-106	100 (25)
------	---------	----------



Test plug; with 500 mm cable; 2 mm Ø; max. 42 V

red	210-136	50
-----	---------	----



Test plug; with 500 mm cable; 2 mm Ø; max. 42 V

yellow	210-137	50
--------	---------	----



Test plug adapter; 5 mm wide; for 210-137 Test Plug (2.3 mm Ø); for 1.5 ... 4 mm² terminal blocks

gray	280-404	100 (25)
------	---------	----------



2-Conductor/1-Pin Carrier Terminal Blocks and 1-/2-Conductor Female Plugs X-COM®-SYSTEM Assembly Types

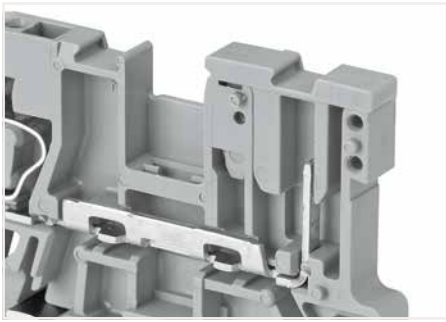

Pin cover (769-438); with Mini-WSB marker slot



1-conductor female plug
Carrier terminal blocks can be commoned via 280 and 780 Series Jumpers and tested using a test plug adapter (280-4..).

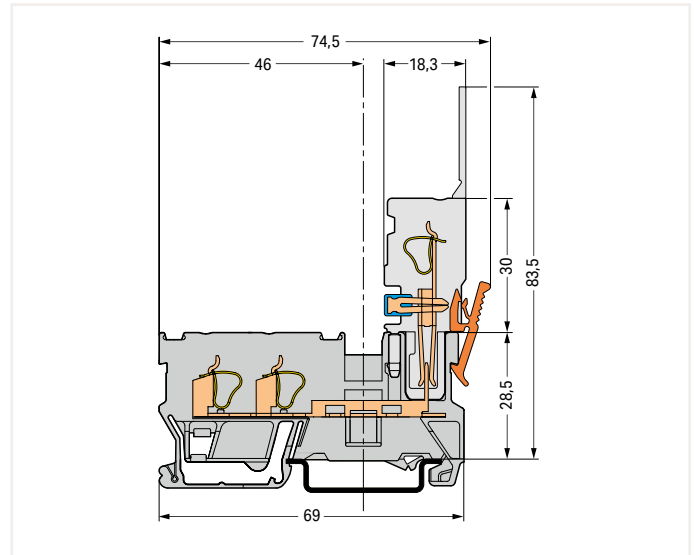

Carrier terminal block

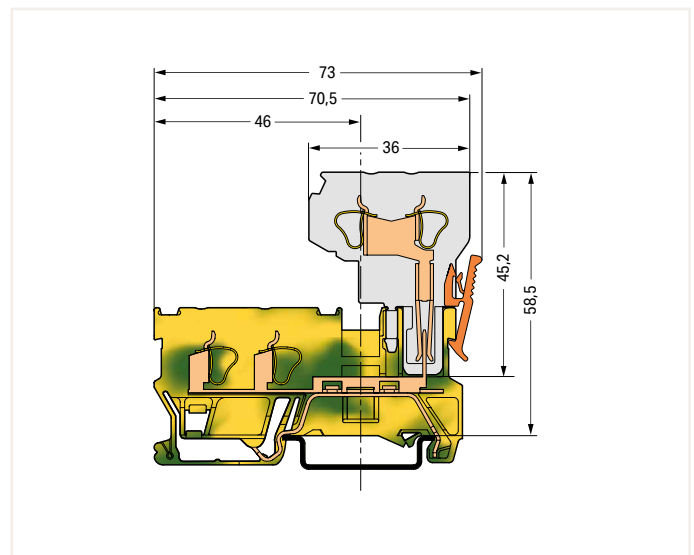

Ground carrier terminal block

6

1-Conductor/1-Pin Carrier Terminal Block X-COM®-SYSTEM; with Three Jumper Positions 4 mm²; 769 Series

Technical Data

0.08 ... 4 mm ²	28 ... 12 AWG
500 V/6 kV/3 ①	300 V, 20 A ②
I _N 32 A ②	300 V, 20 A ③
Terminal block width: 5 mm / 0.197 inch	
8 ... 9 mm / 0.31 ... 0.35 inch	

- ① 500 V = rated voltage
6 kV = rated impulse voltage
3 = pollution degree
(see Section 14)
 - ② Current-carrying capacity curves upon request
- Please observe the application notes:
Insulation stop, page 346
Marking, from page 589
- Approvals and corresponding ratings,
visit www.wago.com

Accessories; 769 Series

Appropriate marking systems:
Mini-WSB/Mini-WSB Inline

1-connector female plug; straight

gray	769-101	200
------	---------	-----

1-conductor female plug; angled

gray	769-101/022-000	200
------	-----------------	-----

2-conductor female plug

gray	769-121	100
------	---------	-----

Mini-WSB marking card; white; 10 strips with 10 markers/ card; 5 mm wide markers

plain	248-501	5
-------	---------	---

Mini-WSB marking card; plain; 10 strips with 10 markers/ card; 5 mm wide markers

yellow	248-501/000-002	5
red	248-501/000-005	5
blue	248-501/000-006	5
gray	248-501/000-007	5
orange	248-501/000-012	5
light green	248-501/000-017	5
green	248-501/000-023	5
violet	248-501/000-024	5

Screwless end stop; for DIN-35 rail; 6 mm wide

gray	249-116	100 (25)
------	---------	----------

Screwless end stop; for DIN-35 rail; 10 mm wide

gray	249-117	50 (25)
------	---------	---------

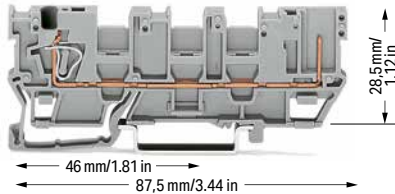

1-conductor/1-pin carrier terminal block; with three jumper positions

Color	Item No.	Pack. Unit
gray	769-214	50

Accessories; 769 Series

Appropriate marking systems:
Mini-WSB/Mini-WSB Inline

End and intermediate plate; 1.1 mm thick

orange	769-316	100 (25)
gray	769-315	100 (25)

Insulation stop; 0.08 ... 0.2 mm² "s" (0.14 mm² "f-st"); 5 pcs/strip

white	769-470	200 (25)
-------	---------	----------

Insulation stop; 0.25 ... 0.5 mm²; 5 pcs/strip

light gray	769-471	200 (25)
------------	---------	----------

Accessories; 769 Series

Appropriate marking systems:
Mini-WSB/Mini-WSB Inline

Insulation stop; 0.75 ... 1 mm²; 5 pcs/strip

dark gray	769-472	200 (25)
-----------	---------	----------

Coding pin; for coding female plugs

orange	769-435	100 (25)
--------	---------	----------

Adjacent jumper; insulated; I_N = I_N terminal block

gray	280-402	200 (25)
------	---------	----------

Alternate jumper; insulated; I_N = I_N terminal block

gray	280-409	100 (25)
------	---------	----------

Pin cover; with Mini-WSB marker slot

gray	769-438	100 (25)
orange	769-439	100 (25)

6

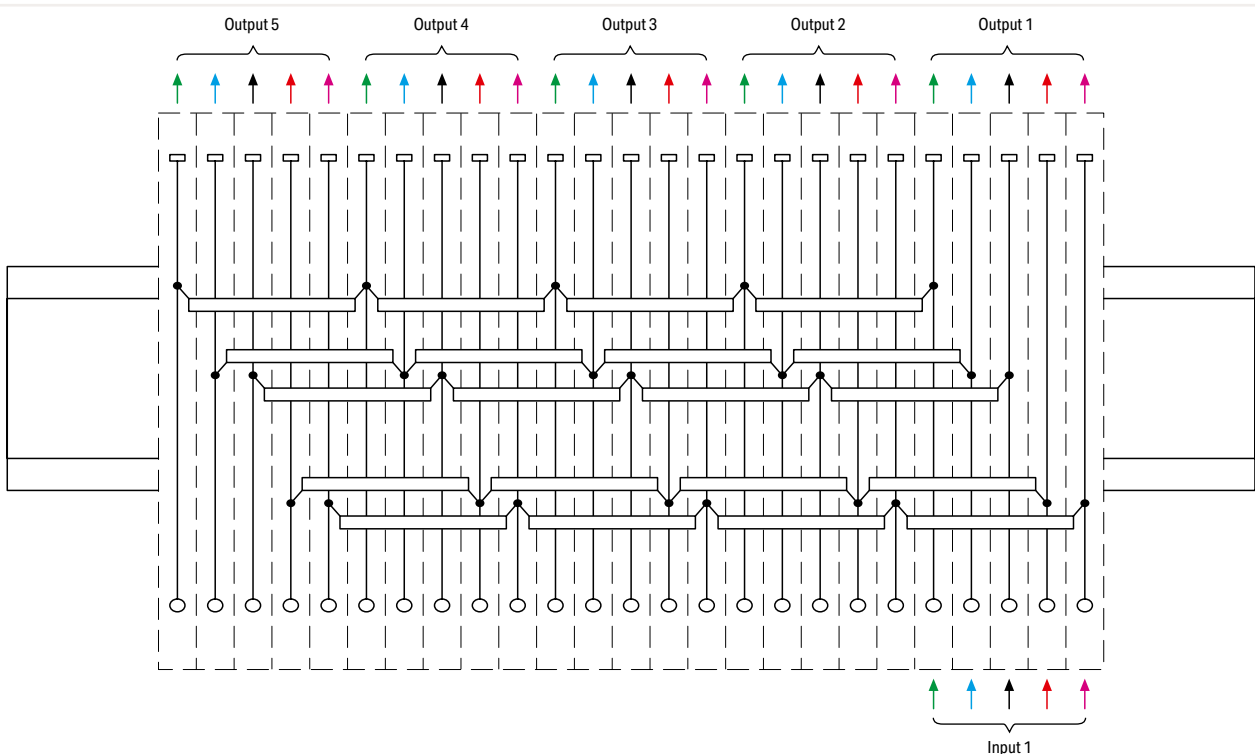

1-Conductor/1-Pin Carrier Terminal Blocks and 1-/2-Conductor Female Plugs X-COM®-SYSTEM Assembly Types

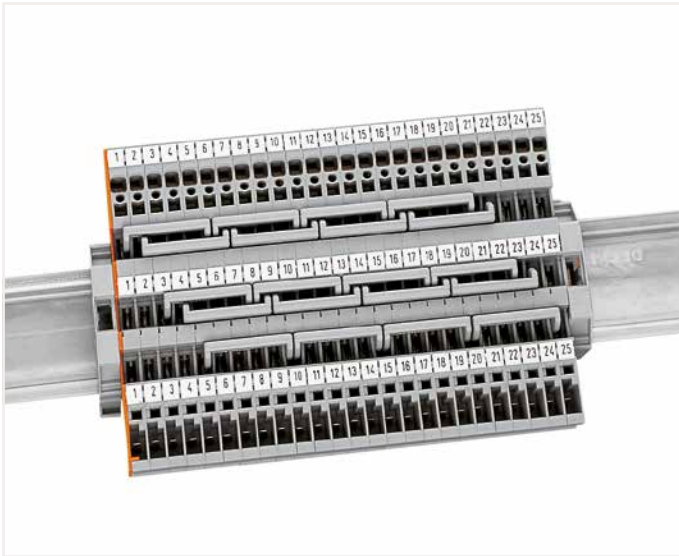

1-conductor/1-pin carrier terminal blocks; with three jumper positions
The three jumper positions allow up to six commoning options for staggered jumpers.

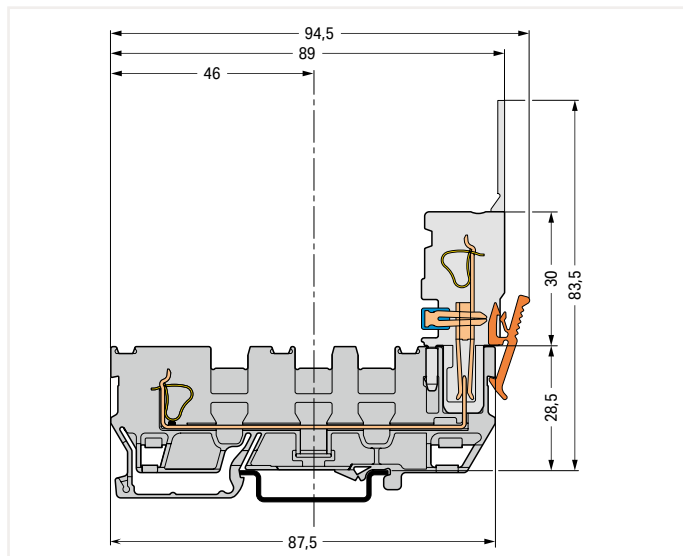
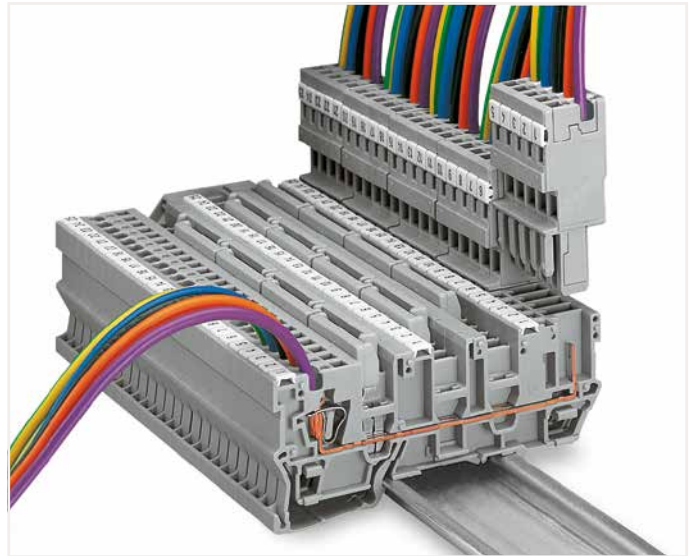

Carrier terminal block

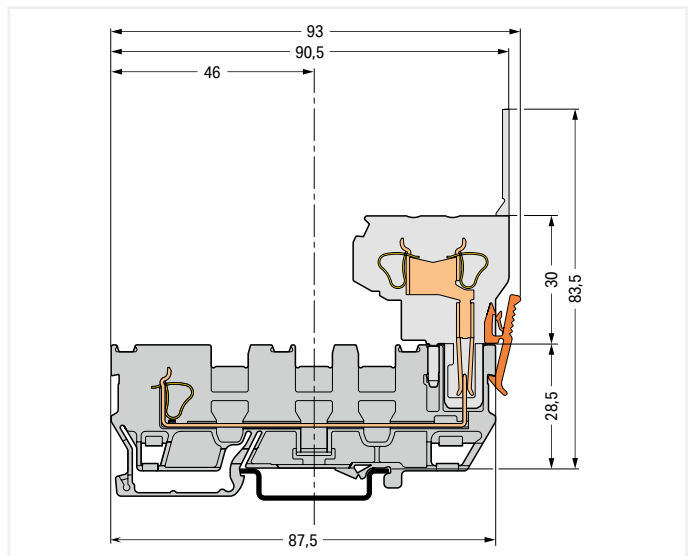

Carrier terminal block

Application examples:
Multiplication of three-phase circuits L1-L2-L3-N-PE
with pluggable outputs (e.g., for motors, frequency converters, power units)
Voltage supplies to multiple locations
(e.g., ±15 V, 0 V, +5 V, +12 V, +24 V)
Various wire-to-wire interfacing possibilities

1-Conductor/1-Pin and 2-Pin Disconnect Carrier Terminal Block X-COM®-SYSTEM 4 mm²; 769 Series

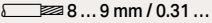
Technical Data	
0.08 ... 4 mm ²	28 ... 12 AWG
400 V/6 kV/3 ①	300 V, 20 A ②
I _N 16 A ②	300 V, 20 A ③
Terminal block width: 5 mm / 0.197 inch	
 8 ... 9 mm / 0.31 ... 0.35 inch	

Technical Data	
400 V/6 kV/3 ①	300 V, 20 A ②
I _N 16 A ②	300 V, 20 A ③
Terminal block width: 5 mm / 0.197 inch	

- ① 400 V = rated voltage
6 kV = rated impulse voltage
3 = pollution degree
250 V/4 kV/3 = Nominal voltage with shield contact (see Section 14)
- ② 16 A, 85°C upper temperature limit, current-carrying capacity curves upon request

Note: 2-conductor female plugs cannot be used.

Please observe the application notes:
Insulation stop, page 346
Marking, from page 589

Approvals and corresponding ratings, visit www.wago.com

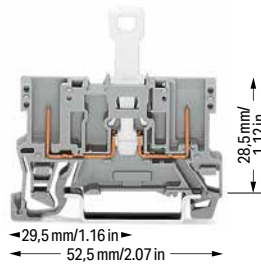
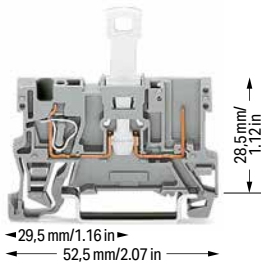



1-conductor/1-pin disconnect carrier terminal block		
Color	Item No.	Pack. Unit
	769-232	50

2-pin disconnect carrier terminal block		
Color	Item No.	Pack. Unit
	769-222	50

1-conductor/1-pin disconnect carrier terminal block; with shield contact		
	769-233 ①	50

2-pin disconnect carrier terminal block; with shield contact		
	769-223 ①	50

Accessories; item-specific			
End and intermediate plate; 1.1 mm thick			
	orange	769-308	100 (25)
	gray	769-307	100 (25)

Accessories; item-specific			
End and intermediate plate; 1.1 mm thick			
	orange	769-306	100 (25)
	gray	769-305	100 (25)

Insulation stop; 0.08 ... 0.2 mm ² "s" (0.14 mm ² "f-st"); 5 pcs/strip			
	white	769-470	200 (25)

Screwless end stop; for DIN-35 rail; 6 mm wide			
	gray	249-116	100 (25)

Insulation stop; 0.25 ... 0.5 mm ² ; 5 pcs/strip			
	light gray	769-471	200 (25)

Screwless end stop; for DIN-35 rail; 10 mm wide			
	gray	249-117	50 (25)

Insulation stop; 0.75 ... 1 mm ² ; 5 pcs/strip			
	dark gray	769-472	200 (25)

Protective warning marker; with black high-voltage symbol; for 5 terminal blocks			
	yellow	280-415	100 (25)

Test plug; with 500 mm cable; 2 mm Ø; max. 42 V			
	red	210-136	50

Accessories; 769 Series
Appropriate marking systems: Mini-WSB/Mini-WSB Inline

Coding pin; for coding female plugs			
	orange	769-435	100 (25)

1-connector female plug; straight			
	gray	769-101	200









Test plug; with 500 mm cable; 2 mm Ø; max. 42 V			
	yellow	210-137	50

1-conductor female plug; angled			
	gray	769-101/022-000	200

Disconnect lock; for disconnect tab used on disconnect terminal blocks (280/281 and 769 Series)			
	red	709-170	200 (25)

Mini-WSB marking card; white; 10 strips with 10 markers/ card; 5 mm wide markers			
	plain	248-501	5

Accessories; 769 Series
Appropriate marking systems:
Mini-WSB/Mini-WSB Inline

Mini-WSB marking card; plain; 10 strips with 10 markers/ card; 5 mm wide markers			
	yellow	248-501/000-002	5
	red	248-501/000-005	5
	blue	248-501/000-006	5
	gray	248-501/000-007	5
	orange	248-501/000-012	5
	light green	248-501/000-017	5
	green	248-501/000-023	5
	violet	248-501/000-024	5

6

1-Conductor/1-Pin and 2-Pin Disconnect Carrier Terminal Block X-COM®-SYSTEM; with Two Jumper Positions

4 mm²; 769 Series

Technical Data

0.08 ... 4 mm ²	28 ... 12 AWG
400 V/6 kV/3 ①	300 V, 20 A ②
I _N 16 A ②	300 V, 20 A ③
Terminal block width: 5 mm / 0.197 inch	
8 ... 9 mm / 0.31 ... 0.35 inch	

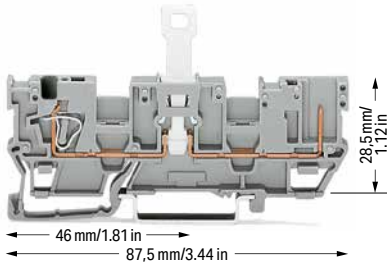

1-conductor/1-pin disconnect carrier terminal block; with two jumper positions

Color	Item No.	Pack. Unit
gray	769-212	50

1-conductor/1-pin disconnect carrier terminal block; with shield contact; with two jumper positions

gray	769-213 ①	50
------	-----------	----

Accessories; item-specific

End and intermediate plate; 1.1 mm thick

orange	769-312	100 (25)
gray	769-311	100 (25)

Separator; oversized; 1.1 mm thick

orange	769-314	100 (25)
--------	---------	----------

Insulation stop; 0.08 ... 0.2 mm² "s" (0.14 mm² "f-st"); 5 pcs/strip

white	769-470	200 (25)
-------	---------	----------

Insulation stop; 0.25 ... 0.5 mm²; 5 pcs/strip

light gray	769-471	200 (25)
------------	---------	----------

Insulation stop; 0.75 ... 1 mm²; 5 pcs/strip

dark gray	769-472	200 (25)
-----------	---------	----------

Protective warning marker; with black high-voltage symbol; for 5 terminal blocks

yellow	280-415	100 (25)
--------	---------	----------

Test plug; with 500 mm cable; 2 mm Ø; max. 42 V

red	210-136	50
-----	---------	----

Accessories; 769 Series

Appropriate marking systems: Mini-WSB/Mini-WSB Inline

Coding pin; for coding female plugs

orange	769-435	100 (25)
--------	---------	----------

Test plug; with 500 mm cable; 2 mm Ø; max. 42 V

yellow	210-137	50
--------	---------	----

Technical Data

400 V/6 kV/3 ①	300 V, 20 A ②
I _N 16 A ②	300 V, 20 A ③
Terminal block width: 5 mm / 0.197 inch	

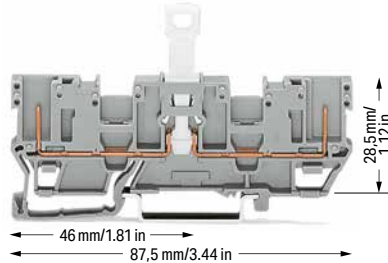

2-pin disconnect carrier terminal block; with two jumper positions

Color	Item No.	Pack. Unit
gray	769-202	50

2-pin disconnect carrier terminal block; with shield contact; with two jumper positions

gray	769-203 ①	50
------	-----------	----

Accessories; item-specific

End and intermediate plate; 1.1 mm thick

orange	769-310	100 (25)
gray	769-309	100 (25)

Separator; oversized; 1.1 mm thick

orange	769-313	100 (25)
--------	---------	----------

- ① 400 V = rated voltage
6 kV = rated impulse voltage
3 = pollution degree
250 V/4 kV/3 = Nominal voltage with shield contact (see Section 14)

- ② 16 A, 85°C upper temperature limit, current-carrying capacity curves upon request

Please observe the application notes:

- Insulation stop, page 346
- Jumpers, from page 348
- Testing accessories, from page 344
- Marking, from page 589

Approvals and corresponding ratings, visit www.wago.com

Accessories; 769 Series

Appropriate marking systems:
Mini-WSB/Mini-WSB Inline

Adjacent jumper; insulated; I_N = I_N terminal block

gray	280-402	200 (25)
------	---------	----------

Alternate jumper; insulated; I_N = I_N terminal block

gray	280-409	100 (25)
------	---------	----------

Staggered jumper; insulated; 5 mm wide; I_N 24 A

1 to 2	780-452	100 (25)
1 to 3	780-453	100 (25)
1 to 4	780-454	100 (25)
1 to 5	780-455	50 (25)
1 to 6	780-456	50 (25)
1 to 7	780-457	50 (25)
1 to 8	780-458	50 (25)

Push-in type wire jumper; insulated; 0.75 mm² conductor cross section; I_N 9 A

L = 60 mm	249-125	100 (10)
L = 110 mm	249-126	100 (10)
L = 250 mm	249-127	100 (10)

Test plug module; snaps together; 5 mm wide

gray	280-418	100 (25)
------	---------	----------

1-connector female plug; straight

gray	769-101	200
------	---------	-----

1-conductor female plug; angled

gray	769-101/022-000	200
------	-----------------	-----

2-conductor female plug

gray	769-121	100
------	---------	-----

Mini-WSB marking card; white; 10 strips with 10 markers/card; 5 mm wide markers

plain	248-501	5
-------	---------	---

1-Conductor/1-Pin and 2-Pin Diode Carrier Terminal Block X-COM®-SYSTEM 4 mm²; 769 Series

Technical Data

0.08 ... 4 mm² | 28 ... 12 AWG

U_N 250 V; U_{RM} 1000 V

1N4007 – 0.5 A continuous current

Terminal block width: 5 mm / 0.197 inch

8 ... 9 mm / 0.31 ... 0.35 inch

Technical Data

U_N 250 V; U_{RM} 1000 V

1N4007 – 0.5 A continuous current

Terminal block width: 5 mm / 0.197 inch

Note: 2-conductor female plugs cannot be used.

Please observe the application notes:

Insulation stop, page 346
Marking, from page 589

Approvals and corresponding ratings, visit www.wago.com

Accessories; 769 Series

Appropriate marking systems:
Mini-WSB/Mini-WSB Inline

Mini-WSB marking card; white; 10 strips with 10 markers/
card; 5 mm wide markers

	plain	248-501	5
--	-------	---------	---

Mini-WSB marking card; plain; 10 strips with 10 markers/
card; 5 mm wide markers

	yellow	248-501/000-002	5
	red	248-501/000-005	5
	blue	248-501/000-006	5
	gray	248-501/000-007	5
	orange	248-501/000-012	5
	light green	248-501/000-017	5
	green	248-501/000-023	5
	violet	248-501/000-024	5

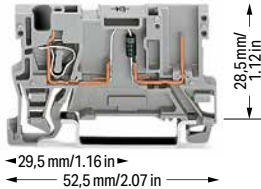

769-238/281-411 769-238/281-410

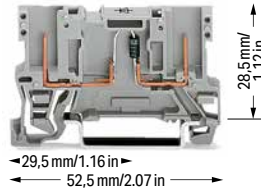

769-228/281-411 769-228/281-410

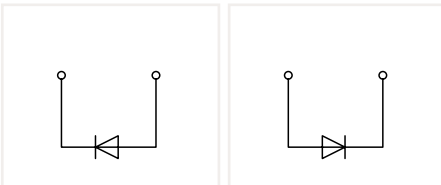

1-conductor/1-pin diode carrier terminal block

	Item No.	Pack. Unit
	769-238/281-411	100
	769-238/281-410	100

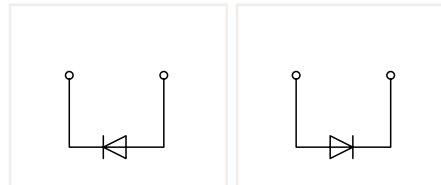

2-pin diode carrier block

	Item No.	Pack. Unit
	769-228/281-411	100
	769-228/281-410	100

Screwless end stop; for DIN-35 rail; 6 mm wide

	gray	249-116	100 (25)
--	------	---------	----------

Screwless end stop; for DIN-35 rail; 10 mm wide

	gray	249-117	50 (25)
--	------	---------	---------

Accessories; item-specific

End and intermediate plate; 1.1 mm thick

	orange	769-308	100 (25)
	gray	769-307	100 (25)

Insulation stop; 0.08 ... 0.2 mm² "s" (0.14 mm² "f-st"); 5 pcs/strip

	white	769-470	200 (25)
--	-------	---------	----------

Insulation stop; 0.25 ... 0.5 mm²; 5 pcs/strip

	light gray	769-471	200 (25)
--	------------	---------	----------

Insulation stop; 0.75 ... 1 mm²; 5 pcs/strip

	dark gray	769-472	200 (25)
--	-----------	---------	----------

Protective warning marker; with black high-voltage symbol; for 5 terminal blocks

	yellow	280-415	100 (25)
--	--------	---------	----------

Test plug; with 500 mm cable; 2 mm Ø; max. 42 V

	red	210-136	50
--	-----	---------	----

Accessories; item-specific

End and intermediate plate; 1.1 mm thick

	orange	769-306	100 (25)
	gray	769-305	100 (25)

Accessories; 769 Series

Appropriate marking systems: Mini-WSB/Mini-WSB Inline

Coding pin; for coding female plugs

	orange	769-435	100 (25)
--	--------	---------	----------

1-conductor female plug; straight

	gray	769-101	200
--	------	---------	-----

Test plug; with 500 mm cable; 2 mm Ø; max. 42 V

	yellow	210-137	50
--	--------	---------	----

1-conductor female plug; angled

	gray	769-101/022-000	200
--	------	-----------------	-----

1-Conductor/1-Pin and 2-Din Diode Carrier Terminal Block X-COM®-SYSTEM; with Two Jumper Positions

4 mm²; 769 Series

Technical Data	
0.08 ... 4 mm ²	28 ... 12 AWG
U _N 250 V; U _{RM} 1000 V	
1N4007 – 0.5 A continuous current	
Terminal block width: 5 mm / 0.197 inch	
 8 ... 9 mm / 0.31 ... 0.35 inch	

Technical Data	
U _N 250 V; U _{RM} 1000 V	
1N4007 – 0.5 A continuous current	
Terminal block width: 5 mm / 0.197 inch	

Please observe the application notes:
 Insulation stop, page 346
 Jumpers, from page 348
 Testing accessories, from page 344
 Marking, from page 589

Approvals and corresponding ratings, visit www.wago.com

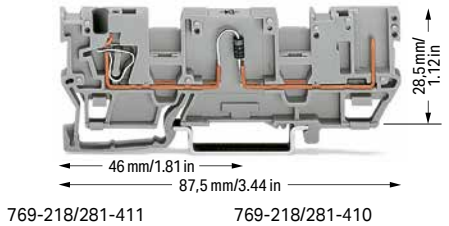

769-218/281-411 769-218/281-410

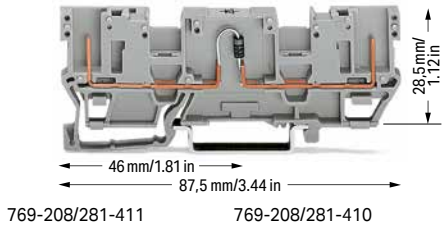

769-208/281-411 769-208/281-410

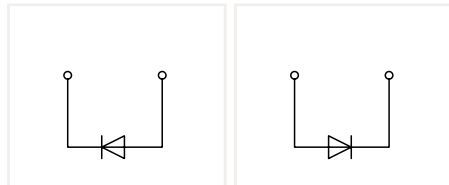

1-conductor/1-pin diode carrier terminal block; with two jumper positions

	Item No.	Pack. Unit
○ Anode, right side	769-218/281-411	50
○ Anode, left side	769-218/281-410	50

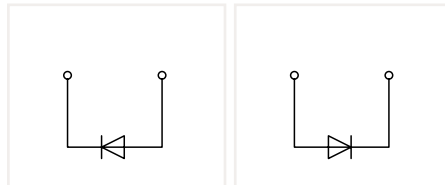

2-pin diode carrier terminal block; with two jumper positions

	Item No.	Pack. Unit
○ Anode, right side	769-208/281-411	50
○ Anode, left side	769-208/281-410	50

Accessories; item-specific

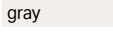
End and intermediate plate; 1.1 mm thick		
	orange	769-312 100 (25)
	gray	769-311 100 (25)

Separator; oversized; 1.1 mm thick

	orange	769-314 100 (25)
---	--------	------------------

Insulation stop; 0.08 ... 0.2 mm² "s" (0.14 mm² "f-st"); 5 pcs/strip

	white	769-470 200 (25)
---	-------	------------------

Insulation stop; 0.25 ... 0.5 mm²; 5 pcs/strip

	light gray	769-471 200 (25)
---	------------	------------------

Insulation stop; 0.75 ... 1 mm²; 5 pcs/strip

	dark gray	769-472 200 (25)
---	-----------	------------------

Protective warning marker; with black high-voltage symbol; for 5 terminal blocks

	yellow	280-415 100 (25)
---	--------	------------------

Test plug; with 500 mm cable; 2 mm Ø; max. 42 V

	red	210-136 50
---	-----	------------

Accessories; item-specific

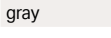
End and intermediate plate; 1.1 mm thick		
	orange	769-310 100 (25)
	gray	769-309 100 (25)

Separator; oversized; 1.1 mm thick

	orange	769-313 100 (25)
---	--------	------------------

Accessories; 769 Series

Appropriate marking systems:
 Mini-WSB/Mini-WSB Inline

Coding pin; for coding female plugs

	orange	769-435	100 (25)
---	--------	---------	----------

Adjacent jumper; insulated; I_N = I_N terminal block

	gray	280-402	200 (25)
---	------	---------	----------

Alternate jumper; insulated; I_N = I_N terminal block

	gray	280-409	100 (25)
---	------	---------	----------

Staggered jumper; insulated; 5 mm wide; I_N 24 A

	1 to 2	780-452	100 (25)
	1 to 3	780-453	100 (25)
	1 to 4	780-454	100 (25)
	1 to 5	780-455	50 (25)
	1 to 6	780-456	50 (25)
	1 to 7	780-457	50 (25)
	1 to 8	780-458	50 (25)

Push-in type wire jumper; insulated; 0.75 mm² conductor cross section; I_N 9 A

	L = 60 mm	249-125	100 (10)
	L = 110 mm	249-126	100 (10)
	L = 250 mm	249-127	100 (10)

Test plug module; snaps together; 5 mm wide

	gray	280-418	100 (25)
---	------	---------	----------

Spacer module; snaps together; 5 mm wide

	gray	280-419	100 (25)
---	------	---------	----------

Test plug; with 500 mm cable; 2 mm Ø; max. 42 V

	yellow	210-137	50
---	--------	---------	----

1-connector female plug; straight

	gray	769-101	200
---	------	---------	-----

1-conductor female plug; angled

	gray	769-101/022-000	200
---	------	-----------------	-----

2-conductor female plug

	gray	769-121	100
---	------	---------	-----

Mini-WSB marking card; white; 10 strips with 10 markers/card; 5 mm wide markers

	plain	248-501	5
---	-------	---------	---

1-Conductor/1-Pin and 2-Pin LED Carrier Terminal Block X-COM®-SYSTEM 4 mm²; 769 Series

Technical Data	
0.08 ... 4 mm ²	28 ... 12 AWG
24 VDC	
I _F 0.025 A max.	
Terminal block width: 5 mm / 0.197 inch	
 8 ... 9 mm / 0.31 ... 0.35 inch	

Technical Data	
24 VDC	
I _F 0.025 A max.	
Terminal block width: 5 mm / 0.197 inch	

Note: 2-conductor female plugs cannot be used.

Please observe the application notes:
Insulation stop, page 346
Marking, from page 589

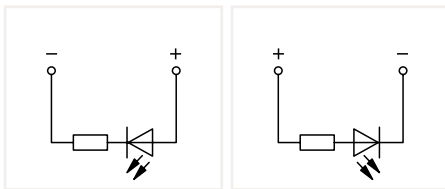
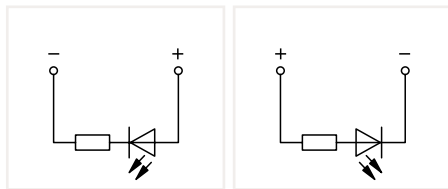
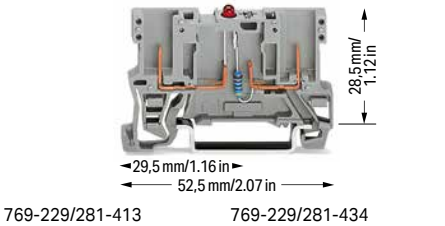
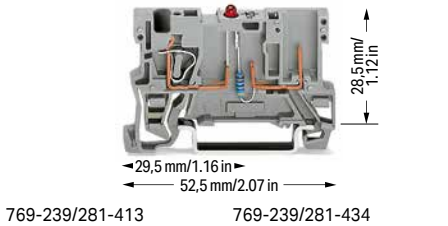

Approvals and corresponding ratings, visit www.wago.com





1-cond./1-pin LED carrier block		
	Item No.	Pack. Unit
<input type="radio"/> Anode, right side	769-239/281-413	100
<input type="radio"/> Anode, left side	769-239/281-434	100

2-pin LED carrier block		
	Item No.	Pack. Unit
<input type="radio"/> Anode, right side	769-229/281-413	100
<input type="radio"/> Anode, left side	769-229/281-434	100

Accessories; item-specific

End and intermediate plate; 1.1 mm thick		
 orange	769-308	100 (25)
 gray	769-307	100 (25)

Accessories; item-specific

End and intermediate plate; 1.1 mm thick		
 orange	769-306	100 (25)
 gray	769-305	100 (25)

Insulation stop; 0.08 ... 0.2 mm² "s" (0.14 mm² "f-st"); 5 pcs/strip

 white	769-470	200 (25)
---	---------	----------

Insulation stop; 0.25 ... 0.5 mm²; 5 pcs/strip

 light gray	769-471	200 (25)
--	---------	----------

Insulation stop; 0.75 ... 1 mm²; 5 pcs/strip

 dark gray	769-472	200 (25)
---	---------	----------

Protective warning marker; with black high-voltage symbol; for 5 terminal blocks

 yellow	280-415	100 (25)
---	---------	----------

Test plug; with 500 mm cable; 2 mm Ø; max. 42 V

 red	210-136	50
--	---------	----

Accessories; 769 Series

Appropriate marking systems: Mini-WSB/Mini-WSB Inline

Coding pin; for coding female plugs

 orange	769-435	100 (25)
---	---------	----------

1-connector female plug; straight

 gray	769-101	200
--	---------	-----

Test plug; with 500 mm cable; 2 mm Ø; max. 42 V

 yellow	210-137	50
---	---------	----

1-conductor female plug; angled

 gray	769-101/022-000	200
--	-----------------	-----

Accessories; 769 Series

Appropriate marking systems:
Mini-WSB/Mini-WSB Inline

Mini-WSB marking card; white; 10 strips with 10 markers/ card; 5 mm wide markers

 plain	248-501	5
---	---------	---

Mini-WSB marking card; plain; 10 strips with 10 markers/ card; 5 mm wide markers

 yellow	248-501/000-002	5
 red	248-501/000-005	5
 blue	248-501/000-006	5
 gray	248-501/000-007	5
 orange	248-501/000-012	5
 light green	248-501/000-017	5
 green	248-501/000-023	5
 violet	248-501/000-024	5

Screwless end stop; for DIN-35 rail; 6 mm wide

 gray	249-116	100 (25)
--	---------	----------

Screwless end stop; for DIN-35 rail; 10 mm wide

 gray	249-117	50 (25)
--	---------	---------

1-Conductor/1-Pin and 2-Pin LED Carrier Terminal Block X-COM®-SYSTEM; with Two Jumper Positions

4 mm²; 769 Series

Technical Data	
0.08 ... 4 mm ²	28 ... 12 AWG
24 VDC	
I _F 0.025 A max.	
Terminal block width: 5 mm / 0.197 inch	
 8 ... 9 mm / 0.31 ... 0.35 inch	

Technical Data	
24 VDC	
I _F 0.025 A max.	
Terminal block width: 5 mm / 0.197 inch	

Please observe the application notes:
 Insulation stop, page 346
 Jumpers, from page 348
 Testing accessories, from page 344
 Marking, from page 589

Approvals and corresponding ratings, visit www.wago.com

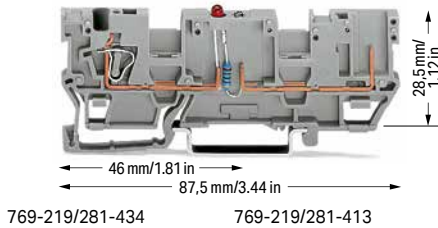

769-219/281-434 769-219/281-413

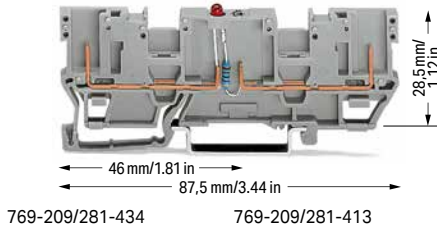

769-209/281-434 769-209/281-413

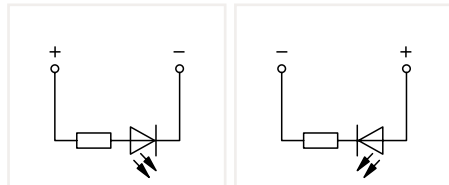

1-conductor/1-pin LED carrier terminal block; with two jumper positions

	Item No.	Pack. Unit
○ Anode, left side	769-219/281-434	50
○ Anode, right side	769-219/281-413	50

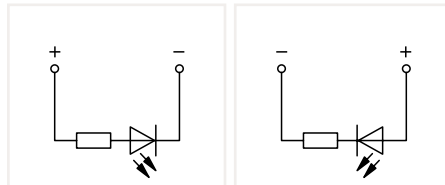

2-pin LED carrier terminal block; with two jumper positions

	Item No.	Pack. Unit
○ Anode, left side	769-209/281-434	50
○ Anode, right side	769-209/281-413	50

Accessories; item-specific

End and intermediate plate; 1.1 mm thick

orange	769-312	100 (25)
gray	769-311	100 (25)

Separator; oversized; 1.1 mm thick

orange	769-314	100 (25)
--------	---------	----------

Insulation stop; 0.08 ... 0.2 mm² "s" (0.14 mm² "f-st"); 5 pcs/strip

white	769-470	200 (25)
-------	---------	----------

Insulation stop; 0.25 ... 0.5 mm²; 5 pcs/strip

light gray	769-471	200 (25)
------------	---------	----------

Insulation stop; 0.75 ... 1 mm²; 5 pcs/strip

dark gray	769-472	200 (25)
-----------	---------	----------

Protective warning marker; with black high-voltage symbol; for 5 terminal blocks

yellow	280-415	100 (25)
--------	---------	----------

Test plug; with 500 mm cable; 2 mm Ø; max. 42 V

red	210-136	50
-----	---------	----

Accessories; item-specific

End and intermediate plate; 1.1 mm thick

orange	769-310	100 (25)
gray	769-309	100 (25)

Separator; oversized; 1.1 mm thick

orange	769-313	100 (25)
--------	---------	----------

Accessories; 769 Series

Appropriate marking systems:
 Mini-WSB/Mini-WSB Inline

Coding pin; for coding female plugs

orange	769-435	100 (25)
--------	---------	----------

Adjacent jumper; insulated; I_N = I_N terminal block

gray	280-402	200 (25)
------	---------	----------

Alternate jumper; insulated; I_N = I_N terminal block

gray	280-409	100 (25)
------	---------	----------

Staggered jumper; insulated; 5 mm wide; I_N 24 A

1 to 2	780-452	100 (25)
1 to 3	780-453	100 (25)
1 to 4	780-454	100 (25)
1 to 5	780-455	50 (25)
1 to 6	780-456	50 (25)
1 to 7	780-457	50 (25)
1 to 8	780-458	50 (25)

Push-in type wire jumper; insulated; 0.75 mm² conductor cross section; I_N 9 A

L = 60 mm	249-125	100 (10)
L = 110 mm	249-126	100 (10)
L = 250 mm	249-127	100 (10)

Test plug module; snaps together; 5 mm wide

gray	280-418	100 (25)
------	---------	----------

Spacer module; snaps together; 5 mm wide

gray	280-419	100 (25)
------	---------	----------

Test plug; with 500 mm cable; 2 mm Ø; max. 42 V

yellow	210-137	50
--------	---------	----

1-connector female plug; straight

gray	769-101	200
------	---------	-----

1-conductor female plug; angled

gray	769-101/022-000	200
------	-----------------	-----

2-conductor female plug

gray	769-121	100
------	---------	-----

Mini-WSB marking card; white; 10 strips with 10 markers/card; 5 mm wide markers

plain	248-501	5
-------	---------	---

6

1-Conductor/1-Pin and 2-Pin Carrier Terminal Blocks and 1-Conductor Female Plugs X-COM®-SYSTEM Assembly Types



1-conductor female plug
Disconnect carrier terminal blocks cannot be commoned.



1-conductor female plug
Disconnect carrier terminal blocks cannot be commoned.

6



1-conductor female plug
Diode carrier terminal blocks cannot be commoned.

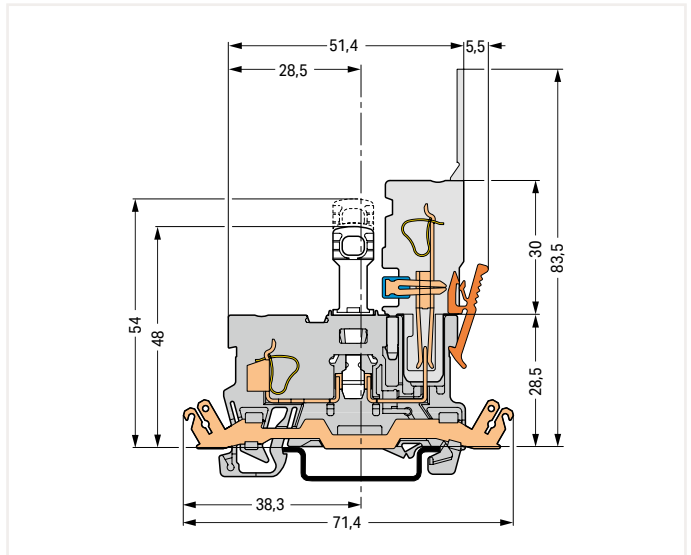

Disconnect carrier terminal block; with shield contact



1-conductor female plug
LED carrier terminal blocks cannot be commoned.

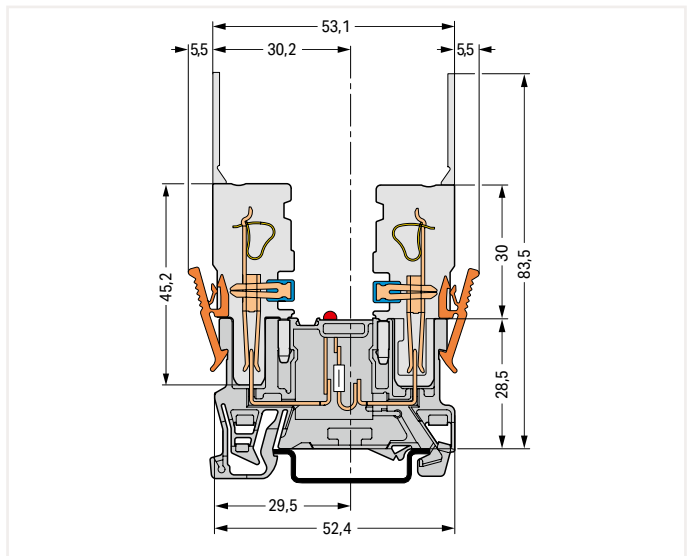

LED carrier terminal block

1-Conductor/1-Pin and 2-Pin Carrier Terminal Blocks X-COM®-SYSTEM; with Two Jumper Positions and 1-/2-Conductor Female Plugs Assembly Types



1-conductor female plug
Disconnect carrier terminal blocks can be commoned via 280 and 780 Series Jumpers and tested using a test plug adapter (280-4..).



2-conductor female plug
Disconnect carrier terminal blocks can be commoned via 280 and 780 Series Jumpers.



2-conductor female plug
Diode carrier terminal blocks can be commoned via 280 and 780 Series Jumpers and tested using a test plug adapter (280-4..).

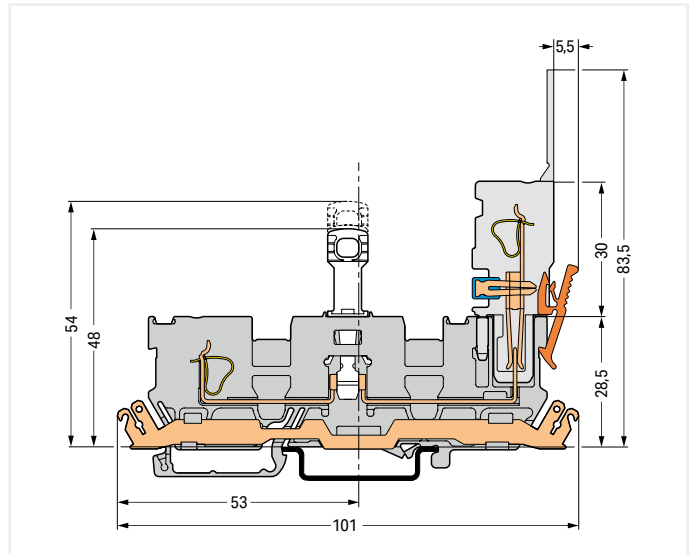

Disconnect carrier terminal block; with shield contact

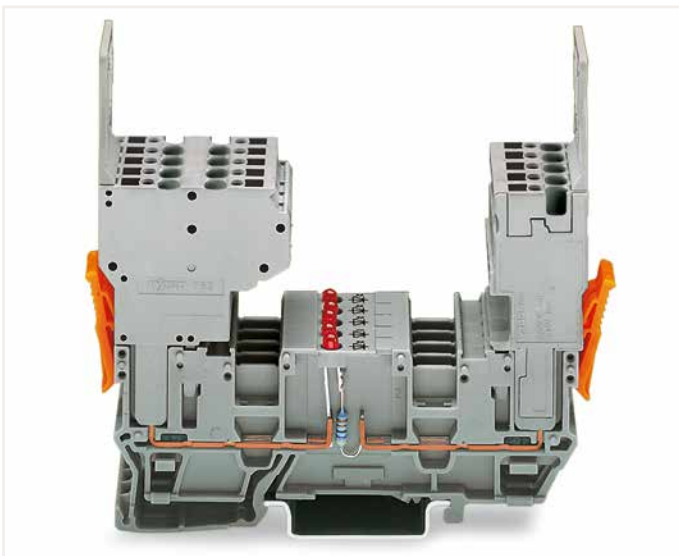

2-conductor and 1-conductor female plugs (may be reversed)
LED carrier terminal blocks can be commoned via 280 and 780 Series Jumpers and tested using a test plug adapter (280-4..).

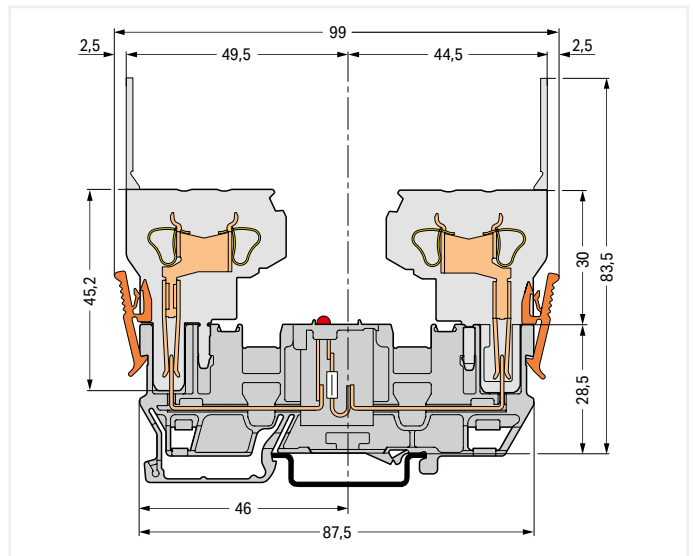

LED carrier terminal block

1-Conductor/1-Conductor Pin Disconnect Carrier Terminal Block X-COM®-SYSTEM; with Two Jumper Positions

4 mm²; 769 Series

Technical Data

0.08 ... 4 mm ²	28 ... 12 AWG
400 V/6 kV/3 ①	
I _N 16 A	
Terminal block width: 5 mm / 0.197 inch	
 8 ... 9 mm / 0.31 ... 0.35 inch	

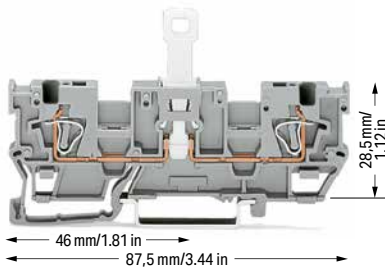

1-conductor/1-conductor pin disconnect carrier terminal block; with two jumper positions

Color	Item No.	Pack. Unit
○ gray	769-242	50

1-conductor/1-conductor disconnect carrier terminal block; with shield contact

○ gray	769-243 ①	50
--------	-----------	----

Accessories; 769 Series

Appropriate marking systems:
Mini-WSB/Mini-WSB Inline

End and intermediate plate; 1.1 mm thick

orange	769-318	100 (25)
gray	769-317	100 (25)

Separator plate; oversized; 1.1 mm thick

orange	769-319	100 (25)
--------	---------	----------

Insulation stop; 0.08 ... 0.2 mm² "s" (0.14 mm² "f-st"); 5 pcs/strip

white	769-470	200 (25)
-------	---------	----------

Insulation stop; 0.25 ... 0.5 mm²; 5 pcs/strip

light gray	769-471	200 (25)
------------	---------	----------

Insulation stop; 0.75 ... 1 mm²; 5 pcs/strip

dark gray	769-472	200 (25)
-----------	---------	----------

Protective warning marker; with black high-voltage symbol; for 5 terminal blocks

yellow	280-415	100 (25)
--------	---------	----------

Adjacent jumper; insulated; I_N = I_N terminal block

gray	280-402	200 (25)
------	---------	----------

Alternate jumper; insulated; I_N = I_N terminal block

gray	280-409	100 (25)
------	---------	----------

- ① 400 V = rated voltage
6 kV = rated impulse voltage
3 = pollution degree
250 V/4 kV/3 = Nominal voltage with shield contact (see Section 14)







Please observe the application notes:
Insulation stop, page 346
Jumpers, from page 348
Testing accessories, from page 344
Marking, from page 589

Approvals and corresponding ratings, visit www.wago.com

Accessories; 769 Series

Appropriate marking systems:
Mini-WSB/Mini-WSB Inline

Staggered jumper; insulated; 5 mm wide; I_N 24 A

	1 to 2	780-452	100 (25)
	1 to 3	780-453	100 (25)
	1 to 4	780-454	100 (25)
	1 to 5	780-455	50 (25)
	1 to 6	780-456	50 (25)
	1 to 7	780-457	50 (25)
	1 to 8	780-458	50 (25)

Push-in type wire jumper; insulated; 0.75 mm² conductor cross section; I_N 9 A

	L = 60 mm	249-125	100 (10)
	L = 110 mm	249-126	100 (10)
	L = 250 mm	249-127	100 (10)

Test plug module; snaps together; 5 mm wide

	gray	280-418	100 (25)
---	------	---------	----------

Spacer module; snaps together; 5 mm wide

	gray	280-419	100 (25)
---	------	---------	----------

Test plug; with 500 mm cable; 2 mm Ø; max. 42 V

	red	210-136	50
---	-----	---------	----

Test plug; with 500 mm cable; 2 mm Ø; max. 42 V

	yellow	210-137	50
---	--------	---------	----

Test plug adapter; 5 mm wide; for 210-137 Test Plug (2.3 mm Ø); for 1.5 ... 4 mm² terminal blocks

	gray	280-404	100 (25)
---	------	---------	----------

Disconnect lock; for disconnect tab used on disconnect terminal blocks (280/281 and 769 Series)

	red	709-170	200 (25)
---	-----	---------	----------

Mini-WSB marking card; white; 10 strips with 10 markers/ card; 5 mm wide markers

	plain	248-501	5
---	-------	---------	---

Accessories; 769 Series

Appropriate marking systems:
Mini-WSB/Mini-WSB Inline

Mini-WSB marking card; plain; 10 strips with 10 markers/ card; 5 mm wide markers

	yellow	248-501/000-002	5
	red	248-501/000-005	5
	blue	248-501/000-006	5
	gray	248-501/000-007	5
	orange	248-501/000-012	5
	light green	248-501/000-017	5
	green	248-501/000-023	5
	violet	248-501/000-024	5

Screwless end stop; for DIN-35 rail; 6 mm wide

	gray	249-116	100 (25)
---	------	---------	----------

Screwless end stop; for DIN-35 rail; 10 mm wide

	gray	249-117	50 (25)
---	------	---------	---------

1-Conductor/1-Conductor Pin Disconnect Carrier Terminal Blocks X-COM®-SYSTEM; with Two Jumper Positions Assembly Types

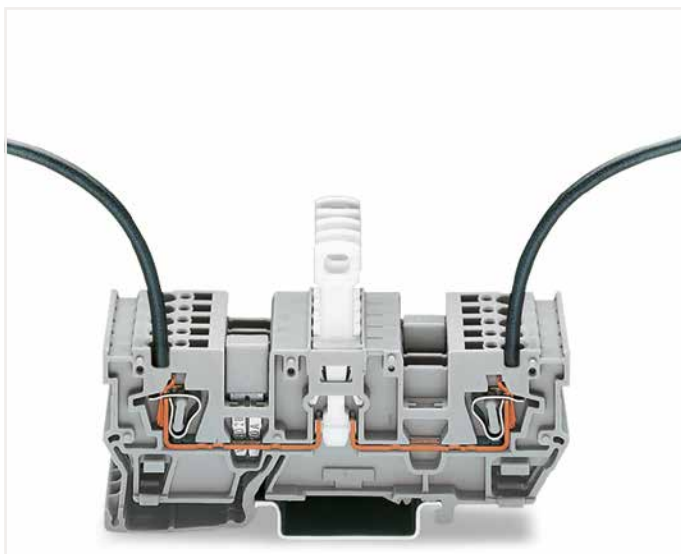

Carrier terminal blocks can be commoned via 280 and 780 Series Jumpers and tested using a test plug adapter (280-4..).

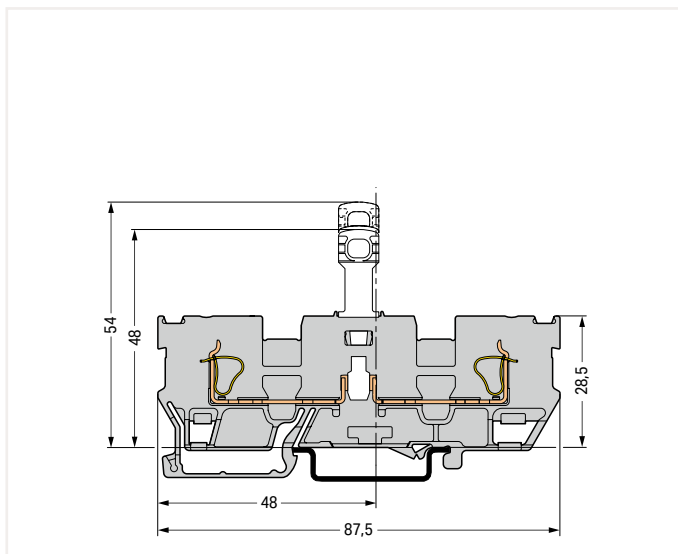

Disconnect carrier terminal block

1-Conductor/1-Pin Carrier Terminal Block and Carrier Terminal Block X-COM®-SYSTEM; for Pluggable Module (Fuses, Relays, Optocouplers, etc.) 4 mm²; 769 Series

Technical Data	
0.08 ... 4 mm²	28 ... 12 AWG
400 V/6 kV/3 ①	300 V, 20 A ②
I _N 16 A ②	300 V, 20 A ③
Terminal block width: 5 mm / 0.197 inch	
8 ... 9 mm / 0.31 ... 0.35 inch	

Technical Data	
0.08 ... 4 mm²	28 ... 12 AWG
400 V/6 kV/3 ①	300 V, 20 A ②
I _N 16 A ②	300 V, 20 A ③
8 ... 9 mm / 0.31 ... 0.35 inch	

① 400 V = rated voltage
6 kV = rated impulse voltage
3 = pollution degree
(see Section 14)

② 16 A, 85°C upper temperature limit, current-carrying capacity curves upon request

Note: 2-conductor female plugs cannot be used.

Please observe the application notes:
Insulation stop, page 346
Jumpers, from page 348
Testing accessories, from page 344
Marking, from page 589

Approvals and corresponding ratings, visit www.wago.com

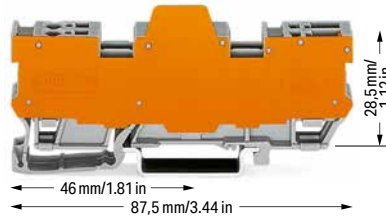
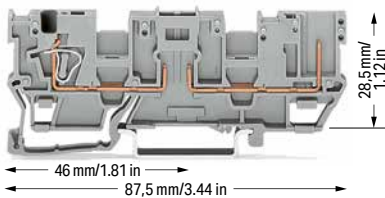

1-conductor/1-pin carrier terminal block; with two jumper positions; gray

	Item No.	Pack. Unit
○ 2-pole	769-181	50

1-conductor/1-pin terminal block for pluggable modules; with two jumper positions; with orange separator plate; gray

	Item No.	Pack. Unit
○ 4-pole; 11.1 mm wide	769-182/769-314	10
○ 6-pole; 16.1 mm wide	769-183/769-314	5
○ 8-pole; 21.1 mm wide	769-184/769-314	5
○ 10-pole; 26.1 mm wide	769-185/769-314	5

Accessories; 769 Series

Appropriate marking systems:
Mini-WSB/Mini-WSB Inline

Test plug adapter; 5 mm wide; for 210-137 Test Plug (2.3 mm Ø); for 1.5 ... 4 mm² terminal blocks

gray	280-404	100 (25)
------	---------	----------

1-connector female plug; straight

gray	769-101	200
------	---------	-----

Mini-WSB marking card; white; 10 strips with 10 markers/card; 5 mm wide markers

plain	248-501	5
-------	---------	---

Mini-WSB marking card; plain; 10 strips with 10 markers/card; 5 mm wide markers

yellow	248-501/000-002	5
red	248-501/000-005	5
blue	248-501/000-006	5
gray	248-501/000-007	5
orange	248-501/000-012	5
light green	248-501/000-017	5
green	248-501/000-023	5
violet	248-501/000-024	5

Screwless end stop; for DIN-35 rail; 6 mm wide

gray	249-116	100 (25)
------	---------	----------

Screwless end stop; for DIN-35 rail; 10 mm wide

gray	249-117	50 (25)
------	---------	---------

Accessories; 769 Series Appropriate marking systems: Mini-WSB/Mini-WSB Inline

End and intermediate plate; 1.1 mm thick

orange	769-312	100 (25)
gray	769-311	100 (25)

Separator; oversized; 1.1 mm thick

orange	769-314	100 (25)
--------	---------	----------

Insulation stop; 0.08 ... 0.2 mm² "s" (0.14 mm² "f-st"); 5 pcs/strip

white	769-470	200 (25)
-------	---------	----------

Insulation stop; 0.25 ... 0.5 mm²; 5 pcs/strip

light gray	769-471	200 (25)
------------	---------	----------

Insulation stop; 0.75 ... 1 mm²; 5 pcs/strip

dark gray	769-472	200 (25)
-----------	---------	----------

Protective warning marker; with black high-voltage symbol; for 5 terminal blocks

yellow	280-415	100 (25)
--------	---------	----------

Coding pin; for coding female plugs

orange	769-435	100 (25)
--------	---------	----------

Adjacent jumper; insulated; I_N = I_N terminal block

gray	280-402	200 (25)
------	---------	----------

Alternate jumper; insulated; I_N = I_N terminal block

gray	280-409	100 (25)
------	---------	----------

Staggered jumper; insulated; 5 mm wide; I_N 24 A

1 to 2	780-452	100 (25)
1 to 3	780-453	100 (25)
1 to 4	780-454	100 (25)
1 to 5	780-455	50 (25)
1 to 6	780-456	50 (25)
1 to 7	780-457	50 (25)
1 to 8	780-458	50 (25)

Push-in type wire jumper; insulated; 0.75 mm² conductor cross section; I_N 9 A

L = 60 mm	249-125	100 (10)
L = 110 mm	249-126	100 (10)
L = 250 mm	249-127	100 (10)

Test plug module; snaps together; 5 mm wide

gray	280-418	100 (25)
------	---------	----------

Spacer module; snaps together; 5 mm wide

gray	280-419	100 (25)
------	---------	----------

Test plug; with 500 mm cable; 2 mm Ø; max. 42 V

red	210-136	50
-----	---------	----

Test plug; with 500 mm cable; 2 mm Ø; max. 42 V

yellow	210-137	50
--------	---------	----

6

1-Conductor Female Plugs and Selection of Pluggable Modules X-COM®-SYSTEM Assembly Types

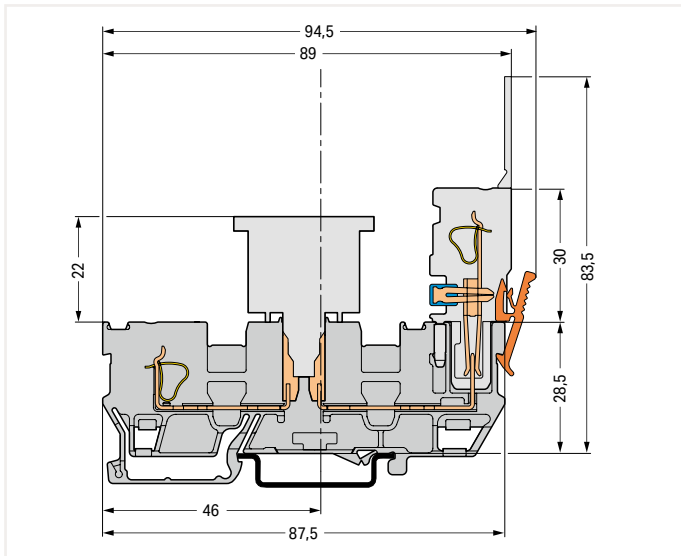

Carrier terminal block

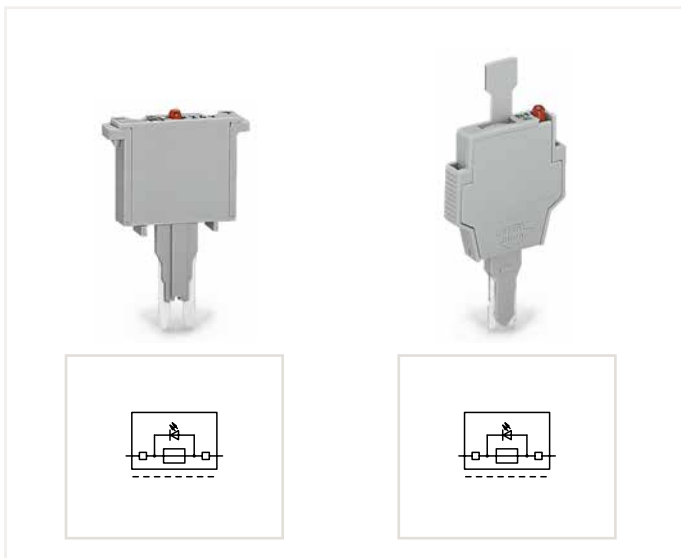

Selection of pluggable modules

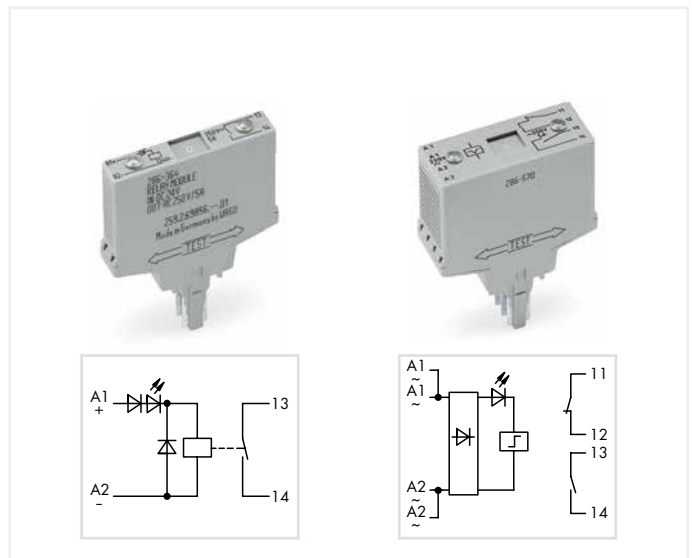

Selection of pluggable modules

Sold & Serviced By:



Toll Free Phone (877) SERV098

www.electromate.com

sales@electromate.com

2-Pin Carrier Terminal Block and Carrier Terminal Block X-COM®-SYSTEM; for Pluggable Module (Fuses, Relays, Optocouplers, etc.) 769 Series

Technical Data

400 V/6 kV/3 ①	300 V, 20 A ②
I _N 16 A ②	300 V, 20 A ②
Terminal block width: 5 mm / 0.197 inch	

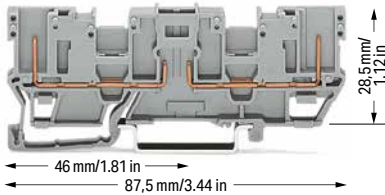

2-pin carrier terminal block; with two jumper positions; gray

	Item No.	Pack. Unit
○ 2-pole	769-161	50

Technical Data

400 V/6 kV/3 ①	300 V, 20 A ②
I _N 16 A ②	300 V, 20 A ②

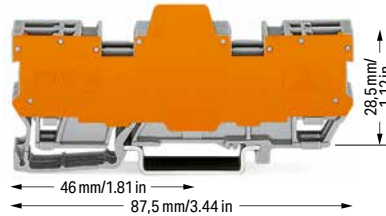

2-pin terminal block for pluggable modules; with two jumper positions; with orange separator plate; gray

	Item No.	Pack. Unit
○ 4-pole; 11.1 mm wide	769-162/769-313	10
○ 6-pole; 16.1 mm wide	769-163/769-313	5
○ 8-pole; 21.1 mm wide	769-164/769-313	5
○ 10-pole; 26.1 mm wide	769-165/769-313	5

① 400 V = rated voltage
6 kV = rated impulse voltage
3 = pollution degree
(see Section 14)

② 16 A, 85°C upper temperature limit, current-carrying capacity curves upon request

Note: 2-conductor female plugs cannot be used.

Please observe the application notes:
Jumpers, from page 348
Marking, from page 589

Approvals and corresponding ratings, visit www.wago.com

6

Accessories; 769 Series

Appropriate marking systems: Mini-WSB/Mini-WSB Inline

End and intermediate plate; 1.1 mm thick

orange	769-310	100 (25)
gray	769-309	100 (25)

Separator; oversized; 1.1 mm thick

orange	769-313	100 (25)
--------	---------	----------

Coding pin; for coding female plugs

orange	769-435	100 (25)
--------	---------	----------

Adjacent jumper; insulated; I_N = I_N terminal block

gray	280-402	200 (25)
------	---------	----------

Alternate jumper; insulated; I_N = I_N terminal block

gray	280-409	100 (25)
------	---------	----------

Staggered jumper; insulated; 5 mm wide; I_N 24 A

1 to 2	780-452	100 (25)
1 to 3	780-453	100 (25)
1 to 4	780-454	100 (25)
1 to 5	780-455	50 (25)
1 to 6	780-456	50 (25)
1 to 7	780-457	50 (25)
1 to 8	780-458	50 (25)

Push-in type wire jumper; insulated; 0.75 mm² conductor cross section; I_N 9 A

L = 60 mm	249-125	100 (10)
L = 110 mm	249-126	100 (10)
L = 250 mm	249-127	100 (10)

Test plug; with 500 mm cable; 2 mm Ø; max. 42 V

yellow	210-137	50
--------	---------	----

1-conductor female plug; straight

gray	769-101	200
------	---------	-----

1-conductor female plug; angled

gray	769-101/022-000	200
------	-----------------	-----

Mini-WSB marking card; white; 10 strips with 10 markers/ card; 5 mm wide markers

plain	248-501	5
-------	---------	---

Mini-WSB marking card; plain; 10 strips with 10 markers/ card; 5 mm wide markers

yellow	248-501/000-002	5
red	248-501/000-005	5
blue	248-501/000-006	5
gray	248-501/000-007	5
orange	248-501/000-012	5
light green	248-501/000-017	5
green	248-501/000-023	5
violet	248-501/000-024	5

Screwless end stop; for DIN-35 rail; 6 mm wide

gray	249-116	100 (25)
------	---------	----------

Screwless end stop; for DIN-35 rail; 10 mm wide

gray	249-117	50 (25)
------	---------	---------

1-Conductor Female Plugs and Selection of Pluggable Modules X-COM®-SYSTEM Assembly Types

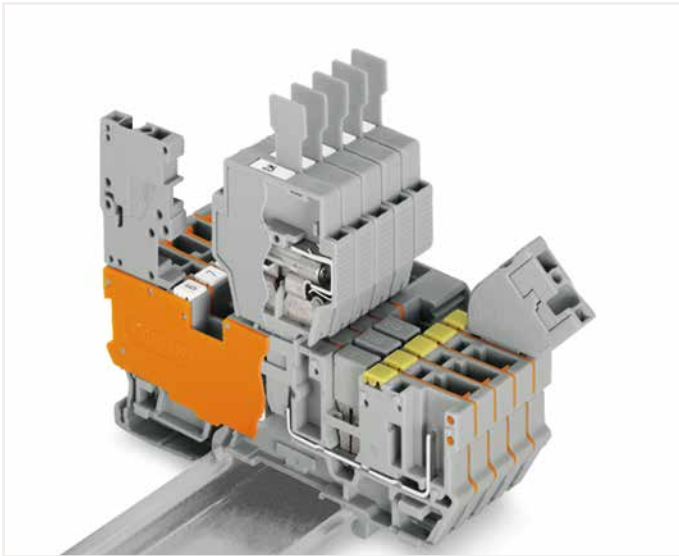

With 6 mm wide fuse plugs, only 1-pole female plugs can be used. Comming is only possible using adjacent jumpers (280 Series) and push-in type wire jumpers.

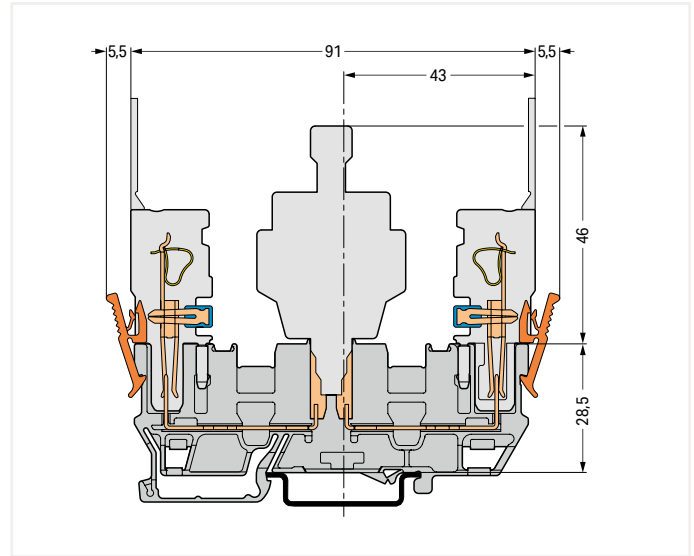

Carrier terminal block
For other dimensions, see carrier terminal block (769-151).



2-pin terminal block for pluggable modules; with orange separator plate

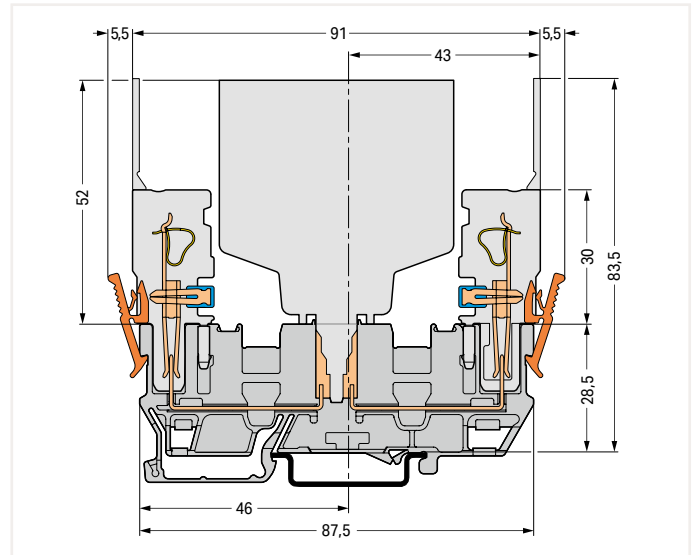

Carrier terminal block

6

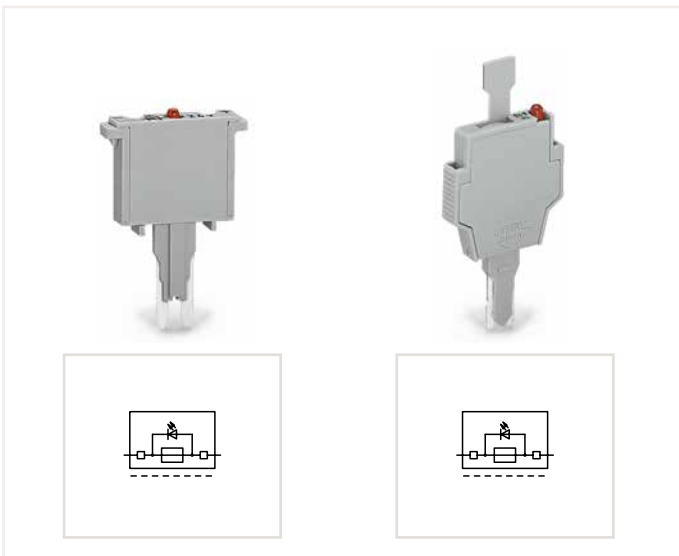

Selection of pluggable modules

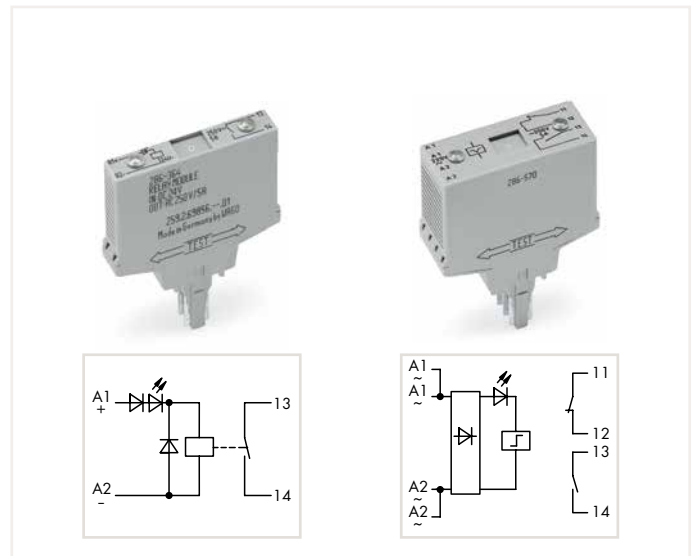

Selection of pluggable modules

1-Conductor/1-Conductor Carrier Terminal Block and Carrier Terminal Block X-COM®-SYSTEM; for Pluggable Module (Fuses, Relays, Optocouplers, etc.) 4 mm²; 769 Series

Technical Data	
0.08 ... 4 mm²	28 ... 12 AWG
400 V/6 kV/3 ①	300 V, 20 A ②
I _N 16 A ②	300 V, 20 A ②
Terminal block width: 5 mm / 0.197 inch	
8 ... 9 mm / 0.31 ... 0.35 inch	

Technical Data	
0.08 ... 4 mm²	28 ... 12 AWG
400 V/6 kV/3 ①	300 V, 20 A ②
I _N 16 A ②	300 V, 20 A ②
8 ... 9 mm / 0.31 ... 0.35 inch	

① 400 V = rated voltage
6 kV = rated impulse voltage
3 = pollution degree
(see Section 14)

② 16 A, 85°C upper temperature limit, current-carrying capacity curves upon request

Note: 2-conductor female plugs cannot be used.

Please observe the application notes:
Insulation stop, page 346
Jumpers, from page 348
Testing accessories, from page 344
Marking, from page 589

Approvals and corresponding ratings, visit www.wago.com

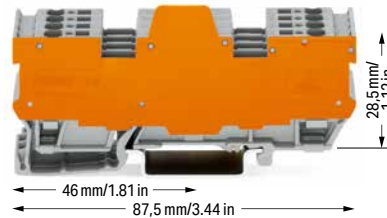
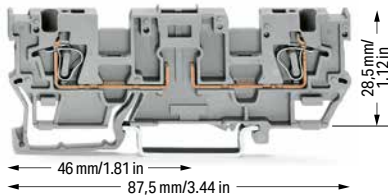

1-conductor/1-conductor carrier terminal block; with two jumper positions; gray

	Item No.	Pack. Unit
○ 2-pole	769-191	50

1-conductor/1-conductor terminal block for pluggable modules; with two jumper positions; with orange separator plate; gray

	Item No.	Pack. Unit
○ 4-pole; 11.1 mm wide	769-192/769-319	10
○ 6-pole; 16.1 mm wide	769-193/769-319	5
○ 8-pole; 21.1 mm wide	769-194/769-319	5
○ 10-pole; 26.1 mm wide	769-195/769-319	5

6

Accessories; 769 Series

Appropriate marking systems: Mini-WSB/Mini-WSB Inline

End and intermediate plate; 1.1 mm thick		
orange	769-316	100 (25)
gray	769-317	100 (25)

Separator; oversized; 1.1 mm thick		
orange	769-319	100 (25)

Insulation stop; 0.08 ... 0.2 mm² "s" (0.14 mm² "f-st"); 5 pcs/strip		
white	769-470	200 (25)

Insulation stop; 0.25 ... 0.5 mm²; 5 pcs/strip		
light gray	769-471	200 (25)

Insulation stop; 0.75 ... 1 mm²; 5 pcs/strip		
dark gray	769-472	200 (25)

Protective warning marker; with black high-voltage symbol; for 5 terminal blocks		
yellow	280-415	100 (25)

Adjacent jumper; insulated; I _N = I _N terminal block		
gray	280-402	200 (25)

Alternate jumper; insulated; I _N = I _N terminal block		
gray	280-409	100 (25)

Staggered jumper; insulated; 5 mm wide; I _N 24 A		
1 to 2	780-452	100 (25)
1 to 3	780-453	100 (25)
1 to 4	780-454	100 (25)
1 to 5	780-455	50 (25)
1 to 6	780-456	50 (25)
1 to 7	780-457	50 (25)
1 to 8	780-458	50 (25)

Push-in type wire jumper; insulated; 0.75 mm² conductor cross section; I _N 9 A		
L = 60 mm	249-125	100 (10)
L = 110 mm	249-126	100 (10)
L = 250 mm	249-127	100 (10)

Test plug; with 500 mm cable; 2 mm Ø; max. 42 V		
red	210-136	50

Test plug; with 500 mm cable; 2 mm Ø; max. 42 V		
yellow	210-137	50

Mini-WSB marking card; white; 10 strips with 10 markers/card; 5 mm wide markers		
plain	248-501	6

Mini-WSB marking card; plain; 10 strips with 10 markers/card; 5 mm wide markers		
yellow	248-501/000-002	5
red	248-501/000-005	5
blue	248-501/000-006	5
gray	248-501/000-007	5
orange	248-501/000-012	5
light green	248-501/000-017	5
green	248-501/000-023	5
violet	248-501/000-024	5

Selection of Pluggable Modules Assembly Types

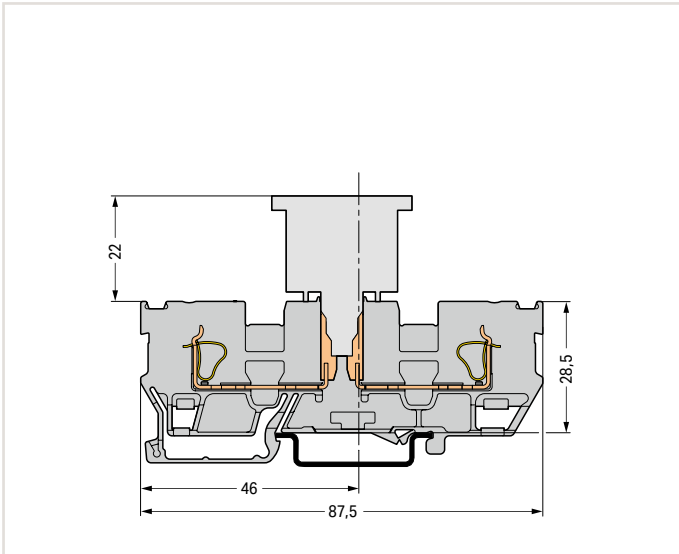

Carrier terminal block

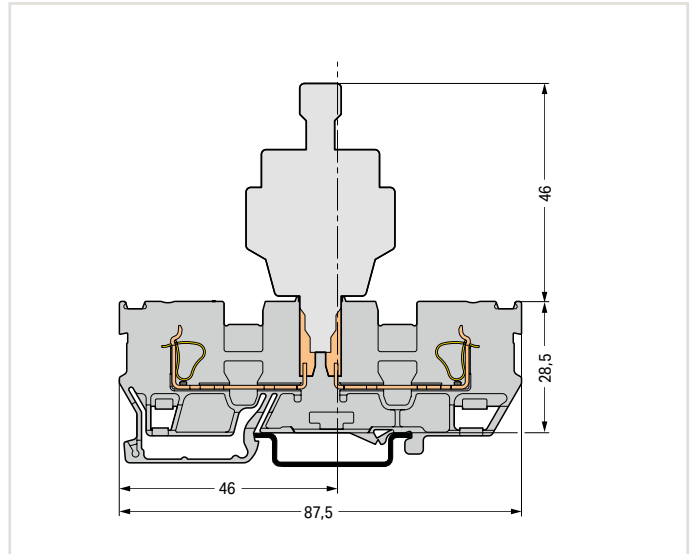

Carrier terminal block

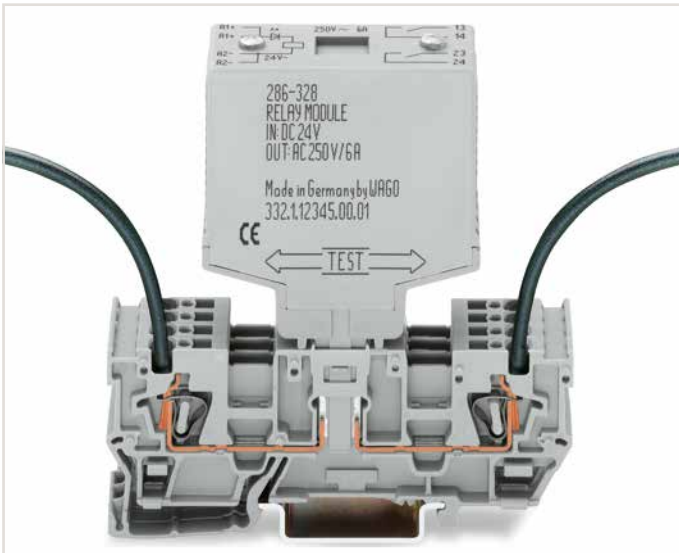

1-conductor/1-conductor carrier terminal block; with two jumper positions

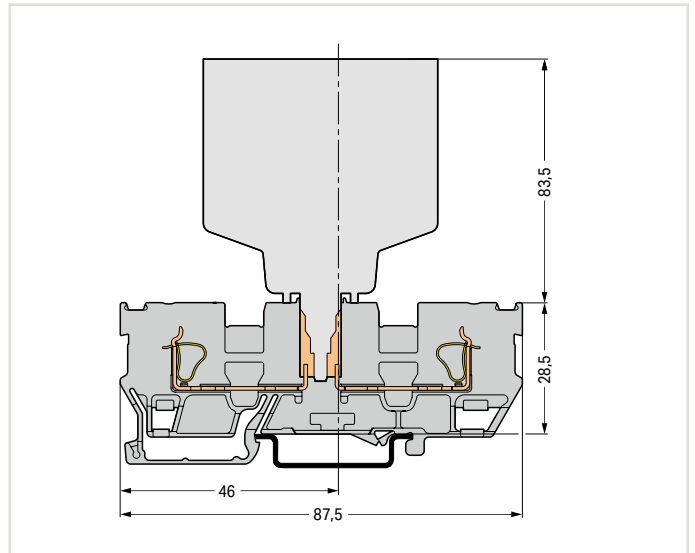

Carrier terminal block

6

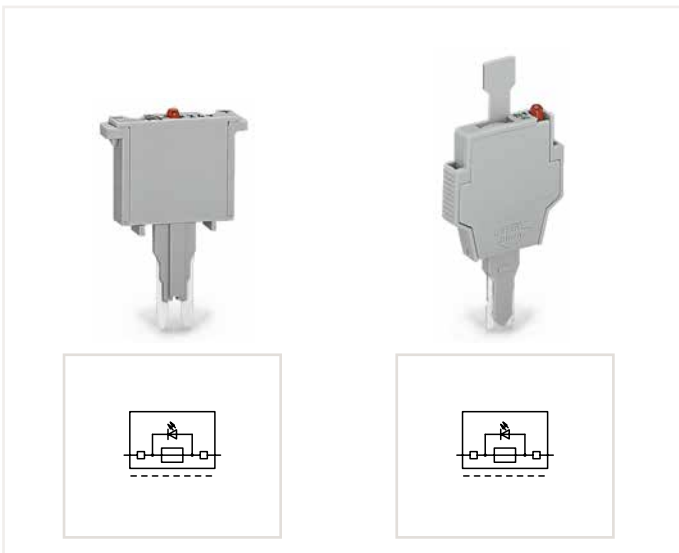

Selection of pluggable modules

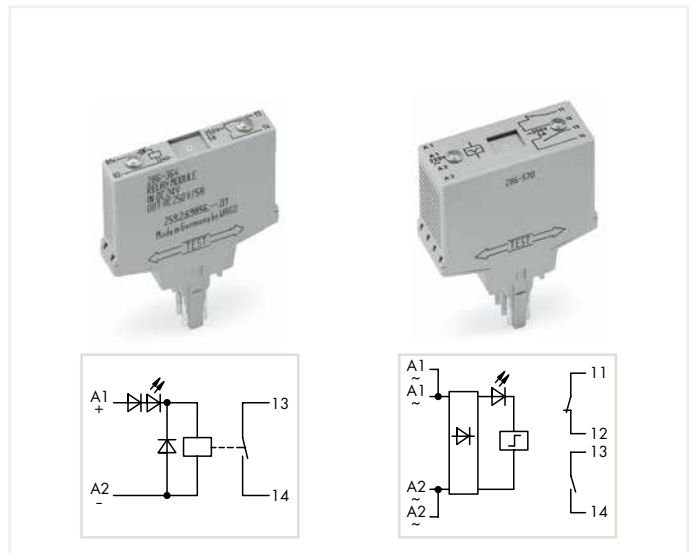

Selection of pluggable modules

Fuse Plugs, Pluggable Diode and LED Modules



Fuse plug; with soldered miniature fuse; 5 mm wide; gray
Electrical ratings are given by the fuse.

	Item No.	Pack. Unit
	250 mA FF 280-850	100
	500 mA FF 280-852	100
	1 A FF 280-854	100
	2 A FF 280-856	100

Diode module; with 1N4007 diode; 5 mm wide

	Item No.	Pack. Unit
	gray 280-801/281-411	100

LED module; with red LED; 5 mm wide; I_N 5.6 mA; I_F 25 mA; gray

	Item No.	Pack. Unit
	24 VDC 280-801/281-413	100
	48 VDC 280-801/281-414	100

Fuse plug; with soldered miniature fuse; with additional indicator lamp; red LED; 15 ... 30 VDC; 5 mm wide; gray
Electrical ratings are given by the fuse and blown fuse indication. Leakage current in case of a blown fuse: LED 5 ... 20 mA

	Item No.	Pack. Unit
	250 mA FF 280-850/281-413	100
	500 mA FF 280-852/281-413	100
	1 A FF 280-854/281-413	100
	2 A FF 280-856/281-413	100

Diode module; with 1N4007 recovery diode; red LED; 5 mm wide; gray

	Item No.	Pack. Unit
	24 VDC 280-801/281-420	100
	48 VDC 280-801/281-421	100

LED module; with red LED; 5 mm wide; I_N 5.6 mA; I_F 25 mA; gray

	Item No.	Pack. Unit
	24 VAC/DC 280-801/281-415	100
	48 VAC/VDC 280-801/281-416	100

Fuse plug with pull-tab; for 5 x 20 mm and 5 x 25 mm glass cartridge fuses; 6 mm wide
Electrical ratings are given by the fuse.

	Item No.	Pack. Unit
	281-511	50

Neon indicator module; 5 mm wide; I_N 0.5 mA; gray

	Item No.	Pack. Unit
	120 VAC/VDC 280-801/281-418	100
	230 VAC/VDC 280-801/281-417	100

Fuse plug with pull-tab; for 5 x 20 mm and 5 x 25 mm glass cartridge fuses; with hole for one LED (for self-assembly); 6 mm wide; gray
Electrical ratings are given by the fuse and blown fuse indication.

	Item No.	Pack. Unit
	281-512	50

Fuse plug with pull-tab; for 5 x 20 mm and 5 x 25 mm glass cartridge fuses; with LED; 24 VAC/DC; 6 mm wide
Electrical ratings are given by the fuse and blown fuse indication. Leakage current in case of a blown fuse: LED 5 ... 20 mA

	Item No.	Pack. Unit
	281-512/281-501	50

Fuse plug with pull-tab; for 5 x 20 mm and 5 x 25 mm glass cartridge fuses; with neon lamp; 120 VAC/DC; 6 mm wide
Electrical ratings are given by the fuse and blown fuse indication. Leakage current in case of a blown fuse: Neon lamp < 0.4 mA

	Item No.	Pack. Unit
	281-512/281-418	50
	281-512/281-417	50

6

6

1-Conductor/1-Pin Double-Deck Carrier Terminal Block X-COM®-SYSTEM

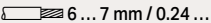

2.5 (4 "f-st") mm²; 870 Series

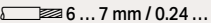

Technical Data	
0.08 ... 2.5 (4 "f-st") mm ² ①	28 ... 12 AWG
500 V/6 kV/3 ②	300 V, 20 A 
I _N 16 A	
Terminal block width: 5 mm / 0.197 inch	
 6 ... 7 mm / 0.24 ... 0.28 inch	

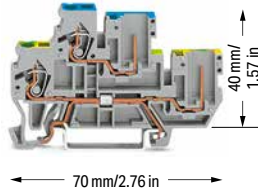
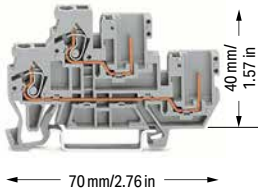
Technical Data	
0.08 ... 2.5 (4 "f-st") mm ² ①	28 ... 12 AWG
500 V/6 kV/3 ②	
I _N 16 A	
Terminal block width: 5 mm / 0.197 inch	
 6 ... 7 mm / 0.24 ... 0.28 inch	

- ① Max. insulation diameter: 4.4 mm
 - ② 500 V = rated voltage
6 kV = rated impulse voltage
3 = pollution degree (see Section 14)
- Note: 2-conductor female plugs cannot be used.
- Please observe the application notes:
Insulation stop, page 346
Marking, from page 589
- Approvals and corresponding ratings, visit www.wago.com





1-conductor/1-pin double-deck carrier terminal block; Through/through terminal block; Gray housing		
	Item No.	Pack. Unit
 L/L	870-101	50
 N/L	870-102	50
 L/N	870-103	50

1-conductor/1-pin double-deck carrier terminal block; Ground conductor/through terminal block; Gray housing		
	Item No.	Pack. Unit
 PE/N	870-117	50
 PE/L	870-127	50

1-conductor/1-pin double-deck carrier terminal block; Through/through terminal block; Blue housing		
 N/N	870-104	50

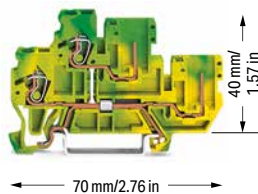
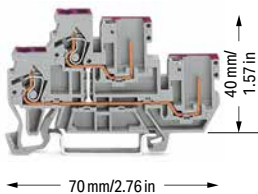
Other terminal blocks with the same profile:		
Through	870-501	Page 432





2-conductor/2-pin double-deck carrier terminal block; 2-conductor/2-pin through terminal block; internally commoned; Violet conductor entry; Gray housing		
	Item No.	Pack. Unit
 L	870-108	50

2-conductor/2-pin double-deck carrier block; 2-conductor/2-pin ground conductor block; internally commoned; Green-yellow housing		
	Item No.	Pack. Unit
 PE	870-107	50

2-conductor/2-pin double-deck carrier terminal block; 2-conductor/2-pin through terminal block; internally commoned; Violet conductor entry; Blue housing		
 N	870-109	50

Accessories; 870 Series

Appropriate marking systems:
Mini-WSB/Mini-WSB Inline/WMB/WMB Inline

End and intermediate plate; 1 mm thick		
	orange	870-119 100 (25)
	gray	870-118 100 (25)

Insulation stop; 0.08 ... 0.2 mm ² "s" (0.14 mm ² "f-st"); 5 pcs/strip		
	white	280-470 200 (25)

Insulation stop; 0.25 ... 0.5 mm ² ; 5 pcs/strip		
	light gray	280-471 200 (25)

Insulation stop; 0.75 ... 1 mm ² ; 5 pcs/strip		
	dark gray	280-472 200 (25)

Coding pin; for coding female plugs		
	orange	769-435 100 (25)

Push-in type jumper bar; insulated; I _N 18 A; light gray		
	2-way	870-402 200 (25)
	3-way	870-403 200 (25)
	4-way	870-404 100 (25)
	5-way	870-405 100 (25)
	6-way	870-406 100 (25)
	7-way	870-407 100 (25)
	8-way	870-408 100 (25)
	9-way	870-409 100 (25)
	10-way	870-410 50 (25)

Push-in type jumper bar; insulated; I _N 18 A; light gray		
	1 to 3	870-433 200 (25)
	1 to 4	870-434 200 (25)
	1 to 5	870-435 100 (25)
	1 to 6	870-436 100 (25)
	1 to 7	870-437 100 (25)
	1 to 8	870-438 100 (25)
	1 to 9	870-439 100 (25)
	1 to 10	870-440 50 (25)

Pin cover; with Mini-WSB marker slot		
	gray	769-438 100 (25)
	orange	769-439 100 (25)

1-connector female plug; straight		
	gray	769-101 200

1-conductor female plug; angled		
	gray	769-101/022-000 200

6

1-Conductor/1-Pin Double-Deck Carrier Terminal Blocks and 1-/2-Conductor Female Plugs X-COM®-SYSTEM Assembly Types



Commoning a double-deck through terminal block (870-501) with a 1-conductor/1-pin double-deck terminal block (870-101) via push-in type jumper bar.

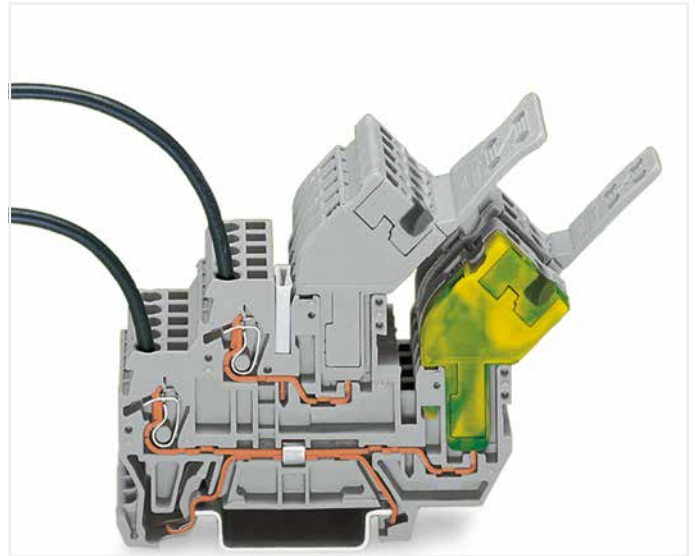

1-conductor female plug; angled
Double-deck carrier terminal blocks can be commoned via 870 Series Push-In Type Jumper Bars.

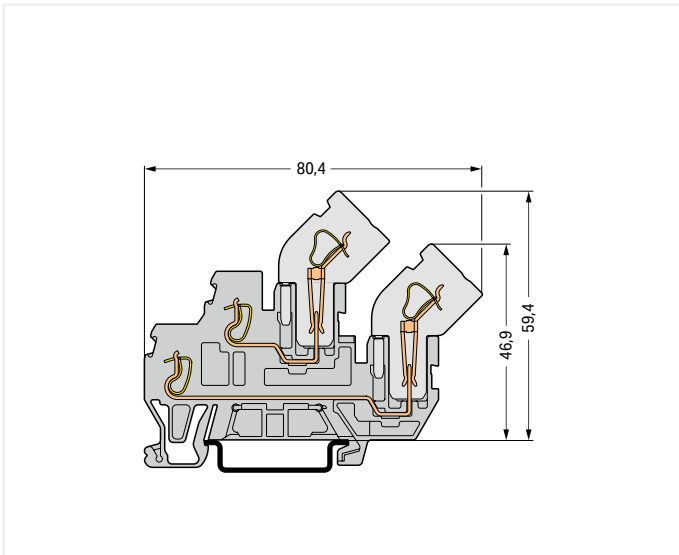

Carrier terminal block

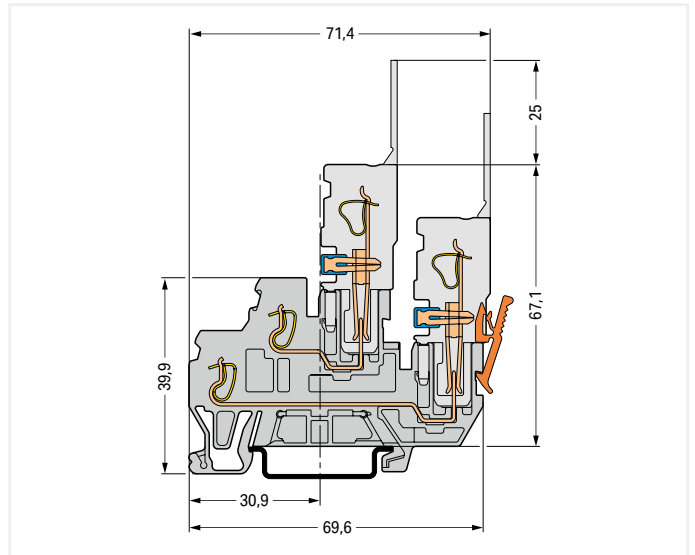

Carrier terminal block

2-Conductor/1-Pin Double-Deck Carrier Terminal Block X-COM®-SYSTEM 2.5 (4 "f-st") mm²; 870 Series

Technical Data

0.08 ... 2.5 (4 "f-st") mm² ① | 28 ... 12 AWG

500 V/6 kV/3 ②

I_N 16 A

Terminal block width: 5 mm / 0.197 inch

6 ... 7 mm / 0.24 ... 0.28 inch

Technical Data

0.08 ... 2.5 (4 "f-st") mm² ① | 28 ... 12 AWG

Terminal block width: 5 mm / 0.197 inch

6 ... 7 mm / 0.24 ... 0.28 inch

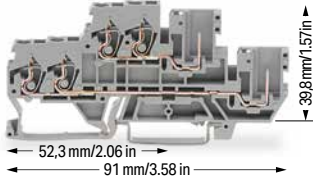

2-conductor/1-pin double-deck carrier terminal block; Through/through terminal block; Gray housing

	Item No.	Pack. Unit
○ L/L	870-1131	40

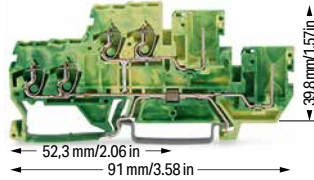

4-conductor/2-pin double-deck carrier block; 4-conductor/2-pin ground conductor block; internally commoned; Green-yellow housing

	Item No.	Pack. Unit
● PE/N	870-1137	40

4-conductor/2-pin double-deck carrier terminal block; 2-conductor/2-pin through terminal block; internally commoned; Violet conductor entry; Gray housing

	Item No.	Pack. Unit
○ L	870-1138	40

① Max. insulation diameter: 4.4 mm

② 500 V = rated voltage
6 kV = rated impulse voltage
3 = pollution degree (see Section 14)

Note: 2-conductor female plugs cannot be used.



Please observe the application notes:
Insulation stop, page 346
Marking, from page 589

Approvals and corresponding ratings, visit www.wago.com

Accessories; 870 Series

Appropriate marking systems:
Mini-WSB/Mini-WSB Inline/WMB/WMB Inline

End and intermediate plate; 1 mm thick

	orange	870-1149	100 (25)
	gray	870-1148	100 (25)

Insulation stop; 0.08 ... 0.2 mm² "s" (0.14 mm² "f-st"); 5 pcs/strip

	white	280-470	200 (25)
---	-------	---------	----------

Insulation stop; 0.25 ... 0.5 mm²; 5 pcs/strip

	light gray	280-471	200 (25)
--	------------	---------	----------

Insulation stop; 0.75 ... 1 mm²; 5 pcs/strip

	dark gray	280-472	200 (25)
---	-----------	---------	----------

Coding pin; for coding female plugs

	orange	769-435	100 (25)
---	--------	---------	----------

Push-in type jumper bar; insulated; I_N 18 A; light gray

	2-way	870-402	200 (25)
	3-way	870-403	200 (25)
	4-way	870-404	100 (25)
	5-way	870-405	100 (25)
	6-way	870-406	100 (25)
	7-way	870-407	100 (25)
	8-way	870-408	100 (25)
	9-way	870-409	100 (25)
	10-way	870-410	50 (25)

Push-in type jumper bar; insulated; I_N 18 A; light gray

	1 to 3	870-433	200 (25)
	1 to 4	870-434	200 (25)
	1 to 5	870-435	100 (25)
	1 to 6	870-436	100 (25)
	1 to 7	870-437	100 (25)
	1 to 8	870-438	100 (25)
	1 to 9	870-439	100 (25)
	1 to 10	870-440	50 (25)

Pin cover; with Mini-WSB marker slot

	gray	769-438	100 (25)
	orange	769-439	100 (25)

1-conductor female plug; straight

	gray	769-101	200
---	------	---------	-----

1-conductor female plug; angled

	gray	769-101/022-000	200
---	------	-----------------	-----

6

2-Pin/2-Pin Double-Deck Carrier Terminal Block X-COM®-SYSTEM 870 Series

Technical Data	
500 V/6 kV/3 ①	
I _N 16 A	
Terminal block width: 5 mm / 0.197 inch	

Technical Data	
Terminal block width: 5 mm / 0.197 inch	



① 500 V = rated voltage
6 kV = rated impulse voltage
3 = pollution degree
(see Section 14)

Note: 2-conductor female plugs cannot be used.

Approvals and corresponding ratings, visit www.wago.com

Accessories; 870 Series

Appropriate marking systems:
Mini-WSB/Mini-WSB Inline/WMB/WMB Inline

End and intermediate plate; 1 mm thick			
	orange	870-169	100 (25)
	gray	870-168	100 (25)

Coding pin; for coding female plugs			
	orange	769-435	100 (25)

Push-in type jumper bar; insulated; I _N 18 A; light gray			
	2-way	870-402	200 (25)
	3-way	870-403	200 (25)
	4-way	870-404	100 (25)
	5-way	870-405	100 (25)
	6-way	870-406	100 (25)
	7-way	870-407	100 (25)
	8-way	870-408	100 (25)
	9-way	870-409	100 (25)
	10-way	870-410	50 (25)

Push-in type jumper bar; insulated; I _N 18 A; light gray			
	1 to 3	870-433	200 (25)
	1 to 4	870-434	200 (25)
	1 to 5	870-435	100 (25)
	1 to 6	870-436	100 (25)
	1 to 7	870-437	100 (25)
	1 to 8	870-438	100 (25)
	1 to 9	870-439	100 (25)
	1 to 10	870-440	50 (25)

Pin cover; with Mini-WSB marker slot			
	gray	769-438	100 (25)
	orange	769-439	100 (25)

1-connector female plug; straight			
	gray	769-101	200

1-conductor female plug; angled			
	gray	769-101/022-000	200

Mini-WSB marking card; white; 10 strips with 10 markers/ card; 5 mm wide markers			
	plain	248-501	5

Mini-WSB marking card; plain; 10 strips with 10 markers/ card; 5 mm wide markers			
	yellow	248-501/000-002	5
	red	248-501/000-005	5
	blue	248-501/000-006	5
	gray	248-501/000-007	5
	orange	248-501/000-012	5
	light green	248-501/000-017	5
	green	248-501/000-023	5
	violet	248-501/000-024	5

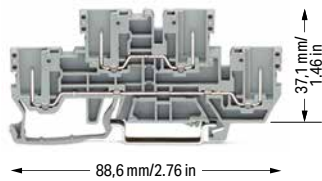

2-pin/2-pin double-deck carrier terminal block; Through/through terminal block; Gray housing

	Item No.	Pack. Unit
○ L/L	870-151	50

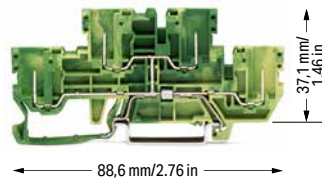

4-pin double-deck carrier block; 4-pin ground conductor block; internally commoned; Green-yellow housing

	Item No.	Pack. Unit
● PE	870-157	50

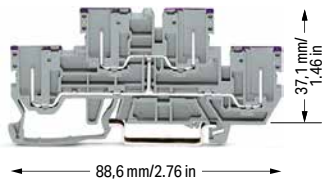

4-pin double-deck carrier terminal block; 4-pin through terminal block; internally commoned; Violet conductor entry; Gray housing

	Item No.	Pack. Unit
○ L	870-158	50

6

2-Pin/2-Pin Double-Deck Carrier Terminal Blocks and 1-Conductor Female Plugs X-COM®-SYSTEM Assembly Types



1-conductor female plug; straight
Double-deck carrier terminal blocks can be commoned via 870 Series Push-In Type Jumper Bars.
Notice: 2-conductor female plugs cannot be used.

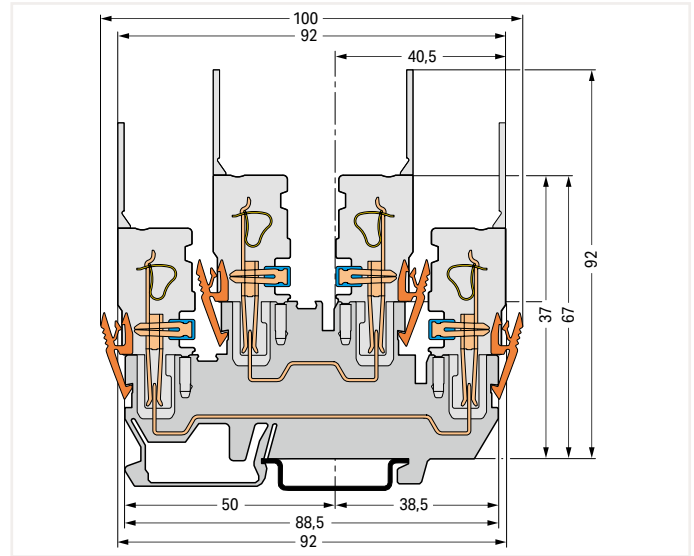

Carrier terminal block

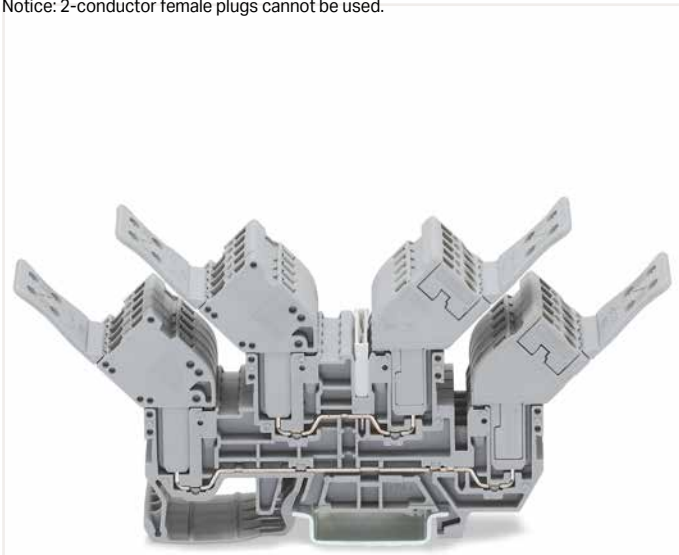

1-conductor female plug; angled
Double-deck carrier terminal blocks can be commoned via 870 Series Push-In Type Jumper Bars.

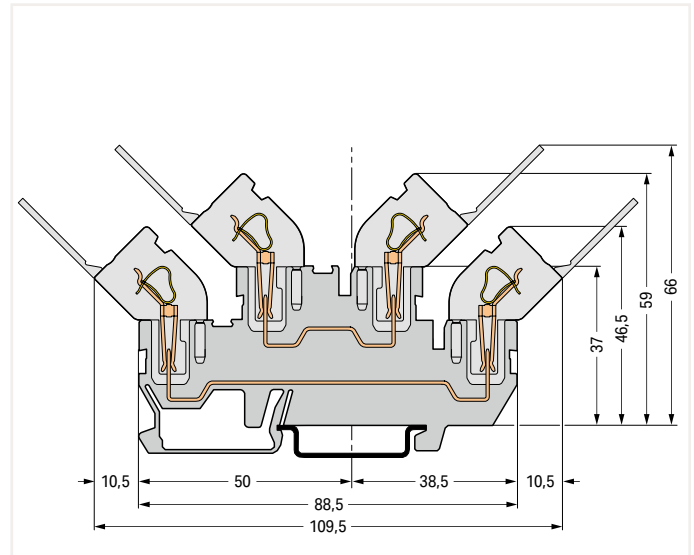

Carrier terminal block

2-Conductor/2-Pin Double-Deck Carrier Terminal Block X-COM®-SYSTEM 2.5 (4 "f-st") mm²; 870 Series

Technical Data

0.08 ... 2.5 (4 "f-st") mm² ① | 28 ... 12 AWG

500 V/6 kV/3 ②

I_N 16 A

Terminal block width: 5 mm / 0.197 inch

6 ... 7 mm / 0.24 ... 0.28 inch

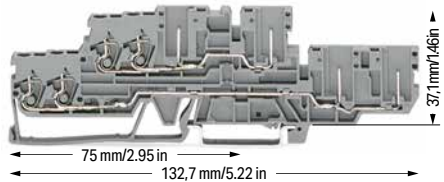

2-conductor/2-pin double-deck carrier terminal block; Through/through terminal block; Gray housing

	Item No.	Pack. Unit
○ L/L	870-131	40

Technical Data

0.08 ... 2.5 (4 "f-st") mm² ① | 28 ... 12 AWG

Terminal block width: 5 mm / 0.197 inch

6 ... 7 mm / 0.24 ... 0.28 inch

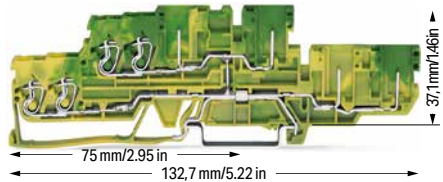

4-conductor/4-pin double-deck carrier block; 4-conductor/4-pin ground conductor block; internally commoned; Green-yellow housing

	Item No.	Pack. Unit
● PE	870-137	40

① Max. insulation diameter: 4.4 mm

② 500 V = rated voltage
6 kV = rated impulse voltage
3 = pollution degree
(see Section 14)

Note: 2- and 1-conductor angled female plugs cannot be used.

Please observe the application notes:
Insulation stop, page 346
Marking, from page 589

Approvals and corresponding ratings, visit www.wago.com

Accessories; 870 Series

Appropriate marking systems:
Mini-WSB/Mini-WSB Inline/WMB/WMB Inline

End and intermediate plate; 1 mm thick

orange	870-149	100 (25)
gray	870-148	100 (25)

Insulation stop; 0.08 ... 0.2 mm² "s" (0.14 mm² "f-st"); 5 pcs/strip

white	280-470	200 (25)
-------	---------	----------

Insulation stop; 0.25 ... 0.5 mm²; 5 pcs/strip

light gray	280-471	200 (25)
------------	---------	----------

Insulation stop; 0.75 ... 1 mm²; 5 pcs/strip

dark gray	280-472	200 (25)
-----------	---------	----------

Coding pin; for coding female plugs

orange	769-435	100 (25)
--------	---------	----------

Push-in type jumper bar; insulated; I_N 18 A; light gray

2-way	870-402	200 (25)
3-way	870-403	200 (25)
4-way	870-404	100 (25)
5-way	870-405	100 (25)
6-way	870-406	100 (25)
7-way	870-407	100 (25)
8-way	870-408	100 (25)
9-way	870-409	100 (25)
10-way	870-410	50 (25)

Push-in type jumper bar; insulated; I_N 18 A; light gray

1 to 3	870-433	200 (25)
1 to 4	870-434	200 (25)
1 to 5	870-435	100 (25)
1 to 6	870-436	100 (25)
1 to 7	870-437	100 (25)
1 to 8	870-438	100 (25)
1 to 9	870-439	100 (25)
1 to 10	870-440	50 (25)

Pin cover; with Mini-WSB marker slot

gray	769-438	100 (25)
orange	769-439	100 (25)

1-connector female plug; straight

gray	769-101	200
------	---------	-----

6

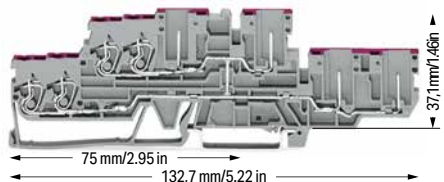

4-conductor/4-pin double-deck carrier terminal block; 4-conductor/4-pin through terminal block; internally commoned; Violet conductor entry; Gray housing

	Item No.	Pack. Unit
○ L	870-138	40

2-Conductor/2-Pin Double-Deck Carrier Terminal Blocks and 1-Conductor Female Plugs X-COM®-SYSTEM Assembly Types

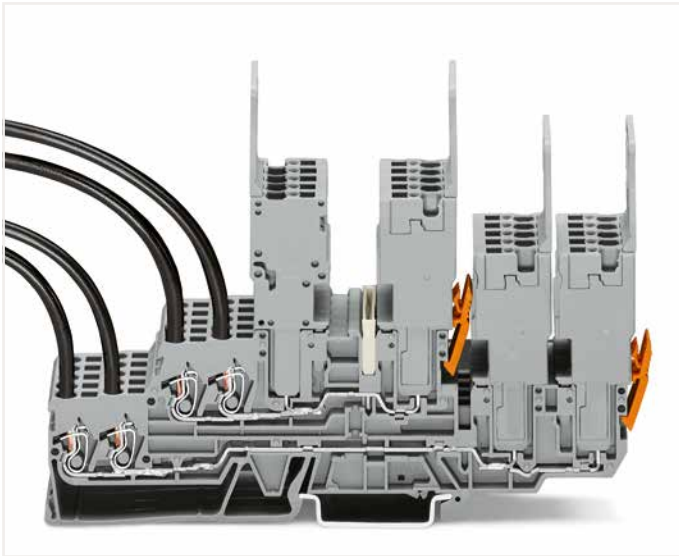

1-conductor female plug; straight

Double-deck carrier terminal blocks can be commoned via 870 Series Push-In Type Jumper Bars.

Notice: Female plugs must be arranged in the opposite direction on the upper deck. 2-conductor female plugs and angled 1-conductor female plugs cannot be used.

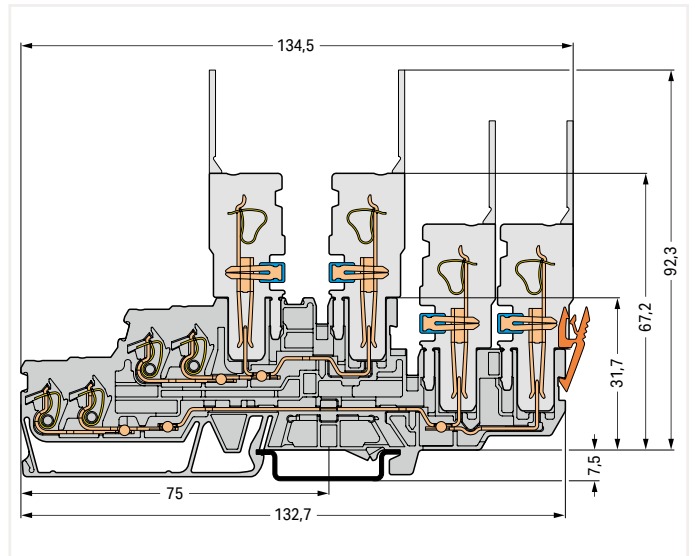

Carrier terminal block

Male Connectors, Headers and Female Plugs X-COM®-SYSTEM

769 Series

Description and Installation



Male connector; with CAGE CLAMP® connection
1-connector female plug; straight

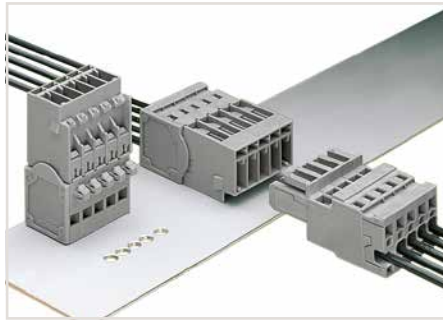

Male connector; with CAGE CLAMP® connection and
snap-in mounting feet
1-connector female plug; straight

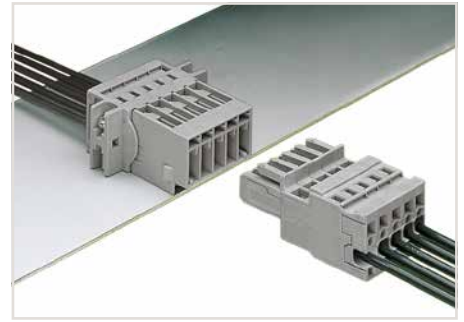

Male connector; with CAGE CLAMP® and mounting flanges
1-connector female plug; straight



Insert a male connector with snap-in flanges
(769-604/005-000) into the cutout.



Male connector; with snap-in flanges
Tool-free assembly



Male connector; with snap-in flanges
Tool-free assembly



Operating tool
Inserting a conductor – side-entry wiring (example shows
a female plug).
With ferruled conductors, it is necessary to use a terminal
block one size smaller than the conductor's nominal cross
section.



Operating tool
Inserting a conductor via operating tool (example shows a
male connector).

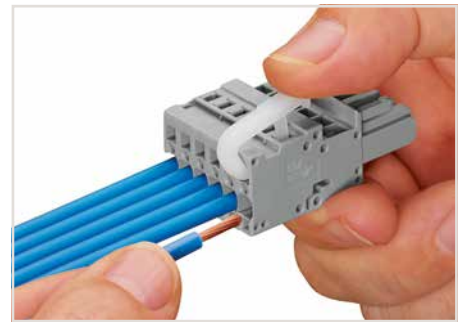

Operating lever
Conductor termination – side-entry wiring (example shows
a female plug)

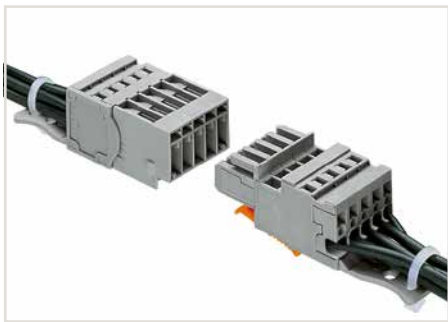

Strain relief plates can be snapped into both male connector
and female plug.

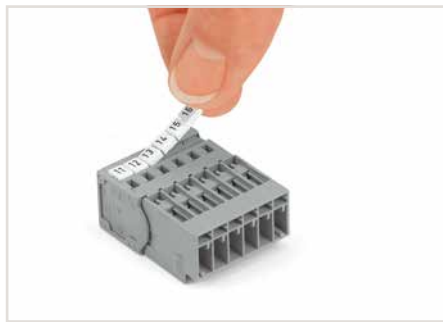

Labeling a male connector with CAGE CLAMP® connection
via Mini-USB Quick Markers.



Labeling a female plug with CAGE CLAMP® connection via
Mini-USB Quick Markers.



CAGE CLAMP® terminates the
following copper conductors:
solid



stranded



fine-stranded,
also with tinned
single strands

For aluminum conductors, see notes in Section 14. With ferruled conductors, it is necessary to use a terminal block one size smaller than the conductor's nominal cross section.





Coding a female plug by removing coding finger(s) via cutting tool. Do not remove the first and last coding fingers or use an additional locking lever.

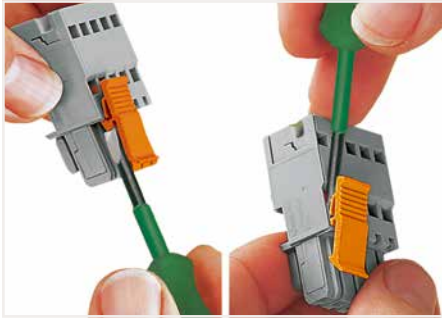

Locking/releasing a lever.



Commoning a 1-conductor female plug via miniature adjacent jumpers.

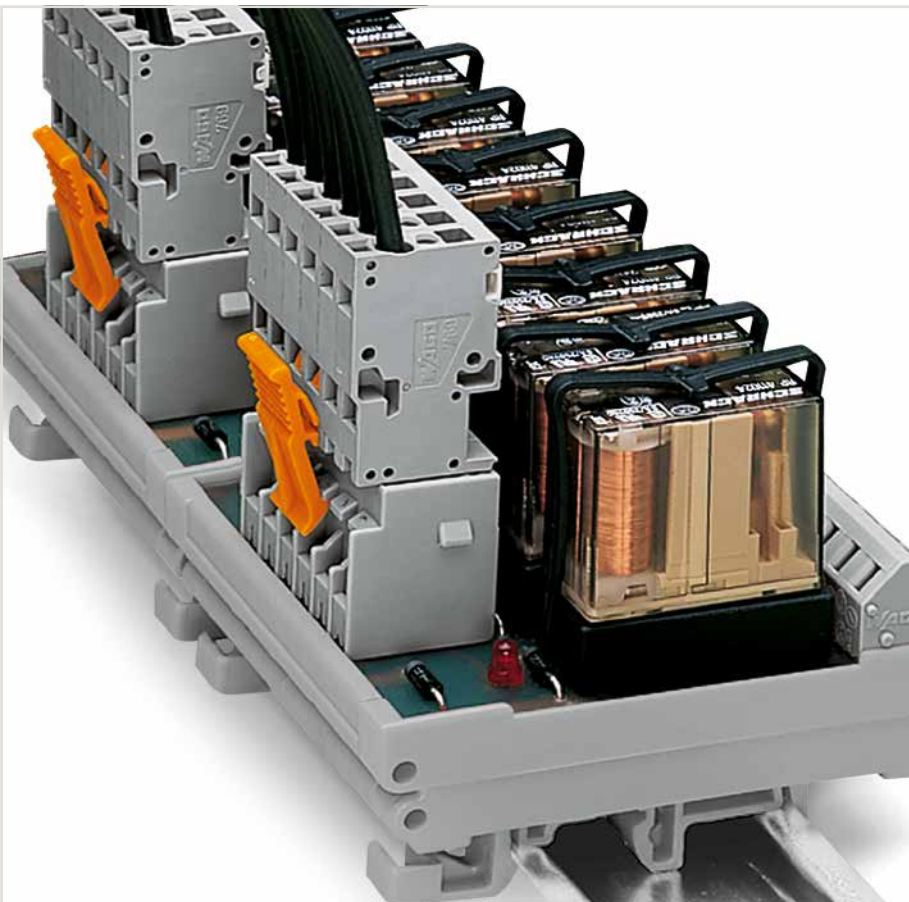

Note: Female plugs used according to the regulations must not be connected/disconnected when live or under load.

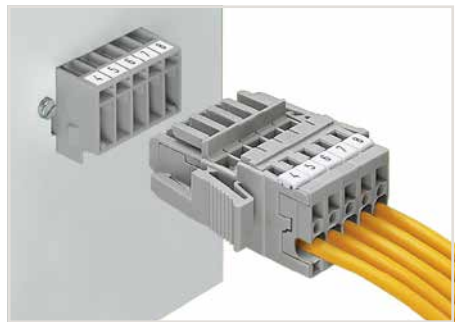

Male header and 1-conductor female plug; with lateral locking levers

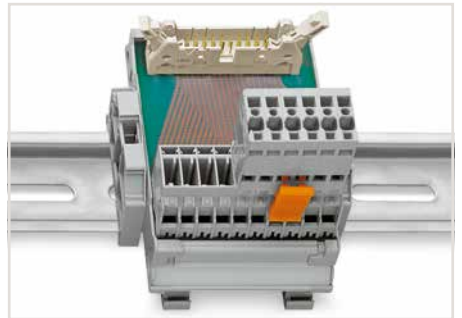

Male header; with solder pins for PCBs



Pluggable PCB connection
Connection to a relay module inside the control cabinet

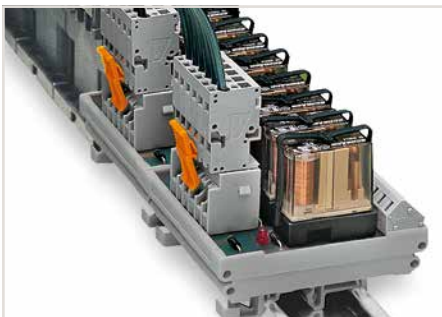

Male header; with straight solder pins and 1-conductor female plug (picture shows a relay module)

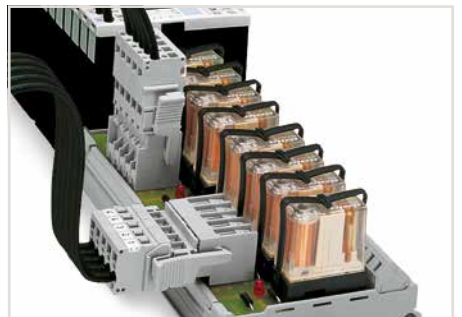

Male header; with solder pins
Integrating PCB components into the system wiring.



fine-stranded,
tip-bonded



fine-stranded,
with ferrule
(gastight crimped)



fine-stranded,
with pin terminal
(gastight crimped)

6

Male Connector X-COM®-SYSTEM; with CAGE CLAMP® Connection; 5 mm Pin Spacing 4 mm²; 769 Series

Technical Data

Pin spacing: 5 mm / 0.197 inch

0.08 ... 4 mm² | 28 ... 12 AWG

500 V/6 kV/3 ① | 300 V, 20 A ②

I_N 32 A ② | 300 V, 20 A ③

8 ... 9 mm / 0.31 ... 0.35 inch

Technical Data

Pin spacing: 5 mm / 0.197 inch

0.08 ... 4 mm² | 28 ... 12 AWG

500 V/6 kV/3 ① | 300 V, 20 A ②

I_N 32 A ② | 300 V, 20 A ③

8 ... 9 mm / 0.31 ... 0.35 inch

Technical Data

Pin spacing: 5 mm / 0.197 inch

0.08 ... 4 mm² | 28 ... 12 AWG

500 V/6 kV/3 ① | 300 V, 20 A ②

I_N 32 A ② | 300 V, 20 A ③

8 ... 9 mm / 0.31 ... 0.35 inch



Dimensions (in mm)

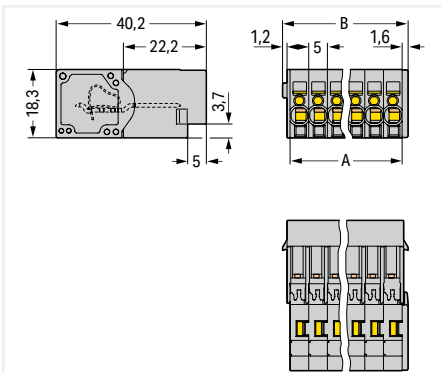

B = A + 3.6 mm
A = pole no. x pin spacing

Dimensions (in mm)

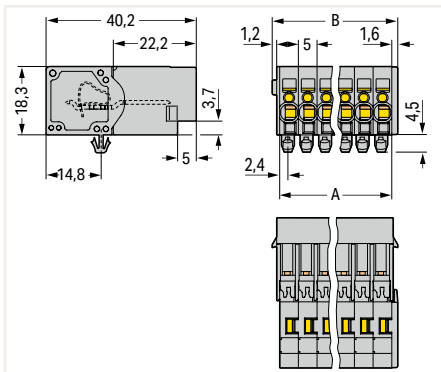

B = A + 3.6 mm
A = pole no. x pin spacing

Dimensions (in mm)

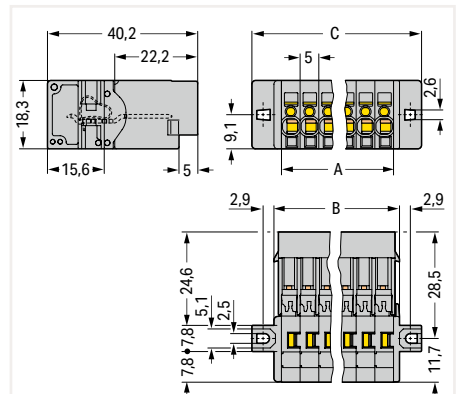

C = A + 15.4 mm
B = A + 3.6 mm
A = pole no. x pin spacing

Male connector; with CAGE CLAMP® connection; for flying leads; gray

Pole No.	Item No.	Pack. Unit
2	769-602	100
3	769-603	100
4	769-604	100
5	769-605	50
6	769-606	50
7	769-607	25
8	769-608	25
9	769-609	25
10	769-610	25
11	769-611	25
12	769-612	25
13	769-613	25
14	769-614	15
15	769-615	10

Male connector; with CAGE CLAMP® connection and snap-in mounting feet; for 0.6 ... 1.2 mm plate thickness; 3.5 mm Ø mounting holes; with mounting adapter (209-137) for DIN-35 rail; gray

Pole No.	Item No.	Pack. Unit
2	769-602/001-000	100
3	769-603/001-000	100
4	769-604/001-000	50
5	769-605/001-000	50
6	769-606/001-000	50
7	769-607/001-000	25
8	769-608/001-000	25
9	769-609/001-000	25
10	769-610/001-000	25
11	769-611/001-000	25
12	769-612/001-000	25
13	769-613/001-000	15
14	769-614/001-000	15
15	769-615/001-000	20

Male connector; with CAGE CLAMP® connection and mounting flanges; for screw or similar mounting types; for vertical or horizontal mounting; gray

Pole No.	Item No.	Pack. Unit
2	769-602/002-000	100
3	769-603/002-000	50
4	769-604/002-000	50
5	769-605/002-000	50
6	769-606/002-000	50
7	769-607/002-000	25
8	769-608/002-000	25
9	769-609/002-000	25
10	769-610/002-000	25
11	769-611/002-000	25
12	769-612/002-000	25
13	769-613/002-000	15
14	769-614/002-000	10
15	769-615/002-000	20

Accessories; item-specific

Strain relief plate; gray

	2- ... 3-pole	769-411	100 (25)
	4- ... 5-pole	769-412	100 (25)
	6- ... 9-pole	769-413	100 (25)
	10- ... 15-pole	769-414	100 (25)

Accessories; item-specific

Mounting adapter; for DIN-35 rail; can be used as end plate; 6.5 mm wide

	gray	209-137	25
--	------	---------	----

Accessories; item-specific

Mounting screw (M2.5 x 16) and hexagon nut (M2.5)

		769-499	100 (25)
--	--	---------	----------

Technical Data

Pin spacing: 5 mm / 0.197 inch

0.08 ... 4 mm² | 28 ... 12 AWG

500 V/6 kV/3 ① | 300 V, 20 A ②

I_N 32 A ② | 300 V, 20 A ②

8 ... 9 mm / 0.31 ... 0.35 inch



Dimensions (in mm)

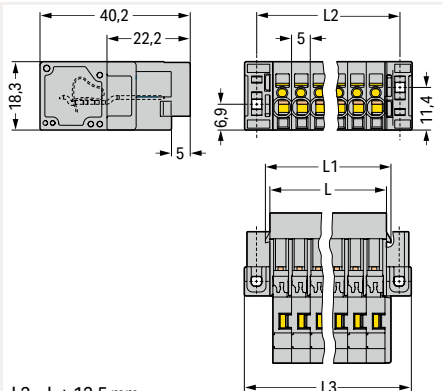

L3 = L + 13.5 mm
 L2 = L + 7 mm
 L1 = L + 2.4 mm
 L = (pole no. - 1) x pin spacing + 6.2 mm

Male connector; with CAGE CLAMP® connection and feedthrough flanges; for screw or similar mounting types; for vertical or horizontal mounting; gray

Pole No.	Item No.	Pack. Unit
2	769-602/004-000	100
3	769-603/004-000	50
4	769-604/004-000	25
5	769-605/004-000	25
6	769-606/004-000	25
7	769-607/004-000	25
8	769-608/004-000	25
9	769-609/004-000	25
10	769-610/004-000	25
11	769-611/004-000	25
12	769-612/004-000	15
13	769-613/004-000	15
14	769-614/004-000	10
15	769-615/004-000	10

- ① 500 V = rated voltage
6 kV = rated impulse voltage
3 = pollution degree
(see Section 14)

- ② Current-carrying capacity curve on page 419 and upon request

Approvals and corresponding ratings, visit www.wago.com

Accessories; for male connectors

Appropriate marking systems:
Mini-WSB/Mini-WSB Inline

1-conductor female plug; straight

	gray	769-102	100
--	------	---------	-----

1-conductor female plug; with lateral locking levers

	gray	769-102/021-000	50
--	------	-----------------	----

2-conductor female plug

	gray	769-122	50
--	------	---------	----

Coding pin; for coding female plugs

	orange	769-435	100 (25)
--	--------	---------	----------

Operating tool; for female plugs and male connectors with CAGE CLAMP® connection

		210-490	1
--	--	---------	---

Operating lever; loose; for male and female connectors with CAGE CLAMP® connection

		769-434	2000 (100)
--	--	---------	------------

Mini-WSB marking card; white; 10 strips with 10 markers/ card; 5 mm wide markers

	plain	248-501	5
--	-------	---------	---

Mini-WSB marking card; plain; 10 strips with 10 markers/ card; 5 mm wide markers

	yellow	248-501/000-002	5
	red	248-501/000-005	5
	blue	248-501/000-006	5
	gray	248-501/000-007	5
	orange	248-501/000-012	5
	light green	248-501/000-017	5
	green	248-501/000-023	5
	violet	248-501/000-024	5



Male connector; with CAGE CLAMP® connection
1-conductor female plug; straight



Labeling a male connector with CAGE CLAMP® connection via Mini-WSB Quick Markers.

Male Connector X-COM®-SYSTEM; with CAGE CLAMP® Connection and Snap-In Flanges; 5 mm Pin Spacing

4 mm²; 769 Series

Technical Data

Pin spacing: 5 mm / 0.197 inch

0.08 ... 4 mm²

28 ... 12 AWG

500 V/6 kV/3 ①

300 V, 20 A ②

I_N 32 A ②

300 V, 20 A ②

8 ... 9 mm / 0.31 ... 0.35 inch

- ① 500 V = rated voltage
6 kV = rated impulse voltage
3 = pollution degree
(see Section 14)

- ② Current-carrying capacity curves upon request

Approvals and corresponding ratings, visit www.wago.com

Accessories; for male connectors

Appropriate marking systems:
Mini-WSB/Mini-WSB Inline

1-connector female plug; straight



gray 769-102 100

1-conductor female plug; with lateral locking levers



gray 769-102/021-000 50

2-conductor female plug



gray 769-122 50

Coding pin; for coding female plugs



orange 769-435 100 (25)

Operating tool; for female plugs and male connectors with CAGE CLAMP® connection



210-490 1

Operating lever; loose; for male and female connectors with CAGE CLAMP® connection



769-434 2000 (100)

Dimensions (in mm)

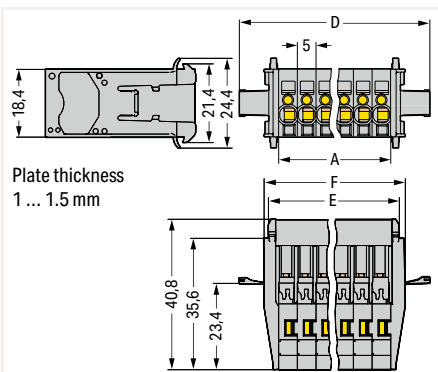

F = A + 8.1 mm
E = A + 4.9 mm
D = A + 21.3 mm
A = pole no. x pin spacing

Male connector; with CAGE CLAMP® connection and snap-in flanges; for flying leads; gray

Pole No.	Item No.	Pack. Unit
2	769-602/005-000	50
3	769-603/005-000	25
4	769-604/005-000	25
5	769-605/005-000	25
6	769-606/005-000	25
7	769-607/005-000	25
8	769-608/005-000	20
9	769-609/005-000	20
10	769-610/005-000	20
11	769-611/005-000	15
12	769-612/005-000	15
13	769-613/005-000	15
14	769-614/005-000	10
15	769-615/005-000	10

Mini-WSB marking card; white; 10 strips with 10 markers/ card; 5 mm wide markers



plain 248-501 5

Mini-WSB marking card; plain; 10 strips with 10 markers/ card; 5 mm wide markers



yellow	248-501/000-002	5
red	248-501/000-005	5
blue	248-501/000-006	5
gray	248-501/000-007	5
orange	248-501/000-012	5
light green	248-501/000-017	5
green	248-501/000-023	5
violet	248-501/000-024	5

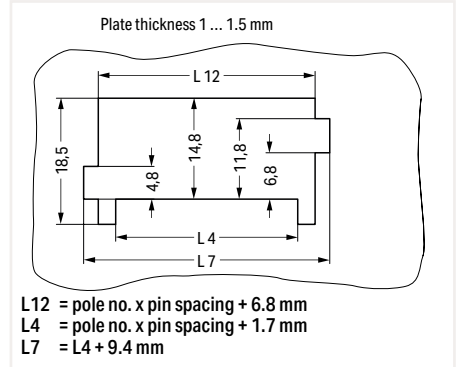

Cutout
Male connector with CAGE CLAMP® connection (769-6xx/005-000) and snap-in flanges



Insert a male connector with snap-in flanges (769-604/005-000) into the cutout.



Male connector; with snap-in flanges
Tool-free assembly



Male connector; with snap-in flanges
Tool-free assembly

Male Connector X-COM®-SYSTEM; with CAGE CLAMP® Connection and Snap-In Flanges; 5 mm Pin Spacing

4 mm²; 769 Series

Technical Data

Pin spacing: 5 mm / 0.197 inch	
0.08 ... 4 mm ²	28 ... 12 AWG
500 V/6 kV/3 ①	300 V, 20 A ②
I _N 32 A ②	300 V, 20 A ③
8 ... 9 mm / 0.31 ... 0.35 inch	

- ① 500 V = rated voltage
6 kV = rated impulse voltage
3 = pollution degree (see Section 14)
 - ② Current-carrying capacity curves upon request
- Approvals and corresponding ratings, visit www.wago.com

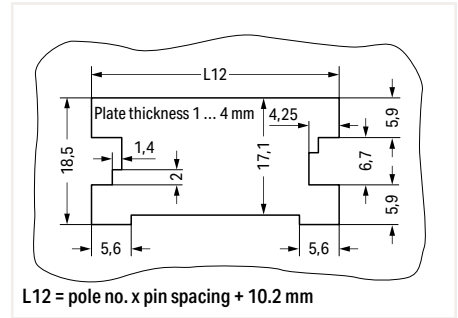

Sheet metal cutout (for female connectors without locking levers)
Male connector with CAGE CLAMP® connection (769-6xx/006-000) and snap-in flanges



Dimensions (in mm)

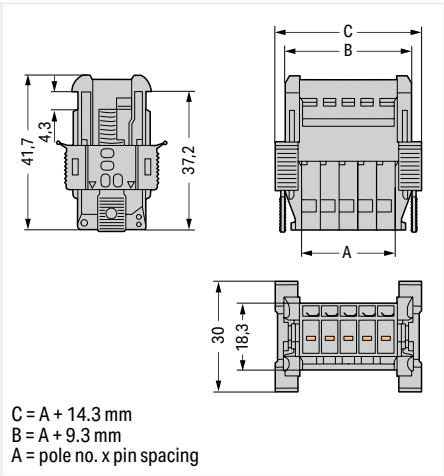

Male connector; with CAGE CLAMP® connection and snap-in flanges; for flying leads; gray

Pole No.	Item No.	Pack. Unit
2	769-602/006-000	50
3	769-603/006-000	25
4	769-604/006-000	25
5	769-605/006-000	25
6	769-606/006-000	25
7	769-607/006-000	25
8	769-608/006-000	20
9	769-609/006-000	20
10	769-610/006-000	20
11	769-611/006-000	15
12	769-612/006-000	15
13	769-613/006-000	15
14	769-614/006-000	10
15	769-615/006-000	10



Insert a male connector with snap-in flanges (769-605/006-000) into the cutout.



Secure the snap-in flange.



For removal, insert operating tool (2.5 mm blade) into release slot.

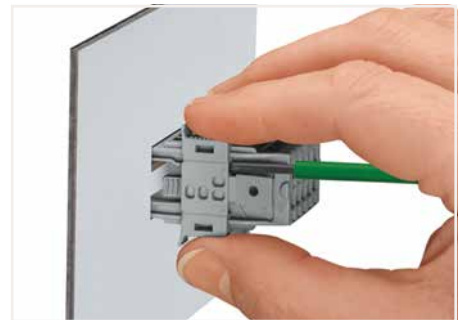

Press center part on both the top and bottom of the connector. Then remove snap-in flange.

Male Header X-COM®-SYSTEM; with Solder Pins; 5 mm Pin Spacing 769 Series

Technical Data

Pin spacing: 5 mm / 0.197 inch

250 V/4 kV/3 ①

300 V, 20 A ②

500 V/4 kV/3 ①

300 V, 20 A ②

I_N 32 A ②

Technical Data

Pin spacing: 5 mm / 0.197 inch

250 V/4 kV/3 ①

300 V, 20 A ②

500 V/4 kV/3 ①

300 V, 20 A ②

I_N 32 A ②

- ① 250 V / 500 V = rated voltage
4 kV = rated impulse voltage
3 = pollution degree
(see Section 14)

- ② Current-carrying capacity curve on page 420 and upon request

Approvals and corresponding ratings, visit www.wago.com



Dimensions (in mm)

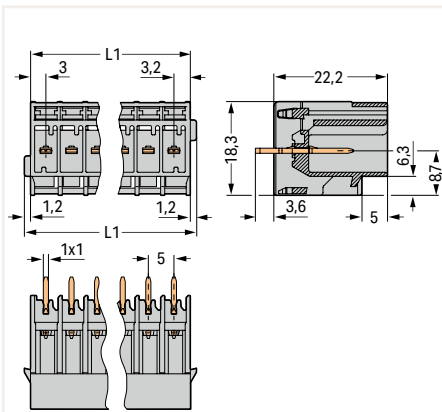

$L1 = L + 2.4 \text{ mm}$
 $L = (\text{pole no.} - 1) \times \text{pin spacing} + 6.2 \text{ mm}$

Male header; with straight solder pins; 1 x 1 mm; Vertical mating direction to the PCB; gray

Pole No.	Item No.	Pack. Unit
○ 2	769-632	200
○ 3	769-633	100
○ 4	769-634	50
○ 5	769-635	50
○ 6	769-636	50
○ 7	769-637	50
○ 8	769-638	25
○ 9	769-639	25
○ 10	769-640	25
○ 11	769-641	25
○ 12	769-642	25
○ 13	769-643	25
○ 14	769-644	25
○ 15	769-645	25

Dimensions (in mm)

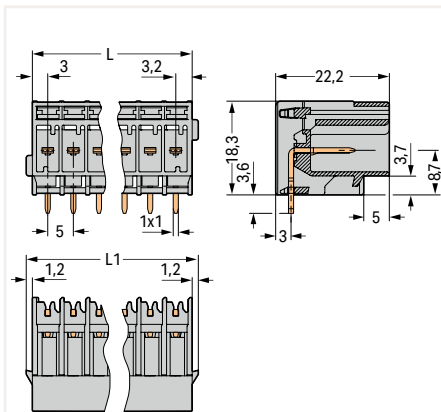

$L1 = L + 2.4 \text{ mm}$
 $L = (\text{pole no.} - 1) \times \text{pin spacing} + 6.2 \text{ mm}$

Male header; with angled solder pins; 1 x 1 mm; Horizontal mating direction to the PCB; gray

Pole No.	Item No.	Pack. Unit
○ 2	769-662	200
○ 3	769-663	100
○ 4	769-664	50
○ 5	769-665	50
○ 6	769-666	50
○ 7	769-667	50
○ 8	769-668	25
○ 9	769-669	25
○ 10	769-670	25
○ 11	769-671	25
○ 12	769-672	25
○ 13	769-673	25
○ 14	769-674	25
○ 15	769-675	25

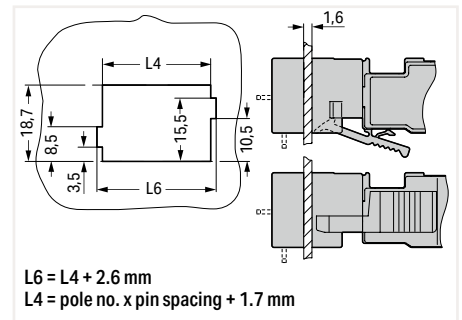

Cutout
Male header; with solder pins

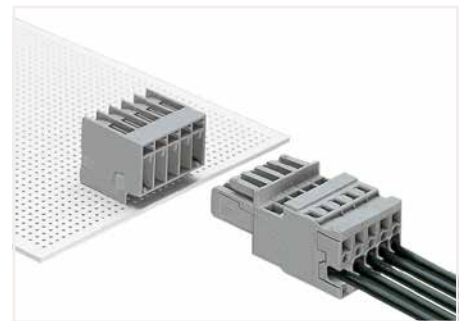

Male header; with angled solder pins

Male header; with preceding contact; with straight solder pins; 1 x 1 mm; Vertical mating direction to the PCB; gray

○ 2	769-632/000-036	200
○ 3	769-633/000-036	100
○ 4	769-634/000-036	50
○ 5	769-635/000-036	50

Accessories; for male connectors

1-conductor female plug; straight

	gray	769-102	100
--	------	---------	-----

1-conductor female plug; with lateral locking levers

	gray	769-102/021-000	50
--	------	-----------------	----

Male Header X-COM®-SYSTEM; with Solder Pins and Mounting Flanges; 5 mm Pin Spacing 769 Series

Technical Data

Pin spacing: 5 mm / 0.197 inch

250 V/4 kV/3 ① 300 V, 20 A ②

500 V/4 kV/3 ① 300 V, 20 A ②

I_N 32 A ②

Technical Data

Pin spacing: 5 mm / 0.197 inch

250 V/4 kV/3 ① 300 V, 20 A ②

500 V/4 kV/3 ① 300 V, 20 A ②

I_N 32 A ②

- ① 250 V / 500 V = rated voltage
4 kV = rated impulse voltage
3 = pollution degree
(see Section 14)

- ② Current-carrying capacity curve on page 420 and upon request

Approvals and corresponding ratings, visit www.wago.com

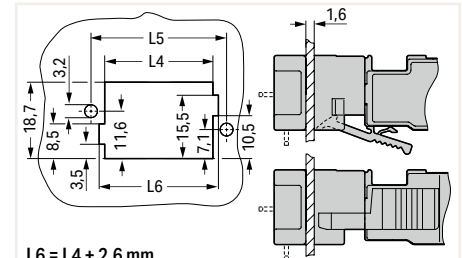

$L6 = L4 + 2.6 \text{ mm}$
 $L5 = L5 + 6.6 \text{ mm}$
 $L4 = \text{pole no.} \times \text{pin spacing} + 1.7 \text{ mm}$

Cutout
Male header; with solder pins and mounting flanges

Dimensions (in mm)

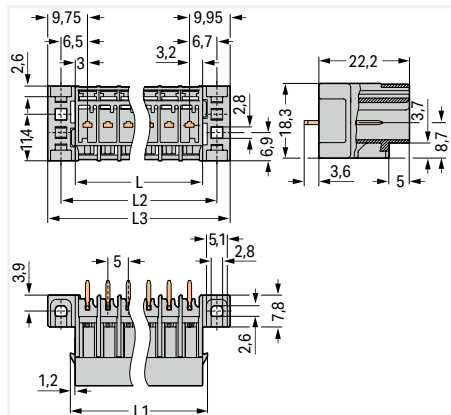

$L1 = L + 2.4 \text{ mm}$, $L2 = L + 7 \text{ mm}$, $L3 = L + 13.5 \text{ mm}$
 $L = (\text{pole no.} - 1) \times \text{pin spacing} + 6.2 \text{ mm}$

Male header; with straight solder pins and mounting flanges; 1 x 1 mm; Vertical mating direction to the PCB; gray

Pole No.	Item No.	Pack. Unit
○ 2	769-632/003-000	200
○ 3	769-633/003-000	100
○ 4	769-634/003-000	50
○ 5	769-635/003-000	50
○ 6	769-636/003-000	25
○ 7	769-637/003-000	25
○ 8	769-638/003-000	25
○ 9	769-639/003-000	25
○ 10	769-640/003-000	25
○ 11	769-641/003-000	25
○ 12	769-642/003-000	25
○ 13	769-643/003-000	15
○ 14	769-644/003-000	15
○ 15	769-645/003-000	15

Dimensions (in mm)

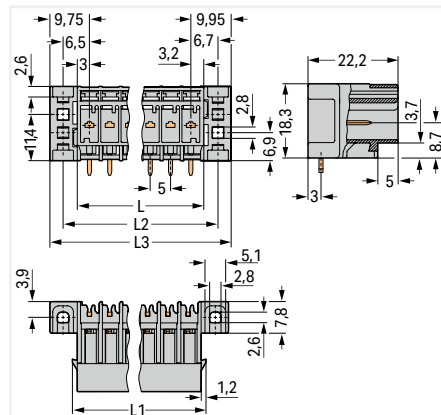

$L1 = L + 2.4 \text{ mm}$, $L2 = L + 7 \text{ mm}$, $L3 = L + 13.5 \text{ mm}$
 $L = (\text{pole no.} - 1) \times \text{pin spacing} + 6.2 \text{ mm}$

Male header; with angled solder pins and mounting flanges; 1 x 1 mm; Horizontal mating direction to the PCB; gray

Pole No.	Item No.	Pack. Unit
○ 2	769-662/003-000	100
○ 3	769-663/003-000	100
○ 4	769-664/003-000	50
○ 5	769-665/003-000	50
○ 6	769-666/003-000	50
○ 7	769-667/003-000	25
○ 8	769-668/003-000	25
○ 9	769-669/003-000	25
○ 10	769-670/003-000	25
○ 11	769-671/003-000	25
○ 12	769-672/003-000	25
○ 13	769-673/003-000	15
○ 14	769-674/003-000	15
○ 15	769-675/003-000	15

Male header; with preceding contact; with straight solder pins and mounting flanges; 1 x 1 mm; Vertical mating direction to the PCB; gray

○ 2	769-632/003-036	200
○ 3	769-633/003-036	100
○ 4	769-634/003-036	50
○ 5	769-635/003-036	50
○ 6	769-636/003-036	25

Accessories; for male connectors

1-conductor female plug; straight

	gray	769-102	100
--	------	---------	-----

1-conductor female plug; with lateral locking levers

	gray	769-102/021-000	50
--	------	-----------------	----

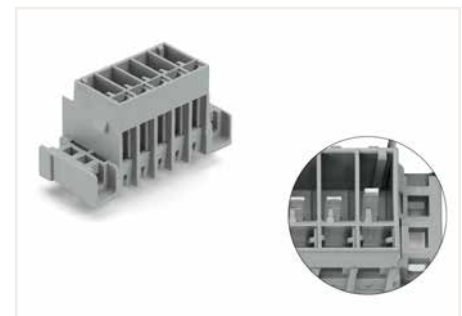

Male header; with preceding contact; with straight solder pins and mounting flanges

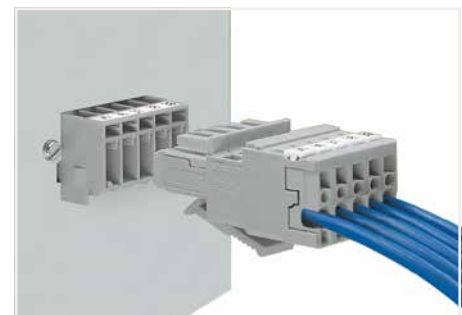

Male header with mounting flanges
1-conductor female plug with bottom-mount locking levers

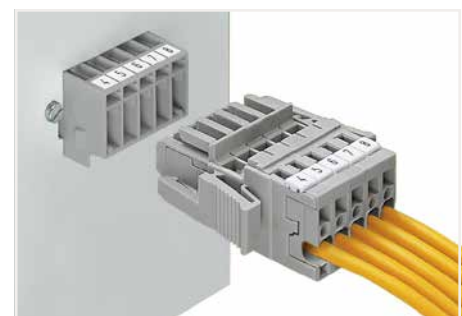

Male header and 1-conductor female plug with lateral locking levers

Male Header X-COM®-SYSTEM; with Solder Pins and Feedthrough Flanges; 5 mm Pin Spacing 769 Series

Technical Data

Pin spacing: 5 mm / 0.197 inch

250 V/4 kV/3 ①

300 V, 20 A ②

500 V/4 kV/3 ①

300 V, 20 A ②

I_N 32 A ②

Technical Data

Pin spacing: 5 mm / 0.197 inch

250 V/4 kV/3 ①

300 V, 20 A ②

500 V/4 kV/3 ①

300 V, 20 A ②

I_N 32 A ②

- ① 250 V / 500 V = rated voltage
4 kV = rated impulse voltage
3 = pollution degree
(see Section 14)

- ② Current-carrying capacity curve on page 420 and upon request

Approvals and corresponding ratings, visit www.wago.com



Dimensions (in mm)

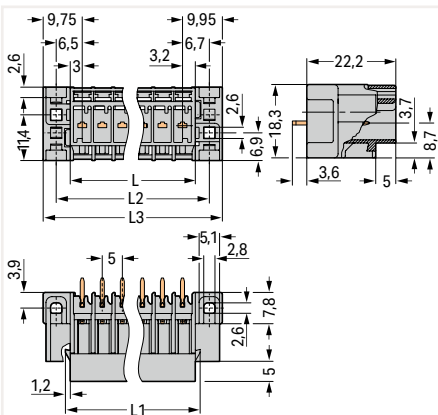

$L1 = L + 2.4 \text{ mm}$, $L2 = L + 7 \text{ mm}$, $L3 = L + 13.5 \text{ mm}$
 $L = (\text{pole no.} - 1) \times \text{pin spacing} + 6.2 \text{ mm}$

Male header; with straight solder pins and feedthrough flanges; 1 x 1 mm; Vertical mating direction to the PCB; gray

Pole No.	Item No.	Pack. Unit
○ 2	769-632/004-000	200
○ 3	769-633/004-000	50
○ 4	769-634/004-000	50
○ 5	769-635/004-000	50
○ 6	769-636/004-000	50
○ 7	769-637/004-000	25
○ 8	769-638/004-000	25
○ 9	769-639/004-000	25
○ 10	769-640/004-000	25
○ 11	769-641/004-000	25
○ 12	769-642/004-000	25
○ 13	769-643/004-000	15
○ 14	769-644/004-000	15
○ 15	769-645/004-000	15

Dimensions (in mm)

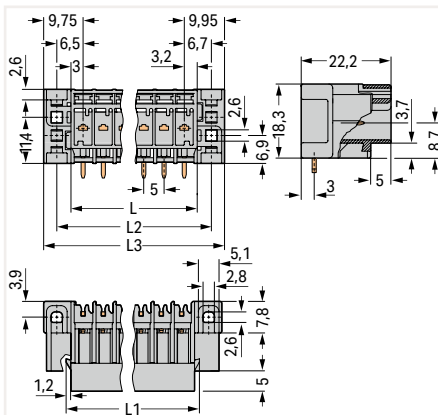

$L1 = L + 2.4 \text{ mm}$, $L2 = L + 7 \text{ mm}$, $L3 = L + 13.5 \text{ mm}$
 $L = (\text{pole no.} - 1) \times \text{pin spacing} + 6.2 \text{ mm}$

Male header; with angled solder pins and feedthrough flanges; 1 x 1 mm; Horizontal mating direction to the PCB; gray

Pole No.	Item No.	Pack. Unit
○ 2	769-662/004-000	200
○ 3	769-663/004-000	100
○ 4	769-664/004-000	50
○ 5	769-665/004-000	50
○ 6	769-666/004-000	50
○ 7	769-667/004-000	50
○ 8	769-668/004-000	25
○ 9	769-669/004-000	25
○ 10	769-670/004-000	25
○ 11	769-671/004-000	25
○ 12	769-672/004-000	25
○ 13	769-673/004-000	25
○ 14	769-674/004-000	15
○ 15	769-675/004-000	15

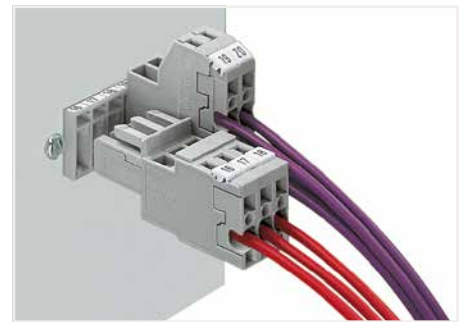

Male header; with feedthrough flanges
1-conductor female plug
2-conductor female plug

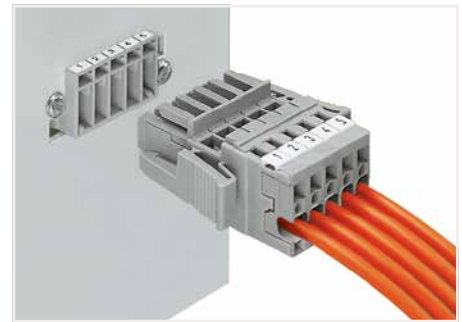

Male header and 1-conductor female plug with lateral locking levers

Accessories; for male connectors

1-conductor female plug; straight

	gray	769-102	100
--	------	---------	-----

1-conductor female plug; with lateral locking levers

	gray	769-102/021-000	50
--	------	-----------------	----

Coding pin; for coding female plugs

	orange	769-435	100 (25)
--	--------	---------	----------

Male Headers X-COM®-SYSTEM; with Solder Pins; with 1-/2-Conductor Female Plugs Assembly Types

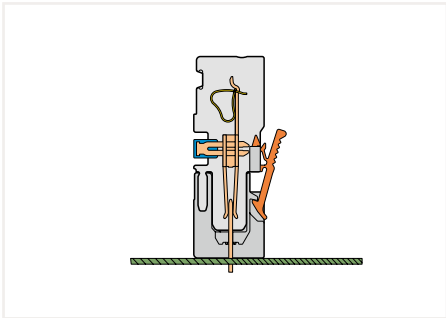

Male header; with straight solder pins

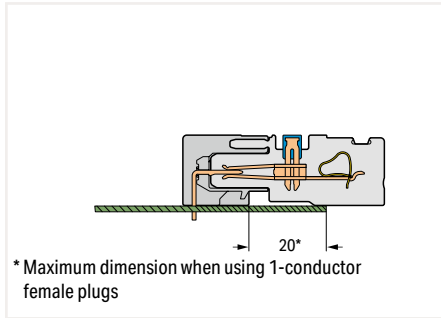

* Maximum dimension when using 1-conductor female plugs

Male header; with angled solder pins

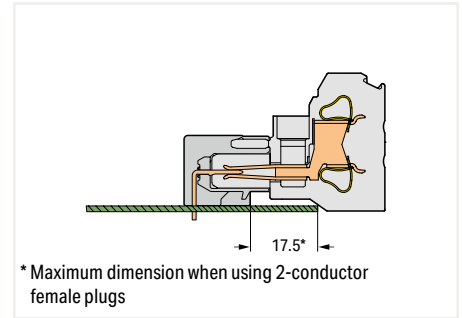

* Maximum dimension when using 2-conductor female plugs

Male header; with angled solder pins

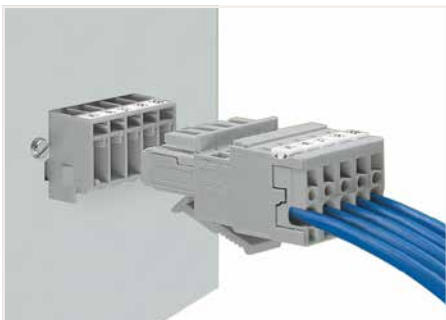

Male header; with mounting flanges
1-conductor female plug; with bottom-mount locking levers

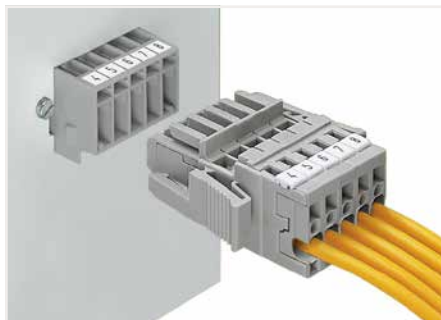

Male header; with mounting flanges
1-conductor female plug; with lateral locking levers

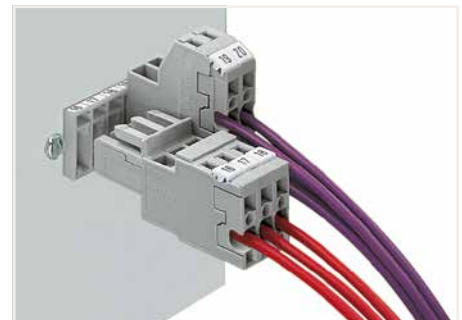

Male header; with feedthrough flanges
1-conductor female plug
2-conductor female plug

6

Cutouts for headers with fixing flanges for feedthrough applications and locking levers

Female plugs with bottom-mounted locking levers

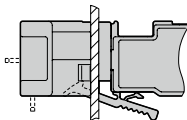

Cutouts for 2-pole locking levers (2- to 15-pole female plugs)

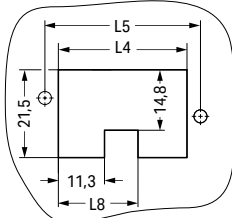

Layout for locking levers outer ...

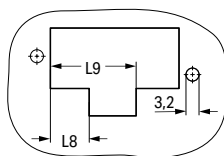

... inner

Cutouts for single pole locking levers

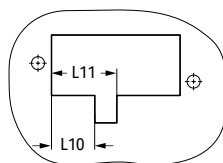
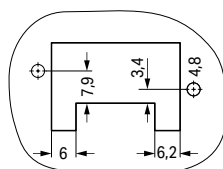

Female plug without locking levers

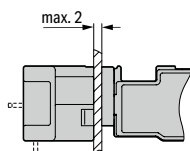
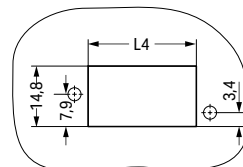

Female plug with lateral locking levers

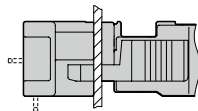
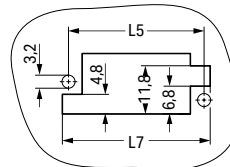

- L4 = pole no. x pin spacing + 1.7 mm
- L5 = L4 + 6.6 mm
- L7 = L4 + 9.4 mm
- L8 = pole no. LL x pin spacing - 0.3 mm
- L9 = L8 + 11.6 mm
- L10 = pole no. LL x pin spacing + 0.6 mm
- L11 = L10 + 5.4 mm
- Pole no. LL: Number of poles ahead of the poles attached to the locking lever
- LL = locking lever

Male Header X-COM®-SYSTEM; with Solder Pins and Rivet Mounting Flanges; 5 mm Pin Spacing 769 Series

Technical Data

Pin spacing: 5 mm / 0.197 inch

250 V/4 kV/3 ①

500 V/4 kV/3 ①

I_N 32 A ②

- ① 250 V / 500 V = rated voltage
4 kV = rated impulse voltage
3 = pollution degree
(see Section 14)
- ② Current-carrying capacity curves upon request

Approvals and corresponding ratings,
visit www.wago.com



Mounting with 3 mm Ø blind rivets

Dimensions (in mm)

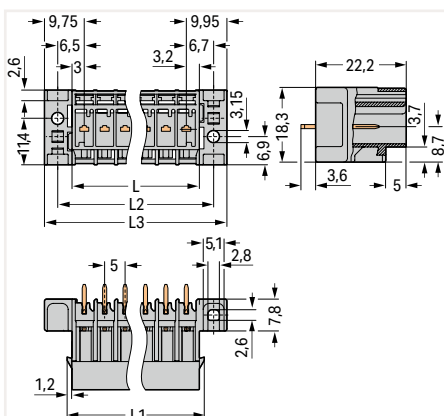

$L1 = L + 2.4$ mm, $L2 = L + 7$ mm, $L3 = L + 13.5$ mm
 $L = (\text{pole no.} - 1) \times \text{pin spacing} + 6.2$ mm

Male header; with straight solder pins and rivet mounting flanges; 1 x 1 mm; Vertical mating direction to the PCB; gray

Pole No.	Item No.	Pack. Unit
2	769-632/007-000	200
3	769-633/007-000	50
4	769-634/007-000	50
5	769-635/007-000	50
6	769-636/007-000	50
7	769-637/007-000	25
8	769-638/007-000	25
9	769-639/007-000	25
10	769-640/007-000	25
11	769-641/007-000	25
12	769-642/007-000	25
13	769-643/007-000	15
14	769-644/007-000	15
15	769-645/007-000	15

Accessories; for male connectors

1-conductor female plug; straight



gray 769-102 100

1-conductor female plug; with lateral locking levers



gray 769-102/021-000 50

Coding pin; for coding female plugs



orange 769-435 100 (25)

6

1-Conductor Female Plug X-COM®-SYSTEM

4 mm²; 769 Series

Technical Data	
0.08 ... 2.5 mm ²	28 ... 12 AWG*
500 V/6 kV/3 ①	300 V, 20 A ②
I _N 32 A ②	300 V, 20 A ②
Module width: 5 mm / 0.197 inch	
8 ... 9 mm / 0.31 ... 0.35 inch	



Dimensions (in mm)

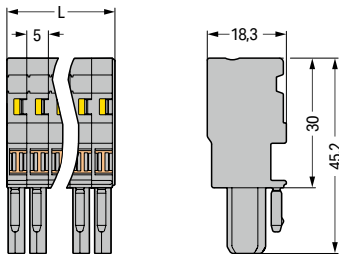

L = pole no. x module width

1-conductor female plug; straight; fits into carrier terminal blocks or male connectors; with coding fingers; can be commoned with miniature adjacent jumpers; gray

Pole No.	Item No.	Pack. Unit
1	769-101	200
2	769-102	100
3	769-103	50
4	769-104	50
5	769-105	50
6	769-106	25
7	769-107	25
8	769-108	25
9	769-109	25
10	769-110	25
11	769-111	20
12	769-112	20
13	769-113	10
14	769-114	10
15	769-115	10

1-conductor female plug; straight; fits into carrier terminal blocks or male connectors; with coding fingers; can be commoned with miniature adjacent jumpers

1 blue	769-101/000-006	200
1 orange	769-101/000-012	200
1 green-yellow	769-101/000-016	200

- 500 V = rated voltage
6 kV = rated impulse voltage
3 = pollution degree
(see Section 14)

- Current-carrying capacity curve from page 417 and upon request

Item no. suffixes
blue .../000-006
green-yellow .../000-016

Snap-on type strain relief housing, see page 416

Note:
According to EN 61984, pluggable connectors without a current interrupting capacity must not be mated or unmated when live or under load.

Approvals and corresponding ratings, visit www.wago.com

Accessories; for female plugs

Appropriate marking systems:
Mini-WSB/Mini-WSB Inline

Insulation stop; 0.08 ... 0.2 mm² "s" (0.14 mm² "f-st"); 5 pcs/strip

white	769-470	200 (25)
-------	---------	----------

Insulation stop; 0.25 ... 0.5 mm²; 5 pcs/strip

light gray	769-471	200 (25)
------------	---------	----------

Insulation stop; 0.75 ... 1 mm²; 5 pcs/strip

dark gray	769-472	200 (25)
-----------	---------	----------

Protective warning marker; with black high-voltage symbol; for 5 terminal blocks

yellow	280-415	100 (25)
--------	---------	----------

Adjacent jumper; insulated; I_N 24 A

gray	769-402	100 (25)
------	---------	----------

Jumper cover; for 1-conductor female plugs; for 5 poles

gray	769-436	100 (25)
------	---------	----------

Operating lever; loose; for male and female connectors with CAGE CLAMP® connection

	769-434	2000 (100)
--	---------	------------

Locking Lever; for 1-pole female plugs

gray	769-428	100 (25)
orange	769-429	100 (25)

Locking lever; for female plugs with 2 poles and more

gray	769-431	100 (25)
orange	769-430	100 (25)

Strain relief plate; gray

1-pole	769-410	100 (25)
2- ... 3-pole	769-411	100 (25)
4- ... 5-pole	769-412	100 (25)

Strain relief plate; gray

6- ... 9-pole	769-413	100 (25)
10- ... 15-pole	769-414	100 (25)

Accessories; for female plugs

Appropriate marking systems:
Mini-WSB/Mini-WSB Inline

Snap-on type strain relief housing; consists of strain relief support and housing

5-pole	769-1605	25
--------	----------	----

Mini-WSB marking card; white; 10 strips with 10 markers/card; 5 mm wide markers

plain	248-501	5
-------	---------	---

Mini-WSB marking card; plain; 10 strips with 10 markers/card; 5 mm wide markers

yellow	248-501/000-002	5
red	248-501/000-005	5
blue	248-501/000-006	5
gray	248-501/000-007	5
orange	248-501/000-012	5
light green	248-501/000-017	5
green	248-501/000-023	5
violet	248-501/000-024	5



1-pole female plug

Application examples:

- Phase selection in three-phase network
- Test plug with rated current capability
- Simplified circuit expansion – addition of base circuits requires only female plugs to be plugged in



Jumper cover for 1-conductor female plugs

1-Conductor Female Plug X-COM®-SYSTEM; with Lateral Locking Levers

4 mm²; 769 Series

Technical Data

0.08 ... 2.5 mm ²	28 ... 12 AWG*
500 V/6 kV/3 ①	300 V, 20 A ②
I _N 32 A ②	300 V, 20 A ②
Module width: 5 mm / 0.197 inch	
8 ... 9 mm / 0.31 ... 0.35 inch	



Dimensions (in mm)

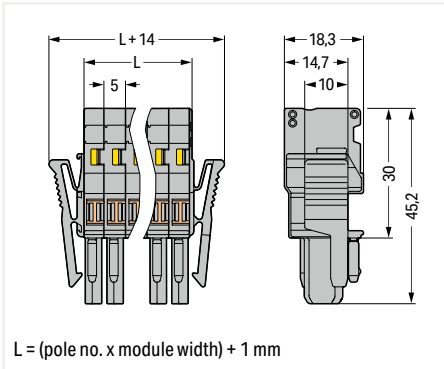

1-conductor female plug; with lateral locking levers; only compatible with male connectors; codable; can be commoned with miniature adjacent jumpers; gray

Pole No.	Item No.	Pack. Unit
○ 2	769-102/021-000	200
○ 3	769-103/021-000	50
○ 4	769-104/021-000	50
○ 5	769-105/021-000	50
○ 6	769-106/021-000	50
○ 7	769-107/021-000	25
○ 8	769-108/021-000	25
○ 9	769-109/021-000	25
○ 10	769-110/021-000	25
○ 11	769-111/021-000	25
○ 12	769-112/021-000	25
○ 13	769-113/021-000	15
○ 14	769-114/021-000	15
○ 15	769-115/021-000	15

- 500 V = rated voltage
6 kV = rated impulse voltage
3 = pollution degree
(see Section 14)

- Current-carrying capacity curve from page 417 and upon request

Item no. suffixes
blue .../000-006
green-yellow .../000-016

Snap-on type strain relief housing, see page 416

Note:
According to EN 61984, pluggable connectors without a current interrupting capacity must not be mated or unmated when live or under load.

Approvals and corresponding ratings, visit www.wago.com

Accessories; for female plugs

Appropriate marking systems:
Mini-WSB/Mini-WSB Inline

Insulation stop; 0.08 ... 0.2 mm² "s" (0.14 mm² "f-st"); 5 pcs/strip

	white	769-470	200 (25)
--	-------	---------	----------

Insulation stop; 0.25 ... 0.5 mm²; 5 pcs/strip

	light gray	769-471	200 (25)
--	------------	---------	----------

Insulation stop; 0.75 ... 1 mm²; 5 pcs/strip

	dark gray	769-472	200 (25)
--	-----------	---------	----------

Protective warning marker; with black high-voltage symbol; for 5 terminal blocks

	yellow	280-415	100 (25)
--	--------	---------	----------

Adjacent jumper; insulated; I_N 24 A

	gray	769-402	100 (25)
--	------	---------	----------

Jumper cover; for 1-conductor female plugs; for 5 poles

	gray	769-436	100 (25)
--	------	---------	----------

Operating lever; loose; for male and female connectors with CAGE CLAMP® connection

		769-434	2000 (100)
--	--	---------	------------

Strain relief plate; gray

	2- ... 3-pole	769-411	100 (25)
--	---------------	---------	----------

	4- ... 5-pole	769-412	100 (25)
--	---------------	---------	----------

Strain relief plate; gray

	6- ... 9-pole	769-413	100 (25)
--	---------------	---------	----------

	10- ... 15-pole	769-414	100 (25)
--	-----------------	---------	----------

Snap-on type strain relief housing; consists of strain relief support and housing

	5-pole	769-1605	25
--	--------	----------	----

Accessories; for female plugs

Appropriate marking systems:
Mini-WSB/Mini-WSB Inline

Mini-WSB marking card; white; 10 strips with 10 markers/card; 5 mm wide markers

	plain	248-501	5
--	-------	---------	---

Mini-WSB marking card; plain; 10 strips with 10 markers/card; 5 mm wide markers

	yellow	248-501/000-002	5
	red	248-501/000-005	5
	blue	248-501/000-006	5
	gray	248-501/000-007	5
	orange	248-501/000-012	5
	light green	248-501/000-017	5
	green	248-501/000-023	5
	violet	248-501/000-024	5

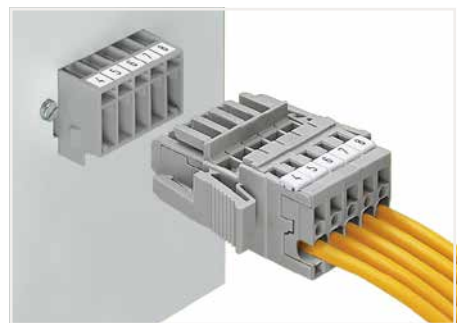

Male header; with mounting flanges
1-conductor female plug with lateral locking levers

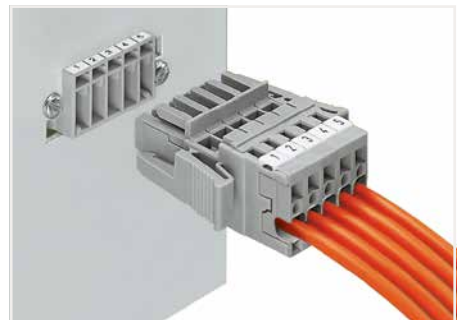

Male header and 1-conductor female plug with lateral locking levers

2-Conductor Female Plug X-COM®-SYSTEM 4 mm²; 769 Series

Technical Data

0.08 ... 2.5 mm ²	28 ... 12 AWG*
500 V/6 kV/3 ①	300 V, 20 A ②
I _N 32 A ②	300 V, 20 A ③
Module width: 5 mm / 0.197 inch	
8 ... 9 mm / 0.31 ... 0.35 inch	

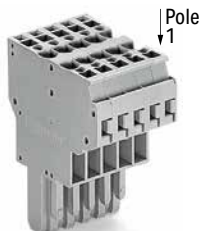

Dimensions (in mm)

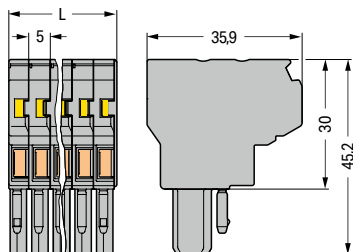

L = pole no. x module width

2-conductor female plug; fits into carrier terminal blocks or male connectors; codable; can be commoned with adjacent and staggered jumpers; gray

Pole No.	Item No.	Pack. Unit
○ 1	769-121	100
○ 2	769-122	50
○ 3	769-123	25
○ 4	769-124	25
○ 5	769-125	20
○ 6	769-126	10
○ 7	769-127	10
○ 8	769-128	10
○ 9	769-129	10
○ 10	769-130	10
○ 11	769-131	5
○ 12	769-132	5
○ 13	769-133	5
○ 14	769-134	5
○ 15	769-135	5

- ① 500 V = rated voltage
6 kV = rated impulse voltage
3 = pollution degree (see Section 14)

- ② Current-carrying capacity curves upon request

Item no. suffixes	
blue	.../000-006
green-yellow	.../000-016

Please observe the application notes:
Jumpers, from page 348

Note:
According to EN 61984, pluggable connectors without a current interrupting capacity must not be mated or unmated when live or under load.

Approvals and corresponding ratings, visit www.wago.com

Accessories; for female plugs

Appropriate marking systems:
Mini-WSB/Mini-WSB Inline

Insulation stop; 0.08 ... 0.2 mm² "s" (0.14 mm² "f-st"); 5 pcs/strip

white	769-470	200 (25)
-------	---------	----------

Insulation stop; 0.25 ... 0.5 mm²; 5 pcs/strip

light gray	769-471	200 (25)
------------	---------	----------

Insulation stop; 0.75 ... 1 mm²; 5 pcs/strip

dark gray	769-472	200 (25)
-----------	---------	----------

Protective warning marker; with black high-voltage symbol; for 5 terminal blocks

yellow	280-415	100 (25)
--------	---------	----------

Adjacent jumper; insulated; I_N = I_N terminal block

gray	280-402	200 (25)
------	---------	----------

Staggered jumper; insulated; 5 mm wide; I_N 24 A

1 to 2	780-452	100 (25)
1 to 3	780-453	100 (25)
1 to 4	780-454	100 (25)
1 to 5	780-455	50 (25)
1 to 6	780-456	50 (25)
1 to 7	780-457	50 (25)
1 to 8	780-458	50 (25)

Locking Lever; for 1-pole female plugs

gray	769-428	100 (25)
orange	769-429	100 (25)

Locking lever; for female plugs with 2 poles and more

gray	769-431	100 (25)
orange	769-430	100 (25)

Strain relief plate; gray

1-pole	769-410	100 (25)
2- ... 3-pole	769-411	100 (25)
4- ... 5-pole	769-412	100 (25)

Strain relief plate; gray

6- ... 9-pole	769-413	100 (25)
10- ... 15-pole	769-414	100 (25)

Accessories; for female plugs

Appropriate marking systems:
Mini-WSB/Mini-WSB Inline

Mini-WSB marking card; white; 10 strips with 10 markers/ card; 5 mm wide markers

plain	248-501	5
-------	---------	---

Mini-WSB marking card; plain; 10 strips with 10 markers/ card; 5 mm wide markers

yellow	248-501/000-002	5
red	248-501/000-005	5
blue	248-501/000-006	5
gray	248-501/000-007	5
orange	248-501/000-012	5
light green	248-501/000-017	5
green	248-501/000-023	5
violet	248-501/000-024	5

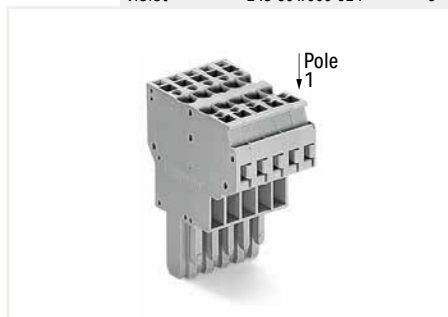

2-conductor female plugs:

- Common signals from one subassembly to the other (bus structure)
- Can be used as a T-wire branch tap connection (e.g. for lighting wiring)
- Enable a higher number of connection possibilities



Commoning options of female plugs:

- After removal, commoned potentials still remain commoned
- Use of plug-in jumpers instead of additional wired jumpers
- Can be used as a "hardware" key for safety lockout
- Can also be used as a commoning jumper for sensor circuits or machine programming

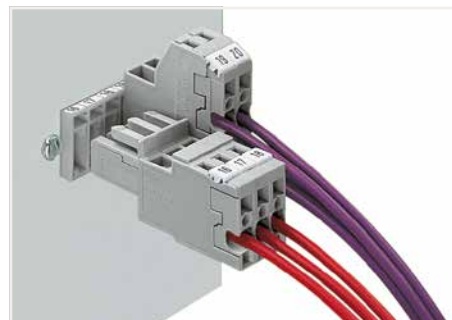

Male header with feedthrough flanges,
1-conductor female plug,
2-conductor female plug

1-Conductor Female Plug X-COM®-SYSTEM; Angled 4 mm²; 769 Series

Technical Data	
0.08 ... 2.5 mm ²	28 ... 12 AWG*
500 V/6 kV/3 ①	300 V, 20 A ②
I _N 32 A ②	300 V, 20 A ②
Module width: 5 mm / 0.197 inch	
8 ... 9 mm / 0.31 ... 0.35 inch	



Dimensions (in mm)

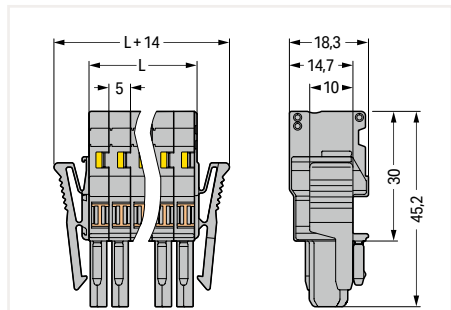

$L = (\text{pole no.} \times \text{module width}) + 1 \text{ mm}$

1-conductor female plug; angled; fits into carrier terminal blocks; codable; gray

Pole No.	Item No.	Pack. Unit
1	769-101/022-000	200
2	769-102/022-000	100
3	769-103/022-000	50
4	769-104/022-000	50
5	769-105/022-000	50
6	769-106/022-000	25
7	769-107/022-000	25
8	769-108/022-000	25
9	769-109/022-000	25
10	769-110/022-000	25
11	769-111/022-000	20
12	769-112/022-000	20
13	769-113/022-000	10
14	769-114/022-000	10
15	769-115/022-000	10

- ① 500 V = rated voltage
6 kV = rated impulse voltage
3 = pollution degree (see Section 14)
- ② Current-carrying capacity curves upon request

Item no. suffixes	
blue	.../000-006
green-yellow	.../000-016

Note:
According to EN 61984, pluggable connectors without a current interrupting capacity must not be mated or unmated when live or under load.

Approvals and corresponding ratings, visit www.wago.com

Accessories; for female plugs
Appropriate marking systems:
Mini-WSB/Mini-WSB Inline

Insulation stop; 0.08 ... 0.2 mm² "s" (0.14 mm² "f-st"); 5 pcs/strip

white	769-470	200 (25)
-------	---------	----------

Insulation stop; 0.25 ... 0.5 mm²; 5 pcs/strip

light gray	769-471	200 (25)
------------	---------	----------

Insulation stop; 0.75 ... 1 mm²; 5 pcs/strip

dark gray	769-472	200 (25)
-----------	---------	----------

Protective warning marker; with black high-voltage symbol; for 5 terminal blocks

yellow	280-415	100 (25)
--------	---------	----------

Operating lever; loose; for male and female connectors with CAGE CLAMP® connection

	769-434	2000 (100)
--	---------	------------

Test plug; with 500 mm cable; 2 mm Ø; max. 42 V

red	210-136	50
-----	---------	----

Test plug; with 500 mm cable; 2 mm Ø; max. 42 V

yellow	210-137	50
--------	---------	----

Strain relief plate; gray

1-pole	769-410	100 (25)
2- ... 3-pole	769-411	100 (25)
4- ... 5-pole	769-412	100 (25)

Strain relief plate; gray

6- ... 9-pole	769-413	100 (25)
10- ... 15-pole	769-414	100 (25)

Snap-on type strain relief housing; consists of strain relief support and housing

5-pole	769-1605	25
--------	----------	----

Accessories; for female plugs

Appropriate marking systems:
Mini-WSB/Mini-WSB Inline

Mini-WSB marking card; white; 10 strips with 10 markers/ card; 5 mm wide markers

plain	248-501	5
-------	---------	---

Mini-WSB marking card; plain; 10 strips with 10 markers/ card; 5 mm wide markers

yellow	248-501/000-002	5
red	248-501/000-005	5
blue	248-501/000-006	5
gray	248-501/000-007	5
orange	248-501/000-012	5
light green	248-501/000-017	5
green	248-501/000-023	5
violet	248-501/000-024	5

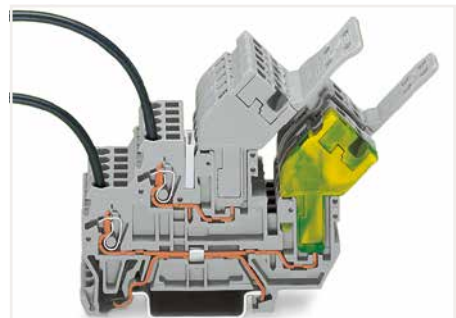

Angled female plugs provide reduced installation height.



1-conductor/1-pin double-deck carrier terminal block
1-conductor female plug, angled*
*1-conductor straight female plug is also possible!

Sold & Serviced By:
ELECTROMATE
Toll Free Phone (877) SERV098
www.electromate.com
sales@electromate.com

Female Plug for Self-Assembly X-COM®-SYSTEM

4 mm²; 769 Series

Technical Data	
0.08 ... 4 mm ²	28 ... 12 AWG
500 V/6 kV/3 ①	
I _N 32 A ②	
Terminal block width: 5 mm / 0.197 inch	
 8 ... 9 mm / 0.31 ... 0.35 inch	





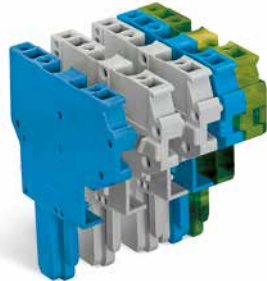



Technical Data	
0.08 ... 4 mm ²	28 ... 12 AWG
500 V/6 kV/3 ①	
I _N 32 A ②	
Terminal block width: 5 mm / 0.197 inch	
 8 ... 9 mm / 0.31 ... 0.35 inch	









Technical Data	
0.08 ... 4 mm ²	28 ... 12 AWG
500 V/6 kV/3 ①	
I _N 32 A ②	
Terminal block width: 5 mm / 0.197 inch	
 8 ... 9 mm / 0.31 ... 0.35 inch	









1-conductor end module; codable; can be commoned with miniature adjacent jumpers		
Color	Item No.	Pack. Unit
 gray	769-503	250
 blue	769-503/000-006	250
 green-yellow	769-503/000-016	250



2-conductor end module; codable; can be commoned with adjacent and staggered jumpers		
Color	Item No.	Pack. Unit
 gray	769-506	250
 blue	769-506/000-006	250
 green-yellow	769-506/000-016	250



1-conductor end module; angled; codable		
Color	Item No.	Pack. Unit
 gray	769-515	250
 blue	769-515/000-006	250
 green-yellow	769-515/000-016	250



1-conductor center module; codable; can be commoned with miniature adjacent jumpers		
Color	Item No.	Pack. Unit
 gray	769-502	250
 blue	769-502/000-006	250
 green-yellow	769-502/000-016	250

2-conductor center module; codable; can be commoned with adjacent and staggered jumpers		
Color	Item No.	Pack. Unit
 gray	769-505	250
 blue	769-505/000-006	250
 green-yellow	769-505/000-016	250

1-conductor center module; angled; codable		
Color	Item No.	Pack. Unit
 gray	769-513	250
 blue	769-513/000-006	250
 green-yellow	769-513/000-016	250

1-conductor base module; with integrated end plate; codable; can be commoned with miniature adjacent jumpers		
Color	Item No.	Pack. Unit
 gray	769-501	250
 blue	769-501/000-006	250
 green-yellow	769-501/000-016	250

2-conductor base module; with integrated end plate; codable; can be commoned with adjacent and staggered jumpers		
Color	Item No.	Pack. Unit
 gray	769-504	250
 blue	769-504/000-006	250
 green-yellow	769-504/000-016	250

1-conductor base module; angled; with integrated end plate; codable		
Color	Item No.	Pack. Unit
 gray	769-512	250
 blue	769-512/000-006	250
 green-yellow	769-512/000-016	250

Accessories; item-specific		
Adjacent jumper; insulated; I _N 24 A		
 gray	769-402	100 (25)

Accessories; item-specific		
Adjacent jumper; insulated; I _N = I _N terminal block		
 gray	280-402	200 (25)

Accessories; for female plugs

Insulation stop; 0.08 ... 0.2 mm ² "s" (0.14 mm ² "f-st"); 5 pcs/strip		
Color	Item No.	Pack. Unit
 white	769-470	200 (25)

Appropriate marking systems: Mini-WSB/Mini-WSB Inline

Locking Lever; for 1-pole female plugs		
Color	Item No.	Pack. Unit
 gray	769-428	100 (25)
orange	769-429	100 (25)

Strain relief plate; gray		
Poles	Item No.	Pack. Unit
6- ... 9-pole	769-413	100 (25)
10- ... 15-pole	769-414	100 (25)

Insulation stop; 0.25 ... 0.5 mm ² ; 5 pcs/strip		
Color	Item No.	Pack. Unit
 light gray	769-471	200 (25)

Locking lever; for female plugs with 2 poles and more		
Color	Item No.	Pack. Unit
 gray	769-431	100 (25)
orange	769-430	100 (25)

Mini-WSB marking card; white; 10 strips with 10 markers/ card; 5 mm wide markers		
Color	Item No.	Pack. Unit
plain	248-501	5

Insulation stop; 0.75 ... 1 mm ² ; 5 pcs/strip		
Color	Item No.	Pack. Unit
 dark gray	769-472	200 (25)

Test plug; with 500 mm cable; 2 mm Ø; max. 42 V		
Color	Item No.	Pack. Unit
 red	210-136	50

Mini-WSB marking card; plain; 10 strips with 10 markers/ card; 5 mm wide markers		
Color	Item No.	Pack. Unit
yellow	248-501/000-002	5
red	248-501/000-005	5
blue	248-501/000-006	5
gray	248-501/000-007	5
orange	248-501/000-012	5
light green	248-501/000-017	5
green	248-501/000-023	5
violet	248-501/000-024	5

Protective warning marker; with black high-voltage symbol; for 5 terminal blocks		
Color	Item No.	Pack. Unit
 yellow	280-415	100 (25)

Test plug; with 500 mm cable; 2 mm Ø; max. 42 V		
Color	Item No.	Pack. Unit
 yellow	210-137	50

Operating lever; loose; for male and female connectors with CAGE CLAMP® connection		
Item No.	Pack. Unit	
769-434	2000 (100)	

Strain relief plate; gray		
Poles	Item No.	Pack. Unit
1-pole	769-410	100 (25)
2- ... 3-pole	769-411	100 (25)
4- ... 5-pole	769-412	100 (25)

- ❶ 500 V = rated voltage
6 kV = rated impulse voltage
3 = pollution degree
(see Section 14)
 - ❷ Current-carrying capacity curves upon request
- Note:**
According to EN 61984, pluggable connectors without a current interrupting capacity must not be mated or unmated when live or under load.
- Approvals and corresponding ratings, visit www.wago.com

Customizing Modular Female Plugs
WAGO's modular X-COM®-SYSTEM female plugs can be customized for applications requiring varying numbers of poles (e.g., when designing prototypes).

- Modules and Pole Numbers**
A customized X-COM®-SYSTEM female plug consists of:
- One base module with an integrated end plate
 - Up to 13 center modules (corresponding to a 15-pole female plug = maximum pole number)
 - One end module

Intended Use
According to EN 61984, pluggable connectors without a current interrupting capacity must not be mated or unmated when live or under load.

Assembly
The appropriate mounting tool shall be used in order to guarantee that the individual modules are properly attached to each other without damaging the locking latches.

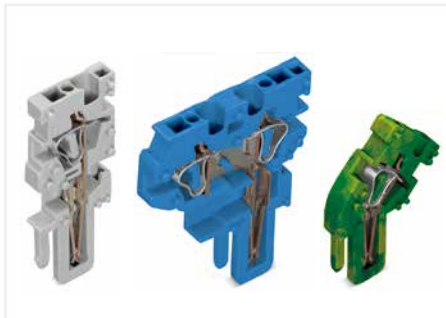

End module



Center module



Base module

Example: 5-Pole, 1-Conductor Female Plug



- Base module with integrated end plate
769-501/000-016
- Center module
769-502/000-006
- Center modules
769-502
- End module
769-503

Pre-Assembled 1-Conductor Female Plug X-COM®-SYSTEM 4 mm²; 769 Series

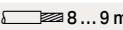
Technical Data	
0.08 ... 4 mm ²	28 ... 12 AWG
500 V/6 kV/3 ①	
I _N 32 A ②	
Module width: 5 mm / 0.197 inch	
 8 ... 9 mm / 0.31 ... 0.35 inch	



Technical Data	
0.08 ... 4 mm ²	28 ... 12 AWG
500 V/6 kV/3 ①	
I _N 32 A ②	
Module width: 5 mm / 0.197 inch	
 8 ... 9 mm / 0.31 ... 0.35 inch	

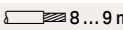

Technical Data	
0.08 ... 4 mm ²	28 ... 12 AWG
500 V/6 kV/3 ①	
I _N 32 A ②	
Module width: 5 mm / 0.197 inch	
 8 ... 9 mm / 0.31 ... 0.35 inch	



1-conductor female plug; with ground base module (green-yellow); fits into carrier terminal blocks or male connectors; codable; can be commoned with miniature adjacent jumpers

Pole No.	Item No.	Pack. Unit
3	769-103/000-036	25
4	769-104/000-036	25
5	769-105/000-036	20
6	769-106/000-036	10
7	769-107/000-036	10
8	769-108/000-036	10
9	769-109/000-036	10
10	769-110/000-036	10
11	769-111/000-036	5
12	769-112/000-036	5
13	769-113/000-036	5
14	769-114/000-036	5
15	769-115/000-036	5

1-conductor female plug; with ground base module (green-yellow); fits into carrier terminal blocks or male connectors; codable; can be commoned with miniature adjacent jumpers

Pole No.	Item No.	Pack. Unit
3	769-103/000-037	25
4	769-104/000-037	25
5	769-105/000-037	20
6	769-106/000-037	10
7	769-107/000-037	10
8	769-108/000-037	10
9	769-109/000-037	10
10	769-110/000-037	10
11	769-111/000-037	5
12	769-112/000-037	5
13	769-113/000-037	5
14	769-114/000-037	5
15	769-115/000-037	5

1-conductor female plug; with ground base module (green-yellow); fits into carrier terminal blocks or male connectors; codable; can be commoned with miniature adjacent jumpers

Pole No.	Item No.	Pack. Unit
3	769-103/000-038	25
4	769-104/000-038	25
5	769-105/000-038	20
6	769-106/000-038	10
7	769-107/000-038	10
8	769-108/000-038	10
9	769-109/000-038	10
10	769-110/000-038	10
11	769-111/000-038	5
12	769-112/000-038	5
13	769-113/000-038	5
14	769-114/000-038	5
15	769-115/000-038	5

Accessories; for female plugs

Insulation stop; 0.08 ... 0.2 mm² "s" (0.14 mm² "f-st"); 5 pcs/strip

white	769-470	200 (25)
-------	---------	----------

Insulation stop; 0.25 ... 0.5 mm²; 5 pcs/strip

light gray	769-471	200 (25)
------------	---------	----------

Insulation stop; 0.75 ... 1 mm²; 5 pcs/strip

dark gray	769-472	200 (25)
-----------	---------	----------

Protective warning marker; with black high-voltage symbol; for 5 terminal blocks

yellow	280-415	100 (25)
--------	---------	----------

Adjacent jumper; insulated; I_N 24 A

gray	769-402	100 (25)
------	---------	----------

Jumper cover; for 1-conductor female plugs; for 5 poles

gray	769-436	100 (25)
------	---------	----------

Appropriate marking systems: Mini-WSB/Mini-WSB Inline

Test plug; with 500 mm cable; 2 mm Ø; max. 42 V

red	210-136	50
-----	---------	----

Test plug; with 500 mm cable; 2 mm Ø; max. 42 V

yellow	210-137	50
--------	---------	----

Strain relief plate; gray

2- ... 3-pole	769-411	100 (25)
4- ... 5-pole	769-412	100 (25)

Strain relief plate; gray

6- ... 9-pole	769-413	100 (25)
10- ... 15-pole	769-414	100 (25)

Snap-on type strain relief housing; consists of strain relief support and housing

5-pole	769-1605	25
--------	----------	----

Operating lever; loose; for male and female connectors with CAGE CLAMP® connection

	769-434	2000 (100)
--	---------	------------

Mini-WSB marking card; white; 10 strips with 10 markers/ card; 5 mm wide markers

plain	248-501	5
-------	---------	---

Mini-WSB marking card; plain; 10 strips with 10 markers/ card; 5 mm wide markers

yellow	248-501/000-002	5
red	248-501/000-005	5
blue	248-501/000-006	5
gray	248-501/000-007	5
orange	248-501/000-012	5
light green	248-501/000-017	5
green	248-501/000-023	5
violet	248-501/000-024	5

6

Technical Data0.08 ... 4 mm² | 28 ... 12 AWG

500 V/6 kV/3 ①

I_N 32 A ②

Module width: 5 mm / 0.197 inch

8 ... 9 mm / 0.31 ... 0.35 inch



① 500 V = rated voltage
6 kV = rated impulse voltage
3 = pollution degree
(see Section 14)

② Current-carrying capacity curves upon request

Snap-on type strain relief housing, see page 416

Note:

According to EN 61984, pluggable connectors without a current interrupting capacity must not be mated or unmated when live or under load.

Approvals and corresponding ratings, visit www.wago.com

1-conductor female plug; with ground base module (green-yellow); fits into carrier terminal blocks or male connectors; codable; can be commoned with miniature adjacent jumpers

Pole No.	Item No.	Pack. Unit
3	769-103/000-039	25
4	769-104/000-039	25
5	769-105/000-039	20
6	769-106/000-039	10
7	769-107/000-039	10
8	769-108/000-039	10
9	769-109/000-039	10
10	769-110/000-039	510
11	769-111/000-039	5
12	769-112/000-039	5
13	769-113/000-039	5
14	769-114/000-039	5
15	769-115/000-039	5

Snap-on Type Strain Relief Housing X-COM®-SYSTEM; for Female Plugs and Male Connectors with CAGE CLAMP® Connection 769 Series

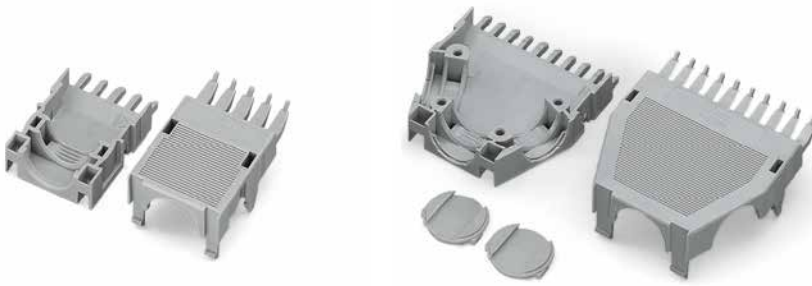

Dimensions (in mm)

Dimensions for strain relief housings

pole no.	L1	L2	L3	L4	L5	D
2	71.7	76.7	64.4	10	31.5	5
3	71.7	76.7	64.4	15	31.5	9.7
4	71.7	76.7	64.4	20	31.5	14
5	71.7	76.7	64.4	25	31.5	14
6	71.7	76.7	64.4	30	31.5	15.5
7	77.7	81.7	69.4	35	36.5	15.5
8	86.2	91.2	78.9	40	46	15.5
9	86.2	91.2	78.9	45	46	15.5
10	86.2	91.2	78.9	50	46	15.5
11	86.2	91.2	78.9	55	46	15.5
12	86.2	91.2	78.9	60	46	15.5
13	86.2	91.2	78.9	65	46	15.5
14	86.2	91.2	78.9	70	46	15.5
15	86.2	91.2	78.9	75	46	15.5

- ❶ 1 cable outlet (rear side), 2- to 5-pole only suitable for cable ties (Fa. Hellermann – not offered by WAGO)
- ❷ 1 cable outlet (rear side)
- ❸ 2 cable outlets, 1 lockout cap
- ❹ 3 cable outlets, 2 covers

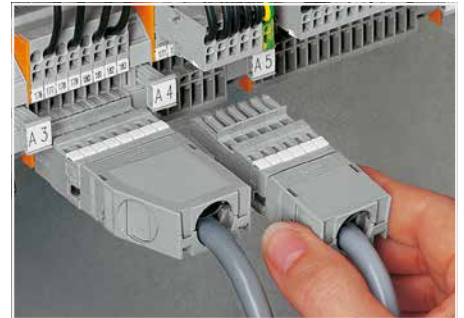

Application:
Snap-on type strain relief housings for 769 Series

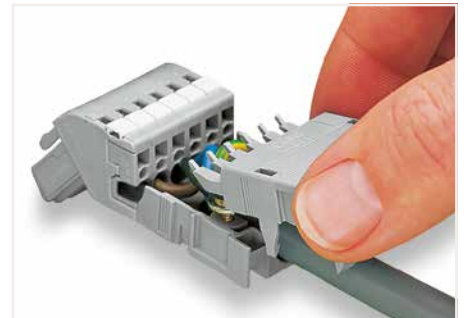

Male header and 1-conductor female plug with lateral locking levers



Snap-on type strain relief housing; consists of strain relief support and housing; 6-pole and 1-conductor female plug; angled; 6-pole

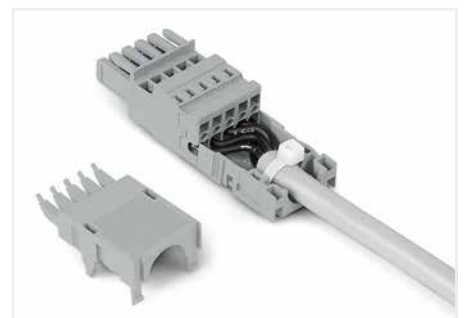

2- to 5-pole strain relief housings feature one cable outlet (rear side).
6- to 9-pole strain relief housings feature two cable outlets and one cover.
10- to 16-pole strain relief housings feature three cable outlets and two covers.

Snap-on type strain relief housing; consists of strain relief support and housing; gray

Pole No.	Item No.	Pack. Unit
○ 2	769-1602 ❶	100
○ 3	769-1603 ❶	100
○ 4	769-1604 ❶	100
○ 5	769-1605 ❶	50

Snap-on type strain relief housing; consists of strain relief support and housing; gray

Pole No.	Item No.	Pack. Unit
○ 2	769-1606 ❷	100
○ 3	769-1607 ❷	100
○ 4	769-1608 ❸	50
○ 5	769-1609 ❸	50
○ 6	769-1610 ❹	50
○ 7	769-1611 ❹	25
○ 8	769-1612 ❹	25
○ 9	769-1613 ❹	25
○ 10	769-1614 ❹	25
○ 11	769-1615 ❹	25

Accessories; item-specific

WSB Quick Marking System; white; 10 strips with 10 markers/card; for 5 ... 17.5 mm terminal block width

	plain	209-501	5

Accessories; item-specific

Cable clamp; for strain relief

	6 or more poles	209-174	25

Mounting screw; for cable clamp

	6 or more poles	209-173	50

1-Conductor/1-Pin and 2-Pin Carrier Terminal Blocks and 1-Conductor Female Plugs X-COM®-SYSTEM Current-Carrying Capacity Curves

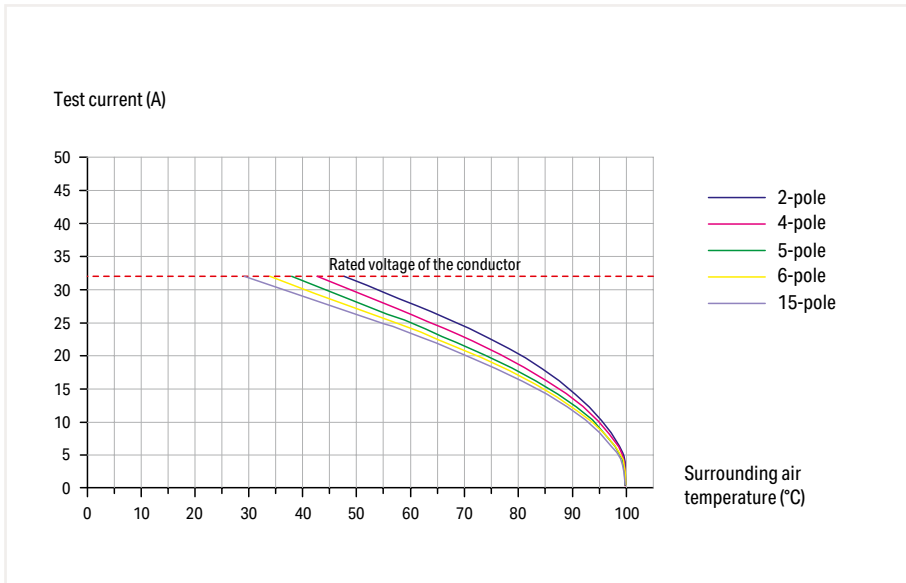

1-conductor/1-pin carrier terminal block (769-176)
Conductor cross section: 4 mm² (12 AWG)

1-conductor female plugs (769-102 to 769-115)
Conductor cross section: 4 mm² (12 AWG)
Conductor loop length: 1 m

6

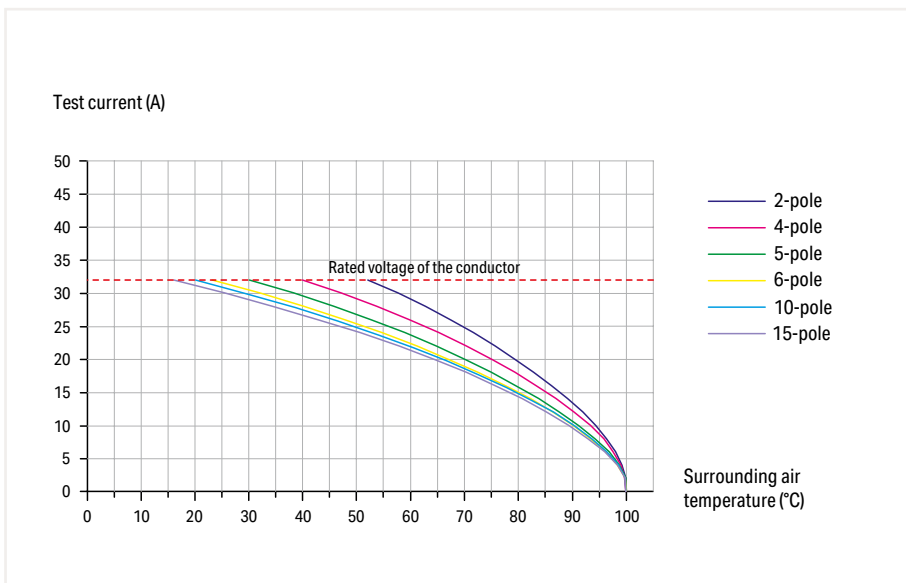

2-pin carrier terminal block (769-156)

1-conductor female plugs (769-102 to 769-115)
Conductor cross section: 4 mm² (12 AWG)
Conductor loop length: 1 m

Sold & Serviced By:



Toll Free Phone (877) SERV098
www.electromate.com
sales@electromate.com

2-Conductor/2-Pin and 4-Pin Carrier Terminal Blocks and 1-Conductor Female Plugs X-COM®-SYSTEM Current-Carrying Capacity Curves

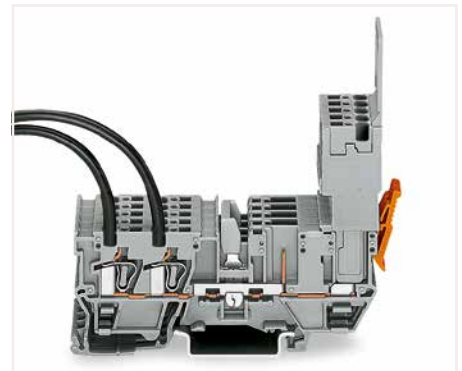
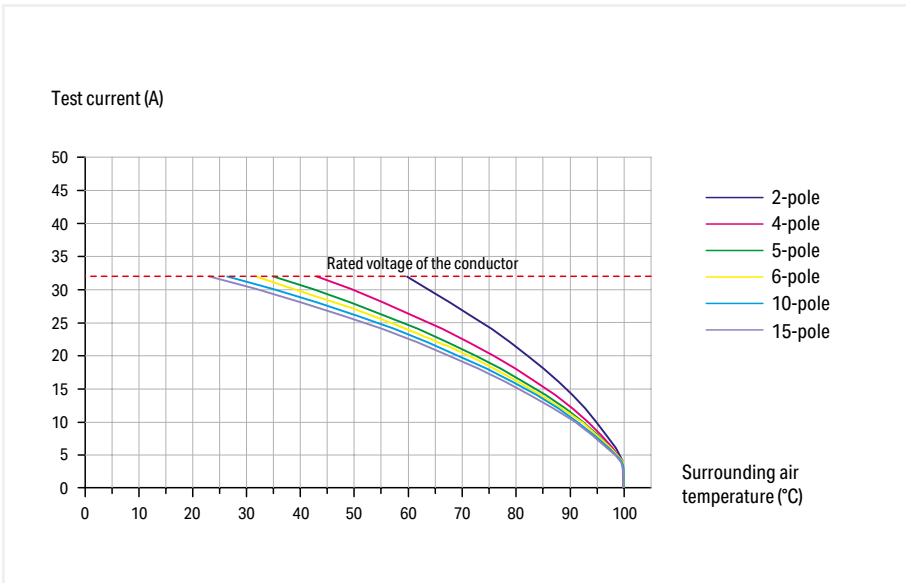

2-conductor/2-pin carrier terminal block (769-171)
Conductor cross section: 4 mm² (12 AWG)

1-conductor female plugs (769-102 to 769-115)
Conductor cross section: 4 mm² (12 AWG)
Conductor loop length: 1 m

6

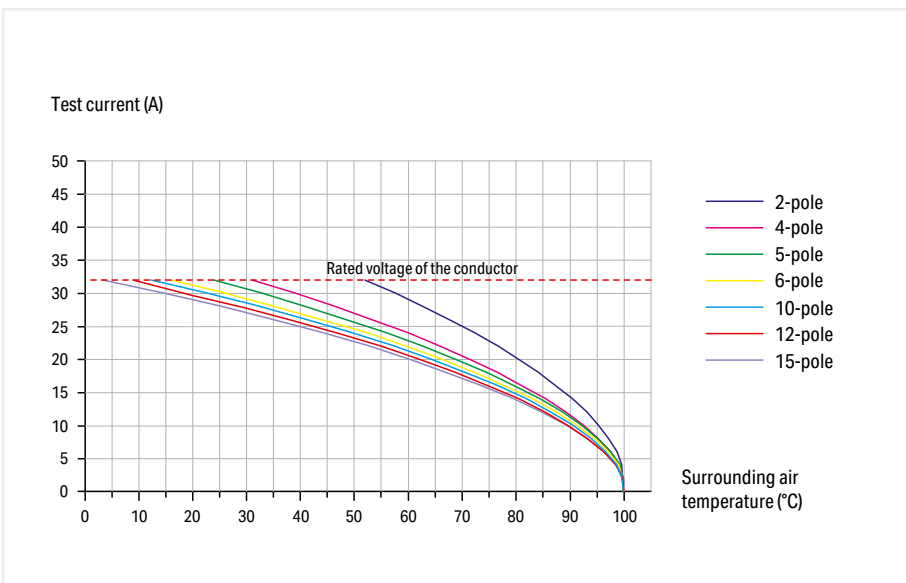

4-pin carrier terminal block (769-151)

1-conductor female plugs (769-102 to 769-115)
Conductor cross section: 4 mm² (12 AWG)
Conductor loop length: 1 m

Male Connectors; with CAGE CLAMP® Connection and 1-Conductor Female Plugs X-COM®-SYSTEM Current-Carrying Capacity Curves

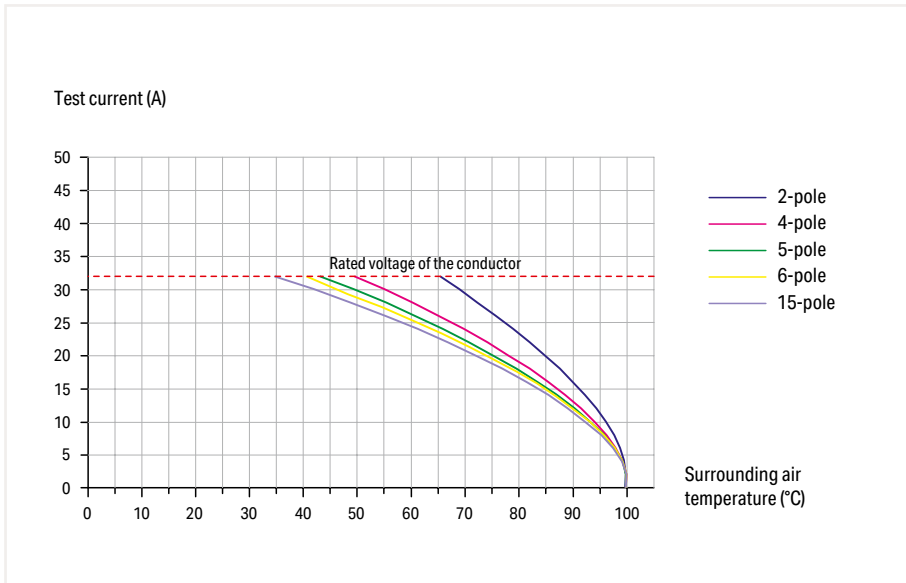

Male connectors with CAGE CLAMP® connection (769-602 to 769-615)
Conductor cross section: 4 mm² (12 AWG)

1-conductor female plugs (769-102 to 769-115)
Conductor cross section: 4 mm² (12 AWG)
Conductor loop length: 1 m

Male Headers with Straight/Angled Solder Pins and 1-Conductor Female Plugs X-COM®-SYSTEM Current-Carrying Capacity Curves

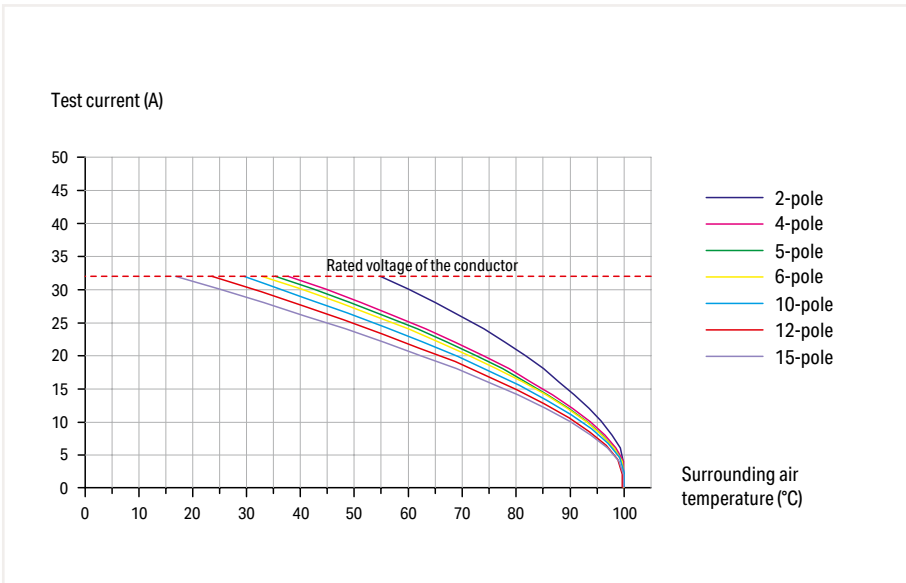

Male headers with straight solder pins (769-632 to 769-645)

1-conductor female plugs (769-102 to 769-115)
Conductor cross section: 4 mm² (12 AWG)
Conductor loop length: 1 m

6

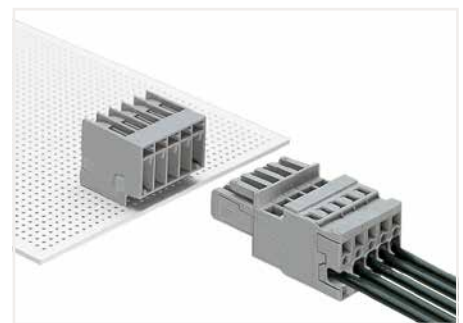
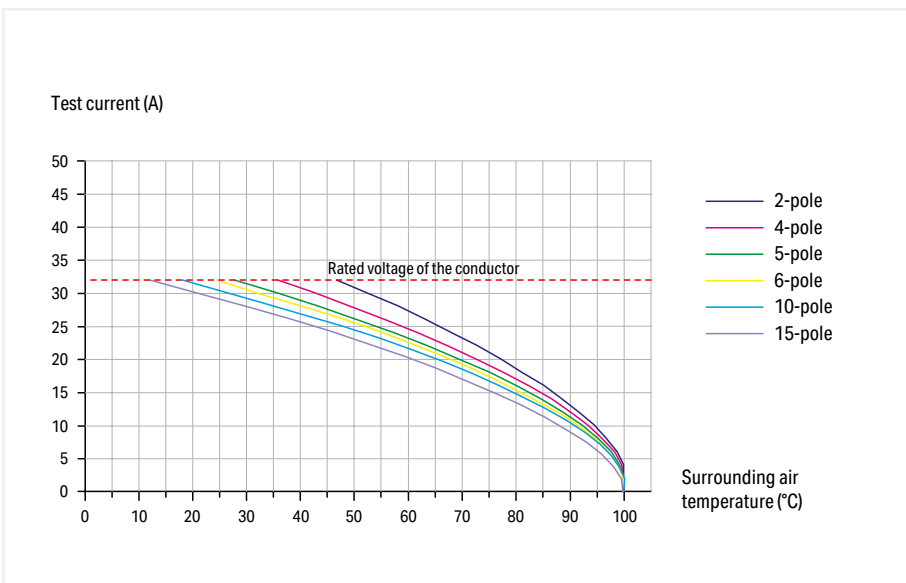

Male headers with angled solder pins (769-662 to 769-675)

1-conductor female plugs (769-102 to 769-115)
Conductor cross section: 4 mm² (12 AWG)
Conductor loop length: 1 m

6

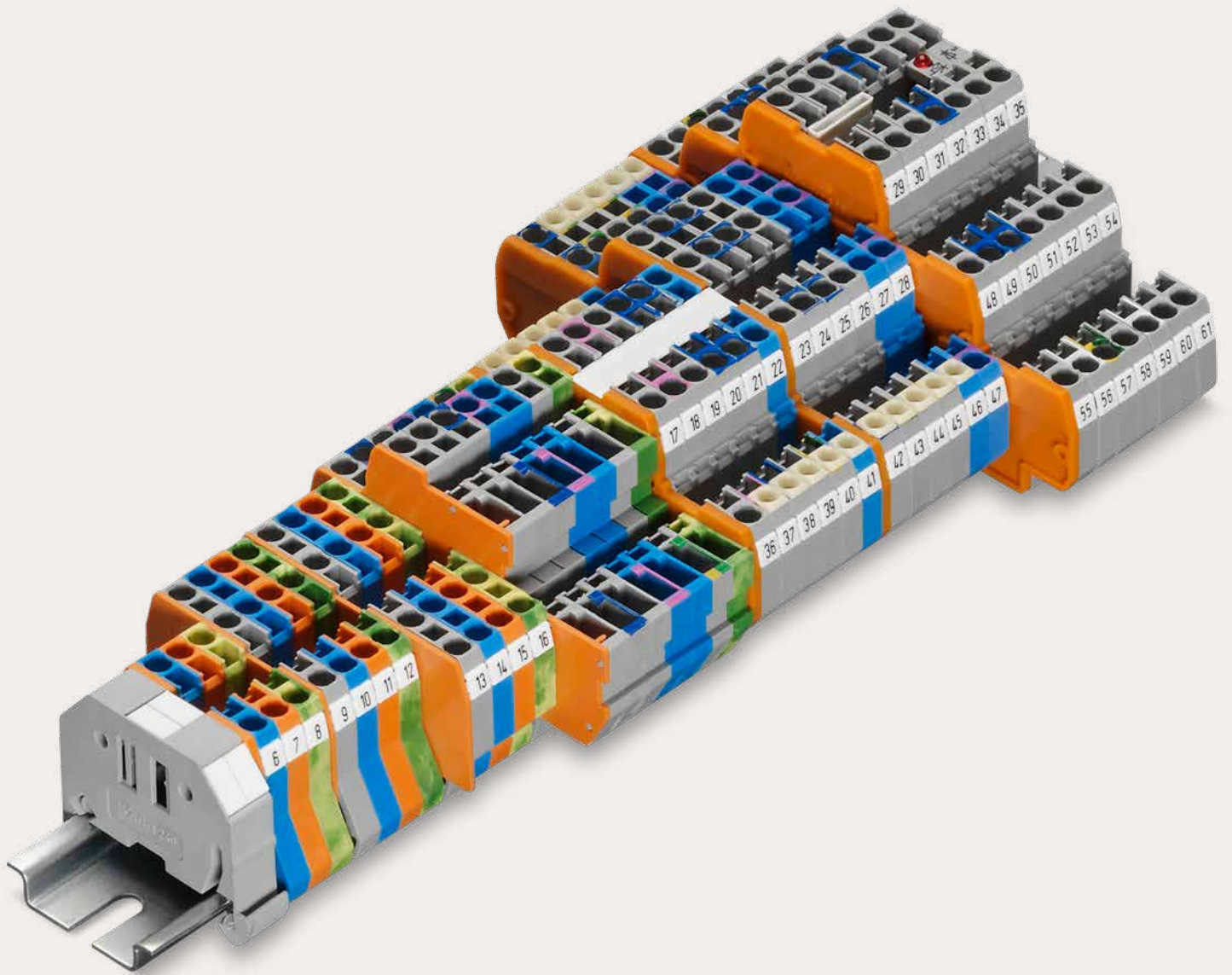







WAGO Rail-Mount Terminal Blocks Mini
WAGO Rail-Mount Terminal Blocks Compact

WAGO Rail-Mount Terminal Blocks Mini

WAGO Rail-Mount Terminal Blocks Compact

Front-Entry Wiring

			Page
	Through, Ground Conductor and Ex Terminal Blocks for DIN-35 and DIN-15 Rails 0.08 ... 2.5 mm ² (28 ... 12 AWG)	264 Series	426
	Through, Ground Conductor and Ex Terminal Blocks for DIN-35 and DIN-15 Rails 0.08 ... 2.5 (4 "f-st") mm ² (28 ... 12 AWG)	870 Series	430
	Multilevel Rail-Mount Terminal Blocks 0.08 ... 2.5 (4 "f-st") mm ² (28 ... 12 AWG)	870 Series	432
	Multilevel Diode and LED Terminal Blocks 0.08 ... 2.5 (4 "f-st") mm ² (28 ... 12 AWG)	870 Series	436
	Sensor and Actuator Terminal Blocks 0.08 ... 2.5 mm ² (28 ... 12 AWG)	270 Series	443
	Accessories for Rail-Mount Terminal Blocks		441

Rail-Mount Terminal Blocks Mini; for DIN-15 and DIN-35 Rails

264 Series

Description and Installation

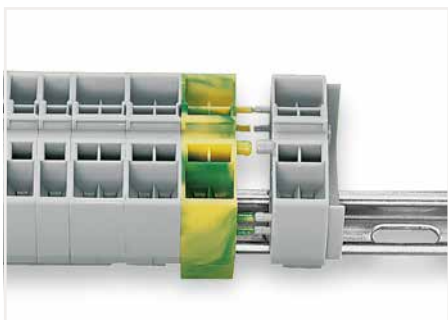

Quick assembly keys prevent reverse mounting.

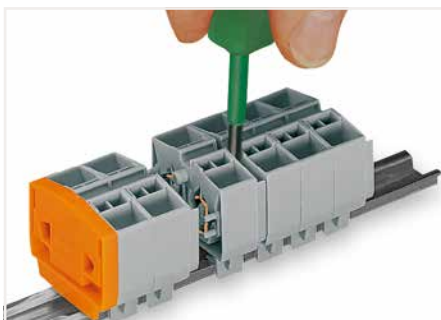

Separate terminal strip and slide individual terminal block laterally.



Remove terminal block from the DIN-rail with a levering action.



Commoning with comb-style jumper bar.

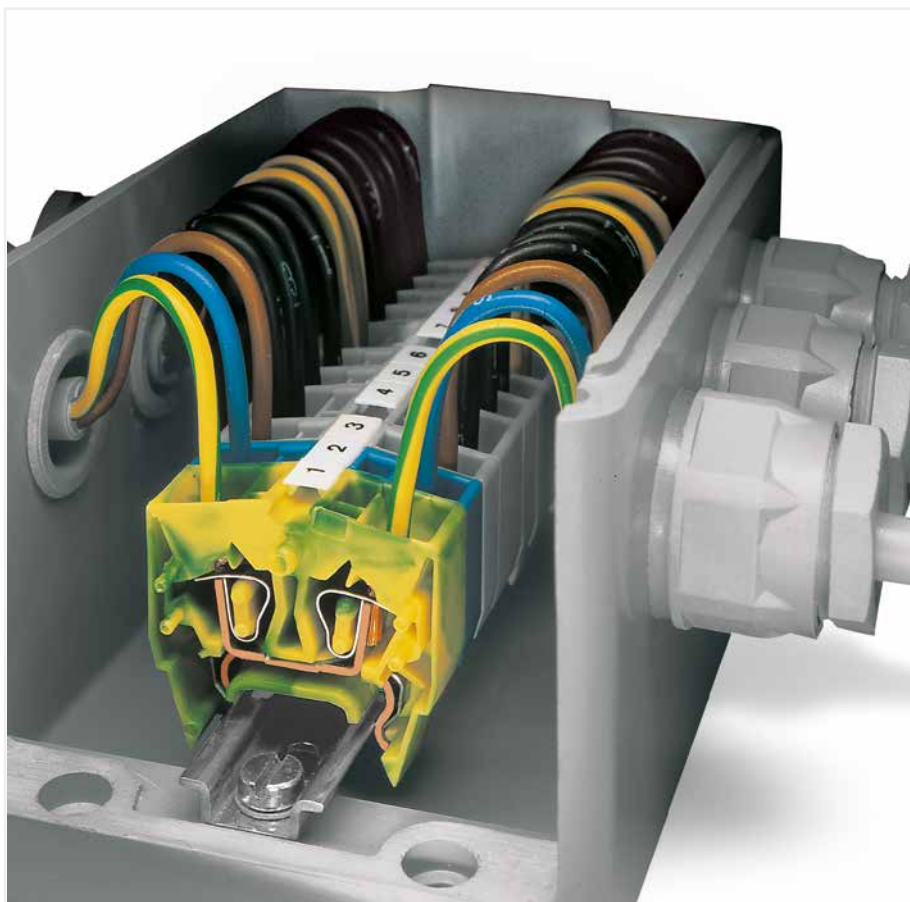

7



Commoning with comb-style jumper bar.



Easy-to-use miniature blocks that require minimal enclosure space.



Combining 2- and 4-conductor terminal blocks. Marking via Mini-WSB Quick Marking System.



CAGE CLAMP® terminates the following copper conductors: solid



stranded



fine-stranded, also with tinned single strands



CAGE CLAMP® termination:
Inserting a conductor.
With ferruled conductors, it is necessary to use a terminal block one size smaller than the conductor's nominal cross section.

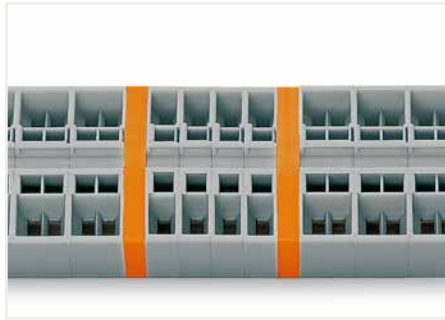

Separating groups via intermediate plates.

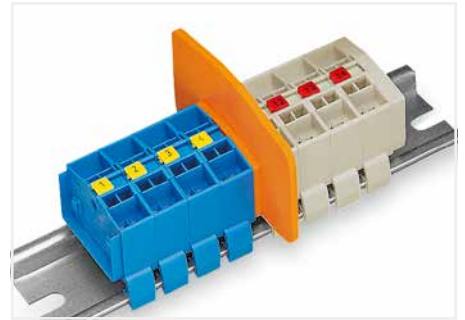

Ex e/Ex i separator plate for miniature rail-mount terminal blocks

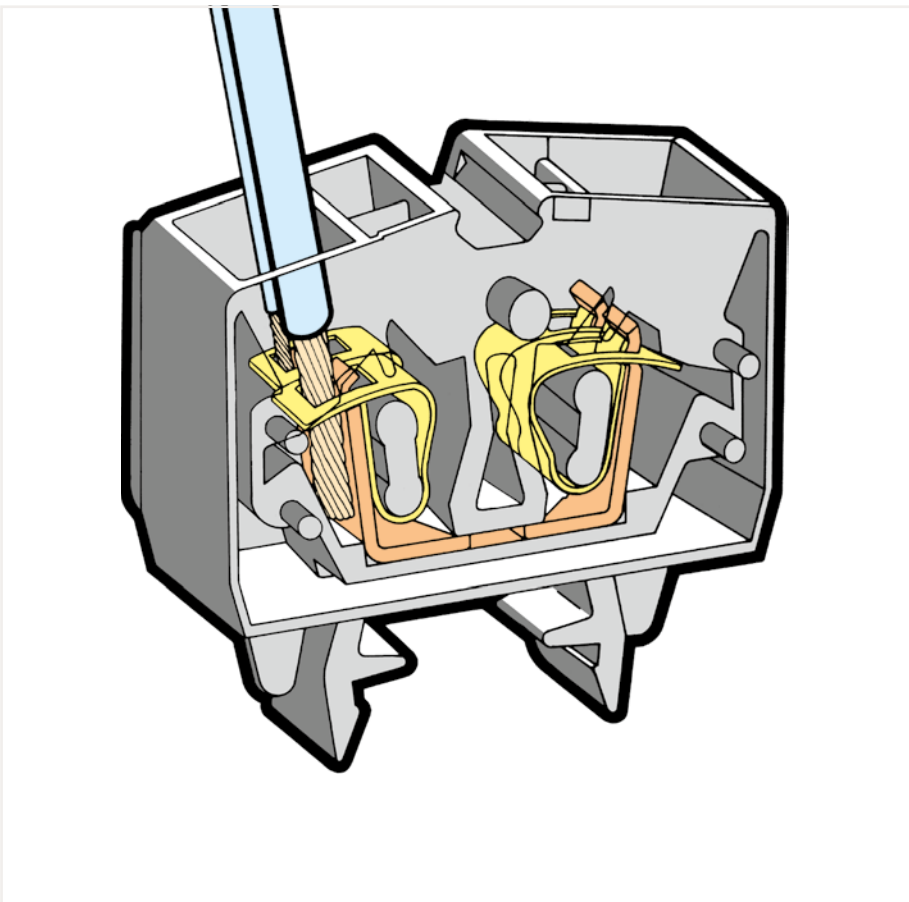

Testing by touch contact to the CAGE CLAMP® spring (limited to 0.5 A and 48 V test voltage) – test pins are not protected against accidental contact.

7



Testing via CAGE CLAMP® on the current bar (max. nominal current: 6 A) – CAGE CLAMP® clamps individual test contacts. The maximum test voltage is 400 V.



Marking with T-marker tag (209-290).



fine-stranded, tip-bonded



fine-stranded, with ferrule (gastight crimped)



fine-stranded, with pin terminal (gastight crimped)

Miniature Through/Ground Conductor and Ex Terminal Block; for DIN-35 Rail

2.5 mm²; 264 Series

Technical Data	
0.08 ... 2.5 mm ²	28 ... 12 AWG*
800 V/8 kV/3 ❶	300 V, 20 A ❷
I _N 24 A	600 V, 20 A ❸
Terminal block width: 6 mm / 0.236 inch	
8 ... 9 mm / 0.31 ... 0.35 inch	



Technical Data	
0.08 ... 2.5 mm ²	28 ... 12 AWG*
800 V/8 kV/3 ❶	300 V, 20 A ❷
I _N 24 A	600 V, 20 A ❸
Terminal block width: 10 mm / 0.394 inch	
8 ... 9 mm / 0.31 ... 0.35 inch	

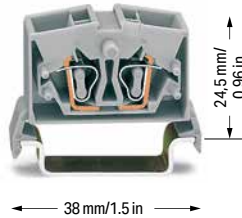

2-conductor miniature through terminal block; for DIN-35 rail		
Color	Item No.	Pack. Unit
gray	264-711	100
blue ❷	264-714	100
orange	264-716	100
light gray ❸	264-125	100

4-conductor miniature through terminal block; for DIN-35 rail		
Color	Item No.	Pack. Unit
gray	264-731	100
blue ❷	264-734	100
orange	264-736	100
light gray ❸	264-225	100

Accessories; item-specific		
Alternate comb-style jumper bar; insulated; I _N = I _N of terminal block		
2-way	281-492	100 (25)

Accessories; item-specific		
Alternate comb-style jumper bar; insulated; I _N = I _N of terminal block		
2-way	280-492	200 (25)

Test plug module; snaps together; 6 mm wide		
gray	249-136	100 (25)

Test plug module; snaps together; 10 mm wide		
gray	249-139	100 (25)

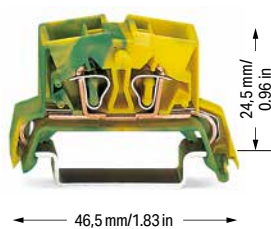

4-conductor miniature ground terminal block; for DIN-35 rail		
Color	Item No.	Pack. Unit
green-yellow	264-737	100
green-yellow ❸	264-737/999-950	100

Accessories; item-specific		
Alternate comb-style jumper bar; insulated; I _N = I _N of terminal block		
2-way	280-492	200 (25)

Test plug module; snaps together; 10 mm wide		
gray	249-139	100 (25)

*12 AWG: THHN, THWN

- ❶ 800 V = rated voltage
8 kV = rated impulse voltage
3 = pollution degree (see Section 14)
- ❷ Terminal blocks with a blue insulated housing are suitable for Ex i applications.
- ❸ Terminal blocks with an Ex mark are suitable for Ex e II applications.
0.5 ... 2.5 mm² / 20 ... 12 AWG*
690 V; 23 A (see Section 14)

See application notes for:
Alternate comb-style jumper bar, page 347
Test plug module, page 474
Mini-WSB marking system, page 589

Approvals and corresponding ratings, visit www.wago.com

Accessories; 264 Series

Appropriate marking systems:
Mini-WSB/Mini-WSB Inline/T-marker tag

End and intermediate plate; 4 mm thick		
orange	264-369	25
gray	264-368	25
light gray	264-370	25

Ex e/Ex i separator; orange; 4 mm thick		
66 mm	264-367	25

Comb-style jumper bar; insulated; reduces maximum conductor size to 1.5 mm ² ; I _N 16 A; gray		
2-way	264-402	200 (25)

Operating tool; insulated		
2-way	280-432	1

Test plug; with 500 mm cable; 2 mm Ø; max. 42 V		
red	210-136	50

Test plug; with 500 mm cable; 2 mm Ø; max. 42 V		
yellow	210-137	50

Mini-WSB marking card; white; 10 strips with 10 markers/card; 5 mm wide markers		
plain	248-501	5

Screwless end stop; for DIN-35 rail; 6 mm wide		
gray	249-116	100 (25)

Steel DIN-rail; per EN 60715; 35 x 7.5 mm; 1 mm thick; 2 m long		
slotted	210-112	10 (1)
unslotted	210-113	10

Aluminum DIN-rail; similar to EN 60715; 35 x 8.2 mm; 1.6 mm thick; 2 m long		
unslotted	210-196	10

7

Miniature Through/Ground Conductor and Ex Terminal Block; for DIN-15 Rail

2.5 mm²; 264 Series

Technical Data	
0.08 ... 2.5 mm ²	28 ... 12 AWG*
800 V/8 kV/3 ①	300 V, 20 A ②
I _N 24 A	600 V, 20 A ③
Terminal block width: 6 mm / 0.236 inch	
8 ... 9 mm / 0.31 ... 0.35 inch	

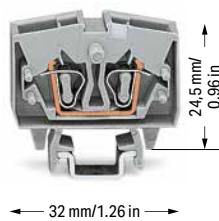

2-conductor miniature through terminal block; for DIN-15 rail		
Color	Item No.	Pack. Unit
gray	264-701	100
blue	264-704 ②	100
orange	264-706	100
light gray ③	264-120 ③	100

Accessories; item-specific		
Alternate comb-style jumper bar; insulated; I _N = I _N of terminal block		
2-way	281-492	100 (25)



Test plug module; snaps together; 6 mm wide		
gray	249-136	100 (25)



Technical Data	
0.08 ... 2.5 mm ²	28 ... 12 AWG*
800 V/8 kV/3 ①	300 V, 20 A ②
I _N 24 A	600 V, 20 A ③
Terminal block width: 10 mm / 0.394 inch	
8 ... 9 mm / 0.31 ... 0.35 inch	

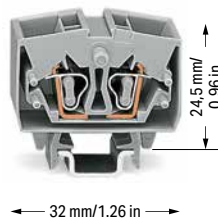

4-conductor miniature through terminal block; for DIN-15 rail		
Color	Item No.	Pack. Unit
gray	264-721	100
blue	264-724 ②	100
orange	264-726	100
light gray ③	264-220 ③	100

Accessories; item-specific		
Alternate comb-style jumper bar; insulated; I _N = I _N of terminal block		
2-way	280-492	200 (25)



Test plug module; snaps together; 10 mm wide		
gray	249-139	100 (25)



4-conductor miniature ground terminal block; for DIN-15 rail		
Color	Item No.	Pack. Unit
green-yellow	264-727	100
green-yellow ③	264-727/999-950 ③	100

Accessories; item-specific		
Alternate comb-style jumper bar; insulated; I _N = I _N of terminal block		
2-way	280-492	200 (25)



Test plug module; snaps together; 10 mm wide		
gray	249-139	100 (25)



*12 AWG: THHN, THWN

- ① 800 V = rated voltage
8 kV = rated impulse voltage
3 = pollution degree
(see Section 14)
- ② Terminal blocks with a blue insulated housing are suitable for Ex i applications.
- ③ Terminal blocks with an Ex mark are suitable for Ex e II applications.
0.5 ... 2.5 mm² / 20 ... 12 AWG*
690 V; 23 A
(see Section 14)

See application notes for:
Alternate comb-style jumper bar, page 347
Test plug module, page 474
Mini-WSB marking system, page 589

Approvals and corresponding ratings, visit www.wago.com

Accessories; 264 Series

Appropriate marking systems:
Mini-WSB/Mini-WSB Inline/T-marker tag

End and intermediate plate; 4 mm thick			
orange	264-369	25	
gray	264-368	25	
light gray	264-370	25	

Ex e/Ex i separator; orange; 4 mm thick			
66 mm	264-367	25	

Comb-style jumper bar; insulated; reduces maximum conductor size to 1.5 mm ² ; I _N 16 A; gray			
2-way	264-402	200 (25)	

Operating tool; insulated			
2-way	280-432	1	

Operating tool; insulated			
1-way	209-130	1	

Test plug; with 500 mm cable; 2 mm Ø; max. 42 V			
red	210-136	50	

yellow	210-137	50	
--------	---------	----	--

Screwless end stop; for DIN-15 rail; 6 mm wide			
gray	249-101	25	

Steel DIN-rail; per EN 60715; 15 x 5.5 mm; 1 mm thick; 2 m long

slotted	210-111	10 (1)
unslotted	210-295	10 (1)

Aluminum DIN-rail; similar to EN 60715; 15 x 5.5 mm; 1 mm thick; 2 m long

unslotted	210-296	1
-----------	---------	---

Rail-Mount Terminal Blocks Compact; for DIN-15 and DIN-35 Rails

870 Series

Description and Installation

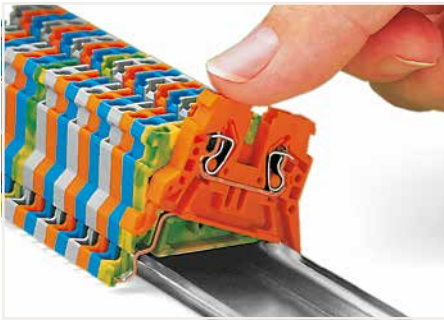

Snapping a rail-mount terminal block onto DIN-35 rail.

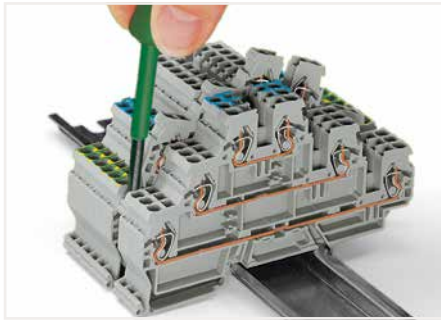

Removing a terminal block from the assembly.



Inserting insulation stops into conductor entry holes of terminal strip.



Push jumper bars down firmly until fully inserted. When using multipole bars, push alternately on the right and then left side until installed. Push-in type jumper bars 1-3-5-7 or 1-4-7 are available upon request.

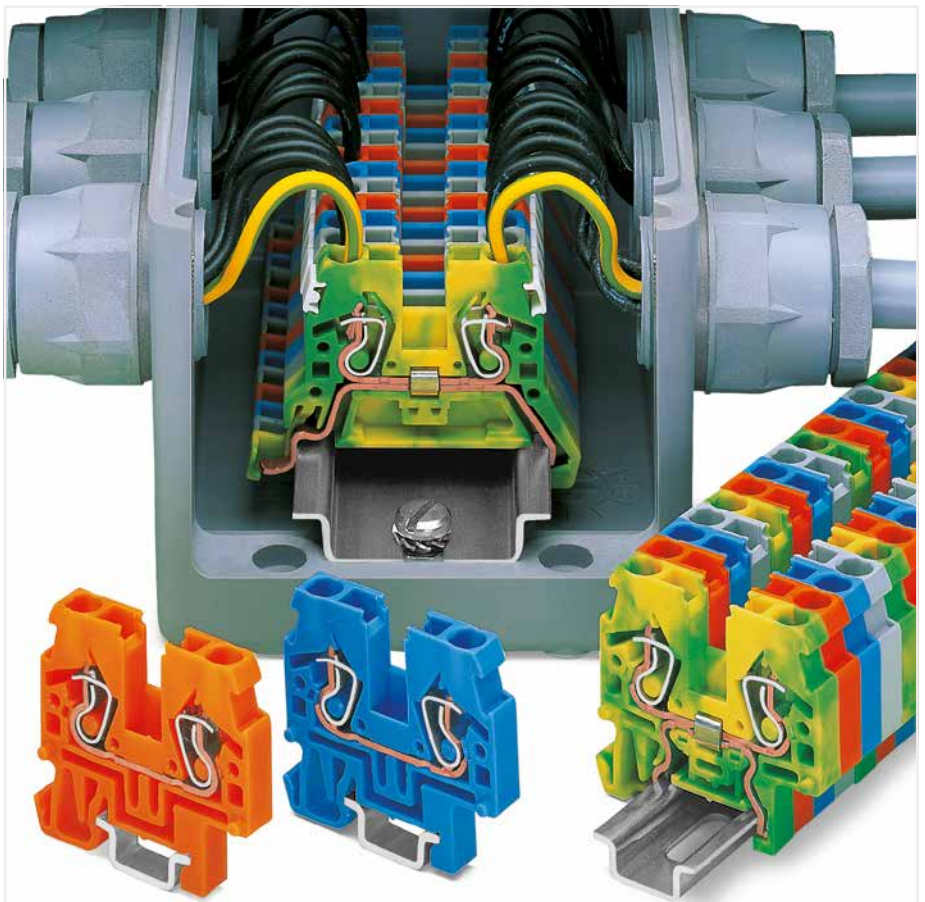

7

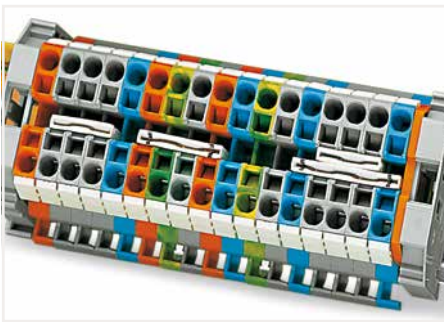

Commoning with push-in type jumper bars: Two parallel jumper slots are accommodated in one terminal block.



Commoning terminal blocks of different sizes via step-down jumpers.

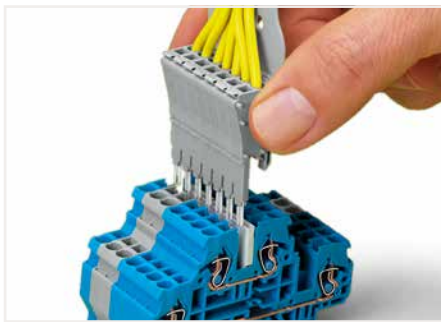

Testing: Using a pre-wired module assembly, similar to test plugs.

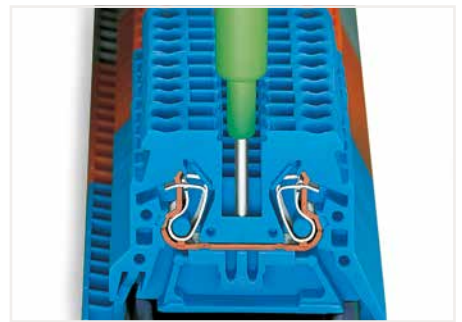

Testing with phase testing device, also possible with single-pole voltage tester.



CAGE CLAMP® terminates the following copper conductors: solid



stranded



fine-stranded, also with tinned single strands



CAGE CLAMP® termination:
Inserting a conductor via operating tool (0.08 ... 4 mm² "f-st").

With ferruled conductors, it is necessary to use a terminal block one size smaller than the conductor's nominal cross section.

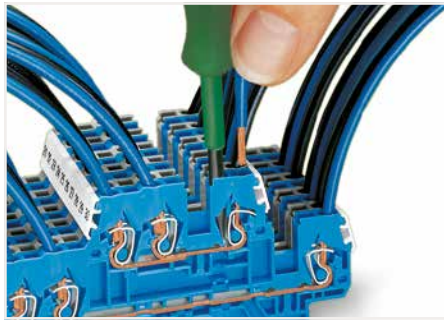

CAGE CLAMP® termination:
Inserting a conductor via operating tool (0.08 ... 4 mm² "f-st").

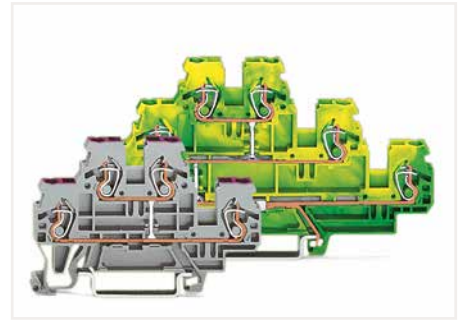

Multilevel terminal blocks:
Double- and triple-deck terminal blocks with internal comings acting as 4- and 6-conductor terminal blocks

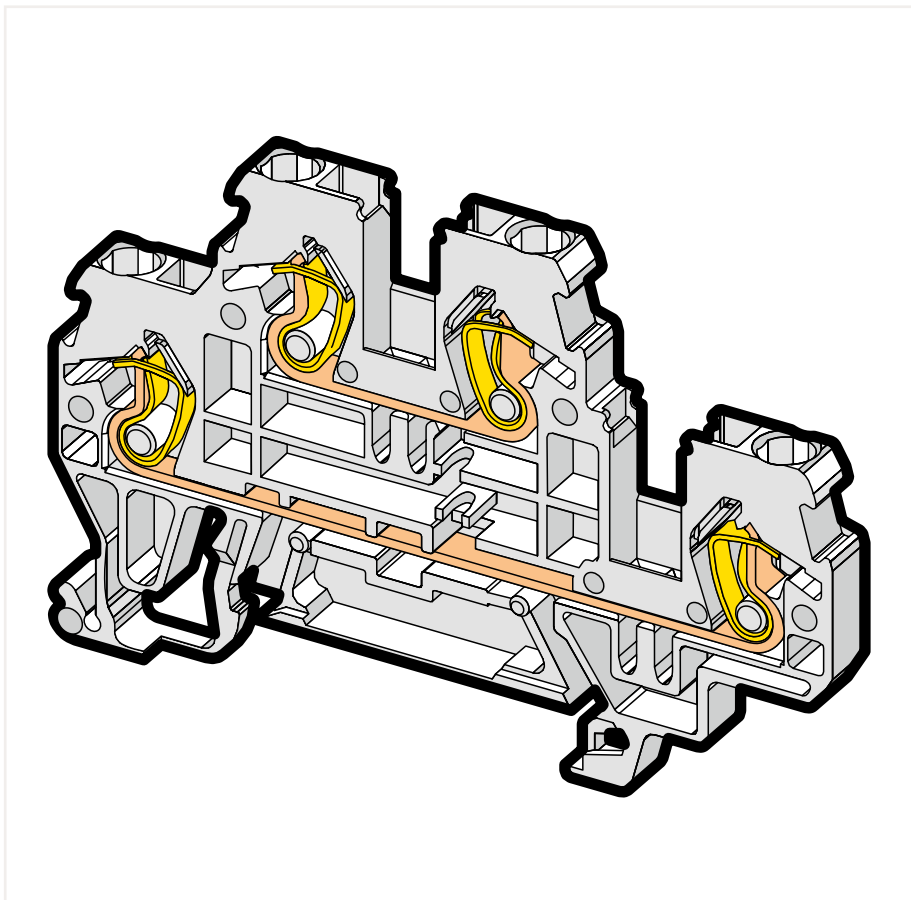

Protective warning marker (280-405); with a black high-voltage symbol

7

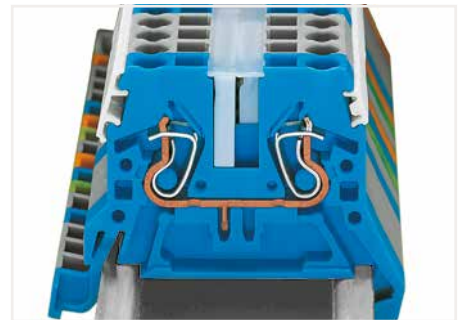

WMB markers in Mini-WSB marker slots
Marking strip; translucent
Mini-WSB markers



Use 50% less rail space with double-deck terminal blocks.



Use 67% less rail space with triple-deck terminal blocks.



Translucent marking strip (709-196) – jumpers below may be visible.



fine-stranded,
tip-bonded



fine-stranded,
with ferrule
(gastight crimped)



fine-stranded,
with pin terminal
(gastight crimped)

Through/Ground Conductor/Ex and Double-Potential Terminal Block for DIN-35 and DIN-15 Rails

2.5 (4 "f-st") mm²; 870 Series

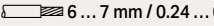
Technical Data	
0.08 ... 2.5 (4 "f-st") mm ² ①	28 ... 12 AWG
500 V/6 kV/3 ②	300 V, 20 A $\overline{V_{UL}}$
I _N 24 A	
Terminal block width: 5 mm / 0.197 inch	
 6 ... 7 mm / 0.24 ... 0.28 inch	

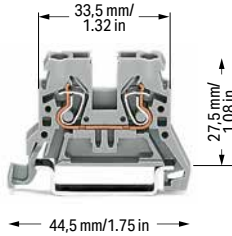

2-conductor through terminal block; for DIN-35 rail		
Color	Item No.	Pack. Unit
gray	870-901	100
blue	870-904 ③	100
orange	870-902	100
light gray ④	870-909 ④	100

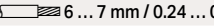
Technical Data	
0.08 ... 2.5 (4 "f-st") mm ² ①	28 ... 12 AWG
500 V/6 kV/3 ②	300 V, 20 A $\overline{V_{UL}}$
I _N 24 A	
Terminal block width: 5 mm / 0.197 inch	
 6 ... 7 mm / 0.24 ... 0.28 inch	

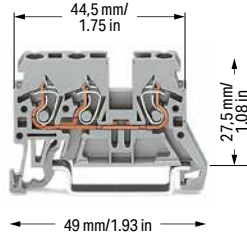

3-conductor through terminal block; for DIN-35 rail		
Color	Item No.	Pack. Unit
gray	870-681	100
blue	870-684 ③	100
orange	870-682	100

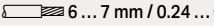
Technical Data	
0.08 ... 2.5 (4 "f-st") mm ² ①	28 ... 12 AWG
500 V/6 kV/3 ②	300 V, 20 A $\overline{V_{UL}}$
I _N 24 A	
Terminal block width: 5 mm / 0.197 inch	
 6 ... 7 mm / 0.24 ... 0.28 inch	

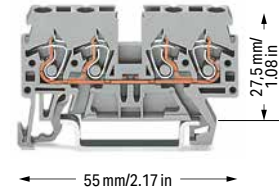

4-conductor through terminal block; for DIN-35 rail		
Color	Item No.	Pack. Unit
gray	870-831	100
blue	870-834 ③	100
orange	870-832	100

2-conductor ground terminal block; for DIN-35 rail		
Notice: This ground conductor terminal block cannot be commoned with push-in type jumper bars!		
Color	Item No.	Pack. Unit
green-yellow	870-907	100
green-yellow ④	870-907/999-950 ④	100

3-conductor ground terminal block; for DIN-35 rail		
Notice: This ground conductor terminal block cannot be commoned with push-in type jumper bars!		
Color	Item No.	Pack. Unit
green-yellow	870-687	100

4-conductor ground terminal block; for DIN-35 rail		
Notice: This ground conductor terminal block cannot be commoned with push-in type jumper bars!		
Color	Item No.	Pack. Unit
green-yellow	870-837	100

Other terminal blocks with the same profile:		
Double-potential	870-826	Page 430

Accessories; item-specific			
End and intermediate plate; 2 mm thick			
orange	870-924	100 (25)	
gray	870-923	100 (25)	
light gray	870-925	100 (25)	

Accessories; item-specific			
End and intermediate plate; 1 mm thick			
orange	870-934	100 (25)	
gray	870-933	100 (25)	

Accessories; item-specific			
End and intermediate plate; 1 mm thick			
orange	870-944	100 (25)	
gray	870-943	100 (25)	

Separator; oversized; 2 mm thick			
orange	870-929	100 (25)	
gray	870-928	100 (25)	

Separator; oversized; 1 mm thick			
orange	870-947	100 (25)	
gray	870-946	100 (25)	

Separator; oversized; 1 mm thick			
orange	870-949	100 (25)	
gray	870-948	100 (25)	

End and intermediate plate; 2 mm thick; for 2-conductor ground conductor Ex terminal blocks only			
green-yellow	870-926	100 (25)	

Ex e/Ex i separator; orange; 3 mm thick			
90 mm	209-190	50 (25)	
120 mm	209-191	50 (25)	

Accessories; 870 Series Appropriate marking systems: Mini-WSB/Mini-WSB Inline/WMB/WMB Inline

Insulation stop; 0.08 ... 0.2 mm ² "s" (0.14 mm ² "f-st"); 5 pcs/strip			
white	280-470	200 (25)	

Push-in type jumper bar; insulated; I _N 18 A; light gray			
2-way	870-402	200 (25)	
3-way	870-403	200 (25)	
4-way	870-404	100 (25)	
5-way	870-405	100 (25)	
6-way	870-406	100 (25)	
7-way	870-407	100 (25)	
8-way	870-408	100 (25)	
9-way	870-409	100 (25)	
10-way	870-410	50 (25)	



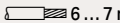

Push-in type jumper bar; insulated; I _N 18 A; light gray			
1 to 3	870-433	200 (25)	
1 to 4	870-434	200 (25)	
1 to 5	870-435	100 (25)	
1 to 6	870-436	100 (25)	
1 to 7	870-437	100 (25)	
1 to 8	870-438	100 (25)	
1 to 9	870-439	100 (25)	
1 to 10	870-440	50 (25)	

Insulation stop; 0.25 ... 0.5 mm ² ; 5 pcs/strip			
light gray	280-471	200 (25)	

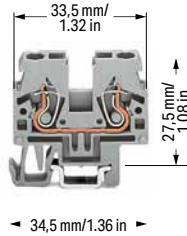

Insulation stop; 0.75 ... 1 mm ² ; 5 pcs/strip			
dark gray	280-472	200 (25)	



Technical Data	
0.08 ... 2.5 (4 "f-st") mm ² ①	28 ... 12 AWG
500 V/6 kV/3 ②	300 V, 20 A. 
I _N 24 A	
Terminal block width: 5 mm / 0.197 inch	
 6 ... 7 mm / 0.24 ... 0.28 inch	





2-conductor through terminal block; for DIN-15 rail		
Color	Item No.	Pack. Unit
 gray	870-911	100
 light gray	870-914 ③	100
 orange	870-912	100
 light gray ④	870-919 ④	100

2-conductor ground terminal block; for DIN-15 rail		
Notice: This ground conductor terminal block cannot be commoned with push-in type jumper bars!		
Color	Item No.	Pack. Unit
 green-yellow	870-917	100

Accessories; item-specific			
End and intermediate plate; 2 mm thick			
	orange	870-924	100 (25)
	gray	870-923	100 (25)
	light gray	870-925	100 (25)

Separator; oversized; 2 mm thick			
	orange	870-929	100 (25)
	gray	870-928	100 (25)

Protective warning marker; with black high-voltage symbol; for 5 terminal blocks			
	yellow	280-405	100 (25)

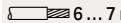

Tap-off module; with anti-reverse mating protection; snaps together; 5 mm wide			
	gray	870-425	100 (25)

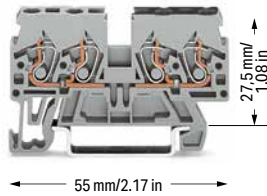

Technical Data	
0.08 ... 2.5 (4 "f-st") mm ² ①	28 ... 12 AWG
500 V/6 kV/3 ②	300 V, 20 A. 
I _N 24 A	
Terminal block width: 5 mm / 0.197 inch	
 6 ... 7 mm / 0.24 ... 0.28 inch	



Double-potential terminal block; with integrated marking level		
Color	Item No.	Pack. Unit
 gray	870-826	100

Notice: These double-potential terminal blocks cannot be commoned with push-in type jumper bars! Front-entry double-potential terminal blocks are space savers. Two independent feedthrough circuits are placed in one insulated housing on one level in just 5 mm. This achieves a width of just 2.5 mm versus standard through terminal blocks for a total height of just 27.5 mm from the upper edge of DIN-rail. Input and output of a circuit are placed on the same side of the terminal block. Both circuits can be individually marked according to input and output. Technical data and accessories, visit www.wago.com

Accessories; item-specific			
End and intermediate plate; 1 mm thick			
	orange	870-944	100 (25)
	gray	870-943	100 (25)

Separator; oversized; 1 mm thick			
	orange	870-949	100 (25)
	gray	870-948	100 (25)

Mini-WSB marking card; white; 10 strips with 10 markers/ card; 5 mm wide markers			
	plain	248-501	5

- Max. insulation diameter: 4.4 mm
 - 500 V = rated voltage
6 kV = rated impulse voltage
3 = pollution degree (see Section 14)
 - Terminal blocks with a blue insulated housing are suitable for Ex i applications.
 - Suitable for Ex e II applications
0.2 ... 2.5 (4 "f-st") mm² / 24 ... 12 AWG
440 V; 22 A (see Section 14)
Using one or more push-in type jumper bars, the maximum rated voltage is reduced to 275 V and the rated current to 13.5 A.
- See application notes for:
Insulation stop, see page 346
Tap-off module, page 441
Group marker carrier, page 435

Approvals and corresponding ratings, visit www.wago.com



Mounting on DIN-15 rail:
Snap individual terminal blocks onto the DIN-15 rail and slide together.

Removal from DIN-15 rail:
Open assembly by laterally sliding terminal blocks with an operating tool and remove them from the rail.



In order to meet creepage and clearance requirements for Ex e applications, it is necessary to insert an end or intermediate plate between a through and a ground conductor terminal block. End plates 870-923 (gray), 870-924 (orange) and 870-925 (light gray), as well as separator plates 870-928 (gray) and 870-929 (orange) cannot be assembled to 2-conductor ground Ex terminal blocks (870-907/999-950).

Double-Deck Terminal Block

2.5 (4 "f-st") mm²; 870 Series

Technical Data

0.08 ... 2.5 (4 "f-st") mm² ① | 28 ... 12 AWG
 500 V/6 kV/3 ②

I_N 24 A
 Terminal block width: 5 mm / 0.197 inch

6 ... 7 mm / 0.24 ... 0.28 inch

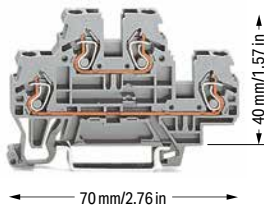

Double-deck terminal block; Through/through terminal block; Gray housing

	Item No.	Pack. Unit
○ L/L	870-501	50
○ N/L	870-502	50
○ L/N	870-503	50

Double-deck terminal block; Through/through terminal block; Blue housing

● N/N 870-504 ③ 50

Double-deck terminal block; Through/through terminal block; Light gray housing

○ L/L ⊕ 870-961 ④ 50

Other terminal blocks with the same profile:

Diode	870-540/281-410	Page 436
LED	870-543/281-434	Page 436

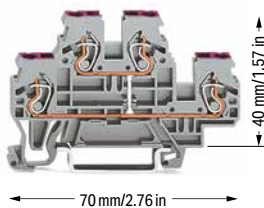

Double-deck terminal block; 4-conductor through terminal block; internally commoned; Violet conductor entry; Gray housing

	Item No.	Pack. Unit
○ L	870-508	50

Double-deck terminal block; 4-conductor through terminal block; internally commoned; Violet conductor entry; Blue housing

● N 870-509 ③ 50

Technical Data

0.08 ... 2.5 (4 "f-st") mm² ① | 28 ... 12 AWG
 500 V/6 kV/3 ②

I_N 24 A
 Terminal block width: 5 mm / 0.197 inch

6 ... 7 mm / 0.24 ... 0.28 inch

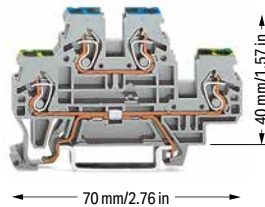

Double-deck terminal block; Ground conductor/through terminal block; Gray housing

	Item No.	Pack. Unit
○ GND/N	870-517	50
○ GND/L	870-527	50

Double-deck terminal block; Ground conductor/through terminal block; Light gray housing

○ GND/L ⊕ 870-967/999-950 ③ 50

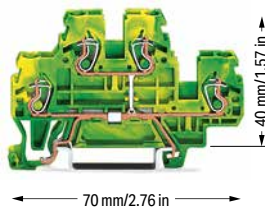

Double-deck terminal block; 4-conductor ground terminal block; internally commoned; Green-yellow housing

	Item No.	Pack. Unit
● GND	870-507	50

① Max. insulation diameter: 4.4 mm

② 500 V = rated voltage
 6 kV = rated impulse voltage
 3 = pollution degree (see Section 14)

③ Terminal blocks with a blue insulated housing are suitable for Ex i applications.

④ Suitable for Ex e II applications
 0.2 ... 2.5 (4 "f-st") mm² / 24 ... 12 AWG
 440 V; 22 A (see Section 14)
 Using one or more push-in type jumper bars, the maximum rated voltage is reduced to 275 V and the rated current to 13.5 A.

See application notes for:
 Insulation stop, see page 346
 Group marker carrier, page 435

Approvals and corresponding ratings, visit www.wago.com

Accessories; 870 Series

Appropriate marking systems:
 Mini-WSB/Mini-WSB Inline/WMB/WMB Inline

End and intermediate plate; 2 mm thick

orange	870-519	100 (25)
gray	870-518	100 (25)

Ex e/Ex i separator; orange; 3 mm thick

125.5 mm	209-192	50 (25)
----------	---------	---------

Insulation stop; 0.08 ... 0.2 mm² "s" (0.14 mm² "f-st"); 5 pcs/strip

white	280-470	200 (25)
-------	---------	----------

Insulation stop; 0.25 ... 0.5 mm²; 5 pcs/strip

light gray	280-471	200 (25)
------------	---------	----------

Insulation stop; 0.75 ... 1 mm²; 5 pcs/strip

dark gray	280-472	200 (25)
-----------	---------	----------

Protective warning marker; with black high-voltage symbol; for 5 terminal blocks

yellow	280-405	100 (25)
--------	---------	----------

Push-in type jumper bar; insulated; I_N 18 A; light gray

2-way	870-402	200 (25)
3-way	870-403	200 (25)
4-way	870-404	100 (25)
5-way	870-405	100 (25)
6-way	870-406	100 (25)
7-way	870-407	100 (25)
8-way	870-408	100 (25)
9-way	870-409	100 (25)
10-way	870-410	50 (25)

Push-in type jumper bar; insulated; I_N 18 A; light gray

1 to 3	870-433	200 (25)
1 to 4	870-434	200 (25)
1 to 5	870-435	100 (25)
1 to 6	870-436	100 (25)
1 to 7	870-437	100 (25)
1 to 8	870-438	100 (25)
1 to 9	870-439	100 (25)
1 to 10	870-440	50 (25)

7

3-Conductor Double-Deck Terminal Block

2.5 (4 "f-st") mm²; 870 Series

Technical Data	
0.08 ... 2.5 (4 "f-st") mm ² ①	28 ... 12 AWG
500 V/6 kV/3 ②	300 V, 20 A ③
I _N 24 A	
Terminal block width: 5 mm / 0.197 inch	
6 ... 7 mm / 0.24 ... 0.28 inch	

Technical Data	
0.08 ... 2.5 (4 "f-st") mm ² ①	28 ... 12 AWG
500 V/6 kV/3 ②	
I _N 24 A	
Terminal block width: 5 mm / 0.197 inch	
6 ... 7 mm / 0.24 ... 0.28 inch	

- ① Max. insulation diameter: 4.4 mm
 - ② 500 V = rated voltage
6 kV = rated impulse voltage
3 = pollution degree
(see Section 14)
 - ③ Terminal blocks with a blue insulated housing are suitable for Ex i applications.
- See application notes for:
Insulation stop, see page 346
Group marker carrier, page 435
- Approvals and corresponding ratings,
visit www.wago.com

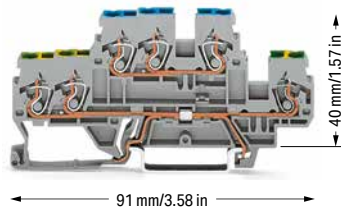
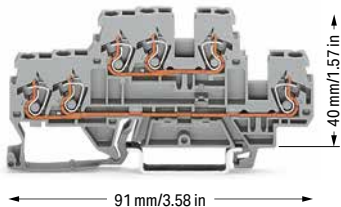

3-conductor double-deck terminal block; Through/through terminal block; Gray housing		
	Item No.	Pack. Unit
○ L/L	870-531	50
○ N/L	870-532	50
○ L/N	870-533	50

3-conductor double-deck terminal block; Ground conductor/through terminal block; Gray housing		
	Item No.	Pack. Unit
○ GND/N	870-535	50
○ GND/L	870-536	50

3-conductor double-deck terminal block; Through/through terminal block; Blue housing		
● N/N	870-534 ④	50

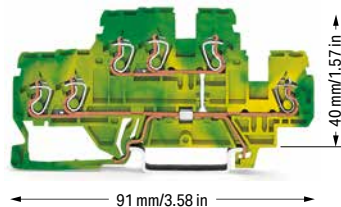
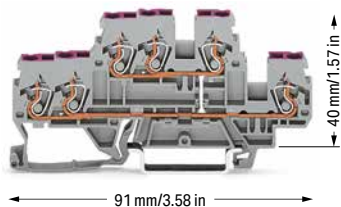

3-conductor double-deck terminal block; 6-conductor through terminal block; internally commoned; Violet conductor entry; Gray housing		
	Item No.	Pack. Unit
○ L	870-538	50

3-conductor double-deck terminal block; 6-conductor ground terminal block; internally commoned; Green-yellow housing		
	Item No.	Pack. Unit
● GND	870-537	50

3-conductor double-deck terminal block; 6-conductor through terminal block; internally commoned; Violet conductor entry; Blue housing		
● N	870-539 ④	50

Accessories; 870 Series
Appropriate marking systems:
Mini-WSB/Mini-WSB Inline/WMB/WMB Inline

End and intermediate plate; 2 mm thick		
orange	870-574	100 (25)
gray	870-573	100 (25)

Insulation stop; 0.08 ... 0.2 mm ² "s" (0.14 mm ² "f-st"); 5 pcs/strip		
white	280-470	200 (25)

Insulation stop; 0.25 ... 0.5 mm ² ; 5 pcs/strip		
light gray	280-471	200 (25)

Insulation stop; 0.75 ... 1 mm ² ; 5 pcs/strip		
dark gray	280-472	200 (25)

Protective warning marker; with black high-voltage symbol; for 5 terminal blocks		
yellow	280-405	100 (25)

Push-in type jumper bar; insulated; I _N 18 A; light gray		
2-way	870-402	200 (25)
3-way	870-403	200 (25)
4-way	870-404	100 (25)
5-way	870-405	100 (25)
6-way	870-406	100 (25)
7-way	870-407	100 (25)
8-way	870-408	100 (25)
9-way	870-409	100 (25)
10-way	870-410	50 (25)

Push-in type jumper bar; insulated; I _N 18 A; light gray		
1 to 3	870-433	200 (25)
1 to 4	870-434	200 (25)
1 to 5	870-435	100 (25)
1 to 6	870-436	100 (25)
1 to 7	870-437	100 (25)
1 to 8	870-438	100 (25)
1 to 9	870-439	100 (25)
1 to 10	870-440	50 (25)

Marking strip; plain; 7.5 mm wide; 1 m long		
translucent	709-196	1

Mini-WSB marking card; white; 10 strips with 10 markers/card; 5 mm wide markers		
plain	248-501	5

Triple-Deck Terminal Block

2.5 (4 "f-st") mm²; 870 Series

Technical Data

0.08 ... 2.5 (4 "f-st") mm² ① | 28 ... 12 AWG
 500 V/6 kV/3 ② | 300 V, 20 A, ③
 I_N 24 A
 Terminal block width: 5 mm / 0.197 inch
 6 ... 7 mm / 0.24 ... 0.28 inch

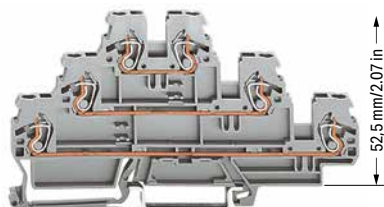

106 mm/4.17 in

Triple-deck terminal block; Through/through/through terminal block; Gray housing

	Item No.	Pack. Unit
○ L/L/L	870-551	50
○ L/L/N	870-553	50

Triple-deck terminal block; Through/through/through terminal block; Light gray housing

○ L/L/L ④	870-951 ⑤	50
-----------	-----------	----

Other terminal blocks with the same profile:

Diode	870-590/281-410	Page 438
LED	870-593/281-434	Page 438

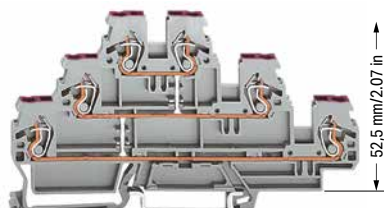

106 mm/4.17 in

Triple-deck terminal block; 6-conductor through terminal block; internally commoned; Violet conductor entry; Gray housing

	Item No.	Pack. Unit
○ L	870-556	50

Technical Data

0.08 ... 2.5 (4 "f-st") mm² ① | 28 ... 12 AWG
 500 V/6 kV/3 ② |
 I_N 24 A
 Terminal block width: 5 mm / 0.197 inch
 6 ... 7 mm / 0.24 ... 0.28 inch

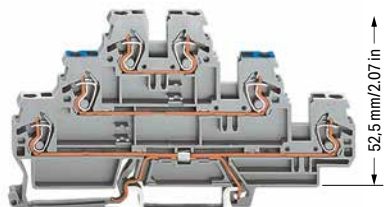

106 mm/4.17 in

Triple-deck terminal block; Shield conductor/through/through terminal block; Gray housing

	Item No.	Pack. Unit
○ Shield/N/L	870-558	50
○ Shield/L/L	870-559	50

Triple-deck terminal block; Ground conductor/through/through terminal block; Gray housing

○ GND/N/L	870-567	50
○ GND/L/L	870-577	50

Triple-deck terminal block; Ground conductor/through/through terminal block; Light gray housing

○ GND/L/L ④	870-957/999-950 ⑤	50
-------------	-------------------	----



106 mm/4.17 in

Triple-deck terminal block; 6-conductor ground terminal block; internally commoned; Green-yellow housing

	Item No.	Pack. Unit
● GND	870-557	50

① Max. insulation diameter: 4.4 mm

② 500 V = rated voltage
 6 kV = rated impulse voltage
 3 = pollution degree (see Section 14)

③ Terminal blocks with a blue insulated housing are suitable for Ex i applications.

④ Suitable for Ex e II applications
 0.2 ... 2.5 (4 "f-st") mm² / 24 ... 12 AWG
 440 V; 22 A (see Section 14)
 Using one or more push-in type jumper bars, the maximum rated voltage is reduced to 275 V and the rated current to 13.5 A.

See application notes for:
 Insulation stop, see page 346
 Group marker carrier, page 435

Approvals and corresponding ratings, visit www.wago.com

Accessories: 870 Series

Appropriate marking systems:
 Mini-WSB/Mini-WSB Inline/WMB/WMB Inline

End and intermediate plate; 2 mm thick

orange	870-569	100 (25)
gray	870-568	100 (25)

Insulation stop; 0.08 ... 0.2 mm² "s" (0.14 mm² "f-st"); 5 pcs/strip

white	280-470	200 (25)
-------	---------	----------

Insulation stop; 0.25 ... 0.5 mm²; 5 pcs/strip

light gray	280-471	200 (25)
------------	---------	----------

Insulation stop; 0.75 ... 1 mm²; 5 pcs/strip

dark gray	280-472	200 (25)
-----------	---------	----------

Protective warning marker; with black high-voltage symbol; for 5 terminal blocks

yellow	280-405	100 (25)
--------	---------	----------

Push-in type jumper bar; insulated; I_N 18 A; light gray

2-way	870-402	200 (25)
3-way	870-403	200 (25)
4-way	870-404	100 (25)
5-way	870-405	100 (25)
6-way	870-406	100 (25)
7-way	870-407	100 (25)
8-way	870-408	100 (25)
9-way	870-409	100 (25)
10-way	870-410	50 (25)

Push-in type jumper bar; insulated; I_N 18 A; light gray

1 to 3	870-433	200 (25)
1 to 4	870-434	200 (25)
1 to 5	870-435	100 (25)
1 to 6	870-436	100 (25)
1 to 7	870-437	100 (25)
1 to 8	870-438	100 (25)
1 to 9	870-439	100 (25)
1 to 10	870-440	50 (25)

Marking strip; plain; 7.5 mm wide; 1 m long

translucent	709-196	1
-------------	---------	---

7

Group Marker Carrier, Marking Strip and Push-In Type Jumper Bar



Group marker carrier; fits into the jumper slot of the current bars
Module width: 5 mm

Color	Item No.	Pack. Unit
<input type="radio"/> gray	870-184	50 (25)

Group marker carrier; fits into the jumper slot of the current bars
Module width: 10 mm

<input type="radio"/> gray	870-183	50 (25)
----------------------------	---------	---------

Group marker carrier; fits into the jumper slot of the current bars
Module width: 15 mm

<input type="radio"/> gray	870-182	50 (25)
----------------------------	---------	---------

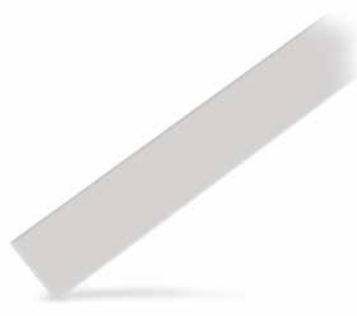

Marking strip; plain; 7.5 mm wide; 1 m long

Color	Item No.	Pack. Unit
translucent	709-196	50 (25)

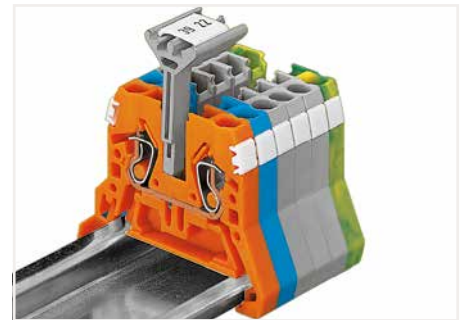

In addition to the plastic marker strips, group marker carriers are now available for the WMB and WSB marking systems. They can be mounted in parallel to a push-in type jumper bar via the open jumper contact slot. It is also very useful if the marker slots on the side of the terminal block are hidden. The carriers are available in the following widths: 5 mm (0.197 inch), 10 mm (0.394 inch) and 15 mm (0.591 inch).

Notice:

Group marker carriers are not suitable for ground conductor terminal blocks and double potential terminal blocks as they have no jumper contact slots.



Ready-made push-in type jumper bar; insulated; I_N 18 A; light gray

	Item No.	Pack. Unit
<input type="radio"/> 1-3-5	870-405/011-000	200 (25)
<input type="radio"/> 1-3-5-7	870-407/011-000	200 (25)
<input type="radio"/> 1-3-5-7-9	870-409/011-000	100 (25)



Delta jumper; insulated; 1-2 3-4 5-6; I_N 18 A

Color	Item No.	Pack. Unit
<input type="radio"/> light gray	870-406/020-000	100 (25)

Sold & Serviced By:



Toll Free Phone (877) SERV098
www.electromate.com
sales@electromate.com

Double-Deck Diode Terminal Block and LED Terminal Block 2.5 (4 "f-st") mm²; 870 Series

Technical Data

0.08 ... 2.5 (4 "f-st") mm² ① | 28 ... 12 AWG

U_N 250 V; U_{RM} 1000 V

1N4007 – 0.5 A continuous current

Terminal block width: 5 mm / 0.197 inch

6 ... 7 mm / 0.24 ... 0.28 inch

Technical Data

0.08 ... 2.5 (4 "f-st") mm² ① | 28 ... 12 AWG

U_N 250 V; U_{RM} 1000 V

1N4007 – 0.5 A continuous current

Terminal block width: 5 mm / 0.197 inch

6 ... 7 mm / 0.24 ... 0.28 inch

Technical Data

0.08 ... 2.5 (4 "f-st") mm² ① | 28 ... 12 AWG

24 VDC

I_F 0.025 A max.

Terminal block width: 5 mm / 0.197 inch

6 ... 7 mm / 0.24 ... 0.28 inch

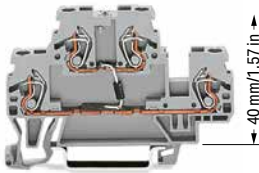

870-540/281-410 870-540/281-411

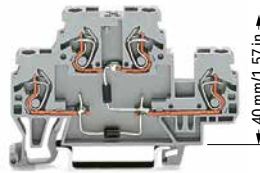

870-541/281-492 870-541/281-491

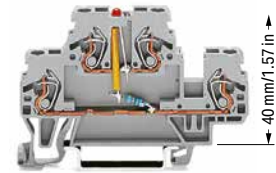

870-543/281-413 870-543/281-434

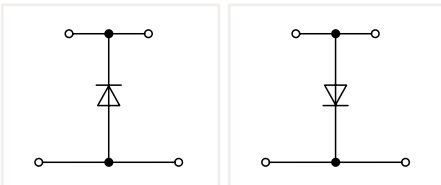

Double-deck diode terminal block; with 1N4007 diode

Color	Item No.	Pack. Unit
○ gray	870-540/281-410	50
○ gray	870-540/281-411	50

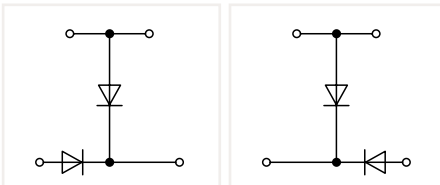

Double-deck diode terminal block; with two 1N4007 diodes

Color	Item No.	Pack. Unit
○ gray	870-541/281-492	50
○ gray	870-541/281-491	50

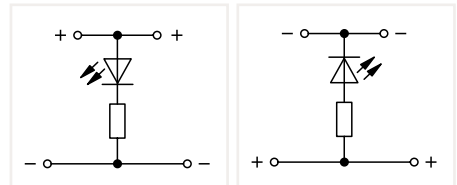

Double-deck LED terminal block; with red LED

Color	Item No.	Pack. Unit
○ gray	870-543/281-413	50
○ gray	870-543/281-434	50

Other terminal blocks with the same profile:

Through 870-501 Page 432

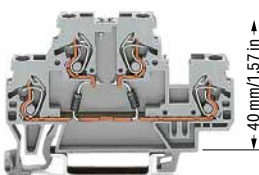

870-542/281-487 870-542/281-488

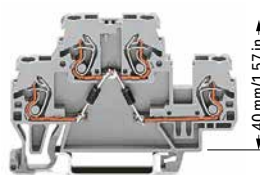

870-541/281-489 870-541/281-490

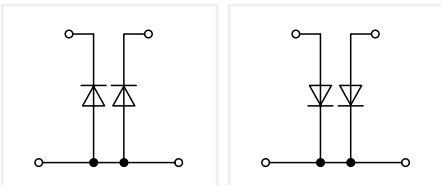

Double-deck diode terminal block; with two 1N4007 diodes

Color	Item No.	Pack. Unit
○ gray	870-542/281-487	50
○ gray	870-542/281-488	50

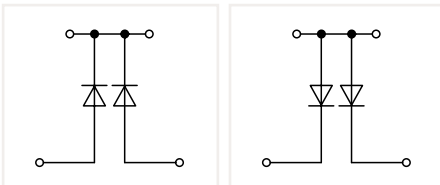

Double-deck diode terminal block; with two 1N4007 diodes

Color	Item No.	Pack. Unit
○ gray	870-541/281-489	50
○ gray	870-541/281-490	50

Double-Deck Diode Terminal Blocks and LED Terminal Blocks Circuit Configuration Examples

1 Max. insulation diameter: 4.4 mm

See application notes for:
Insulation stop, see page 346
Group marker carrier, page 435

Approvals and corresponding ratings,
visit www.wago.com

Accessories; 870 Series

Appropriate marking systems:
Mini-WSB/Mini-WSB Inline/WMB/WMB Inline

End and intermediate plate; 2 mm thick

	orange	870-519	100 (25)
	gray	870-518	100 (25)

Insulation stop; 0.08 ... 0.2 mm² "s" (0.14 mm² "f-st"); 5 pcs/strip

	white	280-470	200 (25)
---	-------	---------	----------

Insulation stop; 0.25 ... 0.5 mm²; 5 pcs/strip

	light gray	280-471	200 (25)
---	------------	---------	----------

Insulation stop; 0.75 ... 1 mm²; 5 pcs/strip

	dark gray	280-472	200 (25)
---	-----------	---------	----------

Protective warning marker; with black high-voltage symbol; for 5 terminal blocks

	yellow	280-405	100 (25)
---	--------	---------	----------

Push-in type jumper bar; insulated; I_N 18 A; light gray

	2-way	870-402	200 (25)
	3-way	870-403	200 (25)
	4-way	870-404	100 (25)
	5-way	870-405	100 (25)
	6-way	870-406	100 (25)
	7-way	870-407	100 (25)
	8-way	870-408	100 (25)
	9-way	870-409	100 (25)
	10-way	870-410	50 (25)

Push-in type jumper bar; insulated; I_N 18 A; light gray

	1 to 3	870-433	200 (25)
	1 to 4	870-434	200 (25)
	1 to 5	870-435	100 (25)
	1 to 6	870-436	100 (25)
	1 to 7	870-437	100 (25)
	1 to 8	870-438	100 (25)
	1 to 9	870-439	100 (25)
	1 to 10	870-440	50 (25)

Marking strip; plain; 7.5 mm wide; 1 m long

	translucent	709-196	1
---	-------------	---------	---

Mini-WSB marking card; white; 10 strips with 10 markers/ card; 5 mm wide markers

	plain	248-501	5
---	-------	---------	---

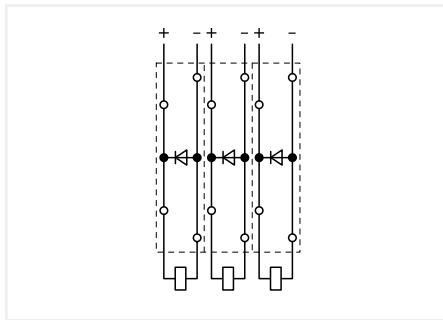

Recovery diodes can be created using the following terminal blocks:
870-540/281-410 or 870-540/281-411

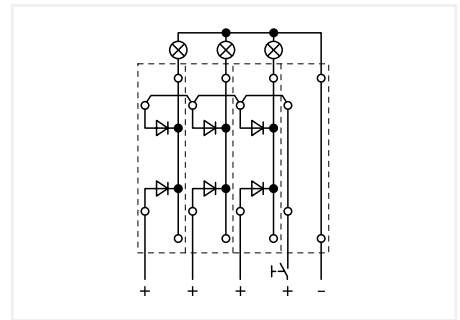

Lamp test circuits can be created using the following terminal blocks:
870-542/281-487 or 870-542/281-488

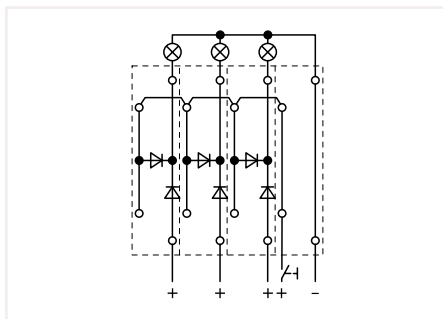

Lamp test circuits can be created using the following terminal blocks:
870-541/281-492 or 870-541/281-491

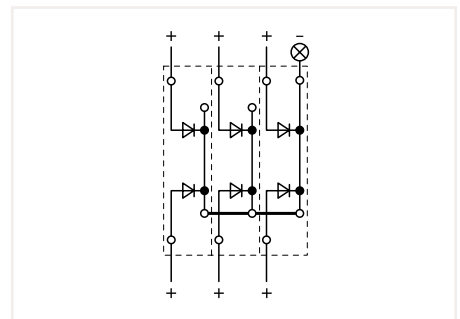

Collective fault signals can be created using the following terminal blocks:
870-541/281-489 or 870-541/281-490

Double-deck diode terminal blocks were specifically developed for custom diode circuits, such as lamp test and collective fault signal circuits. Using LED terminal blocks, monitoring units can be designed, e.g., for control and operating circuits. These terminal blocks provide high-density wiring in a width of just 5 mm.

Push-in type jumper bars provide additional options for custom circuit design.

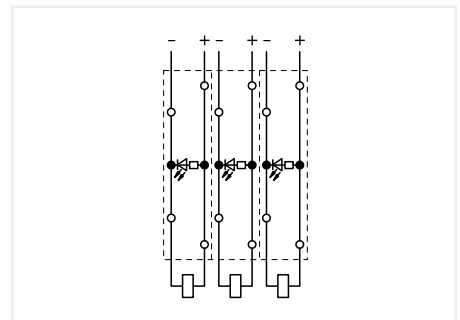

Circuit-related voltage indications can be created using the following terminal blocks:
870-543/281-434 or 870-543/281-413

Triple-Deck Diode Terminal Block and LED Terminal Block 2.5 (4 "f-st") mm²; 870 Series

Technical Data

0.08 ... 2.5 (4 "f-st") mm² ① | 28 ... 12 AWG

U_N 250 V; U_{RM} 1000 V

1N4007 – 0.5 A continuous current

Terminal block width: 5 mm / 0.197 inch

6 ... 7 mm / 0.24 ... 0.28 inch

Technical Data

0.08 ... 2.5 (4 "f-st") mm² ① | 28 ... 12 AWG

U_N 250 V; U_{RM} 1000 V

1N4007 – 0.5 A continuous current

Terminal block width: 5 mm / 0.197 inch

6 ... 7 mm / 0.24 ... 0.28 inch

Technical Data

0.08 ... 2.5 (4 "f-st") mm² ① | 28 ... 12 AWG

24 VDC

I_F 0.025 A max.

Terminal block width: 5 mm / 0.197 inch

6 ... 7 mm / 0.24 ... 0.28 inch

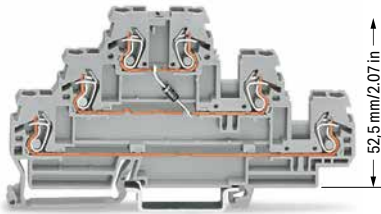

106 mm/4.17 in

280-590/281-410

280-590/281-411

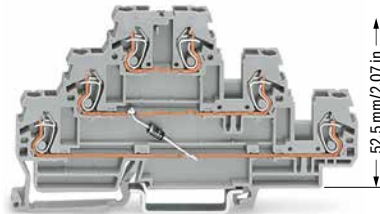

106 mm/4.17 in

280-590/281-675

280-590/281-676

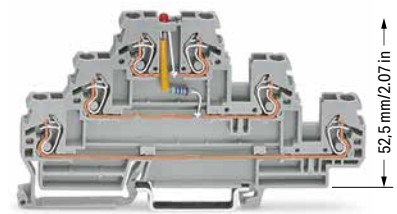

106 mm/4.17 in

280-593/281-434

280-593/281-413

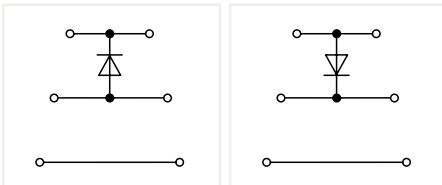

Double-deck diode terminal block; with 1N4007 diode

Color	Item No.	Pack. Unit
○ gray	870-590/281-410	50
○ gray	870-590/281-411	50

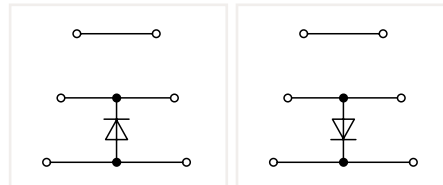

Double-deck diode terminal block; with two 1N4007 diodes

Color	Item No.	Pack. Unit
○ gray	870-590/281-675	50
○ gray	870-590/281-676	50

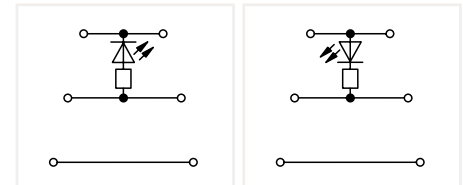

Double-deck LED terminal block; with red LED

Color	Item No.	Pack. Unit
○ gray	870-593/281-434	50
○ gray	870-593/281-413	50

Other terminal blocks with the same profile:

Through	870-551	Page 434
---------	---------	----------

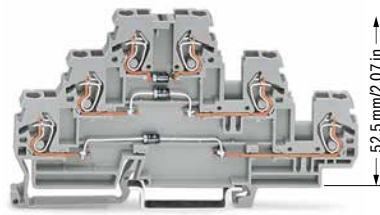

106 mm/4.17 in

280-596/281-673

280-596/281-674

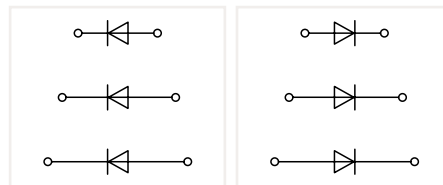

Double-deck diode terminal block; with two 1N4007 diodes

Color	Item No.	Pack. Unit
○ gray	870-596/281-673	50
○ gray	870-596/281-674	50

7

1 Max. insulation diameter: 4.4 mm

See application notes for:
Insulation stop, see page 346
Group marker carrier, page 435

Approvals and corresponding ratings,
visit www.wago.com

Accessories; 870 Series

Appropriate marking systems:
Mini-WSB/Mini-WSB Inline/WMB/WMB Inline

End and intermediate plate; 2 mm thick

	orange	870-569	100 (25)
	gray	870-568	100 (25)

Insulation stop; 0.08 ... 0.2 mm² "s" (0.14 mm² "f-st"); 5 pcs/strip

	white	280-470	200 (25)
---	-------	---------	----------

Insulation stop; 0.25 ... 0.5 mm²; 5 pcs/strip

	light gray	280-471	200 (25)
---	------------	---------	----------

Insulation stop; 0.75 ... 1 mm²; 5 pcs/strip

	dark gray	280-472	200 (25)
---	-----------	---------	----------

Protective warning marker; with black high-voltage symbol; for 5 terminal blocks

	yellow	280-405	100 (25)
---	--------	---------	----------

Push-in type jumper bar; insulated; I_N 18 A; light gray

	2-way	870-402	200 (25)
	3-way	870-403	200 (25)
	4-way	870-404	100 (25)
	5-way	870-405	100 (25)
	6-way	870-406	100 (25)
	7-way	870-407	100 (25)
	8-way	870-408	100 (25)
	9-way	870-409	100 (25)
	10-way	870-410	50 (25)

Push-in type jumper bar; insulated; I_N 18 A; light gray

	1 to 3	870-433	200 (25)
	1 to 4	870-434	200 (25)
	1 to 5	870-435	100 (25)
	1 to 6	870-436	100 (25)
	1 to 7	870-437	100 (25)
	1 to 8	870-438	100 (25)
	1 to 9	870-439	100 (25)
	1 to 10	870-440	50 (25)

Marking strip; plain; 7.5 mm wide; 1 m long

	translucent	709-196	1
---	-------------	---------	---

Mini-WSB marking card; white; 10 strips with 10 markers/ card; 5 mm wide markers

	plain	248-501	5
---	-------	---------	---

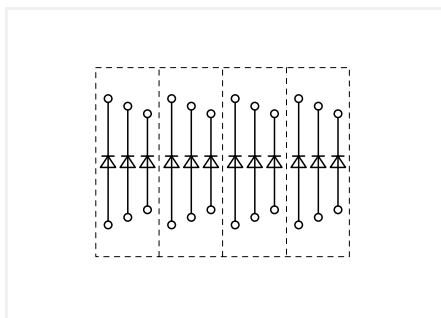

Triple-deck diode terminal blocks were specifically developed for custom diode circuits, such as lamp test and collective fault signal circuits.

Using LED terminal blocks, monitoring units can be designed, e.g., for control and operating circuits.

These terminal blocks provide high-density wiring in a width of just 5 mm.

Push-in type jumper bars provide additional options for custom circuit design.

Sold & Serviced By:



Toll Free Phone (877) SERV098
www.electromate.com
sales@electromate.com

Pluggable Tap-Off Modules 870 Series Description and Installation



Snapping tap-off and spacer modules together to assemble a multipole tap-off module (max. 10 poles).



Module assembly with CAGE CLAMP® connections (0.25 ... 2.5 mm²/24 ... 14 AWG), including strain relief plate and marker slots for Mini-WSB or WMB markers.

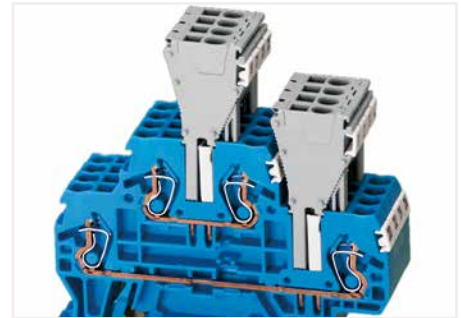

The tap-off module assembly can be directly plugged into the jumper contact slot of the current bar. The terminal blocks can also be commoned via push-in type jumper bars parallel to the jumper slots being used by the modules.



CAGE CLAMP® termination:
Tap-off modules are used when additional or removable connections are required (can be used as a permanent connection or a test plug). Wiring is possible whether the modules are plugged into the assembly or not.

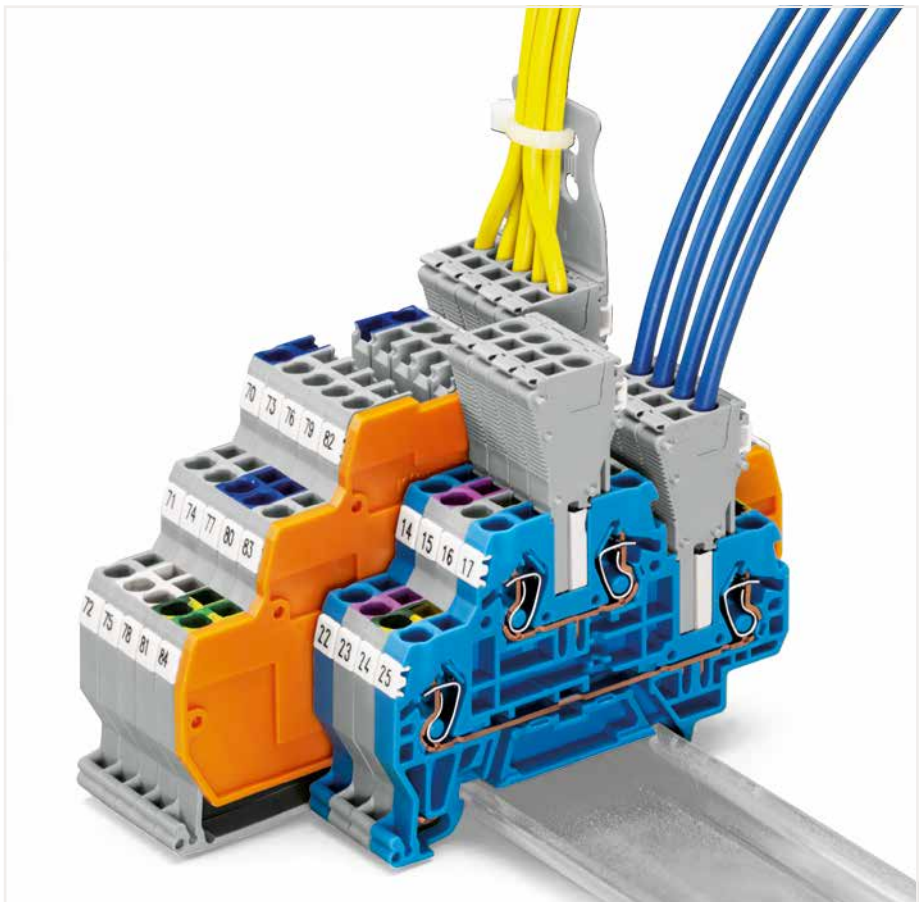

7

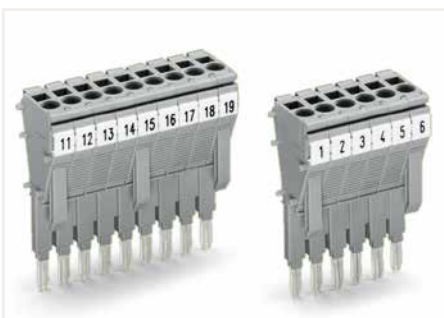

Using anti-reverse mating modules at both ends of a module assembly prevents reverse mating.



Three anti-reverse mating modules are necessary when snapping more than seven tap-off modules together.



Testing is also possible using a pre-wired tap-off module assembly in the very same way as test plugs.



CAGE CLAMP® terminates the following copper conductors: solid



stranded



fine-stranded, also with tinned single strands

Pluggable Tap-Off Module 870 Series

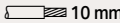
Technical Data	
0.25 ... 2.5 mm ²	22 ... 14 AWG
500 V/6 kV/3 ①	
I _N 18 A	
Module width: 5 mm / 0.197 inch	
 10 mm / 0.38 inch	

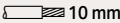
Technical Data	
0.25 ... 2.5 mm ²	22 ... 14 AWG
500 V/6 kV/3 ①	
I _N 10 A	
Module width: 5 mm / 0.197 inch	
 10 mm / 0.38 inch	

- ① 500 V = rated voltage
6 kV = rated impulse voltage
3 = pollution degree
(see Section 14)

Approvals and corresponding ratings,
visit www.wago.com



Pluggable tap-off module; with anti-reverse mating protection; snaps together; for 870 Series Rail-Mount Terminal Blocks with jumper slots in the current bar		
Color	Item No.	Pack. Unit
 gray	870-425	100 (25)

Pluggable tap-off module; snaps together; for 870 Series Rail-Mount Terminal Blocks with jumper slots in the current bar		
Color	Item No.	Pack. Unit
 gray	870-426	100 (25)

Spacer module; snaps together; bridges terminal blocks		
Color	Item No.	Pack. Unit
 gray	870-427	100 (25)

Accessories; for pluggable tap-off modules

Appropriate marking systems: Mini-WSB/Mini-WSB Inline/WMB/WMB Inline

Strain relief plate; gray			
	35 mm wide	734-326	100 (25)
	6 mm wide	734-327	100 (25)
	12.5 mm wide	734-328	100 (25)
	25 mm wide	734-329	100 (25)

Mini-WSB marking card; white; 10 strips with 10 markers/card; 5 mm wide markers			
	plain	248-501	5

Mini-WSB marking card; plain; 10 strips with 10 markers/card; 5 mm wide markers			
	yellow	248-501/000-002	5
	red	248-501/000-005	5
	blue	248-501/000-006	5
	gray	248-501/000-007	5
	orange	248-501/000-012	5
	light green	248-501/000-017	5
	green	248-501/000-023	5
	violet	248-501/000-024	5

WMB marking card; white; 10 strips with 10 markers/card; stretchable 5 ... 5.2 mm			
	plain	793-5501	5

WMB marking card; plain; 10 strips with 10 markers/card; stretchable 5 ... 5.2 mm			
	yellow	793-5501/000-002	5
	red	793-5501/000-005	5
	blue	793-5501/000-006	5
	gray	793-5501/000-007	5
	orange	793-5501/000-012	5
	light green	793-5501/000-017	5
	green	793-5501/000-023	5
	violet	793-5501/000-024	5

WMB marking card; white; 10 strips with 10 markers/card; for 5 ... 17.5 mm terminal block width			
	plain	793-501	5

WMB marking card; plain; 10 strips with 10 markers/card; for 5 ... 17.5 mm terminal block width			
	yellow	793-501/000-002	5
	red	793-501/000-005	5
	blue	793-501/000-006	5
	gray	793-501/000-007	5
	orange	793-501/000-012	5
	light green	793-501/000-017	5
	green	793-501/000-023	5
	violet	793-501/000-024	5

Sensor Terminal Blocks and Actuator Terminal Blocks

270 Series

Description and Installation

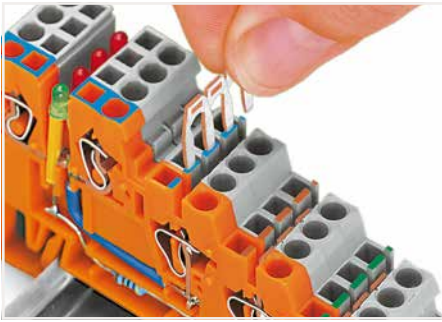

Inserting a jumper.

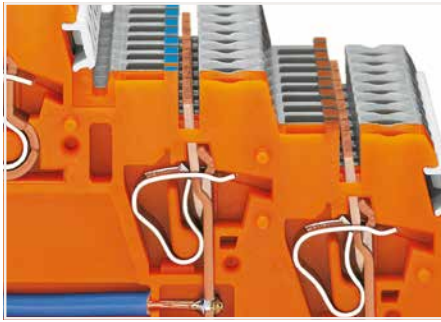

Commoning a supply voltage using un-insulated push-in type jumper bars, 2- to 9-way or 17-way (2 x 8 bits), depending on application.



Commoning signal level voltage via insulated push-in type jumper bars (870 Series) – 2- to 9-way, depending on application. Sensor LED terminal blocks cannot be commoned!



Terminal block assembly: Sensor terminal blocks

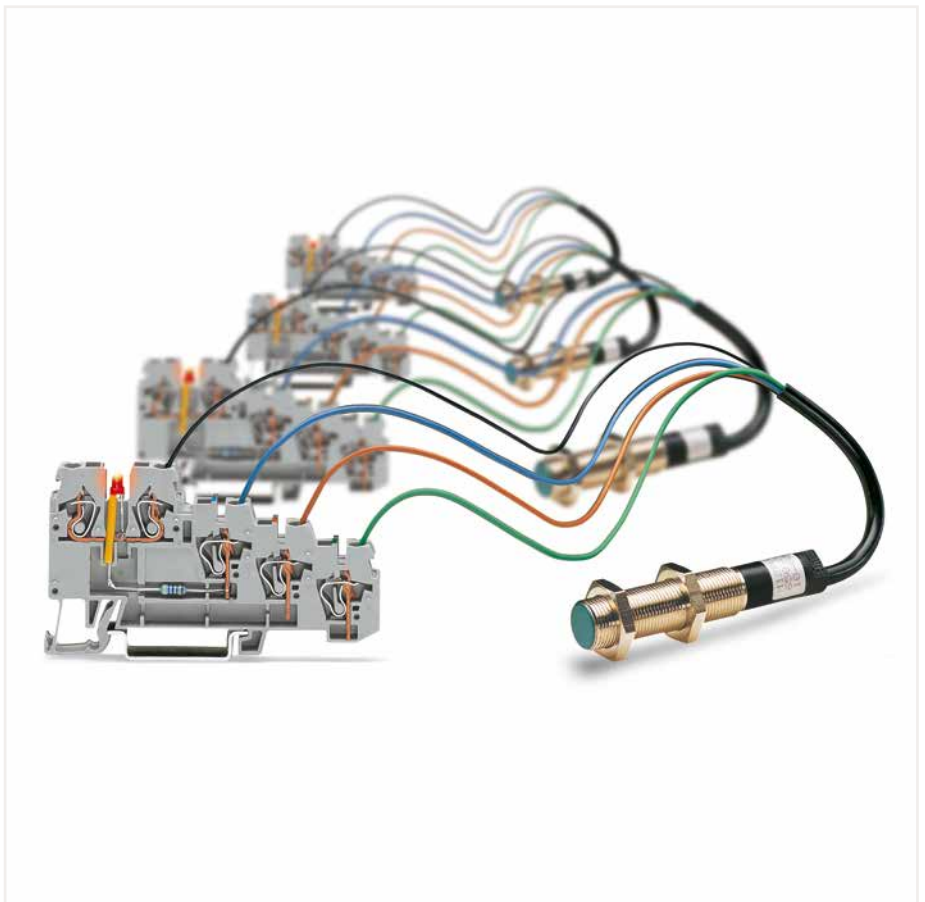

7



Terminal block assembly: Sensor LED terminal blocks



Marking strip (Item No. 709-196)
Not suitable for LED terminal blocks!

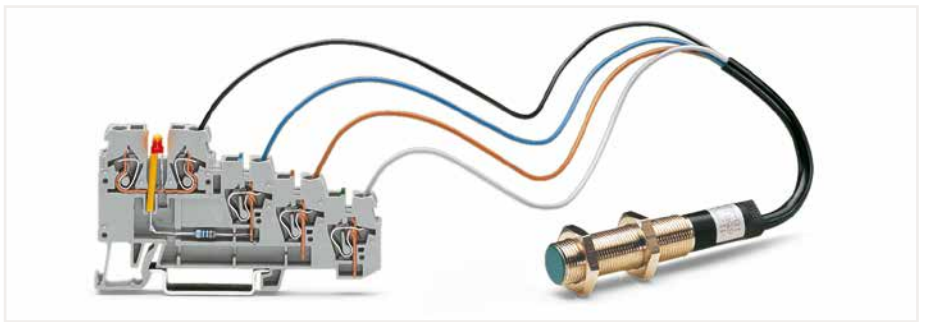

Sensor LED terminal block

CAGE CLAMP® terminates the following copper conductors:
solid stranded

fine-stranded, also with tinned single strands

fine-stranded, tip-bonded

fine-stranded, with ferrule (gastight crimped)

fine-stranded, with pin terminal (gastight crimped)

For aluminum conductors, see notes in Section 14. With ferruled conductors, it is necessary to use a terminal block one size smaller than the conductor's nominal cross section.

4-Conductor Sensor Terminal Block and 4-Conductor Sensor LED Terminal Block 2.5 mm²; 270 Series

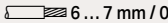
Technical Data	
0.08 ... 2.5 mm ²	28 ... 12 AWG*
250 V/4 kV/3 ①	300 V, 20 A ②
I _N 18 A ②	300 V, 10 A ③
Terminal block width: 5 mm / 0.197 inch	
 6 ... 7 mm / 0.24 ... 0.28 inch	

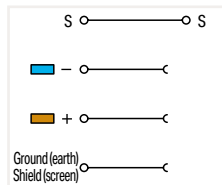
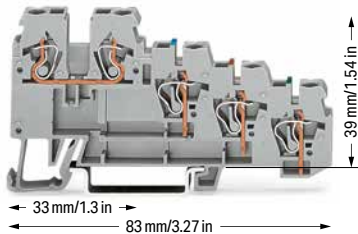

4-conductor sensor terminal block		
Color	Item No.	Pack. Unit
○ gray	270-570	50

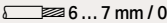
Technical Data	
0.08 ... 2.5 mm ²	28 ... 12 AWG*
24 VDC ③	
Terminal block width: 5 mm / 0.197 inch	
 6 ... 7 mm / 0.24 ... 0.28 inch	

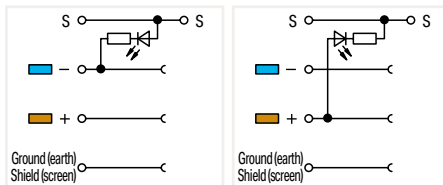
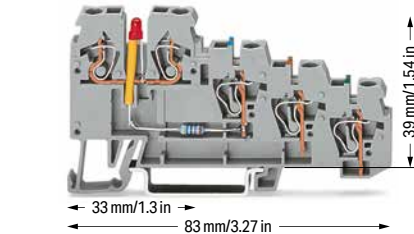

4-conductor sensor LED terminal block; for PNP (high-side) switching sensors; Red LED		
Color	Item No.	Pack. Unit
○ gray	270-570/281-434	50

4-conductor sensor LED terminal block; for NPN (low-side) switching sensors; Yellow LED		
Color	Item No.	Pack. Unit
○ gray	270-570/281-507	50

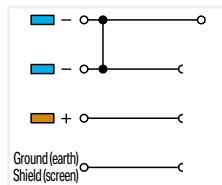
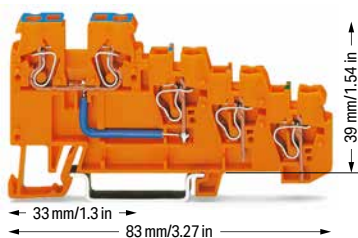

4-conductor sensor supply terminal block; Internal bridge: 9 A		
Color	Item No.	Pack. Unit
○ orange	270-574	10

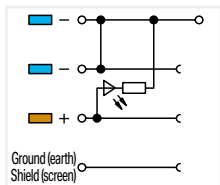
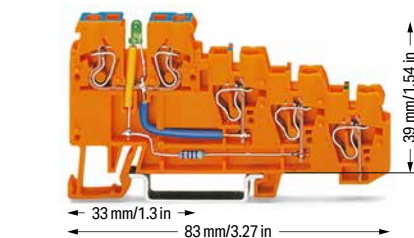

4-conductor sensor LED supply terminal block; Green LED		
Color	Item No.	Pack. Unit
○ orange	870-574/281-483	10

*12 AWG: THHN, THWN

- ① 250 V = rated voltage
4 kV = rated impulse voltage
3 = pollution degree (see Section 14)
 - ② Internal bridge: 9 A
 - ③ Other voltages are available upon request.
LED power consumption: 4.8 mA
- See application notes for:
Insulation stop, see page 346
Marking, from page 589
- Approvals and corresponding ratings,
visit www.wago.com

Accessories; 870 Series

Appropriate marking systems:
Mini-WSB/Mini-WSB Inline/WMB/WMB Inline

End and intermediate plate; 1 mm thick; for quadruple-deck terminal blocks

	orange	270-322	100 (25)
	gray	270-320	100 (25)

Insulation stop; 0.08 ... 0.2 mm² "s" (0.14 mm² "f-st"); 5 pcs/strip

	white	280-470	200 (25)
---	-------	---------	----------

Insulation stop; 0.25 ... 0.5 mm²; 5 pcs/strip

	light gray	280-471	200 (25)
---	------------	---------	----------









Insulation stop; 0.75 ... 1 mm²; 5 pcs/strip

	dark gray	280-472	200 (25)
---	-----------	---------	----------

Push-in type jumper bar; uninsulated; I_N 18 A
Jumpers can be shortened using an electronic side cutter.

	9-way	270-409	200 (25)
	17-way	270-417	200 (25)
	80-way	270-480	100 (25)

Push-in type jumper bar; insulated; I_N 18 A; light gray

	2-way	870-402	200 (25)
	3-way	870-403	200 (25)
	4-way	870-404	100 (25)
	5-way	870-405	100 (25)
	6-way	870-406	100 (25)
	7-way	870-407	100 (25)
	8-way	870-408	100 (25)
	9-way	870-409	50 (25)

Mini-WSB marking card; white; 10 strips with 10 markers/card; 5 mm wide markers

	plain	248-501	5
---	-------	---------	---

WMB marking card; white; 10 strips with 10 markers/card; stretchable 5 ... 5.2 mm

	plain	793-5501	5
---	-------	----------	---

Operating tool with a partially insulated shaft; Type 2; (3.5 x 0.5) mm blade

		210-720	1
---	--	---------	---

3-Conductor Sensor Terminal Block and 3-Conductor Sensor LED Terminal Block 2.5 mm²; 270 Series

Technical Data	
0.08 ... 2.5 mm ²	28 ... 12 AWG*
250 V/4 kV/3 ①	300 V, 20 A ②
I _N 18 A ②	300 V, 10 A ③
Terminal block width: 5 mm / 0.197 inch	
6 ... 7 mm / 0.24 ... 0.28 inch	

Technical Data	
0.08 ... 2.5 mm ²	28 ... 12 AWG*
24 VDC ③	
Terminal block width: 5 mm / 0.197 inch	
6 ... 7 mm / 0.24 ... 0.28 inch	

Technical Data	
0.08 ... 2.5 mm ²	28 ... 12 AWG*
24 VDC ③	
Terminal block width: 5 mm / 0.197 inch	
6 ... 7 mm / 0.24 ... 0.28 inch	

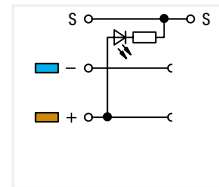
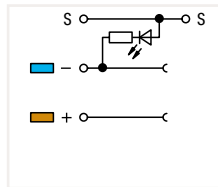
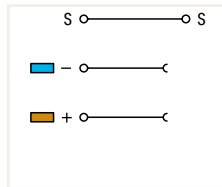
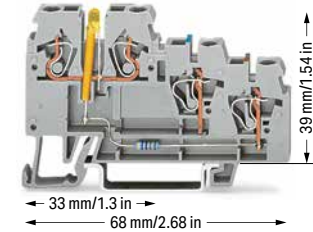
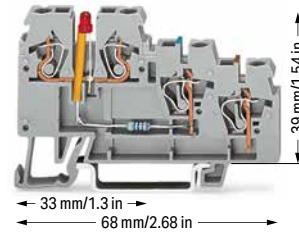
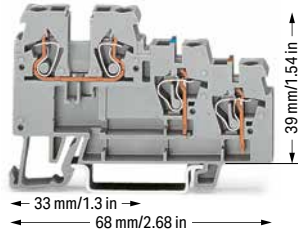

3-conductor sensor terminal block		
Color	Item No.	Pack. Unit
○ gray	270-560	50

3-conductor sensor LED terminal block; for PNP (high-side) switching sensors; Red LED		
Color	Item No.	Pack. Unit
○ gray	270-560/281-434	50

3-conductor sensor LED terminal block; for NPN (low-side) switching sensors; Yellow LED		
Color	Item No.	Pack. Unit
○ gray	270-560/281-507	50

7

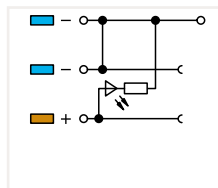
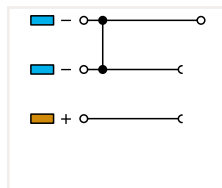
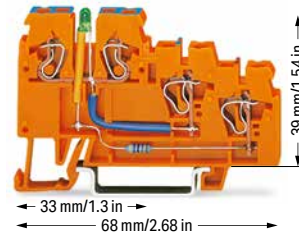
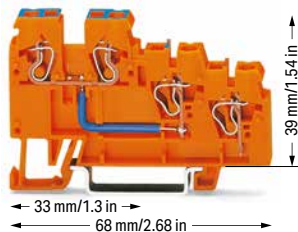

3-conductor sensor supply terminal block; Internal bridge: 9 A		
Color	Item No.	Pack. Unit
○ gray	270-564	10

3-conductor sensor LED supply terminal block; Green LED		
Color	Item No.	Pack. Unit
○ gray	270-564/281-483	10

Pluggable tap-off modules (Item No. 870-425, 870-426, 870-427) can be used on the signal level.

3-Conductor Actuator Terminal Block and 3-Conductor Actuator LED Terminal Block 2.5 mm²; 270 Series

Technical Data	
0.08 ... 2.5 mm ²	28 ... 12 AWG*
250 V/4 kV/3 ①	300 V, 20 A ②
I _N 18 A ②	300 V, 10 A ③
Terminal block width: 5 mm / 0.197 inch	
6 ... 7 mm / 0.24 ... 0.28 inch	

Technical Data	
0.08 ... 2.5 mm ²	28 ... 12 AWG*
24 VDC ③	
Terminal block width: 5 mm / 0.197 inch	
6 ... 7 mm / 0.24 ... 0.28 inch	

- *12 AWG: THHN, THWN
- ① 250 V = rated voltage
4 kV = rated impulse voltage
3 = pollution degree (see Section 14)
- ② Other voltages are available upon request.
LED power consumption: 4.8 mA
- See application notes for:
Insulation stop, page 331
Marking, from page 589
- Approvals and corresponding ratings, visit www.wago.com

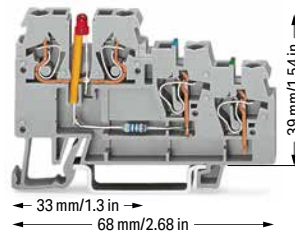
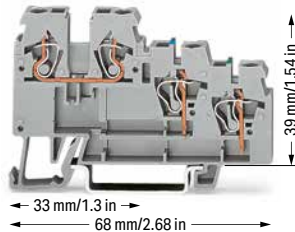

270-572

270-585

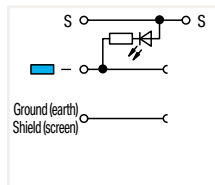
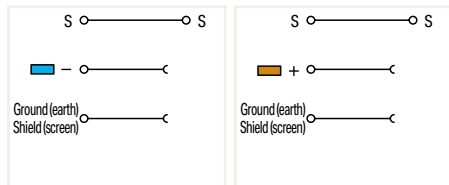

3-conductor actuator terminal block		
Color	Item No.	Pack. Unit
○ gray	270-572	50

3-conductor actuator LED terminal block; for PNP (high-side) switching actuators; Red LED		
Color	Item No.	Pack. Unit
○ gray	270-572/281-434	50

3-conductor actuator terminal block		
Color	Item No.	Pack. Unit
○ gray	270-585	50

Accessories; 870 Series
Appropriate marking systems:
Mini-WSB/Mini-WSB Inline/WMB/WMB Inline

End and intermediate plate; 1 mm thick; for triple-deck terminal blocks

orange	270-321	100 (25)
gray	270-319	100 (25)

Insulation stop; 0.08 ... 0.2 mm² "s" (0.14 mm² "f-st"); 5 pcs/strip

white	280-470	200 (25)
-------	---------	----------

Insulation stop; 0.25 ... 0.5 mm²; 5 pcs/strip

light gray	280-471	200 (25)
------------	---------	----------

Insulation stop; 0.75 ... 1 mm²; 5 pcs/strip

dark gray	280-472	200 (25)
-----------	---------	----------

Push-in type jumper bar; uninsulated; I_N 18 A
Jumpers can be shortened using an electronic side cutter.

9-way	270-409	200 (25)
17-way	270-417	200 (25)
80-way	270-480	100 (25)

Push-in type jumper bar; insulated; I_N 18 A; light gray

2-way	870-402	200 (25)
3-way	870-403	200 (25)
4-way	870-404	100 (25)
5-way	870-405	100 (25)
6-way	870-406	100 (25)
7-way	870-407	100 (25)
8-way	870-408	100 (25)
9-way	870-409	50 (25)

Mini-WSB marking card; white; 10 strips with 10 markers/card; 5 mm wide markers

plain	248-501	5
-------	---------	---

WMB marking card; white; 10 strips with 10 markers/card; stretchable 5 ... 5.2 mm

plain	793-5501	5
-------	----------	---

Operating tool with a partially insulated shaft; Type 2; (3.5 x 0.5) mm blade

	210-720	1
--	---------	---

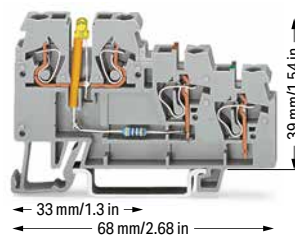
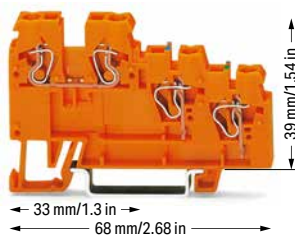

270-577

270-586

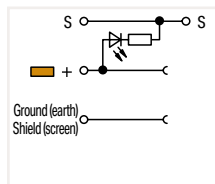
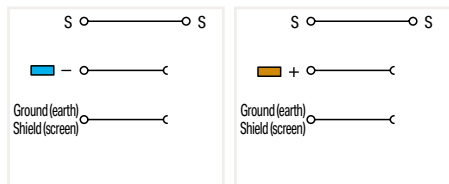

3-conductor actuator supply terminal block		
Color	Item No.	Pack. Unit
○ orange	270-577	10





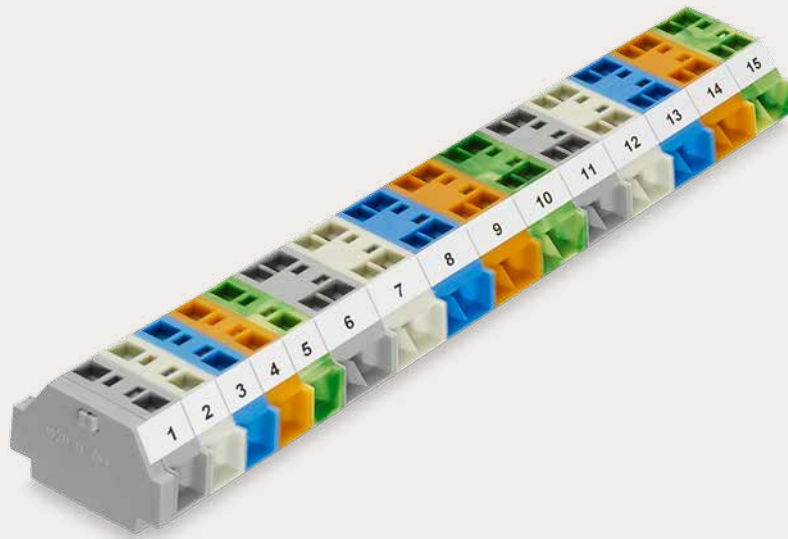

3-conductor actuator LED terminal block; for NPN (low-side) switching actuators; Yellow LED		
Color	Item No.	Pack. Unit
○ gray	270-585/281-507	50

3-conductor actuator supply terminal block		
Color	Item No.	Pack. Unit
○ orange	270-586	10



WAGO Modular Terminal Blocks and WAGO Terminal Strips

WAGO Modular Terminal Blocks and WAGO Terminal Strips Side-/Front-Entry Wiring

			Page
	Modular Terminal Blocks and Terminal Strips; with Mounting Flanges or Snap-In Mounting Feet – Front-Entry Wiring 2.5 (4 "f-st") mm ² (12 AWG)	869 Series	449
	Modular Terminal Blocks and Terminal Strips; with Mounting Flanges or Snap-In Mounting Feet – Front-Entry Wiring 2.5 mm ² (14 AWG)	264 Series	454
	Modular Terminal Blocks and Terminal Strips; with Mounting Flanges or Snap-In Mounting Feet – Side-Entry Wiring 0.08 ... 1.5 mm ² (28 ... 16 AWG) / 2.5 mm ² (14 AWG) / 4 mm ² (12 AWG)	260/261/262 Series	460
	Modular Terminal Blocks and Terminal Strips; with Push-Buttons on One or Both Sides 0.08 ... 1.5 mm ² (28 ... 16 AWG)	261 Series	464
	Modular Terminal Blocks and Terminal Strips with Mini-WSB Marker Slot and Push-Buttons on One or Both Sides 1.5 mm ² (16 AWG)	261 Series	468
	Accessories for Modular Terminal Blocks and Terminal Strips	260/261/262 Series	474

Sold & Serviced By:

 **ELECTROMATE**

Toll Free Phone (877) SERV098
www.electromate.com
sales@electromate.com

Modular Terminal Blocks and Terminal Strips

869 Series

Description and Installation

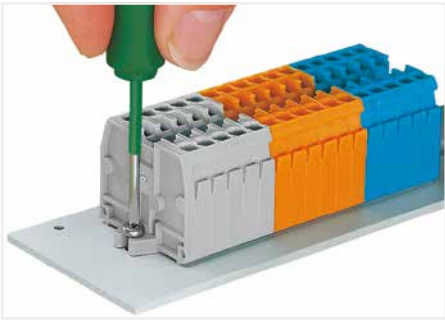

Mounting and securing a terminal strip directly to the plate via screw-type flanges.

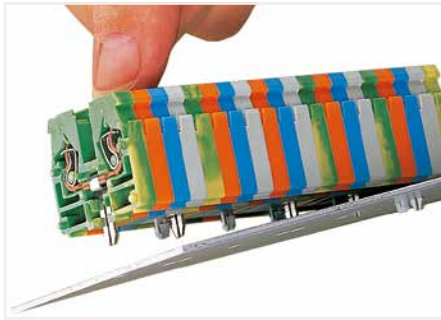

Mounting a terminal strip with snap-in feet into holes.



Mounting a terminal strip with snap-in feet onto the aluminum rail.

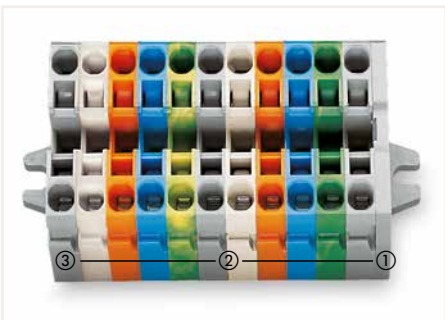

Terminal strip with mounting flanges:

- End plate with mounting flange ①
- Center terminal blocks ②
- End terminal block with mounting flange ③

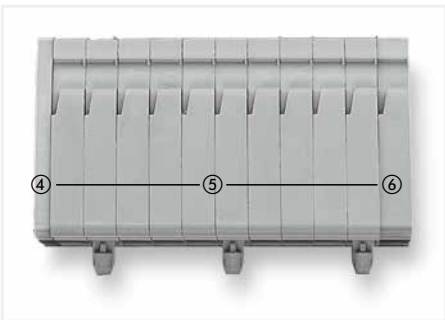

Terminal strip with snap-in mounting feet:

- End plate ④
- Center terminal blocks with/without snap-in mounting feet ⑤
- End terminal block with/without snap-in mounting foot ⑥

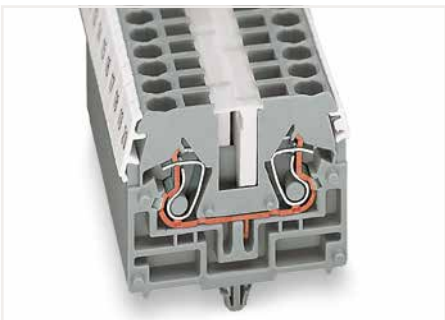

WMB markers in Mini-WSB marker slots
Translucent marking strip
Mini-WSB markers



Push jumper bars down firmly until fully inserted. When using multipole bars, push alternately on the right and then left side until installed.
Push-in type jumper bars 1-3-5-7 or 1-4-7 are available upon request.



Protective warning marker (280-405); with a black high-voltage symbol

CAGE CLAMP® terminates the following copper conductors:
solid stranded

fine-stranded,
also with tinned
single strands

fine-stranded,
tip-bonded

fine-stranded,
with ferrule
(gastight crimped)

fine-stranded,
with pin terminal
(gastight crimped)

For aluminum conductors, see notes in Section 14. With ferruled conductors, it is necessary to use a terminal block one size smaller than the conductor's nominal cross section.

Compact Terminal Strips; with Mounting Flanges or Snap-in Mounting Feet 2.5 (4 "f-st") mm²; 870 Series

Technical Data	
0.08 ... 2.5 (4 "f-st") mm ²	28 ... 12 AWG
500 V/6 kV/3	300 V, 20 A
I _N 24 A	
Pole width: 5 mm / 0.197 inch	
6 ... 7 mm / 0.24 ... 0.28 inch	

Technical Data	
0.08 ... 2.5 (4 "f-st") mm ² ①	28 ... 12 AWG
500 V/6 kV/3 ②	300 V, 20 A
I _N 24 A	
Pole width: 5 mm / 0.197 inch	
6 ... 7 mm / 0.24 ... 0.28 inch	

Technical Data	
0.08 ... 2.5 (4 "f-st") mm ² ①	28 ... 12 AWG
500 V/6 kV/3 ②	300 V, 20 A
I _N 24 A	
Pole width: 5 mm / 0.197 inch	
6 ... 7 mm / 0.24 ... 0.28 inch	



Compact terminal strip; with M3 mounting flanges; for screw or similar mounting types; 3.2 mm mounting hole diameter; gray

Pole No.	Item No.	Pack. Unit
○ 2	869-102	100
○ 3	869-103	100
○ 4	869-104	100
○ 5	869-105	100
○ 6	869-106	50
○ 7	869-107	50
○ 8	869-108	50
○ 9	869-109	50
○ 10	869-110	50
○ 11	869-111	25
○ 12 ①	869-112	25

Compact terminal strip; with M4 mounting flanges; for screw or similar mounting types; 4.2 mm mounting hole diameter; gray

Pole No.	Item No.	Pack. Unit
○ 2	869-202	100
○ 3	869-203	100
○ 4	869-204	100
○ 5	869-205	100
○ 6	869-206	50
○ 7	869-207	50
○ 8	869-208	50
○ 9	869-209	50
○ 10	869-210	25
○ 11	869-211	25
○ 12 ①	869-212	25

Compact terminal strip; with snap-in mounting feet; for 0.6 ... 1.2 mm plate thickness; 3.5 + 0.1 mm mounting hole diameter; gray

Pole No.	Item No.	Pack. Unit
○ 2	869-152	100
○ 3	869-153	100
○ 4	869-154	100
○ 5	869-155	100
○ 6	869-156	50
○ 7	869-157	50
○ 8	869-158	50
○ 9	869-159	50
○ 10	869-160	25
○ 11	869-161	25
○ 12 ①	869-162	25

light gray		
○ 2	869-132	100
○ 3	869-133	100
○ 4	869-134	100
○ 5	869-135	100
○ 6	869-136	50
○ 7	869-137	50
○ 8	869-138	50
○ 9	869-139	50
○ 10	869-140	25
○ 11	869-141	25
○ 12 ①	869-142	25

light gray		
○ 2	869-232	100
○ 3	869-233	100
○ 4	869-234	100
○ 5	869-235	100
○ 6	869-236	50
○ 7	869-237	50
○ 8	869-238	50
○ 9	869-239	50
○ 10	869-240	25
○ 11	869-241	25
○ 12 ①	869-242	25

light gray		
○ 2	869-182	100
○ 3	869-183	100
○ 4	869-184	100
○ 5	869-185	100
○ 6	869-186	50
○ 7	869-187	50
○ 8	869-188	50
○ 9	869-189	50
○ 10	869-190	25
○ 11	869-191	25
○ 12 ①	869-192	25

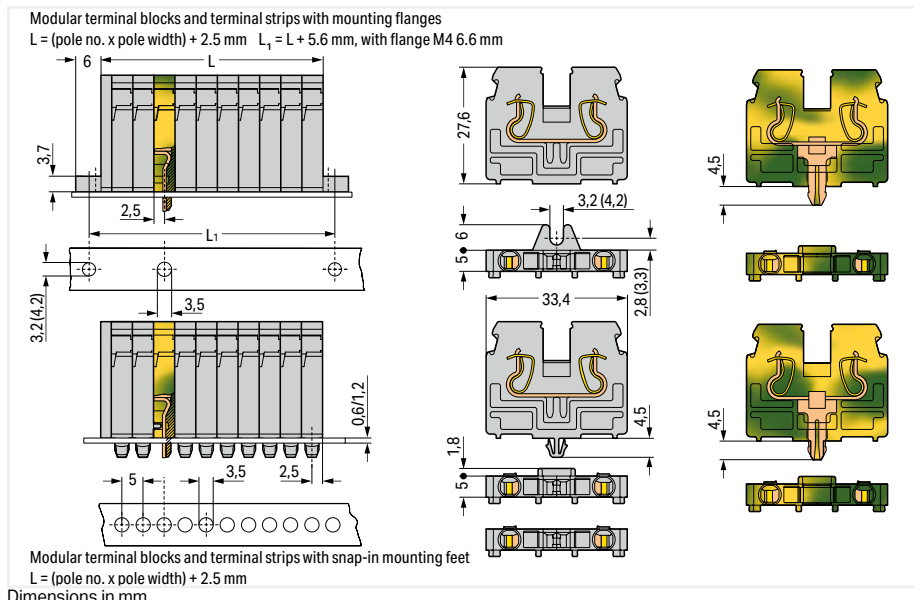

- ① Longer strips and/or mixed-color assemblies are available upon request.
- Item no. suffixes for gray terminal strips in:
 - blue .../000-006 ②
 - green-yellow .../000-016
 - 869-102 ... 869-112
 - 869-202 ... 869-212
 - 869-152 ... 869-162
- ② Terminal strips with a blue insulated housing are suitable for Ex i applications.

Modular Terminal Block; with Mounting Flange or Snap-In Mounting Foot

2.5 (4 "f-st") mm²; 870 Series

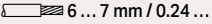
Technical Data	
0.08 ... 2.5 (4 "f-st") mm ² ①	28 ... 12 AWG
500 V/6 kV/3 ②	300 V, 20 A, $\sqrt{2}$
I _N 24 A	
Terminal block width: 5 mm / 0.197 inch	
 6 ... 7 mm / 0.24 ... 0.28 inch	

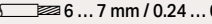
Technical Data	
0.08 ... 2.5 (4 "f-st") mm ² ①	28 ... 12 AWG
500 V/6 kV/3 ②	300 V, 20 A, $\sqrt{2}$
I _N 24 A	
Terminal block width: 5 mm / 0.197 inch	
 6 ... 7 mm / 0.24 ... 0.28 inch	

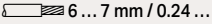
Technical Data	
0.08 ... 2.5 (4 "f-st") mm ² ①	28 ... 12 AWG
500 V/6 kV/3 ②	300 V, 20 A, $\sqrt{2}$
I _N 24 A	
Terminal block width: 5 mm / 0.197 inch	
 6 ... 7 mm / 0.24 ... 0.28 inch	



Center terminal block; without snap-in mounting foot; for 0.6 ... 1.2 mm plate thickness; required between end plate and end terminal block for terminal strips with mounting flanges

Color	Item No.	Pack. Unit
gray	869-321	100
blue	869-324 ③	100
orange	869-326	100
green-yellow	869-327	100
light gray	869-329	100

End terminal block; with M3 mounting flange; for screw or similar mounting types; 3.2 mm mounting hole diameter

Color	Item No.	Pack. Unit
gray	869-301	100
blue	869-304 ③	100
green-yellow	869-307	100
light gray	869-309	100

End terminal block; with snap-in mounting foot; for 0.6 ... 1.2 mm plate thickness; 3.5 + 0.1 mm mounting hole diameter

Color	Item No.	Pack. Unit
gray	869-331	100
blue	869-334 ③	100
green-yellow	869-337	100
light gray	869-339	100

Center terminal block; with direct ground contact; 3.5 + 0.1 mm drilled hole diameter; required between end plate and end terminal block for terminal strips with mounting flanges

Notice: Terminal block cannot be commoned!

green-yellow	869-328	100
--------------	---------	-----

End terminal block; with M4 mounting flange; for screw or similar mounting types; 4.2 mm mounting hole diameter

Color	Item No.	Pack. Unit
gray	869-351	100
blue	869-354 ③	100
green-yellow	869-357	100
light gray	869-359	100

End terminal block; without snap-in mounting foot; for 0.6 ... 1.2 mm plate thickness

Color	Item No.	Pack. Unit
gray	869-341	100
blue	869-344 ③	100
green-yellow	869-347	100
light gray	869-349	100

Accessories; item-specific

Aluminum mounting rail; 1000 mm long; 18 mm wide; 7 mm high

210-154 1



Plastic end stop; with WSB marker slot; for aluminum rail (210-154); 6 mm wide

209-122 25



Accessories; 869 Series

Appropriate marking systems: Mini-WSB/Mini-WSB Inline/WMB/WMB Inline

End plate; with M3 mounting flange; 2.5 mm thick			
	gray	869-385	100 (25)
	blue	869-388	100 (25)
	green-yellow	869-389	100 (25)
	light gray	869-387	100 (25)

End plate; with M4 mounting flange; 2.5 mm thick			
	gray	869-395	100 (25)
	blue	869-398	100 (25)
	green-yellow	869-399	100 (25)
	light gray	869-397	100 (25)

End plate; for terminal blocks with snap-in mounting foot; 2.5 mm thick			
	gray	869-375	100 (25)
	blue	869-378	100 (25)
	green-yellow	869-379	100 (25)
	light gray	869-377	100 (25)

Insulation stop; 0.08 ... 0.2 mm² "s" (0.14 mm² "f-st"); 5 pcs/strip

	white	280-470	200 (25)
---	-------	---------	----------

Insulation stop; 0.25 ... 0.5 mm²; 5 pcs/strip

	light gray	280-471	200 (25)
---	------------	---------	----------

Insulation stop; 0.75 ... 1 mm²; 5 pcs/strip

	dark gray	280-472	200 (25)
---	-----------	---------	----------

Protective warning marker; with black high-voltage symbol; for 5 terminal blocks

	yellow	280-405	100 (25)
---	--------	---------	----------

Push-in type jumper bar; insulated; I_N 18 A; light gray

	2-way	870-402	200 (25)
	3-way	870-403	200 (25)
	4-way	870-404	100 (25)
	5-way	870-405	100 (25)
	6-way	870-406	100 (25)
	7-way	870-407	100 (25)
	8-way	870-408	100 (25)
	9-way	870-409	100 (25)
	10-way	870-410	50 (25)

Test plug; with 500 mm cable; 2 mm Ø; max. 42 V

	red	210-136	50
---	-----	---------	----

Technical Data

0.08 ... 2.5 (4 "f-st") mm ² ①	28 ... 12 AWG
500 V/6 kV/3 ②	300 V, 20 A _{th}
I _N 24 A	
Terminal block width: 5 mm / 0.197 inch	
6 ... 7 mm / 0.24 ... 0.28 inch	



Center terminal block; with snap-in mounting foot; for 0.6 ... 1.2 mm plate thickness; 3.5 + 0.1 mm mounting hole diameter

Color	Item No.	Pack. Unit
○ gray	869-311	100
● blue	869-314 ③	100
● orange	869-316	100
● green-yellow	869-317	100
○ light gray	869-319	100

- ① Max. insulation diameter: 4.4 mm
 - ② 500 V = rated voltage
6 kV = rated impulse voltage
3 = pollution degree (see Section 14)
 - ③ Terminal blocks with a blue insulated housing are suitable for Ex i applications.
- See application notes for:
Insulation stop, see page 346
Group marker carrier, page 435
- Approvals and corresponding ratings, visit www.wago.com

Accessories; 869 Series
Appropriate marking systems:
Mini-WSB/Mini-WSB Inline/WMB/WMB Inline

Mini-WSB marking card; white; 10 strips with 10 markers/
card; 5 mm wide markers

	plain	248-501	5
--	-------	---------	---

Group marker carrier; fits into the jumper slot of the current bars

	gray	870-184	50 (25)
--	------	---------	---------

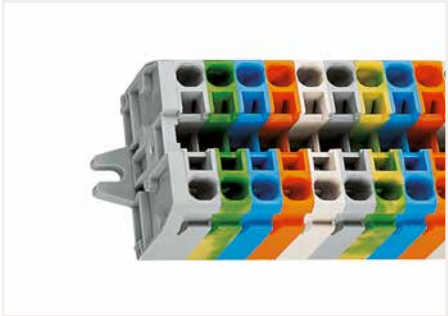

Terminal strip; with M3 or M4 mounting flanges; for screw or similar mounting types
Mounting holes:
3.2 mm Ø; M3 flange
4.2 mm Ø; M4 flange



Inserting insulation stops into conductor entry holes of terminal strip.

Accessories; item-specific
Aluminum mounting rail; 1000 mm long; 18 mm wide; 7 mm high

	210-154	1
--	---------	---

Plastic end stop; with WSB marker slot; for aluminum rail (210-154); 6 mm wide

	209-122	25
--	---------	----

Push-in type jumper bar; insulated; I_N 18 A; light gray

	1 to 3	870-433	200 (25)
	1 to 4	870-434	200 (25)
	1 to 5	870-435	100 (25)
	1 to 6	870-436	100 (25)
	1 to 7	870-437	100 (25)
	1 to 8	870-438	100 (25)
	1 to 9	870-439	100 (25)
	1 to 10	870-440	50 (25)

Marking strip; plain; 7.5 mm wide; 1 m long

	translucent	709-196	1
--	-------------	---------	---



Inserting insulation stops into conductor entry holes of terminal strip.

The wiring of programmable logic controllers and micro-processor-operated control circuits often relies on very small, fine-stranded conductors. These conductors are highly flexible and deform when pushed against the conductor stop in terminal blocks. As a result, the conductor insulation – not the copper conductor – may be clamped, causing intermittent contact or no contact at all. Common to all terminal block types currently offered, this problem creates unnecessary downtime for troubleshooting.

The solution: an insulation stop for compact terminal blocks. Insulation stops automatically bundle the cores of fine-stranded conductors when inserted into the clamping unit, preventing splaying. This also limits the conductor entry to a defined cross sectional area – ensuring the actual conductor, not the insulation, will enter the clamping unit

The insulation stop is available as dividable 5-pole strip for the 869 Series Terminal Strips.

Insulation stop usage will not affect the conductor strip lengths for the aforementioned terminal strips.

Modular Terminal Blocks and Terminal Strips

264 Series

Description and Installation

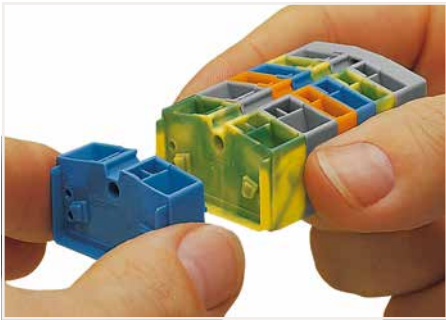

Assembling modular terminal blocks into terminal strips.

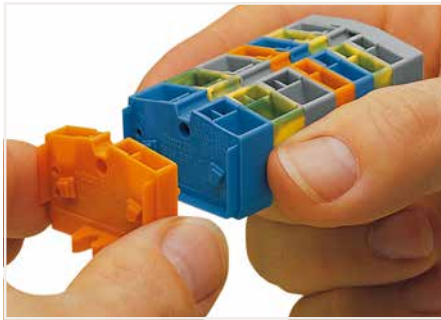

Mounting an "end terminal block" with mounting flange.

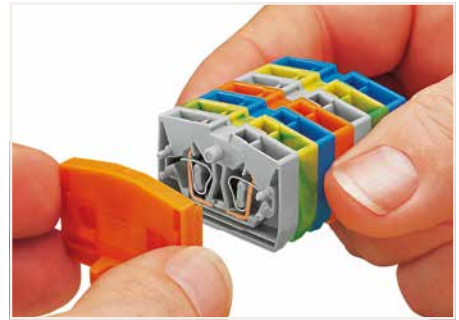

Mounting an end plate.



CAGE CLAMP® termination:
Inserting a conductor.
With ferruled conductors, it is necessary to use a terminal block one size smaller than the conductor's nominal cross section.

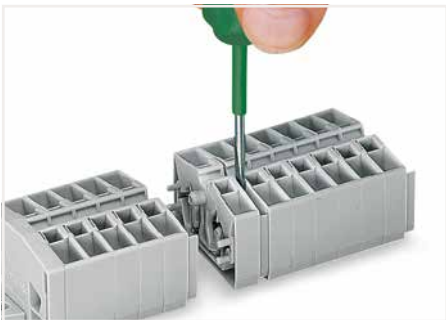

Removing a terminal block.

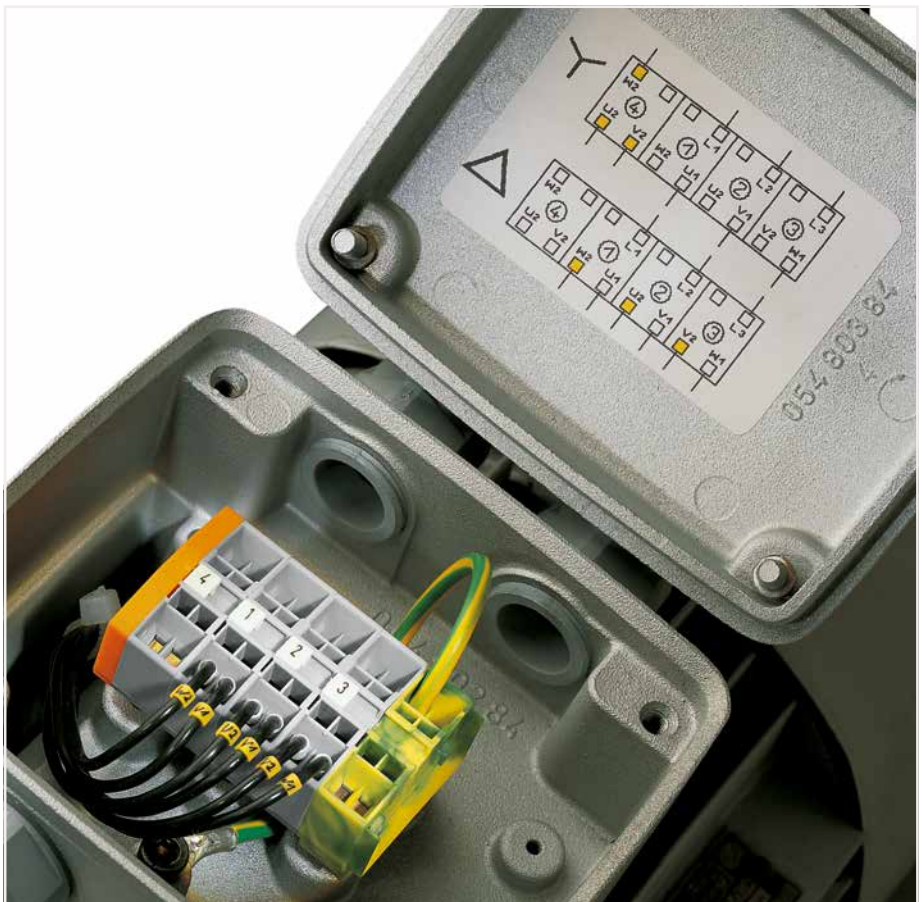

8



Commoning with comb-style jumper bar.



Marking with T-marker tag (209-290).



Combining 2- and 4-conductor terminal blocks.
Marking via Mini-WSB Quick Marking System.



CAGE CLAMP® terminates the following copper conductors:
solid



stranded



fine-stranded,
also with tinned
single strands



Mounting and securing a terminal strip directly to the plate via screw-type flanges.

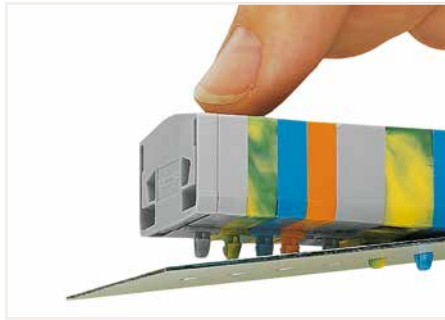

Mounting a terminal strip with snap-in feet into holes.

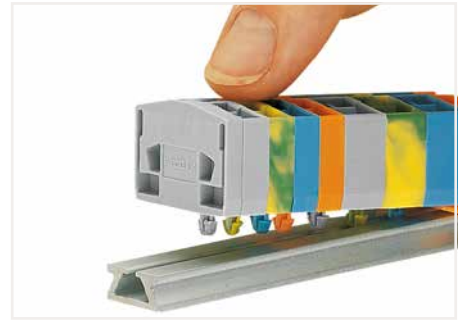

Mounting a terminal strip with snap-in feet onto the aluminum mounting rail.

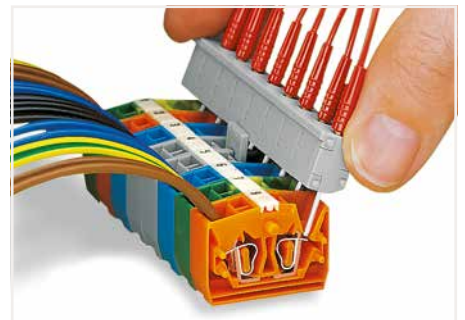
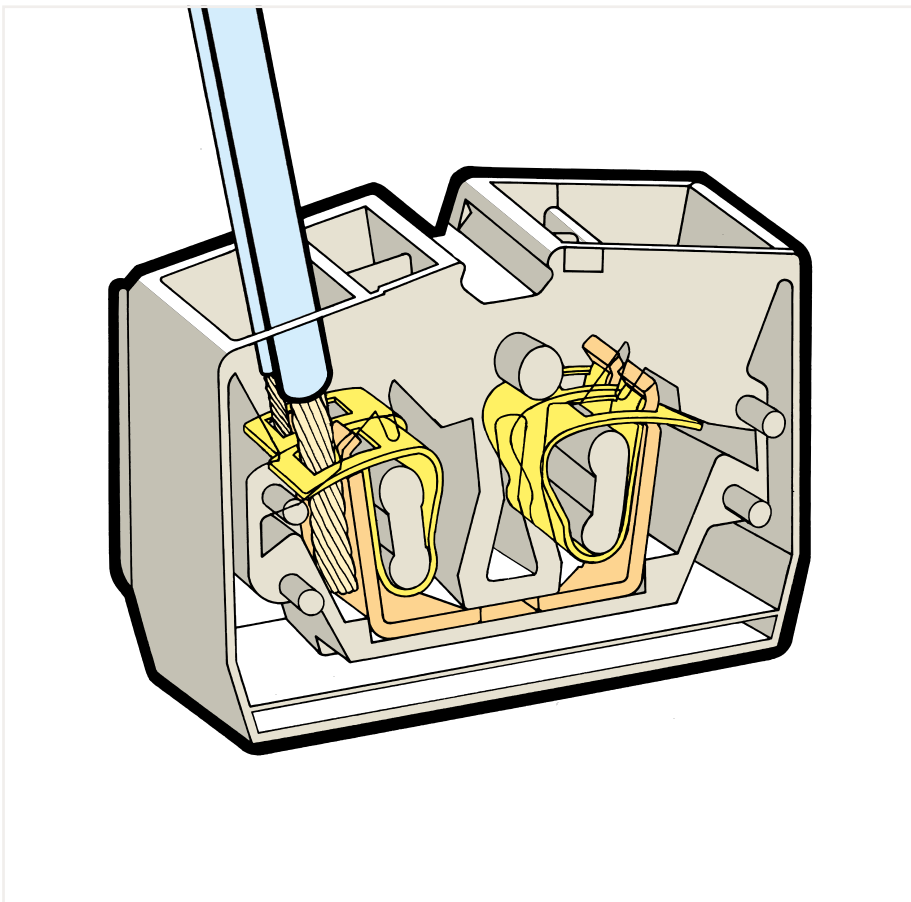

Testing by touch contact to the CAGE CLAMP® spring (limited to 0.5 A and 48 V test voltage) – test pins are not protected against accidental contact.

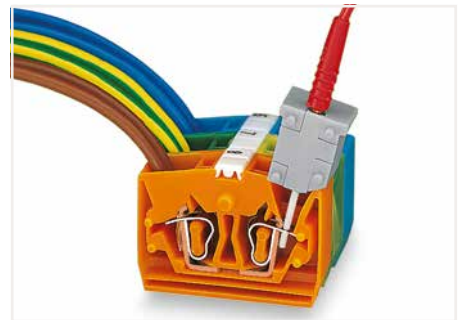

Testing via CAGE CLAMP® on the current bar (max. nominal current: 6 A). CAGE CLAMP® clamps individual test contacts. The maximum test voltage is 400 V.



Ex e II terminal strip; with mounting flanges; for screw or similar mounting types; 3.2 mm mounting hole diameter



Ex e II terminal strip; with snap-in mounting feet; for 0.6 ... 1.2 mm plate thickness; 3.5 mm mounting hole diameter



fine-stranded, tip-bonded



fine-stranded, with ferrule (gastight crimped)



fine-stranded, with pin terminal (gastight crimped)

Modular Terminal Block; with Mounting Flange

2.5 mm²; 264 Series

Technical Data	
0.08 ... 2.5 mm ²	28 ... 12 AWG*
800 V/8 kV/3 ①	300 V, 20 A ②
I _N 24 A	600 V, 20 A ③
Terminal block width: 6 mm / 0.236 inch	
8 ... 9 mm / 0.31 ... 0.35 inch	



Technical Data	
0.08 ... 2.5 mm ²	28 ... 12 AWG*
800 V/8 kV/3 ①	300 V, 20 A ②
I _N 24 A	600 V, 20 A ③
Terminal block width: 10 mm / 0.394 inch	
8 ... 9 mm / 0.31 ... 0.35 inch	



*12 AWG: THHN, THWN

- ① 800 V = rated voltage
8 kV = rated impulse voltage
3 = pollution degree (see Section 14)
- ② Terminal blocks with a blue insulated housing are suitable for Ex i applications.
- ③ Terminal blocks with an Ex mark are suitable for Ex e II applications.
0.5 ... 2.5 mm² / 20 ... 12 AWG*
690 V; 23 A (see Section 14)

See application notes for:
Alternate comb-style jumper bar, page 347
Test plug module, page 474
Mini-WSB marking system, page 589

Approvals and corresponding ratings, visit www.wago.com

2-conductor center terminal block; required between end plate and end terminal block for terminal strips with mounting flanges

Color	Item No.	Pack. Unit
gray	264-321	100
blue	264-324 ②	100
orange	264-326	100
green-yellow	264-327	100
light gray	264-131 ③	100

4-conductor center terminal block; required between end plate and end terminal block for terminal strips with mounting flanges

Color	Item No.	Pack. Unit
gray	264-351	100
blue	264-354 ②	100
orange	264-356	100
green-yellow	264-357	100
light gray	264-231 ③	100

2-conductor end terminal block; with mounting flange; for screw or similar mounting types; 3.2 mm mounting hole diameter

Color	Item No.	Pack. Unit
gray	264-301	100
blue	264-304 ②	100
orange	264-306	100
green-yellow	264-307	100
light gray	264-130 ③	100

4-conductor end terminal block; with mounting flange; for screw or similar mounting types; 3.2 mm mounting hole diameter

Color	Item No.	Pack. Unit
gray	264-331	100
blue	264-334 ②	100
orange	264-336	100
green-yellow	264-337	100
light gray	264-230 ③	100

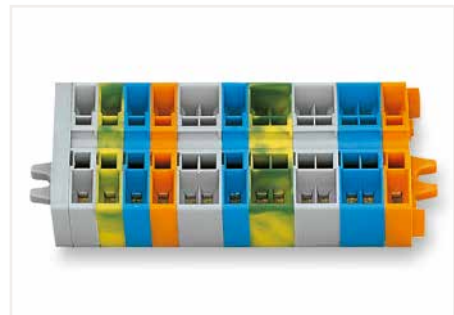

Terminal strip with mounting flanges, consisting of:

- End plate; with mounting flange
- Center terminal blocks
- End terminal block; with mounting flange

Accessories; item-specific

Alternate comb-style jumper bar; insulated; I_N = I_N of terminal block

2-way	Item No.	Pack. Unit
	281-492	100 (25)

Accessories; item-specific

Alternate comb-style jumper bar; insulated; I_N = I_N of terminal block

2-way	Item No.	Pack. Unit
	280-492	200 (25)

Test plug module; snaps together; 6 mm wide

Color	Item No.	Pack. Unit
gray	249-136	100 (25)

Test plug module; snaps together; 10 mm wide

Color	Item No.	Pack. Unit
gray	249-139	100 (25)

Mini-WSB marking card; white; 10 strips with 10 markers/ card; 5 mm wide markers

Color	Item No.	Pack. Unit
plain	248-501	5

Mini-WSB marking card; white; 10 strips with 10 markers/ card; 5 mm wide markers

Color	Item No.	Pack. Unit
plain	264-900	5

Accessories; 264 Series

Appropriate marking systems: Mini-WSB/Mini-WSB Inline/T-marker tag

End and intermediate plate; 4 mm thick

Color	Item No.	Pack. Unit
orange	264-361	25
gray	264-364	25
light gray	264-363	25

Test plug; with 500 mm cable; 2 mm Ø; max. 42 V

Color	Item No.	Pack. Unit
red	210-136	50

Comb-style jumper bar; insulated; reduces maximum conductor size to 1.5 mm²; I_N 16 A; gray

2-way	Item No.	Pack. Unit
	264-402	200 (25)

Test plug; with 500 mm cable; 2 mm Ø; max. 42 V

Color	Item No.	Pack. Unit
yellow	210-137	50

Operating tool; insulated

2-way	Item No.	Pack. Unit
	280-432	1

T-marker tag; 30 markers per tag; up to 6 characters per marker; stretchable 5 ... 6 mm

Color	Item No.	Pack. Unit
plain	209-290	50

Modular Terminal Block; with Snap-In Mounting Foot

2.5 mm²; 264 Series

Technical Data	
0.08 ... 2.5 mm ²	28 ... 12 AWG*
800 V/8 kV/3 ①	300 V, 20 A ②
I _N 24 A	600 V, 20 A ③
Terminal block width: 6 mm / 0.236 inch	
8 ... 9 mm / 0.31 ... 0.35 inch	



Technical Data	
0.08 ... 2.5 mm ²	28 ... 12 AWG*
800 V/8 kV/3 ①	300 V, 20 A ②
I _N 24 A	600 V, 20 A ③
Terminal block width: 10 mm / 0.394 inch	
8 ... 9 mm / 0.31 ... 0.35 inch	



*12 AWG: THHN, THWN

- 800 V = rated voltage
8 kV = rated impulse voltage
3 = pollution degree
(see Section 14)
- Terminal blocks with a blue insulated housing are suitable for Ex i applications.
- Terminal blocks with an Ex mark are suitable for Ex e II applications.
0.5 ... 2.5 mm² / 20 ... 12 AWG*
690 V; 23 A
(see Section 14)

See application notes for:
Alternate comb-style jumper bar, page 347
Test plug module, page 474
Mini-WSB marking system, page 589

Approvals and corresponding ratings,
visit www.wago.com

2-conductor center terminal block; required between end plate and end terminal block for terminal strips with mounting flanges

Color	Item No.	Pack. Unit
gray	264-311	100
blue	264-314 ②	100
orange	264-316	100
green-yellow	264-317	100
light gray	264-180 ③	100

4-conductor center terminal block; required between end plate and end terminal block for terminal strips with mounting flanges

Color	Item No.	Pack. Unit
gray	264-341	100
blue	264-344 ②	100
orange	264-346	100
green-yellow	264-347	100
light gray	264-280 ③	100



Terminal strip with mounting flanges, consisting of:
End plate
• 4-conductor terminal strip; with snap-in mounting foot 1)
• Center terminal blocks
• 2-conductor terminal strip; with snap-in mounting foot 1)
1) at every 4th or 5th terminal block of the strip

Accessories; item-specific

Alternate comb-style jumper bar; insulated; I_N = I_N of terminal block

	2-way	281-492	100 (25)

Accessories; item-specific

Alternate comb-style jumper bar; insulated; I_N = I_N of terminal block

	2-way	280-492	200 (25)

Test plug module; snaps together; 6 mm wide

	gray	249-136	100 (25)

Test plug module; snaps together; 10 mm wide

	gray	249-139	100 (25)

Mini-WSB marking card; white; 10 strips with 10 markers/ card; 5 mm wide markers

	plain	248-501	5

Mini-WSB marking card; white; 10 strips with 10 markers/ card; 5 mm wide markers

		264-900	5

Accessories; 264 Series

Appropriate marking systems: Mini-WSB/Mini-WSB Inline/T-marker tag

End and intermediate plate; 4 mm thick

	orange	264-371	25
	gray	264-374	25
	light gray	264-373	25

Aluminum mounting rail; 1000 mm long; 18 mm wide; 7 mm high

		210-154	1

Comb-style jumper bar; insulated; reduces maximum conductor size to 1.5 mm²; I_N 16 A; gray

	2-way	264-402	200 (25)

Plastic end stop; with WSB marker slot; for aluminum mounting rail (210-154); 6 mm wide

		209-122	25

Operating tool; insulated

	2-way	280-432	1

T-marker tag; 30 markers per tag; up to 6 characters per marker; stretchable 5 ... 6 mm

	plain	209-290	50

Test plug; with 500 mm cable; 2 mm Ø; max. 42 V

	red	210-136	50

Operating tool with a partially insulated shaft; Type 2; (3.5 x 0.5) mm blade

		210-720	1

Test plug; with 500 mm cable; 2 mm Ø; max. 42 V

	yellow	210-137	50

Terminal Strip; with Mounting Flanges or Snap-in Mounting Feet 2.5 mm²; 264 Series

Technical Data	
0.08 ... 2.5 mm ²	28 ... 12 AWG*
800 V/8 kV/3 ①	300 V, 20 A ②
I _N 24 A	600 V, 20 A ③
Pole width: 6 mm / 0.236 inch	
8 ... 9 mm / 0.31 ... 0.35 inch	

Technical Data	
0.08 ... 2.5 mm ²	28 ... 12 AWG*
800 V/8 kV/3 ①	300 V, 20 A ②
I _N 24 A	600 V, 20 A ③
Pole width: 10 mm / 0.394 inch	
8 ... 9 mm / 0.31 ... 0.35 inch	

Technical Data	
0.08 ... 2.5 mm ²	28 ... 12 AWG*
690 V ②	300 V, 20 A ③
I _N 23 A	600 V, 20 A ④
Pole width: 6 mm / 0.236 inch	
8 ... 9 mm / 0.31 ... 0.35 inch	



Dimensions in mm

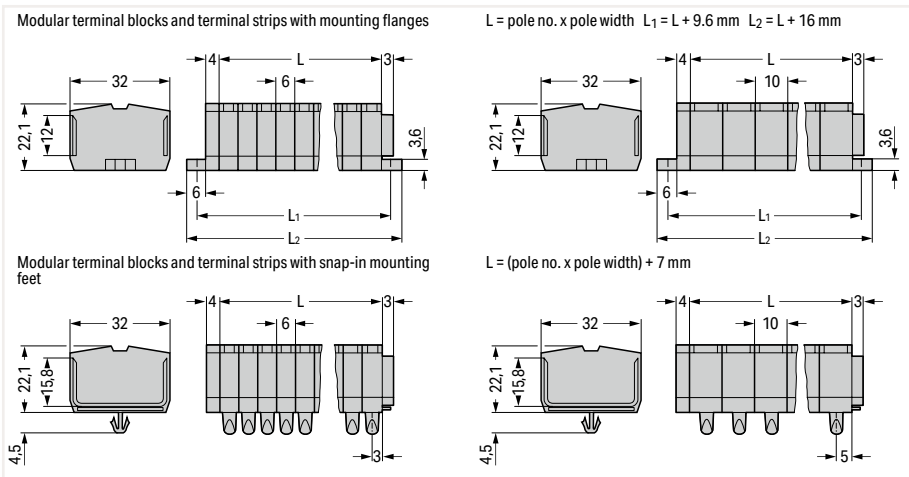

2-conductor terminal strip; with mounting flanges; for screw or similar mounting types; 3.2 mm mounting hole diameter; gray

Pole No.	Item No.	Pack. Unit
2	264-102	100
3	264-103	100
4	264-104	100
5	264-105	100
6	264-106	100
7	264-107	100
8	264-108	100
9	264-109	50
10	264-110	50
11	264-111	50
12 ③	264-112	25

4-conductor terminal strip; with mounting flanges; for screw or similar mounting types; 3.2 mm mounting hole diameter; gray

Pole No.	Item No.	Pack. Unit
2	264-202	100
3	264-203	100
4	264-204	100
5	264-205	100
6	264-206	100
7	264-207	100
8	264-208	100
9	264-209	50
10	264-210	50
11	264-211	25
12 ③	264-212	25

2-conductor Ex e II terminal strip; with mounting flanges; for screw or similar mounting types; 3.2 mm mounting hole diameter; light gray

Pole No.	Item No.	Pack. Unit
2	264-132	100
3	264-133	100
4	264-134	100
5	264-135	100
6	264-136	100
7	264-137	100
8	264-138	100
9	264-139	50
10	264-140	50
11	264-141	25
12 ③	264-142	25

2-conductor terminal strip; with snap-in mounting feet; for 0.6 ... 1.2 mm plate thickness; 3.5 mm mounting hole diameter; gray

Pole No.	Item No.	Pack. Unit
2	264-152	100
3	264-153	100
4	264-154	100
5	264-155	100
6	264-156	50
7	264-157	50
8	264-158	50
9	264-159	50
10	264-160	25
11	264-161	25
12 ③	264-162	25

4-conductor terminal strip; with snap-in mounting feet; for 0.6 ... 1.2 mm plate thickness; 3.5 mm mounting hole diameter; gray

Pole No.	Item No.	Pack. Unit
2	264-252	100
3	264-253	100
4	264-254	100
5	264-255	100
6	264-256	50
7	264-257	50
8	264-258	50
9	264-259	50
10	264-260	25
11	264-261	25
12 ③	264-262	25

2-conductor Ex e II terminal strip; with snap-in mounting feet; for 0.6 ... 1.2 mm plate thickness; 3.5 mm mounting hole diameter; light gray

Pole No.	Item No.	Pack. Unit
2	264-182	100
3	264-183	100
4	264-184	100
5	264-185	100
6	264-186	50
7	264-187	50
8	264-188	50
9	264-189	50
10	264-190	25
11	264-191	25
12 ③	264-192	25

Technical Data

0.08 ... 2.5 mm ²	28 ... 12 AWG*
690 V ②	300 V, 20 A ③
I _N 23 A	600 V, 20 A ④
Pole width: 10 mm / 0.394 inch	
8 ... 9 mm / 0.31 ... 0.35 inch	



*12 AWG: THHN, THWN

- ① 800 V = rated voltage
8 kV = rated impulse voltage
3 = pollution degree
(see Section 14)
- ② Suitable for Ex e II applications
(see Section 14)
- ③ Longer strips and/or mixed-color assemblies are available upon request.

Approvals and corresponding ratings, visit www.wago.com

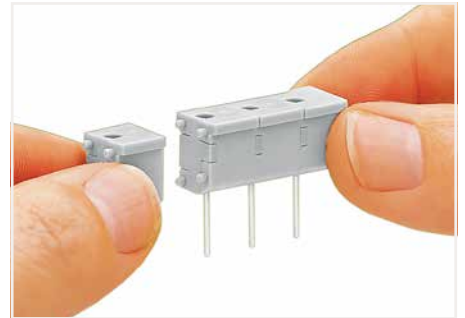

Snapping individual modules together to assemble a multi-pole test plug module.



Item no. suffixes for gray terminal strips with mounting flanges:
264-102 to 264-112
264-202 to 264-212

blue .../000-006,
Terminal strips with a blue insulated housing are suitable for Ex i applications.



Item no. suffixes for gray terminal strips with snap-in mounting feet:
264-152 to 264-162
264-252 to 264-262

blue .../000-006,
Terminal strips with a blue insulated housing are suitable for Ex i applications.

4-conductor Ex e II terminal strip; with mounting flanges; for screw or similar mounting types; 3.2 mm mounting hole diameter; light gray

Pole No.	Item No.	Pack. Unit
○ 2	264-232	100
○ 3	264-233	100
○ 4	264-234	100
○ 5	264-235	100
○ 6	264-236	100
○ 7	264-237	100
○ 8	264-238	100
○ 9	264-239	50
○ 10	264-240	50
○ 11	264-241	100
○ 12 ③	264-242	25



Ex e II terminal strip; with mounting flanges; for screw or similar mounting types; 3.2 mm mounting hole diameter



Ex e II terminal strip; with snap-in mounting feet; for 0.6 ... 1.2 mm plate thickness; 3.5 mm mounting hole diameter

4-conductor Ex e II terminal strip; with snap-in mounting feet; for 0.6 ... 1.2 mm plate thickness; 3.5 mm mounting hole diameter; light gray

○ 2	264-282	100
○ 3	264-283	100
○ 4	264-284	100
○ 5	264-285	100
○ 6	264-286	100
○ 7	264-287	50
○ 8	264-288	50
○ 9	264-289	50
○ 10	264-290	25
○ 11	264-291	25
○ 12 ③	264-292	25

Modular Terminal Blocks and Terminal Strips

260 to 262 Series

Description and Installation



Assembling modular terminal blocks into terminal strips.

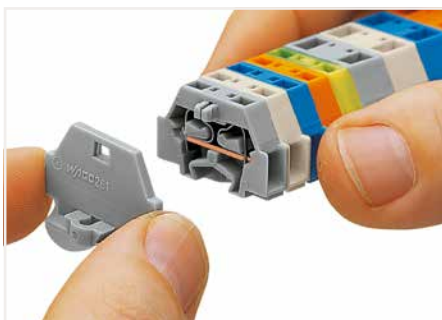

Mounting an end plate.

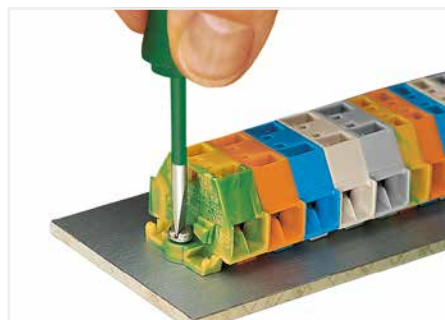

Mounting and securing a terminal strip directly to the plate via screw-type flanges.



CAGE CLAMP® termination:
Inserting a conductor.
With ferruled conductors, it is necessary to use a terminal block one size smaller than the conductor's nominal cross section.

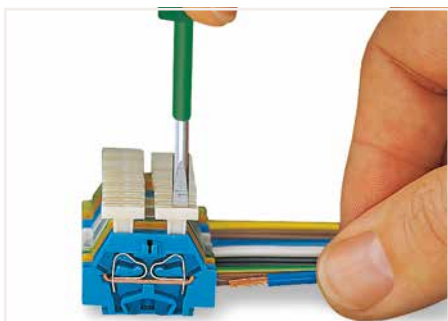

CAGE CLAMP® termination:
Inserting a conductor via push-button.

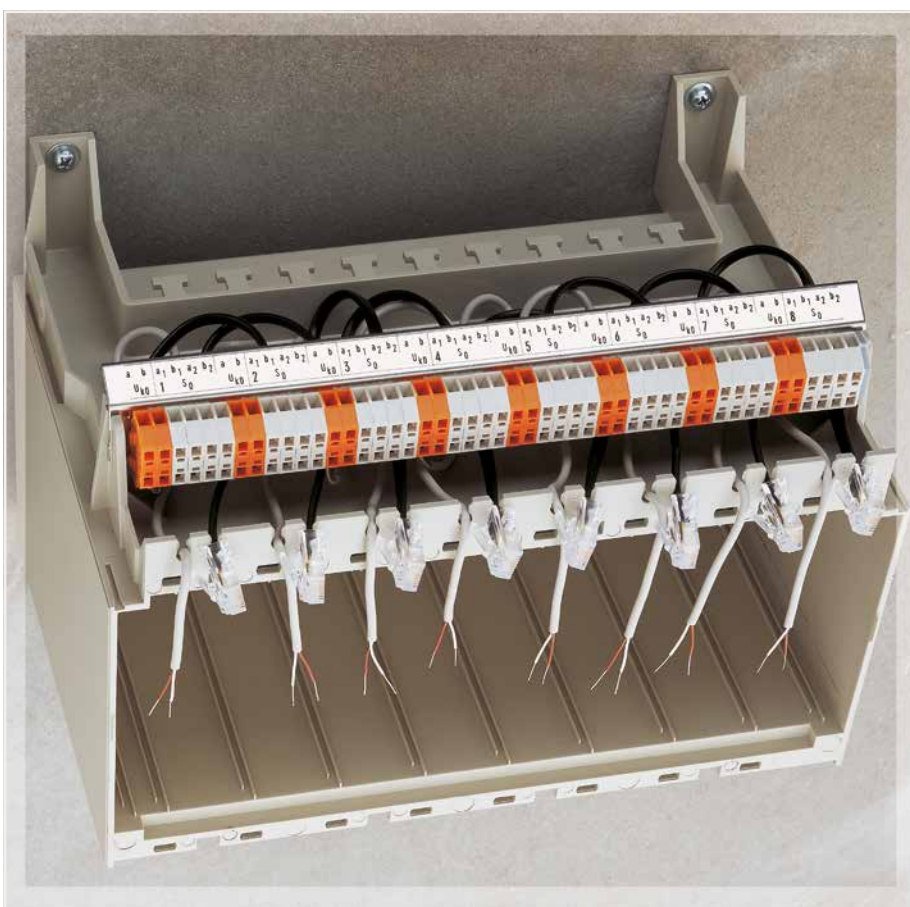

8



Terminal strip; with push-buttons on one side

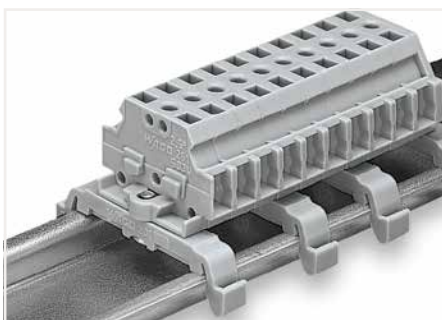

Terminal strip; with marker slot for Mini-WSB Quick Marking System

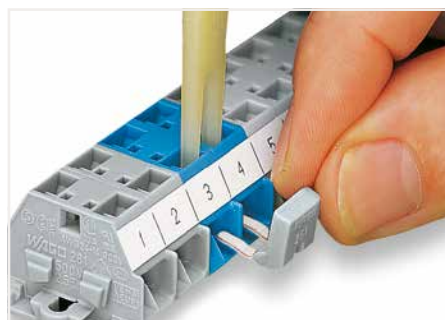

Commoning with comb-style jumper bar.



CAGE CLAMP® terminates the following copper conductors:
solid



stranded



fine-stranded,
also with tinned
single strands



Mounting a terminal strip with snap-in feet into holes.

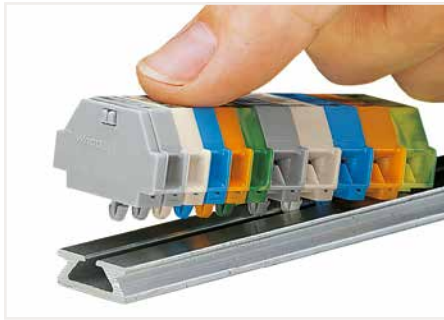

Mounting a terminal strip with snap-in feet onto the aluminum rail.



Mounting and securing a terminal strip directly to the plate via screw-type flanges.
screwing a mounting foot (209-123)
(distance between mounting feet: approx. 20 ... 25 mm)

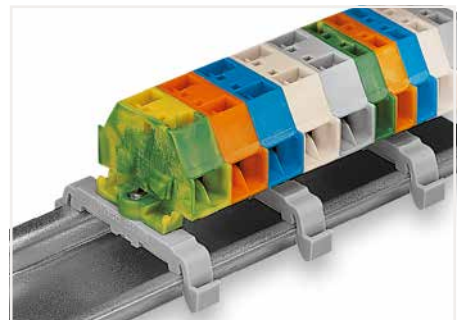
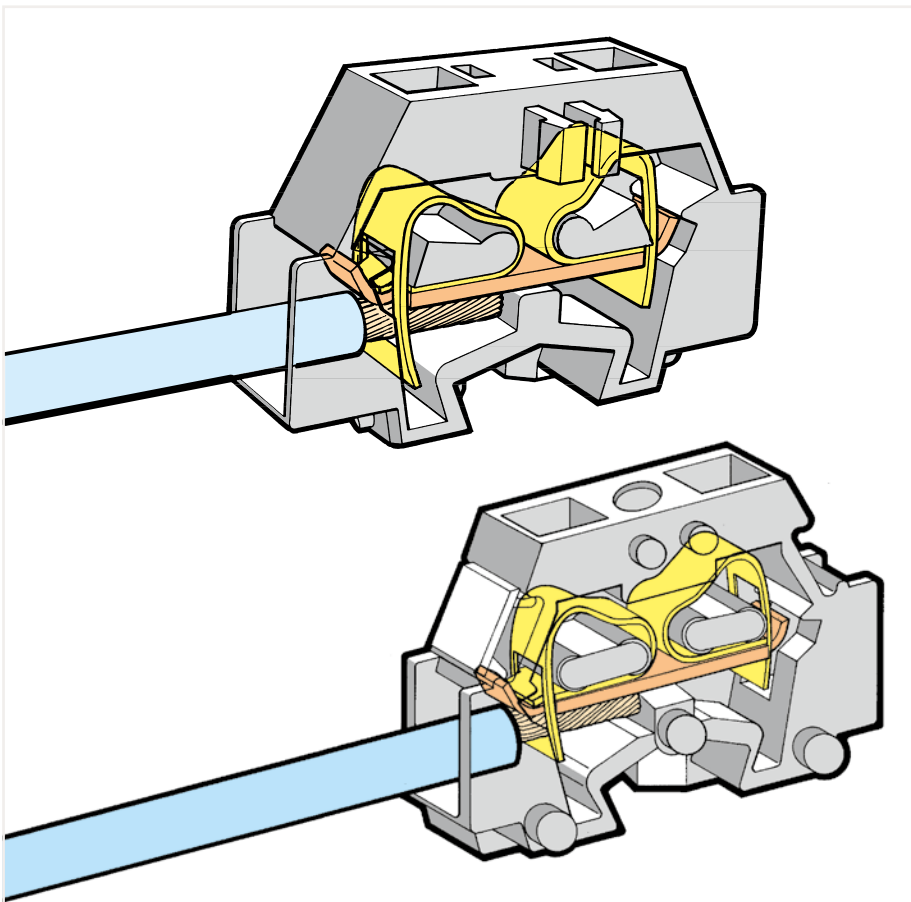

Terminal strip; with mounting flanges; for DIN-35 rail

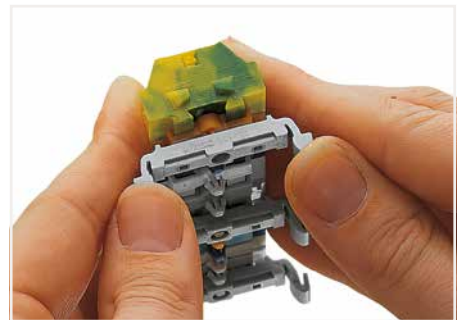

Terminal strip; with snap-in mounting feet; snapping a mounting foot (209-123)
(distance between mounting feet: approx. 20 ... 25 mm)



Marking with self-adhesive marking strips.



Marking by direct printing (upon request).

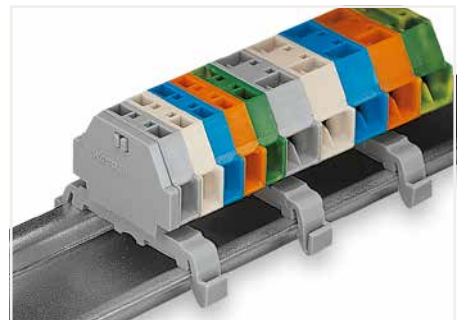

Terminal strip; with snap-in mounting feet; for DIN-35 rail



fine-stranded, tip-bonded



fine-stranded, with ferrule (gastight crimped)



fine-stranded, with pin terminal (gastight crimped)

Modular Terminal Block; with Mounting Flange or Snap-In Mounting Foot 1.5 mm²; 260 Series

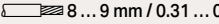
Technical Data	
0.08 ... 1.5 mm ² (28 ... 16 AWG)	28 ... 16 AWG
400 V/6 kV/3 ①	300 V, 10 A ②
I _n 18 A	300 V, 15 A ③
Terminal block width: 5 mm / 0.197 inch	
 8 ... 9 mm / 0.31 ... 0.35 inch	

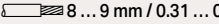
Technical Data	
0.08 ... 1.5 mm ² (28 ... 16 AWG)	28 ... 16 AWG
400 V/6 kV/3 ①	300 V, 10 A ②
I _n 18 A	300 V, 15 A ③
Terminal block width: 8 mm / 0.315 inch	
 8 ... 9 mm / 0.31 ... 0.35 inch	

① 400 V = rated voltage
6 kV = rated impulse voltage
3 = pollution degree
(see Section 14)

See application notes for:
Test plug module, page 474

Approvals and corresponding ratings,
visit www.wago.com



2-conductor terminal block; with mounting flange; for screw or similar mounting types; 3.2 mm mounting hole diameter; with mounting foot (209-123) also for DIN-35 rail

Color	Item No.	Pack. Unit
○ gray	260-301	300 (50)
○ light gray	260-303	300 (50)
● blue	260-304	300 (50)
● orange	260-306	300 (50)
● green-yellow	260-307	300 (50)

4-conductor terminal block; with mounting flange; for screw or similar mounting types; 3.2 mm mounting hole diameter; with mounting foot (209-123) also for DIN-35 rail

Color	Item No.	Pack. Unit
○ gray	260-331	300 (50)
○ light gray	260-333	300 (50)
● blue	260-334	300 (50)
● orange	260-336	300 (50)
● green-yellow	260-337	300 (50)

Accessories; 260 Series

Marking accessories, see Section 13

Test plug; with 500 mm cable; 2 mm Ø; max. 42 V

 red	210-136	50
---	---------	----

Test plug; with 500 mm cable; 2 mm Ø; max. 42 V

 yellow	210-137	50
--	---------	----

Aluminum mounting rail; 1000 mm long; 18 mm wide; 7 mm high

	210-154	1
---	---------	---

Plastic end stop; with WSB marker slot; for aluminum rail (210-154); 6 mm wide

	209-122	25
---	---------	----

Mounting foot; for DIN-35 rail; snaps onto terminal blocks with snap-in mounting foot; 6.4 mm wide

 gray	209-120	25
--	---------	----

Mounting screw; for mounting foot (209-120)

	209-119	500 (50)
---	---------	----------

2-conductor terminal block; with snap-in mounting foot; for 0.6 ... 1.2 mm plate thickness; 3.5 mm mounting hole diameter; also for aluminum rail (210-154) or with mounting foot (209-120) for DIN-35 rail

Color	Item No.	Pack. Unit
○ gray	260-311	300 (50)
○ light gray	260-313	300 (50)
● blue	260-314	300 (50)
● orange	260-316	300 (50)
● green-yellow	260-317	300 (50)

4-conductor terminal block; with snap-in mounting foot; for 0.6 ... 1.2 mm plate thickness; 3.5 mm mounting hole diameter; also for aluminum rail (210-154) or with mounting foot (209-120) for DIN-35 rail

Color	Item No.	Pack. Unit
○ gray	260-341	300 (50)
○ light gray	260-343	300 (50)
● blue	260-344	300 (50)
● orange	260-346	300 (50)
● green-yellow	260-347	300 (50)

Mounting foot with screw; for DIN-35 rail; can be screwed on terminal blocks with mounting flange; 6.4 mm wide

 gray	209-123	25
--	---------	----

Mounting adapter; for DIN-35 rail; can be used as end plate; 6.5 mm wide

 gray	209-137	25
--	---------	----

Operating tool with a partially insulated shaft; Type 2; (3.5 x 0.5) mm blade

	210-720	1
---	---------	---

Accessories; item-specific

Test plug module; snaps together; 5 mm wide

 gray	249-135	100 (25)
--	---------	----------

Test plug module; with locking latches; snaps together; 5 mm wide

 gray	260-404	100 (25)
--	---------	----------

Accessories; item-specific

Test plug module; snaps together; 8 mm wide

 gray	249-138	100 (25)
--	---------	----------

Test plug module; with locking latches; snaps together; 8 mm wide

 gray	260-405	100 (25)
--	---------	----------

Accessories; 260 Series

Marking accessories, see Section 13

End plate; with mounting flange

 gray	260-361	300 (50)
--	---------	----------

End plate; with snap-in mounting foot

 gray	260-371	300 (50)
--	---------	----------

Comb-style jumper bar; insulated; reduces maximum conductor size to 1 mm²; I_n 10 A; gray

 2-way	260-402	25
---	---------	----

Operating tool; insulated; for comb-style jumper bar

 2-way	209-132	1
---	---------	---

Terminal Strip; with Mounting Flanges or Snap-in Mounting Feet 1.5 mm²; 260 Series

Technical Data	
0.08 ... 1.5 mm ² (28 ... 16 AWG)	28 ... 16 AWG
400 V/6 kV/3 ①	300 V, 10 A I_N
I_N 18 A	300 V, 15 A I_{N2}
Pole width: 5 mm / 0.197 inch	
8 ... 9 mm / 0.31 ... 0.35 inch	

Technical Data	
0.08 ... 1.5 mm ² (28 ... 16 AWG)	28 ... 16 AWG
400 V/6 kV/3 ①	300 V, 10 A I_N
I_N 18 A	300 V, 15 A I_{N2}
Pole width: 8 mm / 0.315 inch	
8 ... 9 mm / 0.31 ... 0.35 inch	

- ① 400 V = rated voltage
6 kV = rated impulse voltage
3 = pollution degree
(see Section 14)
 - ② Longer strips and/or mixed-color assemblies are available upon request.
- Approvals and corresponding ratings, visit www.wago.com

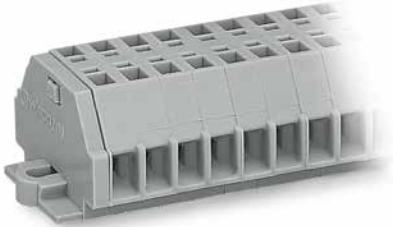

Dimensions in mm

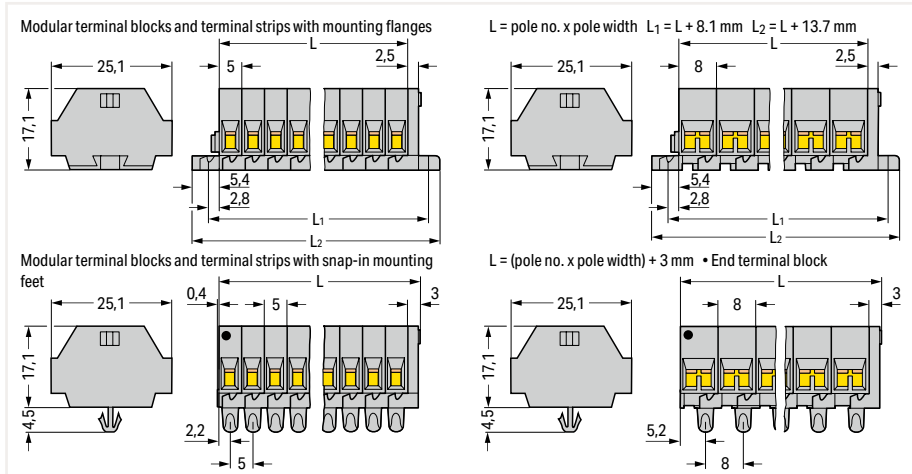

Terminal strip; with mounting flanges; for screw or similar mounting types; 3.2 mm mounting hole diameter (with 209-123 Mounting Foot for DIN-35 rail)



Terminal strip; with snap-in mounting feet; for 0.6 ... 1.2 mm plate thickness; 3.5 mm mounting hole diameter (also for 210-154 Aluminum Rail or with 209-120 Mounting Foot for DIN-35 rail)

2-conductor terminal strip; with mounting flanges; for screw or similar mounting types; 3.2 mm mounting hole diameter; with mounting foot (209-123) also for DIN-35 rail; gray

Pole No.	Item No.	Pack. Unit
2	260-102	100
3	260-103	100
4	260-104	100
5	260-105	100
6	260-106	100
7	260-107	100
8	260-108	100
9	260-109	50
10	260-110	50
11	260-111	50
12 ②	260-112	25

4-conductor terminal strip; with mounting flanges; for screw or similar mounting types; 3.2 mm mounting hole diameter; with mounting foot (209-123) also for DIN-35 rail; gray

Pole No.	Item No.	Pack. Unit
2	260-202	100
3	260-203	100
4	260-204	100
5	260-205	100
6	260-206	100
7	260-207	100
8	260-208	100
9	260-209	50
10	260-210	50
11	260-211	25
12 ②	260-212	25

2-conductor terminal strip; with snap-in mounting feet; for 0.6 ... 1.2 mm plate thickness; 3.5 mm mounting hole diameter; also for aluminum rail (210-154) or with mounting foot (209-120) for DIN-35 rail; gray

Pole No.	Item No.	Pack. Unit
2	260-152	100
3	260-153	100
4	260-154	100
5	260-155	100
6	260-156	50
7	260-157	50
8	260-158	50
9	260-159	50
10	260-160	25
11	260-161	25
12 ②	260-162	25

4-conductor terminal strip; with snap-in mounting feet; for 0.6 ... 1.2 mm plate thickness; 3.5 mm mounting hole diameter; also for aluminum rail (210-154) or with mounting foot (209-120) for DIN-35 rail; gray

Pole No.	Item No.	Pack. Unit
2	260-252	100
3	260-253	100
4	260-254	100
5	260-255	100
6	260-256	50
7	260-257	50
8	260-258	50
9	260-259	50
10	260-260	25
11	260-261	25
12 ②	260-262	25

Modular Terminal Block; with Mounting Flange or Snap-In Mounting Foot 2.5 mm²; 261 Series

Technical Data	
0.08 ... 2.5 mm ²	28 ... 14 AWG
500 V/6 kV/3 ①	300 V, 15 A ②
I _N 24 A	300 V, 20 A ③
Terminal block width: 6 mm / 0.236 inch	
8 ... 9 mm / 0.31 ... 0.35 inch	

Technical Data	
0.08 ... 2.5 mm ²	28 ... 14 AWG
500 V/6 kV/3 ①	300 V, 15 A ②
I _N 24 A	300 V, 20 A ③
Terminal block width: 10 mm / 0.394 inch	
8 ... 9 mm / 0.31 ... 0.35 inch	

- ① 500 V = rated voltage
6 kV = rated impulse voltage
3 = pollution degree
(see Section 14)
 - ② Terminal blocks with a blue insulated housing are suitable for Ex i applications.
- See application notes for:
Test plug module, page 474
- Approvals and corresponding ratings,
visit www.wago.com



Accessories; 261 Series
Marking accessories, see Section 13

Test plug; with 500 mm cable; 2 mm Ø; max. 42 V			
	red	210-136	50

Test plug; with 500 mm cable; 2 mm Ø; max. 42 V			
	yellow	210-137	50

Aluminum mounting rail; 1000 mm long; 18 mm wide; 7 mm high		
		210-154 1

Plastic end stop; with WSB marker slot; for aluminum rail (210-154); 6 mm wide		
		209-122 25

Mounting foot; for DIN-35 rail; snaps onto terminal blocks with snap-in mounting foot; 6.4 mm wide		
	gray	209-120 25

Mounting screw; for mounting foot (209-120)		
		209-119 500(50)

Mounting foot with screw; for DIN-35 rail; can be screwed on terminal blocks with mounting flange; 6.4 mm wide		
	gray	209-123 25

Mounting adapter; for DIN-35 rail; can be used as end plate; 6.5 mm wide		
	gray	209-137 25

Operating tool with a partially insulated shaft; Type 2; (3.5 x 0.5) mm blade		
		210-720 1

2-conductor terminal block; with mounting flange; for screw or similar mounting types; 3.2 mm mounting hole diameter; with mounting foot (209-123) also for DIN-35 rail

Color	Item No.	Pack. Unit
	261-301	200(50)
	261-303	200(50)
	261-304 ②	200(50)
	261-306	200(50)
	261-307	200(50)

4-conductor terminal block; with mounting flange; for screw or similar mounting types; 3.2 mm mounting hole diameter; with mounting foot (209-123) also for DIN-35 rail

Color	Item No.	Pack. Unit
	261-331	200(50)
	261-333	200(50)
	261-334 ②	200(50)
	261-336	200(50)
	261-337	200(50)

2-conductor terminal block; with snap-in mounting foot; for 0.6 ... 1.2 mm plate thickness; 3.5 mm mounting hole diameter; also for aluminum rail (210-154) or with mounting foot (209-120) for DIN-35 rail

Color	Item No.	Pack. Unit
	261-311	200(50)
	261-313	200(50)
	261-314 ②	200(50)
	261-316	200(50)
	261-317	200(50)

4-conductor terminal block; with snap-in mounting foot; for 0.6 ... 1.2 mm plate thickness; 3.5 mm mounting hole diameter; also for aluminum rail (210-154) or with mounting foot (209-120) for DIN-35 rail

Color	Item No.	Pack. Unit
	261-341	200(50)
	261-343	200(50)
	261-344 ②	200(50)
	261-346	200(50)
	261-347	200(50)

Space-saving 2-conductor end terminal block; without protruding snap-in mounting foot; for terminal strips with snap-in mounting feet

Color	Item No.	Pack. Unit
	261-321	200(50)
	261-323	200(50)
	261-324 ②	200(50)
	261-326	200(50)
	261-327	200(50)

Space-saving 4-conductor end terminal block; without protruding snap-in mounting foot; for terminal strips with snap-in mounting feet

Color	Item No.	Pack. Unit
	261-351	200(50)
	261-353	200(50)
	261-354 ②	200(50)
	261-356	200(50)
	261-357	200(50)

Accessories; item-specific

Test plug module; snaps together; 6 mm wide			
	gray	249-136	100(25)

Accessories; item-specific

Test plug module; snaps together; 10 mm wide			
	gray	249-139	100(25)

Test plug module; with locking latches; snaps together; 6 mm wide			
	gray	261-404	100(25)

Test plug module; with locking latches; snaps together; 10 mm wide			
	gray	261-405	100(25)

Accessories; 261 Series
Marking accessories, see Section 13

End plate; with mounting flange		
	gray	261-361 300(50)

Comb-style jumper bar; insulated; reduces maximum conductor size to 1.5 mm ² ; I _N 16 A; gray		
	2-way	261-402 25

End plate; with snap-in mounting foot		
	gray	261-371 300(50)

Operating tool; insulated; for comb-style jumper bar		
	2-way	209-132 1

Terminal Strip; with Mounting Flanges or Snap-in Mounting Feet 2.5 mm²; 261 Series

Technical Data	
0.08 ... 2.5 mm ²	28 ... 14 AWG
500 V/6 kV/3 ①	300 V, 15 A ②
I _N 24 A	300 V, 20 A ③
Pole width: 6 mm / 0.236 inch	
8 ... 9 mm / 0.31 ... 0.35 inch	

Technical Data	
0.08 ... 2.5 mm ²	28 ... 14 AWG
500 V/6 kV/3 ①	300 V, 15 A ②
I _N 24 A	300 V, 20 A ③
Pole width: 10 mm / 0.394 inch	
8 ... 9 mm / 0.31 ... 0.35 inch	

- ① 500 V = rated voltage
6 kV = rated impulse voltage
3 = pollution degree
(see Section 14)
 - ② Terminal strips with a blue insulated housing are suitable for Ex i applications.
Item no. suffixes .../000-006 (upon request)
 - ③ Longer strips and/or mixed-color assemblies are available upon request.
- Approvals and corresponding ratings, visit www.wago.com

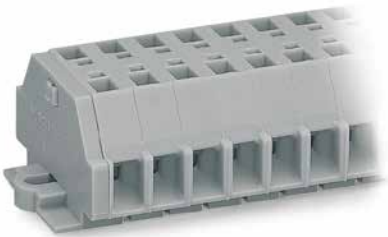

Dimensions in mm

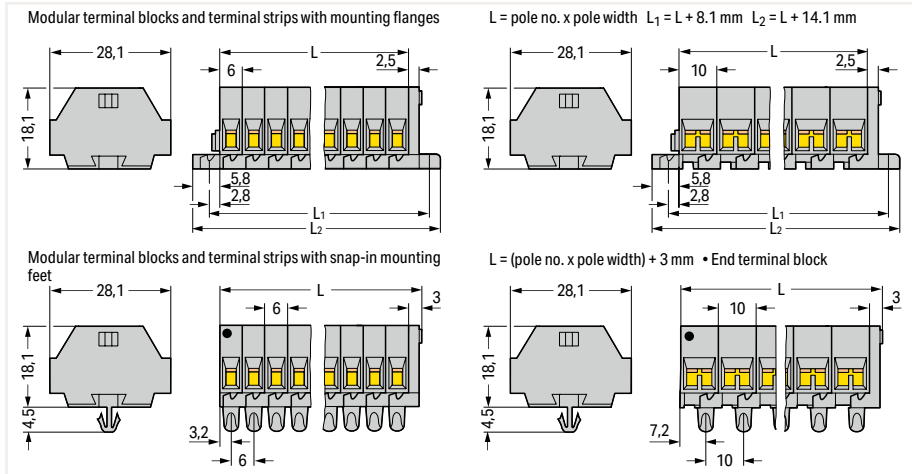

Terminal strip; with mounting flanges; for screw or similar mounting types; 3.2 mm mounting hole diameter (with 209-123 Mounting Foot for DIN-35 rail)



Terminal strip; with snap-in mounting feet; for 0.6 ... 1.2 mm plate thickness; 3.5 mm mounting hole diameter (also for 210-154 Aluminum Rail or with 209-120 Mounting Foot for DIN-35 rail)

2-conductor terminal strip; with mounting flanges; for screw or similar mounting types; 3.2 mm mounting hole diameter; with mounting foot (209-123) also for DIN-35 rail; gray ②

Pole No.	Item No.	Pack. Unit
○ 2	261-102	100
○ 3	261-103	100
○ 4	261-104	100
○ 5	261-105	200
○ 6	261-106	50
○ 7	261-107	50
○ 8	261-108	50
○ 9	261-109	50
○ 10	261-110	25
○ 11	261-111	25
○ 12 ③	261-112	25

4-conductor terminal strip; with mounting flanges; for screw or similar mounting types; 3.2 mm mounting hole diameter; with mounting foot (209-123) also for DIN-35 rail; gray ②

Pole No.	Item No.	Pack. Unit
○ 2	261-202	100
○ 3	261-203	100
○ 4	261-204	100
○ 5	261-205	100
○ 6	261-206	50
○ 7	261-207	50
○ 8	261-208	50
○ 9	261-209	50
○ 10	261-210	25
○ 11	261-211	25
○ 12 ③	261-212	25

2-conductor terminal strip; with snap-in mounting feet; for 0.6 ... 1.2 mm plate thickness; 3.5 mm mounting hole diameter; also for aluminum rail (210-154) or with mounting foot (209-120) for DIN-35 rail; gray ②

Pole No.	Item No.	Pack. Unit
○ 2	261-152	100
○ 3	261-153	100
○ 4	261-154	100
○ 5	261-155	100
○ 6	261-156	50
○ 7	261-157	50
○ 8	261-158	50
○ 9	261-159	50
○ 10	261-160	25
○ 11	261-161	25
○ 12 ③	261-162	25

4-conductor terminal strip; with snap-in mounting feet; for 0.6 ... 1.2 mm plate thickness; 3.5 mm mounting hole diameter; also for aluminum rail (210-154) or with mounting foot (209-120) for DIN-35 rail; gray ②

Pole No.	Item No.	Pack. Unit
○ 2	261-252	100
○ 3	261-253	100
○ 4	261-254	100
○ 5	261-255	100
○ 6	261-256	50
○ 7	261-257	50
○ 8	261-258	50
○ 9	261-259	50
○ 10	261-260	25
○ 11	261-261	25
○ 12 ③	261-262	25

Modular Terminal Block; with Push-Buttons on One Side; with Mounting Flange or Snap-In Mounting Foot

2.5 mm²; 261 Series

Technical Data

0.08 ... 2.5 mm ²	28 ... 14 AWG
500 V/6 kV/3 ①	300 V, 15 A ②
I _N 24 A	300 V, 20 A ③
Terminal block width: 6 mm / 0.236 inch	
 8 ... 9 mm / 0.31 ... 0.35 inch	

Technical Data

0.08 ... 2.5 mm ²	28 ... 14 AWG
500 V/6 kV/3 ①	300 V, 15 A ②
I _N 24 A	300 V, 20 A ③
Terminal block width: 10 mm / 0.394 inch	
 8 ... 9 mm / 0.31 ... 0.35 inch	

- ① 500 V = rated voltage
6 kV = rated impulse voltage
3 = pollution degree
(see Section 14)
 - ② Terminal blocks with a blue insulated housing are suitable for Ex i applications.
- Approvals and corresponding ratings, visit www.wago.com

Accessories; 261 Series

Marking accessories, see Section 13

Mounting foot; for DIN-35 rail; snaps onto terminal blocks with snap-in mounting foot; 6.4 mm wide

gray	209-120	25
------	---------	----



Mounting screw; for mounting foot (209-120)

209-119	500 (50)
---------	----------



2-conductor terminal block; with push-button on one side; with mounting flange; for screw or similar mounting types; 3.2 mm mounting hole diameter; with mounting foot (209-123) also for DIN-35 rail

Color	Item No.	Pack. Unit
gray	261-301/331-000	200 (50)
light gray	261-303/331-000	200 (50)
blue	261-304/331-000 ②	200 (50)
orange	261-306/331-000	200 (50)
green-yellow	261-307/331-000	200 (50)

4-conductor terminal block; with push-button on one side; with mounting flange; for screw or similar mounting types; 3.2 mm mounting hole diameter; with mounting foot (209-123) also for DIN-35 rail

Color	Item No.	Pack. Unit
gray	261-331/332-000	200 (50)
light gray	261-333/332-000	200 (50)
blue	261-334/332-000 ②	200 (50)
orange	261-336/332-000	200 (50)
green-yellow	261-337/332-000	200 (50)

Mounting foot with screw; for DIN-35 rail; can be screwed on terminal blocks with mounting flange; 6.4 mm wide

gray	209-123	25
------	---------	----



Mounting adapter; for DIN-35 rail; can be used as end plate; 6.5 mm wide

gray	209-137	25
------	---------	----



Operating tool with a partially insulated shaft; Type 2; (3.5 x 0.5) mm blade

210-720	1
---------	---



2-conductor terminal block; with push-button on one side; with snap-in mounting foot; for 0.6 ... 1.2 mm plate thickness; 3.5 mm mounting hole diameter; also for aluminum rail (210-154) or with mounting foot (209-120) for DIN-35 rail

Color	Item No.	Pack. Unit
gray	261-311/331-000	200 (50)
light gray	261-313/331-000	200 (50)
blue	261-314/331-000 ②	200 (50)
orange	261-316/331-000	200 (50)
green-yellow	261-317/331-000	200 (50)

4-conductor terminal block; with push-button on one side; with snap-in mounting foot; for 0.6 ... 1.2 mm plate thickness; 3.5 mm mounting hole diameter; also for aluminum rail (210-154) or with mounting foot (209-120) for DIN-35 rail

Color	Item No.	Pack. Unit
gray	261-341/332-000	200 (50)
light gray	261-343/332-000	200 (50)
blue	261-344/332-000 ②	200 (50)
orange	261-346/332-000	200 (50)
green-yellow	261-347/332-000	200 (50)

Space-saving 2-conductor end terminal block; with push-button on one side; without protruding snap-in mounting foot; for terminal strips with snap-in mounting feet

Color	Item No.	Pack. Unit
gray	261-321/331-000	200 (50)
light gray	261-323/331-000	200 (50)
blue	261-324/331-000 ②	200 (50)
orange	261-326/331-000	200 (50)
green-yellow	261-327/331-000	200 (50)

Space-saving 4-conductor end terminal block; with push-button on one side; without protruding snap-in mounting foot; for terminal strips with snap-in mounting feet

Color	Item No.	Pack. Unit
gray	261-351/332-000	200 (50)
light gray	261-353/332-000	200 (50)
blue	261-354/332-000 ②	200 (50)
orange	261-356/332-000	200 (50)
green-yellow	261-357/332-000	200 (50)

Accessories; 261 Series

Marking accessories, see Section 13

End plate; with mounting flange

gray	261-361	300 (50)
------	---------	----------



Test plug; with 500 mm cable; 2 mm Ø; max. 42 V

red	210-136	50
-----	---------	----



End plate; with snap-in mounting foot

gray	261-371	300 (50)
------	---------	----------



Test plug; with 500 mm cable; 2 mm Ø; max. 42 V

yellow	210-137	50
--------	---------	----



Comb-style jumper bar; insulated; reduces maximum conductor size to 1.5 mm²; I_N 16 A; gray

2-way	261-402	25
-------	---------	----



Aluminum mounting rail; 1000 mm long; 18 mm wide; 7 mm high

210-154	1
---------	---



Operating tool; insulated; for comb-style jumper bar

2-way	209-132	1
-------	---------	---



Plastic end stop; with WSB marker slot; for aluminum rail (210-154); 6 mm wide

209-122	25
---------	----



Terminal Strip; with Push-Buttons on One Side; with Mounting Flanges or Snap-in Mounting Feet 2.5 mm²; 261 Series

Technical Data	
0.08 ... 2.5 mm ²	28 ... 14 AWG
500 V/6 kV/3 ①	
I _N 24 A	
Pole width: 6 mm / 0.236 inch	
8 ... 9 mm / 0.31 ... 0.35 inch	

Technical Data	
0.08 ... 2.5 mm ²	28 ... 14 AWG
500 V/6 kV/3 ①	
I _N 24 A	
Pole width: 10 mm / 0.394 inch	
8 ... 9 mm / 0.31 ... 0.35 inch	

- ① 500 V = rated voltage
6 kV = rated impulse voltage
3 = pollution degree
(see Section 14)
 - ② Terminal strips with a blue insulated housing are suitable for Ex i applications.
Item no. suffixes .../000-006 (upon request)
 - ③ Longer strips and/or mixed-color assemblies are available upon request.
- Approvals and corresponding ratings, visit www.wago.com



Dimensions in mm

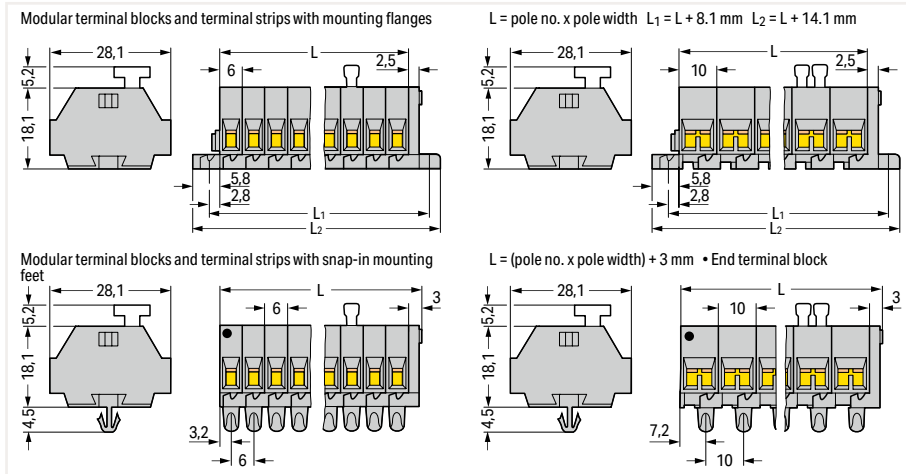

Terminal strip; with mounting flanges; for screw or similar mounting types; 3.2 mm mounting hole diameter (with 209-123 Mounting Foot for DIN-35 rail)

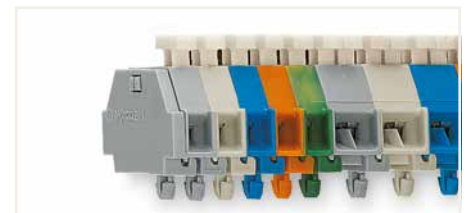

Terminal strip; with snap-in mounting feet; for 0.6 ... 1.2 mm plate thickness; 3.5 mm mounting hole diameter (also for 210-154 Aluminum Rail or with 209-120 Mounting Foot for DIN-35 rail)

2-conductor terminal strip; with push-buttons on one side; with mounting flanges; for screw or similar mounting types; 3.2 mm mounting hole diameter; with mounting foot (209-123) also for DIN-35 rail; gray ②

4-conductor terminal strip; with push-buttons on one side; with mounting flanges; for screw or similar mounting types; 3.2 mm mounting hole diameter; with mounting foot (209-123) also for DIN-35 rail; gray ②

Pole No.	Item No.	Pack. Unit
○ 2	261-102/331-000	100
○ 3	261-103/331-000	100
○ 4	261-104/331-000	100
○ 5	261-105/331-000	200
○ 6	261-106/331-000	50
○ 7	261-107/331-000	50
○ 8	261-108/331-000	50
○ 9	261-109/331-000	50
○ 10	261-110/331-000	25
○ 11	261-111/331-000	25
○ 12 ③	261-112/331-000	25

Pole No.	Item No.	Pack. Unit
○ 2	261-202/332-000	100
○ 3	261-203/332-000	100
○ 4	261-204/332-000	100
○ 5	261-205/332-000	100
○ 6	261-206/332-000	50
○ 7	261-207/332-000	50
○ 8	261-208/332-000	50
○ 9	261-209/332-000	50
○ 10	261-210/332-000	50
○ 11	261-211/332-000	25
○ 12 ③	261-212/332-000	50

2-conductor terminal strip; with push-buttons on one side; with snap-in mounting feet; for 0.6 ... 1.2 mm plate thickness; 3.5 mm mounting hole diameter; also for aluminum rail (210-154) or with mounting foot (209-120) for DIN-35 rail; gray ②

4-conductor terminal strip; with push-buttons on one side; with snap-in mounting feet; for 0.6 ... 1.2 mm plate thickness; 3.5 mm mounting hole diameter; also for aluminum rail (210-154) or with mounting foot (209-120) for DIN-35 rail; gray ②

Pole No.	Item No.	Pack. Unit
○ 2	261-152/331-000	100
○ 3	261-153/331-000	100
○ 4	261-154/331-000	100
○ 5	261-155/331-000	100
○ 6	261-156/331-000	50
○ 7	261-157/331-000	50
○ 8	261-158/331-000	50
○ 9	261-159/331-000	50
○ 10	261-160/331-000	25
○ 11	261-161/331-000	25
○ 12 ③	261-162/331-000	25

Pole No.	Item No.	Pack. Unit
○ 2	261-252/332-000	100
○ 3	261-253/332-000	100
○ 4	261-254/332-000	100
○ 5	261-255/332-000	100
○ 6	261-256/332-000	50
○ 7	261-257/332-000	50
○ 8	261-258/332-000	50
○ 9	261-259/332-000	50
○ 10	261-260/332-000	25
○ 11	261-261/332-000	100
○ 12 ③	261-262/332-000	25

Modular Terminal Block; with Push-Buttons on Both Sides; with Mounting Flange or Snap-In Mounting Foot

2.5 mm²; 261 Series

Technical Data	
0.08 ... 2.5 mm ²	28 ... 14 AWG
500 V/6 kV/3 ①	300 V, 15 A ②
I _N 24 A	300 V, 20 A ③
Terminal block width: 6 mm / 0.236 inch	
8 ... 9 mm / 0.31 ... 0.35 inch	

Technical Data	
0.08 ... 2.5 mm ²	28 ... 14 AWG
500 V/6 kV/3 ①	300 V, 15 A ②
I _N 24 A	300 V, 20 A ③
Terminal block width: 10 mm / 0.394 inch	
8 ... 9 mm / 0.31 ... 0.35 inch	

- ① 500 V = rated voltage
6 kV = rated impulse voltage
3 = pollution degree
(see Section 14)
 - ② Terminal blocks with a blue insulated housing are suitable for Ex i applications.
- Approvals and corresponding ratings, visit www.wago.com

Accessories; 261 Series
Marking accessories, see Section 13

Mounting foot; for DIN-35 rail; snaps onto terminal blocks with snap-in mounting foot; 6.4 mm wide

gray	209-120	25
------	---------	----



Mounting screw; for mounting foot (209-120)

209-119	500 (50)
---------	----------



2-conductor terminal block; with push-buttons on both sides; with mounting flange; for screw or similar mounting types; 3.2 mm mounting hole diameter; with mounting foot (209-123) also for DIN-35 rail

Color	Item No.	Pack. Unit
gray	261-301/341-000	200 (50)
light gray	261-303/341-000	200 (50)
blue	261-304/341-000 ②	200 (50)
orange	261-306/341-000	200 (50)
green-yellow	261-307/341-000	200 (50)

4-conductor terminal block; with push-buttons on both sides; with mounting flange; for screw or similar mounting types; 3.2 mm mounting hole diameter; with mounting foot (209-123) also for DIN-35 rail

Color	Item No.	Pack. Unit
gray	261-331/342-000	200 (50)
light gray	261-333/342-000	200 (50)
blue	261-334/342-000 ②	200 (50)
orange	261-336/342-000	200 (50)
green-yellow	261-337/342-000	200 (50)

Mounting foot with screw; for DIN-35 rail; can be screwed on terminal blocks with mounting flange; 6.4 mm wide

gray	209-123	25
------	---------	----



Mounting adapter; for DIN-35 rail; can be used as end plate; 6.5 mm wide

gray	209-137	25
------	---------	----



Operating tool with a partially insulated shaft; Type 2; (3.5 x 0.5) mm blade

210-720	1
---------	---



2-conductor terminal block; with push-buttons on both sides; with snap-in mounting foot; for 0.6 ... 1.2 mm plate thickness; 3.5 mm mounting hole diameter; also for aluminum rail (210-154) or with mounting foot (209-120) for DIN-35 rail

Color	Item No.	Pack. Unit
gray	261-311/341-000	200 (50)
light gray	261-313/341-000	200 (50)
blue	261-314/341-000 ②	200 (50)
orange	261-316/341-000	200 (50)
green-yellow	261-317/341-000	200 (50)

4-conductor terminal block; with push-buttons on both sides; with snap-in mounting foot; for 0.6 ... 1.2 mm plate thickness; 3.5 mm mounting hole diameter; also for aluminum rail (210-154) or with mounting foot (209-120) for DIN-35 rail

Color	Item No.	Pack. Unit
gray	261-341/342-000	200 (50)
light gray	261-343/342-000	200 (50)
blue	261-344/342-000 ②	200 (50)
orange	261-346/342-000	200 (50)
green-yellow	261-347/342-000	200 (50)

Space-saving 2-conductor end terminal block; with push-buttons on both sides; without protruding snap-in mounting foot; for terminal strips with snap-in mounting feet

Color	Item No.	Pack. Unit
gray	261-321/341-000	200 (50)
light gray	261-323/341-000	200 (50)
blue	261-324/341-000 ②	200 (50)
orange	261-326/341-000	200 (50)
green-yellow	261-327/341-000	200 (50)

Space-saving 4-conductor end terminal block; with push-buttons on both sides; without protruding snap-in mounting foot; for terminal strips with snap-in mounting feet

Color	Item No.	Pack. Unit
gray	261-351/342-000	200 (50)
light gray	261-353/342-000	200 (50)
blue	261-354/342-000 ②	200 (50)
orange	261-356/342-000	200 (50)
green-yellow	261-357/342-000	200 (50)

Accessories; 261 Series
Marking accessories, see Section 13

End plate; with mounting flange

gray	261-361	300 (50)
------	---------	----------



Test plug; with 500 mm cable; 2 mm Ø; max. 42 V

red	210-136	50
-----	---------	----



End plate; with snap-in mounting foot

gray	261-371	300 (50)
------	---------	----------



Test plug; with 500 mm cable; 2 mm Ø; max. 42 V

yellow	210-137	50
--------	---------	----



Comb-style jumper bar; insulated; reduces maximum conductor size to 1.5 mm²; I_N 16 A; gray

2-way	261-402	25
-------	---------	----



Aluminum mounting rail; 1000 mm long; 18 mm wide; 7 mm high

210-154	1
---------	---



Operating tool; insulated; for comb-style jumper bar

2-way	209-132	1
-------	---------	---



Plastic end stop; with WSB marker slot; for aluminum rail (210-154); 6 mm wide

209-122	25
---------	----



Terminal Strip; with Push-Buttons on Both Sides; with Mounting Flanges or Snap-in Mounting Feet

2.5 mm²; 261 Series

Technical Data	
0.08 ... 2.5 mm ²	28 ... 14 AWG
500 V/6 kV/3 ①	
I _N 24 A	
Pole width: 6 mm / 0.236 inch	
8 ... 9 mm / 0.31 ... 0.35 inch	

Technical Data	
0.08 ... 2.5 mm ²	28 ... 14 AWG
500 V/6 kV/3 ①	
I _N 24 A	
Pole width: 10 mm / 0.394 inch	
8 ... 9 mm / 0.31 ... 0.35 inch	

- ① 500 V = rated voltage
6 kV = rated impulse voltage
3 = pollution degree
(see Section 14)
 - ② Terminal strips with a blue insulated housing are suitable for Ex i applications.
Item no. suffixes .../000-006 (upon request)
 - ③ Longer strips and/or mixed-color assemblies are available upon request.
- Approvals and corresponding ratings, visit www.wago.com

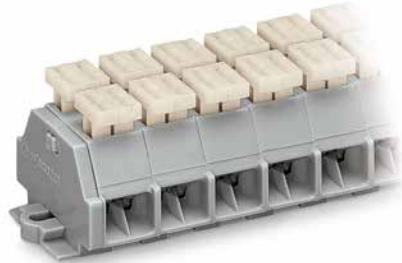
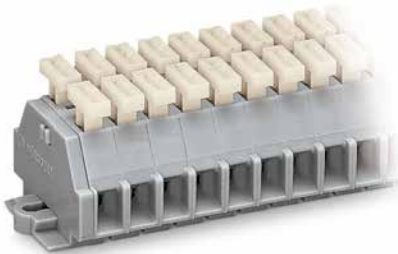

Dimensions in mm

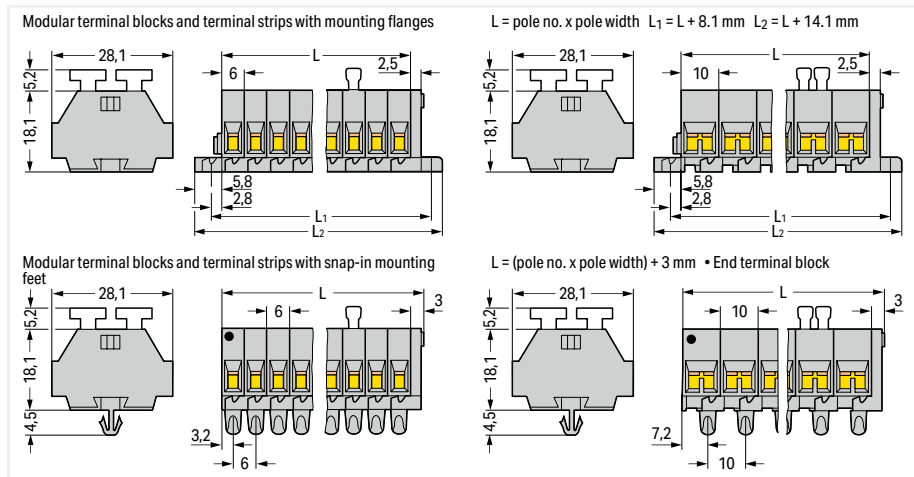

Terminal strip; with mounting flanges; for screw or similar mounting types; 3.2 mm mounting hole diameter (with 209-123 Mounting Foot for DIN-35 rail)



Terminal strip; with snap-in mounting feet; for 0.6 ... 1.2 mm plate thickness; 3.5 mm mounting hole diameter (also for 210-154 Aluminum Rail or with 209-120 Mounting Foot for DIN-35 rail)

2-conductor terminal strip; with push-buttons on both sides; with mounting flanges; for screw or similar mounting types; 3.2 mm mounting hole diameter; with mounting foot (209-123) also for DIN-35 rail; gray ②

4-conductor terminal strip; with push-buttons on both sides; with mounting flanges; for screw or similar mounting types; 3.2 mm mounting hole diameter; with mounting foot (209-123) also for DIN-35 rail; gray ②

Pole No.	Item No.	Pack. Unit
○ 2	261-102/341-000	100
○ 3	261-103/341-000	100
○ 4	261-104/341-000	50
○ 5	261-105/341-000	100
○ 6	261-106/341-000	25
○ 7	261-107/341-000	50
○ 8	261-108/341-000	50
○ 9	261-109/341-000	100
○ 10	261-110/341-000	25
○ 11	261-111/341-000	25
○ 12 ③	261-112/341-000	25

Pole No.	Item No.	Pack. Unit
○ 2	261-202/342-000	100
○ 3	261-203/342-000	100
○ 4	261-204/342-000	100
○ 5	261-205/342-000	100
○ 6	261-206/342-000	50
○ 7	261-207/342-000	50
○ 8	261-208/342-000	100
○ 9	261-209/342-000	50
○ 10	261-210/342-000	25
○ 11	261-211/342-000	25
○ 12 ③	261-212/342-000	50

2-conductor terminal strip; with push-buttons on both sides; with snap-in mounting feet; for 0.6 ... 1.2 mm plate thickness; 3.5 mm mounting hole diameter; also for aluminum rail (210-154) or with mounting foot (209-120) for DIN-35 rail; gray ②

4-conductor terminal strip; with push-buttons on both sides; with snap-in mounting feet; for 0.6 ... 1.2 mm plate thickness; 3.5 mm mounting hole diameter; also for aluminum rail (210-154) or with mounting foot (209-120) for DIN-35 rail; gray ②

Pole No.	Item No.	Pack. Unit
○ 2	261-152/341-000	100
○ 3	261-153/341-000	100
○ 4	261-154/341-000	50
○ 5	261-155/341-000	100
○ 6	261-156/341-000	100
○ 7	261-157/341-000	50
○ 8	261-158/341-000	50
○ 9	261-159/341-000	50
○ 10	261-160/341-000	25
○ 11	261-161/341-000	25
○ 12 ③	261-162/341-000	100

Pole No.	Item No.	Pack. Unit
○ 2	261-252/342-000	100
○ 3	261-253/342-000	100
○ 4	261-254/342-000	100
○ 5	261-255/342-000	100
○ 6	261-256/342-000	50
○ 7	261-257/342-000	50
○ 8	261-258/342-000	50
○ 9	261-259/342-000	50
○ 10	261-260/342-000	25
○ 11	261-261/342-000	100
○ 12 ③	261-262/342-000	25

Modular Terminal Block; with Mounting Flange; with Marker Slot for Mini-WSB Quick Marking System

2.5 mm²; 261 Series

Technical Data

0.08 ... 2.5 mm ²	28 ... 14 AWG
500 V/6 kV/3 ①	300 V, 15 A ②
I _N 24 A	300 V, 20 A ③
Terminal block width: 6 mm / 0.236 inch	
8 ... 9 mm / 0.31 ... 0.35 inch	

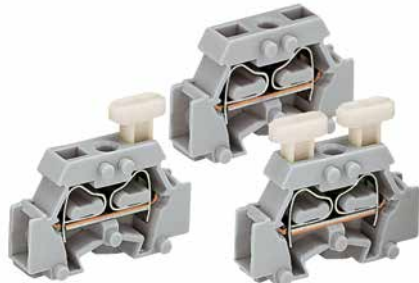

- ① 500 V = rated voltage
6 kV = rated impulse voltage
3 = pollution degree
(see Section 14)
- Approvals and corresponding ratings, visit www.wago.com

Accessories; 261 Series

Marking accessories, see Section 13

Mini-WSB marking card; white; 10 strips with 10 markers/
card; 5 mm wide markers

plain	248-501	5
-------	---------	---

Operating tool with a partially insulated shaft; Type 2; (3.5 x 0.5) mm blade

	210-720	1
--	---------	---

2-conductor terminal block; with mounting flange; for screw or similar mounting types; 3.2 mm mounting hole diameter; with mounting foot (209-123) also for DIN-35 rail

Color	Item No.	Pack. Unit
○ gray	261-411	200 (50)

2-conductor terminal block; with push-button on one side; with mounting flange; for screw or similar mounting types; 3.2 mm mounting hole diameter; with mounting foot (209-123) also for DIN-35 rail

○ gray	261-411/331-000	200 (50)
--------	-----------------	----------

2-conductor terminal block; with push-buttons on both sides; with mounting flange; for screw or similar mounting types; 3.2 mm mounting hole diameter; with mounting foot (209-123) also for DIN-35 rail

○ gray	261-411/341-000	200 (50)
--------	-----------------	----------

Accessories; 261 Series

Marking accessories, see Section 13

End plate; with mounting flange

gray	261-410	300 (50)
------	---------	----------

Comb-style jumper bar; insulated; reduces maximum conductor size to 1 mm²; I_N 10 A; gray

2-way	261-402	25
-------	---------	----



Operating tool; insulated; for comb-style jumper bar

2-way	209-132	1
-------	---------	---



Test plug; with 500 mm cable; 2 mm Ø; max. 42 V

red	210-136	50
-----	---------	----



Mounting foot with screw; for DIN-35 rail; can be screwed on terminal blocks with mounting flange; 6.4 mm wide

gray	209-123	25
------	---------	----



Mounting adapter; for DIN-35 rail; can be used as end plate; 6.5 mm wide

gray	209-137	25
------	---------	----

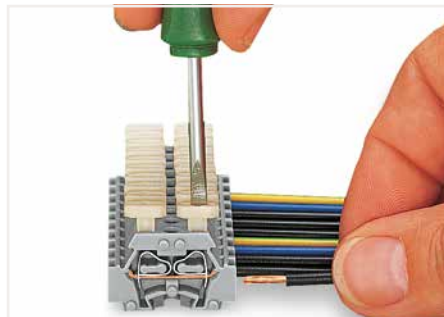

CAGE CLAMP® termination: Inserting a conductor via push-button.



Terminal strip; with marker slot for Mini-WSB Quick Marking System



Testing with voltage tester.

8

Terminal Strip; with Mounting Flanges; with Marker Slot for Mini-WSB Quick Marking System 2.5 mm²; 261 Series

Technical Data	
0.08 ... 2.5 mm ²	28 ... 14 AWG
500 V/6 kV/3 ①	300 V, 15 A ②
I _N 24 A	300 V, 20 A ③
Pole width: 6 mm / 0.236 inch	
8 ... 9 mm / 0.31 ... 0.35 inch	

Technical Data	
0.08 ... 2.5 mm ²	28 ... 14 AWG
500 V/6 kV/3 ①	300 V, 15 A ②
I _N 24 A	300 V, 20 A ③
Pole width: 6 mm / 0.236 inch	
8 ... 9 mm / 0.31 ... 0.35 inch	

- ① 500 V = rated voltage
6 kV = rated impulse voltage
3 = pollution degree
(see Section 14)
 - ② Longer strips are available upon request.
- Approvals and corresponding ratings, visit www.wago.com

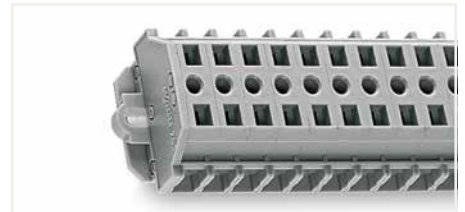
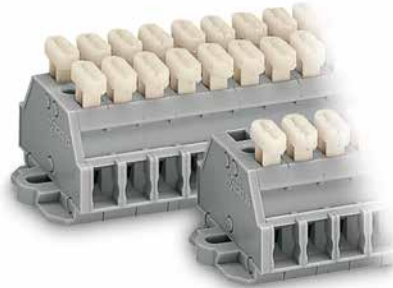
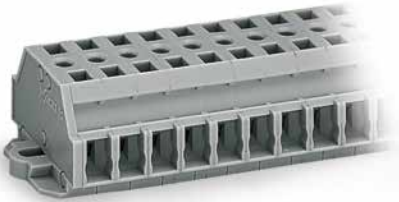

Dimensions in mm

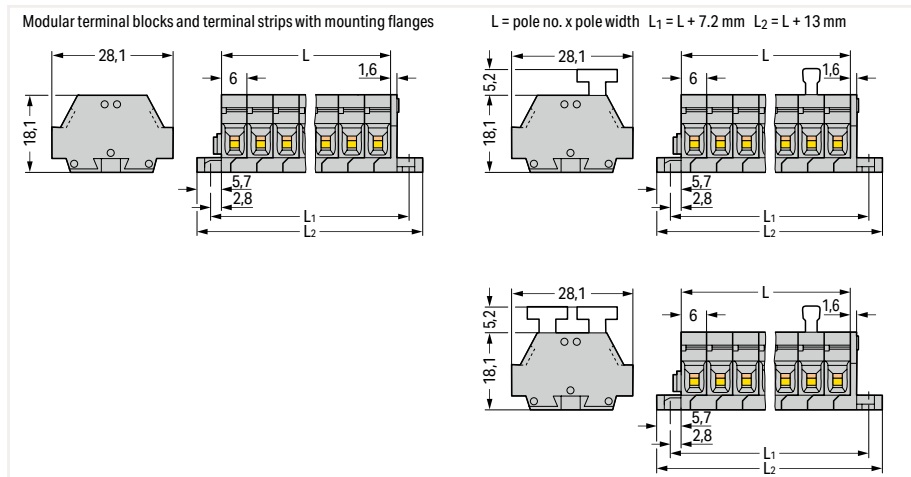

Terminal strip; with mounting flanges; for screw or similar mounting types; 3.2 mm mounting hole diameter (with 209-123 Mounting Foot for DIN-35 rail)



Terminal strip; with mounting flanges; for screw or similar mounting types; 3.2 mm mounting hole diameter (with 209-123 Mounting Foot for DIN-35 rail)

2-conductor terminal strip; with mounting flanges; for screw or similar mounting types; 3.2 mm mounting hole diameter; with mounting foot (209-123) also for DIN-35 rail; gray

Pole No.	Item No.	Pack. Unit
○ 2	261-422	100
○ 3	261-423	100
○ 4	261-424	100
○ 5	261-425	200
○ 6	261-426	50
○ 7	261-427	50
○ 8	261-428	50
○ 9	261-429	50
○ 10	261-430	25
○ 11	261-431	25
○ 12 ②	261-432	25

2-conductor terminal strip; with push-buttons on one side; with mounting flanges; for screw or similar mounting types; 3.2 mm mounting hole diameter; with mounting foot (209-123) also for DIN-35 rail; gray

Pole No.	Item No.	Pack. Unit
○ 2	261-422/331-000	100
○ 3	261-423/331-000	100
○ 4	261-424/331-000	100
○ 5	261-425/331-000	100
○ 6	261-426/331-000	50
○ 7	261-427/331-000	50
○ 8	261-428/331-000	50
○ 9	261-429/331-000	50
○ 10	261-430/331-000	25
○ 11	261-431/331-000	25
○ 12 ③	261-432/331-000	25

2-conductor terminal strip; with push-buttons on both sides; with mounting flanges; for screw or similar mounting types; 3.2 mm mounting hole diameter; with mounting foot (209-123) also for DIN-35 rail; gray

Pole No.	Item No.	Pack. Unit
○ 2	261-422/341-000	100
○ 3	261-423/341-000	100
○ 4	261-424/341-000	100
○ 5	261-425/341-000	100
○ 6	261-426/341-000	50
○ 7	261-427/341-000	50
○ 8	261-428/341-000	50
○ 9	261-429/341-000	50
○ 10	261-430/341-000	25
○ 11	261-431/341-000	25
○ 12 ④	261-432/341-000	25

Modular Terminal Block; with Mounting Flange or Snap-In Mounting Foot 4 mm²; 262 Series

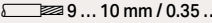
Technical Data	
0.08 ... 4 mm ²	28 ... 12 AWG
630 V/8 kV/3 ①	300 V, 20 A ②
I _N 24 A	300 V, 20 A ③
Terminal block width: 7 mm / 0.276 inch	
 9 ... 10 mm / 0.35 ... 0.39 inch	

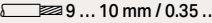
Technical Data	
0.08 ... 4 mm ²	28 ... 12 AWG
630 V/8 kV/3 ①	300 V, 20 A ②
I _N 32 A	300 V, 20 A ③
Terminal block width: 12 mm / 0.472 inch	
 9 ... 10 mm / 0.35 ... 0.39 inch	

- ① 630 V = rated voltage
8 kV = rated impulse voltage
3 = pollution degree
(see Section 14)
 - ② Terminal blocks with a blue insulated housing are suitable for Ex i applications.
- See application notes for:
Test plug module, page 474
- Approvals and corresponding ratings,
visit www.wago.com



Accessories; 262 Series
Marking accessories, see Section 13

Mounting foot; for DIN-35 rail; snaps onto terminal blocks with snap-in mounting foot; 6.4 mm wide	gray	209-120	25
--	------	---------	----



Mounting screw; for mounting foot (209-120)	209-119	500 (50)
---	---------	----------

2-conductor terminal block; with mounting flange; for screw or similar mounting types; 3.2 mm mounting hole diameter; with mounting foot (209-123) also for DIN-35 rail

Color	Item No.	Pack. Unit
gray	262-301	100 (50)
blue	262-304 ②	100 (50)
orange	262-306	100 (50)
green-yellow	262-307	100 (50)

4-conductor terminal block; with mounting flange; for screw or similar mounting types; 3.2 mm mounting hole diameter; with mounting foot (209-123) also for DIN-35 rail

Color	Item No.	Pack. Unit
gray	262-331	100 (50)
blue	262-334 ②	100 (50)
orange	262-336	100 (50)
green-yellow	262-337	100 (50)

Mounting foot with screw; for DIN-35 rail; can be screwed on terminal blocks with mounting flange; 6.4 mm wide	gray	209-123	25
--	------	---------	----



2-conductor terminal block; with snap-in mounting foot; for 0.6 ... 1.2 mm plate thickness; 3.5 mm mounting hole diameter; also for aluminum rail (210-154) or with mounting foot (209-120) for DIN-35 rail

Color	Item No.	Pack. Unit
gray	262-311	100 (50)
blue	262-314 ②	100 (50)
orange	262-316	100 (50)
green-yellow	262-317	100 (50)

4-conductor terminal block; with snap-in mounting foot; for 0.6 ... 1.2 mm plate thickness; 3.5 mm mounting hole diameter; also for aluminum rail (210-154) or with mounting foot (209-120) for DIN-35 rail

Color	Item No.	Pack. Unit
gray	262-341	100 (50)
blue	262-344 ②	100 (50)
orange	262-346	100 (50)
green-yellow	262-347	100 (50)

Mounting adapter; for DIN-35 rail; can be used as end plate; 6.5 mm wide	gray	209-137	25
--	------	---------	----



Operating tool with a partially insulated shaft; Type 2; (3.5 x 0.5) mm blade	210-720	1
---	---------	---



Space-saving 2-conductor end terminal block; without protruding snap-in mounting foot; for terminal strips with snap-in mounting feet

Color	Item No.	Pack. Unit
gray	262-321	100 (50)
blue	262-324 ②	100 (50)
orange	262-326	100 (50)
green-yellow	262-327	100 (50)

Space-saving 4-conductor end terminal block; without protruding snap-in mounting foot; for terminal strips with snap-in mounting feet

Color	Item No.	Pack. Unit
gray	262-351	100 (50)
blue	262-354 ②	100 (50)
orange	262-356	100 (50)
green-yellow	262-357	100 (50)

Accessories; item-specific
Test plug module; snaps together; 7 mm wide

gray	249-137	100 (25)
------	---------	----------

Accessories; item-specific
Test plug module; snaps together; 12 mm wide

gray	249-140	100 (25)
------	---------	----------

Accessories; 262 Series
Marking accessories, see Section 13

End plate; with mounting flange	gray	262-361	300 (50)
---------------------------------	------	---------	----------

Test plug; with 500 mm cable; 2 mm Ø; max. 42 V	red	210-136	50
---	-----	---------	----

End plate; with snap-in mounting foot	gray	262-371	300 (50)
---------------------------------------	------	---------	----------

Test plug; with 500 mm cable; 2 mm Ø; max. 42 V	yellow	210-137	50
---	--------	---------	----

Comb-style jumper bar; insulated; reduces maximum conductor size to 2.5 mm ² ; I _N 16 A; gray	2-way	262-402	25
---	-------	---------	----

Aluminum mounting rail; 1000 mm long; 18 mm wide; 7 mm high	210-154	1
---	---------	---

Operating tool; insulated; for comb-style jumper bar	2-way	209-132	1
--	-------	---------	---

Plastic end stop; with WSB marker slot; for aluminum rail (210-154); 6 mm wide	209-122	25
--	---------	----

Sold & Serviced By:

 Toll Free Phone (877) SERV098
www.electromate.com
sales@electromate.com

Terminal Strip; with Mounting Flanges or Snap-in Mounting Feet 4 mm²; 262 Series

Technical Data	
0.08 ... 4 mm ²	28 ... 12 AWG
630 V/8 kV/3 ①	300 V, 20 A ②
I _N 24 A	300 V, 20 A ③
Pole width: 7 mm / 0.276 inch	
9 ... 10 mm / 0.35 ... 0.39 inch	

Technical Data	
0.08 ... 4 mm ²	28 ... 12 AWG
630 V/8 kV/3 ①	300 V, 20 A ②
I _N 32 A	300 V, 20 A ③
Pole width: 12 mm / 0.472 inch	
9 ... 10 mm / 0.35 ... 0.39 inch	

- ① 630 V = rated voltage
8 kV = rated impulse voltage
3 = pollution degree
(see Section 14)
 - ② Terminal strips with a blue insulated housing are suitable for Ex i applications.
Item no. suffixes .../000-006 (upon request)
 - ③ Longer strips and/or mixed-color assemblies are available upon request.
- Approvals and corresponding ratings, visit www.wago.com

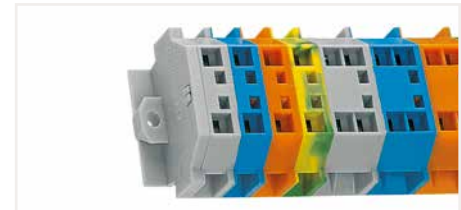
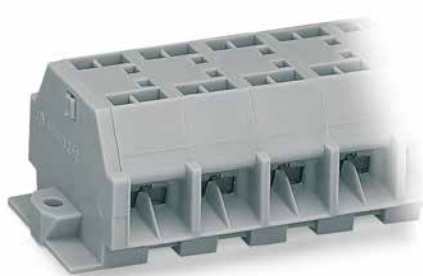
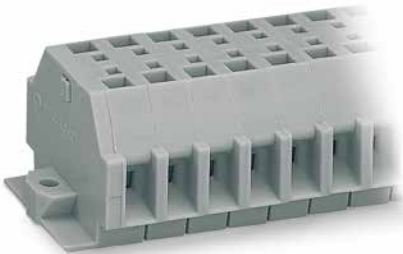

Terminal strip; with mounting flanges; for screw or similar mounting types; 3.2 mm mounting hole diameter (with 209-123 Mounting Foot for DIN-35 rail)

Dimensions in mm

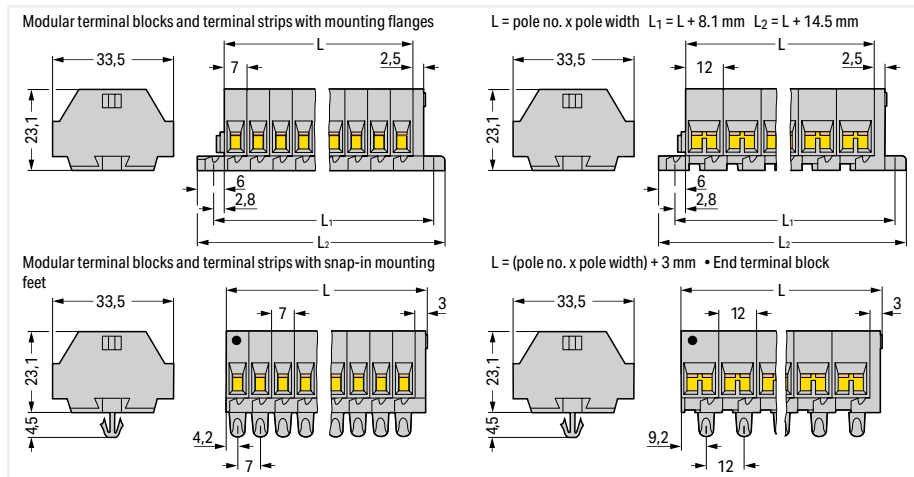

Terminal strip; with snap-in mounting feet; for 0.6 ... 1.2 mm plate thickness; 3.5 mm mounting hole diameter (also for 210-154 Aluminum Rail or with 209-120 Mounting Foot for DIN-35 rail)

2-conductor terminal strip; with mounting flanges; for screw or similar mounting types; 3.2 mm mounting hole diameter; with mounting foot (209-123) also for DIN-35 rail; gray ②

Pole No.	Item No.	Pack. Unit
○ 2	262-102	100
○ 3	262-103	100
○ 4	262-104	100
○ 5	262-105	100
○ 6	262-106	100
○ 7	262-107	100
○ 8	262-108	100
○ 9	262-109	50
○ 10	262-110	25
○ 11	262-111	25
○ 12 ③	262-112	25

4-conductor terminal strip; with mounting flanges; for screw or similar mounting types; 3.2 mm mounting hole diameter; with mounting foot (209-123) also for DIN-35 rail; gray ②

Pole No.	Item No.	Pack. Unit
○ 2	262-202	100
○ 3	262-203	100
○ 4	262-204	100
○ 5	262-205	100
○ 6	262-206	50
○ 7	262-207	50
○ 8	262-208	50
○ 9	262-209	50
○ 10	262-210	25
○ 11	262-211	25
○ 12 ③	262-212	25

2-conductor terminal strip; with snap-in mounting feet; for 0.6 ... 1.2 mm plate thickness; 3.5 mm mounting hole diameter; also for aluminum rail (210-154) or with mounting foot (209-120) for DIN-35 rail; gray ②

Pole No.	Item No.	Pack. Unit
○ 2	262-152	100
○ 3	262-153	100
○ 4	262-154	100
○ 5	262-155	100
○ 6	262-156	50
○ 7	262-157	50
○ 8	262-158	50
○ 9	262-159	50
○ 10	262-160	25
○ 11	262-161	25
○ 12 ③	262-162	25

4-conductor terminal strip; with snap-in mounting feet; for 0.6 ... 1.2 mm plate thickness; 3.5 mm mounting hole diameter; also for aluminum rail (210-154) or with mounting foot (209-120) for DIN-35 rail; gray ②

Pole No.	Item No.	Pack. Unit
○ 2	262-252	100
○ 3	262-253	100
○ 4	262-254	100
○ 5	262-255	100
○ 6	262-256	50
○ 7	262-257	50
○ 8	262-258	50
○ 9	262-259	50
○ 10	262-260	25
○ 11	262-261	25
○ 12 ③	262-262	25

Modular Ex Terminal Block; with Mounting Flange or Snap-In Mounting Foot 4 mm²; 262 Series

Technical Data	
0.5 ... 4 mm²	28 ... 12 AWG
550 V	300 V, 20 A VA
I _N 23 A	300 V, 20 A AE
Terminal block width: 7 mm / 0.276 inch	
 9 ... 10 mm / 0.35 ... 0.39 inch	

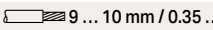
Technical Data	
0.5 ... 4 mm²	28 ... 12 AWG
550 V	300 V, 20 A VA
I _N 30 A	300 V, 20 A AE
Terminal block width: 12 mm / 0.472 inch	
 9 ... 10 mm / 0.35 ... 0.39 inch	

① Using crimped ferrules for corrosion protection, the rated cross section is reduced by one size. For conductor types and conductor preparation, see Section 14 "Electrical Equipment for Hazardous Environments."

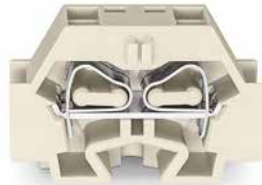

2-conductor Ex e II terminal block; with mounting flange; for screw or similar mounting types; 3.2 mm mounting hole diameter; with mounting foot (209-123) also for DIN-35 rail

Color	Item No.	Pack. Unit
○ light gray AE	262-130	100 (50)

4-conductor Ex e II terminal block; with mounting flange; for screw or similar mounting types; 3.2 mm mounting hole diameter; with mounting foot (209-123) also for DIN-35 rail

Color	Item No.	Pack. Unit
○ light gray AE	262-230	100 (50)

2-conductor Ex e II terminal block; with snap-in mounting foot; for 0.6 ... 1.2 mm plate thickness; 3.5 mm mounting hole diameter; also for aluminum rail (210-154) or with mounting foot (209-120) for DIN-35 rail

○ light gray AE	262-180	100 (50)
------------------------	---------	----------

4-conductor Ex e II terminal block; with snap-in mounting foot; for 0.6 ... 1.2 mm plate thickness; 3.5 mm mounting hole diameter; also for aluminum rail (210-154) or with mounting foot (209-120) for DIN-35 rail

○ light gray AE	262-280	100 (50)
------------------------	---------	----------

Space-saving 2-conductor Ex e II end terminal block; without protruding snap-in mounting foot; for terminal strips with snap-in mounting feet

○ light gray AE	262-181	100 (50)
------------------------	---------	----------

Space-saving 4-conductor Ex e II end terminal block; without protruding snap-in mounting foot; for terminal strips with snap-in mounting feet

○ light gray AE	262-281	100 (50)
------------------------	---------	----------

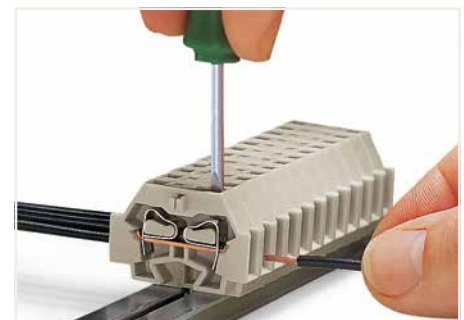

CAGE CLAMP® termination: Inserting a conductor.

Accessories; 262 Series

Marking accessories, see Section 13

End plate; with mounting flange

gray	262-363	50
------	---------	----

End plate; with snap-in mounting foot

gray	262-373	50
------	---------	----

Mounting foot; for DIN-35 rail; snaps onto terminal blocks with snap-in mounting foot; 6.4 mm wide

gray	209-120	25
------	---------	----

Mounting screw; for mounting foot (209-120)

	209-119	500 (50)
--	---------	----------

Comb-style jumper bar; insulated; reduces maximum conductor size to 2.5 mm²; I_N 16 A; gray

2-way	262-402	25
-------	---------	----

Mounting foot with screw; for DIN-35 rail; can be screwed on terminal blocks with mounting flange; 6.4 mm wide

gray	209-123	25
------	---------	----

Operating tool; insulated; for comb-style jumper bar

2-way	209-132	1
-------	---------	---

Mounting adapter; for DIN-35 rail; can be used as end plate; 6.5 mm wide

gray	209-137	25
------	---------	----

Aluminum mounting rail; 1000 mm long; 18 mm wide; 7 mm high

	210-154	1
--	---------	---

Operating tool with a partially insulated shaft; Type 2; (3.5 x 0.5) mm blade

	210-720	1
--	---------	---

Plastic end stop; with WSB marker slot; for aluminum rail (210-154); 6 mm wide

	209-122	25
--	---------	----

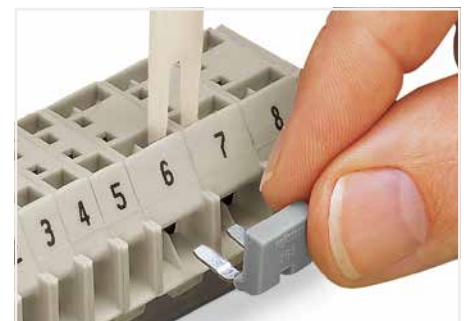

Commoning with comb-style jumper bar.

8

Ex Terminal Strip; with Mounting Flanges or Snap-in Mounting Feet 4 mm²; 262 Series

Technical Data	
0.5 ... 4 mm ²	28 ... 12 AWG
550 V	300 V, 20 A
I _N 23 A	300 V, 20 A
Pole width: 7 mm / 0.276 inch	
9 ... 10 mm / 0.35 ... 0.39 inch	

Technical Data	
0.5 ... 4 mm ²	28 ... 12 AWG
550 V	300 V, 20 A
I _N 30 A	300 V, 20 A
Pole width: 12 mm / 0.472 inch	
9 ... 10 mm / 0.35 ... 0.39 inch	

Using crimped ferrules for corrosion protection, the rated cross section is reduced by one size. For conductor types and conductor preparation, see Section 14 "Electrical Equipment for Hazardous Environments."

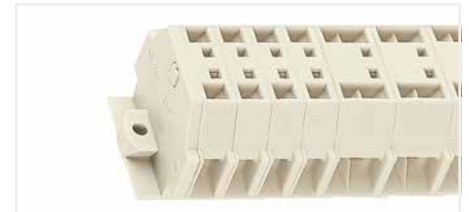
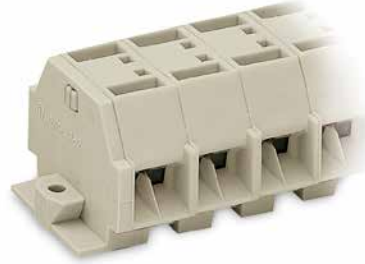

Terminal strip; with mounting flanges; for screw or similar mounting types; 3.2 mm mounting hole diameter (with 209-123 Mounting Foot for DIN-35 rail)

Dimensions in mm

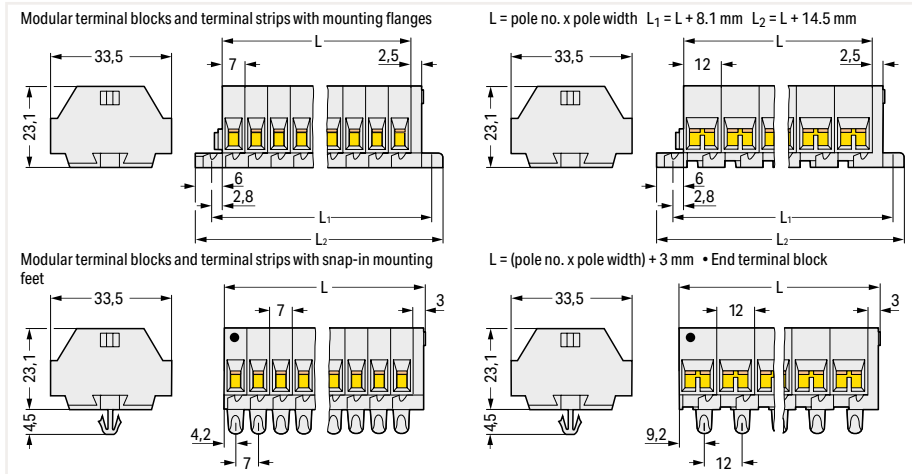

Terminal strip; with snap-in mounting feet; for 0.6 ... 1.2 mm plate thickness; 3.5 mm mounting hole diameter (also for 210-154 Aluminum Rail or with 209-120 Mounting Foot for DIN-35 rail)

2-conductor Ex e II terminal strip; with mounting flanges; for screw or similar mounting types; 3.2 mm mounting hole diameter; with mounting foot (209-123) also for DIN-35 rail; gray

Pole No.	Item No.	Pack. Unit
○ 2	262-132	100
○ 3	262-133	100
○ 4	262-134	100
○ 5	262-135	100
○ 6	262-136	100
○ 7	262-137	50
○ 8	262-138	50
○ 9	262-139	50
○ 10	262-140	25
○ 11	262-141	25
○ 12 ②	262-142	25

4-conductor Ex e II terminal strip; with mounting flanges; for screw or similar mounting types; 3.2 mm mounting hole diameter; with mounting foot (209-123) also for DIN-35 rail; gray

Pole No.	Item No.	Pack. Unit
○ 2	262-232	100
○ 3	262-233	100
○ 4	262-234	100
○ 5	262-235	100
○ 6	262-236	50
○ 7	262-237	50
○ 8	262-238	50
○ 9	262-239	50
○ 10	262-240	25
○ 11	262-241	25
○ 12 ②	262-242	25

2-conductor Ex e II terminal strip; with snap-in mounting feet; for 0.6 ... 1.2 mm plate thickness; 3.5 mm mounting hole diameter; also for aluminum rail (210-154) or with mounting foot (209-120) for DIN-35 rail; gray

Pole No.	Item No.	Pack. Unit
○ 2	262-182	100
○ 3	262-183	100
○ 4	262-184	100
○ 5	262-185	100
○ 6	262-186	50
○ 7	262-187	50
○ 8	262-188	50
○ 9	262-189	50
○ 10	262-190	25
○ 11	262-191	25
○ 12 ②	262-192	25

4-conductor Ex e II terminal strip; with snap-in mounting feet; for 0.6 ... 1.2 mm plate thickness; 3.5 mm mounting hole diameter; also for aluminum rail (210-154) or with mounting foot (209-120) for DIN-35 rail; gray

Pole No.	Item No.	Pack. Unit
○ 2	262-282	100
○ 3	262-283	100
○ 4	262-284	100
○ 5	262-285	100
○ 6	262-286	50
○ 7	262-287	50
○ 8	262-288	50
○ 9	262-289	50
○ 10	262-290	25
○ 11	262-291	25
○ 12 ②	262-292	25

Test Plug Module; for Terminal Strips without Push-Buttons 260, 261 and 262 Series

Technical Data	
for 260 Series	
Test voltage: 250 V / 500 V ①	
Test current: 0.5 A / 6 A ②	
Middle pressure: 2.2 N per pole	



Technical Data	
for 261 Series (also 264 Series)	
Test voltage: 400 V / 800 V ①	
Test current: 0.5 A / 6 A ②	
Middle pressure: 2.2 N per pole	



Technical Data	
for 262 Series	
Test voltage: 500 V / 800 V ①	
Test current: 0.5 A / 6 A ②	
Middle pressure: 2.2 N per pole	



Test plug module; without locking latches; snaps together; for 2-conductor terminal blocks Module width: 5 mm		
Color	Item No.	Pack. Unit
○ gray	249-135	100 (25)

Test plug module; without locking latches; snaps together; for 2-conductor terminal blocks Module width: 6 mm		
Color	Item No.	Pack. Unit
○ gray	249-136	100 (25)

Test plug module; without locking latches; snaps together; for 2-conductor terminal blocks Module width: 7 mm		
Color	Item No.	Pack. Unit
○ gray	249-137	100 (25)

Test plug module; without locking latches; snaps together; for 4-conductor terminal blocks Module width: 8 mm		
Color	Item No.	Pack. Unit
○ gray	249-138	100 (25)

Test plug module; without locking latches; snaps together; for 4-conductor terminal blocks Module width: 10 mm		
Color	Item No.	Pack. Unit
○ gray	249-139	100 (25)

Test plug module; without locking latches; snaps together; for 4-conductor terminal blocks Module width: 12 mm		
Color	Item No.	Pack. Unit
○ gray	249-140	100 (25)

Test plug module; with locking latches; snaps together; for 2-conductor terminal blocks Module width: 5 mm		
Color	Item No.	Pack. Unit
○ gray	260-404	100 (25)

Test plug module; with locking latches; snaps together; for 2-conductor terminal blocks Module width: 6 mm		
Color	Item No.	Pack. Unit
○ gray	261-404	100 (25)

Test plug module; with locking latches; snaps together; for 4-conductor terminal blocks Module width: 8 mm		
Color	Item No.	Pack. Unit
○ gray	260-405	100 (25)

Test plug module; without locking latches; snaps together; for 4-conductor terminal blocks Module width: 10 mm		
Color	Item No.	Pack. Unit
○ gray	261-405	100 (25)

Accessories; for L-type test plug modules

Test plug; with 500 mm cable; 2 mm Ø; max. 42 V		
red	210-136	50



Test plug; with 500 mm cable; 2.3 mm Ø; max. 42 V		
yellow	210-137	50



- ❶ Maximum test voltage (touch contact): 48 V (test pins are not touch-proof)
- ❷ Maximum test current (touch contact): 0.5 A
Maximum test current: 6 A (if the test pins are securely connected in the clamping units)

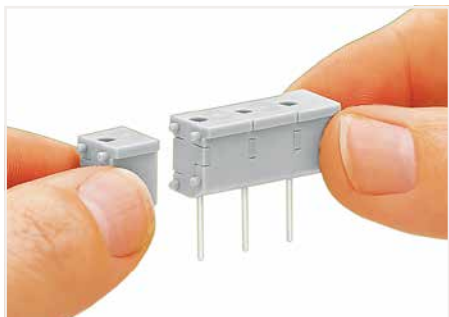

Snapping individual modules together to assemble a multi-pole test plug module.

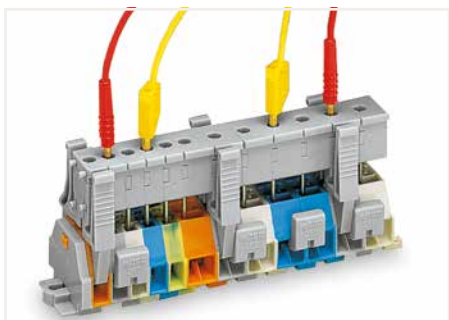

Testing via test plug modules snapped onto a terminal strip – wired or unwired. As touch contact is made with the CAGE CLAMP® (spring steel) unit, this testing type is limited to maximum 0.5 A.

Distance between locking devices must be approximately 35 ... 40 mm.



Testing after the conductors have been terminated.





WAGO Chassis-Mount Terminal Strips

WAGO Field-Wiring Terminal Blocks

WAGO Chassis-Mount Terminal Strips

WAGO Field-Wiring Terminal Blocks

Side-Entry Wiring

			Page
	4-Conductor Chassis-Mount Terminal Strips 0.5 ... 4 mm ² (20 ... 12 AWG)	862 Series	480
	Field-Wiring Terminal Blocks 0.5 ... 2.5 mm ² (18 ... 12 AWG)	294 Series	489

4-Conductor Chassis-Mount Terminal Strips

862 Series

Description and Installation

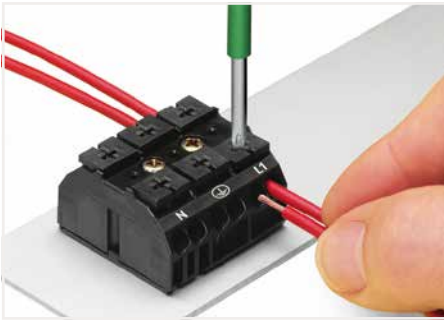

Terminating four conductors per pole – solid and fine-stranded.



Inserting a conductor via push-button.



Testing with a 2 mm Ø test plug.



Makes an automatic contact to the mounting plate. The plate's varnish is instantly penetrated.



Commoning using a comb-style jumper bar (862-482).

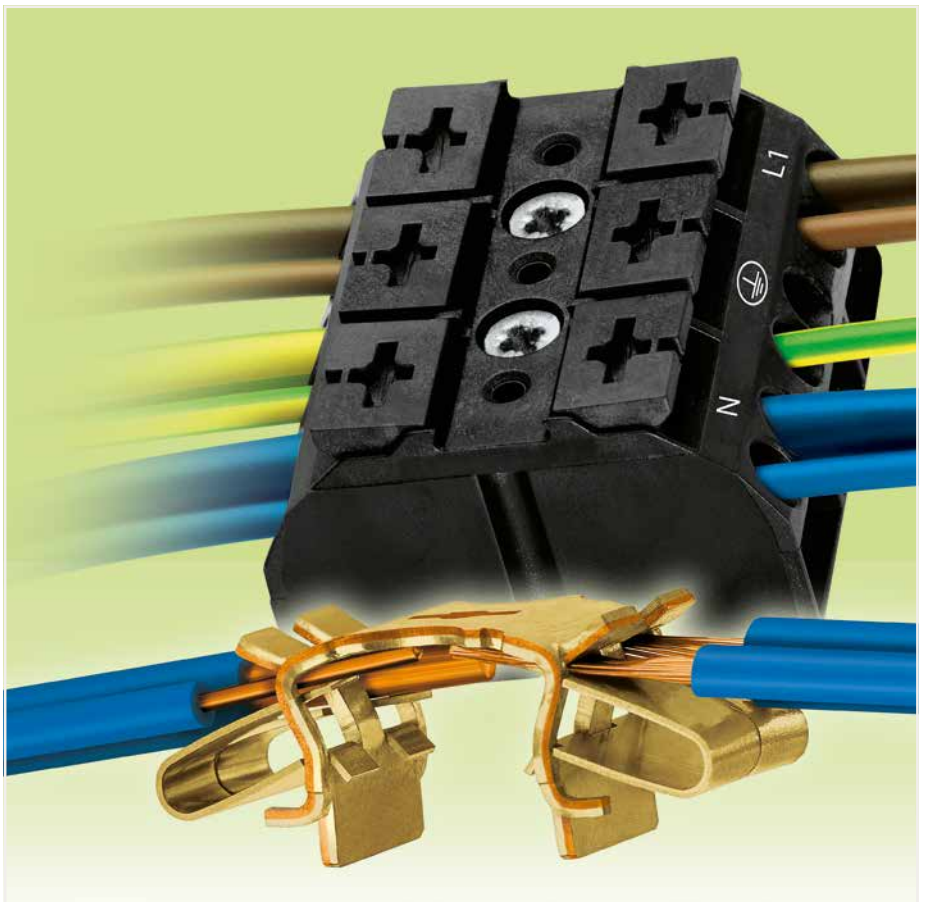

Cost-Effective Features:

WAGO's 862 Series Chassis-Mount Terminal Strips were developed specifically to minimize wiring costs, while accommodating requirements for flexible mounting, multiple connection points and easy usage:

- Equipped with Push-in CAGE CLAMP®, the 862 Series connects up to four conductors sized 0.5 to 4 mm² (20 ... 12 AWG). Due to multiple connection points per pole, different conductor sizes can be used within the same terminal block position.
- For factory wiring, Push-in CAGE CLAMP® connection technology allows solid conductors, ultrasonically bonded conductors from 0.5 ... 4 mm² (20 ... 12 AWG; length of bonded conductor end: min. 10 mm) or fine-stranded conductors with ferrules from 1 to 2.5 mm² (18 ... 14 AWG) to be terminated by simply pushing them into the unit.
- Convenient automatic grounding contact (optional)
- Snap-in mounting feet for fast assembly
- Push-buttons for easy installation with an operating tool or by hand
- Built-in test points simplify testing with 2 mm Ø test plug
- Flexible marking options with standard marking (pre-marked), marking strip or custom marked for large orders

Push-in CAGE CLAMP® terminates the following copper conductors:
solid stranded

fine-stranded, also with tinned single strands

fine-stranded, tip-bonded

fine-stranded, with ferrule (gastight crimped)

fine-stranded, with pin terminal (gastight crimped)

For aluminum conductors, see notes in Section 14. With ferruled conductors, it is necessary to use a terminal block one size smaller than the conductor's nominal cross section.

Mounting Types

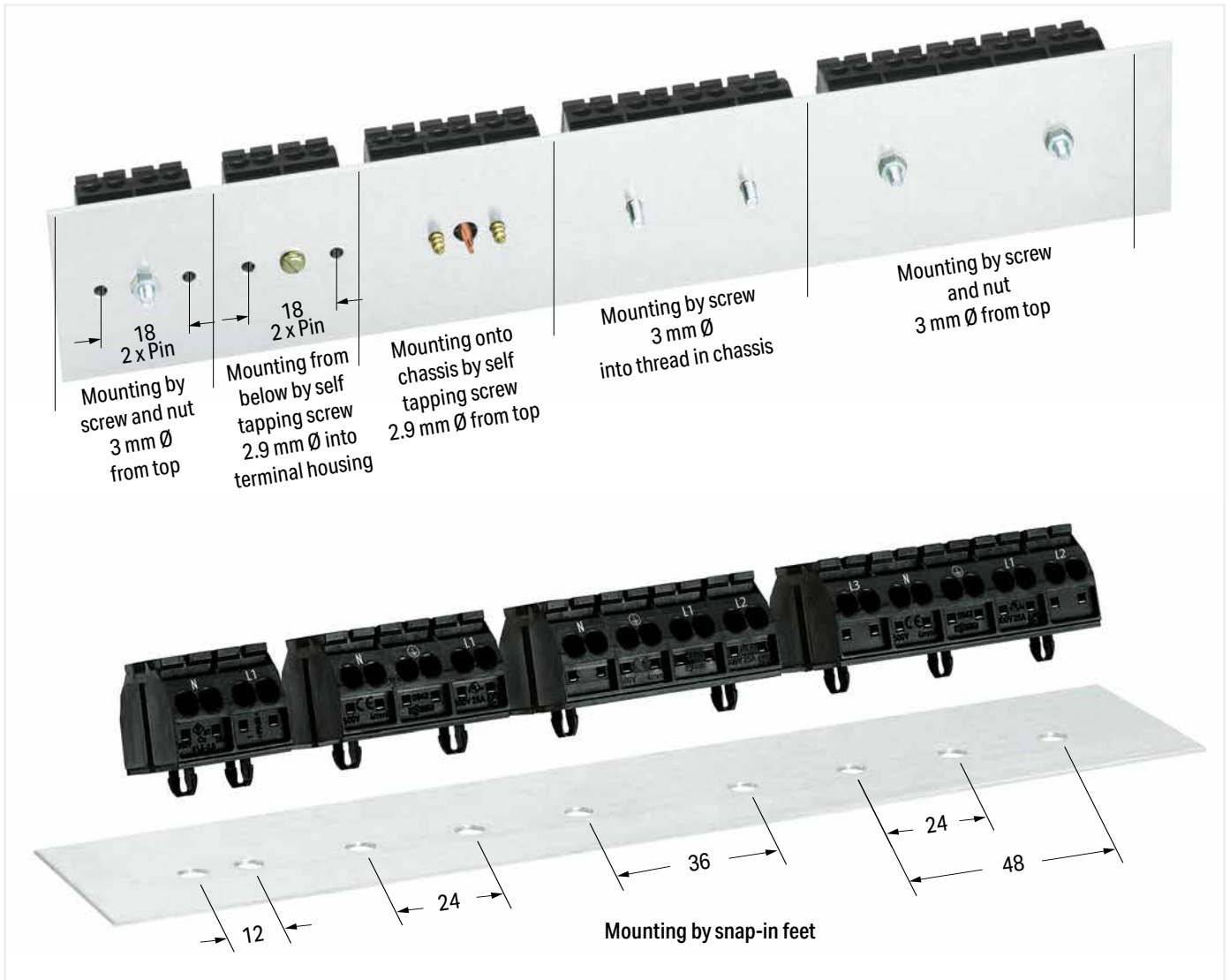

Dimensions in mm

9

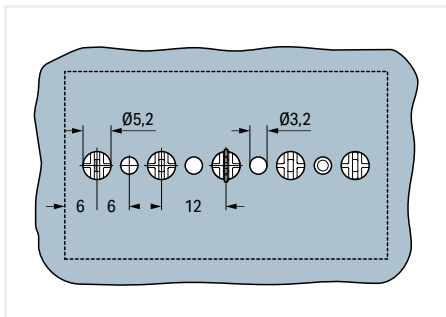

Dimensions (in mm) for ground contact and snap-in mounting foot (5.2 mm Ø)

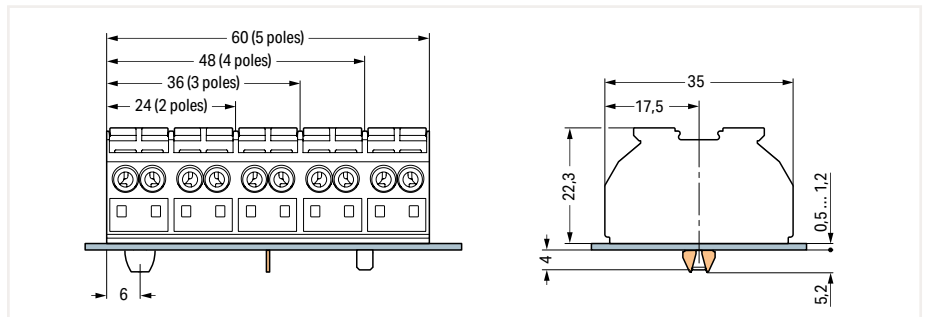

Dimensions (in mm) for chassis-mount terminal strips

4-Conductor Chassis-Mount Terminal Strip; 2-Pole 4 mm²; 862 Series

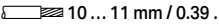
Technical Data	
0.5 ... 4 mm ² ①	20 ... 12 AWG
500 V/6 kV/3 ②	300 V, 20 A ③
I _N 32 A	300 V, 20 A ④
 10 ... 11 mm / 0.39 ... 0.43 inch	



4-conductor chassis-mount terminal strip; for mounting via screw and nut (3 mm Ø) or for self-tapping screw (2.9 mm Ø) from top; with 2 x pin; black

	Item No.	Pack. Unit
● N-L1	862-2552	500
● L1-N	862-1552	500
● L1-N ⑤	862-1552/999-950 ③	500
● plain	862-552	500

4-conductor chassis-mount terminal strip; for self-tapping screw (2.9 mm Ø) from below; with 2 x pin; black

● N-L1	862-2562	500
● L1-N	862-1562	500
● L1-N ⑤	862-1562/999-950 ③	500
● plain	862-562	500

4-conductor chassis-mount terminal strip; 1 snap-in foot per pole; black

● N-L1	862-2532	500
● L1-N	862-1532	500
● L1-N ⑤	862-1532/999-950 ③	500
● plain	862-532	500

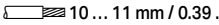
Technical Data	
0.5 ... 4 mm ² ①	20 ... 12 AWG
500 V/6 kV/3 ②	300 V, 20 A ③
I _N 32 A	300 V, 20 A ④
 10 ... 11 mm / 0.39 ... 0.43 inch	



4-conductor chassis-mount terminal strip; for mounting via screw and nut (3 mm Ø) or for self-tapping screw (2.9 mm Ø) from top; with 2 x pin; white

	Item No.	Pack. Unit
○ N-L1	862-2652	500
○ L1-N	862-1652	500
○ L1-N ⑤	862-1652/999-950 ③	500
○ plain	862-652	500

4-conductor chassis-mount terminal strip; for self-tapping screw (2.9 mm Ø) from below; with 2 x pin; white

○ N-L1	862-2662	500
○ L1-N	862-1662	500
○ L1-N ⑤	862-1662/999-950 ③	500
○ plain	862-662	500

4-conductor chassis-mount terminal strip; 1 snap-in foot per pole; white

○ N-L1	862-2632	500
○ L1-N	862-1632	500
○ L1-N ⑤	862-1632/999-950 ③	500
○ plain	862-632	500

① Conductor range: 0.5 ... 4 mm² "s+f-st"; Push-in termination: 1 ... 4 mm² "s" and 1 ... 2.5 mm² "insulated ferrules, 12 mm"
Depending on the conductor characteristic, a conductor with a smaller cross section can also be inserted via push-in termination.

② 500 V = rated voltage
6 kV = rated impulse voltage
3 = pollution degree
(see Section 14)

③ Terminal blocks with an Ex mark are suitable for Ex e II applications.
440 V; 28 A
(see Section 14)

Approvals and corresponding ratings, visit www.wago.com

Accessories; 862 Series

Appropriate marking system:
Marking strips

Comb-style jumper bar; for conductor entry; insulated; terminated conductor entry; I_N 32 A

	black	862-482	5
---	-------	---------	---

Test plug; with 500 mm cable; 2 mm Ø; max. 42 V

	red	210-136	50
--	-----	---------	----

Test plug; with 500 mm cable; 2 mm Ø; max. 42 V

	yellow	210-137	50
---	--------	---------	----

Marking strip; on reel; 7.5 mm wide; not stretchable; plain; snap-on type

	white	709-178	1
---	-------	---------	---

Operating tool with a partially insulated shaft; Type 2; (3.5 x 0.5) mm blade

		210-720	1
---	--	---------	---

4-Conductor Chassis-Mount Terminal Strip; 3-Pole 4 mm²; 862 Series

Technical Data

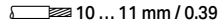
0.5 ... 4 mm ² ①	20 ... 12 AWG
500 V/6 kV/3 ②	300 V, 20 A ③
I _N 32 A	300 V, 20 A ④
 10 ... 11 mm / 0.39 ... 0.43 inch	



4-conductor chassis-mount terminal strip; for mounting via screw and nut (3 mm Ø) or for self-tapping screw (2.9 mm Ø) from top; black

	Item No.	Pack. Unit
● N-GND-L1; without ground contact	862-2503	250
● GND-N-L1; without ground contact	862-1503	250
● GND-N-L1; without ground contact ③	862-1503/999-950 ③	250
● plain; without ground contact	862-503	250
● N-GND-L1; with ground contact	862-8503	250
● GND-L1-N; with ground contact	862-9503	250

4-conductor chassis-mount terminal strip; 1 snap-in foot per pole; black

● N-GND-L1; without ground contact	862-2533	250
● GND-N-L1; without ground contact	862-1533	250
● GND-N-L1; without ground contact ③	862-1533/999-950 ③	250
● plain; without ground contact	862-533	250
● N-GND-L1; with ground contact	862-8533	250
● GND-L1-N; with ground contact	862-9533	250

4-conductor chassis-mount terminal strip; Snap-in foot at pos. 1+3; black

● N-GND-L1; without ground contact	862-2593	250
● GND-N-L1; without ground contact	862-1593	250
● GND-N-L1; without ground contact ③	862-1593/999-950 ③	250
● plain; without ground contact	862-593	250
● N-GND-L1; with ground contact	862-8593	250
● GND-N-L1; with ground contact	862-9593	250

Technical Data

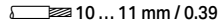
0.5 ... 4 mm ² ①	20 ... 12 AWG
500 V/6 kV/3 ②	300 V, 20 A ③
I _N 32 A	300 V, 20 A ④
 10 ... 11 mm / 0.39 ... 0.43 inch	



4-conductor chassis-mount terminal strip; for mounting via screw and nut (3 mm Ø) or for self-tapping screw (2.9 mm Ø) from top; white

○ N-GND-L1; without ground contact	862-2603	250
○ GND-N-L1; without ground contact	862-1603	250
○ GND-N-L1; without ground contact ③	862-1603/999-950 ③	250
○ plain; without ground contact	862-603	250
○ N-GND-L1; with ground contact	862-8603	250
○ GND-L1-N; with ground contact	862-9603	250

4-conductor chassis-mount terminal strip; 1 snap-in foot per pole; white

○ N-GND-L1; without ground contact	862-2633	250
○ GND-N-L1; without ground contact	862-1633	250
○ GND-N-L1; without ground contact ③	862-1633/999-950 ③	250
○ plain; without ground contact	862-633	250
○ N-GND-L1; with ground contact	862-8633	250
○ GND-L1-N; with ground contact	862-9633	250

4-conductor chassis-mount terminal strip; Snap-in foot at pos. 1+3; white

○ N-GND-L1; without ground contact	862-2693	250
○ GND-N-L1; without ground contact	862-1693	250
○ GND-N-L1; without ground contact ③	862-1693/999-950 ③	250
○ plain; without ground contact	862-693	250
○ N-GND-L1; with ground contact	862-8693	250
○ GND-N-L1; with ground contact	862-9693	250

① Conductor range: 0.5 ... 4 mm² "s+f-st"; Push-in termination: 1 ... 4 mm² "s" and 1 ... 2.5 mm² "insulated ferrules, 12 mm"
Depending on the conductor characteristic, a conductor with a smaller cross section can also be inserted via push-in termination.

② 500 V = rated voltage
6 kV = rated impulse voltage
3 = pollution degree
(see Section 14)

③ Terminal blocks with an Ex mark are suitable for Ex e II applications.
440 V; 28 A
(see Section 14)

Approvals and corresponding ratings, visit www.wago.com

Accessories; 862 Series

Appropriate marking system:
Marking strips

Comb-style jumper bar; for conductor entry; insulated; terminated conductor entry; I, 32 A

black 862-482 5



Test plug; with 500 mm cable; 2 mm Ø; max. 42 V

red 210-136 50



Test plug; with 500 mm cable; 2 mm Ø; max. 42 V

yellow 210-137 50



Marking strip; on reel; 7.5 mm wide; not stretchable; plain; snap-on type

white 709-178 1



Operating tool with a partially insulated shaft; Type 2; (3.5 x 0.5) mm blade

210-720 1



4-Conductor Chassis-Mount Terminal Strip; 4-Pole 4 mm²; 862 Series

Technical Data	
0.5 ... 4 mm ² ①	20 ... 12 AWG
500 V/6 kV/3 ②	300 V, 20 A ③
I _N 32 A	300 V, 20 A ④
 10 ... 11 mm / 0.39 ... 0.43 inch	



Technical Data	
0.5 ... 4 mm ² ①	20 ... 12 AWG
500 V/6 kV/3 ②	300 V, 20 A ③
I _N 32 A	300 V, 20 A ④
 10 ... 11 mm / 0.39 ... 0.43 inch	



- ① Conductor range: 0.5 ... 4 mm² "s+f-st"; Push-in termination: 1 ... 4 mm² "s" and 1 ... 2.5 mm² "insulated ferrules, 12 mm"
Depending on the conductor characteristic, a conductor with a smaller cross section can also be inserted via push-in termination.
 - ② 500 V = rated voltage
6 kV = rated impulse voltage
3 = pollution degree
(see Section 14)
 - ③ Terminal blocks with an Ex mark are suitable for Ex e II applications.
440 V; 28 A
(see Section 14)
- Approvals and corresponding ratings, visit www.wago.com

4-conductor chassis-mount terminal strip; for mounting via screw and nut (3 mm Ø) or for self-tapping screw (2.9 mm Ø) from top; black

	Item No.	Pack. Unit
● N-GND-L1-L2; without ground contact	862-2504	200
● GND-N-L1-L2; without ground contact	862-1504	200
● GND-N-L1-L2; without ground contact ④	862-1504/999-950 ④	200
● plain; without ground contact	862-504	200
● N-GND-L1-L2; with ground contact	862-8504	200
● GND-N-L1-L2; with ground contact	862-9504	200

4-conductor chassis-mount terminal strip; for mounting via screw and nut (3 mm Ø) or for self-tapping screw (2.9 mm Ø) from top; white

	Item No.	Pack. Unit
○ N-GND-L1-L2; without ground contact	862-2604	200
○ GND-N-L1-L2; without ground contact	862-1604	200
○ GND-N-L1-L2; without ground contact ④	862-1604/999-950 ④	200
○ plain; without ground contact	862-604	200
○ N-GND-L1-L2; with ground contact	862-8604	200
○ GND-N-L1-L2; with ground contact	862-9604	200

Accessories; 862 Series
Appropriate marking system:
Marking strips

Comb-style jumper bar; for conductor entry; insulated; terminated conductor entry; I_N 32 A

 black	862-482	5
---	---------	---

Test plug; with 500 mm cable; 2 mm Ø; max. 42 V

 red	210-136	50
--	---------	----

Test plug; with 500 mm cable; 2 mm Ø; max. 42 V

 yellow	210-137	50
--	---------	----

Marking strip; on reel; 7.5 mm wide; not stretchable; plain; snap-on type

 white	709-178	1
---	---------	---

Operating tool with a partially insulated shaft; Type 2; (3.5 x 0.5) mm blade

	210-720	1
---	---------	---

4-conductor chassis-mount terminal strip; 1 snap-in foot per pole; black

● N-GND-L1-L2; without ground contact	862-2534	200
● GND-N-L1-L2; without ground contact	862-1534	200
● GND-N-L1-L2; without ground contact ④	862-1534/999-950 ④	200
● plain; without ground contact	862-534	200
● N-GND-L1-L2; with ground contact	862-8534	200
● GND-N-L1-L2; with ground contact	862-9534	200

4-conductor chassis-mount terminal strip; 1 snap-in foot per pole; white

○ N-GND-L1-L2; without ground contact	862-2634	200
○ GND-N-L1-L2; without ground contact	862-1634	200
○ GND-N-L1-L2; without ground contact ④	862-1634/999-950 ④	200
○ plain; without ground contact	862-634	200
○ N-GND-L1-L2; with ground contact	862-8634	200
○ GND-N-L1-L2; with ground contact	862-9634	200

4-conductor chassis-mount terminal strip; Snap-in foot at pos. 1+4; black

● N-GND-L1-L2; without ground contact	862-2594	200
● GND-N-L1-L2; without ground contact	862-1594	200
● GND-N-L1-L2; without ground contact ④	862-1594/999-950 ④	200
● plain; without ground contact	862-594	200
● N-GND-L1-L2; with ground contact	862-8594	200
● GND-N-L1-L2; with ground contact	862-9594	200

4-conductor chassis-mount terminal strip; Snap-in foot at pos. 1+4; white

○ N-GND-L1-L2; without ground contact	862-2694	200
○ GND-N-L1-L2; without ground contact	862-1694	200
○ GND-N-L1-L2; without ground contact ④	862-1694/999-950 ④	200
○ plain; without ground contact	862-694	200
○ N-GND-L1-L2; with ground contact	862-8694	200
○ GND-N-L1-L2; with ground contact	862-9694	200

4-Conductor Chassis-Mount Terminal Strip; 5-Pole 4 mm²; 862 Series

Technical Data

0.5 ... 4 mm ² ①	20 ... 12 AWG
500 V/6 kV/3 ②	300 V, 20 A ③
I _N 32 A	300 V, 20 A ④
10 ... 11 mm / 0.39 ... 0.43 inch	



Technical Data

0.5 ... 4 mm ² ①	20 ... 12 AWG
500 V/6 kV/3 ②	300 V, 20 A ③
I _N 32 A	300 V, 20 A ④
10 ... 11 mm / 0.39 ... 0.43 inch	



① Conductor range: 0.5 ... 4 mm² "s+f-st"; Push-in termination: 1 ... 4 mm² "s" and 1 ... 2.5 mm² "insulated ferrules, 12 mm"
Depending on the conductor characteristic, a conductor with a smaller cross section can also be inserted via push-in termination.

② 500 V = rated voltage
6 kV = rated impulse voltage
3 = pollution degree
(see Section 14)

③ Terminal blocks with an Ex mark are suitable for Ex e II applications.
440 V; 28 A
(see Section 14)

Approvals and corresponding ratings, visit www.wago.com

Accessories; 862 Series

Appropriate marking system:
Marking strips

Comb-style jumper bar; for conductor entry; insulated; terminated conductor entry; I, 32 A

black 862-482 5

Test plug; with 500 mm cable; 2 mm Ø; max. 42 V

red 210-136 50

Test plug; with 500 mm cable; 2 mm Ø; max. 42 V

yellow 210-137 50

Marking strip; on reel; 7.5 mm wide; not stretchable; plain; snap-on type

white 709-178 1

Operating tool with a partially insulated shaft; Type 2; (3.5 x 0.5) mm blade

210-720 1

4-conductor chassis-mount terminal strip; for mounting via screw and nut (3 mm Ø) or for self-tapping screw (2.9 mm Ø) from top; black

	Item No.	Pack. Unit
● L3-N-GND-L1-L2; without ground contact	862-2505	200
● GND-N-L1-L2-L3; without ground contact	862-1505	200
● GND-N-L1-L2-L3; without ground contact ③	862-1505/999-950 ③	200
● plain; without ground contact	862-505	200
● L3-N-GND-L1-L2; with ground contact	862-8505	200
● GND-N-L1-L2-L3; with ground contact	862-9505	200

4-conductor chassis-mount terminal strip; for mounting via screw and nut (3 mm Ø) or for self-tapping screw (2.9 mm Ø) from top; white

	Item No.	Pack. Unit
○ L3-N-GND-L1-L2; without ground contact	862-2605	200
○ GND-N-L1-L2-L3; without ground contact	862-1605	200
○ GND-N-L1-L2-L3; without ground contact ③	862-1605/999-950 ③	200
○ plain; without ground contact	862-605	200
○ L3-N-GND-L1-L2; with ground contact	862-8605	200
○ GND-N-L1-L2-L3; with ground contact	862-9605	200

4-conductor chassis-mount terminal strip; 1 snap-in foot per pole; black

● L3-N-GND-L1-L2; without ground contact	862-2525	200
● GND-N-L1-L2-L3; without ground contact	862-1525	200
● GND-N-L1-L2-L3; without ground contact ③	862-1525/999-950 ③	200
● plain; without ground contact	862-525	200
● L3-N-GND-L1-L2; with ground contact	862-8525	200
● GND-N-L1-L2-L3; with ground contact	862-9525	200

4-conductor chassis-mount terminal strip; 1 snap-in foot per pole; white

○ L3-N-GND-L1-L2; without ground contact	862-2625	200
○ GND-N-L1-L2-L3; without ground contact	862-1625	200
○ GND-N-L1-L2-L3; without ground contact ③	862-1625/999-950 ③	200
○ plain; without ground contact	862-625	200
○ L3-N-GND-L1-L2; with ground contact	862-8625	200
○ GND-N-L1-L2-L3; with ground contact	862-9625	200

4-conductor chassis-mount terminal strip; Snap-in foot at pos. 1+3; black

● L3-N-GND-L1-L2; without ground contact	862-2515	200
● GND-N-L1-L2-L3; without ground contact	862-1515	200
● GND-N-L1-L2-L3; without ground contact ③	862-1515/999-950 ③	200
● plain; without ground contact	862-515	200
● L3-N-GND-L1-L2; with ground contact	862-8515	200
● GND-N-L1-L2-L3; with ground contact	862-9515	200

4-conductor chassis-mount terminal strip; Snap-in foot at pos. 1+3; white

○ L3-N-GND-L1-L2; without ground contact	862-2615	200
○ GND-N-L1-L2-L3; without ground contact	862-1615	200
○ GND-N-L1-L2-L3; without ground contact ③	862-1615/999-950 ③	200
○ plain; without ground contact	862-615	200
○ L3-N-GND-L1-L2; with ground contact	862-8615	200
○ GND-N-L1-L2-L3; with ground contact	862-9615	200

Connect Lighting and Equipment Worldwide

Contact Technology

294 Series

Contact Technology

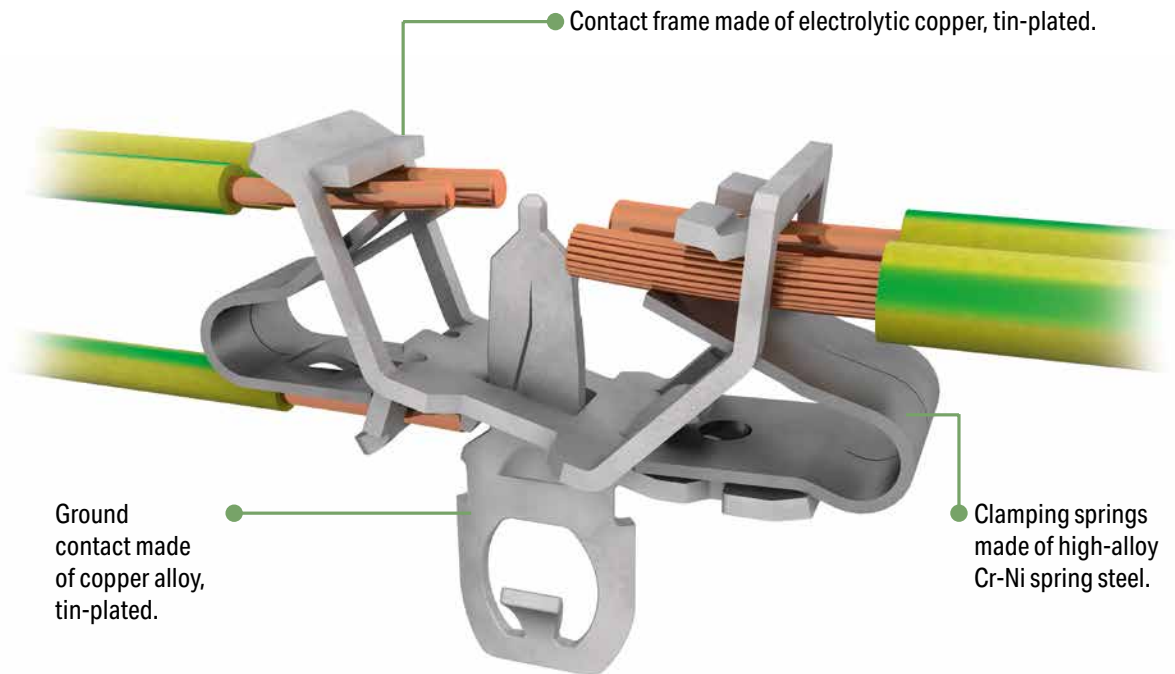

EUROPE
1 x 0.5 ... 2.5 mm ² "s"
1 x 0.5 ... 1.5 mm ² "s"
1 x 0.5 ... 0.75 mm ² "s"
AMERICA
1 x AWG 18 ... 14 "s"
1 x AWG 18 ... 16 "s"
1 x AWG 18 "s"
JAPAN
1 x 0.8 ... 1.6 mm diam. "s"
1 x 0.8 ... 1 mm diam. "s"
1 x 0.8 mm diam. "s"

Internal connection:
 PUSH WIRE® for internal wiring with solid conductors

EUROPE
2 x 0.5 ... 2.5 mm ² "s, str, f-str"
AMERICA
2 x AWG 18 ... 12 "s"
2 x AWG 18 ... 14 "s, f-str"
JAPAN
2 x 0.8 ... 2 mm diam. "s"
2 x 0.5 ... 2 mm ² "str, f-str"

External connection:
 Push-in CAGE CLAMP® for field-wiring with all conductor types

9

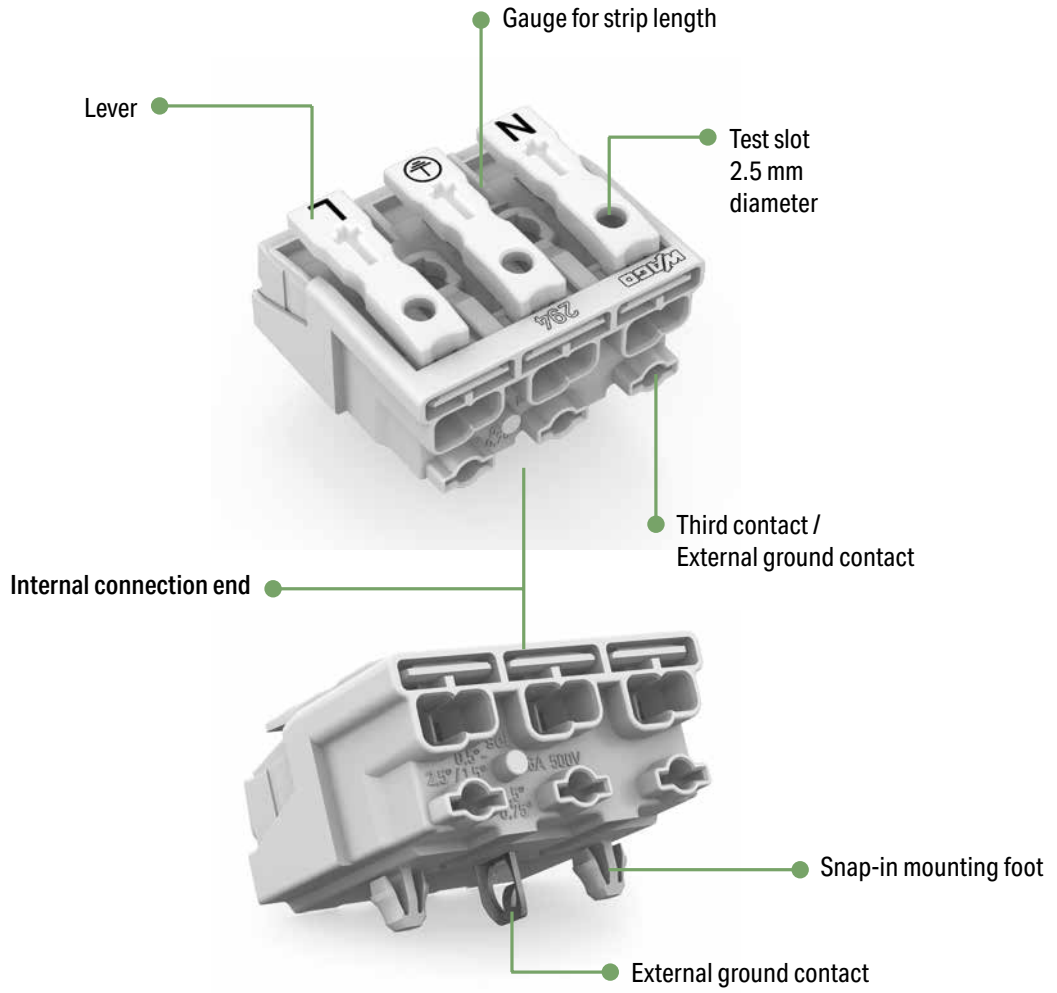

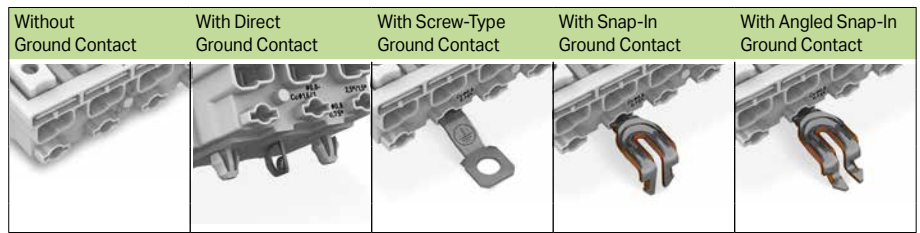
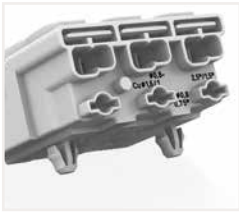

Field-Wiring Terminal Block; with Two Snap-In Mounting Feet – Overview 294 Series



Pole No.	Marking	Item No.	Item No.	Item No.	Item No.	Item No.
2 	plain	294-5002				
	N-L	294-5012				
	N´-L´	294-5022				
	DA- DA+	294-5032				
	- +	294-5072				
	1-N	294-5052				
	2-1	294-5042				

3 	plain	294-5003				
	N-GND-L	294-5013	294-5113	294-5413	294-5213	294-5313
	N´-GND-L´	294-5023	294-5123	294-5423	294-5223	294-5323
	1-GND-N	294-5053	294-5153	294-5453	294-5253	294-5353
	3-2-1	294-5043				

4 	plain	294-5004				
	1/L´-2/L-GND-N	294-5024	294-5124	294-5424	294-5224	294-5324
	1-2-GND-N	294-5014	294-5124	294-5424	294-5224	294-5324
	4-3-2-1	294-5044				
	1/L´-2/L E-N	294-5094/4025-000				

5 	plain	294-5005				
	L3-L2-L1-GND_N	294-5015		294-5415	294-5215	294-5315
	L´-N´-L-GND-N	294-5025		294-5425	294-5225	294-5325
	DA+ DA- L GND N	294-5035		294-5435	294-5235	294-5335
	DA- N GND L DA+	294-5075	294-5175	294-5475	294-5275	294-5375
	3-N-GND-1-2	294-5055	294-5155	294-5455	294-5255	294-5355
	5-4-3-2-1	294-5045				
	DA+ DA- L E N	294-5095/5025-000				
	L3-L2-L1-E-N	294-5095/5026-000				
	L´-N´-L-E-N	294-5095/5027-000				

Field-Wiring Terminal Block; without Snap-In Mounting Feet – Overview 294 Series

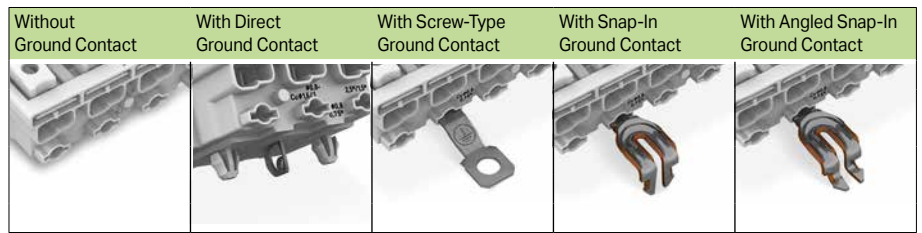
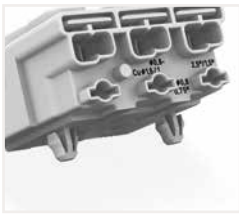



Pole No.	Marking	Item No.	Item No.	Item No.	Item No.	Item No.
2 	plain	294-4002				
	N-L	294-4012				
	N´-L´	294-4022				
	DA- DA+	294-4032				
	- +	294-4072				
	1-N	294-4052				
	2-1	294-4042				

3 	plain	294-4003				
	N-GND-L	294-4013		294-4413	294-4213	294-4313
	N´-GND-L´	294-4023		294-4423	294-4223	294-4323
	1-GND-N	294-4053		294-4453	294-4253	294-4353
	3-2-1	294-4043				

4 	plain	294-4004				
	1/L´-2/L-GND-N	294-4024		294-4424	294-4224	294-4324
	1-2-GND-N	294-4014		294-4424	294-4224	294-4324
	4-3-2-1	294-4044				
	1/L´-2/L E-N	294-4094/4025-000				

5 	plain	294-4005				
	L3-L2-L1-GND_N	294-4015		294-4415	294-4215	294-4315
	L´-N´-L-GND-N	294-4025		294-4425	294-4225	294-4325
	DA+ DA- L GND N	294-4035		294-4435	294-4235	294-4335
	DA- N GND L DA+	294-4075		294-4475	294-4275	294-4375
	3-N-GND-1-2	294-4055		294-4455	294-4255	294-4355
	5-4-3-2-1	294-4045				
	DA+ DA- L E N	294-4095/5025-000				
	L3-L2-L1-E-N	294-4095/5026-000				
	L´-N´-L-E-N	294-4095/5027-000				

6 	plain	294-4006				
--	-------	----------	--	--	--	--

7 	plain	294-4007				
--	-------	----------	--	--	--	--

Field-Wiring Terminal Block

2.5 mm; 294 Series



Terminating five conductors per pole – solid and fine-stranded.

- External connection of solid, stranded and fine-stranded conductors
- Universal conductor termination (AWG, metric)
- Third contact located at the bottom of internal connection end
- Strain relief plate can be retrofitted

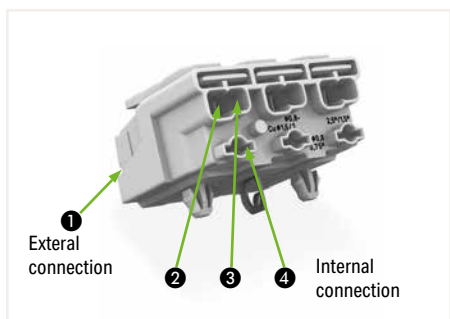

Technical Data

Ratings per	IEC/EN 60998-1	IEC/EN 60998-2-2
Overtoltage category	II	II
Pollution degree	2	2
Rated voltage	500 V	500 V
Rated surge voltage	4 kV	4 kV
Rated current	24 A	24 A
Temperature specification	T 85	

Conductor Data (External Connection)

Connection technology ❶	Push-in CAGE CLAMP®
Solid conductor	0.5 ... 2.5 mm / 18 ... 12 AWG
Stranded conductor	0.5 ... 2.5 mm / 18 ... 16 AWG
Fine-stranded conductor	0.5 ... 2.5 mm / 18 ... 16 AWG
Solid conductor, push-in termination	0.5 ... 2.5 mm / 18 ... 12 AWG
Fine-stranded conductor with ferrule, push-in termination	0.5 mm ² / 18 AWG
Fine-stranded conductor with ferrule with plastic collar	0.5 ... 1.5 mm / 18 ... 16 AWG
Fine-stranded conductor with ferrule without plastic collar	0.5 ... 1.5 mm / 18 ... 16 AWG

Conductor Data (Internal Connection)

Connection technology	PUSH WIRE®
Conductor termination ❷	
Solid conductor	0.5 ... 2.5 mm / 18 ... 14 AWG
Fine-stranded conductor with ferrule without plastic collar	0.5 ... 1.5 mm / 18 ... 14 AWG
Fine-stranded conductor with ferrule with plastic collar	0.5 ... 1.5 mm / 18 ... 14 AWG
Conductor termination ❸	
Solid conductor	0.5 ... 1.5 mm / 18 ... 16 AWG
Fine-stranded conductor with ferrule without plastic collar	0.5 ... 1 mm / 18 ... 14 AWG
Fine-stranded conductor with ferrule with plastic collar	0.5 ... 0.75 mm / 18 AWG
Conductor termination ❹	
Solid conductor	0.5 ... 0.75 mm / 18 AWG
Strip length	8 ... 9 mm / 0.31 ... 0.35 inch

Material Data

Material group	IIIa
Insulation material	Polycarbonate (PC)
Temperature stability	Relative Temperature Index (RTI) of 120 °C
Flammability class per UL 94	V0
Clamping spring material	Chrome nickel spring steel (CrNi)
Contact material	Electrolytic copper (E _{0a})
Contact plating	Tin-plated
16 mm-high versions are available upon request.	

Field-Wiring Terminal Block

2.5 mm; 294 Series

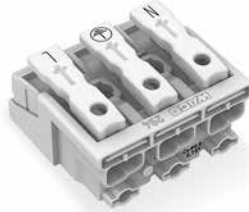

Dimensions in mm

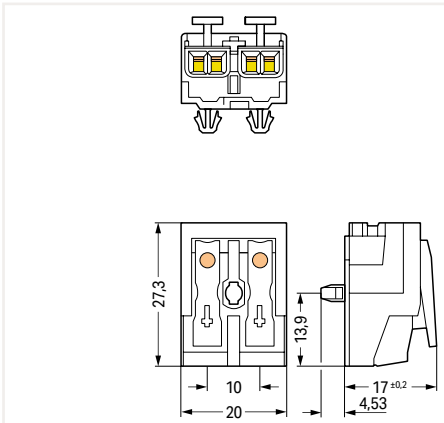

Field-wiring terminal block; without ground contact; with snap-in mounting feet; 2-pole; white

Marking	Item No.	Pack. Unit
○ N-L	294-5012	1000
○ N´-L´	294-5022	1000
○ DA- DA+	294-5032	1000
○ - +	294-5072	1000
○ 2-1	294-5042	1000
○ 1-N	294-5052	1000
○ plain	294-5002	1000

Dimensions in mm

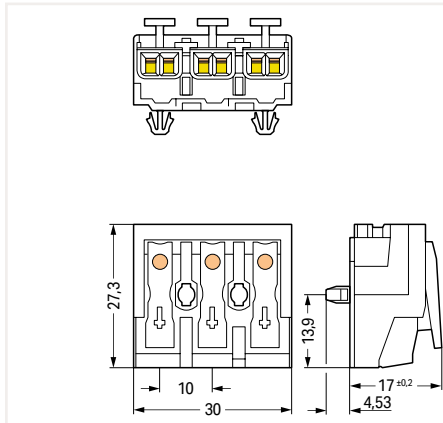

Field-wiring terminal block; without ground contact; with snap-in mounting feet; 3-pole; white

Marking	Item No.	Pack. Unit
○ N-GND-L	294-5013	500
○ N´-GND-L´	294-5023	500
○ 1-GND-N	294-5053	500
○ 3-2-1	294-5043	500
○ plain	294-5003	500

Dimensions in mm

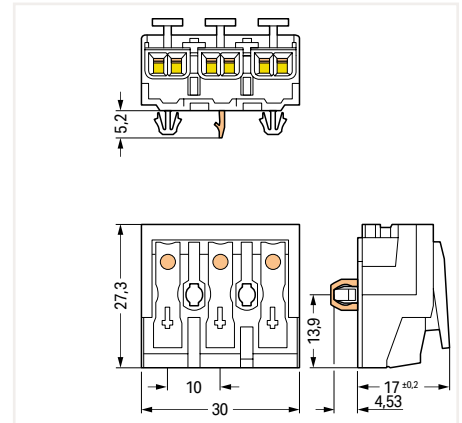

Field-wiring terminal block; with direct ground contact; with snap-in mounting feet; 3-pole; white

Marking	Item No.	Pack. Unit
○ N-GND-L	294-5113	500
○ N´-GND-L´	294-5123	500
○ 1-GND-N	294-5153	500

Field-wiring terminal block; without ground contact; without snap-in mounting feet; 2-pole; white

○ N-L	294-4012	1000
○ N´-L´	294-4022	1000
○ DA- DA+	294-4032	1000
○ - +	294-4072	1000
○ 2-1	294-4042	1000
○ 1-N	294-4052	1000
○ plain	294-4002	1000

Field-wiring terminal block; without ground contact; without snap-in mounting feet; 3-pole; white

○ N-GND-L	294-4013	500
○ N´-GND-L´	294-4023	500
○ 1-GND-N	294-4053	500
○ 3-2-1	294-4043	500
○ plain	294-4003	500
○ N-E-L	294-4093/3025-000	500

Field-Wiring Terminal Block

2.5 mm; 294 Series



Dimensions in mm

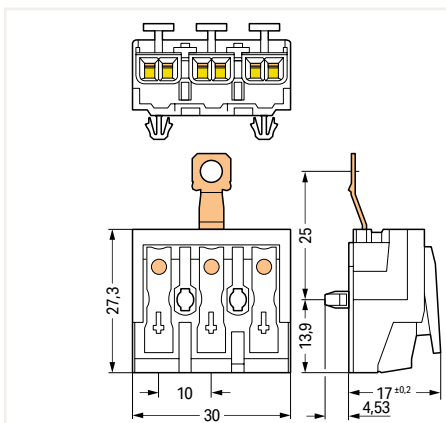

Field-wiring terminal block; with screw-type ground contact; with snap-in mounting feet; 3-pole; white

Marking	Item No.	Pack. Unit
○ N-GND-L	294-5413	500
○ N'-GND-L'	294-5423	500
○ 1-GND-N	294-5453	500

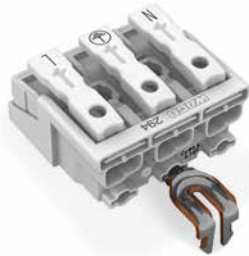

Dimensions in mm

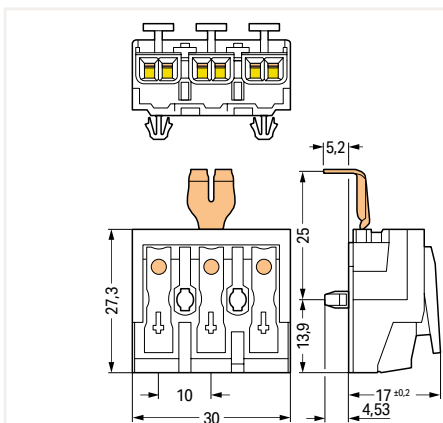

Field-wiring terminal block; with ground contact; with snap-in mounting feet; 3-pole; white

Marking	Item No.	Pack. Unit
○ N-GND-L	294-5213	500
○ N'-GND-L'	294-5223	500
○ 1-GND-N	294-5253	500

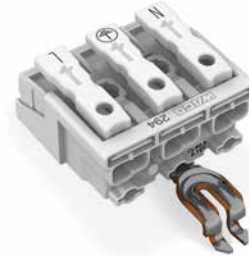

Dimensions in mm

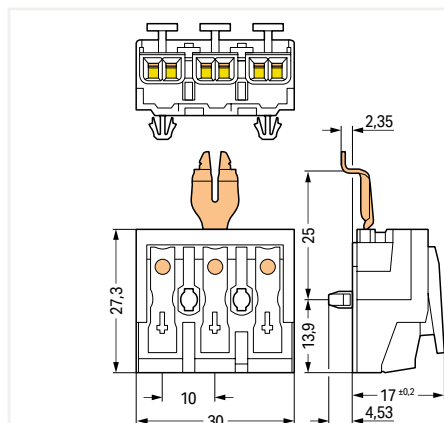

Field-wiring terminal block; with angled ground contact; with snap-in mounting feet; 3-pole; white

Marking	Item No.	Pack. Unit
○ N-GND-L	294-5313	500
○ N'-GND-L'	294-5323	500
○ 1-GND-N	294-5353	500

9

Field-wiring terminal block; with screw-type ground contact; without snap-in mounting feet; 3-pole; white

○ N-GND-L	294-4413	500
○ N'-GND-L'	294-4423	500
○ 1-GND-N	294-4453	500

Field-wiring terminal block; with snap-in ground contact; without snap-in mounting feet; 3-pole; white

○ N-GND-L	294-4213	500
○ N'-GND-L'	294-4223	500
○ 1-GND-N	294-4253	500

Field-wiring terminal block; with angled snap-in ground contact; without snap-in mounting feet; 3-pole; white

○ N-GND-L	294-4313	500
○ N'-GND-L'	294-4323	500
○ 1-GND-N	294-4353	500

PUSH-IN CAGE CLAMP® | **PUSH WIRE®**

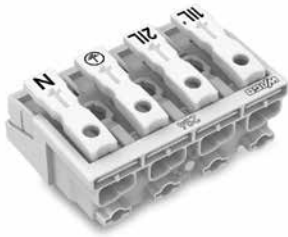

Dimensions in mm

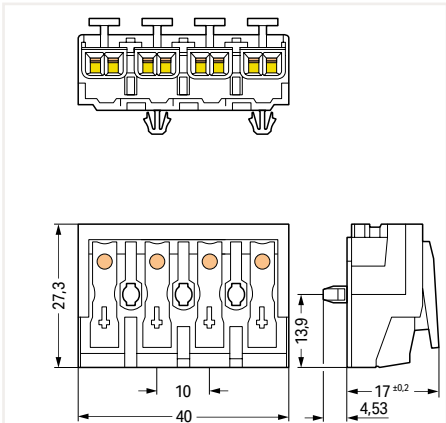

Field-wiring terminal block; without ground contact; with snap-in mounting feet; 4-pole; white

Marking	Item No.	Pack. Unit
○ 1/L'-2/L-GND-N	294-5024	500
○ 1-2-GND-N	294-5014	500
○ 4-3-2-1	294-5044	500
○ plain	294-5004	500
○ 1/L'-2/L-E-N	294-5094/4025-000	500

Field-wiring terminal block; without ground contact; without snap-in mounting feet; 4-pole; white

○ 1/L'-2/L-GND-N	294-4024	500
○ 1-2-GND-N	294-4014	500
○ 4-3-2-1	294-4044	500
○ plain	294-4004	500
○ 1/L'-2/L-E-N	294-4094/4025-000	500

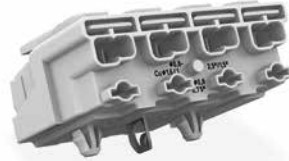

Dimensions in mm

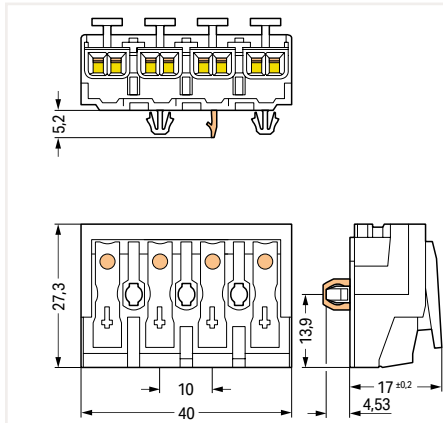

Field-wiring terminal block; with direct ground contact; with snap-in mounting feet; 4-pole; white

Marking	Item No.	Pack. Unit
○ 1/L'-2/L-GND-N	294-5124	500
○ 1-2-GND-N	294-5114	500

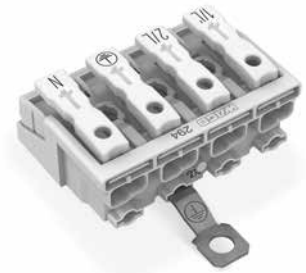

Dimensions in mm

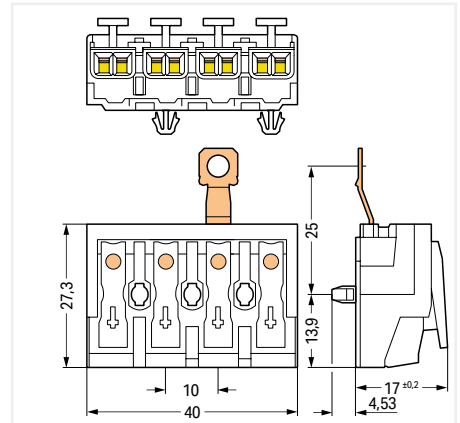

Field-wiring terminal block; with screw-type ground contact; with snap-in mounting feet; 4-pole; white

Marking	Item No.	Pack. Unit
○ 1/L'-2/L-GND-N	294-5424	500
○ 1-2-GND-N	294-5414	500

Field-wiring terminal block; with screw-type ground contact; without snap-in mounting feet; 4-pole; white

○ 1/L'-2/L-GND-N	294-4424	500
○ 1-2-GND-N	294-4414	500

Field-Wiring Terminal Block

2.5 mm; 294 Series

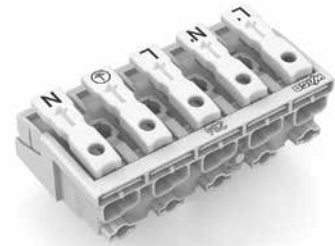
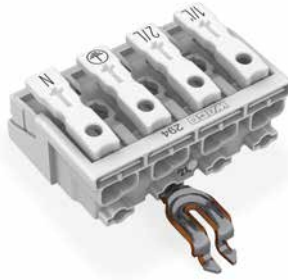
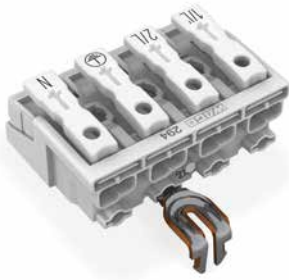

Dimensions in mm

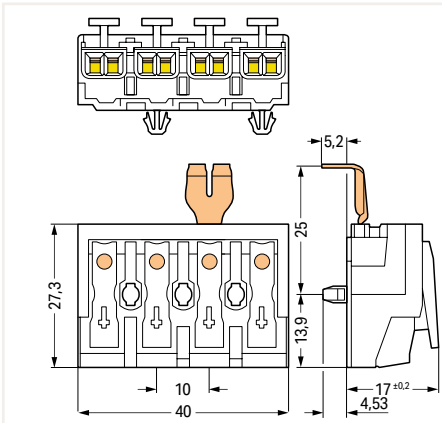

Field-wiring terminal block; with ground contact; with snap-in mounting feet; 4-pole; white

Marking	Item No.	Pack. Unit
○ 1/L'-2/L-GND-N	294-5224	500
○ 1-2-GND-N	294-5214	500

Dimensions in mm

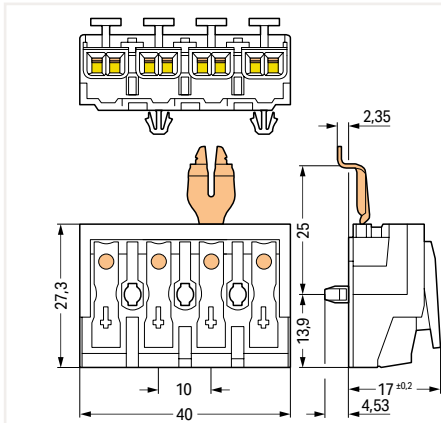

Field-wiring terminal block; with angled ground contact; with snap-in mounting feet; 4-pole; white

Marking	Item No.	Pack. Unit
○ 1/L'-2/L-GND-N	294-5324	500
○ 1-2-GND-N	294-5314	500

Dimensions in mm

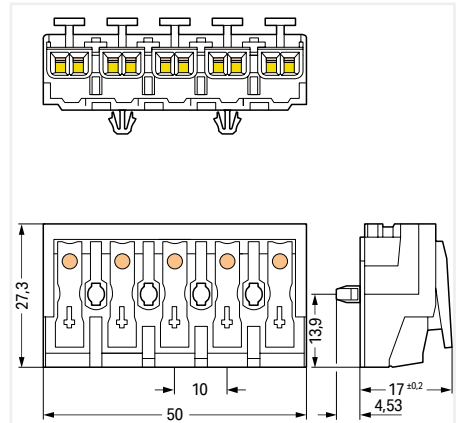

Field-wiring terminal block; without ground contact; with snap-in mounting feet; 5-pole; white

Marking	Item No.	Pack. Unit
○ L'-N'-L-GND-N	294-5025	250
○ L3-L2-L1-GND-N	294-5015	250
○ DA+ DA- L GND N	294-5035	250
○ DA- N GND L DA+	294-5075	250
○ 3-N-GND-1-2	294-5055	250
○ 5-4-3-2-1	294-5045	250
○ plain	294-5005	250
○ DA+ DA- L E N	294-5095/5025-000	250
○ L3-L2-L1-E-N	294-5095/5026-000	250
○ L'-N'-L-E-N	294-5095/5027-000	250

Field-wiring terminal block; with snap-in ground contact; without snap-in mounting feet; 4-pole; white

○ 1/L'-2/L-GND-N	294-4224	500
○ 1-2-GND-N	294-4214	500

Field-wiring terminal block; with angled snap-in ground contact; without snap-in mounting feet; 4-pole; white

○ 1/L'-2/L-GND-N	294-4324	500
○ 1-2-GND-N	294-4314	500

Field-wiring terminal block; without ground contact; without snap-in mounting feet; 5-pole; white

○ L'-N'-L-GND-N	294-4025	250
○ L3-L2-L1-GND-N	294-4015	250
○ DA+ DA- L GND N	294-4035	250
○ DA- N GND L DA+	294-4075	250
○ 3-N-GND-1-2	294-4055	250
○ 5-4-3-2-1	294-4045	250
○ plain	294-4005	250
○ DA+ DA- L E N	294-4095/5025-000	250
○ L3-L2-L1-E-N	294-4095/5026-000	250
○ L'-N'-L-E-N	294-4095/5027-000	250

9

PUSH-IN CAGE CLAMP® | **PUSH WIRE®**

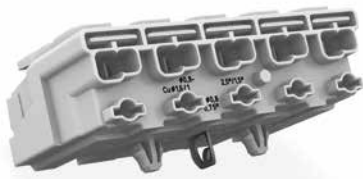

Dimensions in mm

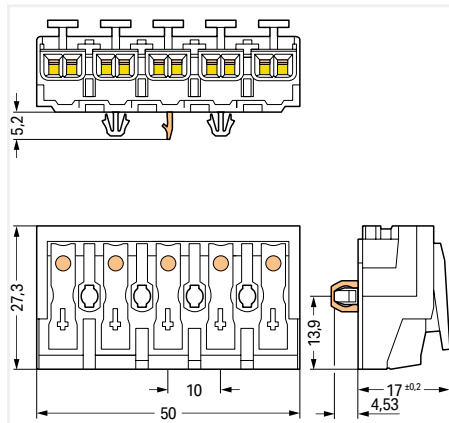

Field-wiring terminal block; with direct ground contact; with snap-in mounting feet; 5-pole; white

Marking	Item No.	Pack. Unit
○ DA- N GND L DA+	294-5175	250
○ 3-N-GND-1-2	294-5155	250



Dimensions in mm

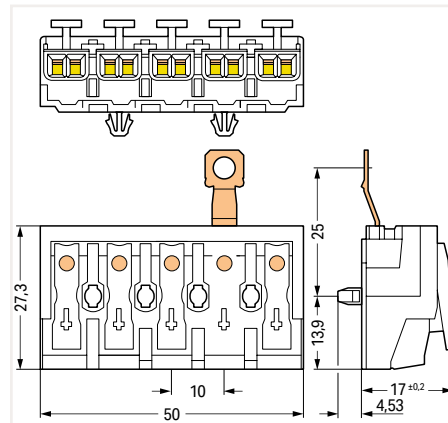

Field-wiring terminal block; with screw-type ground contact; with snap-in mounting feet; 5-pole; white

Marking	Item No.	Pack. Unit
○ L'-N'-L-GND-N	294-5425	250
○ L3-L2-L1-GND-N	294-5415	250
○ DA+ DA- L GND N	294-5435	250
○ DA- N GND L DA+	294-5475	250
○ 3-N-GND-1-2	294-5455	250

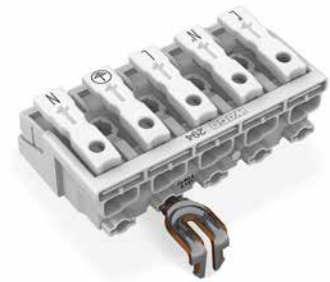

Dimensions in mm

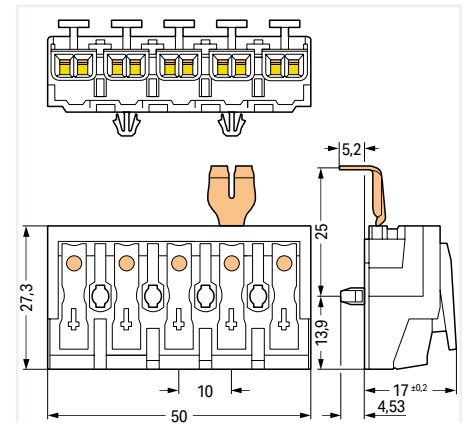

Field-wiring terminal block; with ground contact; with snap-in mounting feet; 5-pole; white

Marking	Item No.	Pack. Unit
○ L'-N'-L-GND-N	294-5225	250
○ L3-L2-L1-GND-N	294-5215	250
○ DA+ DA- L GND N	294-5235	250
○ DA- N GND L DA+	294-5275	250
○ 3-N-GND-1-2	294-5255	250

Field-wiring terminal block; with screw-type ground contact; without snap-in mounting feet; 5-pole; white

○ L'-N'-L-GND-N	294-4425	250
○ L3-L2-L1-GND-N	294-4415	250
○ DA+ DA- L GND N	294-4435	250
○ DA- N GND L DA+	294-4475	250
○ 3-N-GND-1-2	294-4455	250

Field-wiring terminal block; with snap-in ground contact; without snap-in mounting feet; 5-pole; white

○ L'-N'-L-GND-N	294-4225	250
○ L3-L2-L1-GND-N	294-4215	250
○ DA+ DA- L GND N	294-4235	250
○ DA- N GND L DA+	294-4275	250
○ 3-N-GND-1-2	294-4255	250

Field-Wiring Terminal Block

2.5 mm; 294 Series

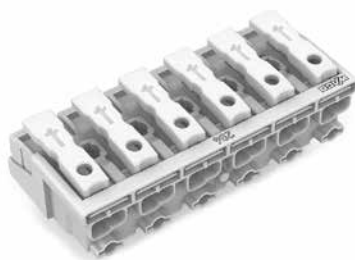
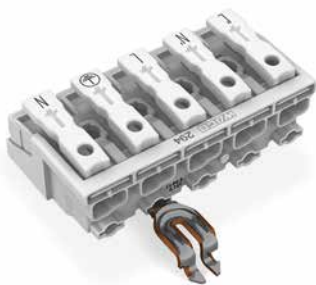

Dimensions in mm

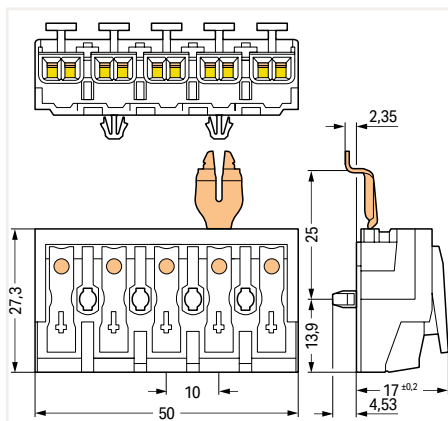

Field-wiring terminal block; without ground contact; with snap-in mounting feet; 5-pole; white

Marking	Item No.	Pack. Unit
○ L'-N'-L-GND-N	294-5325	250
○ L3-L2-L1-GND-N	294-5315	250
○ DA+ DA- L GND N	294-5335	250
○ DA- N GND L DA+	294-5375	250
○ 3-N-GND-1-2	294-5355	250

Dimensions in mm

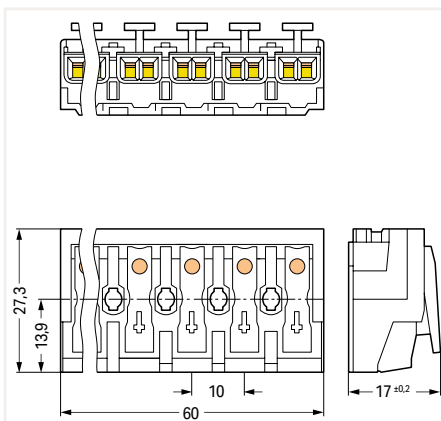

Field-wiring terminal block; without ground contact; without snap-in mounting feet; 6-pole; white

Marking	Item No.	Pack. Unit
○ plain	294-4006	200

Dimensions in mm

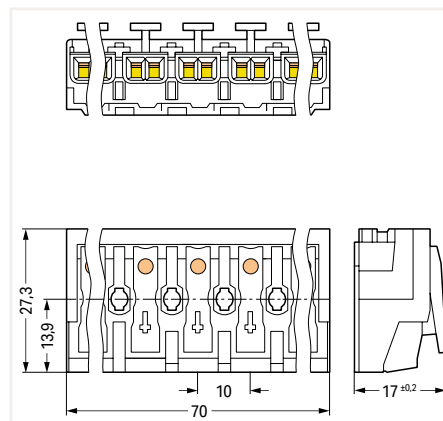

Field-wiring terminal block; without ground contact; without snap-in mounting feet; 7-pole; white

Marking	Item No.	Pack. Unit
○ plain	294-4007	200

9

Field-wiring terminal block; without ground contact; without snap-in mounting feet; 5-pole; white

○ L'-N'-L-GND-N	294-4325	250
○ L3-L2-L1-GND-N	294-4315	250
○ DA+ DA- L GND N	294-4335	250
○ DA- N GND L DA+	294-4375	250
○ 3-N-GND-1-2	294-4355	250

Tool and Strain Relief Plate



Dimensions in mm

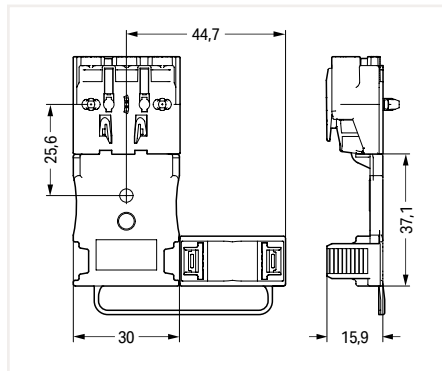

Dimensions in mm

Assembly tool; presses snap-in mounting feet into the mounting plate; fits ground connections safely and easily

Item No.	Pack. Unit
294-199	50

Strain relief plate; with locking clip; for multicore cable: 1 x 5.2 ... 12 mm outer diameter

Marking	Item No.	Pack. Unit
○ white	294-364	50

Strain relief; with snap-in mounting feet; for 4.5 ... 12 mm cable diameter

Marking	Item No.	Pack. Unit
○ white	294-370	500

Strain relief plate; with locking clip; for flat cables and individual conductors: min. 3 x 0.5 mm², max. 5 x 2.5 mm² or 7 x 1.5 mm²

Marking	Item No.	Pack. Unit
○ white	294-384	50

Strain relief; for screw/rivet mounting; for 4.5 ... 12 mm cable diameter

Marking	Item No.	Pack. Unit
○ white	294-375	500



Disconnection tool; removes conductors from PUSH WIRE® connections

Item No.	Pack. Unit
206-294	1



Conductor removal:
Slide disconnection tool beneath the conductor and pull both conductor and tool out.



Strain relief; for screw/rivet mounting; for 4.5 ... 12 mm cable diameter

Drilled-Hole Patterns for Snap-In Mounting Feet 294 Series

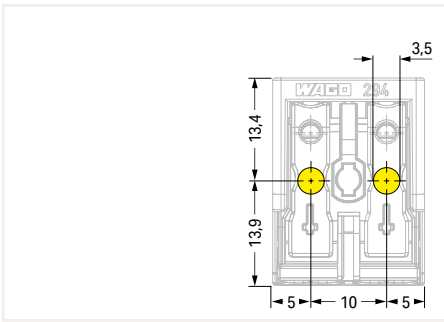

2-pole – without ground contact

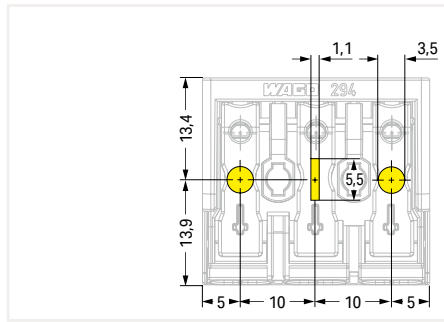

3-pole – with direct ground contact

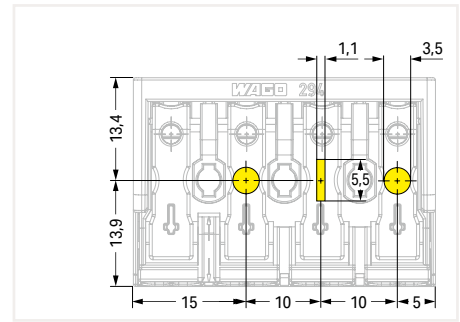

3-pole – with direct ground contact

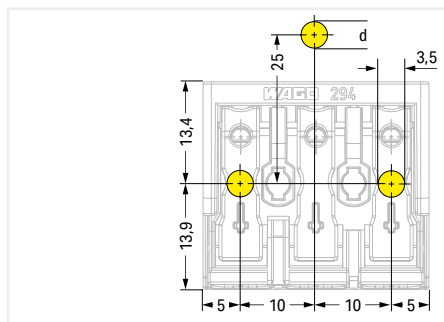

3-pole –
with snap-in ground contact, $d = 4.9 \text{ mm}$
with screw-type ground contact, $d \leq 4.1 \text{ mm}$

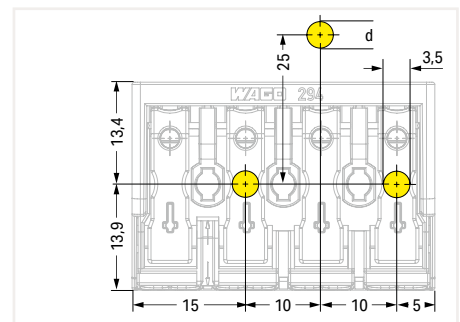

4-pole –
with snap-in ground contact, $d = 4.9 \text{ mm}$
with screw-type ground contact, $d \leq 4.1 \text{ mm}$

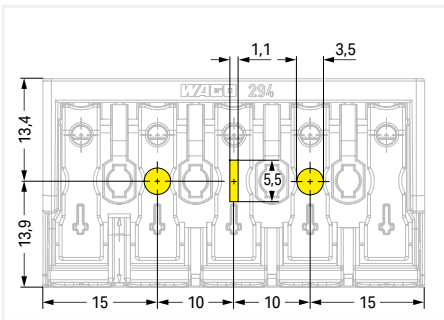

3-pole – with direct ground contact

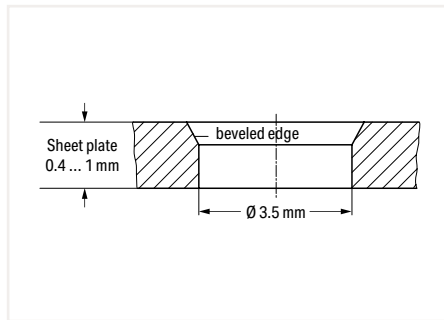

Drilled hole for snap-in mounting foot

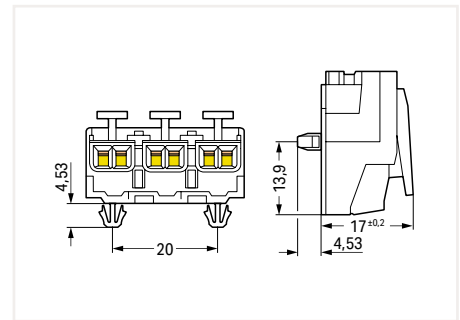

Snap-in mounting foot

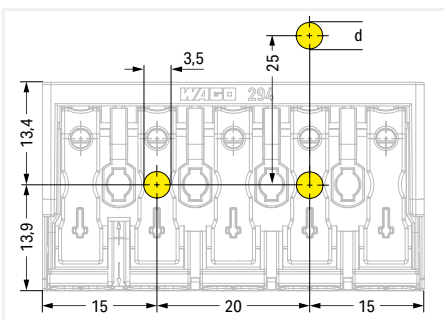

5-pole –
with snap-in ground contact, $d = 4.9 \text{ mm}$
with screw-type ground contact, $d \leq 4.1 \text{ mm}$

9

Drilled-Hole Patterns for Snap-In Mounting Feet 294 Series

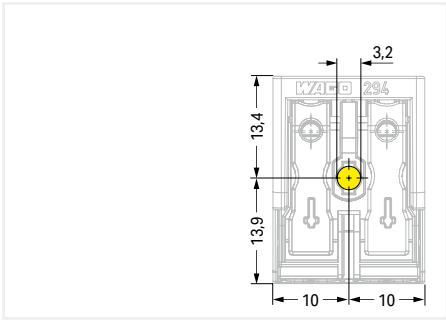

2-pole – without ground contact

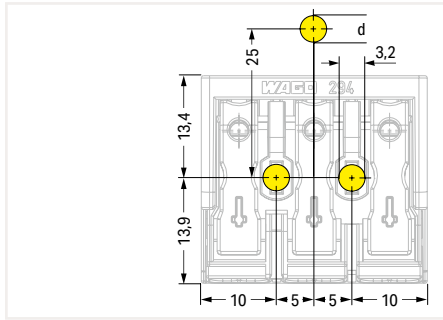

3-pole –
with snap-in ground contact, $d = 4.9 \text{ mm}$
with screw-type ground contact, $d \leq 4.1 \text{ mm}$

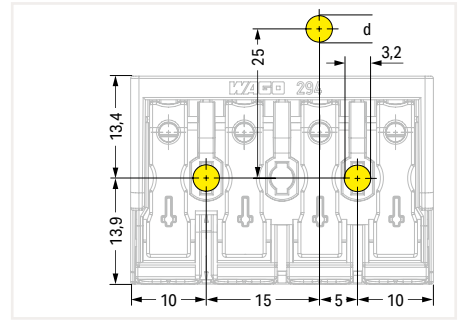

4-pole –
with snap-in ground contact, $d = 4.9 \text{ mm}$
with screw-type ground contact, $d \leq 4.1 \text{ mm}$

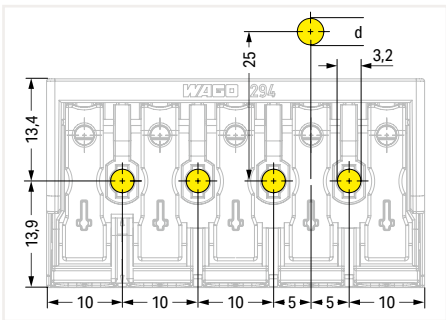

5-pole –
with snap-in ground contact, $d = 4.9 \text{ mm}$
with screw-type ground contact, $d \leq 4.1 \text{ mm}$

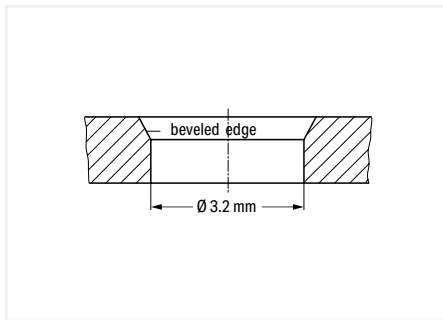

Hole for screw mount
Notice:
The maximum thread diameter for self-tapping screws is 3 mm.

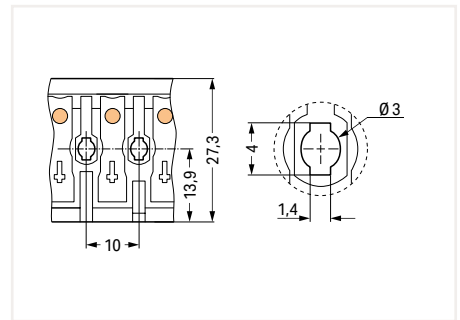

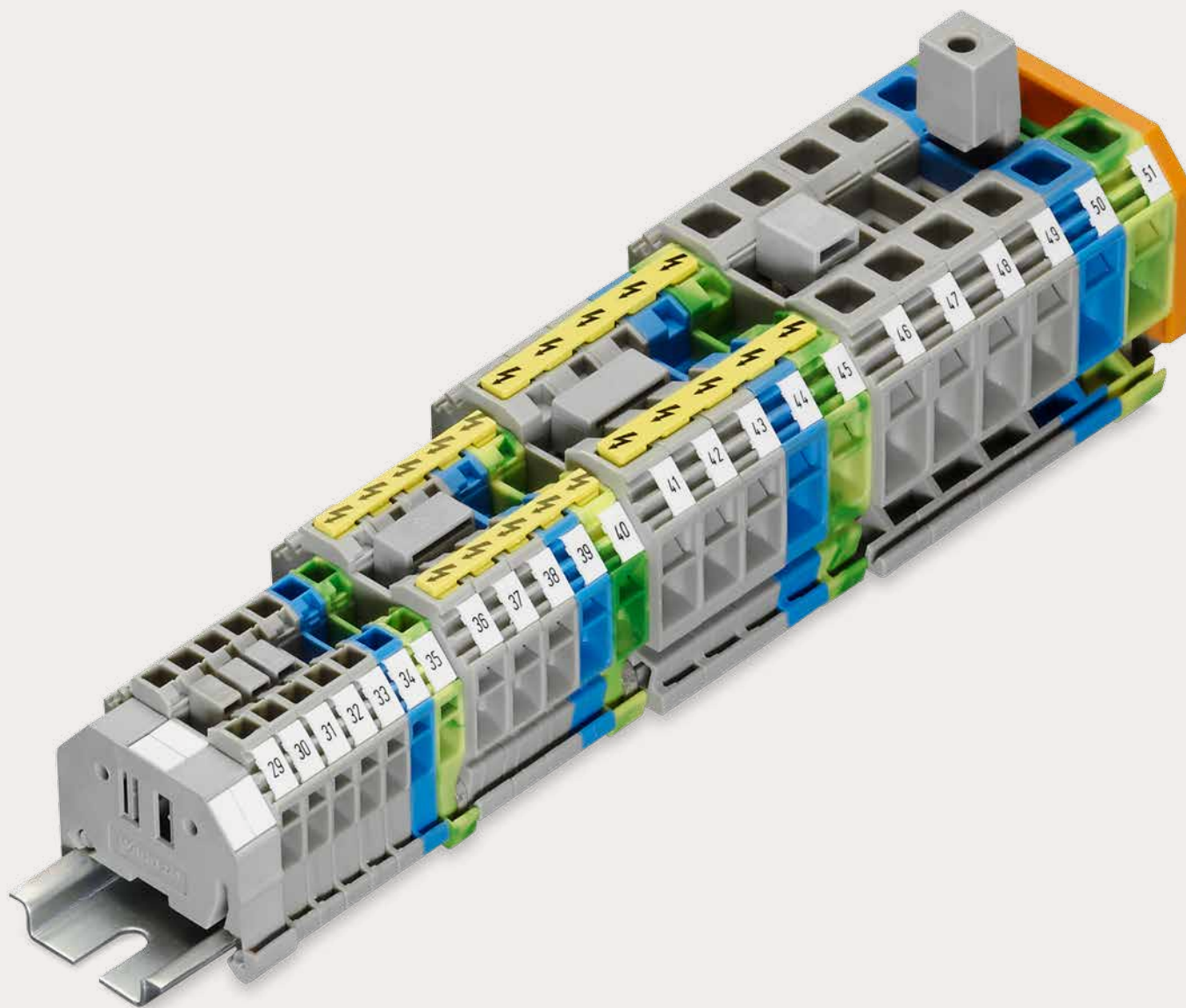

Mounting hole for screw
Notice:
The maximum thread diameter for self-tapping screws is 3 mm.



WAGO Rail-Mount Terminal Blocks Classic

WAGO Rail-Mount Terminal Blocks Classic

Side-Entry Wiring

			Page
	Through and Ground Conductor Terminal Blocks 0.08 ... 16 mm ² (28 ... 6 AWG)	279 ... 283 Series	502
	Disconnect/Test Terminal Blocks and Ground Conductor Disconnect Terminal Blocks 0.2 ... 6 mm ² (24 ... 10 AWG)	282 Series	506
	Fuse Terminal Blocks 0.2 ... 6 mm ² (24 ... 10 AWG)	282 Series	508

Rail-Mount Terminal Blocks Classic; Side-Entry Wiring 279 ... 284 Series Description and Installation

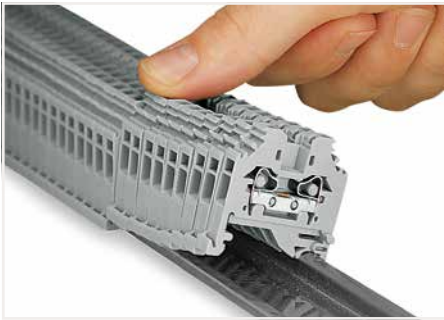

Snapping side-entry rail-mount terminal blocks onto the DIN-rail.

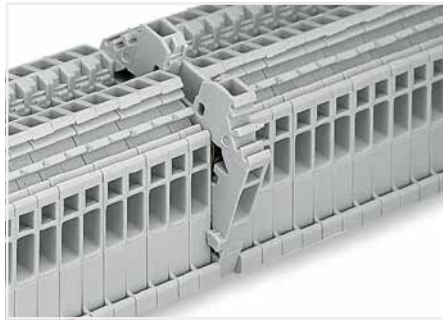

Quick assembly keys prevent reverse mounting.

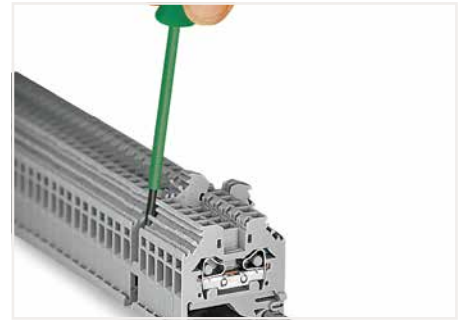

Removing a terminal block from the assembly.



CAGE CLAMP® connection
Inserting a conductor.
With ferruled conductors, it is necessary to use a terminal block one size larger than the conductor's nominal cross section.



Testing with a test plug –
Picture shows a test plug adapter (209-170).

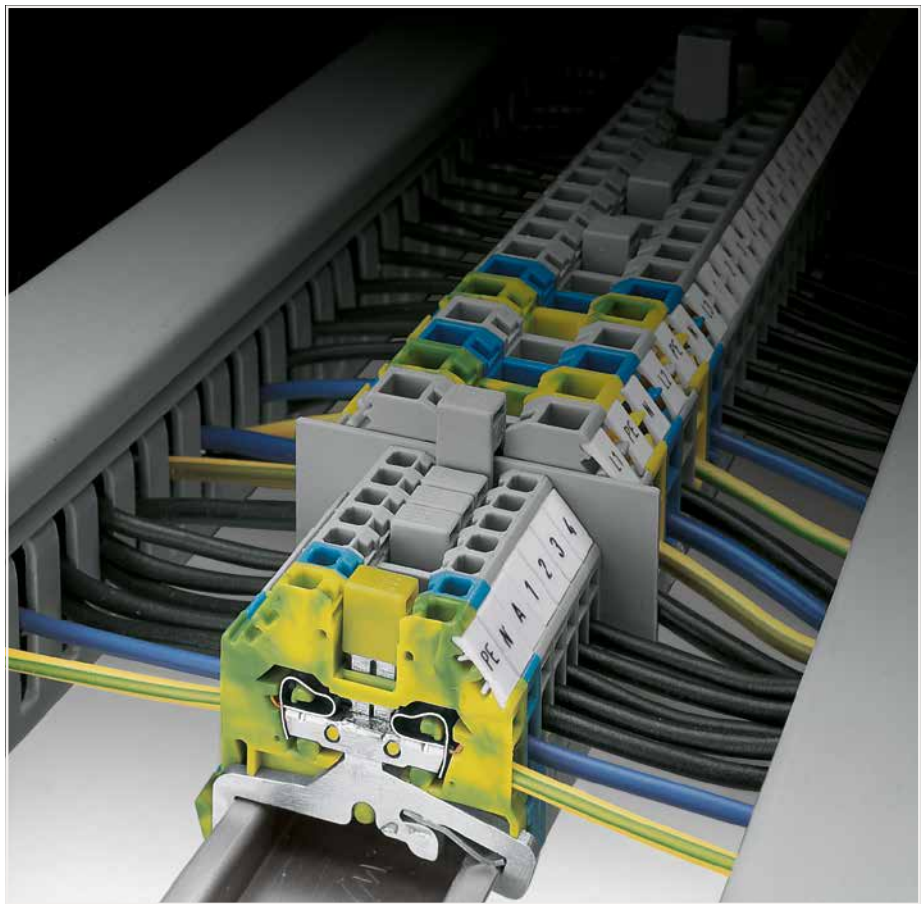

10



Commoning using an adjacent jumper (280-402).
Push jumpers down until fully inserted.



Commoning side-entry rail-mount terminal blocks via step-down jumpers.
Push down the step-down jumper until fully inserted.



CAGE CLAMP® terminates the following copper conductors:
solid



stranded



fine-stranded,
also with tinned
single strands



Suitable for all DIN-35 rails

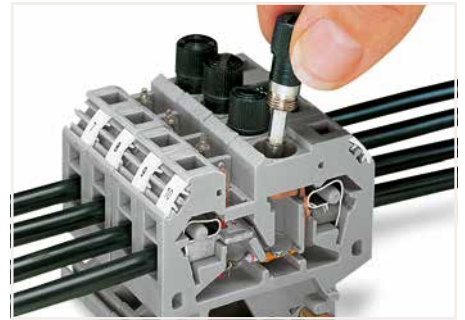

Replacing a fuse.

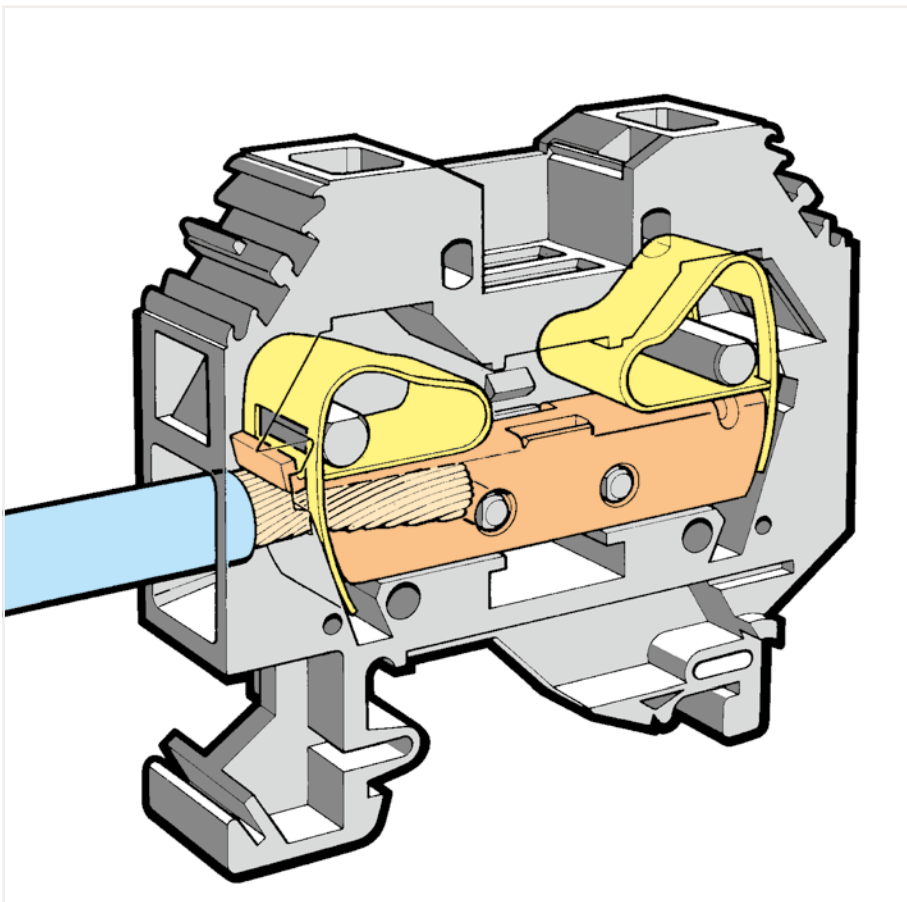

Shifting the disconnect slide link of a disconnect/test terminal block.

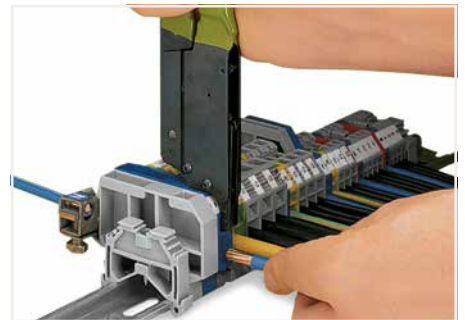

When operating the handles beyond the locked position, the ratchet allows the tool to open and be removed from the terminal block.



Labeling via WMB Multi Marking System.



fine-stranded, tip-bonded



fine-stranded, with ferrule (gastight crimped)



fine-stranded, with pin terminal (gastight crimped)

Through and Ground Conductor Terminal Block

1.5 mm²; 279 Series and 2.5 mm²; 280 Series and 4 mm²; 281 Series and 6 mm²; 282 Series

Technical Data	
0.08 ... 1.5 mm ²	28 ... 16 AWG
800 V/8 kV/3 ⚡	600 V, 10 A ⚡
I _N 18 A	600 V, 15 A ⚡
Terminal block width: 4 mm / 0.157 inch	
8 ... 9 mm / 0.31 ... 0.35 inch	

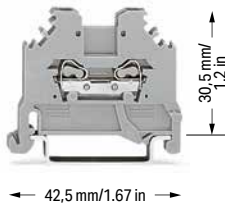

2-conductor through terminal block		
Color	Item No.	Pack. Unit
gray	279-101	100
blue	279-104 ②	100

Technical Data	
0.08 ... 2.5 mm ²	28 ... 12 AWG*
800 V/8 kV/3 ⚡	600 V, 20 A ⚡
I _N 24 A	600 V, 20 A ⚡
Terminal block width: 5 mm / 0.197 inch	
8 ... 9 mm / 0.31 ... 0.35 inch	

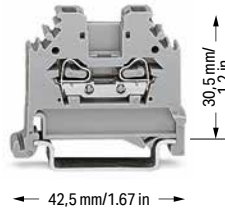

2-conductor through terminal block		
Color	Item No.	Pack. Unit
gray	280-101	100
blue	280-104 ②	100

Technical Data	
0.08 ... 4 mm ²	28 ... 12 AWG
800 V/8 kV/3 ⚡	600 V, 20 A ⚡
I _N 32 A	600 V, 25 A ⚡
Terminal block width: 6 mm / 0.236 inch	
9 ... 10 mm / 0.35 ... 0.39 inch	

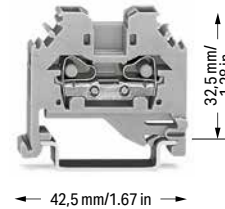

2-conductor through terminal block		
Color	Item No.	Pack. Unit
gray	281-101	100
blue	281-104 ②	100

2-conductor ground terminal block		
green-yellow	281-107	100

2-conductor ground terminal block		
green-yellow	281-107	100

Accessories; item-specific

End and intermediate plate; 2.5 mm thick		
orange	280-302	100 (25)
gray	280-301	100 (25)

Accessories; item-specific

End and intermediate plate; 2.5 mm thick		
orange	280-302	100 (25)
gray	280-301	100 (25)

Accessories; item-specific

End and intermediate plate; 3 mm thick		
orange	281-302	100 (25)
gray	281-301	100 (25)

Separator; oversized; 2 mm thick		
orange	280-322	100 (25)
gray	280-332	100 (25)

Separator; oversized; 2 mm thick		
orange	280-322	100 (25)
gray	280-332	100 (25)

Separator; oversized; 2 mm thick		
orange	281-322	100 (25)
gray	281-332	100 (25)

Adjacent jumper; insulated; I _N 15 A		
gray	279-402	200 (25)
yellow-green	279-422	200 (25)

Adjacent jumper; insulated; I _N = I _N terminal block		
gray	280-402	200 (25)
yellow-green	280-422	200 (25)

Adjacent jumper; insulated; I _N = I _N terminal block		
gray	281-402	200 (25)
yellow-green	281-422	200 (25)

Alternate jumper; insulated; I _N 15 A		
gray	279-409	100 (25)

Alternate jumper; insulated; I _N = I _N terminal block		
gray	280-409	100 (25)

Alternate jumper; insulated; I _N = I _N terminal block		
gray	281-409	100 (25)

Step-down jumper; insulated; commons 10/6 mm ² (8/10 AWG) down to 4/2.5/1.5 mm ² (12/14/16 AWG); I _N 15 A		
gray	284-414	50 (25)

Step-down jumper; insulated; commons 10/6 mm ² (8/10 AWG) down to 4/2.5/1.5 mm ² (12/14/16 AWG); I _N 15 A		
gray	284-414	50 (25)

Step-down jumper; insulated; commons 10/6 mm ² (8/10 AWG) down to 4/2.5/1.5 mm ² (12/14/16 AWG); I _N 15 A		
gray	284-414	50 (25)

Step-down intermediate plate; 1 mm thick; only for 4, 2.5 and 1.5 mm ² terminal blocks		
gray	281-333	100 (25)
orange	281-336	100 (25)

Step-down intermediate plate; 1 mm thick; only for 4, 2.5 and 1.5 mm ² terminal blocks		
gray	281-333	100 (25)
orange	281-336	100 (25)

Step-down intermediate plate; 1 mm thick; only for 4, 2.5 and 1.5 mm ² terminal blocks		
gray	281-333	100 (25)
orange	281-336	100 (25)

Protective warning marker; with black high-voltage symbol; for 5 terminal blocks		
yellow	279-405	100 (25)

Protective warning marker; with black high-voltage symbol; for 5 terminal blocks		
yellow	280-405	100 (25)

Step-down jumper; insulated; commons 10/6 mm ² (8/10 AWG) down to 6/4 mm ² (10/12 AWG); I _N 30 A		
gray	284-413	50 (25)

Test plug adapter; 8.3 mm wide; for 4 mm Ø test plug; for 1.5 ... 10 mm ² terminal blocks		
gray	209-170	50 (25)

Test plug adapter; 8.3 mm wide; for 4 mm Ø test plug; for 1.5 ... 10 mm ² terminal blocks		
gray	209-170	50 (25)

Step-down jumper; insulated; commons 16 mm ² (6 AWG) down to 4 mm ² (12 AWG); I _N 32 A		
gray	283-414	50 (25)

Test plug adapter; 5 mm wide; for 210-137 Test Plug (2.3 mm Ø); for 1.5 ... 4 mm ² terminal blocks		
gray	280-404	100 (25)

Test plug adapter; 5 mm wide; for 210-137 Test Plug (2.3 mm Ø); for 1.5 ... 4 mm ² terminal blocks		
gray	280-404	100 (25)

Protective warning marker; with black high-voltage symbol; for 5 terminal blocks		
yellow	281-405	100 (25)

Technical Data

0.2 ... 6 mm ²	24 ... 10 AWG
800 V/8 kV/3 ①	600 V, 30 A ②
I _N 41 A	600 V, 10 A ③
Terminal block width: 8 mm / 0.315 inch	
12 ... 13 mm / 0.47 ... 0.51 inch	

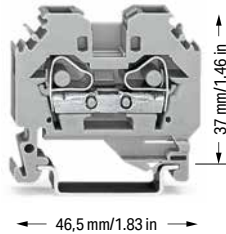

2-conductor through terminal block

Color	Item No.	Pack. Unit
gray	282-101	50
blue	282-104 ②	50

2-conductor ground terminal block

green-yellow	282-107	50
--------------	---------	----

Accessories; item-specific

End and intermediate plate; 4 mm thick

orange	282-302	100 (25)
gray	282-301	100 (25)

Separator; oversized; 2 mm thick

orange	282-322	100 (25)
gray	282-332	100 (25)

Adjacent jumper; insulated; I_N 41 A

gray	282-402	100 (25)
yellow-green	282-422	100 (25)

Alternate jumper; insulated; I_N 41 A

gray	282-409	100 (25)
------	---------	----------

Step-down jumper; insulated; commons 10/6 mm² (8/10 AWG) down to 6/4 mm² (10/12 AWG); I_N 30 A

gray	284-413	50 (25)
------	---------	---------

Step-down cover plate; 1 mm thick

gray	284-333	100 (25)
orange	284-343	100 (25)

Protective warning marker; with black high-voltage symbol; for 5 terminal blocks

yellow	282-405	100 (25)
--------	---------	----------

Test plug adapter; 8.3 mm wide; for 4 mm Ø test plug; for 1.5 ... 10 mm² terminal blocks

gray	209-170	50 (25)
------	---------	---------

B-type test plug module; snaps together; 8 mm wide

gray	709-310	100 (25)
------	---------	----------

*12 AWG: THHN, THWN

- 800 V = rated voltage
8 kV = rated impulse voltage
3 = pollution degree
(see Section 14)

- Terminal blocks with a blue insulated housing are suitable for Ex i applications.

See application notes for:
Step-down jumper, page 234
Test plug module, page 345
Marking, from page 588

Approvals and corresponding ratings,
visit www.wago.com

DIN-Rail	Item No.	Current [A]	Acc. to mm ² /AWG/Cu
DIN 35 x 7.5 (steel) slotted	210-112	76	16/6
unslotted	210-113	76	16/6
DIN 35 x 15 (steel)			
1.5 mm thick	210-114	125	35/2
2.3 mm thick	210-118	125	35/2
DIN 35 x 7.5 (Al)			
unslotted	210-196	76	16/6
DIN 35 x 15 (Cu)			
2.3 mm thick	210-198	309	150/6/0

When using standard DIN-rails as ground conductor bus-bars, please refer to the maximum current capacities listed above.

Steel DIN-rails are not suited for PEN (ground and N-conductor) applications per EN 60947-7-2 (VDE 0611, Part 3).

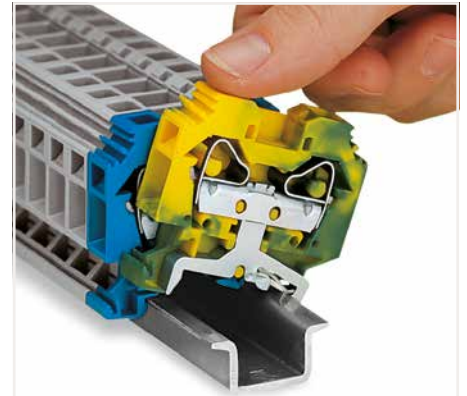

Snapping a terminal block onto the DIN-rail. Ground conductor terminal blocks snap onto the rail in the same way as through terminal blocks, but automatically make a direct electrical connection to the rail. After mounting, sliding the blocks on the rail is not possible.



Removing a terminal block from the DIN-rail. When mounting on the rail, ensure that open sides of terminal blocks face in the same direction. Both mounting feet and removal slots are on the same side for all terminal blocks, making it possible to visually ensure blocks are facing in same direction.

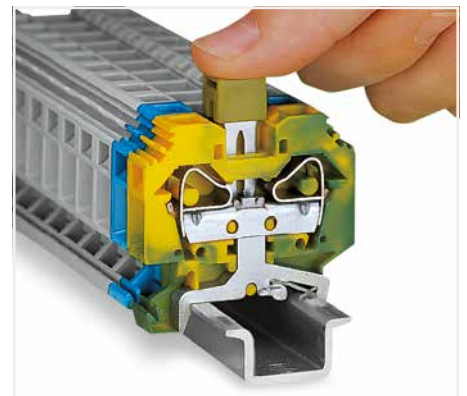

Push jumper down until fully inserted. Commoning ground conductor terminal blocks with through terminal blocks is possible in one direction only (via rear side of terminal block) using adjacent jumpers. Recommends using yellow-green adjacent jumpers in addition to the required marking of these blocks.

Through and Ground Conductor Terminal Block

10 mm²; 284 Series and 16 mm²; 283 Series

Technical Data

0.2 ... 10 mm ²	24 ... 8 AWG
800 V/8 kV/3 ①	600 V, 50 A ②
I _N 57 A	600 V, 65 A ③
Terminal block width: 10 mm / 0.394 inch	
12 ... 13 mm / 0.47 ... 0.51 inch	

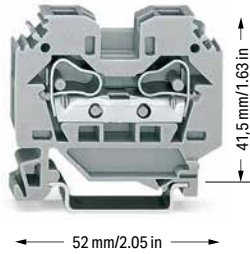

Technical Data

0.2 ... 16 mm ²	24 ... 6 AWG
800 V/8 kV/3 ①	600 V, 65 A ②
I _N 76 A	600 V, 90 A ③
Terminal block width: 12 mm / 0.472 inch	
16 ... 17 mm / 0.63 ... 0.67 inch	

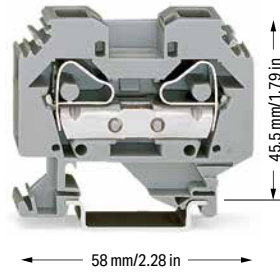

- ① 800 V = rated voltage
8 kV = rated impulse voltage
3 = pollution degree
(see Section 14)

See application notes for:
Step-down jumper, page 234
Test plug module, page 345
Marking, from page 588

Approvals and corresponding ratings,
visit www.wago.com

2-conductor through terminal block

Color	Item No.	Pack. Unit
gray	284-101	50
blue	284-104 ②	50

2-conductor through terminal block

Color	Item No.	Pack. Unit
gray	283-101	50
blue	283-104 ②	50

2-conductor ground terminal block

green-yellow	284-107	50
--------------	---------	----

2-conductor ground terminal block

green-yellow	283-107	50
--------------	---------	----

Accessories; item-specific

End and intermediate plate; 2.5 mm thick

orange	284-302	100 (25)
gray	284-301	100 (25)

Accessories; item-specific

End and intermediate plate; 4 mm thick

orange	283-302	50 (25)
gray	283-301	50 (25)

Separator; oversized; 2 mm thick

orange	284-322	100 (25)
gray	284-332	100 (25)

Separator; oversized; 2 mm thick

orange	283-322	50 (25)
gray	283-332	50 (25)

Adjacent jumper; insulated; I_N 57 A

gray	284-402	100 (25)
yellow-green	284-422	100 (25)

Adjacent jumper; insulated; I_N 76 A

gray	283-402	50 (25)
yellow-green	283-422	50 (25)

Alternate jumper; insulated; I_N 57 A

gray	284-409	50 (25)
------	---------	---------

Alternate jumper; insulated; I_N 76 A

gray	283-409	50 (25)
------	---------	---------

Step-down jumper; insulated; commons 10/6 mm² (8/10 AWG) down to 6/4 mm² (10/12 AWG); I_N 30 A

gray	284-413	50 (25)
------	---------	---------

Step-down jumper; insulated; commons 16 mm² (6 AWG) down to 4 mm² (12 AWG); I_N 32 A

gray	283-414	50 (25)
------	---------	---------

Step-down cover plate; 1 mm thick

gray	284-333	100 (25)
orange	284-343	100 (25)

Step-down cover plate; 1 mm thick

gray	283-333	100 (25)
orange	283-335	100 (25)

Protective warning marker; with black high-voltage symbol; for 5 terminal blocks

yellow	284-405	50 (25)
--------	---------	---------

Protective warning marker; with black high-voltage symbol; for 5 terminal blocks

yellow	283-405	50 (25)
--------	---------	---------

Test plug adapter; 8.3 mm wide; for 4 mm Ø test plug; for 1.5 ... 10 mm² terminal blocks

gray	209-170	50 (25)
------	---------	---------

Test plug adapter; 8.3 mm wide; for 4 mm Ø test plug; for 1.5 ... 10 mm² terminal blocks

gray	283-404	25
------	---------	----

B-type test plug module; snaps together; 8 mm wide

gray	709-310	100 (25)
------	---------	----------



Step-down jumpers common terminal blocks of different sizes, without losing a conductor clamping point. This can be beneficial on long conductor runs where voltage drop can be a problem. A large conductor can be easily connected to smaller conductors at the distribution point.

Step-down jumpers are simply pushed down for full insertion, similar to adjacent jumpers. Commoning may be made in either direction using the special thin end plate to cover the open side. Additional through terminal blocks having a smaller cross-section may be commoned using adjacent jumpers.

In this case, pay attention that:
The total current of the outgoing circuits does not exceed the nominal current of the step-down jumper.
The standard or special thin cover plate is installed on the open side of the larger block.

10

Step-Down Jumper; for Side-Entry Through Terminal Blocks Installation



Step-down jumper; insulated; commons 10/6 mm² (8/10 AWG) down to 4/2.5/1.5 mm² (12/14/16 AWG); I_N 15 A

Color	Item No.	Pack. Unit
○ gray	284-414	50 (25)

Step-down jumper; insulated; commons 10/6 mm² (8/10 AWG) down to 6/4 mm² (10/12 AWG); I_N 30 A

○ gray	284-413	50 (25)
--------	---------	---------

Accessories; item-specific

Step-down cover plate; 1 mm thick

gray	284-333	100 (25)
orange	284-343	100 (25)

Step-down intermediate plate; 1 mm thick; only for 4, 2.5 and 1.5 mm² terminal blocks

gray	281-333	100 (25)
orange	281-336	100 (25)

Step-down jumper; insulated; commons 16 mm² (6 AWG) down to 4 mm² (12 AWG); I_N 32 A

Color	Item No.	Pack. Unit
○ gray	283-414	50 (25)

Accessories; item-specific

Step-down cover plate; 1 mm thick

gray	283-333	100 (25)
orange	283-335	100 (25)

Side-entry terminal blocks cannot be commoned with front-entry terminal blocks via step-down jumpers. For commoning front-entry terminal blocks via step-down jumpers, see page 250.



Commoning from 6 mm²/10 AWG (282 Series) to 1.5 mm²/16 AWG (279 Series) rail-mount terminal blocks via step-down jumpers.

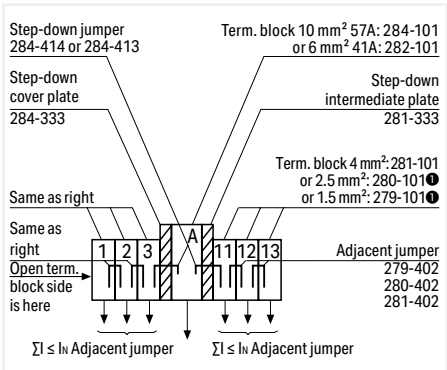

Assembly example: Commoning from 10/6 mm² (8/10 AWG) to 4/2.5/1.5 mm² (12/14/16 AWG) rail-mount terminal blocks via step-down jumper (284-414).
 Ⓢ Commoning with step-down jumpers from 10 mm² (284-101) to 2.5 mm² (280-101) or 1.5 mm² (279-101) terminal blocks via the terminal block rear side is not possible (see example: terminal block A to 11).

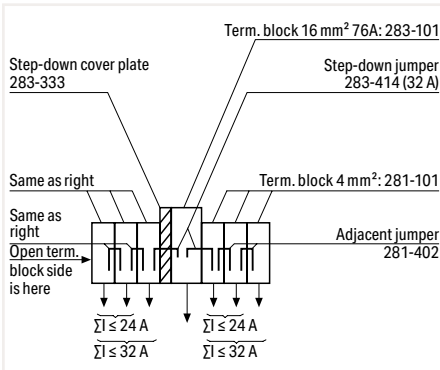

Assembly example: Commoning from 16 mm²/6 AWG to 4 mm²/12 AWG rail-mount terminal blocks via step-down jumper (283-414).



Commoning from 16 mm²/6 AWG (283 Series) to 4 mm²/12 AWG (281 Series) rail-mount terminal blocks via step-down jumpers.

Disconnect/Test Terminal Block

6 mm²; 282 Series

Technical Data	
0.2 ... 6 mm ²	24 ... 10 AWG
400 V/6 kV/3 ①	300 V, 30 A ②
I _N 41 A	300 V, 40 A ③
Terminal block width: 8 mm / 0.315 inch	
12 ... 13 mm / 0.47 ... 0.51 inch	

Technical Data	
0.2 ... 6 mm ²	24 ... 10 AWG
400 V/6 kV/3 ①	300 V, 30 A ②
I _N 41 A	300 V, 40 A ③
Terminal block width: 8 mm / 0.315 inch	
12 ... 13 mm / 0.47 ... 0.51 inch	

Technical Data	
0.2 ... 6 mm ²	24 ... 10 AWG
400 V/6 kV/3 ①	300 V, 30 A ②
I _N 41 A	300 V, 40 A ③
Terminal block width: 8 mm / 0.315 inch	
12 ... 13 mm / 0.47 ... 0.51 inch	

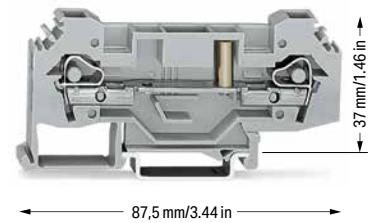
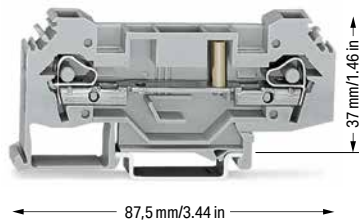
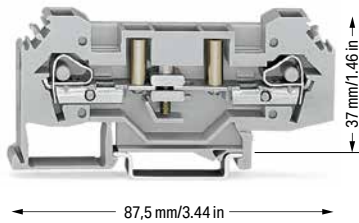



Disconnect/test terminal block; with 4 mm Ø test sockets		
Color	Item No.	Pack. Unit
○ gray	282-131	25

Through terminal block		
Color	Item No.	Pack. Unit
○ gray	282-133	25

Disconnect/test terminal block; without test sockets		
Color	Item No.	Pack. Unit
○ gray	282-135	25

Accessories; item-specific			
Alternate jumper; insulated; I _N 41 A			
	gray	282-409	100 (25)

Accessories; item-specific			
Alternate jumper; insulated; I _N 41 A			
	gray	282-409	100 (25)

Accessories; item-specific			
Alternate jumper; insulated; I _N 41 A			
	gray	282-409	100 (25)

Accessories; item-specific			
Lock-out; prevents reclosing of slide link; snap-on type			
	orange	282-137	100 (25)

Accessories; item-specific			
Lock-out; prevents reclosing of slide link; snap-on type			
	orange	282-137	100 (25)

Accessories; 282 Series

Appropriate marking system: WMB

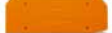
End and intermediate plate; 4 mm thick			
	gray	282-315	50 (25)
	orange	282-314	50 (25)

Screwless end stop; for DIN-35 rail; 6 mm wide			
	gray	249-116	100 (25)

Protective warning marker; with black high-voltage symbol; for 5 terminal blocks			
	yellow	282-405	100 (25)

Screwless end stop; for DIN-35 rail; 10 mm wide			
	gray	249-117	50 (25)

Adjacent jumper; insulated; I _N 41 A			
	gray	282-402	100 (25)

Test plug adapter; 8.3 mm wide; for 4 mm Ø test plug; for 1.5 ... 10 mm ² terminal blocks			
	gray	209-170	50 (25)

B-type test plug module; snaps together; 8 mm wide			
	gray	709-310	100 (25)

B-type spacer module; snaps together; 8 mm wide			
	gray	709-311	100 (25)

10

Technical Data	
0.2 ... 6 mm ²	24 ... 10 AWG

Terminal block width: 16 mm / 0.63 inch
 12 ... 13 mm / 0.47 ... 0.51 inch

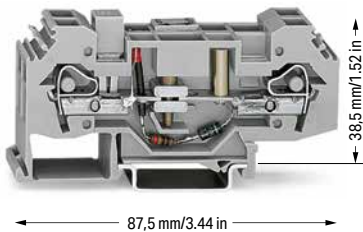

Ground conductor disconnect terminal block; gray		
Color	Item No.	Pack. Unit
○ 24 V	282-140	12
○ 48 V	282-141	12
○ 120 V	282-138	12
○ 230 V	282-139	12

Accessories; item-specific		
Lock-out; prevents reclosing of slide link; snap-on type		
orange	282-137	100 (25)



- 1 400 V = rated voltage
6 kV = rated impulse voltage
3 = pollution degree (see Section 14)
- See application notes for:
Test plug module, page 345
Marking, from page 588
- Approvals and corresponding ratings,
visit www.wago.com

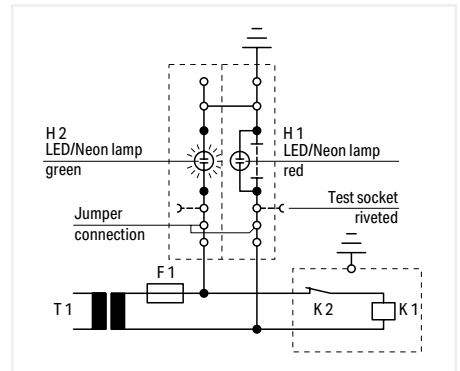

Operation
Slide link closed, auxiliary circuit grounded, green LED/neon lamp illuminates.

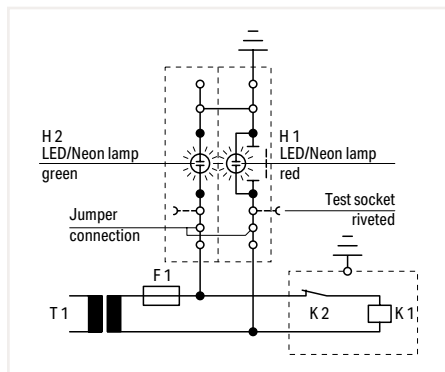

Test condition – no grounding
Slide link open, auxiliary circuit not grounded.

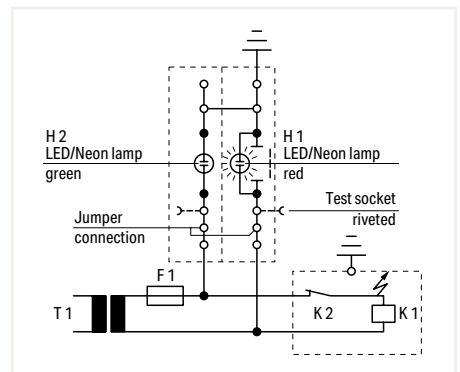

Test condition – grounding
Slide link open, auxiliary circuit not grounded, red LED/neon lamp illuminates.

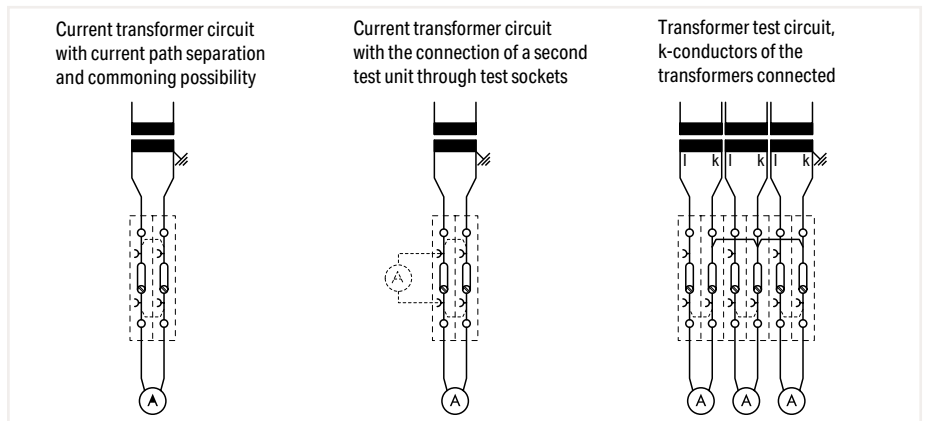

IEC 60204/DIN VDE 0113 "Safety of machinery – Electrical equipment of machines – Part 1: General requirements," Section 9.4.3.1:

Ground faults on control circuits must not cause unintentional starting, hazardous movements, or prevent stopping of the machine.

In order to fulfill this requirement, a connection to the protective bonding circuit must be provided in accordance with Section 8.2 and the devices must be connected as described in Section 9.1.4. Control circuits fed from a transformer and not connected to the protective bonding circuit must be provided with an insulation monitoring device (e.g., residual current device), which either indicates a ground fault or interrupts the circuit automatically after a ground fault. In the case of electronic circuits, the connection of one side of the control circuit to the protective bonding circuit in accordance with Section 9.1.4 can prevent unintentional operation. When this does not help, or if due to other reasons that electronic circuits cannot be connected to the protective bonding circuit, other measures must be taken to achieve the same level of safety.

Multipole control switches that interrupt all live conductors must be used where the control circuit is directly connected between the phase conductors of the supply or between a phase conductor and a neutral conductor, which is either not grounded or grounded through a high impedance. This is required for starting or stopping machine functions, which can cause a hazardous situation including: damaging the machine or halting work in progress in the event of unintentional starting or failure to stop.

Fuse Terminal Block

6 mm²; 282 Series

Technical Data	
0.2 ... 6 mm ²	24 ... 10 AWG
500 V/6 kV/3 ①	600 V, 10 A ②
I _N 10 A	250 V, 10 A ③
Terminal block width: 13 mm / 0.512 inch	
12 ... 13 mm / 0.47 ... 0.51 inch	

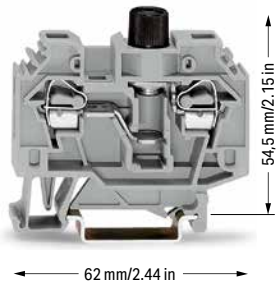

2-conductor fuse terminal block; for 5 x 20 mm glass cartridge fuse; without indicator		
Color	Item No.	Pack. Unit
○ gray	282-122	40

Technical Data	
0.2 ... 6 mm ²	24 ... 10 AWG
500 V/6 kV/3 ①	600 V, 10 A ②
I _N 10 A	250 V, 10 A ③
Terminal block width: 13 mm / 0.512 inch	
12 ... 13 mm / 0.47 ... 0.51 inch	

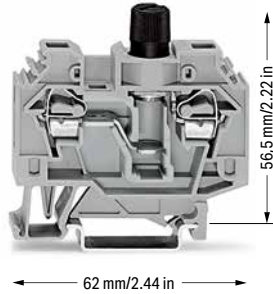

2-conductor fuse terminal block; for 1/4" x 1 1/4" glass cartridge fuse; without indicator		
Color	Item No.	Pack. Unit
○ gray	282-120	40

2-conductor fuse terminal block; for 1/4" x 1 1/4" glass cartridge fuse; without indicator		
Color	Item No.	Pack. Unit
○ gray	282-128	40

Technical Data	
0.2 ... 6 mm ²	24 ... 10 AWG
500 V/6 kV/3 ①	600 V, 10 A ②
I _N 10 A	250 V, 10 A ③
Terminal block width: 13 mm / 0.512 inch	
12 ... 13 mm / 0.47 ... 0.51 inch	



2-conductor fuse terminal block; for 5 x 25 mm glass cartridge fuse; with indicator		
Color	Item No.	Pack. Unit
○ gray	282-126	40

Accessories; item-specific		
Glass cartridge fuse; without indicator; 5 x 20 mm; 6.3 A / 250 V; medium-acting		



Accessories; item-specific		
Glass cartridge fuse; without indicator; 1/4" x 1", 10 A / 240 V; per BS 1362		



Glass cartridge fuse; without indicator; 1/4" x 1 1/4"; 10 A / 250 V; medium-acting		
---	--	--



Glass cartridge fuse; without indicator; 1/4" x 1 1/4"; very fast-acting		
--	--	--



Accessories; item-specific		
Glass cartridge fuse; with indicator; 5 x 25 mm; 6.3 A / 250 V; medium-acting		



Glass cartridge fuse; with indicator; 5 x 25 mm, 10 A / 450 V; fast-acting		
--	--	--



Accessories; 282 Series

Appropriate marking system: WMB

End and intermediate plate; 4 mm thick			
gray	282-312	50 (25)	
orange	282-311	50 (25)	



Protective warning marker; with black high-voltage symbol; for 5 terminal blocks			
yellow	282-405	100 (25)	



Adjacent jumper; insulated; I _N 41 A			
gray	282-402	100 (25)	



Test plug adapter; 8.3 mm wide; for 4 mm Ø test plug; for 1.5 ... 10 mm ² terminal blocks			
gray	209-170	50 (25)	



Test plug adapter; 6 mm wide; with CAGE CLAMP®; for 0.08 ... 2.5 mm ²			
I _N 24 A	281-407	100 (25)	



Operating pliers; for 281, 282, 283, 284 Series side-entry rail-mounted terminal blocks			
	210-141	1	



Technical Data	
0.2 ... 6 mm ²	24 ... 10 AWG

Terminal block width: 13 mm / 0.512 inch

12 ... 13 mm / 0.47 ... 0.51 inch



2-conductor fuse terminal block; for 1/4" x 1 1/4" glass cartridge fuse; with 24 VDC red LED		
Color	Item No.	Pack. Unit
○ gray	282-128/281-413	40

Technical Data	
0.2 ... 6 mm ²	24 ... 10 AWG

Terminal block width: 13 mm / 0.512 inch

12 ... 13 mm / 0.47 ... 0.51 inch

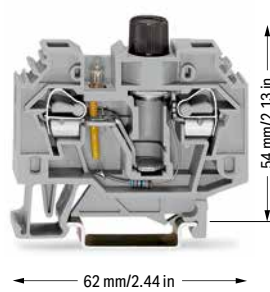

2-conductor fuse terminal block; for 1/4" x 1 1/4" glass cartridge fuse; with 250 VAC/220 VDC neon lamp		
Color	Item No.	Pack. Unit
○ gray	282-128/281-417	40

2-conductor fuse terminal block; for 5 x 20 mm glass cartridge fuse; with 250 VAC/220 VDC neon lamp		
Color	Item No.	Pack. Unit
○ gray	282-124	40

2-conductor fuse terminal block; for 1/4" x 1 1/4" glass cartridge fuse; with 120 VAC/DC neon lamp		
Color	Item No.	Pack. Unit
○ gray	282-128/281-418	40

① 500 V = rated voltage
 6 kV = rated impulse voltage
 3 = pollution degree
 (see Section 14)
 Electrical ratings are given by the fuse or LED nominal voltage (see page 292).

Approvals and corresponding ratings, visit www.wago.com

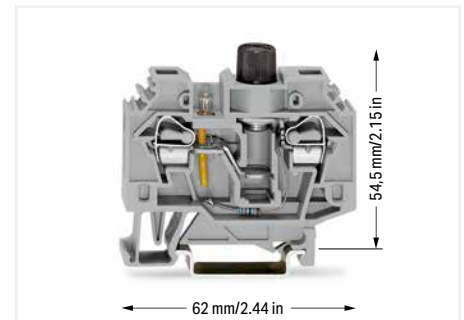

Dimensions in mm
 Item No. 282-124

Accessories; item-specific		
Glass cartridge fuse; without indicator; 1/4" x 1 1/4"; 10 A / 250 V; medium-acting		
	282-457	200 (100)

Glass cartridge fuse; without indicator; 1/4" x 1 1/4"; very fast-acting		
	282-454	200 (10)

Accessories; item-specific		
Glass cartridge fuse; without indicator; 5 x 20 mm; 6.3 A / 250 V; medium-acting		
	282-451	100

Glass cartridge fuse; without indicator; 1/4" x 1 1/4"; 10 A / 250 V; medium-acting		
	282-457	200 (100)

Glass cartridge fuse; without indicator; 1/4" x 1 1/4"; very fast-acting		
	282-454	200 (10)

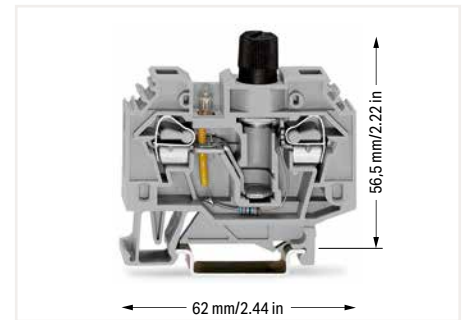

Dimensions in mm
 Item No. 282-128/281-418

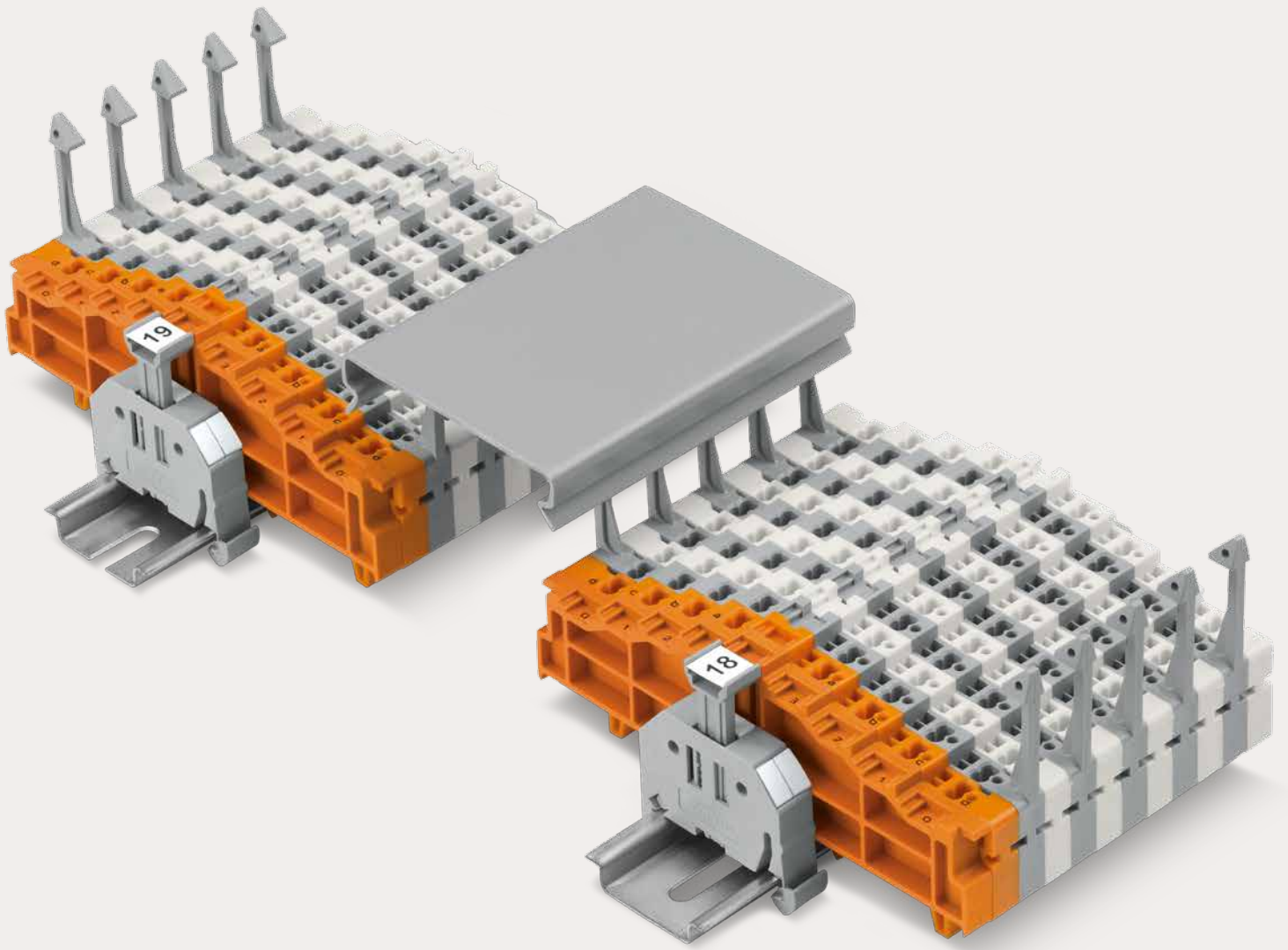







WAGO Patchboard Systems

WAGO Busbar Terminal Blocks

WAGO Patchboard Systems

WAGO Busbar Terminal Blocks

			Page
	Matrix Patchboards	726 Series	514
	Common Potential Matrix Patchboards Marking on the Patchboard Side Marking on the Supply Side	726 Series	518
	Matrix Patchboard Accessories		522
	Terminal Blocks for Matrix Patching and Common Potential Terminal Blocks 1.5 mm ² (16 AWG)	727 Series	526
	3-Conductor, Double-Potential Terminal Blocks 2.5 mm ² (14 AWG)	280 Series	531
	Busbar Terminal Blocks	812 Series	533

Matrix Patchboards

726 Series

Description and Installation

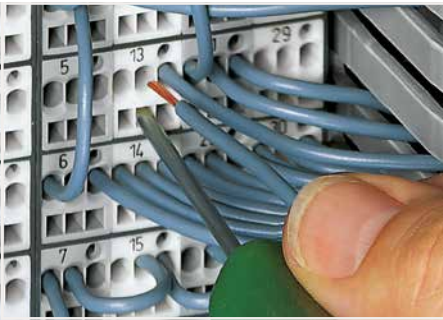

CAGE CLAMP® connection
Inserting a conductor via 210-719 Operating Tool (2.5 x 0.4 mm blade).



Factory-marked modules
Side 1: 1, 2, 3, 4 ...

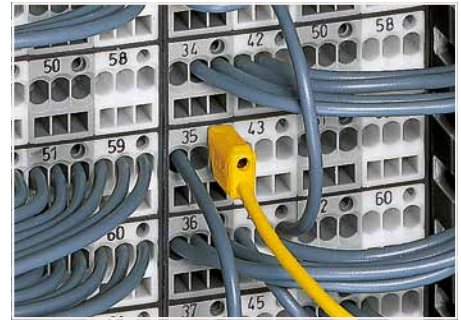

Testing with a 2.3 mm Ø test plug (210-137).

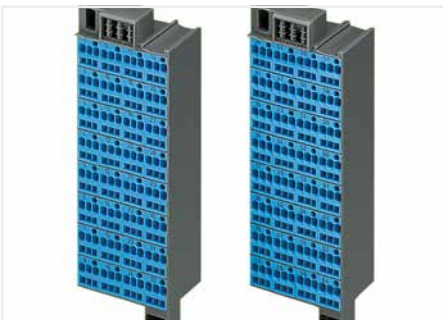

Blue matrix patchboards are suitable for Ex i applications.



WFB continuous marking strip – fits into the matrix patchboards' marker slot and group marker carrier.

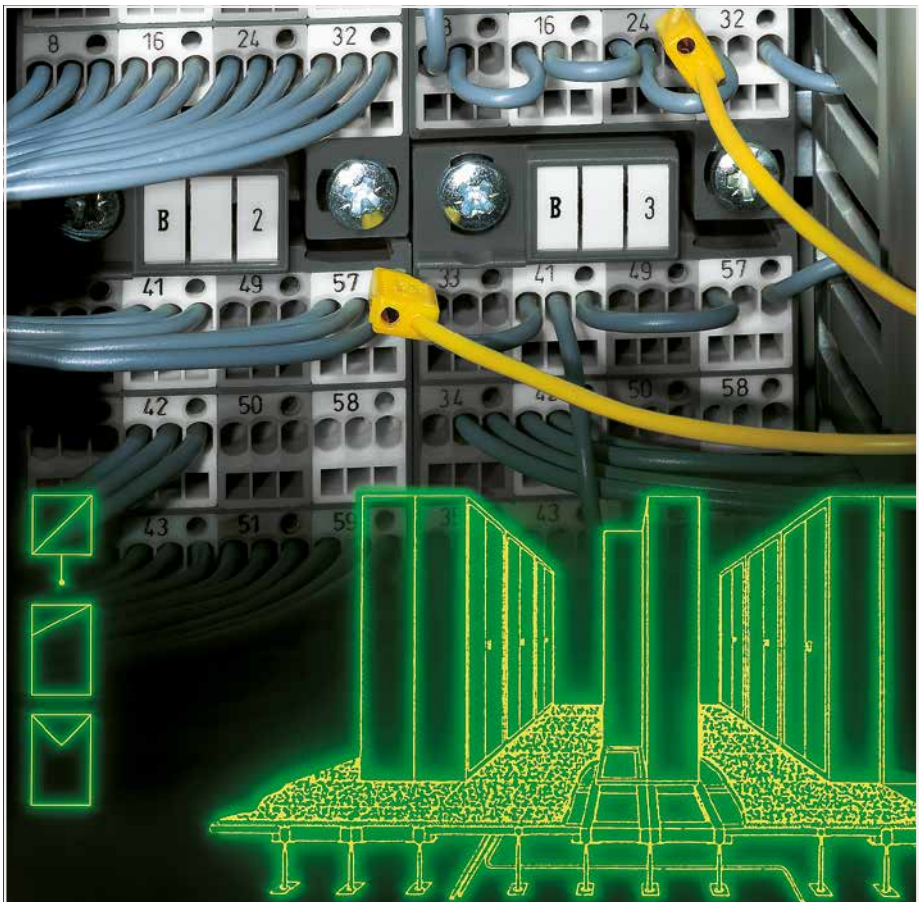

11



Individual group marking via WSB Quick Marking System.



Installation example:
Matrix patchboards in a frame

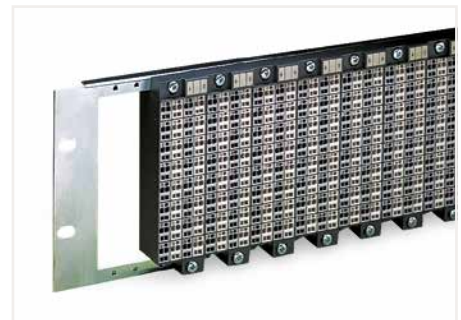

Installation example:
Matrix patchboards in a 19" rack



CAGE CLAMP® terminates the following copper conductors:
solid



stranded



fine-stranded, also with tinned single strands



Space saving:
Slimline matrix patchboard (lower right), mounted upside down



Snapping on an additional module with contact to mounting frame.



Assembling a matrix patchboard with additional module – direct connection to the mounting frame.

	Max. conductor cross section (mm ² /AWG) without ferrule	Max. conductor cross section (mm ² /AWG) with ferrule			
		insulated		uninsulated	
		0.75	Item No./Color 216-202/ gray	1	Item No. 216-103
Side 2	1.5				
Side 1	1.5	0.75	216-202/ gray	1	216-103
Side 2	2.5	1.5	216-204/ black	1.5	216-104
Side 1	1.5	0.75	216-202/ gray	1	216-103



Terminating ferruled conductors via operating tool.



fine-stranded, tip-bonded



fine-stranded, with ferrule (gastight crimped)



fine-stranded, with pin terminal (gastight crimped)

Matrix Patchboard; 32-Pole 726 Series

Technical Data		Technical Data	
Side 1: 3x 0.08 ... 1.5 mm ²	28 ... 16 AWG	Side 1: 3x 0.08 ... 1.5 mm ²	28 ... 16 AWG
Side 2: 3x 0.08 ... 1.5 mm ²	28 ... 16 AWG	Side 2: 2x 0.08 ... 2.5 mm ²	28 ... 14 AWG
500 V/6 kV/3 ①	300 V, 10 A ②	500 V/6 kV/3 ①	300 V, 10 A ②
I _n 10 A	300 V, 10 A ②	I _n 10 A	300 V, 10 A ②
8 ... 10 mm / 0.31 ... 0.39 inch		8 ... 10 mm / 0.31 ... 0.39 inch	



Dimensions in mm

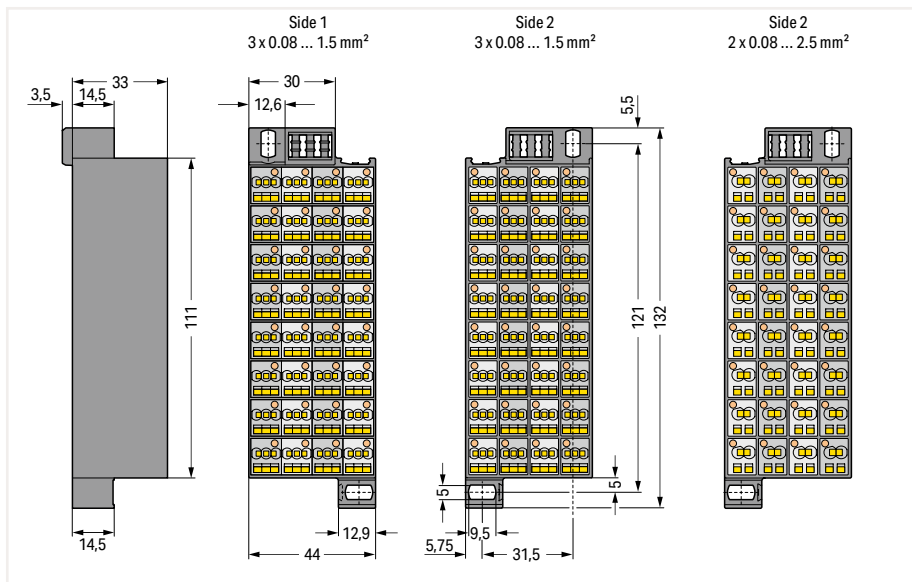

Matrix patchboard; Dark gray frame; Gray/white modules; Vertical module marking on sides 1 and 2; 32-pole			Matrix patchboard; Dark gray frame; Gray/white modules; Vertical module marking on sides 1 and 2; 32-pole		
	Item No.	Pack. Unit		Item No.	Pack. Unit
Marking 1 ... 32	726-121	20	Marking 1 ... 32	726-221	20
Marking 33 ... 64	726-122	20	Marking 33 ... 64	726-222	20

Matrix patchboard; Dark gray frame; Blue modules; Vertical module marking on sides 1 and 2; 32-pole			Matrix patchboard; Dark gray frame; Blue modules; Vertical module marking on sides 1 and 2; 32-pole		
	Item No.	Pack. Unit		Item No.	Pack. Unit
Marking 1 ... 32	726-141 ②	20	Marking 1 ... 32	726-241 ②	20
Marking 33 ... 64	726-142 ②	20	Marking 33 ... 64	726-242 ②	20

Accessories; for Matrix Patchboards
Appropriate marking systems: WSB/WFB

Insulation stop; 0.08 ... 0.2 mm ² "s" (0.14 mm ² "f-st"); 4 x 3 pcs/strip	white	726-901	200 (25)	Insulation stop; 0.25 ... 0.5 mm ² "s+f-st"; 4 x 3 pcs/strip	dark gray	726-907	200 (25)
Insulation stop; 0.25 mm ² "s"; 0.14 ... 0.25 mm ² "f-st"; 4 x 3 pcs/strip	light gray	726-906	200 (25)	Wire commoning chain; insulated; 32 connections; I _n 6 A; max. 50 V; 0.5 mm ²	gray	709-107	1

- ① 500 V = rated voltage
6 kV = rated impulse voltage
3 = pollution degree
(see Section 14)
 - ② Suitable for Ex i applications
- See application notes for:
Insulation stop, page 523
- Approvals and corresponding ratings,
visit www.wago.com

Accessories; for Matrix Patchboards

Appropriate marking systems:
WSB/WFB

Test plug; with 500 mm cable; 2.3 mm Ø; max. 42 V	yellow	210-137	50
---	--------	---------	----

Group marker carrier for side 2

dark gray	726-902	50
-----------	---------	----

WFB continuous marking strip; 1000 mm long

transparent	210-612	10
-------------	---------	----

Carrier for WFB continuous marking strip; snaps into marker slot

gray	209-185	200 (25)
------	---------	----------

WSB marker card; white; 10 strips with 10 markers/card; for 5 ... 17.5 mm terminal block width

plain	209-501	5
-------	---------	---

WSB marker card; white; 10 strips with 10 markers/card; horizontal marking

1 ... 10 (10x)	209-502	5
----------------	---------	---

WSB marker card; white; 10 strips with 10 markers/card; horizontal marking

1 ... 50 (2x)	209-566	5
---------------	---------	---

WSB marker card; white; 10 strips with 10 markers/card; horizontal marking

X (100x)	209-500/209-035	5
----------	-----------------	---

Operating tool with a partially insulated shaft; Type 1; (2.5 x 0.4) mm blade

	210-719	1
--	---------	---

Sold & Serviced By:

 Toll Free Phone (877) SERV098
www.electromate.com
sales@electromate.com

Matrix Patchboard; 48-Pole 726 Series

Technical Data	
Side 1: 3x 0.08 ... 1.5 mm ²	28 ... 16 AWG
Side 2: 3x 0.08 ... 1.5 mm ²	28 ... 16 AWG
500 V/6 kV/3 ①	300 V, 10 A ②
I _N 10 A	300 V, 10 A ③
8 ... 10 mm / 0.31 ... 0.39 inch	

Technical Data	
Side 1: 3x 0.08 ... 1.5 mm ²	28 ... 16 AWG
Side 2: 2x 0.08 ... 2.5 mm ²	28 ... 14 AWG
500 V/6 kV/3 ①	300 V, 10 A ②
I _N 10 A	300 V, 10 A ③
8 ... 10 mm / 0.31 ... 0.39 inch	

- ① 500 V = rated voltage
6 kV = rated impulse voltage
3 = pollution degree
(see Section 14)
 - ② Suitable for Ex i applications
- See application notes for:
Insulation stop, page 523
- Approvals and corresponding ratings,
visit www.wago.com



Dimensions in mm

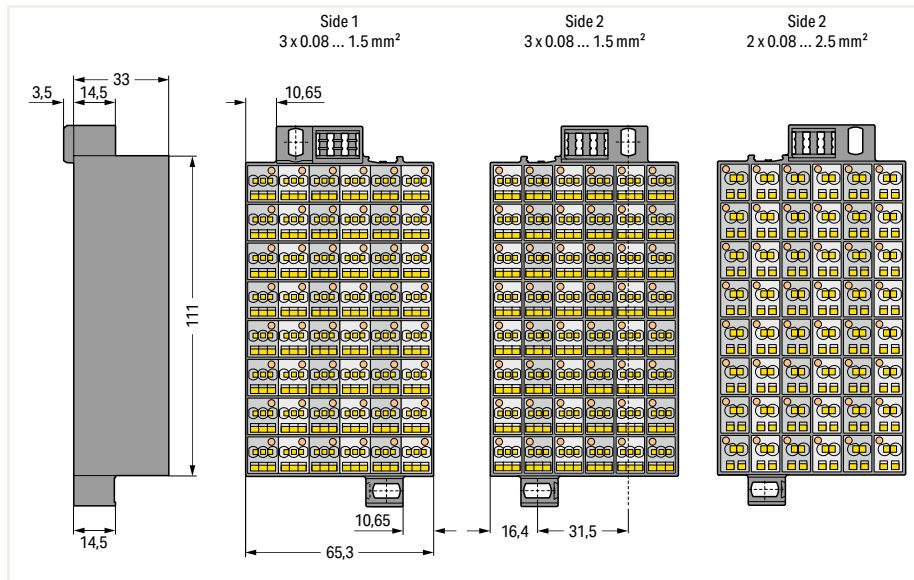

Matrix patchboard; Dark gray frame; Gray/white modules; Vertical module marking on sides 1 and 2; 48-pole

	Item No.	Pack. Unit
Marking 1 ... 48	726-421	10

Matrix patchboard; Gray/white modules; Module marking on dark gray frame; Vertical module marking on sides 1 and 2; 48-pole

	Item No.	Pack. Unit
Marking 1 ... 48	726-521	10

Matrix patchboard; Dark gray frame; Blue modules; Vertical module marking on sides 1 and 2; 48-pole

	Item No.	Pack. Unit
Marking 1 ... 48	726-441 ②	10

Matrix patchboard; Dark gray frame; Blue modules; Vertical module marking on sides 1 and 2; 48-pole

	Item No.	Pack. Unit
Marking 1 ... 48	726-541 ②	10

Accessories; for Matrix Patchboards

Appropriate marking systems: WSB/WFB

Insulation stop; 0.08 ... 0.2 mm² "s" (0.14 mm² "f-st"); 4 x 3 pcs/strip

	Item No.	Pack. Unit
white	726-901	200 (25)

Insulation stop; 0.25 mm² "s"; 0.14 ... 0.25 mm² "f-st"; 4 x 3 pcs/strip

	Item No.	Pack. Unit
light gray	726-906	200 (25)

Insulation stop; 0.25 ... 0.5 mm² "s+f-st"; 4 x 3 pcs/strip

	Item No.	Pack. Unit
dark gray	726-907	200 (25)

Wire commoning chain; insulated; 32 connections; I_N 6 A; max. 50 V; 0.5 mm²

	Item No.	Pack. Unit
gray	709-107	1

Test plug; with 500 mm cable; 2.3 mm Ø; max. 42 V

	Item No.	Pack. Unit
yellow	210-137	50

Group marker carrier for side 2

	Item No.	Pack. Unit
dark gray	726-902	50

Accessories; for Matrix Patchboards

Appropriate marking systems:
WSB/WFB

WFB continuous marking strip; 1000 mm long		
transparent	210-612	10

Carrier for WFB continuous marking strip; snaps into marker slot

gray	209-185	200 (25)

WSB marker card; white; 10 strips with 10 markers/card; for 5 ... 17.5 mm terminal block width

plain	209-501	5

WSB marker card; white; 10 strips with 10 markers/card; horizontal marking

1 ... 10 (10x)	209-502	5

WSB marker card; white; 10 strips with 10 markers/card; horizontal marking

1 ... 50 (2x)	209-566	5

WSB marker card; white; 10 strips with 10 markers/card; horizontal marking

X (100x)	209-500/209-035	5

Operating tool with a partially insulated shaft; Type 1; (2.5 x 0.4) mm blade

	210-719	1

Matrix Patchboard; 80-Pole 726 Series

Technical Data		Technical Data	
Side 1: 3x 0.08 ... 1.5 mm ²	28 ... 16 AWG	Side 1: 3x 0.08 ... 1.5 mm ²	28 ... 16 AWG
Side 2: 3x 0.08 ... 1.5 mm ²	28 ... 16 AWG	Side 2: 2x 0.08 ... 2.5 mm ²	28 ... 14 AWG
500 V/6 kV/3 ①	300 V, 10 A ②	500 V/6 kV/3 ①	300 V, 10 A ②
I _n 10 A	300 V, 10 A ②	I _n 10 A	300 V, 10 A ②
8 ... 10 mm / 0.31 ... 0.39 inch		8 ... 10 mm / 0.31 ... 0.39 inch	

- ① 500 V = rated voltage
6 kV = rated impulse voltage
3 = pollution degree
(see Section 14)
 - ② Suitable for Ex i applications
- See application notes for:
Insulation stop, page 523
- Approvals and corresponding ratings,
visit www.wago.com

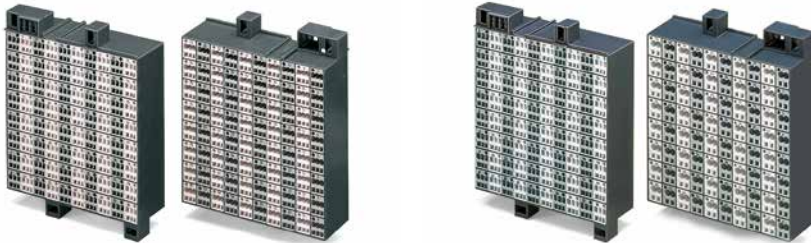

Dimensions in mm

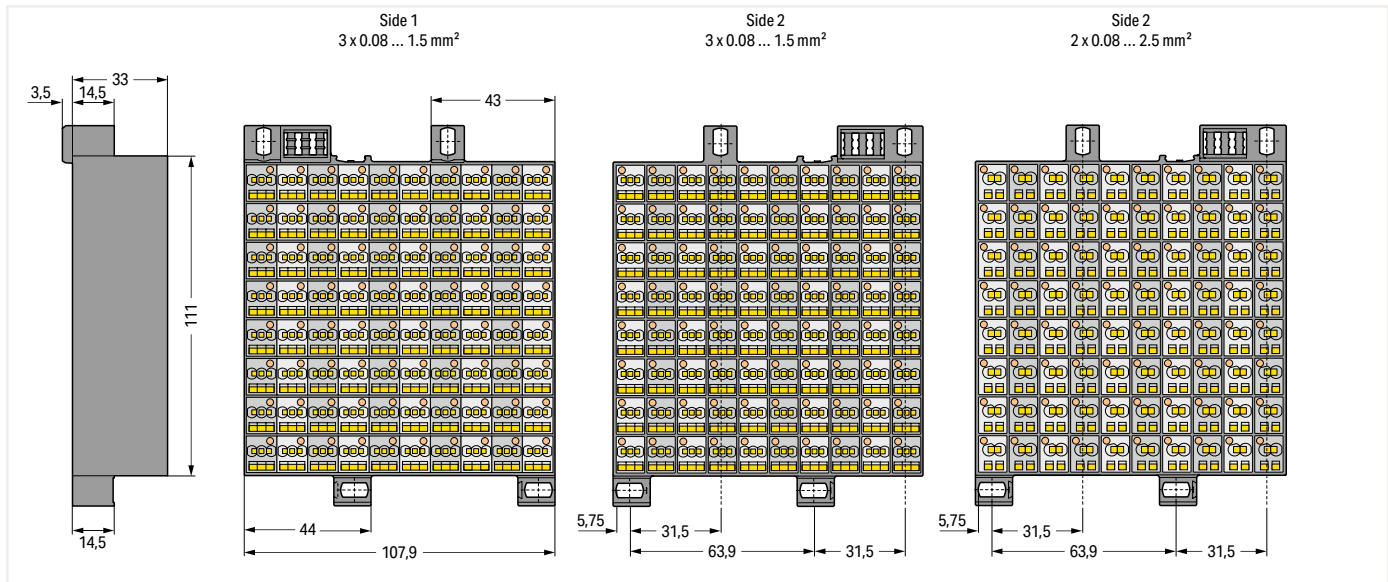

Matrix patchboard; Dark gray frame; Gray/white modules; Vertical module marking on sides 1 and 2; 48-pole

Marking 1 ... 80	Item No.	Pack. Unit
	726-721	8

Matrix patchboard; Dark gray frame; Gray/white modules; Vertical module marking on sides 1 and 2; 48-pole

Marking 1 ... 80	Item No.	Pack. Unit
	726-821	8

Accessories; for Matrix Patchboards
Appropriate marking systems:
WSB/WFB

WSB marker card; white; 10 strips with 10 markers/card; horizontal marking

1 ... 10 (10x)	209-502	5
----------------	---------	---

Matrix patchboard; Dark gray frame; Blue modules; Vertical module marking on sides 1 and 2; 48-pole

Marking 1 ... 80	Item No.	Pack. Unit
	726-741 ②	8

Matrix patchboard; Dark gray frame; Blue modules; Vertical module marking on sides 1 and 2; 48-pole

Marking 1 ... 80	Item No.	Pack. Unit
	726-841 ②	8

WSB marker card; white; 10 strips with 10 markers/card; horizontal marking

1 ... 50 (2x)	209-566	5
---------------	---------	---

Accessories; for Matrix Patchboards
Appropriate marking systems: WSB/WFB

Insulation stop; 0.08 ... 0.2 mm² "s" (0.14 mm² "f-st"); 4 x 3 pcs/strip

white	726-901	200 (25)
-------	---------	----------

WFB continuous marking strip; 1000 mm long

transparent	210-612	10
-------------	---------	----

Insulation stop; 0.25 mm² "s"; 0.14 ... 0.25 mm² "f-st"; 4 x 3 pcs/strip

light gray	726-906	200 (25)
------------	---------	----------

Carrier for WFB continuous marking strip; snaps into marker slot

gray	209-185	200 (25)
------	---------	----------

Insulation stop; 0.25 ... 0.5 mm² "s+f-st"; 4 x 3 pcs/strip

dark gray	726-907	200 (25)
-----------	---------	----------

WSB marker card; white; 10 strips with 10 markers/card; for 5 ... 17.5 mm terminal block width

plain	209-501	5
-------	---------	---

WSB marker card; white; 10 strips with 10 markers/card; horizontal marking

X (100x)	209-500/209-035	5
----------	-----------------	---

Operating tool with a partially insulated shaft; Type 1; (2.5 x 0.4) mm blade

	210-719	1
--	---------	---

11

Matrix Patchboard; Slimline Version; for 19" Racks; 32-Pole 726 Series

Technical Data		Technical Data	
Side 1: 3x 0.08 ... 1.5 mm ²	28 ... 16 AWG	Side 1: 3x 0.08 ... 1.5 mm ²	28 ... 16 AWG
Side 2: 3x 0.08 ... 1.5 mm ²	28 ... 16 AWG	Side 2: 2x 0.08 ... 2.5 mm ²	28 ... 14 AWG
500 V/6 kV/3 ①	300 V, 10 A ②	500 V/6 kV/3 ①	300 V, 10 A ②
I _n 10 A	300 V, 10 A ②	I _n 10 A	300 V, 10 A ②
8 ... 10 mm / 0.31 ... 0.39 inch		8 ... 10 mm / 0.31 ... 0.39 inch	



Dimensions in mm

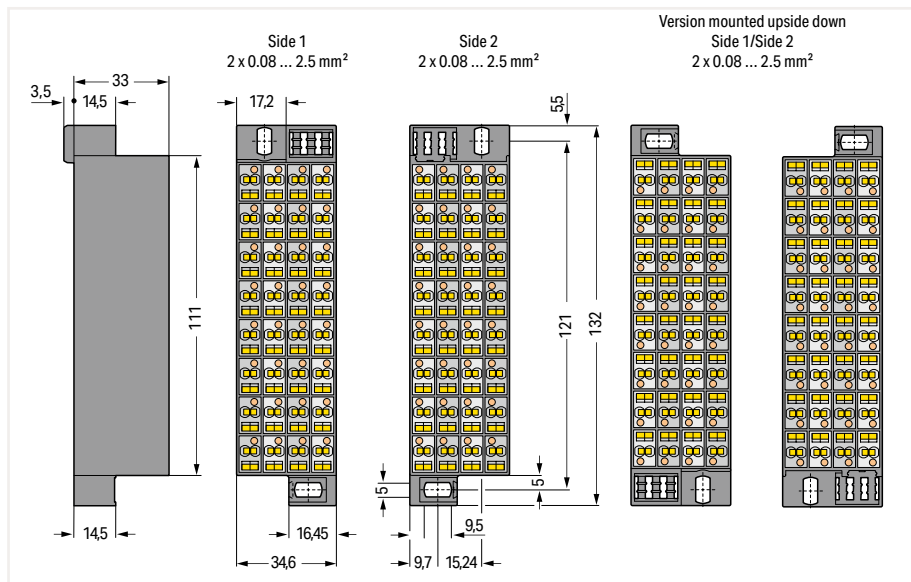

Matrix patchboard; Dark gray frame; Gray/white modules; Vertical module marking on sides 1 and 2; for 19" racks; Slimline version; 32-pole

	Item No.	Pack. Unit		Item No.	Pack. Unit
Marking 1 ... 32	726-321	24	Marking 1 ... 32	726-325	24
Marking 33 ... 64	726-322	24	Marking 33 ... 64	726-326	24

Matrix patchboard; Dark gray frame; Blue modules; Vertical module marking on sides 1 and 2; for 19" racks; Slimline version; 32-pole

	Item No.	Pack. Unit		Item No.	Pack. Unit
Marking 1 ... 32	726-341 ②	24	Marking 1 ... 32	726-345 ②	24
Marking 33 ... 64	726-342 ②	24	Marking 33 ... 64	726-346 ②	24

Accessories; for Matrix Patchboards

Appropriate marking systems: WSB/WFB

Insulation stop; 0.08 ... 0.2 mm ² "s" (0.14 mm ² "f-st"); 4 x 3 pcs/strip		Item No.	Pack. Unit
white		726-901	200 (25)
dark gray		726-907	200 (25)

Insulation stop; 0.25 mm ² "s"; 0.14 ... 0.25 mm ² "f-st"; 4 x 3 pcs/strip		Item No.	Pack. Unit
light gray		726-906	200 (25)

Test plug; with 500 mm cable; 2.3 mm Ø; max. 42 V		Item No.	Pack. Unit
yellow		210-137	50

- ① 500 V = rated voltage
6 kV = rated impulse voltage
3 = pollution degree (see Section 14)
 - ② Suitable for Ex i applications
- See application notes for: Insulation stop, page 523
- Approvals and corresponding ratings, visit www.wago.com

Accessories; for Matrix Patchboards

Appropriate marking systems: WSB/WFB

WFB continuous marking strip; 1000 mm long		Item No.	Pack. Unit
transparent		210-612	10

Carrier for WFB continuous marking strip; snaps into marker slot		Item No.	Pack. Unit
gray		209-185	200 (25)

WSB marker card; white; 10 strips with 10 markers/card; for 5 ... 17.5 mm terminal block width		Item No.	Pack. Unit
plain		209-501	5

WSB marker card; white; 10 strips with 10 markers/card; horizontal marking		Item No.	Pack. Unit
1 ... 10 (10x)		209-502	5

WSB marker card; white; 10 strips with 10 markers/card; horizontal marking		Item No.	Pack. Unit
1 ... 50 (2x)		209-566	5

WSB marker card; white; 10 strips with 10 markers/card; horizontal marking		Item No.	Pack. Unit
X (100x)		209-500/209-035	5

Operating tool with a partially insulated shaft; Type 1; (2.5 x 0.4) mm blade		Item No.	Pack. Unit
		210-719	1

Common Potential Matrix Patchboard; Slimline Version; for 19" Racks

726 Series

Technical Data

Side 1: I_N 24 A
 24x 2x 0.08 ... 2.5 mm² | 28 ... 14 AWG
 8 ... 10 mm / 0.31 ... 0.39 inch

Side 2: I_N 76 A
 1x or 2x 0.5 ... 16 (25 "f-st") mm² | 20 ... 4 AWG
 18 ... 20 mm / 0.71 ... 0.79 inch

Technical Data

Side 1: I_N 24 A
 24x 2x 0.08 ... 2.5 mm² | 28 ... 14 AWG
 8 ... 10 mm / 0.31 ... 0.39 inch

Side 2: I_N 76 A
 1x or 2x 0.5 ... 16 (25 "f-st") mm² | 20 ... 4 AWG
 18 ... 20 mm / 0.71 ... 0.79 inch

Technical Data

Side 1:
 24x 2x 0.08 ... 2.5 mm² | 28 ... 14 AWG
 8 ... 10 mm / 0.31 ... 0.39 inch

Side 2:
 1x or 2x 0.5 ... 16 (25 "f-st") mm² | 20 ... 4 AWG
 18 ... 20 mm / 0.71 ... 0.79 inch

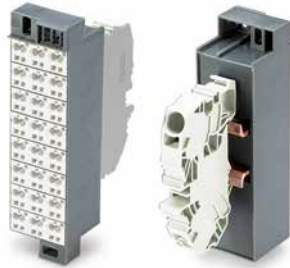

Dimensions in mm

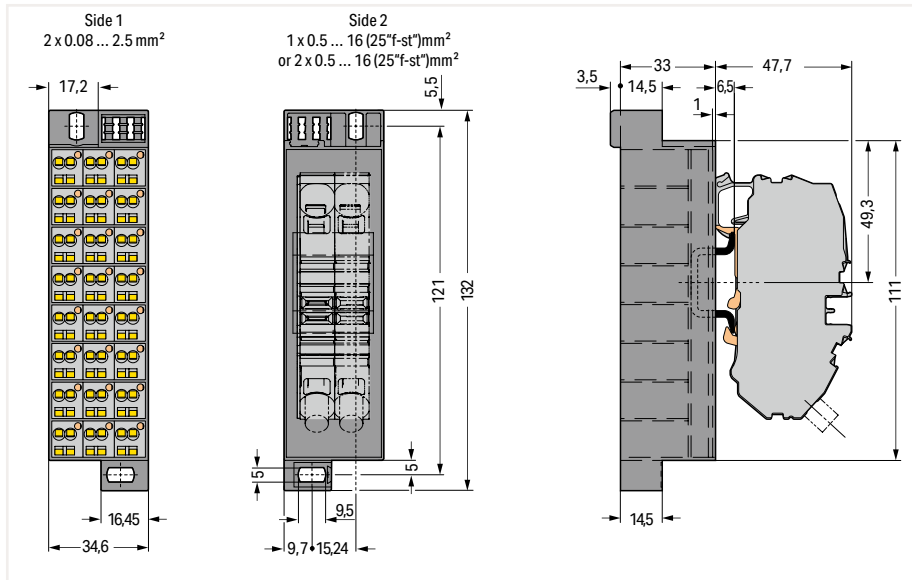

Common potential matrix patchboard; Dark gray frame; Marking 1 ... 24; Gray modules; Vertical module marking; with one supply terminal block incl. end plate; for 19" racks; Slimline version

	Item No.	Pack. Unit
	726-601	10

Common potential matrix patchboard; Dark gray frame; Marking 1 ... 24; White modules; Vertical module marking; with one supply terminal block incl. end plate; for 19" racks; Slimline version

	Item No.	Pack. Unit
	726-611	10

Common potential matrix patchboard; Dark gray frame; Marking 1 ... 24; Green-yellow modules; Vertical module marking; with one supply terminal block incl. end plate; for 19" racks; Slimline version

	Item No.	Pack. Unit
	726-621	10

Common potential matrix patchboard; Dark gray frame; Marking 1 ... 24; Gray modules; Vertical module marking; with two supply terminal blocks incl. end plate; for 19" racks; Slimline version

	726-602	10
--	---------	----

Common potential matrix patchboard; Dark gray frame; Marking 1 ... 24; White modules; Vertical module marking; with two supply terminal blocks incl. end plate; for 19" racks; Slimline version

	726-612	10
--	---------	----

Common potential matrix patchboard; Dark gray frame; Marking 1 ... 24; Green-yellow modules; Vertical module marking; with two supply terminal blocks incl. end plate; for 19" racks; Slimline version

	726-622	10
--	---------	----

Accessories; item-specific
 Spare supply terminal block; only for use with common potential matrix patchboards (726Series); 16 mm²; 12 mm wide

gray	2016-7611	20
------	-----------	----



Accessories; item-specific
 Spare supply terminal block; only for use with common potential matrix patchboards (726Series); 16 mm²; 12 mm wide

white	2016-7608	20
-------	-----------	----



Accessories; item-specific
 Ground supply terminal block; 2-conductor ground terminal block; 16 mm²; 12 mm wide

green-yellow	2016-7607	20
--------------	-----------	----



End and intermediate plate; 1 mm thick

gray	2016-7691	100 (25)
------	-----------	----------



End and intermediate plate; 1 mm thick

gray	2016-7691	100 (25)
------	-----------	----------



End and intermediate plate; 1 mm thick

gray	2016-7691	100 (25)
------	-----------	----------



Operating tool with a partially insulated shaft; Type 3; (5.5 x 0.8) mm blade

	210-721	1
--	---------	---



Operating tool with a partially insulated shaft; Type 3; (5.5 x 0.8) mm blade

	210-721	1
--	---------	---



Operating tool with a partially insulated shaft; Type 3; (5.5 x 0.8) mm blade

	210-721	1
--	---------	---



11

Technical Data

Side 1: I_N 24 A
 24x 2x 0.08 ... 2.5 mm² | 28 ... 14 AWG
 8 ... 10 mm / 0.31 ... 0.39 inch
 Side 2: I_N 76 A
 1x or 2x 0.5 ... 16 (25 "f-st") mm² | 20 ... 4 AWG
 18 ... 20 mm / 0.71 ... 0.79 inch

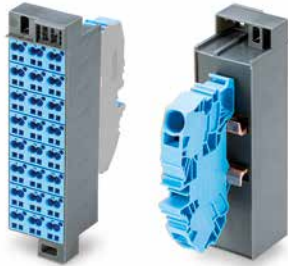

1 Suitable for Ex i applications

See application notes for:
 Insulation stop, page 523

Approvals and corresponding ratings,
 visit www.wago.com

Accessories; for Common Potential Matrix Patchboards

Appropriate marking systems:
 WSB/WFB

Insulation stop; 0.08 ... 0.2 mm² "s"; (0.14 mm² "f-st");
 4 x 3 pcs/strip

white	726-901	200 (25)
-------	---------	----------

Insulation stop; 0.25 mm² "s"; 0.14 ... 0.25 mm² "f-st";
 4 x 3 pcs/strip

light gray	726-906	200 (25)
------------	---------	----------

Insulation stop; 0.25 ... 0.5 mm² "s+f-st"; 4 x 3 pcs/strip

dark gray	726-907	200 (25)
-----------	---------	----------

Wire commoning chain; insulated; 32 connections; I_N 6 A;
 max. 50 V; 0.5 mm²

gray	709-107	1
------	---------	---

Test plug; with 500 mm cable; 2.3 mm Ø; max. 42 V

yellow	210-137	50
--------	---------	----

Group marker carrier for side 2

dark gray	726-902	50
-----------	---------	----

WFB continuous marking strip; 1000 mm long

transparent	210-612	10
-------------	---------	----

Carrier for WFB continuous marking strip; snaps into
 marker slot

gray	209-185	200 (25)
------	---------	----------

WSB marker card; white; 10 strips with 10 markers/card;
 for 5 ... 17.5 mm terminal block width

plain	209-501	5
-------	---------	---

WSB marker card; white; 10 strips with 10 markers/card;
 horizontal marking

1 ... 10 (10x)	209-502	5
----------------	---------	---

WSB marker card; white; 10 strips with 10 markers/card;
 horizontal marking

1 ... 50 (2x)	209-566	5
---------------	---------	---

WSB marker card; white; 10 strips with 10 markers/card;
 horizontal marking

X (100x)	209-500/209-035	5
----------	-----------------	---

Accessories; for Common Potential Matrix Patchboards

Appropriate marking systems:
 WMB/WMB Inline/WFB

WMB Inline; plain; 1,500 WMB markers (5 mm)/reel;
 stretchable 5 ... 5.2 mm

white	2009-115	1
-------	----------	---

WMB marker card; white; 10 strips with 10 markers/card;
 stretchable 5 ... 5.2 mm

plain	793-5501	5
-------	----------	---

WMB marker card; plain; 10 strips with 10 markers/card;
 stretchable 5 ... 5.2 mm

yellow	793-5501/000-002	5
red	793-5501/000-005	5
blue	793-5501/000-006	5
gray	793-5501/000-007	5
orange	793-5501/000-012	5
light green	793-5501/000-017	5
green	793-5501/000-023	5
violet	793-5501/000-024	5

Operating tool with a partially insulated shaft; Type 1; (2.5
 x 0.4) mm blade

	210-719	1
--	---------	---

Common potential matrix patchboard; Dark gray frame;
 Marking 1 ... 24; Blue modules; Vertical module marking;
 with one supply terminal block incl. end plate; for 19"
 racks; Slimline version

Item No.	Pack. Unit
726-631 1	10

Common potential matrix patchboard; Dark gray frame;
 Marking 1 ... 24; Blue modules; Vertical module marking;
 with two supply terminal blocks incl. end plate; for 19"
 racks; Slimline version

726-632 1	10
------------------	----

Accessories; item-specific

Spare supply terminal block; 2-conductor supply
 terminal block for distribution boxes; only for use with
 common potential matrix patchboards (726Series);
 16 mm²; 12 mm wide

blue	2016-7614	20
------	-----------	----

End and intermediate plate; 1 mm thick

gray	2016-7691	100 (25)
------	-----------	----------

PUSH-IN CAGE CLAMP® CAGE CLAMP®

Common Potential Matrix Patchboard; Slimline Version; for 19" Racks; Supply Side/Patchboard Side

726 Series

Technical Data

Side 1: I _N 76 A	
1x or 2x 0.5 ... 16 (25 "f-st") mm ²	20 ... 4 AWG
18 ... 20 mm / 0.71 ... 0.79 inch	
Side 2: I _N 24 A	
24x 2x 0.08 ... 2.5 mm ²	28 ... 14 AWG
8 ... 10 mm / 0.31 ... 0.39 inch	



Technical Data

Side 1: I _N 76 A	
1x or 2x 0.5 ... 16 (25 "f-st") mm ²	20 ... 4 AWG
18 ... 20 mm / 0.71 ... 0.79 inch	
Side 2: I _N 24 A	
24x 2x 0.08 ... 2.5 mm ²	28 ... 14 AWG
8 ... 10 mm / 0.31 ... 0.39 inch	

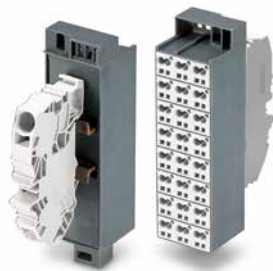

Technical Data

Side 1:	
1x or 2x 0.5 ... 16 (25 "f-st") mm ²	20 ... 4 AWG
18 ... 20 mm / 0.71 ... 0.79 inch	
Side 2:	
24x 2x 0.08 ... 2.5 mm ²	28 ... 14 AWG
8 ... 10 mm / 0.31 ... 0.39 inch	



Dimensions in mm

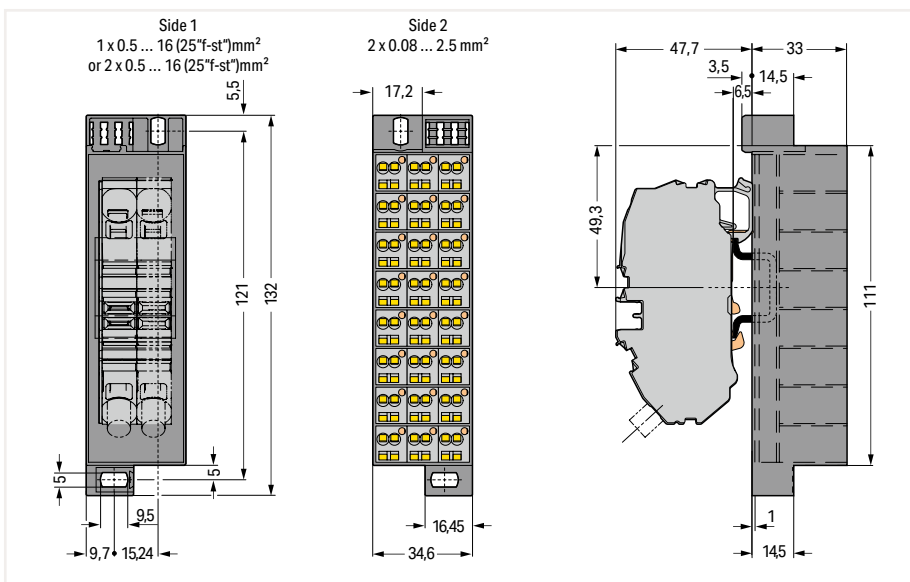

Common potential matrix patchboard; Dark gray frame; with one supply terminal block incl. end plate; Marking 1 ... 24; Gray modules; Vertical module marking; ; for 19" racks; Slimline version

Item No.	Pack. Unit
726-651	10

Common potential matrix patchboard; Dark gray frame; with one supply terminal block incl. end plate; Marking 1 ... 24; White modules; Vertical module marking; ; for 19" racks; Slimline version

Item No.	Pack. Unit
726-661	10

Common potential matrix patchboard; Dark gray frame; with one supply terminal block incl. end plate; Marking 1 ... 24; Green-yellow modules; Vertical module marking; ; for 19" racks; Slimline version

Item No.	Pack. Unit
726-671	10

Common potential matrix patchboard; Dark gray frame; with two supply terminal blocks incl. end plate; Marking 1 ... 24; Gray modules; Vertical module marking; for 19" racks; Slimline version

726-652	10
---------	----

Common Potential Matrix Patchboard; Dark gray frame; with two supply terminal blocks incl. end plate; Marking 1 ... 24; White modules; Vertical module marking; for 19" racks; Slimline version

726-662	10
---------	----

Common potential matrix patchboard; Dark gray frame; with two supply terminal blocks incl. end plate; Marking 1 ... 24; Green-yellow modules; Vertical module marking; for 19" racks; Slimline version

726-672	10
---------	----

Accessories; item-specific

Spare supply terminal block; only for use with common potential matrix patchboards (726Series); 16 mm²; 12 mm wide

gray	2016-7611	20
------	-----------	----

End and intermediate plate; 1 mm thick

gray	2016-7691	100 (25)
------	-----------	----------

Operating tool with a partially insulated shaft; Type 3; (5.5 x 0.8) mm blade

210-721	1
---------	---

Accessories; item-specific

Spare supply terminal block; only for use with common potential matrix patchboards (726Series); 16 mm²; 12 mm wide

white	2016-7608	20
-------	-----------	----

End and intermediate plate; 1 mm thick

gray	2016-7691	100 (25)
------	-----------	----------

Operating tool with a partially insulated shaft; Type 3; (5.5 x 0.8) mm blade

210-721	1
---------	---

Accessories; item-specific

Ground supply terminal block; 2-conductor ground terminal block; 16 mm²; 12 mm wide

green-yellow	2016-7607	20
--------------	-----------	----

End and intermediate plate; 1 mm thick

gray	2016-7691	100 (25)
------	-----------	----------

Operating tool with a partially insulated shaft; Type 3; (5.5 x 0.8) mm blade

210-721	1
---------	---

11

Matrix Patchboard; with Push-Buttons; Slimline Version; for 19" Racks; 32-Pole 726 Series

Technical Data

Side 1: 32x 0.2 ... 1.5 mm ² ❶	24 ... 16 AWG
Side 2: 32x 0.2 ... 1.5 mm ² ❶	24 ... 16 AWG
800 V/8 kV/3 ❷	300 V, 10 A ❸
I _N 10 A	300 V, 10 A ❸
10 mm / 0.39 inch	



Technical Data

Side 1: 32x 0.2 ... 1.5 mm ² ❶	24 ... 16 AWG
Side 2: 32x 0.2 ... 1.5 mm ² ❶	24 ... 16 AWG
800 V/8 kV/3 ❷	300 V, 10 A ❸
I _N 10 A	300 V, 10 A ❸
10 mm / 0.39 inch	



- ❶ Conductor range: 0.2 ... 1.5 mm² "s+f-st" and 0.25 ... 1 mm² "insulated ferrules; 10 mm"
 - ❷ 800 V = rated voltage
8 kV = rated impulse voltage
3 = pollution degree (see Section 14)
 - ❸ Suitable for Ex i applications
- See application notes for:
Marking, from page 588
- Approvals and corresponding ratings,
visit www.wago.com

Accessories; for Matrix Patchboards

Appropriate marking systems:
WMB/WMB Inline/WFB

WMB marker card; plain; 10 strips with 10 markers/card; stretchable 5 ... 5.2 mm

	yellow	793-5501/000-002	5
	red	793-5501/000-005	5
	blue	793-5501/000-006	5
	gray	793-5501/000-007	5
	orange	793-5501/000-012	5
	light green	793-5501/000-017	5
	green	793-5501/000-023	5
	violet	793-5501/000-024	5

Operating tool with a partially insulated shaft; Type 1; (2.5 x 0.4) mm blade



210-719 1

Test probe; 2 mm Ø; min. 12 mm lon; uninsulated tip; not offered by WAGO (e.g., MultiContact XPP-80/2-16)

Dimensions in mm

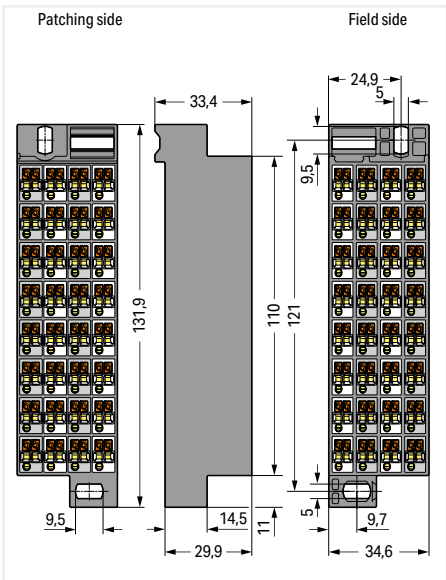

Matrix patchboard; Dark gray frame; Gray/white modules; for 19" racks; Slimline version; 32-pole

	Item No.	Pack. Unit
plain	726-770	30

Matrix patchboard; Dark gray frame; Gray/white modules; Vertical module marking on sides 1 and 2; for 19" racks; Slimline version; 32-pole

Marking 1 ... 32	726-771	30
------------------	---------	----

Matrix patchboard; Dark gray frame; White/gray modules; for 19" racks; Slimline version; 32-pole

plain	726-780	30
-------	---------	----

Dimensions in mm

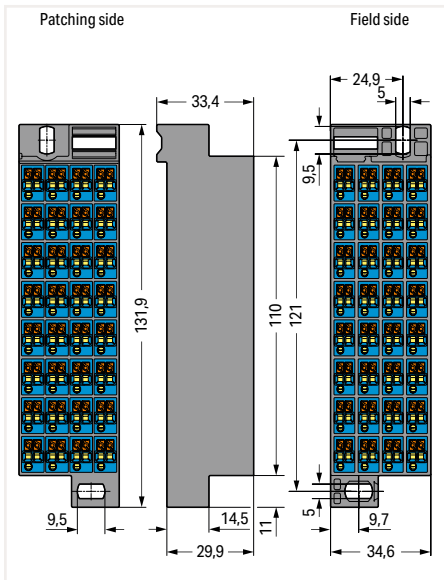

Matrix patchboard; Dark gray frame; Blue modules; for 19" racks; Slimline version; 32-pole

plain	726-800 ❸	30
-------	-----------	----

Matrix patchboard; Dark gray frame; Blue modules; Vertical module marking on sides 1 and 2; for 19" racks; Slimline version; 32-pole

Marking 1 ... 32	726-801 ❸	30
------------------	-----------	----

Accessories; for Matrix Patchboards

Appropriate marking systems: WMB/WMB Inline/WFB

Wire commoning chain; insulated; 32 connections; I_N 6 A; max. 50 V; 0.5 mm²

	gray	709-107	1
--	------	---------	---

WMB marker card; white; 10 strips with 10 markers/card; stretchable 5 ... 5.2 mm

	plain	793-5501	5
--	-------	----------	---

WMB Inline; plain; 1,500 WMB markers (5 mm)/reel; stretchable 5 ... 5.2 mm

	white	2009-115	1
--	-------	----------	---

Additional Module for Matrix Patchboards 726 Series

Technical Data	
0.08 ... 4 mm ²	28 ... 14 AWG
0.08 ... 2.5 mm ²	28 ... 14 AWG
500 V/6 kV/3 ①	300 V, 10 A ②
I _N 10 A	
9 mm / 0.35 inch	

- ① 500 V = rated voltage
6 kV = rated impulse voltage
3 = pollution degree
(see Section 14)
 - ② Suitable for Ex i applications
- See application notes for:
Insulation stop, page 523
- Approvals and corresponding ratings,
visit www.wago.com



Dimensions in mm

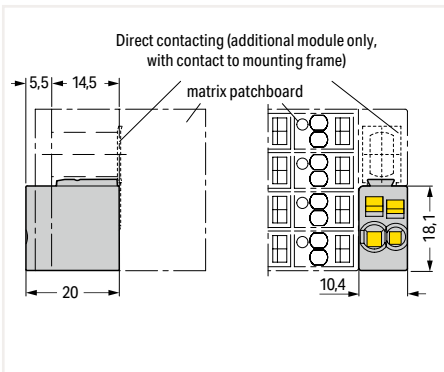

Snapping on an additional module with contact to mounting frame.

Additional module for matrix patchboard; for snap-on mounting to the lower mounting adapter; with CAGE CLAMP®; Additional module with contact to the mounting frame

Color	Item No.	Pack. Unit
○ white	726-903	25

Additional module for matrix patchboards; snaps onto the lower mounting adapter; with CAGE CLAMP®; insulated

○ gray	726-904	25
--------	---------	----



Assembling a matrix patchboard with additional module – direct connection to the mounting frame.

Insulation Stop; for Matrix Patchboard 726 Series

Suitable for patchboard side (side 1) of 1.5 mm² matrix patchboards (front side differs from back side)



Insulation stop; 0.08 ... 0.2 mm² "s" (0.14 mm² "f-st");
4 x 3 pcs/strip

Color	Item No.	Pack. Unit
○ white	726-901	200 (25)

Insulation stop; 0.25 mm² "s"; 0.14 ... 0.25 mm² "f-st";
4 x 3 pcs/strip

○ gray	726-906	200 (25)
--------	---------	----------

Insulation stop; 0.25 ... 0.5 mm² "s+f-st"; 4 x 3 pcs/strip

● dark gray	726-907	200 (25)
-------------	---------	----------



Inserting an insulation stop into conductor entry holes of matrix patchboards.



Mounted insulation stop

Terminal Blocks for Matrix Patching and Common Potential Terminal Blocks

727 Series

Description and Installation



Snap individual 4- or 8-level terminal blocks onto the DIN-rail.

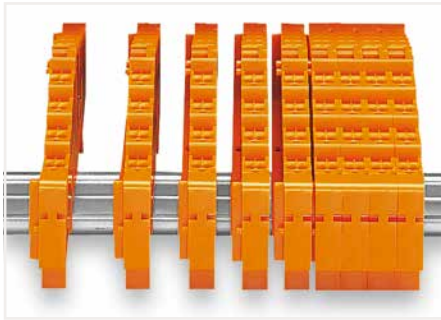

Slide terminal blocks together.

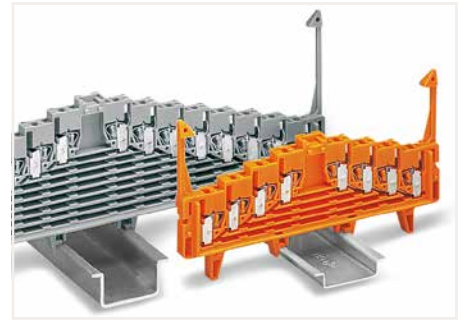

Terminal blocks for DIN-35 x 7.5 mm or DIN-35 x 15 mm rails are available.



Grip end plate at both sides and:

- push down (assembly)
- pull up (removal)



Open the assembly by laterally sliding a block via operating tool (2.5 x 0.4 mm blade).

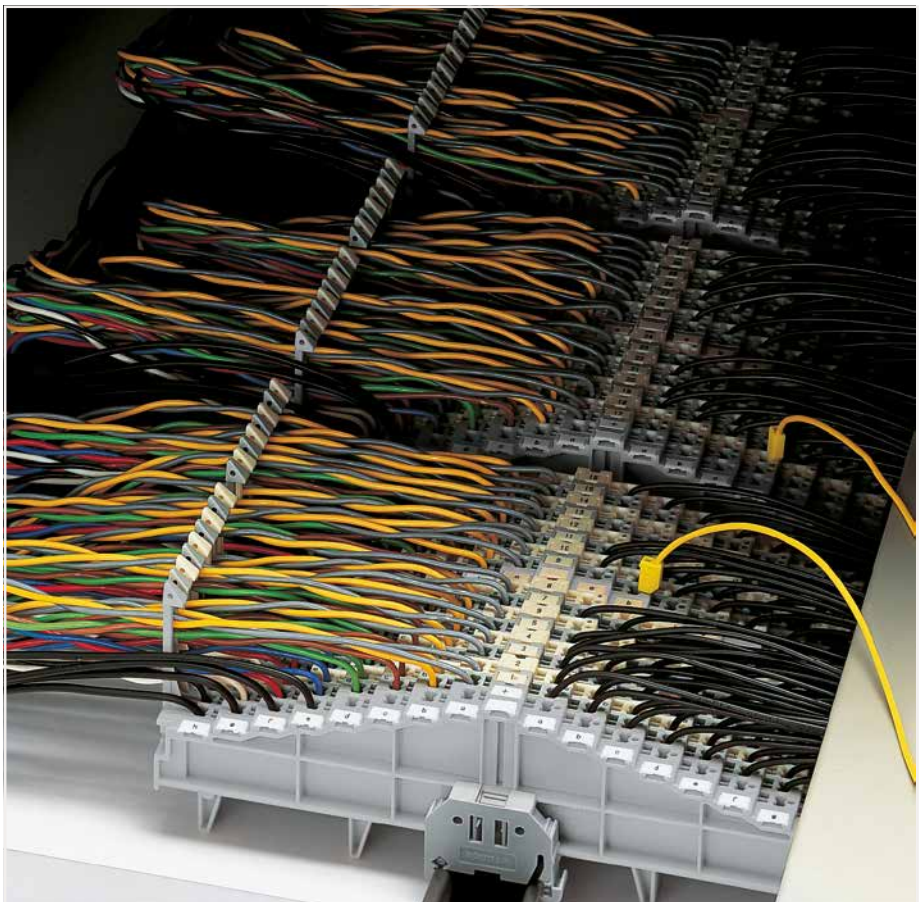

11



Slide terminal block and remove from the rail with a levering action.

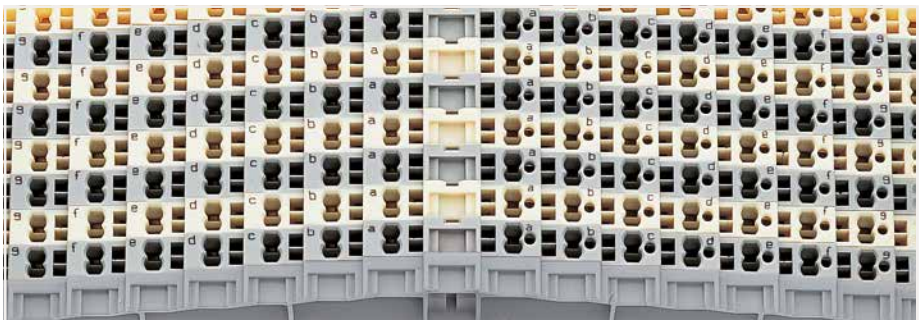

Connection points identified via factory-direct printing



CAGE CLAMP® terminates the following copper conductors: solid



stranded



fine-stranded, also with tinned single strands

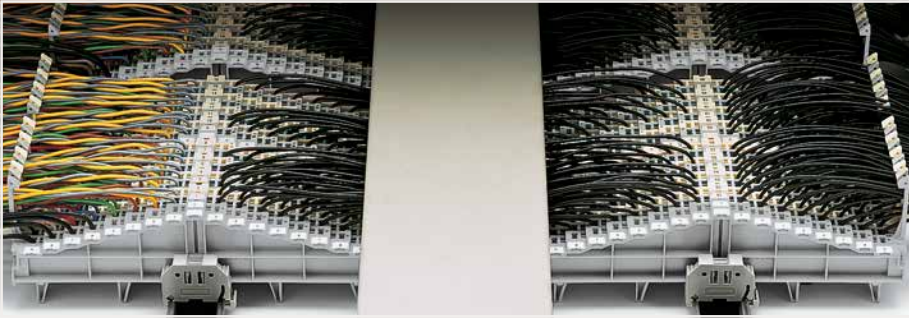

Example:
 Left: Main cables fed through locking clips on the field side
 Right: Control cables fed between locking clips
 Center: Wiring of both patching sides



Using terminal blocks with locking clips, the wiring space between the terminal strips can be covered with a wiring duct cover.

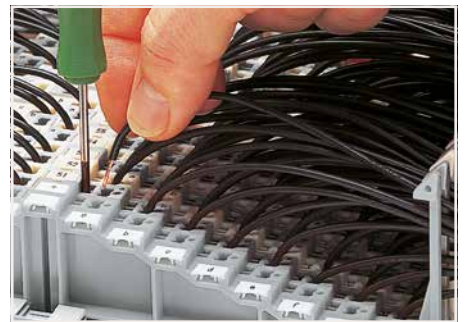
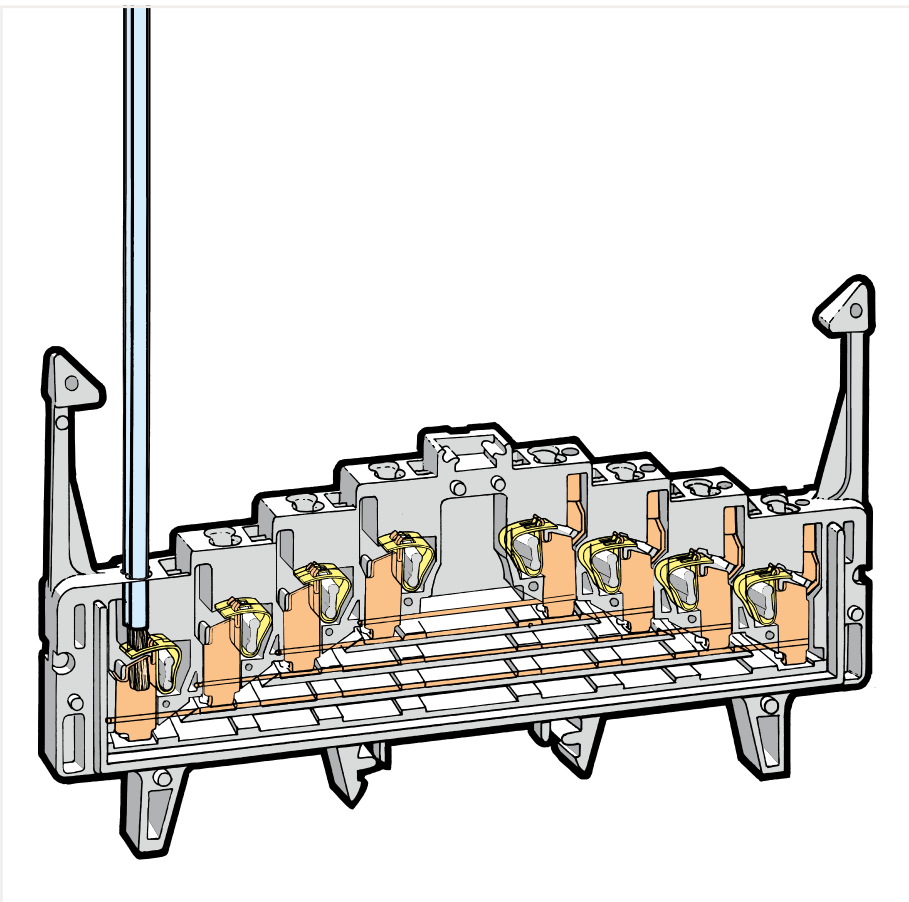

CAGE CLAMP® connection
 Inserting a conductor via 210-719 Operating Tool (2.5 x 0.4 mm blade).
 Max. cross section for uninsulated ferrules 1 mm² (18 AWG), for insulated ferrules 0.75 mm² (20 AWG)



Special test contact for 2.3 mm Ø test plug

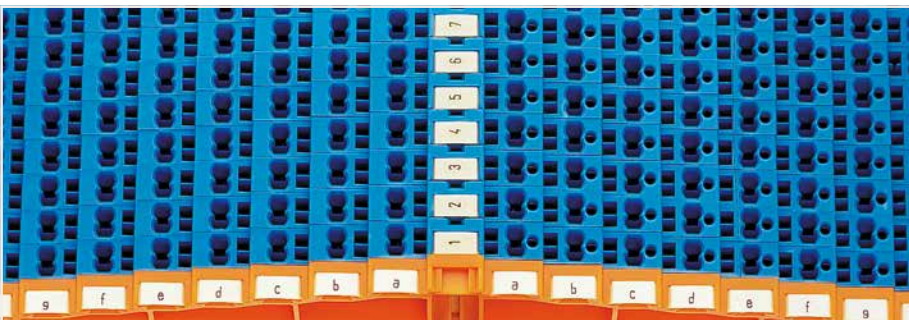

Marking coordinates via WMB Multi Marking System.

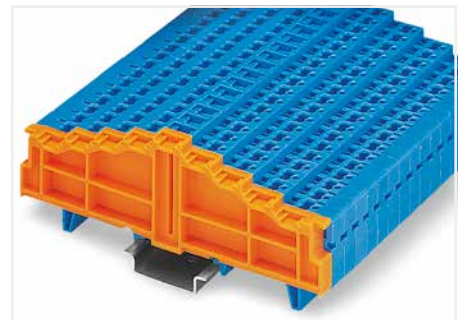

Blue terminal blocks for matrix patching are suitable for Ex i applications.



fine-stranded, tip-bonded



fine-stranded, with ferrule (gastight crimped)



fine-stranded, with pin terminal (gastight crimped)

4-Level Terminal Block for Matrix Patching 1.5 mm²; 727 Series

Technical Data

0.08 ... 1.5 mm ²	28 ... 16 AWG
250 V/4 kV/3 ①	300 V, 10 A ②
I _N 12 A	300 V, 10 A ③
Terminal block width: 7.62 mm / 0.3 inch	
8 ... 10 mm / 0.31 ... 0.39 inch	

Technical Data

0.08 ... 1.5 mm ²	28 ... 16 AWG
250 V/4 kV/3 ①	300 V, 10 A ②
I _N 12 A	300 V, 10 A ③
Terminal block width: 7.62 mm / 0.3 inch	
8 ... 10 mm / 0.31 ... 0.39 inch	

- ① 250 V = rated voltage
4 kV = rated impulse voltage
3 = pollution degree
(see Section 14)
- ② Terminal blocks with a blue insulated housing are suitable for Ex i applications.
60 V = peak value ^ (table 4, EN 60079-11 when approved by the manufacturer's authorized inspection representative)

See application notes for:
Wire harness support, page 530
Marking, from page 588

Approvals and corresponding ratings,
visit www.wago.com

Accessories; 727 Series

Appropriate marking systems:
WMB

Step-down test plug; from 4 mm socket to 2 mm plug;
max. 42 V

red	210-297	100 (25)
-----	---------	----------



Wire harness support

gray	249-109	50
------	---------	----



Double marker carrier; for center I/O module marking; for
WSB and WMB marking systems; 4 mm wide

gray	209-128	200 (100)
------	---------	-----------



Screwless end stop; for DIN-35 rail; 6 mm wide

gray	249-116	100 (25)
------	---------	----------



Screwless end stop; for DIN-35 rail; 10 mm wide

gray	249-117	50 (25)
------	---------	---------



Operating tool with a partially insulated shaft; Type 1; (2.5
x 0.4) mm blade

	210-719	1
--	---------	---

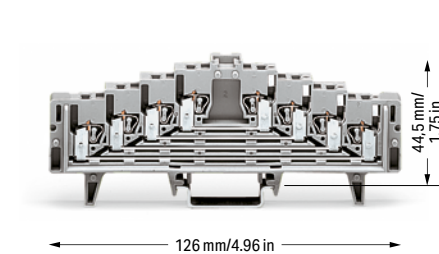

4-level terminal block for matrix patching; with locking
clips; no marking; 4 x pairs of clamping units on the same
level; for DIN 35 x 7.5 rail

Color	Item No.	Pack. Unit
gray	727-219	50
white	727-221	50
blue	727-223 ②	50

4-level terminal block for matrix patching; without locking
clips; no marking; 4 x pairs of clamping units on the same
level; for DIN 35 x 7.5 rail

Color	Item No.	Pack. Unit
gray	727-220	50
white	727-222	50
blue	727-224 ②	50

4-level terminal block for matrix patching; with locking
clips; no marking; 4 x pairs of clamping units on the same
level; for DIN 35 x 15 rail

gray	727-229	50
white	727-231	50
blue	727-233 ②	50

4-level terminal block for matrix patching; without locking
clips; no marking; 4 x pairs of clamping units on the same
level; for DIN 35 x 15 rail

gray	727-230	50
white	727-232	50
blue	727-234 ②	50

Item no. suffixes for terminal blocks with marking:

0-1-2-3--3-2-1-0	.../021-000
a-b-c-d--d-c-b-a	.../022-000
3-2-1-0--0-1-2-3	.../023-000
d-c-b-a--a-b-c-d	.../024-000

Other terminal blocks with the same profile:

0-1-2-3--3-2-1-0	.../021-000
a-b-c-d--d-c-b-a	.../022-000
3-2-1-0--0-1-2-3	.../023-000
d-c-b-a--a-b-c-d	.../024-000

Accessories; 727 Series

Appropriate marking system: WMB

4-level end plate; no marking; 7.62 mm thick

orange	727-217	25
gray	727-213	25

4-level end plate; Marking: 0-1-2-3--3-2-1-0; 7.62 mm
thick

orange	727-205	25
gray	727-255	25

4-level end plate; Marking: a-b-c-d--d-c-b-a; 7.62 mm
thick

orange	727-206	25
gray	727-256	25

4-level end plate; Marking: 3-2-1-0--0-1-2-3; 7.62 mm
thick

orange	727-207	25
gray	727-257	25

4-level end plate; Marking: d-c-b-a--a-b-c-d; 7.62 mm
thick

orange	727-208	25
gray	727-258	25

Insulation stop; 0.08 ... 0.2 mm² "s" (0.14 mm² "f-st"); 8
pcs/strip

white	727-197	200 (25)
-------	---------	----------

Insulation stop; 0.25 mm² "s"; 0.14 ... 0.25 mm² "f-st"; 8
pcs/strip

light gray	727-198	200 (25)
------------	---------	----------

Insulation stop; 0.25 ... 0.5 mm² "s+f-st"; 8 pcs/strip

dark gray	727-199	200 (25)
-----------	---------	----------

Wire commoning chain; insulated; 32 connections; I_N 6 A;
max. 50 V; 0.5 mm²

gray	709-107	1
------	---------	---

Test plug; with 500 mm cable; 2.3 mm Ø; max. 42 V

yellow	210-137	50
--------	---------	----

4-Level Common Potential Terminal Block

1.5 mm²; 727 Series

Technical Data	
0.08 ... 1.5 mm ²	28 ... 16 AWG
250 V/4 kV/3 ①	300 V, 10 A ②
I _N 18 A	300 V, 10 A ③
Terminal block width: 7.62 mm / 0.3 inch	
8 ... 10 mm / 0.31 ... 0.39 inch	

Technical Data	
0.08 ... 1.5 mm ²	28 ... 16 AWG
250 V/4 kV/3 ①	300 V, 10 A ②
I _N 18 A	300 V, 10 A ③
Terminal block width: 7.62 mm / 0.3 inch	
8 ... 10 mm / 0.31 ... 0.39 inch	

① 250 V = rated voltage
4 kV = rated impulse voltage
3 = pollution degree
(see Section 14)

See application notes for:
Wire harness support, page 530
Marking, from page 588

Approvals and corresponding ratings,
visit www.wago.com

Accessories; 727 Series
Appropriate marking systems:
WMB

Double marker carrier; for center I/O module marking; for WSB and WMB marking systems; 4 mm wide

gray	209-128	200 (100)
------	---------	-----------

Screwless end stop; for DIN-35 rail; 6 mm wide

gray	249-116	100 (25)
------	---------	----------

Screwless end stop; for DIN-35 rail; 10 mm wide

gray	249-117	50 (25)
------	---------	---------

Operating tool with a partially insulated shaft; Type 1; (2.5 x 0.4) mm blade

	210-719	1
--	---------	---

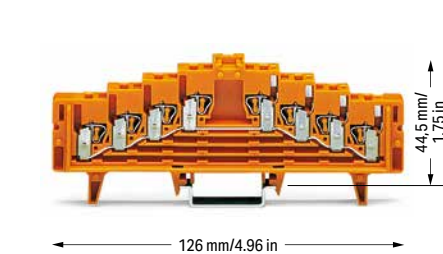

4-level common potential terminal block; with locking clips; no marking; all clamping units connected to the same current bar; for DIN 35 x 7.5 rail

Color	Item No.	Pack. Unit
orange	727-225	50
light gray	727-227	50

4-level terminal block for matrix patching; without locking clips; no marking; all clamping units connected to the same current bar; for DIN 35 x 7.5 rail

Color	Item No.	Pack. Unit
orange	727-226	50
light gray	727-228	50

4-level common potential terminal block; with locking clips; no marking; all clamping units connected to the same current bar; for DIN 35 x 15 rail

orange	727-235	50
light gray	727-237	50

4-level terminal block for matrix patching; without locking clips; no marking; all clamping units connected to the same current bar; for DIN 35 x 15 rail

orange	727-236	50
light gray	727-238	50

Item no. suffixes for terminal blocks with marking:

0-1-2-3--3-2-1-0	.../021-000
a-b-c-d--d-c-b-a	.../022-000
3-2-1-0--0-1-2-3	.../023-000
d-c-b-a--a-b-c-d	.../024-000

Other terminal blocks with the same profile:

0-1-2-3--3-2-1-0	.../021-000
a-b-c-d--d-c-b-a	.../022-000
3-2-1-0--0-1-2-3	.../023-000
d-c-b-a--a-b-c-d	.../024-000

Accessories; 727 Series
Appropriate marking system: WMB

4-level end plate; no marking; 7.62 mm thick

orange	727-217	25
gray	727-213	25

Insulation stop; 0.25 mm² "s"; 0.14 ... 0.25 mm² "f-st"; 8 pcs/strip

light gray	727-198	200 (25)
------------	---------	----------

4-level end plate; Marking: 0-1-2-3--3-2-1-0; 7.62 mm thick

orange	727-205	25
gray	727-255	25

Insulation stop; 0.25 ... 0.5 mm² "s+f-st"; 8 pcs/strip

dark gray	727-199	200 (25)
-----------	---------	----------

4-level end plate; Marking: a-b-c-d--d-c-b-a; 7.62 mm thick

orange	727-206	25
gray	727-256	25

Wire commoning chain; insulated; 32 connections; I_N 6 A; max. 50 V; 0.5 mm²

gray	709-107	1
------	---------	---

4-level end plate; Marking: 3-2-1-0--0-1-2-3; 7.62 mm thick

orange	727-207	25
gray	727-257	25

Test plug; with 500 mm cable; 2.3 mm Ø; max. 42 V

yellow	210-137	50
--------	---------	----

4-level end plate; Marking: d-c-b-a--a-b-c-d; 7.62 mm thick

orange	727-208	25
gray	727-258	25

Step-down test plug; from 4 mm socket to 2 mm plug; max. 42 V

red	210-297	100 (25)
-----	---------	----------

Insulation stop; 0.08 ... 0.2 mm² "s" (0.14 mm² "f-st"); 8 pcs/strip

white	727-197	200 (25)
-------	---------	----------

Wire harness support

gray	249-109	50
------	---------	----

8-Level Terminal Block for Matrix Patching



1.5 mm²; 727 Series

Technical Data	
0.08 ... 1.5 mm ²	28 ... 16 AWG
250 V/4 kV/3 ①	300 V, 10 A ②
I _N 12 A	300 V, 10 A ③
Terminal block width: 7.62 mm / 0.3 inch	
 8 ... 10 mm / 0.31 ... 0.39 inch	

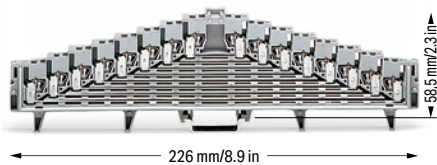
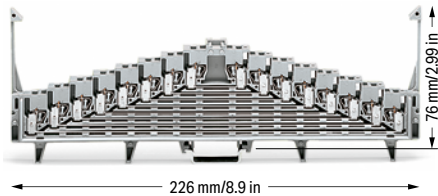

Technical Data	
0.08 ... 1.5 mm ²	28 ... 16 AWG
250 V/4 kV/3 ①	300 V, 10 A ②
I _N 12 A	300 V, 10 A ③
Terminal block width: 7.62 mm / 0.3 inch	
 8 ... 10 mm / 0.31 ... 0.39 inch	



8-level terminal block for matrix patching; with locking clips; no marking; 8 x pairs of clamping units on the same level; for DIN 35 x 7.5 rail

Color	Item No.	Pack. Unit
 gray	727-119	25
 white	727-121	25
 blue	727-123 ②	25

8-level terminal block for matrix patching; without locking clips; no marking; 8 x pairs of clamping units on the same level; for DIN 35 x 7.5 rail

Color	Item No.	Pack. Unit
 gray	727-120	25
 white	727-122	25
 blue	727-124 ②	25

8-level terminal block for matrix patching; with locking clips; no marking; 8 x pairs of clamping units on the same level; for DIN 35 x 15 rail

Color	Item No.	Pack. Unit
 gray	727-129	25
 white	727-131	25
 blue	727-133 ②	25

8-level terminal block for matrix patching; without locking clips; no marking; 8 x pairs of clamping units on the same level; for DIN 35 x 15 rail

Color	Item No.	Pack. Unit
 gray	727-130	25
 white	727-132	25
 blue	727-134 ②	25

Item no. suffixes for terminal blocks with marking:

0-1-2-3-4-5-6-7--7-6-5-4-3-2-1-0	.../001-000
a-b-c-d-e-f-g-h--h-g-f-e-d-c-b-a	.../002-000
7-6-5-4-3-2-1-0--0-1-2-3-4-5-6-7	.../003-000
h-g-f-e-d-c-b-a--a-b-c-d-e-f-g-h	.../004-000



Other terminal blocks with the same profile:

0-1-2-3-4-5-6-7--7-6-5-4-3-2-1-0	.../001-000
a-b-c-d-e-f-g-h--h-g-f-e-d-c-b-a	.../002-000
7-6-5-4-3-2-1-0--0-1-2-3-4-5-6-7	.../003-000
h-g-f-e-d-c-b-a--a-b-c-d-e-f-g-h	.../004-000

Accessories; 727 Series

Appropriate marking system: WMB



4-level end plate; no marking; 7.62 mm thick

 orange	727-117	25
 gray	727-113	25
 blue	727-114	25
 white	727-115	25
 light gray	727-116	25

4-level end plate; Marking: 7-6-5-4-3-2-1-0--0-1-2-3-4-5-6-7; 7.62 mm thick

 orange	727-107	25
 gray	727-157	25
 blue	727-161	25
 white	727-165	25
 light gray	727-169	25

4-level end plate; Marking: 0-1-2-3-4-5-6-7--7-6-5-4-3-2-1-0; 7.62 mm thick

 orange	727-105	25
 gray	727-155	25
 blue	727-159	25
 white	727-163	25
 light gray	727-167	25

4-level end plate; Marking: h-g-f-e-d-c-b-a--a-b-c-d-e-f-g-h; 7.62 mm thick

 orange	727-108	25
 gray	727-158	25
 blue	727-162	25
 white	727-166	25
 light gray	727-170	25

4-level end plate; Marking: a-b-c-d-e-f-g-h--h-g-f-e-d-c-b-a; 7.62 mm thick

 orange	727-106	25
 gray	727-156	25
 blue	727-160	25
 white	727-164	25
 light gray	727-168	25

Insulation stop; 0.08 ... 0.2 mm² "s" (0.14 mm² "f-st"); 8 pcs/strip

 white	727-197	200 (25)
---	---------	----------

Insulation stop; 0.25 mm² "s"; 0.14 ... 0.25 mm² "f-st"; 8 pcs/strip

 light gray	727-198	200 (25)
--	---------	----------

① 250 V = rated voltage
4 kV = rated impulse voltage
3 = pollution degree
(see Section 14)

② Terminal blocks with a blue insulated housing are suitable for Ex i applications.
60 V = peak value ^ (table 4, EN 60079-11 when approved by the manufacturer's authorized inspection representative)

See application notes for:
Wire harness support, page 530
Marking, from page 588

Note: Only combine terminal blocks and end plates that are colored gray/white/light gray or orange/blue!

Approvals and corresponding ratings, visit www.wago.com

Accessories; 727 Series

Appropriate marking systems:
WMB

Insulation stop; 0.25 ... 0.5 mm² "s+f-st"; 8 pcs/strip

 dark gray	727-199	200 (25)
---	---------	----------

Wire commoning chain; insulated; 32 connections; I_N 6 A; max. 50 V; 0.5 mm²

 gray	709-107	1
--	---------	---

Test plug; with 500 mm cable; 2.3 mm Ø; max. 42 V

 yellow	210-137	50
--	---------	----

Step-down test plug; from 4 mm socket to 2 mm plug; max. 42 V

 red	210-297	100 (25)
---	---------	----------

Wire harness support

 gray	249-109	50
--	---------	----

Double marker carrier; for center I/O module marking; for WSB and WMB marking systems; 4 mm wide

 gray	209-128	200 (100)
--	---------	-----------

WMB marker card; white; 10 strips with 10 markers/card; for PLC input marking; for 5 ... 17.5 mm terminal block width

 E0.0, E0.1, ..., E9.6, E9.7 (1x each)	793-933	5
---	---------	---

Screwless end stop; for DIN-35 rail; 6 mm wide

 gray	249-116	100 (25)
--	---------	----------

Screwless end stop; for DIN-35 rail; 10 mm wide

 gray	249-117	50 (25)
--	---------	---------

Operating tool with a partially insulated shaft; Type 1; (2.5 x 0.4) mm blade

 operating tool	210-719	1
--	---------	---

8-Level Common Potential Terminal Block

1.5 mm²; 727 Series

Technical Data	
0.08 ... 1.5 mm ²	28 ... 16 AWG
250 V/4 kV/3 ①	300 V, 10 A ②
I _N 18 A	300 V, 10 A ③
Terminal block width: 7.62 mm / 0.3 inch	
8 ... 10 mm / 0.31 ... 0.39 inch	

Technical Data	
0.08 ... 1.5 mm ²	28 ... 16 AWG
250 V/4 kV/3 ①	300 V, 10 A ②
I _N 18 A	300 V, 10 A ③
Terminal block width: 7.62 mm / 0.3 inch	
8 ... 10 mm / 0.31 ... 0.39 inch	

① 250 V = rated voltage
4 kV = rated impulse voltage
3 = pollution degree
(see Section 14)

See application notes for:
Wire harness support, page 530
Marking, from page 588

Note: Only combine terminal blocks and end plates that are colored **gray/white/light gray** or **orange/blue!**

Approvals and corresponding ratings, visit www.wago.com

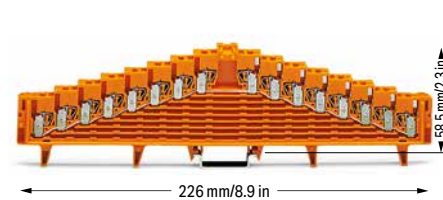
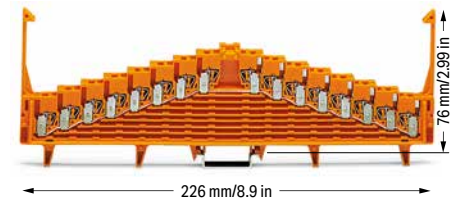

8-level common potential terminal block; with locking clips; no marking; all clamping units connected to the same current bar; for DIN 35 x 7.5 rail

Color	Item No.	Pack. Unit
orange	727-125	25
light gray	727-127	25

8-level terminal block for matrix patching; without locking clips; no marking; all clamping units connected to the same current bar; for DIN 35 x 7.5 rail

Color	Item No.	Pack. Unit
orange	727-126	25
light gray	727-128	25

8-level common potential terminal block; with locking clips; no marking; all clamping units connected to the same current bar; for DIN 35 x 15 rail

Color	Item No.	Pack. Unit
orange	727-135	25
light gray	727-137	25

8-level terminal block for matrix patching; without locking clips; no marking; all clamping units connected to the same current bar; for DIN 35 x 15 rail

Color	Item No.	Pack. Unit
orange	727-136	25
light gray	727-138	25

Item no. suffixes for terminal blocks with marking:		
0-1-2-3-4-5-6-7--7-6-5-4-3-2-1-0	.../001-000	
a-b-c-d-e-f-g-h--h-g-f-e-d-c-b-a	.../002-000	
7-6-5-4-3-2-1-0--0-1-2-3-4-5-6-7	.../003-000	
h-g-f-e-d-c-b-a--a-b-c-d-e-f-g-h	.../004-000	

Other terminal blocks with the same profile:		
0-1-2-3-4-5-6-7--7-6-5-4-3-2-1-0	.../001-000	
a-b-c-d-e-f-g-h--h-g-f-e-d-c-b-a	.../002-000	
7-6-5-4-3-2-1-0--0-1-2-3-4-5-6-7	.../003-000	
h-g-f-e-d-c-b-a--a-b-c-d-e-f-g-h	.../004-000	

Accessories; 727 Series

Appropriate marking system: WMB

4-level end plate; no marking; 7.62 mm thick		
orange	727-117	25
gray	727-113	25
blue	727-114	25
white	727-115	25
light gray	727-116	25

4-level end plate; Marking: h-g-f-e-d-c-b-a--a-b-c-d-e-f-g-h; 7.62 mm thick		
orange	727-108	25
gray	727-158	25
blue	727-162	25
white	727-166	25
light gray	727-170	25

4-level end plate; Marking: 0-1-2-3-4-5-6-7--7-6-5-4-3-2-1-0; 7.62 mm thick		
orange	727-105	25
gray	727-155	25
blue	727-159	25
white	727-163	25
light gray	727-167	25

Insulation stop; 0.08 ... 0.2 mm ² "s" (0.14 mm ² "f-st"); 8 pcs/strip		
white	727-197	200 (25)

4-level end plate; Marking: a-b-c-d-e-f-g-h--h-g-f-e-d-c-b-a; 7.62 mm thick		
orange	727-106	25
gray	727-156	25
blue	727-160	25
white	727-164	25
light gray	727-168	25

Insulation stop; 0.25 mm ² "s"; 0.14 ... 0.25 mm ² "f-st"; 8 pcs/strip		
light gray	727-198	200 (25)

4-level end plate; Marking: 7-6-5-4-3-2-1-0--0-1-2-3-4-5-6-7; 7.62 mm thick		
orange	727-107	25
gray	727-157	25
blue	727-161	25
white	727-165	25
light gray	727-169	25

Insulation stop; 0.25 ... 0.5 mm ² "s+f-st"; 8 pcs/strip		
dark gray	727-199	200 (25)

Wire commoning chain; insulated; 32 connections; I _N 6 A; max. 50 V; 0.5 mm ²		
gray	709-107	1

Accessories; 727 Series

Appropriate marking systems:
WMB

Test plug; with 500 mm cable; 2.3 mm Ø; max. 42 V		
yellow	210-137	50

Step-down test plug; from 4 mm socket to 2 mm plug; max. 42 V		
red	210-297	100 (25)

Wire harness support

gray	249-109	50
------	---------	----

Double marker carrier; for center I/O module marking; for WSB and WMB marking systems; 4 mm wide

gray	209-128	200 (100)
------	---------	-----------

Screwless end stop; for DIN-35 rail; 6 mm wide

gray	249-116	100 (25)
------	---------	----------

Screwless end stop; for DIN-35 rail; 10 mm wide

gray	249-117	50 (25)
------	---------	---------

Operating tool with a partially insulated shaft; Type 1; (2.5 x 0.4) mm blade

	210-719	1
--	---------	---

Terminal Blocks for Matrix Patching

280 Series

Description and Installation

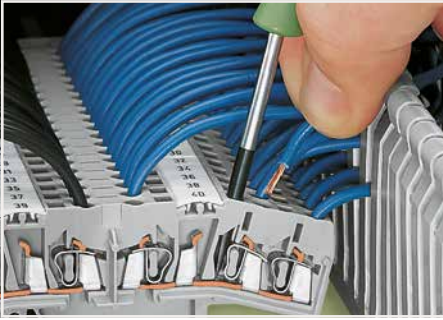

Terminal blocks for matrix patching: Inserting/removing a conductor on the terminal block's side-entry.
With ferruled conductors, it is necessary to use a terminal block one size smaller than the conductor's nominal cross section.

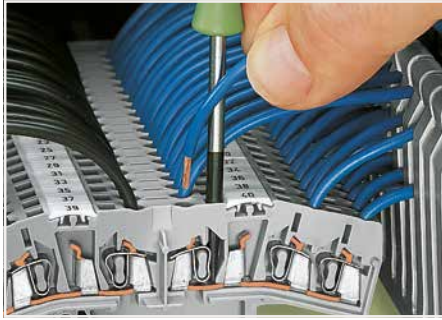

Terminal blocks for matrix patching: Inserting/removing a conductor in the terminal block's center.

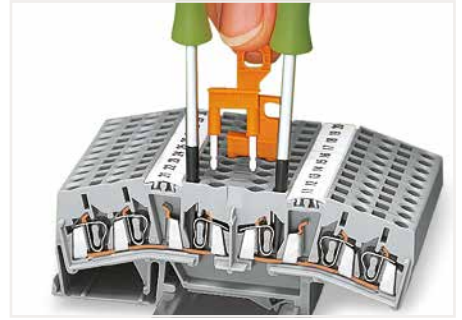

Using terminal blocks for matrix patching as disconnect terminal blocks via disconnect jumpers.

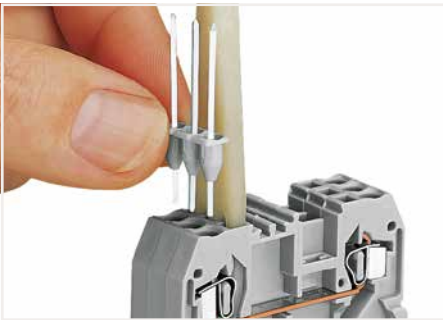

Inserting a pin module into 280 Series blocks.



Multiplying potentials via 10-way comb-style jumper bar. (only possible in the terminal block's center)

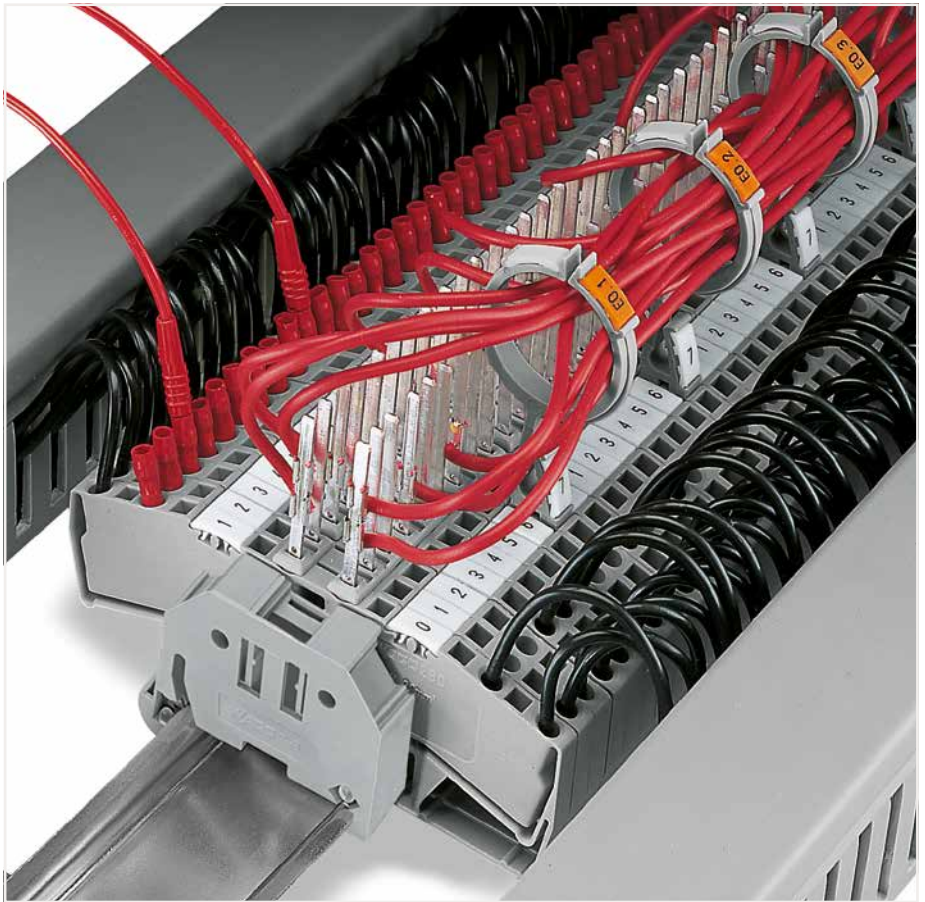

11



Clipping a wire harness support into the marker slot.



Inserting a cable into the wire harness support.

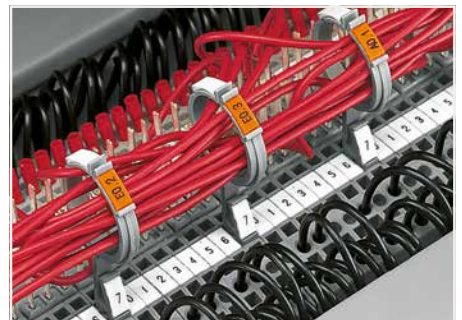

2 x group marking on top
1 x terminal block marking at the bottom

CAGE CLAMP® terminates the following copper conductors:
solid stranded

fine-stranded,
also with tinned
single strands

fine-stranded,
tip-bonded

fine-stranded,
with ferrule
(gastight crimped)

fine-stranded,
with pin terminal
(gastight crimped)

For aluminum conductors, see notes in Section 14. With ferruled conductors, it is necessary to use a terminal block one size smaller than the conductor's nominal cross section.

Terminal Block for Matrix Patching

2.5 mm²; 280 Series

Technical Data

0.08 ... 2.5 mm² | 28 ... 12 AWG*

800 V/8 kV/3 ① | 600 V, 10 A ②

I_N 18 A

Terminal block width: 5 mm / 0.197 inch

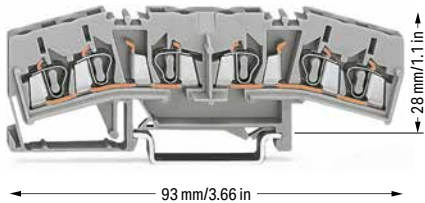
 8 ... 9 mm / 0.31 ... 0.35 inch

3-conductor double-potential terminal block or terminal block for matrix patching

Notice: This 3-conductor double-potential terminal block cannot be commoned via adjacent jumpers.

Color	Item No.	Pack. Unit
○ gray	280-675	100

Accessories; for Terminal Blocks for Matrix Patching

Appropriate marking systems:
WMB/WMB Inline

End and intermediate plate; 25 mm thick

orange	280-333	25
gray	280-325	25

Separator; 3 mm oversized; 1 mm thick

gray	280-394	100 (25)
orange	280-395	100 (25)

Insulation stop; 0.08 ... 0.2 mm² "s" (0.14 mm² "f-st"); 5 pcs/strip

white	280-470	200 (25)
-------	---------	----------

Insulation stop; 0.25 ... 0.5 mm²; 5 pcs/strip

light gray	280-471	200 (25)
------------	---------	----------

Insulation stop; 0.75 ... 1 mm²; 5 pcs/strip

dark gray	280-472	200 (25)
-----------	---------	----------

Protective warning marker; with black high-voltage symbol; for 5 terminal blocks

yellow	280-415	100 (25)
--------	---------	----------

Comb-style jumper bar; insulated; I_N = I_N of terminal block

2-way	280-482	200 (25)
3-way	280-483	200 (25)

Comb-style jumper bar; insulated; I_N = I_N of terminal block

10-way	280-490	50 (25)
--------	---------	---------

Disconnect jumper; with pull-tab; I_N = I_N of terminal block; orange

2-way	280-494	200 (25)
-------	---------	----------

*12 AWG: THHN, THWN

- ① 800 V = rated voltage
8 kV = rated impulse voltage
3 = pollution degree (see Section 14)
500 V/6 kV/3 between both current bars (if used as disconnect terminal block or potential multiplier)

See application notes for:
Insulation stop, page 346
Comb-style jumper bar, page 284
Marking, from page 588

Approvals and corresponding ratings, visit www.wago.com

Accessories; for Terminal Blocks for Matrix Patching

Appropriate marking systems:
WMB/WMB Inline

Operating tool; insulated

2-way	280-432	1
3-way	280-433	1

Operating tool; insulated

10-way	280-440	1
--------	---------	---

Pin module; 1 x 1 mm; for self-assembly on all front-entry rail-mount terminal blocks (280 Series); for wire-wrap connection; 2-pole

	280-477	100
--	---------	-----

Pin module; 0.8 x 2.4 mm; for self-assembly on all front-entry rail-mount terminal blocks (280 Series); for termi-point connection; 2-pole

	280-473	100
--	---------	-----

Pin module; 1 x 1 mm; for self-assembly on all front-entry rail-mount terminal blocks (280 Series); for wire-wrap connection; 3-pole

	280-478	100
--	---------	-----

Pin module; 0.8 x 2.4 mm; for self-assembly on all front-entry rail-mount terminal blocks (280 Series); for termi-point connection; 3-pole

	280-474	100
--	---------	-----

Wire harness support

gray	249-109	50
------	---------	----

In measurement and control technology, matrix patchboards are essential for process automation systems. Particularly beneficial to these applications is the use of the WAGO wire harness support, which simplifies wiring. WAGO's 280 Series 3-Conductor Double-Potential Terminal Blocks (with or without the addition of Wire-Wrap® or TERMI-POINT® pins) are also ideal for this type of application. They can be used for connecting peripheral field devices (e.g. measuring and control equipment) to process control systems (e.g., panels, cabinets) via matrix connections.

The WAGO wire harness supports are pushed into the terminal blocks (approx. every 8th unit) to form an additional "cable-duct" above the wiring level of the terminal blocks. The two marker slots on the top may be used for group marking, while the lower slot is used for marking the terminal block.

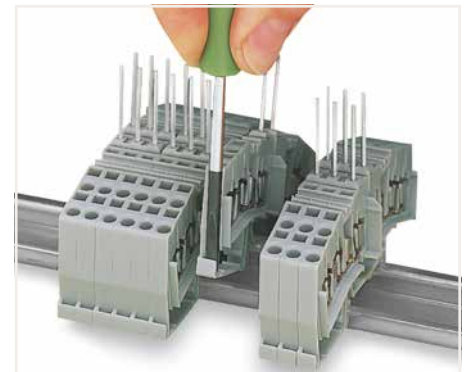

Please note that due to the protruding rods, the terminal blocks can only be inserted or removed from the assembly after sliding adjacent terminal blocks on the rail. Removal: Separate terminal strip, slide terminal block to disconnect and then remove from the DIN-rail.

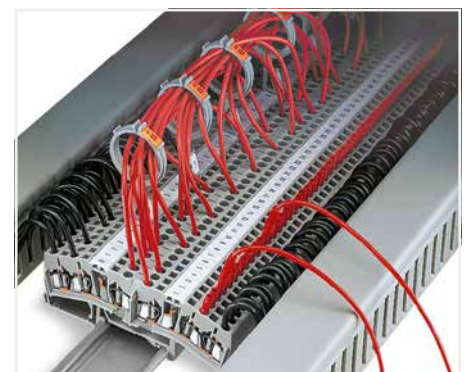

Terminal blocks for matrix patching with wire harness supports:

For 5 mm wide double-potential terminal blocks, two 3-conductor through terminal blocks are offered in one insulating housing on one level. This achieves a width of just 2.5 mm versus standard through terminal blocks. On each side of the terminal block are marker slots for WAGO WMB Inline markers. Via the available accessories, these terminal blocks can also be used as 4-conductor disconnect terminal blocks or potential multipliers.

The WAGO wire harness supports are pushed into the terminal blocks (approx. every 8th unit) to form an additional "cable-duct" above the wiring level of the terminal blocks. The two marker slots on the top may be used for group marking, while the lower slot is used for marking the terminal block.

PUSH-IN CAGE CLAMP® CAGE CLAMP®

Busbar Terminal Blocks

812 Series

Description and Installation

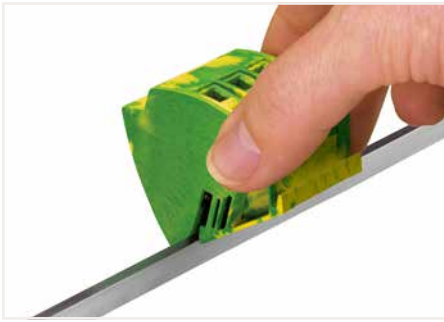

Snapping a ground busbar terminal block onto the N-busbar.



Unlock right and left positions to remove the ground busbar terminal block. Then pull up the block from the busbar.

Using the 812 Series Busbar Terminal Blocks in switch-gear cabinets and distribution boards permits simple and safe potential distribution on standard (10 x 3) mm busbars. Tool-free snapping of self-locking busbar terminal blocks onto the busbar enables quick and easy assembly, as well as subsequent extension. The busbar terminal blocks are available in two different versions for conductors ranging from 1.5 to 16 mm² (16–6 AWG).
 Current carrying capacity: With a maximum total current of 96 A, the clamping units of the busbar terminal block can be loaded with the rated current of the conductor cross sections approved. This only applies when (10 x 3) mm busbars are used.

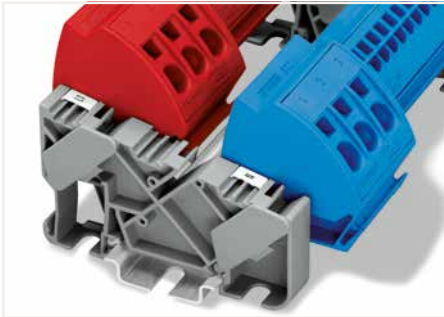

Busbar carrier (812-140): Offers three receptacles for (10 x 3) mm busbars with locking device for easy mounting of the busbars. The carrier can be snapped onto the DIN-35 rail or screwed on a panel.



Ground busbar carrier (812-141): Offers a receptacle with locking device for (10 x 3) mm busbar. Contact between the busbar and rail is made automatically by simply snapping the carrier onto the DIN-35 rail. One end of the busbar is mounted onto the ground busbar carrier, the other end is inserted into the middle position of the insulated busbar carrier.

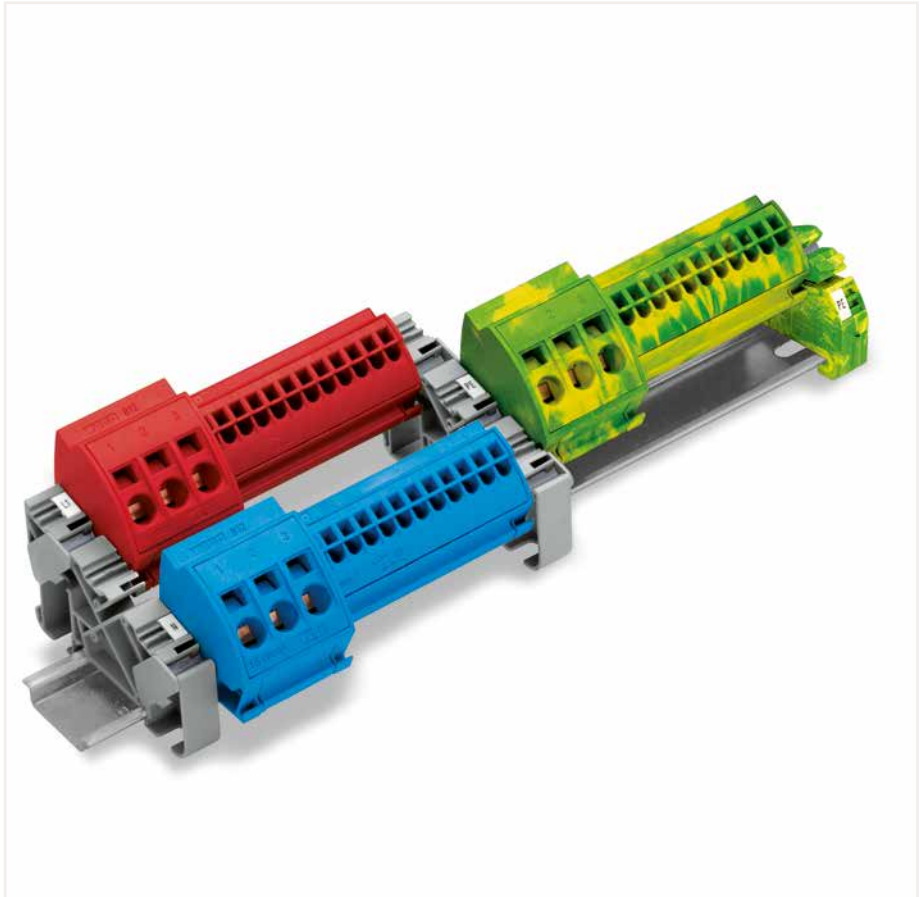

Mixed 4 mm² (12 AWG) and 16 mm² (6 AWG) busbar terminal blocks



Conductor termination (4 mm²/12 AWG): With Push-in CAGE CLAMP®, solid conductors can be terminated by simply pushing them into the 12 x 4 mm² busbar terminal block, significantly reducing wiring time.

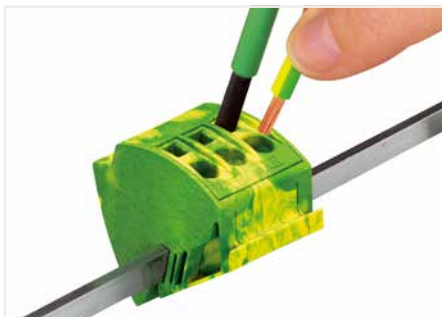

Conductor termination (16 mm²/6 AWG): Open the clamping unit with an operating tool when terminating solid, stranded and fine-stranded conductors.

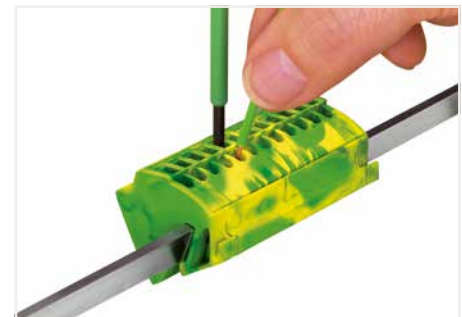

Conductor removal (4 mm²/12 AWG and 16 mm²/6 AWG): Open the clamping unit using an operating tool.

CAGE CLAMP® and Push-in CAGE CLAMP® terminate the following copper conductors:

solid	stranded
-------	----------

fine-stranded,
also with tinned
single strands

fine-stranded,
tip-bonded

For aluminum conductors, see notes in Section 14.



11

Busbar Terminal Block 4 mm² and 16 mm²; 812 Series

Technical Data	
0.5 ... 4 mm²	20 ... 12 AWG
1000 V/6 kV/3	600 V, 20 A
I _N 96 A	600 V, 95 A
Terminal block width: 75 mm / 2.953 inch	
11 mm / 0.43 inch	



Technical Data	
1.5 ... 16 mm²	14 ... 6 AWG
1000 V/6 kV/3	600 V, 20 A
I _N 96 A	600 V, 95 A
Terminal block width: 38 mm / 1.496 inch	
12 mm / 0.47 inch	

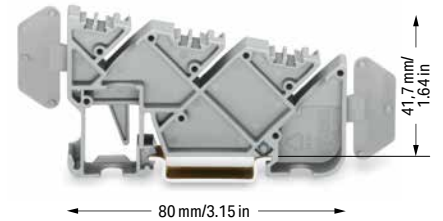
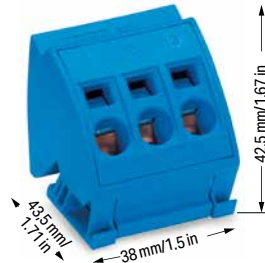

Busbar terminal block 4 mm²; with Push-in CAGE CLAMP® connection		
Color	Item No.	Pack. Unit
blue	812-104	10
light gray	812-101	10
dark gray	812-102	10
red	812-103	10

Busbar terminal block 16 mm²; with CAGE CLAMP® connection		
Color	Item No.	Pack. Unit
blue	812-114	12
light gray	812-111	12
dark gray	812-112	12
red	812-113	12

Insulated busbar carrier; 12 mm wide		
Color	Item No.	Pack. Unit
gray	812-140	25

Accessories; item-specific		
Busbar; tin-plated; 1000 mm long; Copper (10 x 3) mm		
I _N	Item No.	Pack. Unit
140 A	210-133	1



Accessories; item-specific		
Busbar; tin-plated; 1000 mm long; Copper (10 x 3) mm		
I _N	Item No.	Pack. Unit
140 A	210-133	1



Accessories; item-specific		
Finger guard; touch-proof cover protects unused conductor entries		
Color	Item No.	Pack. Unit
yellow	284-400	100 (25)

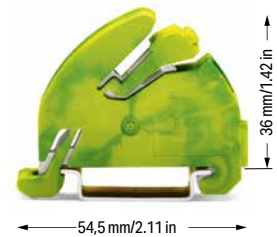
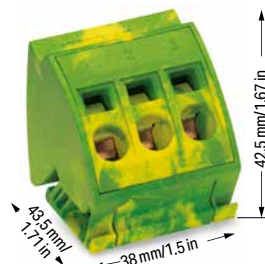
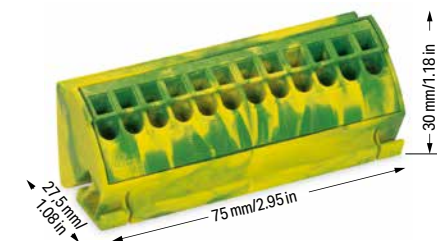

Ground busbar terminal block 4 mm²; with Push-in CAGE CLAMP® connection		
Color	Item No.	Pack. Unit
green-yellow	812-100	10

Ground busbar terminal block 16 mm²; with CAGE CLAMP® connection		
Color	Item No.	Pack. Unit
green-yellow	812-110	12

Ground busbar carrier; with DIN-35 rail contact; 11 mm wide		
Color	Item No.	Pack. Unit
green-yellow	812-141	25

Accessories; item-specific		
Busbar; tin-plated; 1000 mm long; Copper (10 x 3) mm		
I _N	Item No.	Pack. Unit
140 A	210-133	1



Accessories; item-specific		
Busbar; tin-plated; 1000 mm long; Copper (10 x 3) mm		
I _N	Item No.	Pack. Unit
140 A	210-133	1



Accessories; item-specific		
Finger guard; touch-proof cover protects unused conductor entries		
Color	Item No.	Pack. Unit
yellow	284-400	100 (25)





WAGO Splicing Connectors

WAGO Lighting Connectors

WAGO Splicing Connectors

WAGO Lighting Connectors

			Page
	COMPACT PUSH WIRE® Connectors for Junction Boxes 2.5 mm ² (14 AWG)	2273 Series	537
	PUSH WIRE® Connectors for Junction Boxes 4 mm ² and 6 mm ² (10 AWG)	773 Series	540
	Ex PUSH WIRE® Connectors for Junction Boxes 2.5 mm ² (12 AWG) and 6 mm ² (10 AWG)	773 Series	542
	MICRO PUSH WIRE® Connectors for Junction Boxes 0.8 mm Ø	243 Series	546
	COMPACT Splicing Connectors for All Conductor Types 4 mm ² and 6 mm ² (10 AWG)	221 Series	549
	CLASSIC Splicing Connectors for All Conductor Types 2.5 mm ² (14 AWG)	222 Series	557
	Lighting Connectors 2.5 mm ² (14 AWG)	224 Series	561
	Splicing Connector Set	887 Series	562
	Luminaire Disconnect Connectors 12 AWG	873 Series	566

COMPACT PUSH WIRE® Junction Box Connectors for Solid Conductors

2273 Series

Description and Installation



Advantages:

- Convenient wiring via extremely compact design
- Push-in termination of up to eight solid conductors
- Cross section range: 0.5 ... 2.5 mm² (18 ... 14 AWG)
- Any combination of conductor sizes is possible
- PUSH WIRE® connection terminates solid ("s") copper conductors



Strip solid conductor to 11 mm/0.43 inch (see marking).

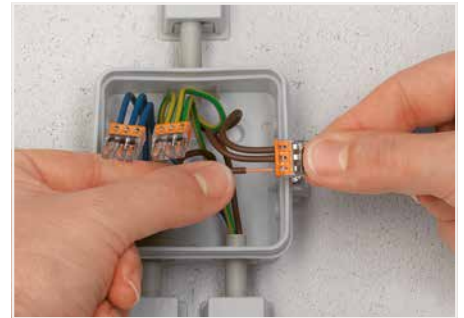

Termination: Insert the stripped solid conductor until it hits backstop.

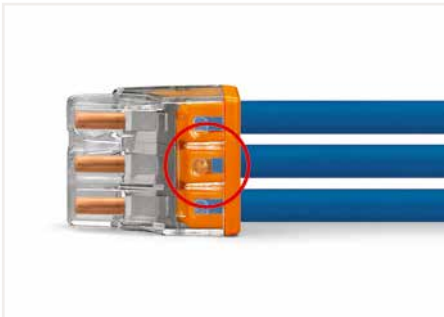

The transparent housing shows if conductors are fully inserted; within the colored base, a clear port shows if the conductor's strip length is correct.

Conductors are correctly stripped if the clear port shows no bare conductor on the unprinted connector side. Picture shows center conductor with exceeded strip length.



Removal: Hold conductor to be removed and twist alternately left and right while pulling the connector.



Testing via test port opposite to conductor entry.



One single carrier can hold up to 24 clamping units in a very narrow space. Previously, this was only possible using rail-mount terminal blocks.

Advantages:

- Mount carrier onto DIN-35 rail or via screws – easily and quickly
- Accommodate three 2.5 mm² (12 AWG) 2273 Series Connectors in a single carrier
- Easily exchange connectors
- Large marking area for self-adhesive marking strips or for direct marking with permanent felt-tip pen

PUSH WIRE® Connectors in Distribution Boxes

During distribution box retrofits or expansions, conductors often require extensions or additional clamping points. Individual PUSH WIRE® connectors (e.g., 2273 Series) are approved as interconnect components for building wiring applications per EN 60998. Application standards for building installation (e.g., Parts 510 and 520 from DIN VDE 0100) also place the following requirements on junction box connectors:

- They must be arranged so that operation, inspection, maintenance and access to the removable connectors is simplified.
- It must be possible to test them.
- Conductors connected from outside must be clearly and permanently assigned to their associated circuits.

These requirements cannot be met with PUSH WIRE® connectors alone. In combination with mounting carriers, the PUSH WIRE® connectors clearly meet these requirements, making them comparable to rail-mount terminal blocks. Using PUSH WIRE® connectors with mounting carriers in distribution boxes is accepted by testing authorities.



To adjust the mounting carrier, unlock the latch via operating tool (5.5 mm blade) and move the clamping slide to the required width by rotating the tool.



The mounting carrier is suitable for both connector widths.



PUSH WIRE® terminates the following copper conductors: solid

12

COMPACT PUSH WIRE® Junction Box Connector for Solid Conductors and Mounting Carrier 2.5 mm²; 2273 Series

Technical Data	
0.5 ... 2.5 mm ² "s"	20 ... 14 AWG "s"
450 V/4 kV/2	
I _N 24 A	
11 mm / 0.43 inch	

Technical Data	
0.5 ... 2.5 mm ² "s"	20 ... 14 AWG "s"
450 V/4 kV/2	
I _N 24 A	
11 mm / 0.43 inch	

Technical Data	
0.5 ... 2.5 mm ² "s"	20 ... 14 AWG "s"
450 V/4 kV/2	
I _N 24 A	
11 mm / 0.43 inch	



Dimensions in mm

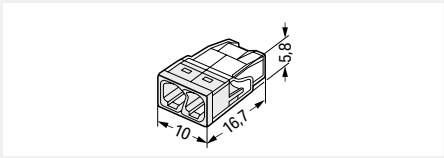

COMPACT PUSH WIRE® connector for junction boxes; 2-wire connector; Transparent housing; White cover; Continuous operating temperature (max.): 105 °C; Surrounding air temperature (max.): 60 °C (T60)

Item No.	Pack. Unit
2273-202	1000 (100)

Dimensions in mm

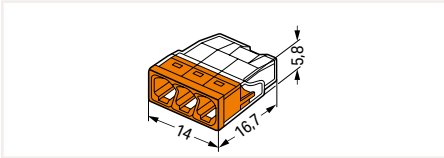

COMPACT PUSH WIRE® connector for junction boxes; 3-wire connector; Transparent housing; Orange cover; Continuous operating temperature (max.): 105 °C; Surrounding air temperature (max.): 60 °C (T60)

Item No.	Pack. Unit
2273-203	1000 (100)

Dimensions in mm

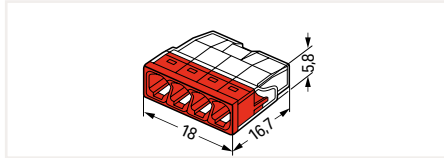

COMPACT PUSH WIRE® connector for junction boxes; 4-wire connector; Transparent housing; Red cover; Continuous operating temperature (max.): 105 °C; Surrounding air temperature (max.): 60 °C (T60)

Item No.	Pack. Unit
2273-204	1000 (100)

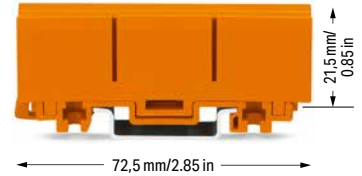

Dimensions in mm

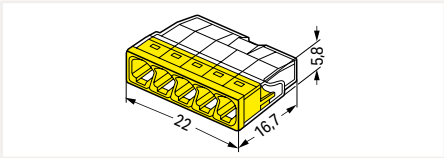

COMPACT PUSH WIRE® connector for junction boxes; 5-wire connector; Transparent housing; Yellow cover; Continuous operating temperature (max.): 105 °C; Surrounding air temperature (max.): 60 °C (T60)

Item No.	Pack. Unit
2273-205	1000 (100)

Dimensions in mm

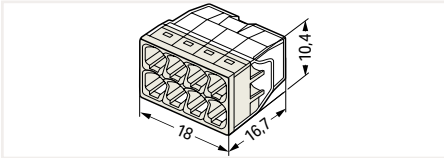

COMPACT PUSH WIRE® connector for junction boxes; 8-wire connector; Transparent housing; Light gray cover; Continuous operating temperature (max.): 105 °C; Surrounding air temperature (max.): 60 °C (T60)

Item No.	Pack. Unit
2273-208	500 (50)

Mounting carrier; for single- and double-row connectors

	Item No.	Pack. Unit
orange	2273-500	50 (10)

Accessories; item-specific

Marking strip; 5 mm high; 48 self-adhesive strips per card; plain

	white	210-334	100

Accessories; 2273 Series

Syringe; contains 20 ml "Alu-Plus" Contact Paste



Item No.	Pack. Unit
249-130	20 (5)

PUSH WIRE® Connectors for Junction Boxes

773 Series

Description and Installation

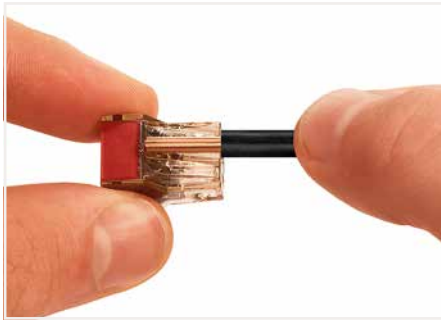
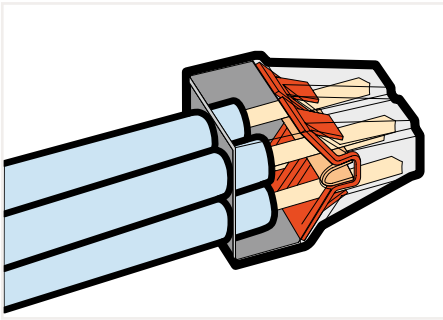

Strip a solid conductor to 12 mm (0.47 inch).



Termination: Insert stripped solid conductor until it hits backstop.



Removal: Hold conductor to be removed and twist alternately left and right while pulling the connector.

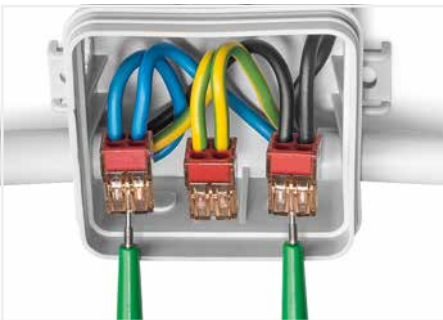

Testing



12



PUSH WIRE® terminates the following copper conductors:
solid

Mounting Carrier; for PUSH WIRE® Junction Box Connectors; for DIN-35 Rail or Screw Mount; 773 Series

773 Series

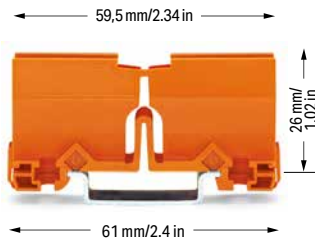

Mounting carrier; for all 773 Series PUSH WIRE® Connectors for Junction Boxes

Color	Item No.	Pack. Unit
orange	773-332	50 (10)

Use the cover as an end plate.

Accessories; item-specific

Marking strip; 5 mm high; 48 self-adhesive strips per card; plain

white	210-334	100
-------	---------	-----



Snap the mounting carrier onto the DIN-rail.

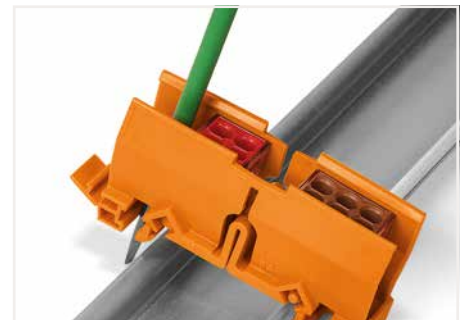

Remove the mounting carrier from the DIN-rail.



A mounting carrier (see accessories) suits applications where the connectors must be marked and secured in position. The DIN-35 rail-mount carrier fits up to six connectors and can also be mounted on a flat surface using two screws.

Using this PUSH WIRE® connector, a large range of wiring applications can be achieved in distribution or junction boxes. To mention just a few: potential multiplication and changing from or to 6 mm² (10 AWG) conductor size.

PUSH WIRE® Junction Box Connector for Solid Conductors

4 mm²; 773 Series

Technical Data
1.5 ... 4 mm² "s"
400 V/4 kV/2 ①
I _N 32 A
12 mm / 0.47 inch



Dimensions in mm

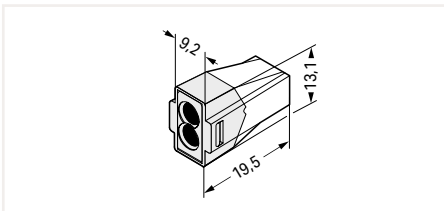

PUSH WIRE® junction box connector for solid conductors up to 4 mm²; 2-wire connector; Transparent brown housing; White cover; Continuous operating temperature (max.): 105 °C; Surrounding air temperature (max.): 60 °C (T60)

Item No.	Pack. Unit
773-602	1000 (100)

Technical Data
1.5 ... 4 mm² "s"
400 V/4 kV/2 ①
I _N 32 A
12 mm / 0.47 inch



Dimensions in mm

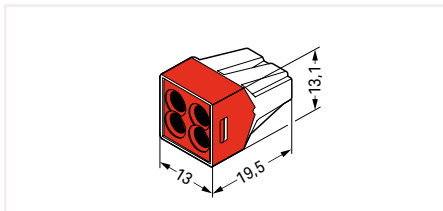

PUSH WIRE® junction box connector for solid conductors up to 4 mm²; 2-wire connector; Transparent brown housing; Red cover; Continuous operating temperature (max.): 105 °C; Surrounding air temperature (max.): 60 °C (T60)

Item No.	Pack. Unit
773-604	1000 (100)

Technical Data
1.5 ... 4 mm² "s"
400 V/4 kV/2 ①
I _N 32 A
12 mm / 0.47 inch



Dimensions in mm

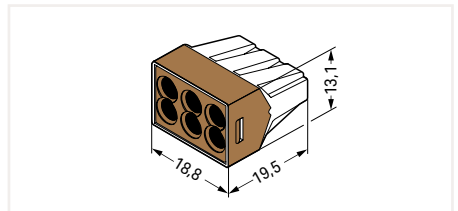

PUSH WIRE® junction box connector for solid conductors up to 4 mm²; 2-wire connector; Transparent brown housing; Brown cover; Continuous operating temperature (max.): 105 °C; Surrounding air temperature (max.): 60 °C (T60)

Item No.	Pack. Unit
773-606	500 (50)

Accessories; 773 Series

Syringe; contains 20 ml "Alu-Plus" Contact Paste



Item No.	Pack. Unit
249-130	20 (5)

Mounting carrier; for single- and double-row connectors



Color	Item No.	Pack. Unit
orange	773-332	50 (10)

PUSH WIRE® Connector for Junction Boxes

2.5 mm² and 6 mm²; 773 Series

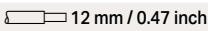
Technical Data	
0.75 ... 2.5 mm ² "s"	18 ... 12 AWG "s"
1.5 ... 2.5 mm ² "st"	16 ... 12 AWG "st"
400 V/4 kV/2 ①	600 V, 20 AⓈ
I _N 24 A	600 V, 20 AⓈ
 12 mm / 0.47 inch	

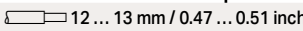
Technical Data	
2.5 ... 6 mm ² "s+st"	14 ... 10 AWG "s+st"
400 V/4 kV/2 ①	600 V, 30 AⓈ
I _N 41 A	600 V, 30 AⓈ
 12 ... 13 mm / 0.47 ... 0.51 inch	

- ① In grounded power lines
 400 V = rated voltage
 4 kV = rated impulse voltage
 2 = pollution degree
 (see Section 14)

Approvals and corresponding ratings, visit www.wago.com



Dimensions in mm

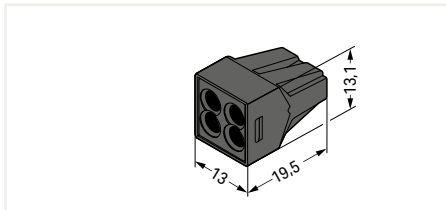

PUSH WIRE® connector for junction boxes; 4-wire connector; Continuous operating temperature: 105 °C; Surrounding air temperature (max.): 105 °C

Color	Item No.	Pack. Unit
● black	773-514	1000 (100)

Dimensions in mm

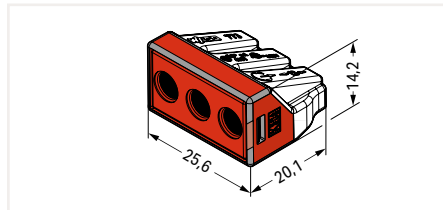

PUSH WIRE® connector for junction boxes; 3-wire connector; Transparent housing; Red cover; Continuous operating temperature (max.): 105 °C; Surrounding air temperature (max.): 60 °C

Color	Item No.	Pack. Unit
● red	773-173	500 (50)

Accessories; 773 Series

Syringe; contains 20 ml "Alu-Plus" Contact Paste

249-130 20 (5)



PUSH WIRE® Connectors in Distribution Boxes

During distribution box retrofits or expansions, conductors often require extensions or additional clamping points. Individual PUSH WIRE® connectors (e.g., 773 Series) are approved as interconnect components for building wiring applications per EN 60998. Application standards for building installation (e.g., Parts 510 and 520 from DIN VDE 0100) also place the following requirements on junction box connectors:

- They must be arranged so that operation, inspection, maintenance and access to the removable connectors is simplified.
- It must be possible to test them.
- Conductors connected from outside must be clearly and permanently assigned to their associated circuits.

These requirements cannot be met with PUSH WIRE® connectors alone. In combination with mounting carriers, the PUSH WIRE® connectors clearly meet these requirements, making them comparable to rail-mount terminal blocks. Using PUSH WIRE® connectors with mounting carriers in distribution boxes is accepted by testing authorities.

Ex PUSH WIRE® Connector for Junction Boxes 2.5 mm² and 6 mm²; 773 Series

Technical Data

0.75 ... 2.5 mm ² "s"	18 ... 14 AWG "s" 16 ... 12 AWG "st"
550 V ①	
I _N 24 A	
□ 12 mm / 0.47 inch	



Dimensions in mm

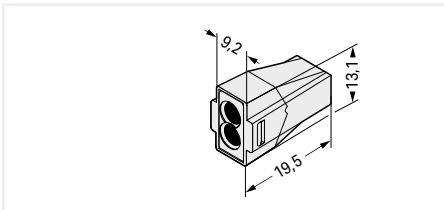

PUSH WIRE® connector for junction boxes; 2-wire connector

Color	Item No.	Pack. Unit
○ light gray ②	773-492 ②	1000 (100)

Technical Data

0.75 ... 2.5 mm ² "s"	18 ... 14 AWG "s" 16 ... 12 AWG "st"
550 V ①	
I _N 24 A	
□ 12 mm / 0.47 inch	



Dimensions in mm

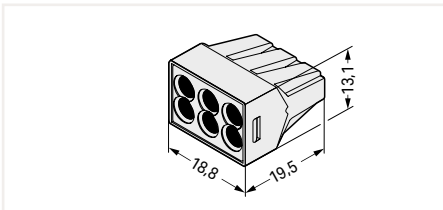

PUSH WIRE® connector for junction boxes; 6-wire connector

Color	Item No.	Pack. Unit
○ light gray ②	773-496 ②	500 (50)

Technical Data

2.5 ... 6 mm ² "s"	14 ... 10 AWG "s"
550 V ①	
I _N 42 A	
□ 12 ... 15 mm / 0.47 ... 0.59 inch	



Dimensions in mm

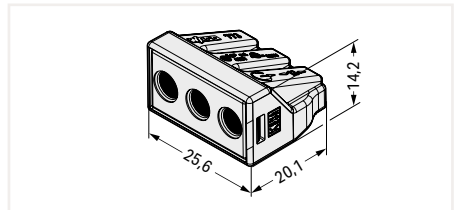

PUSH WIRE® connector for junction boxes; 3-wire connector

Color	Item No.	Pack. Unit
○ light gray ②	773-493 ②	500 (50)



Dimensions in mm

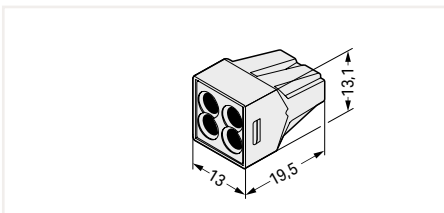

PUSH WIRE® connector for junction boxes; 4-wire connector

Color	Item No.	Pack. Unit
○ light gray ②	773-494 ②	1000 (100)



Dimensions in mm

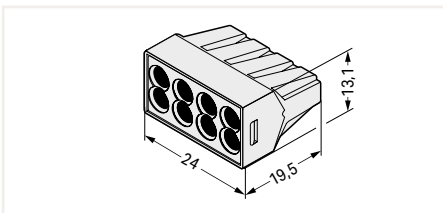

PUSH WIRE® connector for junction boxes; 8-wire connector

Color	Item No.	Pack. Unit
○ light gray ②	773-498 ②	500 (50)

12

Mounting Carrier; for Ex PUSH WIRE® Junction Box Connectors; for DIN-35 Rail or Screw Mount 773 Series

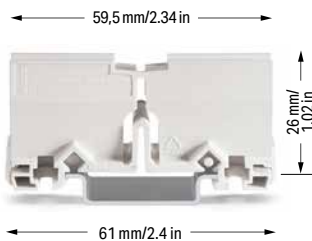

Mounting carrier; for Ex PUSH WIRE® junction box connectors

Color	Item No.	Pack. Unit
○ light gray ☺	773-331	50 (10)

Accessories; item-specific

Marking strip; 5 mm high; 48 self-adhesive strips per card; plain

	white	210-334	100
---	-------	---------	-----

- 1 275 V at a distance < 10 mm to parts of other potentials
 - 2 To be used only in conjunction with a mounting carrier (773-331)
- Approvals and corresponding ratings, visit www.wago.com

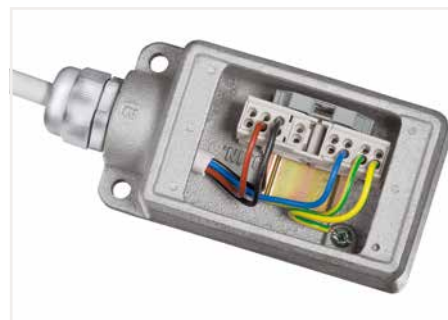

Wiring example in an Ex junction box



Insert the connectors into the carrier.

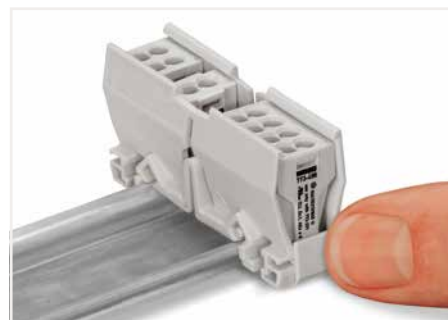

Use the cover as an end plate.



Snap the mounting carrier onto the DIN-rail.



Remove the mounting carrier from the DIN-rail.

Ex PUSH WIRE® connectors are ideal for distribution and junction boxes, as well as control and operating systems. When used in hazardous areas, they offer the following advantages over traditional connectors:

- Time- and cost-saving PUSH WIRE® connection
- Vibration-proof, maintenance-free connections
- 100% touch-proof protection
- Connectors can be secured in position via mounting carriers
- One single carrier equipped with 2-, 4-, 6- and 8-wire connectors holds up to 16 clamping units according to user requirements, saving materials and related costs
- Available as OEM products for manufacturers and suppliers of enclosures and distribution boxes used in hazardous areas

MICRO PUSH WIRE® Junction Box Connectors for Solid Conductors

243 Series

Description and Installation

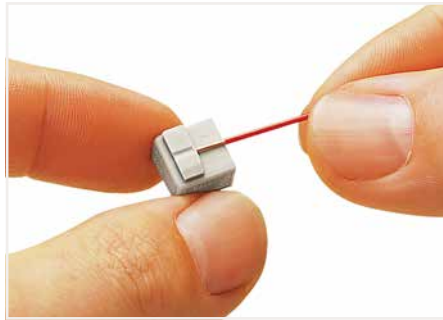
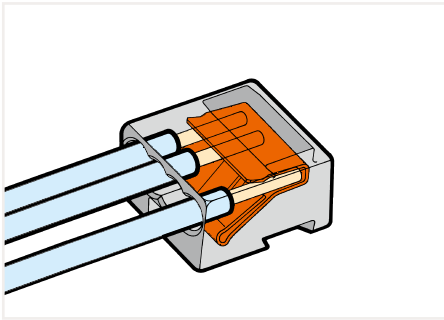

Strip solid conductors to 5 ... 6 mm (0.19 ... 0.23 inch).



Connector strips:
Assembling modular connectors into connector strips.

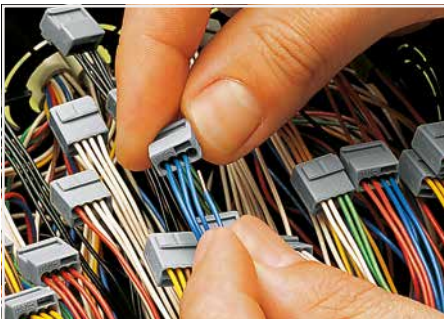

Termination: Insert stripped conductor until it hits back-stop.

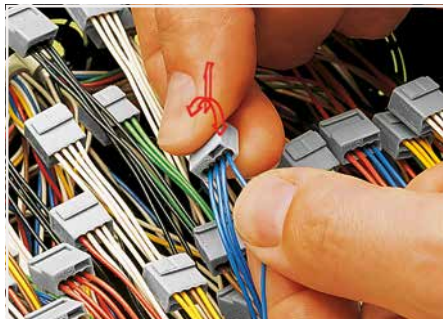

Removal: Hold conductor to be removed and twist alternately left and right while pulling the connector.



Testing

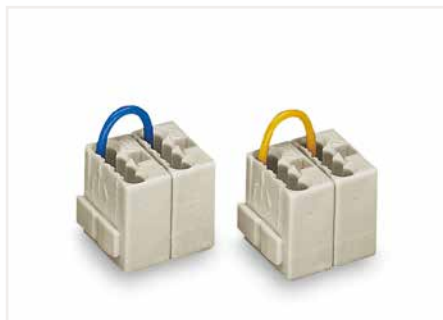

Commoned connector strips



PUSH WIRE® terminates the following copper conductors:
solid

Mounting Carrier; for MICRO PUSH WIRE® Junction Box Connectors; for DIN-35 Rail or Screw Mount 243 Series

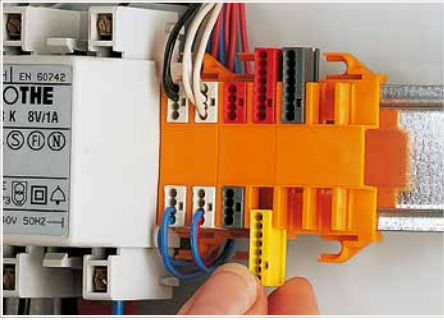

Inserting a MICRO junction box connector into the mounting carrier.

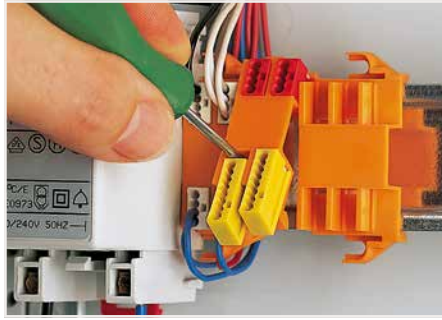

Removing a mounting carrier from the assembly.



Example of a residential door bell application – carriers mounted on a DIN-35 rail

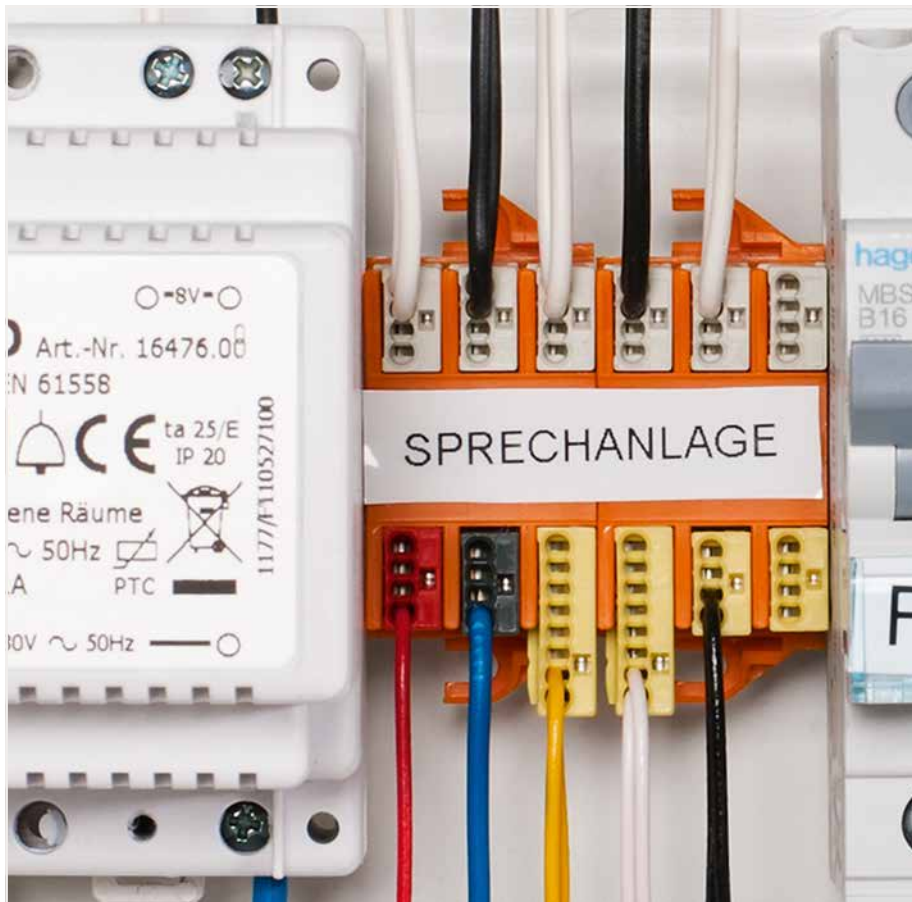

Example of a residential intercom application

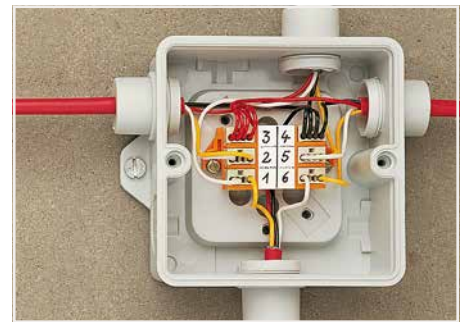

Typical application in a terminal box for burglar alarm – screw-mounted carrier

Quick Fix Mounting

Realizing MICRO PUSH WIRE® connectors for junction boxes are ideal for DIN-rail-mount panel applications, electrical installers have requested the ability to use them in distribution panels. These connectors provide easy connections for smaller conductors used in low-current applications. They are well-suited to terminating telephone-style conductors for connecting alarms, bells, door sensors, communication systems, etc.

The mounting carrier is WAGO's professional solution. It is available with mounting slots for 4 or 6 connectors.

Depending on the number of conductors, each mounting slot can accommodate a 4- or 8-conductor MICRO PUSH WIRE® junction box connector. The connectors simply snap into the mounting slots and are removable, allowing conductors to be exchanged during changeover.

The carrier is designed for easy mounting directly to the DIN-35 rail, or to a panel, via the screw-mount flanges provided on both sides. A large marking area for direct marking with a permanent felt-tip pen or for pre-printed self-adhesive marking strips is provided for clear circuit identification.

Sold & Serviced By:

 Toll Free Phone (877) SERV098
www.electromate.com
sales@electromate.com

MICRO PUSH WIRE® Connector for Junction Boxes Ø 0.8 mm and Ø 0.5 mm; 243 Series

Technical Data	
0.6 ... 0.8 mm Ø "s" ①	22 ... 20 AWG "s"
100 V/1,5 kV/2 ②	150 V, 7 A ③
I _N 6 A	150 V, 7 A ④
5 ... 6 mm / 0.2 ... 0.24 inch	

Technical Data	
0.6 ... 0.8 mm Ø "s" ①	22 ... 20 AWG "s"
100 V/1,5 kV/2 ②	150 V, 7 A ③
I _N 6 A	150 V, 7 A ④
5 ... 6 mm / 0.2 ... 0.24 inch	

Technical Data	
0.4 ... 0.5 mm Ø "s"	26 ... 24 AWG "s"
100 V/1,5 kV/2 ②	
I _N 6 A	150 V, 7 A ④
5 ... 6 mm / 0.2 ... 0.24 inch	



Dimensions in mm

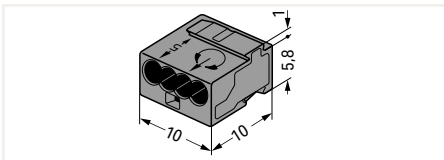

Dimensions in mm

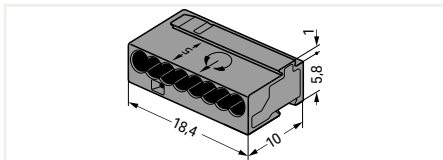

Dimensions in mm

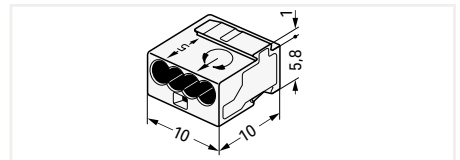

MICRO PUSH WIRE® connector for junction boxes; 4-wire connector; Continuous operating temperature (max.): 105 °C; Surrounding air temperature (max.): 60 °C

MICRO PUSH WIRE® connector for junction boxes; 8-wire connector; Continuous operating temperature (max.): 105 °C; Surrounding air temperature (max.): 60 °C

MICRO PUSH WIRE® connector for junction boxes; 4-wire connector; Continuous operating temperature (max.): 105 °C; Surrounding air temperature (max.): 60 °C

Color	Item No.	Pack. Unit
dark gray	243-204	1000 (100)
red	243-804	1000 (100)

Color	Item No.	Pack. Unit
dark gray	243-208	500 (50)
red	243-808	500 (50)

Color	Item No.	Pack. Unit
transparent	243-144	1000 (100)



Dimensions in mm

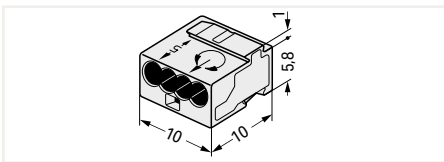

Dimensions in mm

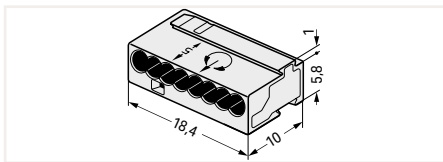

MICRO PUSH WIRE® connector for junction boxes; 4-wire connector; Continuous operating temperature (max.): 105 °C; Surrounding air temperature (max.): 60 °C

MICRO PUSH WIRE® connector for junction boxes; 8-wire connector; Continuous operating temperature (max.): 105 °C; Surrounding air temperature (max.): 60 °C

Color	Item No.	Pack. Unit
light gray	243-304	1000 (100)
red	243-504	1000 (100)

Color	Item No.	Pack. Unit
light gray	243-308	500 (50)
red	243-508	500 (50)

12

Mounting Carrier; for MICRO PUSH WIRE® Junction Box Connectors; for DIN-35 Rail or Screw Mount

243 Series

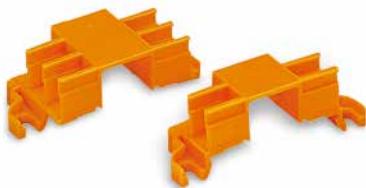

Mounting carrier; for 4 connectors

Color	Item No.	Pack. Unit
orange	243-112	50 (10)

Mounting carrier; for 6 connectors

orange	243-113	50 (10)
--------	---------	---------

Accessories; item-specific

Marking strip; 7 mm high; 6 self-adhesive strips per card; plain

white	243-110	100
-------	---------	-----



- When using conductors of the same diameter, 0.5 mm (24 AWG) or 1 mm (18 AWG) diameters are also possible.
- 100 V = rated voltage
1.5 kV = rated impulse voltage
2 = pollution degree (see Section 14)

Approvals and corresponding ratings, visit www.wago.com

Quick Fix Mounting

Realizing MICRO PUSH WIRE® connectors for junction boxes are ideal for DIN-rail-mount panel applications, electrical installers have requested the ability to use them in distribution panels. These connectors provide easy connections for smaller conductors used in low-current applications. They are well-suited to terminating telephone-style conductors for connecting alarms, bells, door sensors, communication systems, etc.

The mounting carrier is WAGO's professional solution. It is available with mounting slots for 4 or 6 connectors.

Depending on the number of conductors, each mounting slot can accommodate a 4- or 8-conductor MICRO PUSH WIRE® junction box connector. The connectors simply snap into the mounting slots and are removable, allowing conductors to be exchanged during changeover.

The carrier is designed for easy mounting directly to the DIN-35 rail, or to a panel, via the screw-mount flanges provided on both sides. A large marking area for direct marking with a permanent felt-tip pen or for pre-printed self-adhesive marking strips is provided for clear circuit identification.



The 243 Series can be used in both communication and alarm systems according to the VdS (German Association of Property Insurers) guidelines.

No general approval is given to PUSH WIRE® connectors by the VdS association. The connectors must be tested together with the different parts of the system.

The requirements for connectors are specified in the VdS guidelines for junction boxes (VdS 2116) in section 9.8: "The junction box connectors must be designed to guarantee a reliable and stable connection."

The verification of the fulfillment of these requirements is documented in the VDE test report No. 2574-1440-4031 for the insulated 243 Series PUSH WIRE® Connectors.

COMPACT Splicing Connectors for All Conductor Types

221 Series

Description and Installation

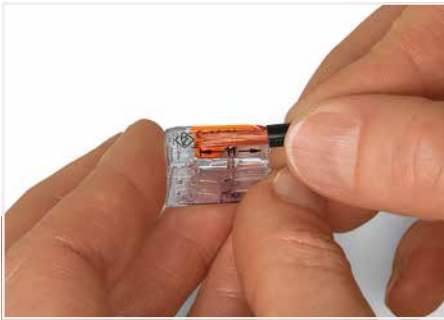

Strip conductor to 11 mm (0.43 inch).



Termination: Lift the lever to open the clamping unit and insert a stripped conductor.

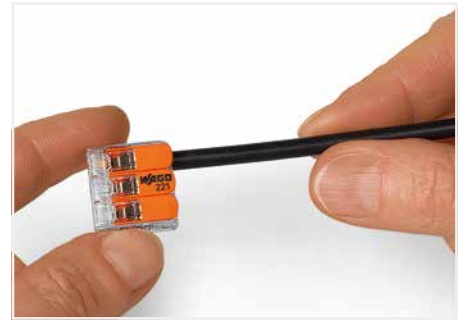

Then, lower the lever to close the clamp.



Wiring fine-stranded conductors in a junction box.



Custom low-voltage lighting system

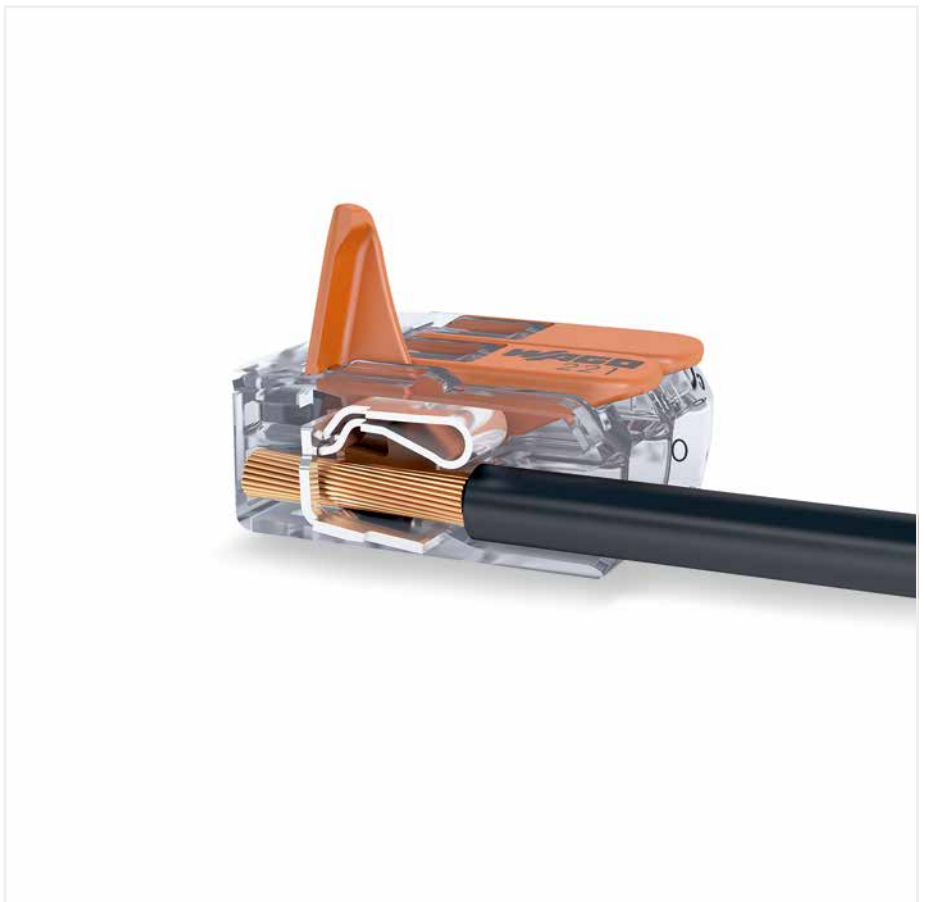

12



Wiring fine-stranded conductors in a junction box for in-floor heating.



Lighting distribution in ceiling canopy



Pendant light connection in suspended ceilings

CAGE CLAMP® terminates the following copper conductors:
solid stranded

fine-stranded, also with tinned single strands

fine-stranded, tip-bonded

COMPACT Splicing Connector for All Conductor Types

4 mm²; 221 Series

Technical Data	
0.2 ... 4 mm ² "s+str"	24 ... 12 AWG
0.14 ... 4 mm ² "f-st"	
450 V/4 kV/2 ①	600 V, 20 A ^②
I _N 32 A	
11 mm / 0.43 inch	

Technical Data	
0.2 ... 4 mm ² "s+str"	24 ... 12 AWG
0.14 ... 4 mm ² "f-st"	
450 V/4 kV/2 ①	600 V, 20 A ^②
I _N 32 A	
11 mm / 0.43 inch	

① 450 V = rated voltage
 4 kV = rated impulse voltage
 2 = pollution degree (see Section 14)

Approvals and corresponding ratings, visit www.wago.com



Dimensions in mm

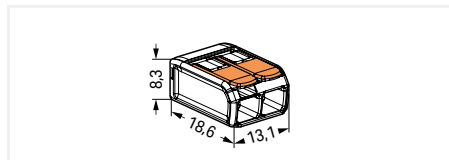

Dimensions in mm

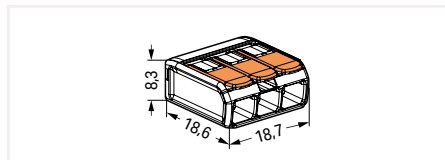

COMPACT splicing connector for all conductor types; 2-wire connector; with levers; Continuous operating temperature (max.): 105 °C; Surrounding air temperature: 85 °C (T85)

Item No.	Pack. Unit
221-412	1000 (100)

COMPACT splicing connector for all conductor types; 3-wire connector; with levers; Continuous operating temperature (max.): 105 °C; Surrounding air temperature: 85 °C (T85)

Item No.	Pack. Unit
221-413	500 (50)



Compact, lever-operated splicing connectors:
 Tool-free connection of up to five stripped, fine-stranded conductors from 0.14 ... 4 mm², as well as solid or stranded conductors from 0.2 ... 4 mm² (24 ... 12 AWG).

How these work:
 Pull up an orange lever to open the clamping unit. Then insert the conductor and push the lever back down, flush with the connector housing.

Safety:
 The specially designed rest position of the lever reliably prevents accidental unclamping of a connected conductor.
 Application safety, for any type of conductor (solid, stranded, fine-stranded), is confirmed by approvals like ENEC or UL.

ENEC is the European mark for electrical products that demonstrates compliance with European safety standards. The ENEC mark is subjected to the same EN standards as the VDE mark.

While the VDE mark is only permitted in Germany, the ENEC mark is accepted in more than 20 European countries.



Dimensions in mm

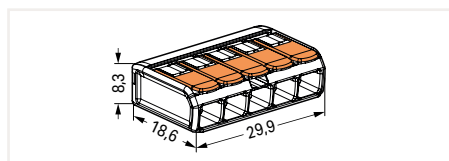

COMPACT splicing connector for all conductor types; 5-wire connector; with levers; Continuous operating temperature (max.): 105 °C; Surrounding air temperature: 85 °C (T85)

Item No.	Pack. Unit
221-415	250 (25)

Mounting Carrier 221 Series Installation



Inserting a connector into the mounting carrier.

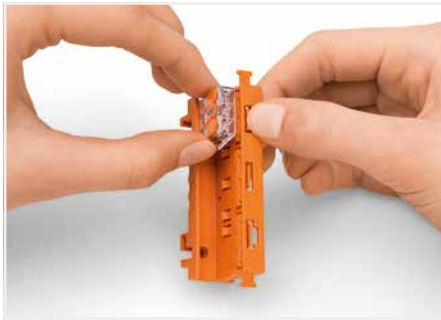

Removing a connector from the mounting carrier.



Removing a conductor.



Testing connectors via test slots on top of the carrier.

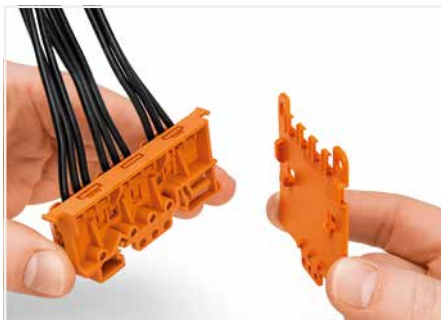

Securing a strain relief plate (222-505) to the mounting carrier.

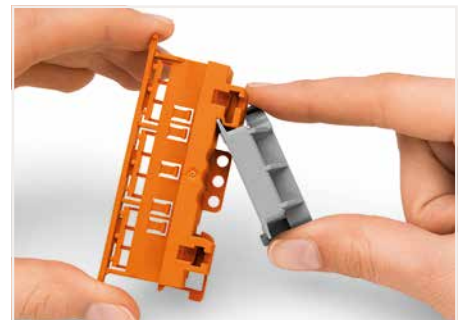

Snapping the angled DIN-rail adapter (222-510) onto the mounting carrier.



Strain relief via cable ties on the mounting carrier (transverse to the connectors' wiring direction) – clamping units labeled via marking strips (210-334)



Vertical mounting with strain relief plate on DIN-35 rail



Horizontal mounting on DIN-35 rail using an angled DIN-rail adapter

12



Horizontal screw mounting with strain relief plate on a flat surface



Vertical screw mounting with strain relief plate on a flat surface

Mounting Carrier 221 Series

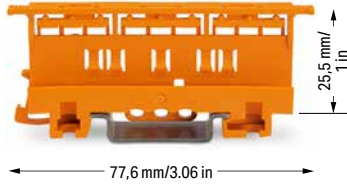

Mounting carrier; for 2-, 3- and 5-wire splicing connectors (4 mm²); 17.5 mm wide

Color	Item No.	Pack. Unit
orange	221-500	50 (10)

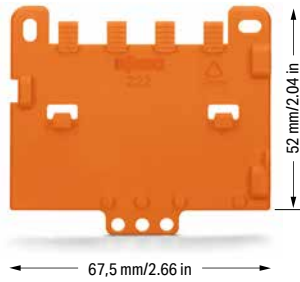

Strain relief plate; for mounting carrier (221 or 222 Series); snaps on to mounting carrier; 4 mm thick

Color	Item No.	Pack. Unit
orange	222-505	50 (10)

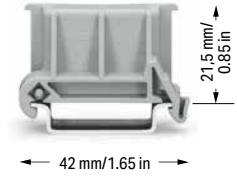

Angled DIN-rail adapter; in combination with mounting carrier (221-500 or 222-500) for DIN-35 rail mounting; 18.5 mm wide

Color	Item No.	Pack. Unit
gray	222-510	50 (10)

Accessories; item-specific

Marking strip; 5 mm high; 48 self-adhesive strips per card; plain

Color	Item No.	Pack. Unit
white	210-334	100

Mounting Carrier; for Single Connectors

221 Series

Installation



Inserting a connector into the mounting carrier.



Removing a connector from the mounting carrier.

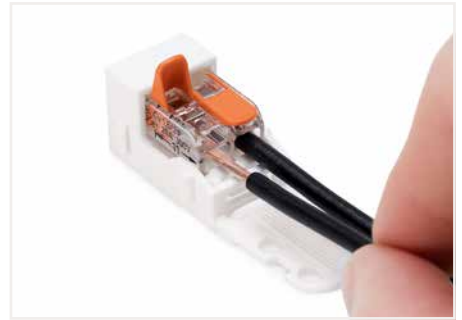

Inserting a conductor.



Use a cable tie to secure the conductors to the strain relief plate.



Labeling the mounting carrier.



Testing a connector mounted on the carrier via test slot.



The strain relief plate can be removed.



Horizontal screw mounting



Vertical screw mounting

12



Horizontal mounting via snap-in foot



Vertical mounting via snap-in foot



Connecting a light to the mains.

Mounting Carrier; for Single Connectors 221 Series



Dimensions in mm

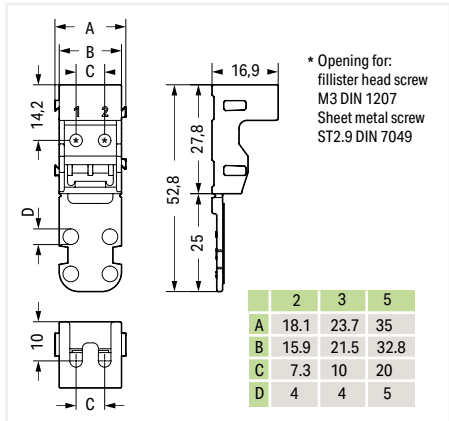

Mounting carrier; for 2-wire connectors (4 mm²); for screw mounting
Dimensions from the surface (mm) W x H x D
18.1 x 16.9 x 52.8

Color	Item No.	Pack. Unit
○ white	221-502	50 (10)
● black	221-502/000-004	50 (10)

Dimensions in mm

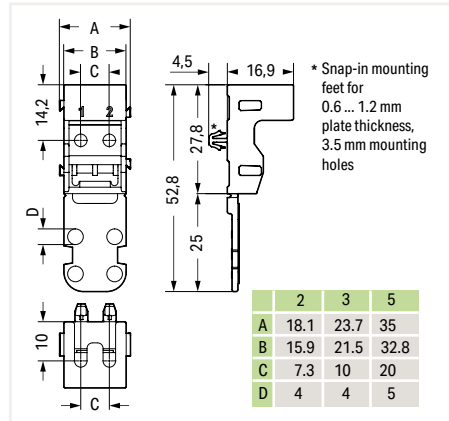

Mounting carrier; for 3-wire connectors (4 mm²); for screw mounting
Dimensions from the surface (mm) W x H x D
18.1 x 16.9 x 52.8

Color	Item No.	Pack. Unit
○ white	221-503	50 (10)
● black	221-503/000-004	50 (10)

Dimensions in mm

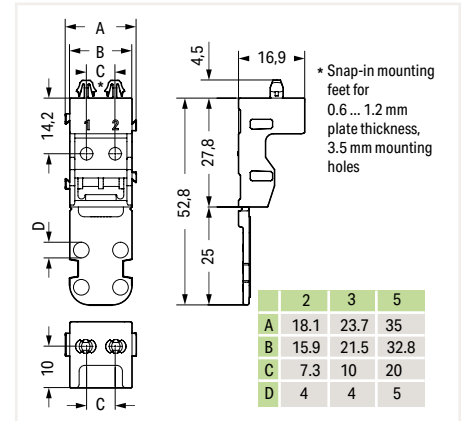

Mounting carrier; for 5-wire connectors (4 mm²); for screw mounting
Dimensions from the surface (mm) W x H x D
18.1 x 16.9 x 52.8

Color	Item No.	Pack. Unit
○ white	221-505	50 (10)
● black	221-505/000-004	50 (10)

Mounting carrier; for 2-wire connectors (4 mm²); with snap-in mounting foot for horizontal mounting
Dimensions from the surface (mm) W x H x D
18.1 x 16.9 (+ 4.5 snap-in mounting foot) x 52.8

○ white	221-512	50 (10)
● black	221-512/000-004	50 (10)

Mounting carrier; for 3-wire connectors (4 mm²); with snap-in mounting foot for horizontal mounting
Dimensions from the surface (mm) W x H x D
18.1 x 16.9 (+ 4.5 snap-in mounting foot) x 52.8

○ white	221-513	50 (10)
● black	221-513/000-004	50 (10)

Mounting carrier; for 5-wire connectors (4 mm²); with snap-in mounting foot for horizontal mounting
Dimensions from the surface (mm) W x H x D
18.1 x 16.9 (+ 4.5 snap-in mounting foot) x 52.8

○ white	221-515	50 (10)
● black	221-515/000-004	50 (10)

Mounting carrier; for 2-wire connectors (4 mm²); with snap-in mounting foot for vertical mounting
Dimensions from the surface (mm) W x H x D
18.1 x 52.8 (+ 4.5 snap-in mounting foot) x 16.9

○ white	221-522	50 (10)
● black	221-522/000-004	50 (10)

Mounting carrier; for 3-wire connectors (4 mm²); with snap-in mounting foot for vertical mounting
Dimensions from the surface (mm) W x H x D
18.1 x 52.8 (+ 4.5 snap-in mounting foot) x 16.9

○ white	221-523	50 (10)
● black	221-523/000-004	50 (10)

Mounting carrier; for 5-wire connectors (4 mm²); with snap-in mounting foot for vertical mounting
Dimensions from the surface (mm) W x H x D
18.1 x 52.8 (+ 4.5 snap-in mounting foot) x 16.9

○ white	221-525	50 (10)
● black	221-525/000-004	50 (10)

More information on dimensions is available upon request.

Accessories; item-specific

Marking strip; 5 mm high; 48 self-adhesive strips per card; plain

white	210-334	100
-------	---------	-----

COMPACT Splicing Connectors for All Conductor Types

221 Series

Description and Installation

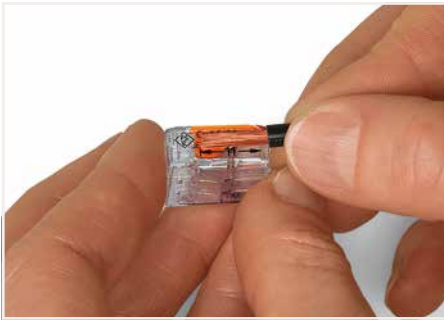

Strip conductor to 12 ... 14 mm (0.47 ... 0.55 inch).



Termination: Lift the lever to open the clamping unit and insert a stripped conductor.

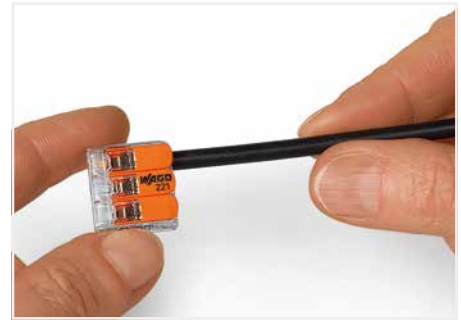

Then, lower the lever to close the clamp.



Wiring fine-stranded conductors in a junction box.



Custom low-voltage lighting system

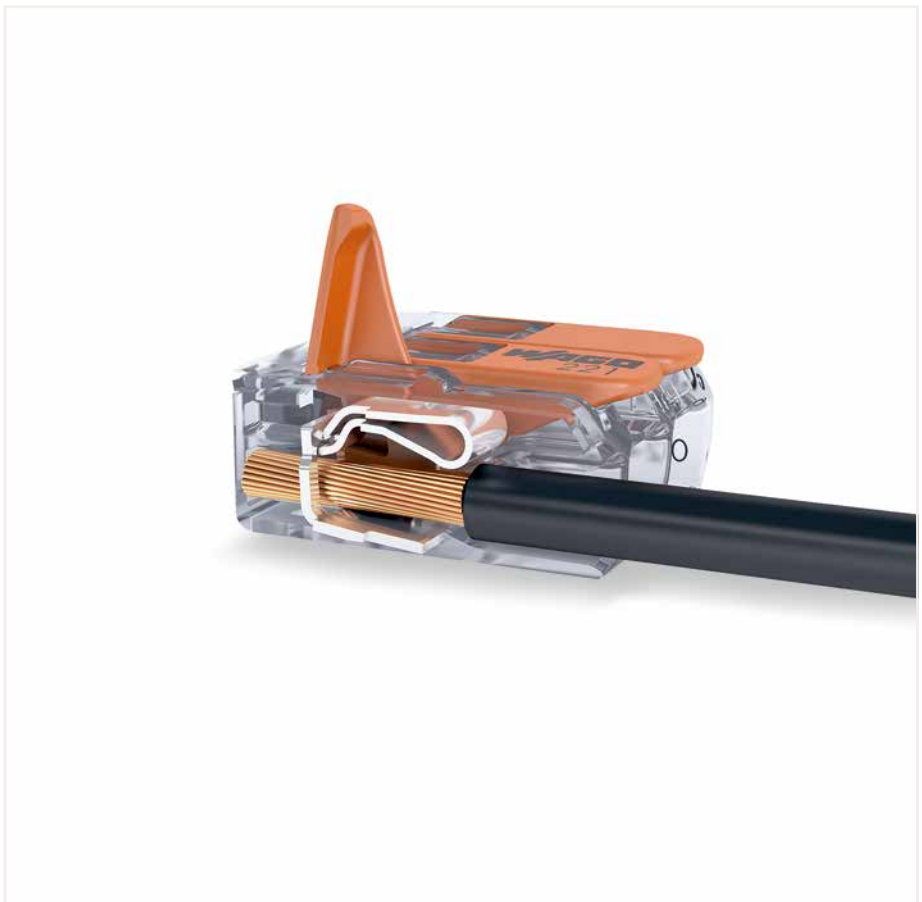

12



Wiring fine-stranded conductors in a junction box for in-floor heating.



Lighting distribution in ceiling canopy



Pendant light connection in suspended ceilings

CAGE CLAMP® terminates the following copper conductors:
solid stranded

fine-stranded, also with tinned single strands

fine-stranded, tip-bonded

COMPACT Splicing Connector for All Conductor Types and Mounting Carrier

6 mm²; 221 Series

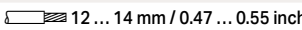
Technical Data	
0.5 ... 6 mm ²	20 ... 10 AWG
450 V/4 kV/2 ①	600 V, 20 A-②
I _N 41 A	
 12 ... 14 mm / 0.47 ... 0.55 inch	

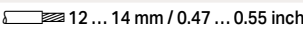
Technical Data	
0.5 ... 6 mm ²	20 ... 10 AWG
450 V/4 kV/2 ①	600 V, 20 A-②
I _N 41 A	
 12 ... 14 mm / 0.47 ... 0.55 inch	

- ① 450 V = rated voltage
4 kV = rated impulse voltage
2 = pollution degree (see Section 14)

Approvals and corresponding ratings, visit www.wago.com



Dimensions in mm

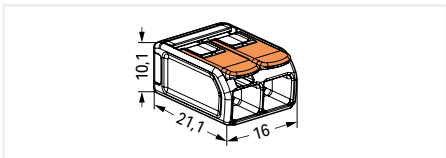

COMPACT splicing connector for all conductor types; 2-wire connector; with levers; Continuous operating temperature (max.): 105 °C; Surrounding air temperature: 85 °C (T85)

Item No.	Pack. Unit
221-612	500 (50)

Dimensions in mm

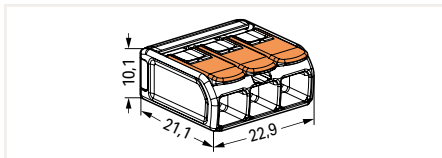

COMPACT splicing connector for all conductor types; 3-wire connector; with levers; Continuous operating temperature (max.): 105 °C; Surrounding air temperature: 85 °C (T85)

Item No.	Pack. Unit
221-613	300 (30)



Compact, lever-operated splicing connectors: Connect up to five stripped conductors from 0.5 to 6 mm² (20 ... 10 AWG) – without tools!

How these work:

Pull up one of the orange operating levers to open the clamping unit. Then insert the conductor and push the lever back down, flush with the connector housing.

Safety:

The lever's specially designed rest position reliably prevents accidental unclamping of a connected conductor. Application safety, for any type of conductor (solid, stranded, fine-stranded), is confirmed by approvals like ENEC or UL.

ENEC is the European mark for electrical products that demonstrates compliance with European safety standards. The ENEC mark is subjected to the same EN standards as the VDE mark.

While the VDE mark is only permitted in Germany, the ENEC mark is accepted in more than 20 European countries.



Dimensions in mm

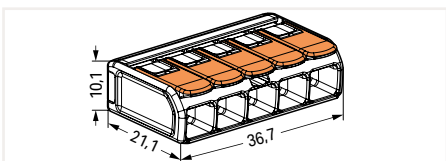

COMPACT splicing connector for all conductor types; 5-wire connector; with levers; Continuous operating temperature (max.): 105 °C; Surrounding air temperature: 85 °C (T85)

Item No.	Pack. Unit
221-615	150 (15)

Mounting carrier; for 2-, 3- and 5-wire splicing connectors (6 mm²); 19.3 mm wide

Color	Item No.	Pack. Unit
orange	221-510	50 (10)

Accessories; item-specific

Marking strip; 5 mm high; 48 self-adhesive strips per card; plain

	white	210-334	100
---	-------	---------	-----

Sold & Serviced By:

 Toll Free Phone (877) SERV098
www.electromate.com
sales@electromate.com

CLASSIC Splicing Connectors for All Conductor Types

222 Series

Description and Installation

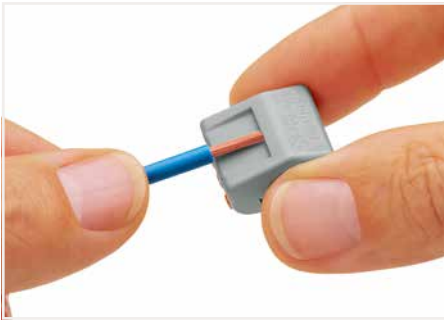

Strip conductor to 9 ... 10 mm (0.35 ... 0.39 inch).

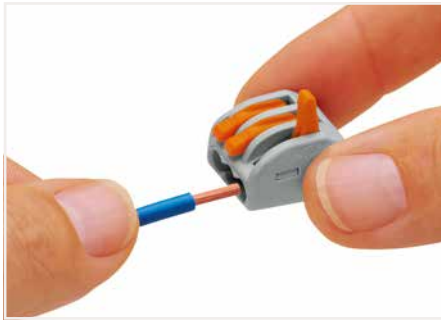

Termination: Lift the lever to open the clamping unit and insert a stripped conductor.

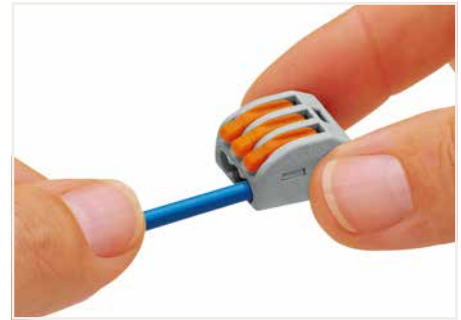

Then, lower the lever to close the clamp.

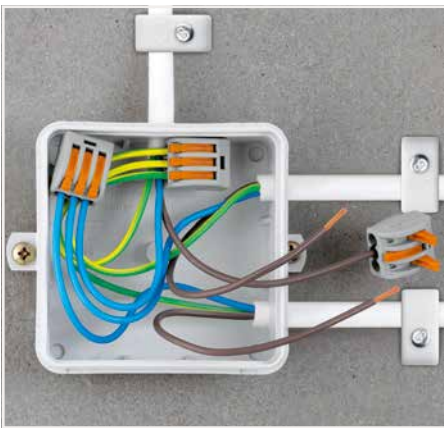

Wiring fine-stranded conductors in a junction box.

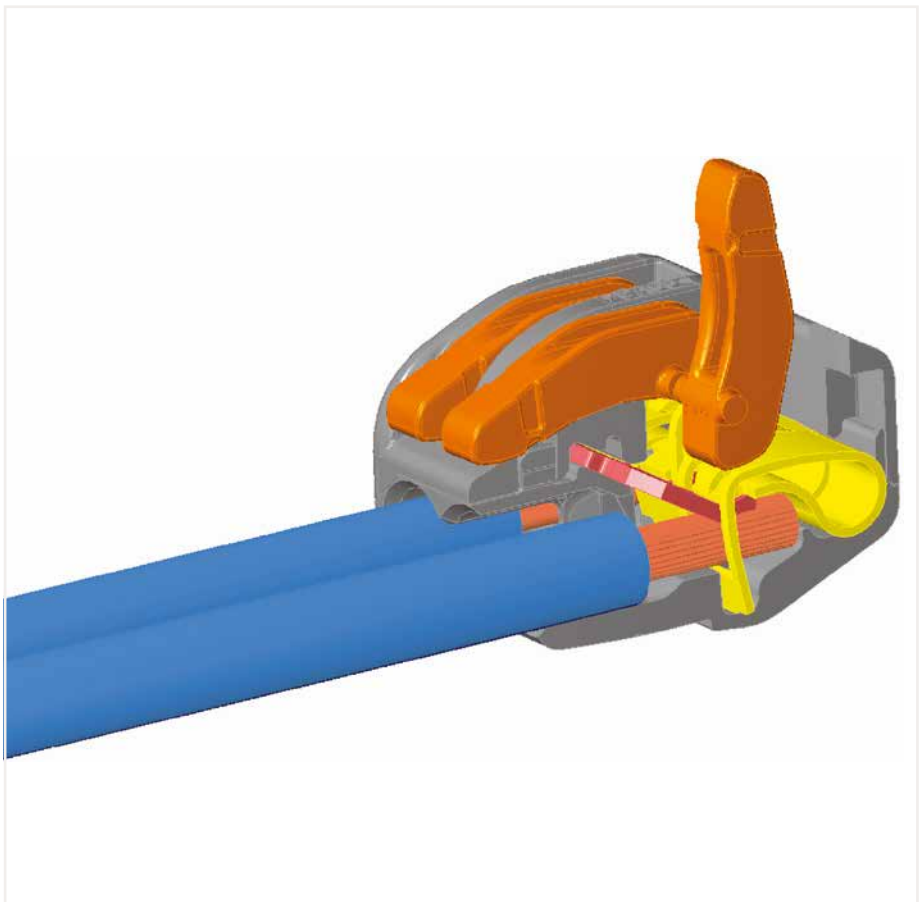

12



Testing the wired connectors.

CAGE CLAMP® terminates the following copper conductors:
solid stranded

fine-stranded, also with tinned single strands

fine-stranded, tip-bonded

fine-stranded, with ferrule (gastight crimped)

fine-stranded, with pin terminal (gastight crimped)

For aluminum conductors, see notes in Section 14. With ferruled conductors, it is necessary to use a terminal block one size smaller than the conductor's nominal cross section.

CLASSIC Splicing Connector for All Conductor Types 2.5 mm²; 222 Series

Technical Data

0.08 ... 2.5 mm ² "s+str"	28 ... 12 AWG "s+st"
0.08 ... 4 mm ² "f-st"	28 ... 12 AWG "f-st"
400 V/4 kV/2 ①	600 V, 20 A ②-⑤
I _N 32 A	
9 ... 10 mm / 0.35 ... 0.39 inch	

Technical Data

0.08 ... 2.5 mm ² "s+str"	28 ... 12 AWG "s+st"
0.08 ... 4 mm ² "f-st"	28 ... 12 AWG "f-st"
400 V/4 kV/2 ①	600 V, 20 A ②-⑤
I _N 32 A	
9 ... 10 mm / 0.35 ... 0.39 inch	

- ① In grounded power lines
400 V = rated voltage
4 kV = rated impulse voltage
2 = pollution degree
(see Section 14)

Approvals and corresponding ratings, visit www.wago.com



Dimensions in mm

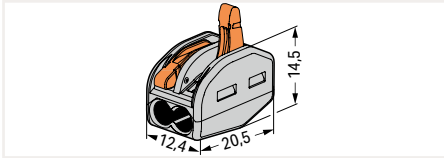

Splicing connector for all conductor types; 2-wire connector; with levers; Continuous operating temperature (max.): 85 °C; Surrounding air temperature (max.): 40 °C

Color	Item No.	Pack. Unit
○ gray	222-412	500 (50)



Dimensions in mm

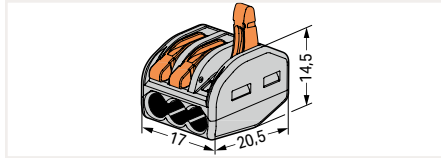

Splicing connector for all conductor types; 3-wire connector; with levers; Continuous operating temperature (max.): 85 °C; Surrounding air temperature (max.): 40 °C

Color	Item No.	Pack. Unit
○ gray	222-413	500 (50)



Compact, lever-operated splicing connectors:
Tool-free connection of up to five stripped, fine-stranded conductors from 0.08 ... 4 mm² (28 ... 12 AWG), as well as solid or stranded conductors up to 2.5 mm² (12 AWG).

How these work:

Pull up one of the orange operating levers to open the clamping unit so that the lever engages and keeps the clamp in its opened position. Then insert the conductor and push the lever back down, flush with the connector housing.

Safety:

The lever's specially designed rest position reliably prevents accidental unclamping of a connected conductor. Application safety, for any type of conductor (solid, stranded, fine-stranded), is confirmed by approvals like ENEC or UL.

ENEC is the European mark for electrical products that demonstrates compliance with European safety standards. The ENEC mark is subjected to the same EN standards as the VDE mark.

While the VDE mark is only permitted in Germany, the ENEC mark is accepted in more than 20 European countries.



Dimensions in mm

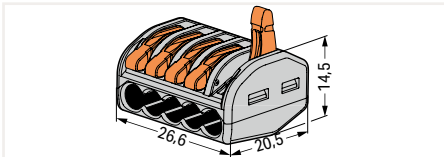

Splicing connector for all conductor types; 5-wire connector; with levers; Continuous operating temperature (max.): 85 °C; Surrounding air temperature (max.): 40 °C

Color	Item No.	Pack. Unit
○ gray	222-415	400 (40)

Mounting Carrier 222 Series Installation



Horizontal mounting on DIN-35 rail using an angled DIN-rail adapter



Horizontal mounting with strain relief plate on DIN-35 rail using an angled DIN-rail adapter

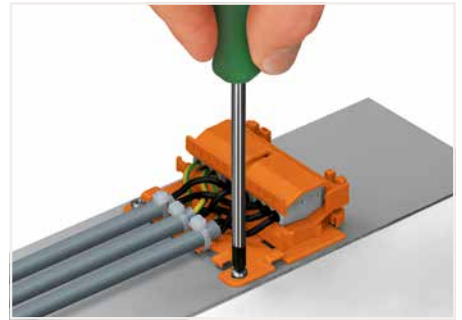

Horizontal screw mounting with strain relief plate on a flat surface



Vertical mounting with strain relief plate on DIN-35 rail; Marking clamping units via marking strips.



Strain relief via cable ties on the mounting carrier (transverse to the connectors' wiring direction); Molded marking clamping units

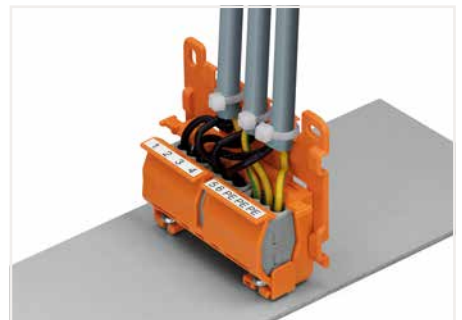

Mounting carrier with strain relief plate mounted vertically on a plate; Round cable secured via strain relief lug.



Snapping the lateral connector safety lock onto the mounting carrier.



Securing a strain relief plate to the mounting carrier.

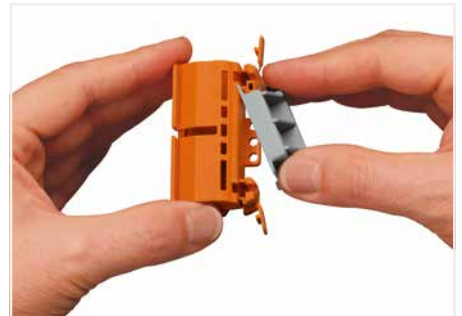

Snapping the angled DIN-rail adapter onto the mounting carrier.

Sold & Serviced By:

 Toll Free Phone (877) SERV098
www.electromate.com
sales@electromate.com

Mounting Carrier 222 Series



Mounting carrier; for 2-, 3- and 5-wire splicing connectors; 22 mm wide

Color	Item No.	Pack. Unit
orange	222-500	50 (10)

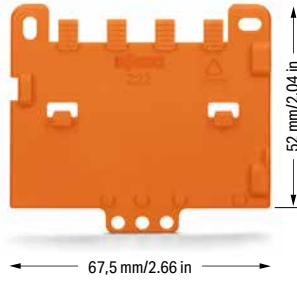

Strain relief plate; for mounting carrier (221 or 222 Series); snaps on to mounting carrier; 4 mm thick

Color	Item No.	Pack. Unit
orange	222-505	50 (10)

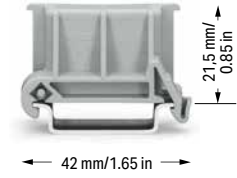

Angled DIN-rail adapter; in combination with mounting carrier (221-500 or 222-500) for DIN-35 rail mounting; 18.5 mm wide

Color	Item No.	Pack. Unit
gray	222-510	50 (10)

Accessories; item-specific

Marking strip; 5 mm high; 48 self-adhesive strips per card; plain

Color	Item No.	Pack. Unit
white	210-334	100



Lighting Connectors; 224 Series

Lighting Side and Installation Side

Description and Installation

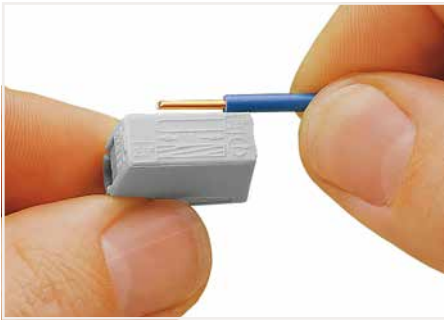

Strip conductor to 9 ... 11 mm (0.35 ... 0.43 inch).

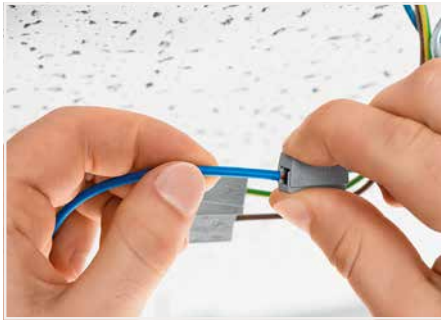

To connect: Press button fully, insert stripped conductor into square entry and release.

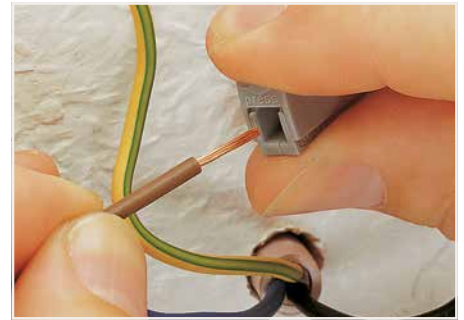

To remove: Press button and withdraw conductor.

Lighting side

CAGE CLAMP® terminates the following copper conductors:

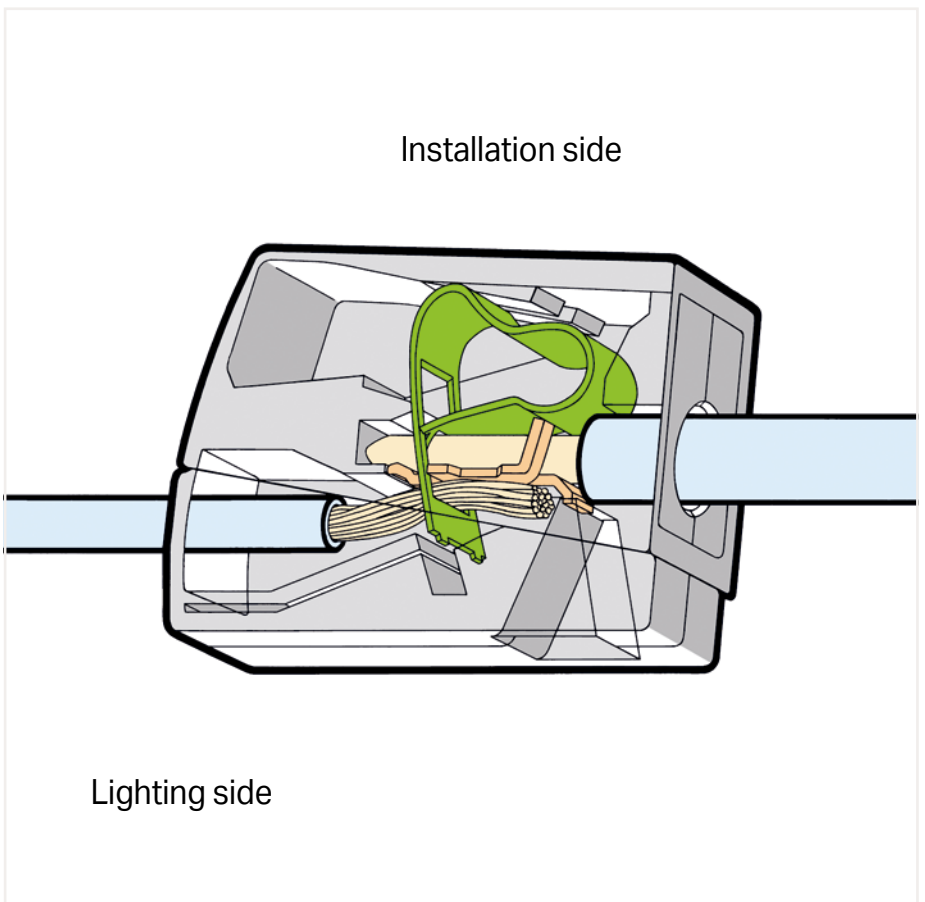
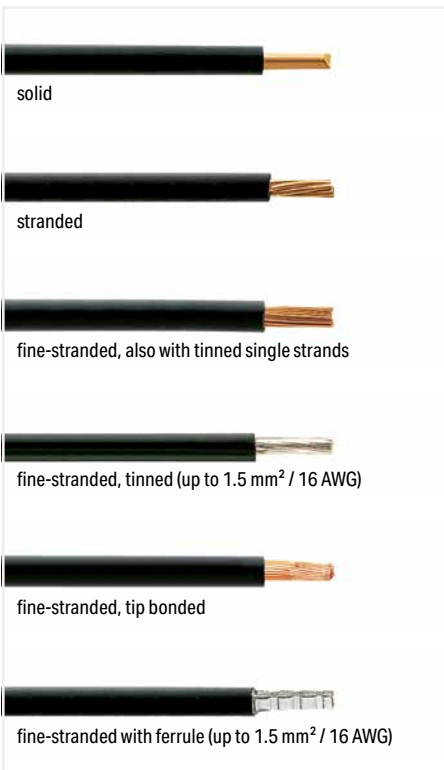

12

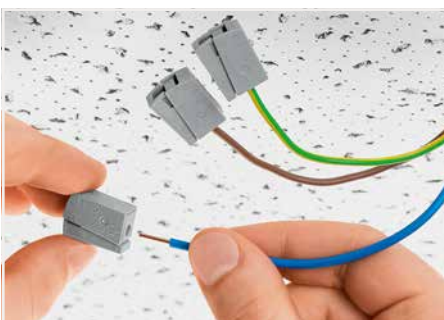

To connect: Insert stripped solid conductor into circular entry and push until it hits the backstop.

Installation side



PUSH WIRE® terminates the following copper conductors:
solid

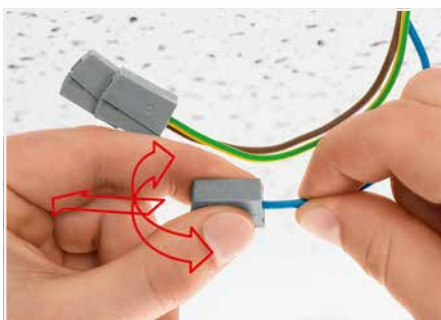

To remove: Hold conductor to be removed and twist alternately left and right while slightly pulling the connector.



Testing via separate test ports.

Lighting Connector and Service Connector

2.5 mm², 224 Series

Technical Data	
Installation side	
1 ... 2.5 mm ² "s"	14 ... 12 AWG
Lighting side	
0.5 ... 2.5 mm ² "s+f-st"	20 ... 16 AWG
400 V/4 kV/2	300 V, 20 AⓈ
I _N 24 A	300 V, 20 AⓈ
9 ... 11 mm / 0.35 ... 0.43 inch	

Technical Data	
Installation side	
1 ... 2.5 mm ² "s"	16 ... 14 AWG
Lighting side	
0.5 ... 2.5 mm ² "s+f-st"	20 ... 16 AWG
400 V/4 kV/2	300 V, 20 AⓈ
I _N 24 A	300 V, 20 AⓈ
9 ... 11 mm / 0.35 ... 0.43 inch	

Technical Data	
0.5 ... 2.5 mm ² "s+f-st"	20 ... 16 AWG
400 V/4 kV/2	300 V, 20 AⓈ
I _N 24 A	
9 ... 11 mm / 0.35 ... 0.43 inch	



Dimensions in mm

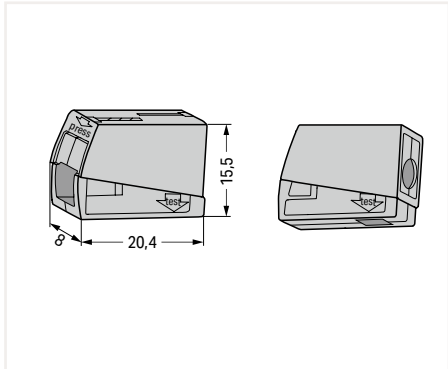

Dimensions in mm

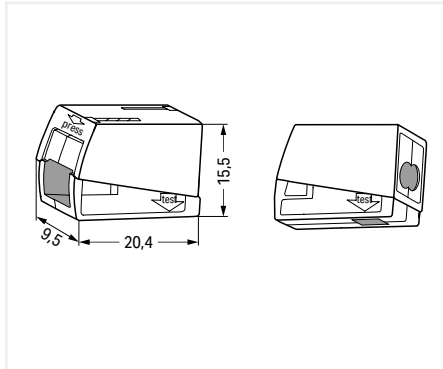

Dimensions in mm

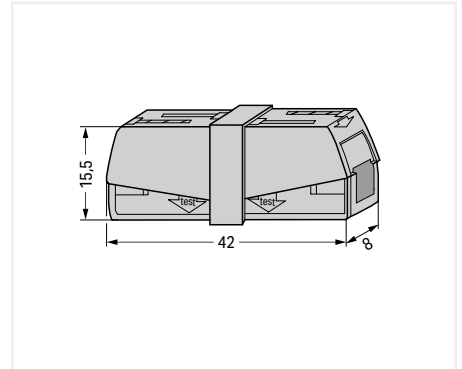

Lighting connector; Standard version; Continuous operating temperature (max.): 105 °C; Surrounding air temperature (max.): 60 °C

Color	Item No.	Pack. Unit
○ gray	224-101	1000 (100)

2-wire lighting connector; Standard version; Continuous operating temperature (max.): 105 °C; Surrounding air temperature (max.): 60 °C

Color	Item No.	Pack. Unit
○ white	224-112	1000 (100)

Service connector

Color	Item No.	Pack. Unit
○ gray	224-201	50

Lighting connector; Version for increased continuous operating temperature: 120 °C; Surrounding air temperature (max.): 75 °C

Color	Item No.	Pack. Unit
● black	224-104	100

2-wire lighting connector; Version for increased continuous operating temperature: 120 °C; Surrounding air temperature (max.): 75 °C

Color	Item No.	Pack. Unit
● black	224-114	100

Accessories; 224 Series

Syringe; contains 20 ml "Alu-Plus" Contact Paste

Item No.	Pack. Unit
249-130	20 (5)



Splicing Connector Set 887 Series



Splicing connector set; Vario-T-BOXX; 222, 224, 243, 2273 Series

Item No.	Pack. Unit
887-910	1

Contains:

COMPACT PUSH WIRE® Connectors for Junction Boxes

white	2 x 0.5 ... 2.5 mm ²	2273-202	100
orange	3 x 0.5 ... 2.5 mm ²	2273-203	100
yellow	5 x 0.5 ... 2.5 mm ²	2273-205	100
light gray	8 x 0.5 ... 2.5 mm ²	2273-208	50

Splicing Connectors

gray	3 x 0.08 ... 4 mm ²	222-413	50
gray	5 x 0.08 ... 4 mm ²	222-415	40

Lighting Connectors

white	1 ... 2.5 mm ² "s"	224-101	100
-------	-------------------------------	---------	-----

MICRO PUSH WIRE® Connectors for Junction Boxes

dark gray	4 x 0.6 ... 0.8 mm Ø	243-204	100
red	4 x 0.6 ... 0.8 mm Ø	243-804	100
dark gray	8 x 0.6 ... 0.8 mm Ø	243-208	50

Mounting Carrier for 6 connectors

243-113	10
---------	----

Splicing connector set; Vario-T-BOXX; 221, 224, 243, 773, 2273 Series

Item No.	Pack. Unit
887-912	1

Contains:

COMPACT PUSH WIRE® Connectors for Junction Boxes

orange	3 x 0.5 ... 2.5 mm ²	2273-203	100
yellow	5 x 0.5 ... 2.5 mm ²	2273-205	100
light gray	8 x 0.5 ... 2.5 mm ²	2273-208	50

COMPACT Splicing Connectors

transparent	3 x 0.14 ... 4 mm ²	221-413	50
transparent	5 x 0.14 ... 4 mm ²	221-415	25

Lighting Connectors

white	2x 1 ... 2.5 mm ² "s"	224-112	100
-------	----------------------------------	---------	-----

PUSH WIRE® Connectors for Junction Boxes

red	1.5 ... 4 mm ² "s"	773-604	100
-----	-------------------------------	---------	-----

MICRO PUSH WIRE® Connectors for Junction Boxes

dark gray	4 x 0.6 ... 0.8 mm Ø	243-204	100
red	4 x 0.6 ... 0.8 mm Ø	243-804	100
dark gray	8 x 0.6 ... 0.8 mm Ø	243-208	50

Mounting Carrier for 6 connectors

243-113	10
---------	----

Splicing connector set; L-BOXX® 102; 221, 224, 243, 773, 2273 Series

Item No.	Pack. Unit
887-913	1

Contains:

COMPACT PUSH WIRE® Connectors for Junction Boxes

orange	3 x 0.5 ... 2.5 mm ²	2273-203	100
yellow	5 x 0.5 ... 2.5 mm ²	2273-205	100
light gray	8 x 0.5 ... 2.5 mm ²	2273-208	50

COMPACT Splicing Connectors

transparent	2 x 0.14 ... 4 mm ²	221-412	100
transparent	3 x 0.14 ... 4 mm ²	221-413	50
transparent	5 x 0.14 ... 4 mm ²	221-415	25

Lighting Connectors

white	2 x 1 ... 2.5 mm ² "s"	224-112	100
-------	-----------------------------------	---------	-----

PUSH WIRE® Connectors for Junction Boxes

red	2.5 ... 6 mm ² "s+st"	773-173	50
-----	----------------------------------	---------	----

MICRO PUSH WIRE® Connectors for Junction Boxes

dark gray	4 x 0.6 ... 0.8 mm Ø	243-204	100
dark gray	8 x 0.6 ... 0.8 mm Ø	243-208	50

Mounting Carrier for 6 connectors

orange	221-500	4
--------	---------	---



Splicing connector set; L-BOXX® 102; 221 Series; 4 mm² and 6 mm²

Item No.	Pack. Unit
887-921	1

Contains:

COMPACT PUSH WIRE® Connectors for Junction Boxes

transparent	3 x 0.5 ... 6 mm ²	221-613	30
-------------	-------------------------------	---------	----

COMPACT Splicing Connectors

transparent	2 x 0.14 ... 4 mm ²	221-412	100
transparent	3 x 0.14 ... 4 mm ²	221-413	250
transparent	5 x 0.14 ... 4 mm ²	221-415	25

Mounting Carrier

orange	221-500	10
--------	---------	----

12



Splicing connector set; L-BOXX® 102; 221, 2273 Series

	Item No.	Pack. Unit
	887-917	1

Contains:

COMPACT PUSH WIRE® Connectors for Junction Boxes			
white	2 x 0.5 ... 2.5 mm ²	2273-202	100
orange	3 x 0.5 ... 2.5 mm ²	2273-203	100
red	4 x 0.5 ... 2.5 mm ²	2273-204	100
yellow	5 x 0.5 ... 2.5 mm ²	2273-205	100
light gray	8 x 0.5 ... 2.5 mm ²	2273-208	50

COMPACT Splicing Connectors			
transparent	2 x 0.14 ... 4 mm ²	221-412	100
transparent	3 x 0.14 ... 4 mm ²	221-413	100
transparent	5 x 0.14 ... 4 mm ²	221-415	25

Mounting Carrier orange	2273-500	2
----------------------------	----------	---

Mounting Carrier orange	221-500	2
----------------------------	---------	---



Splicing connector set; L-BOXX® 102; 221 Series

	Item No.	Pack. Unit
	887-918	1

Contains:

COMPACT Splicing Connectors			
transparent	2 x 0.14 ... 4 mm ²	221-412	100
transparent	3 x 0.14 ... 4 mm ²	221-413	250
transparent	5 x 0.14 ... 4 mm ²	221-415	50

Mounting Carrier orange	221-500	10
----------------------------	---------	----

Splicing connector set; L-BOXX® 102; 221 Series; 4 mm² and 6 mm²

	Item No.	Pack. Unit
	887-920	1

Contains:

COMPACT PUSH WIRE® Connectors for Junction Boxes			
transparent	2 x 0.5 ... 6 mm ²	221-612	50
transparent	3 x 0.5 ... 6 mm ²	221-613	30
transparent	5 x 0.5 ... 6 mm ²	221-615	5

COMPACT Splicing Connectors			
transparent	2 x 0.14 ... 4 mm ²	221-412	200
transparent	3 x 0.14 ... 4 mm ²	221-413	150
transparent	5 x 0.14 ... 4 mm ²	221-415	25

Mounting Carrier orange	221-510	2
----------------------------	---------	---

Mounting Carrier orange	221-500	2
----------------------------	---------	---

Splicing Connector Set 887 Series



Splicing connector set; L-BOXX® Mini; 221 Series

	Item No.	Pack. Unit
	887-952	1

Contains:

COMPACT Splicing Connectors			
transparent	2 x 0.14 ... 4 mm ²	221-412	100
transparent	3 x 0.14 ... 4 mm ²	221-413	100
transparent	5 x 0.14 ... 4 mm ²	221-415	25

Mounting Carrier			
orange		221-500	4

Splicing connector set; L-BOXX® Mini; 2273 Series

	Item No.	Pack. Unit
	887-953	1

Contains:

COMPACT PUSH WIRE® Connectors for Junction Boxes			
white	2 x 0.5 ... 2.5 mm ²	2273-202	100
orange	3 x 0.5 ... 2.5 mm ²	2273-203	100
red	4 x 0.5 ... 2.5 mm ²	2273-204	100
yellow	5 x 0.5 ... 2.5 mm ²	2273-205	75
light gray	8 x 0.5 ... 2.5 mm ²	2273-208	25

Mounting Carrier			
orange		2273-500	4

Splicing connector set; L-BOXX® Mini; 221, 2273 Series

	Item No.	Pack. Unit
	887-955	1

Contains:

COMPACT PUSH WIRE® Connectors for Junction Boxes			
orange	3 x 0.5 ... 2.5 mm ²	2273-203	100
yellow	5 x 0.5 ... 2.5 mm ²	2273-205	75
light gray	8 x 0.5 ... 2.5 mm ²	2273-208	25

COMPACT Splicing Connectors			
transparent	2 x 0.14 ... 4 mm ²	221-412	75
transparent	3 x 0.14 ... 4 mm ²	221-413	50
transparent	5 x 0.14 ... 4 mm ²	221-415	25

Mounting Carrier			
orange		2273-500	1

Mounting Carrier			
orange		221-500	1



Set; L-BOXX® Mini

	Item No.	Pack. Unit
	887-957	1

Contains:

COMPACT PUSH WIRE® Connectors for Junction Boxes			
transparent	2 x 0.5 ... 6 mm ²	221-612	40
transparent	3 x 0.5 ... 6 mm ²	221-613	30
transparent	5 x 0.5 ... 6 mm ²	221-615	15

COMPACT Splicing Connectors			
transparent	2 x 0.14 ... 4 mm ²	221-412	75
transparent	3 x 0.14 ... 4 mm ²	221-413	50
transparent	5 x 0.14 ... 4 mm ²	221-415	25

Mounting Carrier		
orange		221-500 1

Splicing connector set; L-BOXX® Mini; 221 Series; 4 mm² and 6 mm²

	Item No.	Pack. Unit
	887-959	1

Contains:

COMPACT PUSH WIRE® Connectors for Junction Boxes			
transparent	2 x 0.14 ... 4 mm ²	221-412	100
transparent	3 x 0.14 ... 4 mm ²	221-413	100
transparent	5 x 0.14 ... 4 mm ²	221-415	25

COMPACT Splicing Connectors			
transparent	3 x 0.5 ... 6 mm ²	221-613	30



Splicing connector set; L-BOXX® Mini; 221, 2273, 224 Series

	Item No.	Pack. Unit
	887-960	1

Contains:

COMPACT PUSH WIRE® Connectors for Junction Boxes			
white	2 x 0.5 ... 2.5 mm ²	2273-202	40
orange	3 x 0.5 ... 2.5 mm ²	2273-203	30
red	4 x 0.5 ... 2.5 mm ²	2273-204	25
yellow	5 x 0.5 ... 2.5 mm ²	2273-205	20
light gray	8 x 0.5 ... 2.5 mm ²	2273-208	15

COMPACT PUSH WIRE® Connectors for Junction Boxes			
transparent	2 x 0.14 ... 4 mm ²	221-412	20
transparent	3 x 0.14 ... 4 mm ²	221-413	15
transparent	5 x 0.14 ... 4 mm ²	221-415	10

COMPACT PUSH WIRE® Connectors for Junction Boxes			
transparent	3 x 0.5 ... 6 mm ²	221-613	5

Lighting Connectors			
white	1 ... 2.5 mm ² "s"	224-112	15

Luminaire Disconnect Connector (U.S. Version)

12 AWG; 873 Series

Technical Data	
2-conductor plug ❶	1-conductor socket ❷
18 ... 12 AWG "s"	18 AWG "s"
16 ... 12 AWG "st"	600 V, 6 A
11 ... 13 mm / 0.43 ... 0.51 inch ❶	
9 ... 11 mm / 0.35 ... 0.43 inch ❷	

Technical Data	
2-conductor plug ❶	1-conductor socket ❷
18 ... 12 AWG "s"	18 AWG "s"
16 ... 12 AWG "st"	600 V, 6 A
11 ... 13 mm / 0.43 ... 0.51 inch ❶	
9 ... 11 mm / 0.35 ... 0.43 inch ❷	

- ❶ 2-conductor plug
 - ❷ 1-conductor socket
- Approvals and corresponding ratings, visit www.wago.com

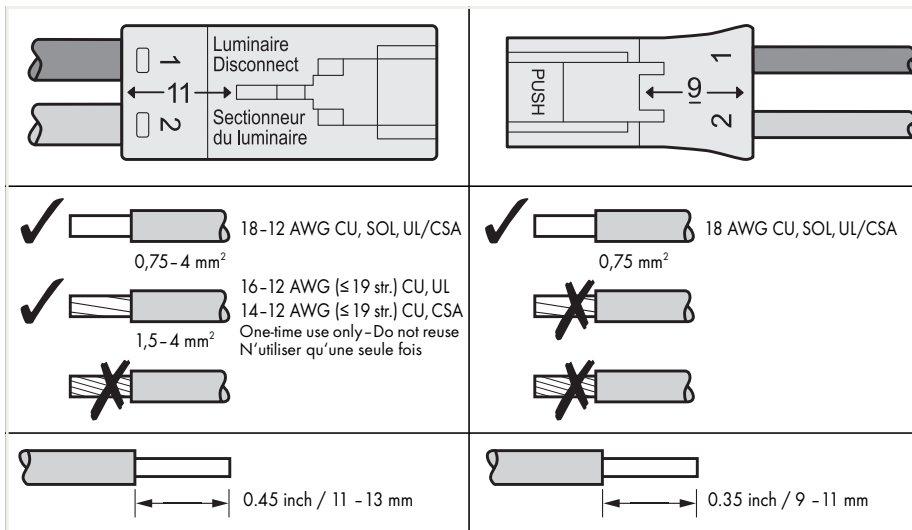
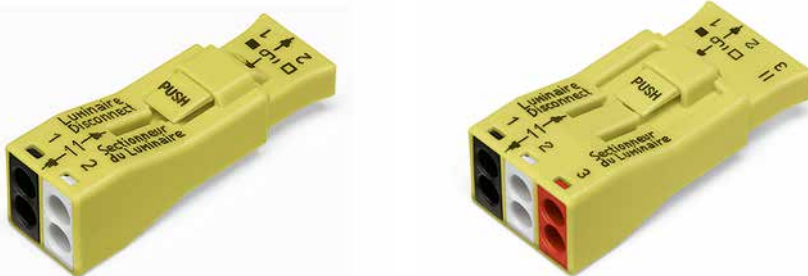

Touchproof connectors are required for ballast supply cables in the USA and Canada. When exchanging a ballast:

1. The touch-proof plug-in connection is disconnected first.
2. The ballast is replaced.
3. Network connection is restored by plugging the connection.

Reconnection streamlines ballast replacement while enhancing safety by safeguarding the installer from electric shock. The 873 Series is approved according to UL 2459 and CSA 22.2 for this type of application.

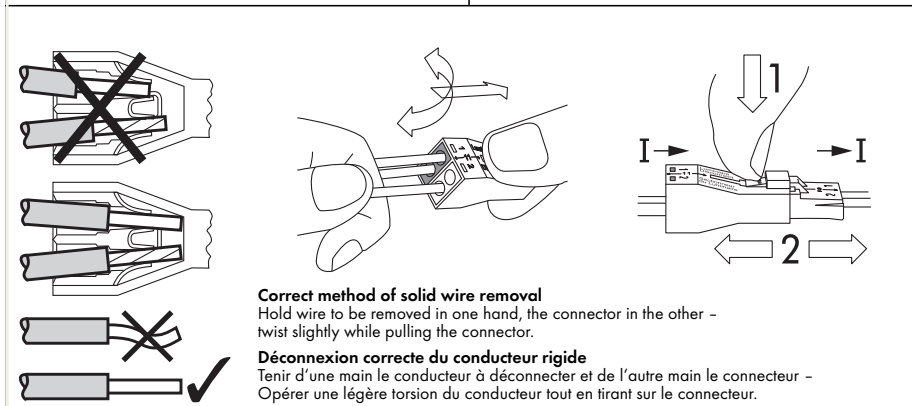

873 Series approvals per EN 60998 and EN 61984:

EN 60998
0.75 mm² (solid), 6 A for socket
1.5 ... 4 mm² (solid), 32 A for plug
400 V / 4 kV / 2

EN 61984
0.75 mm² (solid), 6 A for socket
0.75 ... 4 mm² (solid), 32 A for plug
400 V / 4 kV / 2

12

Luminaire Disconnect Connectors		
Pole No.	Item No.	Pack. Unit
2	873-902	400

Luminaire Disconnect Connectors		
Pole No.	Item No.	Pack. Unit
3	873-903	200

Luminaire Disconnect Connector (U.S. Version) 12 AWG; 873 Series

Technical Data

2-conductor plug ①	1-conductor socket ②
18 ... 12 AWG "s"	18 AWG "s"
16 ... 12 AWG "st"	600 V, 6 A ②
11 ... 13 mm / 0.43 ... 0.51 inch ①	
9 ... 11 mm / 0.35 ... 0.43 inch ②	



- ① 2-conductor plug
 - ② 1-conductor socket
- Approvals and corresponding ratings, visit www.wago.com

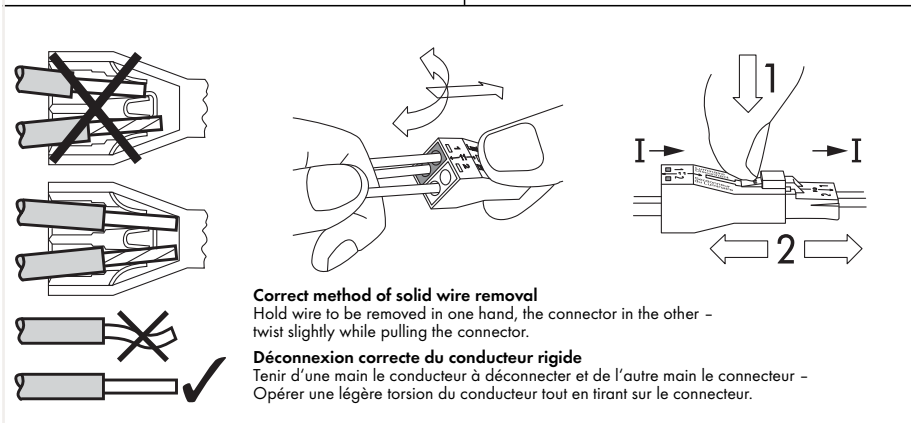
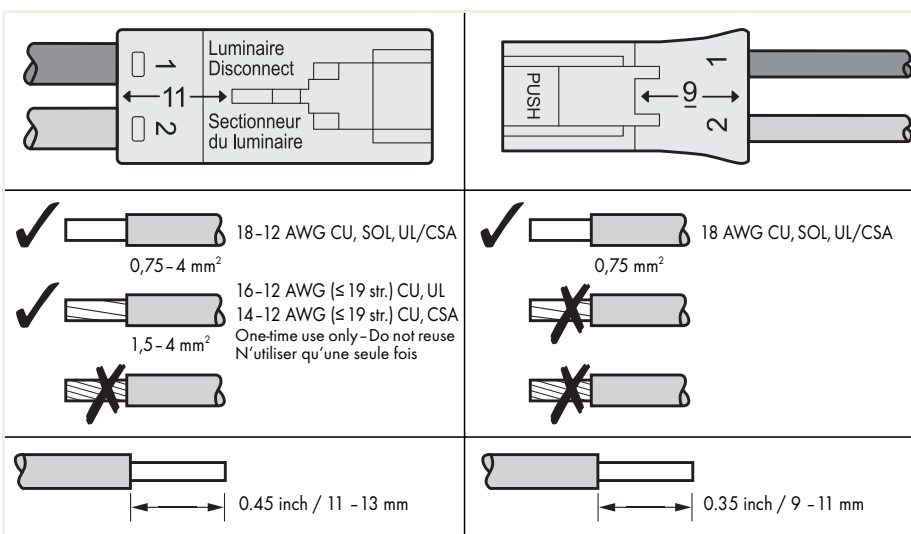

Touchproof connectors are required for ballast supply cables in the USA and Canada. When exchanging a ballast:

1. The touch-proof plug-in connection is disconnected first.
2. The ballast is replaced.
3. Network connection is restored by plugging the connection.

Reconnection streamlines ballast replacement while enhancing safety by safeguarding the installer from electric shock. The 873 Series is approved according to UL 2459 and CSA 22.2 for this type of application.

873 Series approvals per EN 60998 and EN 61984:

EN 60998
0.75 mm² (solid), 6 A for socket
1.5 ... 4 mm² (solid), 32 A for plug
400 V / 4 kV / 2

EN 61984
0.75 mm² (solid), 6 A for socket
0.75 ... 4 mm² (solid), 32 A for plug
400 V / 4 kV / 2

Luminaire disconnect connector; with preceding ground contact

Pole No.	Item No.	Pack. Unit
2	873-953	500













WAGO Accessories and WAGO Tools

Sold & Serviced By:



Toll Free Phone (877) SERV098
www.electromate.com
sales@electromate.com

WAGO Accessories and WAGO Tools

			Page
	Shield Clamping Saddles	790 Series	572
	Spring-Equipped Shield Clamping Saddles	790 Series	575
	Busbar Carriers	790 Series	578
	Marking Systems		588
	End Stops for DIN-35 and DIN-15 Rails		606
	DIN-Rails, Collective Jumper Carriers and Rail-Mount Terminal Block Covers		604
	Operating tools		612
	Cable Strippers		616
	Crimping Tools for Ferrules		618
	Cable Cutter		624
	"Alu-Plus" Contact Paste		625
	Test and Measurement Devices		626

Shield Connection System

790 Series

Installation



Carrier with grounding foot* (790-113), 45 mm long, busbar 90° to the rail

*for all shield clamping saddle sizes



Carrier with grounding foot* (790-114), 45 mm long, busbar parallel to the rail

*for all shield clamping saddle sizes



Carrier with grounding foot* (790-115), 125 mm long, busbar parallel to the rail

*for all shield clamping saddle sizes



Securing a spacer sleeve to a specialty slotted DIN-rail.

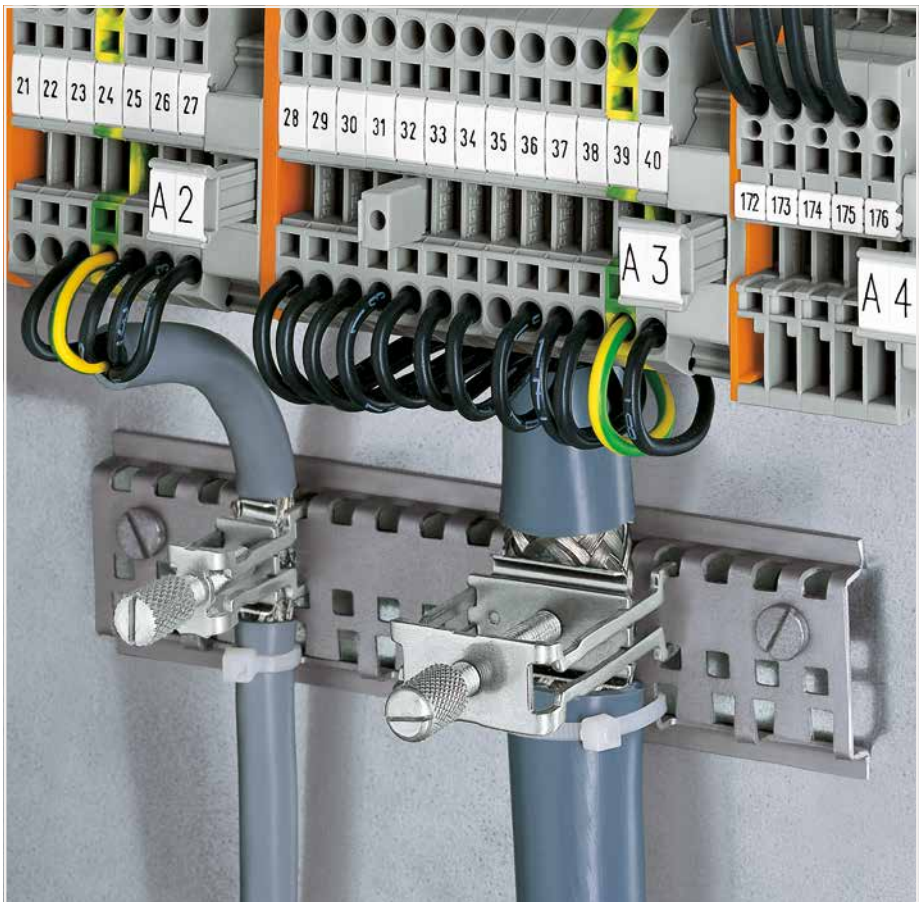

Securing an additional shield clamping saddle.

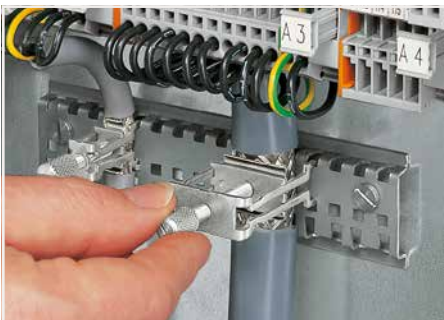

Tightening/removing a shield clamping saddle.



After connection, tighten the knurled screw to complete the installation.
Recommended tightening torque: 0.5 Nm



To remove the clamping saddle, unscrew until ratcheted mechanism is released, then slightly tip saddle and remove the clamping saddle.

Shield Connection System

790 Series

Installation

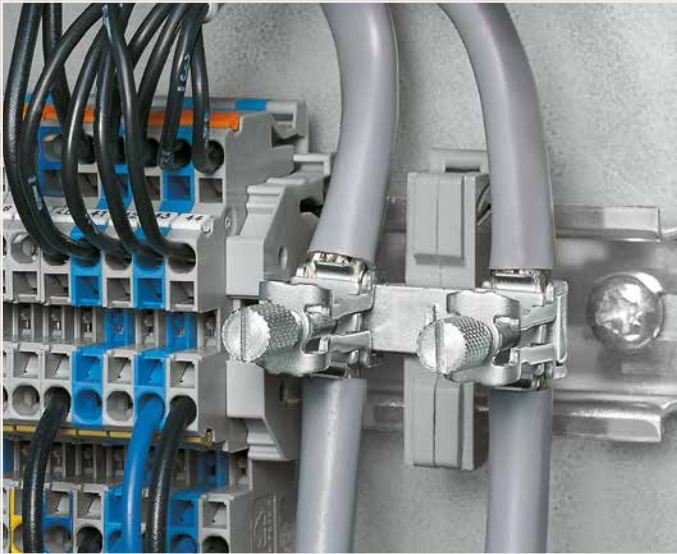

Carrier with grounding foot – busbar parallel to the rail



Insulated mounting carriers for a common shield reference potential, independent of housing potential



U-shaped (10 x 3) mm copper busbar



Snap shield clamping saddles into any metal plate (max. thickness: 3 mm).

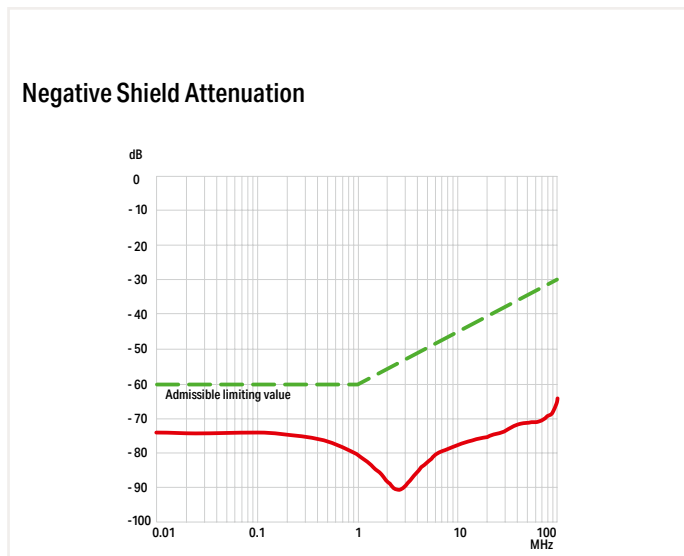

The shield connection system is highly effective because the clamping unit can be brought very close to the unshielded part of the cable.

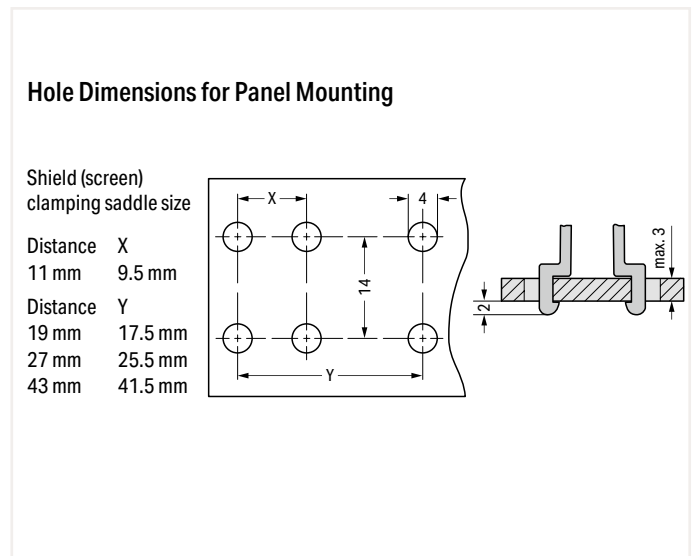

Additionally, the spring material is part of the clamping saddle, providing a good electrical connection (the system also acts as a partial strain relief). The spring element integrated in the shield clamping saddle compensates for deformation and settling that results from a connected shield.

Shield Clamping Saddles 790 Series

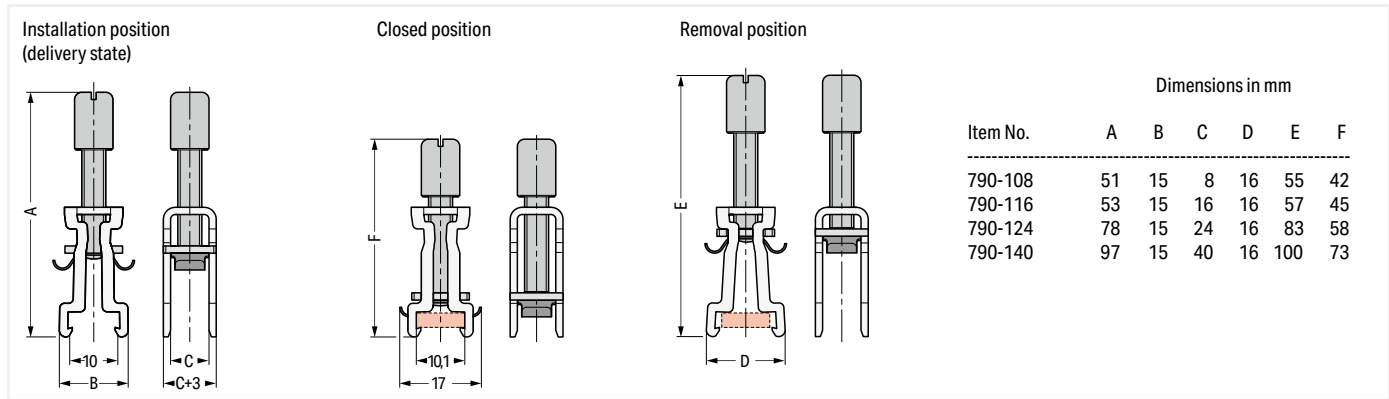

Item No.	Dimensions in mm					
	A	B	C	D	E	F
790-108	51	15	8	16	55	42
790-116	53	15	16	16	57	45
790-124	78	15	24	16	83	58
790-140	97	15	40	16	100	73

Shield clamping saddle; 11 mm wide; Connectable shield diameter: 3 ... 8 mm
Note: Cannot be used for connecting ground conductors!

Item No.	Pack. Unit
790-108	50 (10)

Shield clamping saddle; 19 mm wide; Connectable shield diameter: 7 ... 16 mm
Note: Cannot be used for connecting ground conductors!

Item No.	Pack. Unit
790-116	50 (10)

Shield clamping saddle; 27 mm wide; Connectable shield diameter: 6 ... 24 mm
Note: Cannot be used for connecting ground conductors!

Item No.	Pack. Unit
790-124	50 (10)

Accessories; for Shield Clamping Saddles

Carrier with grounding saddle; Busbar parallel to the rail; 15 mm long; Copper (10 x 3) mm; for shield clamping saddles (790-108)

790-110	25
---------	----

Carrier with grounding foot; Busbar parallel to the rail; 25 mm long; Copper (10 x 3) mm; for shield clamping saddles (790-108; 790-116) and shield clamps (791-111; 791-117)

790-112	25
---------	----

Carrier with grounding foot; Busbar 90° to the DIN-rail; 45 mm long; Copper (10 x 3) mm; for shield clamping saddles (790 Series)

790-113	25
---------	----

Carrier with grounding foot; Busbar parallel to the DIN-rail; 45 mm long; Copper (10 x 3) mm; for shield clamping saddles (790 Series) and shield clamps (791 Series)

790-114	25
---------	----

Carrier with two grounding feet; Busbar parallel to the DIN-rail; 125 mm long; Copper (10 x 3) mm

790-115	25
---------	----

DIN-rail; specialty slotted; 1000 mm long; tin-plated

790-145	
---------	--

Spacer sleeve; steel; for DIN-rail; specialty slotted; for M5-size screw;

790-144	200 (100)
---------	-----------

Insulated mounting foot; for busbar with M4 x 8 mm screw

790-100	50 (25)
---------	---------

Insulated mounting foot; for busbar with (3.5 x 9) mm sheet metal screw

790-101	50 (25)
---------	---------

Busbar; tin-plated; 1000 mm long; copper (10 x 3) mm

210-133	1
---------	---

Busbar; tin-plated; 30 mm long; copper (10 x 3) mm

790-133	20
---------	----

Busbar; tin-plated; 50 mm long; copper (10 x 3) mm

790-134	20
---------	----

U-shaped busbar; Copper (10 x 3) mm; for 5 I/O; for 750 Series I/O Modules

790-190	25 (5)
---------	--------

U-shaped busbar; Copper (10 x 3) mm; for 8 I/O; for 750 Series I/O Modules

790-191	25
---------	----

U-shaped busbar; Copper (10 x 3) mm; for 5 I/O; for 750 Series I/O Modules

790-192	25
---------	----

U-shaped busbar; Copper (10 x 3) mm; for 8 I/O; for 750 Series I/O Modules

790-193	25
---------	----

13

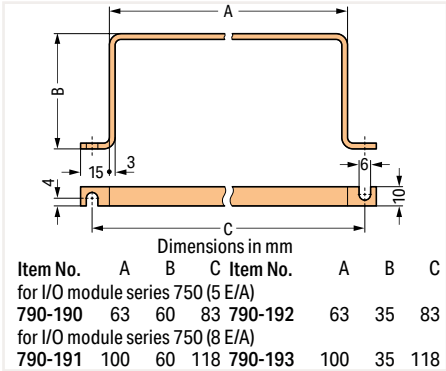

Shield clamping saddle; 43 mm wide; Connectable shield diameter: 22 ... 40 mm
 Note: Cannot be used for connecting ground conductors!

Item No.	Pack. Unit
790-140	50 (10)



Carrier with grounding foot* (790-114), 45 mm long, busbar parallel to the rail



Carrier with grounding foot* (790-115), 125 mm long, busbar parallel to the rail

*for all shield clamping saddle sizes

*for all shield clamping saddle sizes

Sold & Serviced By:



Toll Free Phone (877) SERV098
 www.electromate.com
 sales@electromate.com

Spring-Equipped Shield Clamping Saddles

790 Series

Installation



Shield clamping saddles are available in three different sizes for shield diameters ranging from 3 to 20 mm.

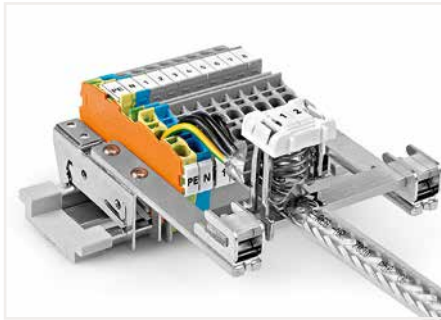

Application example



Compress the clamping saddle until fully engaged.



Mounting a clamping saddle on a specialty slotted DIN-rail (790-145).
When releasing the saddle, do not place your finger under the clamping spring!



Removing the shield clamping saddle.



Shield clamping saddle contacts shield conductor and specialty slotted DIN-rail (790-145).



Labeling using a marking strip.



Labelling using WMB markers.

Spring-Equipped Shield Clamping Saddles 790 Series



Delivery position

Mounting position

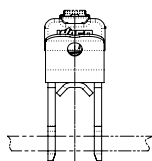
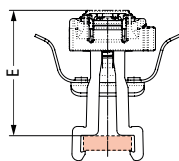
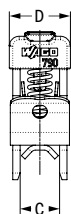
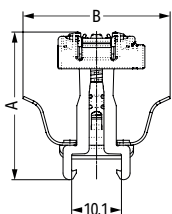

Dimensions in mm

Item No.	A	B	C	D	E*
790-208	30	29.9	8	12.4	25.8
790-216	34.6	28.3	16	21.8	30.2
790-220	45.6	28.3	24	30	41.2

*Height with WMB marker

Shield clamping saddle; 12.4 mm wide; Connectable shield diameter: 3 ... 8 mm
Note: Cannot be used for connecting ground conductors and strain relief!

Item No.	Pack. Unit
790-208	50

Shield clamping saddle; 21.8 mm wide; Connectable shield diameter: 6 ... 16 mm
Note: Cannot be used for connecting ground conductors and strain relief!

Item No.	Pack. Unit
790-216	25

Shield clamping saddle; 30 mm wide; Connectable shield diameter: 6 ... 20 mm
Note: Cannot be used for connecting ground conductors and strain relief!

Item No.	Pack. Unit
790-220	25

Accessories; for Shield Clamping Saddles

Carrier with grounding foot; Busbar parallel to the rail; 15 mm long; Copper (10 x 3) mm; for shield clamping saddles (790-108)

790-110	25
---------	----



Carrier with grounding foot; Busbar parallel to the rail; 25 mm long; Copper (10 x 3) mm; for shield clamping saddles (790-108; 790-116) and shield clamps (791-111; 791-117)

790-112	25
---------	----



Carrier with grounding foot; Busbar 90° to the DIN-rail; 45 mm long; Copper (10 x 3) mm; for shield clamping saddles (790 Series)

790-113	25
---------	----



Carrier with grounding foot; Busbar parallel to the DIN-rail; 45 mm long; Copper (10 x 3) mm; for shield clamping saddles (790 Series) and shield clamps (791 Series)

790-114	25
---------	----



Carrier with two grounding feet; Busbar parallel to the DIN-rail; 125 mm long; Copper (10 x 3) mm

790-115	25
---------	----



DIN-rail; specialty slotted; 1000 mm long; tin-plated

790-145



Spacer sleeve; steel; for DIN-rail; specialty slotted; for M5-size screw;

790-144	200 (100)
---------	-----------



Busbar; tin-plated; 1000 mm long; copper (10 x 3) mm

210-133	1
---------	---



Busbar; tin-plated; 30 mm long; copper (10 x 3) mm

790-133	20
---------	----



Busbar; tin-plated; 50 mm long; copper (10 x 3) mm

790-134	20
---------	----



Shield Clamp and Shield Termination 791 and 709 Series



Dimensions in mm

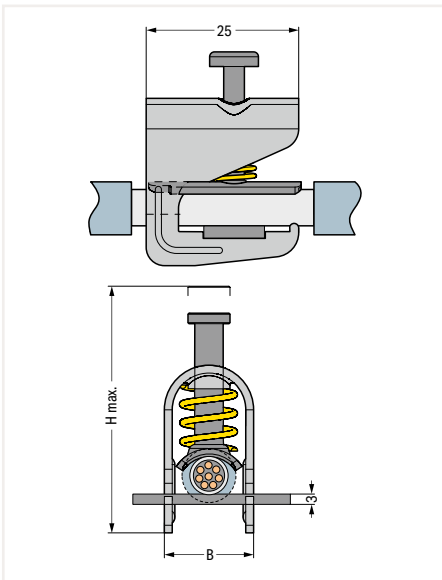

Shield clamp; Connectable shield diameter: 1.5 ... 6.5 mm; Height (max.): 40 mm; 10 mm wide
Note: Cannot be used for connecting ground conductors!

Item No.	Pack. Unit
791-107	50

Shield clamp; Connectable shield diameter: 5 ... 11 mm; Height (max.): 47 mm; 17 mm wide
Note: Cannot be used for connecting ground conductors!

791-111	50
---------	----

Shield clamp; Connectable shield diameter: 10 ... 17 mm; Height (max.): 63 mm; 23 mm wide
Note: Cannot be used for connecting ground conductors!

791-117	50
---------	----

Shield clamp; Connectable shield diameter: 16 ... 24 mm; Height (max.): 78 mm; 30 mm wide
Note: Cannot be used for connecting ground conductors!

791-124	50
---------	----

Shield termination; includes cable ties for 5 ... 10 mm shield diameter; 60 mm long

Item No.	Pack. Unit
709-350	100 (25)

Shield termination; includes cable ties for 5 ... 10 mm shield diameter; 150 mm long

709-352	100 (25)
---------	----------



Insert the shield termination into the female plug using the operating tool.



Fit the shield termination to the shield cable.



Secure both shield cable and shield termination to the strain relief plate using cable ties.



Shield termination connected to an X-COM® female plug

Busbar Carriers 790 Series

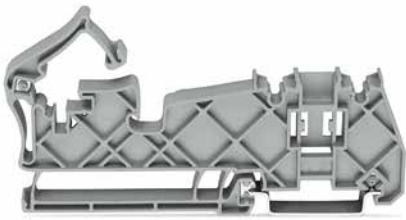

Dimensions in mm

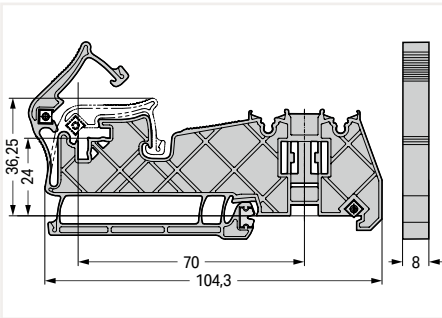

Busbar carrier; for (10 x 3) mm copper busbars; no contact to DIN-rail; insulated

Item No.	Pack. Unit
790-400	20



Snapping the busbar carrier onto DIN-35 rail.



Vertical mounting position of the busbar



Place the busbar in the carrier holder.



Horizontal mounting position of the busbar



Snap the mounting bracket into position.



Release the mounting bracket by pushing the operating tool down ① and then forward ②.

Busbar Carriers

790 Series



Dimensions in mm

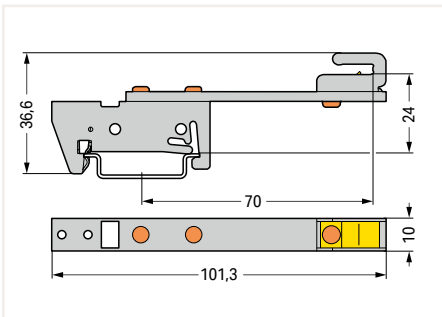

Busbar carrier; for (10 x 3) mm copper busbars; single side; straight; 70 mm between center of DIN-rail and busbar carrier

Item No.	Pack. Unit
790-300	10

Dimensions in mm

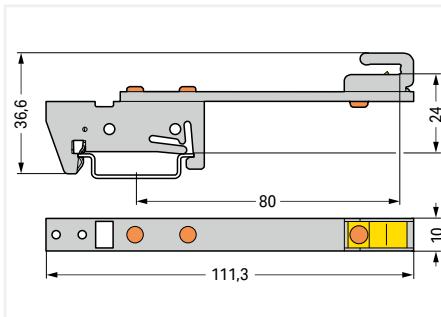

Busbar carrier; for (10 x 3) mm copper busbars; single side; straight; 80 mm between center of DIN-rail and busbar carrier

Item No.	Pack. Unit
790-302	10

Dimensions in mm

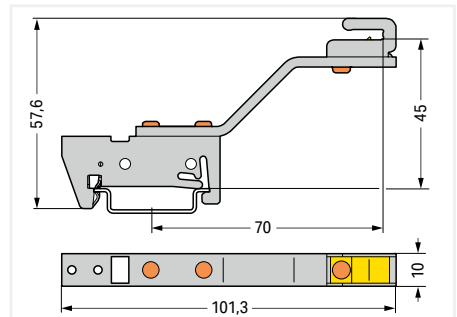

Busbar carrier; for (10 x 3) mm copper busbars; single side; angled; 70 mm between center of DIN-rail and busbar carrier

Item No.	Pack. Unit
790-301	10



Remove the busbar carrier using an operating tool (type 3, 5.5 x 0.8 mm blade).

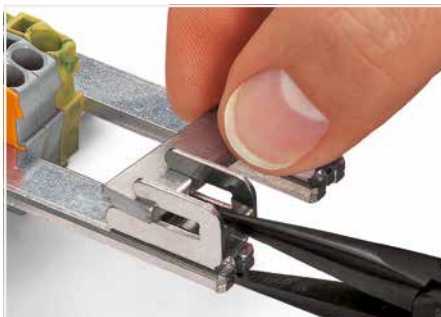

To remove the busbar, compress the spring using pliers.



Place the busbar in the busbar carrier.

Busbar Carriers 790 Series



Dimensions in mm

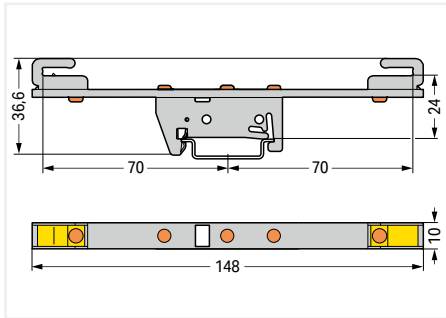

Busbar carrier; for (10 x 3) mm copper busbars; both sides; straight; 70 mm between center of DIN-rail and busbar carrier

Item No.	Pack. Unit
790-310	10

Dimensions in mm

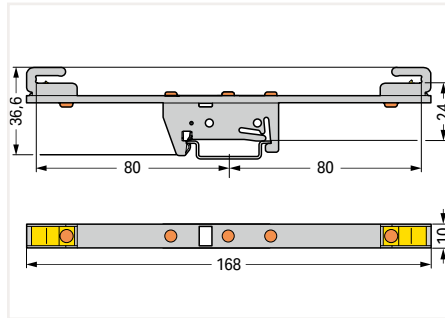

Busbar carrier; for (10 x 3) mm copper busbars; both sides; straight; 80 mm between center of DIN-rail and busbar carrier

Item No.	Pack. Unit
790-312	10

Dimensions in mm

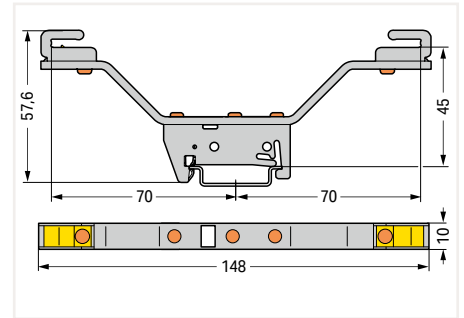

Busbar carrier; for (10 x 3) mm copper busbars; both sides; angled; 70 mm between center of DIN-rail and busbar carrier

Item No.	Pack. Unit
790-311	10

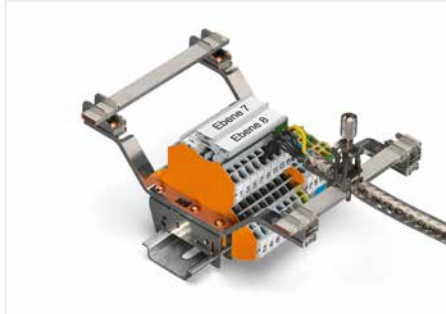

Application example

Busbar Carrier with a T-Connector (Flexible) and T-Connector 790 Series



Dimensions in mm

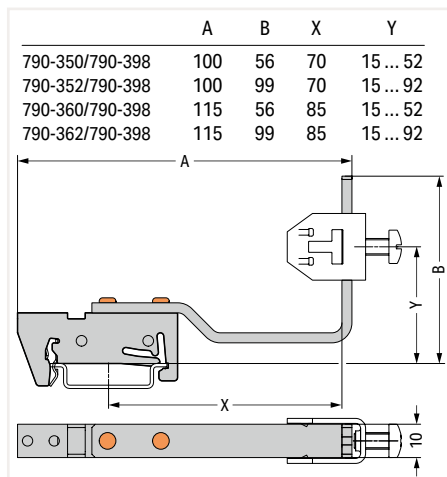

Dimensions in mm

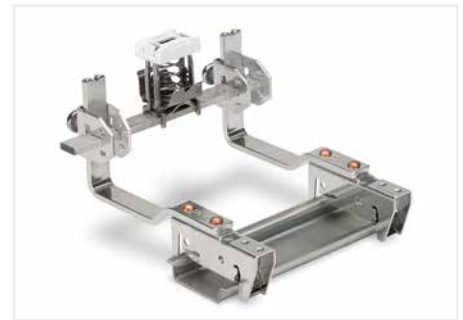
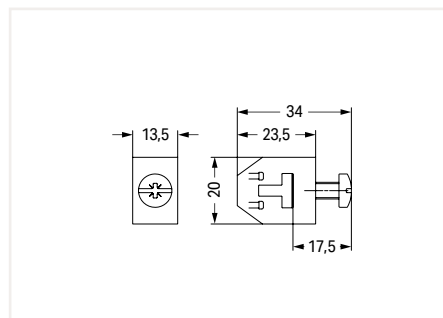

Horizontal mounting position of the busbar



Vertical mounting position of the busbar

Busbar carrier with a T-connector; flexible; for (10 x 3) mm copper busbars; 70 mm between center of DIN-rail and busbar carrier; 56 mm high

Item No.	Pack. Unit
790-350/790-398	12

Busbar carrier with a T-connector; flexible; for (10 x 3) mm copper busbars; 70 mm between center of DIN-rail and busbar carrier; 99 mm high

790-352/790-398	12
-----------------	----

Busbar carrier with a T-connector; flexible; for (10 x 3) mm copper busbars; 85 mm between center of DIN-rail and busbar carrier; 56 mm high

790-360/790-398	12
-----------------	----

Busbar carrier with a T-connector; flexible; for (10 x 3) mm copper busbars; 85 mm between center of DIN-rail and busbar carrier; 99 mm high

790-362/790-398	12
-----------------	----

T-connector; connects two (10 x 3) mm copper busbars

Item No.	Pack. Unit
790-398	

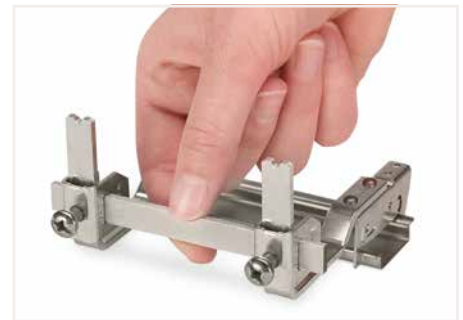

The height of the busbar can be adjusted.



Secure the busbar by tightening the screws at the required position.

Smart Data

Supports Workflow from Control Cabinet Planning to Installation

Electrical Planning
 Directly import data from a CAE circuit diagram into the Smart Designer engineering software or output marking data on Smart Printer

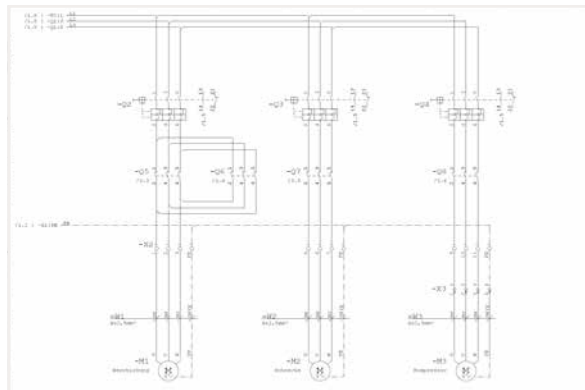

Technical and Commercial Item Data
 Classified by ETIM and eCl@ss – also in Advanced Format



Mechanical Planning
 CAD export into all standard CAD formats and in different granularities



Smart Designer

- Free online configuration and ordering software for all electrical interconnect and automation components
- No installation required
- Available worldwide – 24 hours a day
- Item data is always updated
- Auto-audit feature checks product compatibility via programmed database
- Design in full 3-D

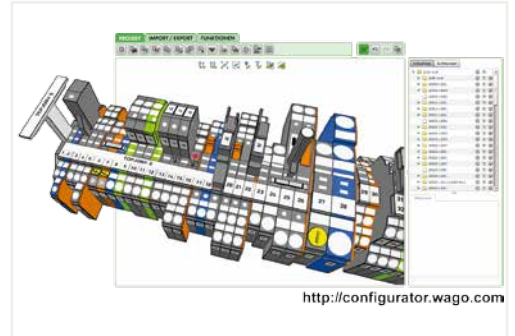

Smart Script

- XML-based software for all WAGO labeling materials
- Data import from CAE systems
- Font size check
- Material selection wizard



Configuration made easy – <http://configurator.wago.com>

Smart Printer

The Fastest Marking System



Smart Script



Smart Script
Import from CAE systems or create customized marking.

Smart Designer

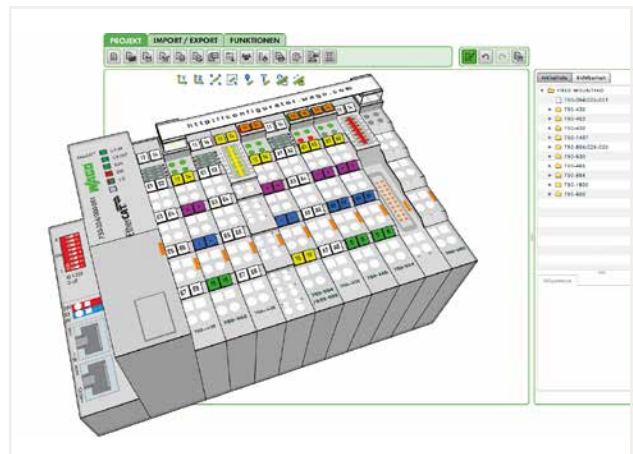

Smart Designer
After designing, print labeling materials directly from the project via Smart Printer

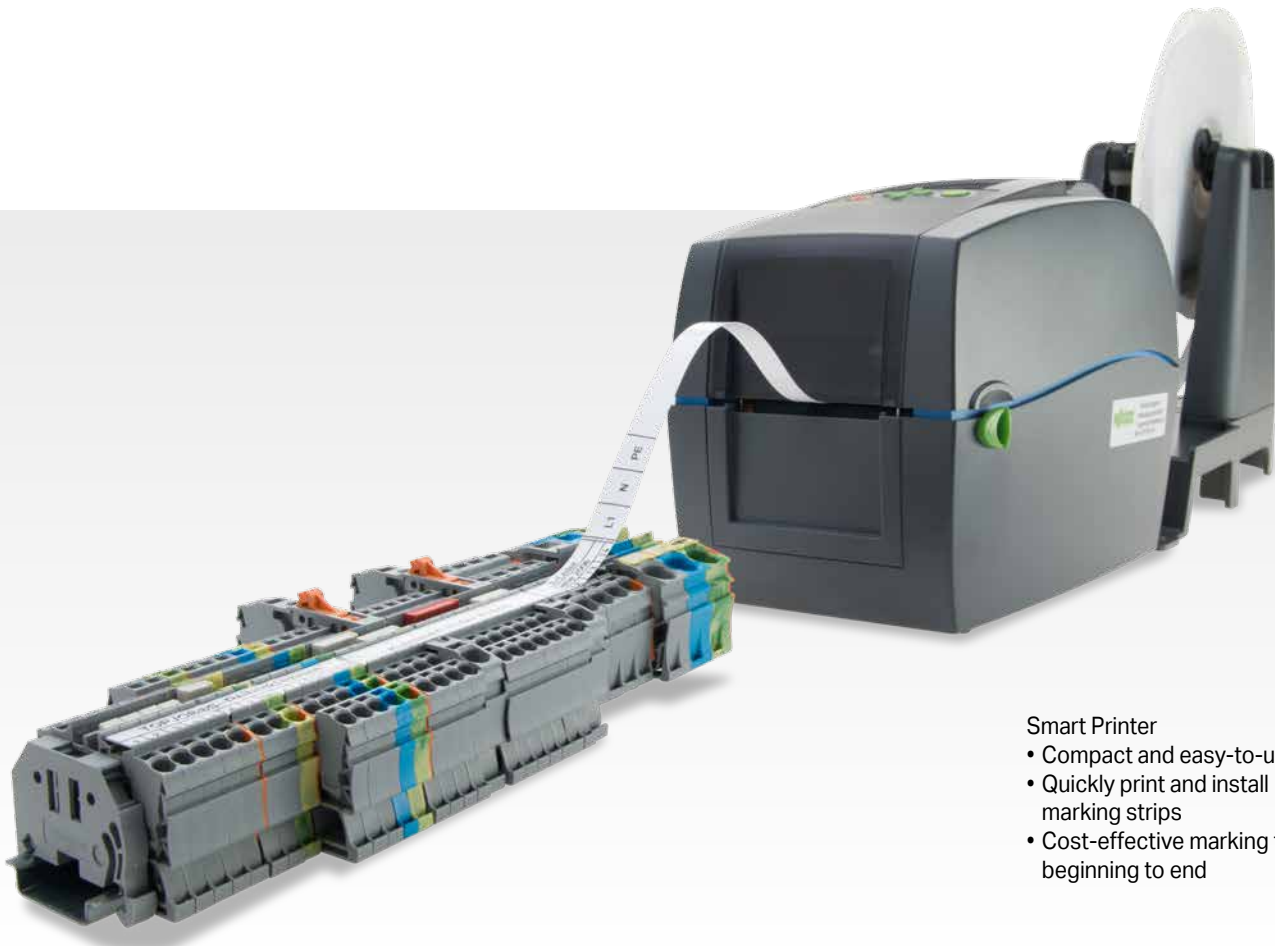

Smart Printer

- Compact and easy-to-use
- Quickly print and install marking strips
- Cost-effective marking from beginning to end

Terminal Block Marking

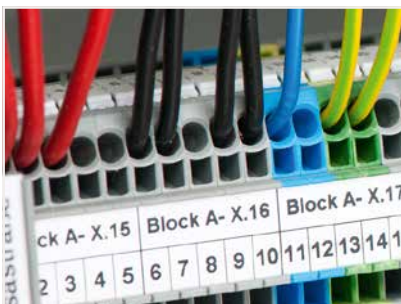

Multi-line marking strips for clear, detailed control cabinet labels

- WMB Inline markers on a reel are suitable for various terminal block sizes – just one marker size for all standard applications
- Same profile across all TOPJOB® S Rail-Mount Terminal Blocks ensures quick labeling

Cable and Conductor Marking



Different versions available:

- Marking sleeves, self-laminating labels, conductor markers for thread-on mounting or shrink tubes
- Large variety of marking surface sizes

Device Marking

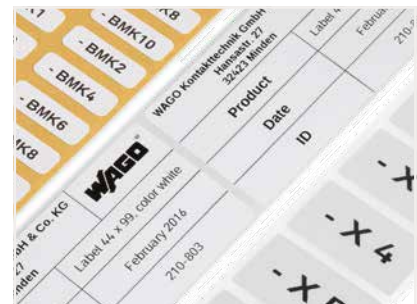

Broad selection of label types (e.g., printable fabric), push-button markers and type plates optimizes marking for devices and control cabinets

- Labels and markers are available in a variety of colors and sizes

Marking Systems

Description and Installation



Separating a strip from the WMB or WMB marker card.



Stretching a WMB marker strip.



Separating an individual marker from the strip – for larger terminal blocks.



Marking via Mini-WSB Quick Marking System.

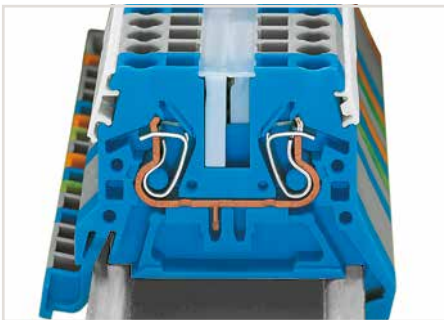

WMB markers in Mini-WSB marker slots
Translucent marking strip
Mini-WSB markers

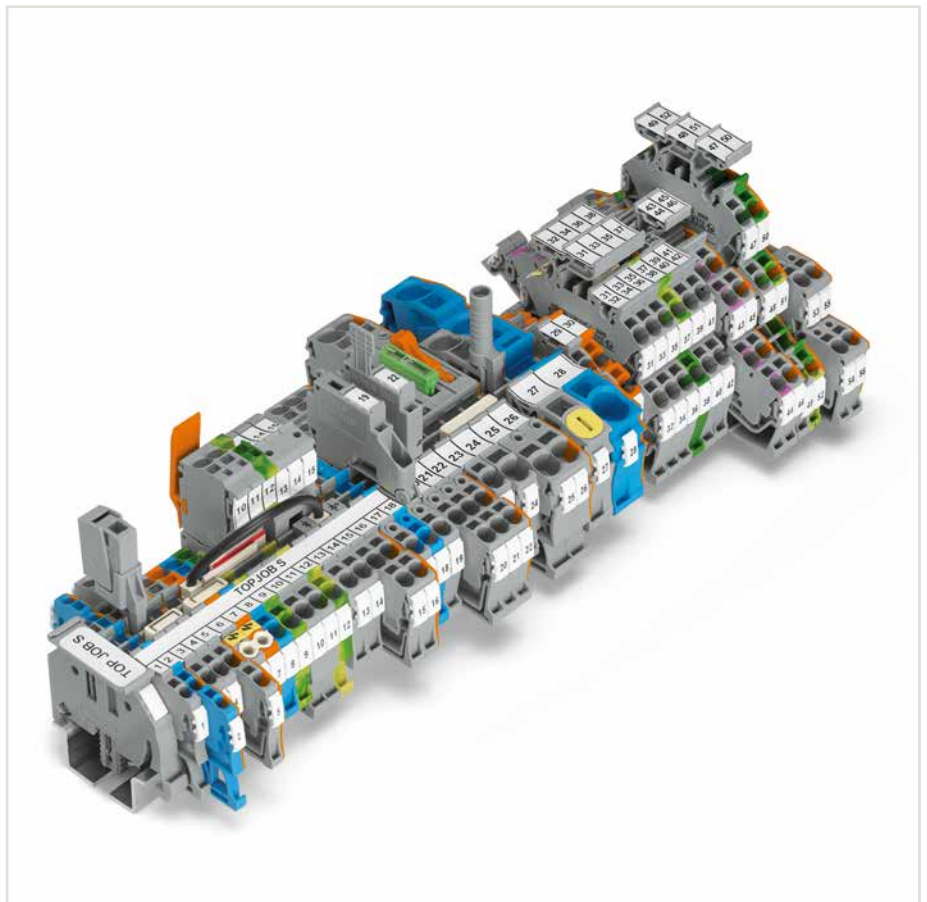

Printing a marking strip (2009-110) via Smart Printer.

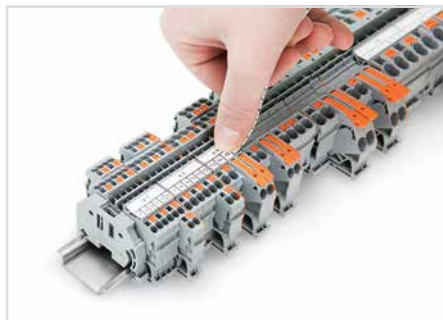

Snapping a marking strip into the marker slot.



Marking strip – multi-line printing

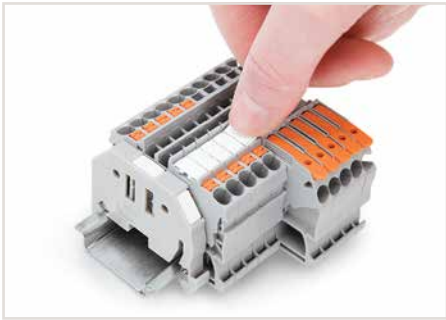

Snapping a marking strip into the marker slot.



Snapping a WMB marker strip into the marker slot of the double marker carrier.



WMB "decade" marking

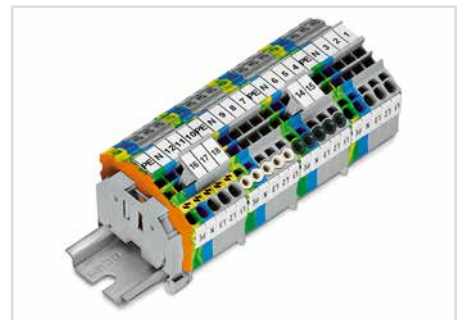

Group marker carriers for WAGO Rail-Mount Terminal Blocks TOPJOB® S- can be snapped into jumper slots.

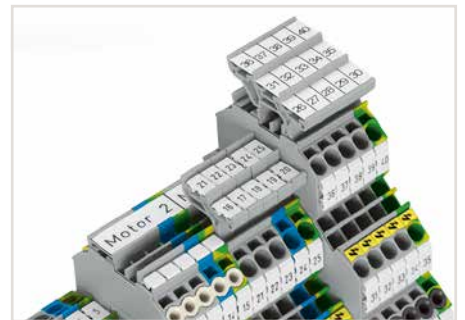

Double- and triple-deck marker carriers can be retrofitted into the jumper contact slot of double- and triple-deck terminal blocks.



Height-adjustable group marker carrier (249-116) for marking strips (2009-110)



Height-adjustable group marker carrier

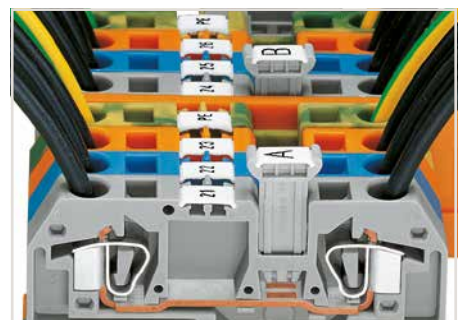

Additional group marking

Marking System

Terminal Block Width: 3.5 mm, 4 ... 4.2 mm and from 5 mm

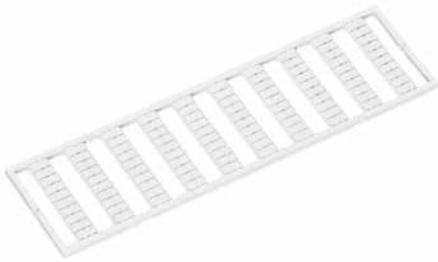

Use		
Marker width	Can be snapped onto the following terminal block series	
	for continuous marking	that will be separated
3.5 mm	2000, 2020	-
4 ... 4.2 mm	279, 2001	-
5 ... 5.2 mm	270, 280, 780, 869, 870, 880, 2002, 2003, 2022	Terminal blocks with spacing > 5 ... 5.2 mm
5 ... 17.5 mm	270, 280, 780, 869, 870, 880	281 ... 285, 781 ... 785, 2002, 2004, 2005, 2006, 2007, 2010, 2016, 2022

WMB marker card; plain; 10 strips with 10 markers/card					
Color	5 mm Item No.	5 ... 5.2 mm Item No.	4 ... 4.2 mm Item No.	3.5 mm Item No.	Pack. Unit
○ white	793-501	793-5501	793-4501	793-3501	5
● yellow	793-501/000-002	793-5501/000-002	793-4501/000-002		5
● red	793-501/000-005	793-5501/000-005	793-4501/000-005		5
● blue	793-501/000-006	793-5501/000-006	793-4501/000-006		5
○ gray	793-501/000-007	793-5501/000-007	793-4501/000-007		5
● orange	793-501/000-012	793-5501/000-012	793-4501/000-012		5
● light green	793-501/000-017	793-5501/000-017	793-4501/000-017		5
● green	793-501/000-023	793-5501/000-023	793-4501/000-023		5
● violet	793-501/000-024	793-5501/000-024	793-4501/000-024		5



Use		
Marker width	Can be snapped onto the following terminal block series	
	for continuous marking	that will be separated
3.5 mm	2000, 2020	-
4 ... 4.2 mm	279, 2001	-
5 ... 5.2 mm	270, 280, 780, 869, 870, 880, 2002, 2003, 2022	Terminal blocks with spacing > 5 ... 5.2 mm

WMB Inline; plain; 2,300 WMB markers (3.5 mm)/reel		
Color	3.5 mm Item No.	Pack. Unit
○ white	2009-113	1

WMB Inline; plain; 2,000 WMB markers (4 mm)/reel; stretchable 4 ... 4.2 mm		
Color	4 ... 4.2 mm Item No.	Pack. Unit
○ white	2009-114	1

WMB Inline; plain; 1,500 WMB markers (5 mm)/reel; stretchable 5 ... 5.2 mm		
Color	5 ... 5.2 mm Item No.	Pack. Unit
○ white	2009-115	1

Use		
	Can be snapped onto the following terminal block series	
	2000, 2001, 2002, 2003, 2004, 2005, 2006, 2007, 2010, 2016, 2020, 2022	

Marking strip; plain; 11 mm wide; 50 m reel		
Color	3.5 mm Item No.	Pack. Unit
○ white	2009-110	1



Mini-WSB Quick Marking System

Terminal Block Width: 5 mm

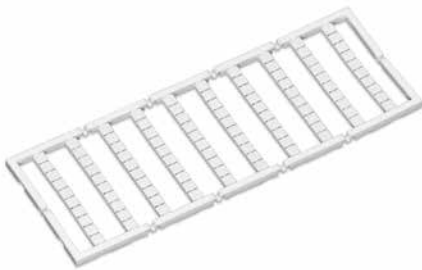

Use		
Marker width	Can be snapped onto the following terminal block series	
5 mm	for continuous marking	that will be separated
	264, 270, 869, 880, 769, 870, 218, 233 ... 236, 243, 250, 252 ... 257, 735 ... 742, 745, 746, 804, 805, 806, 816, 831, 750, 753, 2002, 2003, 2022	745, 746, 2004, 2006, 2007, 2010, 2016

Mini-WSB marker card; plain; 10 strips with 10 markers/card		
Color	Item No.	Pack. Unit
<input type="radio"/> white	248-501	5
<input type="radio"/> yellow	248-501/000-002	5
<input type="radio"/> red	248-501/000-005	5
<input type="radio"/> blue	248-501/000-006	5
<input type="radio"/> gray	248-501/000-007	5
<input type="radio"/> orange	248-501/000-012	5
<input type="radio"/> light green	248-501/000-017	5
<input type="radio"/> green	248-501/000-023	5
<input type="radio"/> violet	248-501/000-024	5

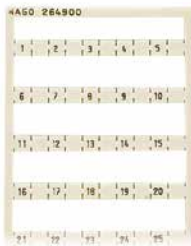

Mini-WSB marker card; with marking; not stretchable; horizontal marking; snap-on type		
Marking	Item No.	Pack. Unit
<input type="radio"/> 1, , 2, , 3, , 4, , 5, ; to 46, , 47, , 48, , 49, , 50, ; (each 1x)	264-900	5
<input type="radio"/> U, , V, , W, , N, , GND, ; (10x)	264-901	5
<input type="radio"/> L1, , L2, , L3, , N, , GND, ; (10x)	264-902	5
<input type="radio"/> 1, , 1, , 1, , 1, , 1, ; (10x)	264-903	5
<input type="radio"/> 2, , 2, , 2, , 2, ; (10x)	264-904	5
<input type="radio"/> 3, , 3, , 3, , 3, ; (10x)	264-905	5



Use		
Marker width	Can be snapped onto the following terminal block series	
5 mm	for continuous marking	that will be separated
	264, 270, 869, 880, 769, 870, 218, 233 ... 236, 243, 250, 252 ... 257, 735 ... 742, 745, 746, 804, 805, 806, 816, 831, 750, 753, 2002, 2003, 2022	745, 746, 2004, 2005, 2006, 2007, 2010, 2016

Mini-WSB Inline; plain; 1,700 markers (5 mm)/reel; stretchable 5 ... 5.2 mm		
Color	3.5 mm Item No.	Pack. Unit
<input type="radio"/> white	2009-145	1

Marking Card; Self-Adhesive Marking Strips



- Strip length: 182 mm

Marking strip; plain; as DIN A4 sheet

	Item No.	Pack. Unit
<input type="radio"/> Strip height: 2.3 mm; 100 self-adhesive strips per card	210-331	100
<input type="radio"/> Strip height: 3 mm; 80 self-adhesive strips per card	210-332	100
<input type="radio"/> Strip height: 5 mm; 48 self-adhesive strips per card	210-334	100
<input type="radio"/> Strip height: 6 mm; 40 self-adhesive strips per card	210-333	100
<input type="radio"/> Strip height: 9 mm; 25 self-adhesive strips per card	210-335	100



- Horizontal marking
- Strip length: 182 mm
- Strip height: 6 mm

Marking strip; as DIN A4 sheet; for 2-conductor terminal strips (260 Series)

Marking	Item No.	Pack. Unit
<input type="radio"/> 1 ... 10 (120 x)	210-333/500-002	100
<input type="radio"/> 11 ... 20 (120 x)	210-333/500-003	100
<input type="radio"/> 21 ... 30 (120 x)	210-333/500-004	100
<input type="radio"/> 31 ... 40 (120 x)	210-333/500-005	100
<input type="radio"/> 41 ... 50 (120 x)	210-333/500-006	100
<input type="radio"/> 51 ... 60 (120 x)	210-333/500-007	100
<input type="radio"/> 61 ... 70 (120 x)	210-333/500-008	100
<input type="radio"/> 71 ... 80 (120 x)	210-333/500-009	100
<input type="radio"/> 81 ... 90 (120 x)	210-333/500-010	100
<input type="radio"/> 91 ... 100 (120 x)	210-333/500-011	100
<input type="radio"/> 1 ... 50 (20 x)	210-333/500-021	100
<input type="radio"/> L1 (1440 x)	210-333/500-074	100
<input type="radio"/> L2 (1440 x)	210-333/500-075	100
<input type="radio"/> L3 (1440 x)	210-333/500-076	100
<input type="radio"/> N (1440 x)	210-333/500-077	100
<input type="radio"/> PE (1440 x)	210-333/500-078	100
<input type="radio"/> PEN (1440 x)	210-333/500-079	100
<input type="radio"/> only grid spacing	210-333/500-001	100

Marking strip; for 4-conductor terminal strips (260 Series)

<input type="radio"/> 1 ... 10 (80 x)	210-333/800-002	100
<input type="radio"/> 11 ... 20 (80 x)	210-333/800-003	100
<input type="radio"/> 21 ... 30 (80 x)	210-333/800-004	100
<input type="radio"/> 31 ... 40 (80 x)	210-333/800-005	100
<input type="radio"/> 41 ... 50 (80 x)	210-333/800-006	100
<input type="radio"/> 51 ... 60 (80 x)	210-333/800-007	100
<input type="radio"/> 61 ... 70 (80 x)	210-333/800-008	100
<input type="radio"/> 71 ... 80 (80 x)	210-333/800-009	100
<input type="radio"/> 81 ... 90 (80 x)	210-333/800-010	100
<input type="radio"/> 91 ... 100 (80 x)	210-333/800-011	100
<input type="radio"/> 1 ... 40 (20 x)	210-333/800-209	100
<input type="radio"/> L1 (880 x)	210-333/800-074	100
<input type="radio"/> L2 (880 x)	210-333/800-075	100
<input type="radio"/> L3 (880 x)	210-333/800-076	100
<input type="radio"/> N (880 x)	210-333/800-077	100
<input type="radio"/> PE (880 x)	210-333/800-078	100
<input type="radio"/> PEN (880 x)	210-333/800-079	100
<input type="radio"/> only grid spacing	210-333/800-001	100

Marking Card; Self-Adhesive Marking Strips



- Horizontal marking
- Strip length: 182 mm
- Strip height: 6 mm

Marking strip; as DIN A4 sheet; for 2-conductor terminal strips (261 Series)

Marking	Item No.	Pack. Unit
<input type="radio"/> 1 ... 12 (80 x)	210-333/600-103	100
<input type="radio"/> 13 ... 24 (80 x)	210-333/600-104	100
<input type="radio"/> 25 ... 36 (80 x)	210-333/600-105	100
<input type="radio"/> 37 ... 48 (80 x)	210-333/600-106	100
<input type="radio"/> 41 ... 50 (80 x)	210-333/600-006	100
<input type="radio"/> 51 ... 60 (80 x)	210-333/600-007	100
<input type="radio"/> 61 ... 70 (80 x)	210-333/600-008	100
<input type="radio"/> 71 ... 80 (80 x)	210-333/600-009	100
<input type="radio"/> 81 ... 90 (80 x)	210-333/600-010	100
<input type="radio"/> 91 ... 100 (80 x)	210-333/600-011	100
<input type="radio"/> 1 ... 50 (20 x)	210-333/600-021	100
<input type="radio"/> L1 (1200 x)	210-333/600-074	100
<input type="radio"/> L2 (1200 x)	210-333/600-075	100
<input type="radio"/> L3 (1200 x)	210-333/600-076	100
<input type="radio"/> N (1200 x)	210-333/600-077	100
<input type="radio"/> PE (1200 x)	210-333/600-078	100
<input type="radio"/> PEN (1200 x)	210-333/600-079	100
<input type="radio"/> only grid spacing	210-333/600-001	100

Marking strip; for 4-conductor terminal strips (261 Series)

<input type="radio"/> 1 ... 16 (40 x)	210-333/1000-202	100
<input type="radio"/> 17 ... 32 (40 x)	210-333/1000-204	100
<input type="radio"/> 33 ... 48 (40 x)	210-333/1000-206	100
<input type="radio"/> 49 ... 64 (40 x)	210-333/1000-110	100
<input type="radio"/> 65 ... 80 (40 x)	210-333/1000-111	100
<input type="radio"/> 81 ... 96 (40 x)	210-333/1000-112	100
<input type="radio"/> 97 ... 112 (40 x)	210-333/1000-113	100
<input type="radio"/> 1 ... 36 (20 x)	210-333/1000-208	100
<input type="radio"/> L1 (720 x)	210-333/1000-074	100
<input type="radio"/> L2 (720 x)	210-333/1000-075	100
<input type="radio"/> L3 (720 x)	210-333/1000-076	100
<input type="radio"/> N (720 x)	210-333/1000-077	100
<input type="radio"/> PE (720 x)	210-333/1000-078	100
<input type="radio"/> PEN (720 x)	210-333/1000-079	100
<input type="radio"/> only grid spacing	210-333/1000-001	100

Marking Card; Self-Adhesive Marking Strips



- Horizontal marking
- Strip length: 182 mm
- Strip height: 6 mm

Marking strip; as DIN A4 sheet; for 2-conductor terminal strips (262 Series)

Marking	Item No.	Pack. Unit
<input type="radio"/> 1 ... 20 (40 x)	210-333/700-020	100
<input type="radio"/> 21 ... 40 (40 x)	210-333/700-108	100
<input type="radio"/> 41 ... 60 (40 x)	210-333/700-109	100
<input type="radio"/> 1 ... 50 (20 x)	210-333/700-021	100
<input type="radio"/> L1 (1040 x)	210-333/700-074	100
<input type="radio"/> L2 (1040 x)	210-333/700-075	100
<input type="radio"/> L3 (1040 x)	210-333/700-076	100
<input type="radio"/> N (1040 x)	210-333/700-077	100
<input type="radio"/> PE (1040 x)	210-333/700-078	100
<input type="radio"/> PEN (1040 x)	210-333/700-079	100
<input type="radio"/> only grid spacing	210-333/700-001	100

Marking strip; for 4-conductor terminal strips (262 Series)

<input type="radio"/> 1 ... 12 (40 x)	210-333/1200-103	100
<input type="radio"/> 13 ... 24 (40 x)	210-333/1200-104	100
<input type="radio"/> 25 ... 36 (40 x)	210-333/1200-105	100
<input type="radio"/> 37 ... 48 (40 x)	210-333/1200-106	100
<input type="radio"/> 49 ... 60 (40 x)	210-333/1200-107	100
<input type="radio"/> 1 ... 24 (20 x)	210-333/1200-203	100
<input type="radio"/> L1 (600 x)	210-333/1200-074	100
<input type="radio"/> L2 (600 x)	210-333/1200-075	100
<input type="radio"/> L3 (600 x)	210-333/1200-076	100
<input type="radio"/> N (600 x)	210-333/1200-077	100
<input type="radio"/> GND (600 x)	210-333/1200-078	100
<input type="radio"/> PEN (600 x)	210-333/1200-079	100
<input type="radio"/> only grid spacing	210-333/1200-001	100

Group Marker Carrier and Marker Carrier TOPJOB® S



Group marker carrier; snap-on type for jumper slot; gray		
	Item No.	Pack. Unit
○ 5 mm wide	2009-191	50 (25)
○ 10 mm wide	2009-192	50 (25)
○ 15 mm wide	2009-193	50 (25)

Group marker carrier; snap-on type for jumper slot; gray		
	Item No.	Pack. Unit
○ 10 mm wide	2009-196	50 (25)

Marker carrier; for lateral marker slots; 5 mm wide		
Color	Item No.	Pack. Unit
○ gray	2009-198	200 (25)



2009-193 Group Marker Carrier (equipped with marking strips) for all 2001 to 2016 Series TOPJOB® S Rail-Mount Terminal Blocks.
Do not use on an end plate!



Marker carrier; for jumper slots of double-deck, double-disconnect terminal blocks (2002 Series); 5 mm wide		
Color	Item No.	Pack. Unit
○ gray	2002-160	50 (25)

Marker carrier; for jumper slots (2002 Series); 5 mm wide		
Color	Item No.	Pack. Unit
○ gray	2002-161	100 (25)



Using marker carriers for marking strips (2002-161) in jumper slots.



Using marker carriers for marking strips (2009-198) in lateral marker slots.

Multilevel Marker Carrier TOPJOB® S



Double-deck marker carrier; pivoting		
Color	Item No.	Pack. Unit
○ gray	2000-121	50 (25)



Double-deck marker carrier; pivoting		
Color	Item No.	Pack. Unit
○ gray	2002-121	50 (25)



Triple-deck marker carrier; pivoting		
Color	Item No.	Pack. Unit
○ gray	2002-131	50 (25)

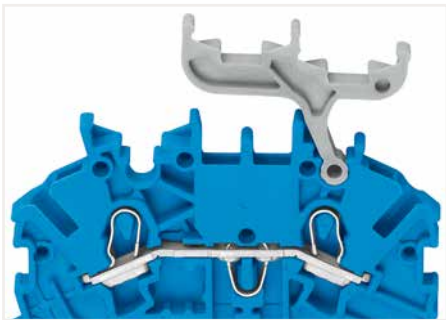

Double-deck terminal blocks:
A double-deck marker carrier (2000-121) can be retrofitted to double-deck terminal blocks without a marker carrier.

Group Marker Carriers (Adjustable in Height) and Laterally Movable Marking System

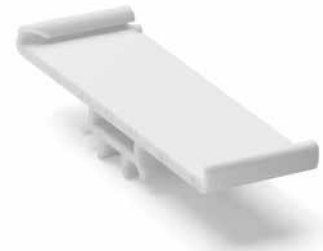

Group marker carrier; fits into jumper slot of rail-mount terminal blocks; for terminal block width 4 ... 6 mm; for up to 3 WMB markers or 8 branch markers; 15 mm wide

Color	Item No.	Pack. Unit
○ gray	209-140	50 (25)

Group marker carrier; snaps onto screwless 249-116 and 249-117 End Stops (center or side mounting); 10 mm wide

Color	Item No.	Pack. Unit
○ white	209-112	50 (25)

Group marker carrier; for WMB and Mini-WSB marker slots; 10 mm wide

Color	Item No.	Pack. Unit
○ white	209-145	100 (25)

Group marker carrier; fits into jumper slot of rail-mount terminal blocks; for up to 2 WMB markers or 5 branch markers; 10 mm wide

○ gray	209-141	50 (25)
--------	---------	---------

Marker; from white cardboard; for self-marking; 100 markers/sheet

○ white	209-113	1
---------	---------	---

Group marker carrier; fits into jumper slot of rail-mount terminal blocks; for up to 1 WMB markers or 2 branch markers; 5 mm wide

○ gray	209-142	50 (25)
--------	---------	---------

Self-adhesive marker; for self-marking; 7 x 25 markers/sheet

○ white	210-345	1
---------	---------	---

Protective marker cover

transparent	209-114	50
-------------	---------	----

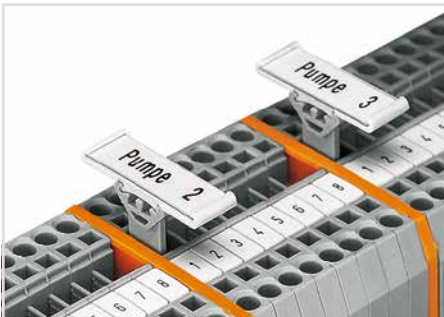

Group marker carriers (209-141 and 209-112)



Group marking on N-busbar carrier used as an end stop



Group marker carrier (209-145)



Group marker carrier (209-145)

Group Marker Carriers (Adjustable in Height) and Laterally Movable Marking System



Height-adjustable group marker carrier; snaps onto end stops (249-116 and 249-117), adjustable in height from 43.5 to 59.5 mm; for 1 marker or self-adhesive marker and transparent protection cover; 10 mm wide

Color	Item No.	Pack. Unit
○ gray	249-119	50 (25)

Height-adjustable group marker carrier; snaps onto end stops (249-116 and 249-117), adjustable in height from 43.5 to 59.5 mm; for 2 WMB markers or 1 continuous strip; 10 mm wide

○ gray	249-118	100 (25)
--------	---------	----------

Height-adjustable group marker carrier; snaps onto end stops (249-116 and 249-117), adjustable in height from 42.2 to 58.2 mm; with marking surface; 6 mm wide

○ white	249-120	50 (25)
---------	---------	---------

Height-adjustable group marker carrier; snaps onto end stops (249-116 and 249-117), adjustable in height from 45 to 61 mm; for 9 WMB markers or 1 TOPJOB® S marking strip; 12.2 mm wide

○ gray	2009-163	50 (25)
--------	----------	---------



Carrier-through element; height-adjustable; snaps onto end stops (249-116 and 249-117)

Color	Item No.	Pack. Unit
○ gray	709-118	50 (25)

Carrier-end element; height-adjustable; snaps onto end stops (249-116 and 249-117)

○ gray	709-119	50 (25)
--------	---------	---------



Receptacles for:
 1 x marker
 2 x WMB Multi marker or
 1 x WFB continuous marking strip

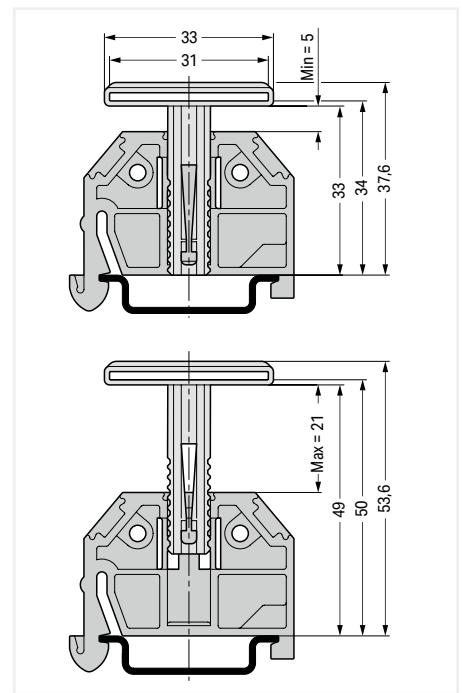

Dimensions in mm

Accessories; item-specific

Marking strip receptacle; folded; 1 m long; 16 mm wide; 1.7 mm thick

transparent	709-120	1
-------------	---------	---

Marking card; with 14 marking strips; DIN A4

	709-193	1
--	---------	---



Height adjustable group marker carrier (249-116) for marking strips (2009-110)



This laterally movable marking system can be used as an additional group marker carrier or continuous marking strip carrier for terminal strips or single-deck rail-mount terminal blocks, e.g., for:

- DIN-35 rail-mount terminal strips (264 Series)
- Single-deck rail-mount terminal blocks (279 to 284 Series) with a maximum height of 49 mm (1.93 inch) from upper-edge of DIN-rail (please observe conductor radius)

Group Marker Carrier and Double Marker Carrier

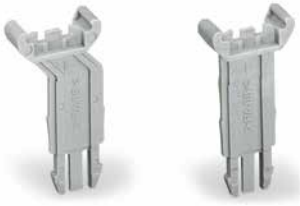

Group marker carrier; angled; e.g., for transformer terminal blocks (282 Series)

Color	Item No.	Pack. Unit
○ gray	209-144	50 (25)

Double marker carrier; for center I/O module marking; for WSB and WMB marking systems; 4 mm wide

Color	Item No.	Pack. Unit
○ gray	209-128	200 (100)

Group marker carrier; straight; e.g., for 2- and 3-conductor terminal blocks (282 Series)

Color	Item No.	Pack. Unit
○ gray	209-143	50 (25)



This group marker carrier (209-144) makes it possible to mark subgroups in confined places. They can be snapped into unused jumper contact slots of the terminal block housing. Labeling is performed via WMB Multi markers.



Snapping a WMB marker strip into the marker slot of the double marker carrier.

Group Marker Carrier (Pivoting) and WFB Continuous Marking Strip

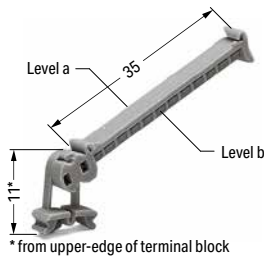

Pivoting group marker carrier

Color	Item No.	Pack. Unit
○ gray	249-105	50 (25)

Marker; 4 x 30 markers/sheet

○ white	209-183	1
---------	---------	---

Protective marker cover

transparent	209-184	50
-------------	---------	----

WFB continuous marking strip; 1000 mm long; for self-marking; e.g., with felt-tip pen

Color	Item No.	Pack. Unit
transparent	210-612	10

Carrier for WFB continuous marking strip; snaps into marker slot

○ gray	209-185	200 (25)
--------	---------	----------

Accessories; item-specific

Felt-tip pen; for permanent marking

	210-110	200 (1)
--	---------	---------

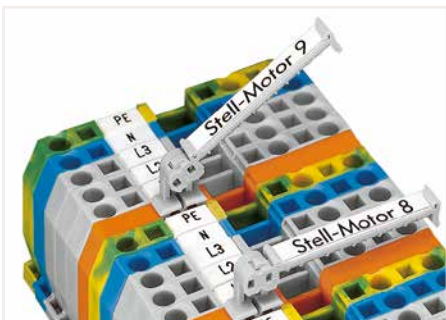

This pivoting group marker carrier has been developed for group marking of rail-mount terminal blocks and incorporates many customer requirements.

- Can be used in all multiprofile marker slots for rail-mount terminal blocks from 5 mm (0.197 inch) on or in spacer housings as shown above.
- Pivotal in seven different stable positions, providing the best visual angle in case of difficult mounting conditions



WFB continuous marking strip
Customized ink pen marking



Carrier for WFB Continuous marking strips, to be fixed every 10th terminal block.

Thermal Transfer Printer Smart Printer



Open the printer.



Printer – open



Accessories for unwinding material



Insert the ink ribbon.



Prepare the marking material.



Insert and secure the appropriate roller into the printer.



Printer has several interfaces:
USB, ETHERNET, serial COM port



Fast, cost-effective and easy to use –
printing WMB Inline markers via Smart Printer

Thermal Transfer Printer and Cutter Smart Printer



Smart Printer; WMB Inline markers; Marking strips; Conductor markers and labels; Resolution: 300 dpi

Item No.	Pack. Unit
258-5000	1

Smart Printer

includes:

- Power supply and cable
- USB cable
- 1 x marking strip reel (2009-110)
- 1 x WMB Inline marker reel (2009-115)
- 2 x roller (258-5006 + 258-5007)
- 1 x reel holder
- 1 x ink ribbon (258-5005)

Technical Data

Printing method	Thermal transfer
Print head	Glass layer, spring-mounted
Print speed (max.)	127 mm/s (WAGO recommends 50.8 mm/s)
Print width (max.)	47 mm
Print length (max.)	762 mm
Print resolution	300 dpi (12 pixels/mm)
See-through/reflective sensor	Yes, centrally mounted
Operating display	Color TFT LCD with navigation button
Memory	8 MB Flash, 16 MB SDRAM
Interfaces	USB, RS-232, ETHERNET 10/100 Mbps, USB Host
Operating voltage	100 ... 240 VAC, 50 ... 60 Hz (automatic adjustment)
Dimensions (mm) W x H x D	135 x 175 x 245
Weight	2000 g (without printing material)
Operating temperature	5 ... 40 °C (41 ... 104 °F)
Storage temperature	-20 ... 50 °C (-4 ... 122 °F)
Safety approvals	CE (EMC)
Ink ribbon (see also Full Line Catalog, Volume 6, Marking)	External roll diameter: 40 mm; Internal core diameter: 12.7 mm (0.5 inch); Max. length: 110 m; Max. width: 58 mm



Cutter for Smart Printer; for marking strips only; not suitable for WMB Inline markers

Item No.	Pack. Unit
258-5030	1

Hardware requirements:

- Printer model: Smart Printer
- From manufacturing month/year: 0814 – August 2014
- Firmware version: 1.UW7i
- Printer driver: Version 7.4.2

Software requirements:

- Smart Script: Version 3.88.9.0 or higher
- WAGO printer settings: Version 2.4.0.0 or higher

Approved print material to be cut:

- Marking strips: 2009-110, 709-177, 709-178, 757-901/000-005
- Self-adhesive marking strips: 210-702, 210-870 ... -877
- Cable tie markers: 211-835 ... -836, 211-836/000-002
- Self-laminating labels: 211-855 ... -857
- Conductor markers for thread-on mounting: 211-861 ... -863
- Type labels: 210-801 ... -804, 210-812
- Continuous labels: 210-831 ... -834
- Label for circuit identification: 210-813

Dimensions of printing materials:

- Width (max.): 46 mm
- Thickness (max.): 250 µm

Technical Data

Width	60 mm
Height	107 mm
Depth	131 mm
Weight	1050 g

Control Cabinet Outlet and Switch Cabinet Drawer 709 Series

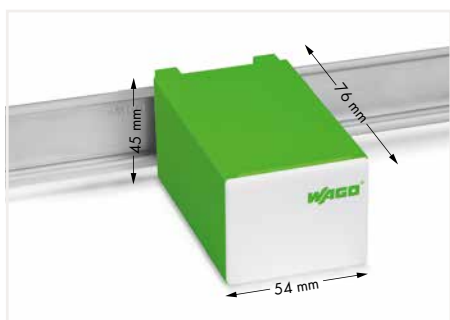

Technical Data	
Ratings per	DIN VDE 0620-1
Voltage type	AC
Rated voltage	250 V
Rated surge voltage	2 kV
Rated current	16 A

Connection Data	
Connection technology	Push-in CAGE CLAMP®
Actuation type	Type 2 (3.5 x 0.5) mm blade
Actuation direction	Operation parallel to conductor entry
Connectable conductor materials	Copper
Solid conductor	0.2 ... 2.5 mm / 24 ... 14 AWG
Stranded conductor	0.2 ... 2.5 mm / 24 ... 14 AWG
Fine-stranded conductor	0.2 ... 2.5 mm / 24 ... 14 AWG
Strip length	9 ... 10 mm / 0.35 ... 0.39 inch
Number of poles	3

Mechanical Data	
Mounting type	DIN-35 rail
Protection type	IP20
Potential marking	L GND N

Material Data	
Material group	I
Insulation material	Polyamide 66 (PA 66)
Flammability class per UL94	V0
Clamping spring material	Chrome nickel spring steel (CrNi)
Contact material	Copper alloy
Contact plating	Sn

Environmental Requirements	
Continuous operating temperature from	-35 °C
Continuous operating temperature up to	85 °C

- ❶ The outlets are available in three colors to identify different circuits:
- 709-581 gray (standard)
 - 709-582 yellow (permanently energized)
 - 709-583 red (UPS)

Approvals and corresponding ratings, visit www.wago.com

Control Cabinet Outlet and Switch Cabinet Drawer 709 Series



Dimensions in mm

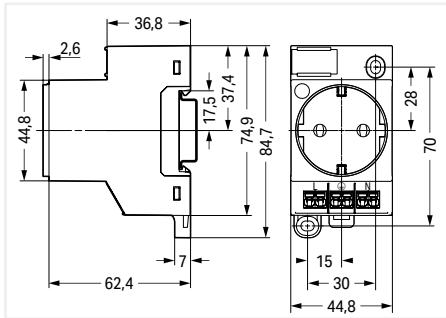

Dimensions in mm

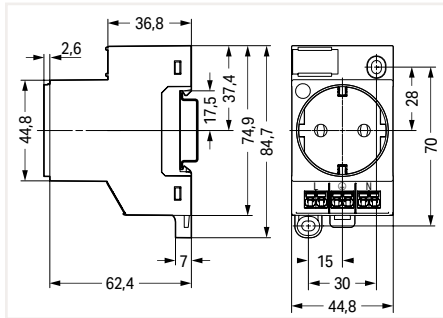

Dimensions in mm

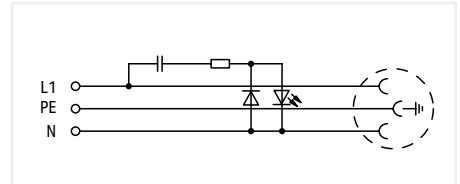
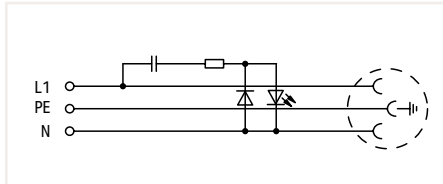
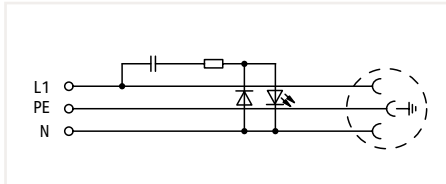
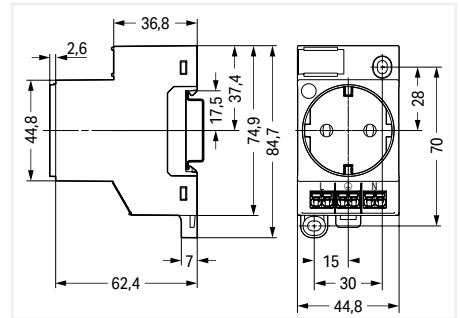

Control cabinet outlet; for DIN-35 rail and screw mounting; for plug Type F, CEE 7/4 (SCHUKO®); used in Germany, the Netherlands, Austria; with status LED; with Push-in CAGE CLAMP® double connection

Color	Item No.	Pack. Unit
○ light gray	709-581	1

Control cabinet outlet; for DIN-35 rail and screw mounting; for plug Type F, CEE 7/4 (SCHUKO®); used in Germany, the Netherlands, Austria; with status LED; with Push-in CAGE CLAMP® double connection

Color	Item No.	Pack. Unit
● yellow	709-582	1

Control cabinet outlet; for DIN-35 rail and screw mounting; for plug Type F, CEE 7/4 (SCHUKO®); used in Germany, the Netherlands, Austria; with status LED; with Push-in CAGE CLAMP® double connection

Color	Item No.	Pack. Unit
● red	709-583	1



Dimensions in mm

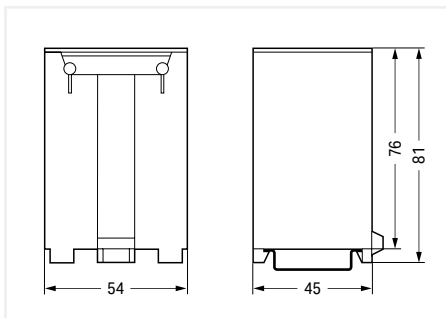

Switchgear cabinet drawer; DIN-35 rail-mount drawer

Item No.	Pack. Unit
709-591	1

DIN-Rail; Rail End Cap; Angled Support Bracket and Collective Jumper Carrier



Dimensions in mm

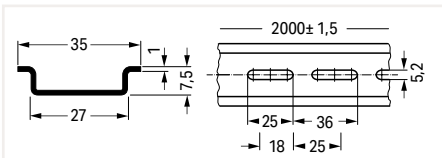

Steel DIN-rail; I_N 76 A (based on 1 m length); 35 x 7.5 mm; 1 mm thick; 2 m long; per EN 60715

	Item No.	Pack. Unit
unslotted	210-113	10 (1)

Hole width: 25 mm; Hole spacing: 36 mm

slotted	210-112	10 (1)
---------	---------	--------

Hole width: 18 mm; Hole spacing: 25 mm

slotted	210-115	1
---------	---------	---



Dimensions in mm

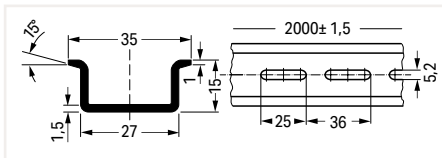

Steel DIN-rail; I_N 125 A (based on 1 m length); 35 x 15 mm; 1.5 mm thick; 2 m long; similar to EN 60715

	Item No.	Pack. Unit
unslotted	210-114	10 (1)
slotted	210-197	10 (1)



Dimensions in mm

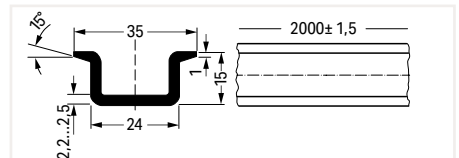

Steel DIN-rail; I_N 125 A (based on 1 m length); 35 x 15 mm; 2.3 mm thick; 2 m long; per EN 60715

	Item No.	Pack. Unit
unslotted	210-118	10 (1)



Dimensions in mm

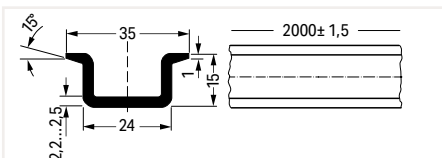

Copper DIN-rail; I_N 309 A (based on 1 m length); 35 x 15 mm; 2.3 mm thick; 2 m long; per EN 60715

	Item No.	Pack. Unit
unslotted	210-198	10 (1)



Dimensions in mm

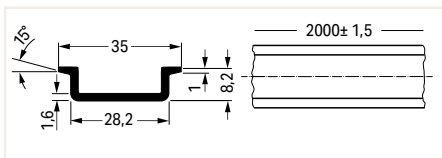

Aluminum DIN-rail; I_N 76 A (based on 1 m length); 35 x 8.2 mm; 1.6 mm thick; 2 m long; similar to EN 60715

	Item No.	Pack. Unit
unslotted	210-196	20 (1)



Rail end cap; for DIN-35 rail (7.5 mm high)

Color	Item No.	Pack. Unit
○ gray	209-109	50 (25)

13



Dimensions in mm

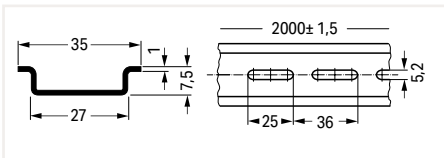

Steel DIN-rail; I_n 76 A (based on 1 m length); 35 x 7.5 mm; 1 mm thick; 2 m long; per EN 60715

	Item No.	Pack. Unit
unslotted	210-505	1
slotted	210-504	1



Dimensions in mm

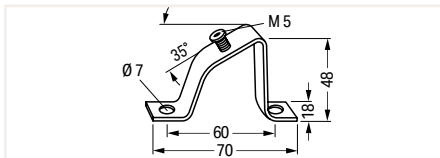

Angled support bracket; without screw

	Item No.	Pack. Unit
	210-148	10

Screw M5 x 8		
	210-149	100 (20)

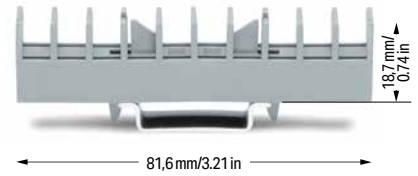

Collective jumper carrier; for DIN-35 rail; compatible with jumpers for transverse switching terminal block (282-811) and longitudinal switching disconnect terminal block (282-821)
The collective carrier can be snapped onto DIN-35 rails. It stores jumpers during maintenance.

Color	Item No.	Pack. Unit
○ gray	282-369	25



Dimensions in mm

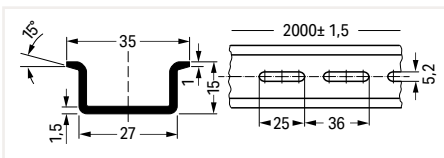

Steel DIN-rail; I_n 125 A (based on 1 m length); 35 x 15 mm; 1.5 mm thick; 2 m long; per EN 60715

	Item No.	Pack. Unit
unslotted	210-506	1
slotted	210-508	1



Collective carrier for adjacent jumpers; for DIN-35 rail; for adjacent jumpers (279 to 284 Series); for banana plugs (215 Series)
The collective carrier can be snapped onto DIN-35 rails. It stores adjacent jumpers and banana plugs during maintenance.

Color	Item No.	Pack. Unit
○ gray	209-100	50 (25)

Screwless End Stop; for DIN-35 Rail 249 Series



Screwless end stop; for DIN-35 rail; 6 mm wide

Color	Item No.	Pack. Unit
○ gray	249-116	100 (25)

Screwless end stop; for DIN-35 rail; 10 mm wide

○ gray	249-117	50 (25)
--------	---------	---------



Simply snap on – that's it!



Simply snap on – that's it!



Screwless end stop; for DIN-35 rail; 14 mm wide

Color	Item No.	Pack. Unit
○ gray	249-197	10



Simply snap on – that's it!

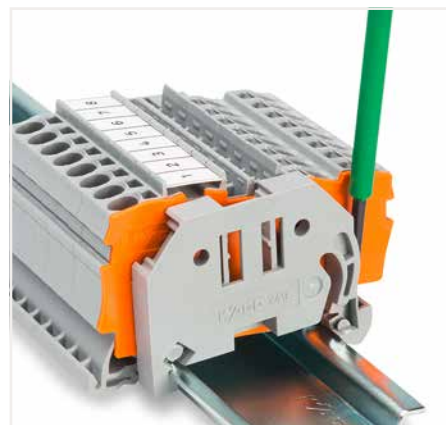

Removing an end stop from the DIN-rail.

Snap on – that's it! Assembling the WAGO Screwless End Stop is as simple and quick as snapping a rail-mount terminal block onto the rail.

Tool free!

A tool-free design allows rail-mount terminal blocks to be safely and economically secured against any movement on all DIN-35 rails per DIN EN 60715 (35 x 7.5 mm; 35 x 15 mm).

Screwless!

The "secret" to a perfect fit lies in the two small clamping plates which keep the end stop in position, even if the rails are mounted vertically.

Simply snap on – that's it!

In addition, costs are significantly reduced when using large numbers of end stops.

Additional benefit: Three marker slots for all WAGO Rail-Mount Terminal Block Marking Systems and one snap-in hole for WAGO's adjustable height group marker carriers offer individual marking options.

Mounting Foot



Mounting foot; for isolated DIN-35 rail mounting

Color	Item No.	Pack. Unit
<input type="radio"/> gray	209-106	25



Double-deck terminal blocks:

A double-deck marker carrier (2000-121) can be retrofitted to double-deck terminal blocks without a marker carrier.

Sealable, Transparent Covers for Rail-Mount Terminal Blocks

709 Series

Description and Installation

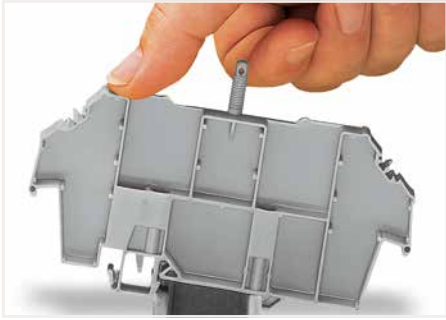

Snapping a cover carrier onto the DIN-rail.



Application example:
Cover (type 1) without safety warning



Application example:
Cover (type 1) with safety warning

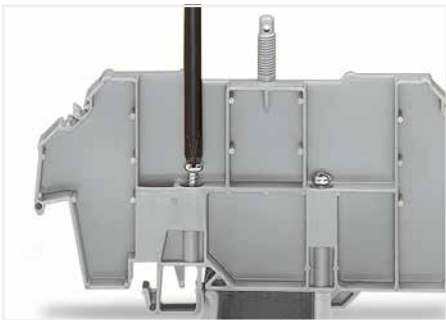

Tightening both securing screw (left) and mounting screw (right).



Application example:
Cover (type 2) with safety warning

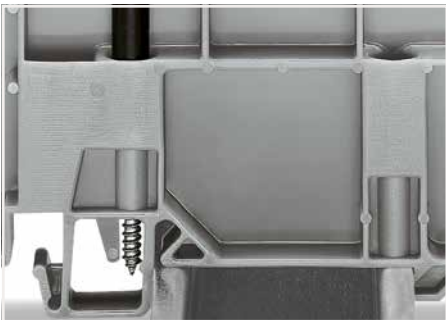

Securing screw – prevents lifting off from the rail.
Mounting screw – prevents the cover carrier from being moved on the rail.

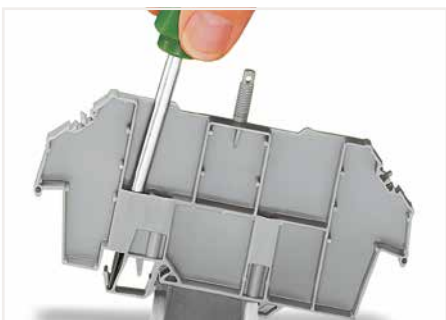

Removing a cover carrier from the DIN-rail.



Inserting a marking strip into the cover.



Cover with lead seals:
Using covers without lead seals,
the thread dome-head can be broken off.

Sealable, Transparent Cover; for Rail-Mount Terminal Blocks 709 Series



Cover; Type 1; for cover carrier (type 1); 1 m long		
Color	Item No.	Pack. Unit
transparent	709-153	10

Cover; Type 2; for cover carrier (type 2); 1 m long		
Color	Item No.	Pack. Unit
transparent	709-154	10

Accessories

Marking card; with 6 marking strips; for group marking or safety instructions

	plain	709-183	1
--	-------	---------	---

Spare mounting/securing screw; for cover

		209-196	200 (25)
--	--	---------	----------

Spare knurled nut; for cover

		210-549	100 (25)
--	--	---------	----------



Cover carrier; Type 1; incl. mounting/securing screws and knurled nut; for rail-mount terminal blocks (279 to 282, 880 Series); for "Mini" rail-mount terminal blocks (264 Series); for sensor/actuator terminal blocks (270 Series)

Color	Item No.	Pack. Unit
○ gray	709-167	10

Cover carrier; Type 2; incl. mounting/securing screws and knurled nut; for rail-mount terminal blocks (283 to 285 Series); for double- and triple-deck terminal blocks (279 to 281 Series); for TOPJOB® rail-mount terminal blocks (780 to 785 and 775 Series); for sensor/actuator terminal blocks (280 Series); for disconnect/test terminal blocks for transformer circuits (282 Series)

Color	Item No.	Pack. Unit
○ gray	709-168	10

Dimensions in mm

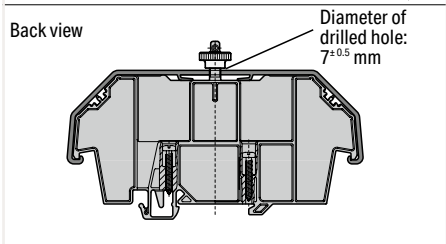
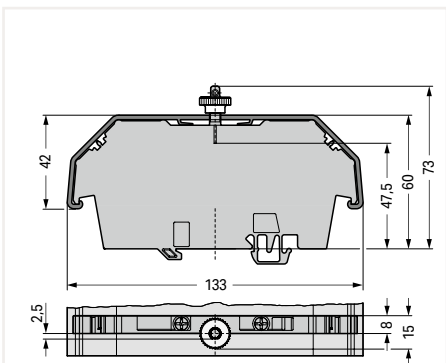

Dimensions in mm

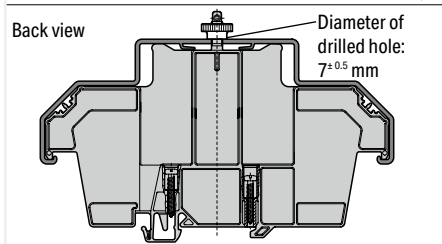
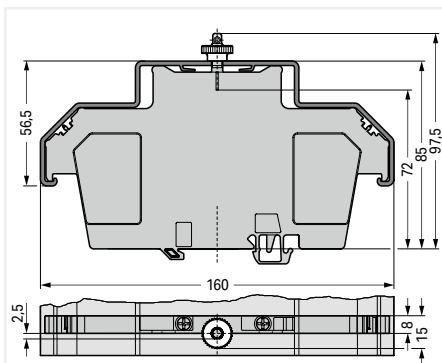



Sealable, Transparent Cover; for Rail-Mount Terminal Blocks 709 Series



Cover; Type 3; for cover carrier (type 3); 1 m long		
Color	Item No.	Pack. Unit
transparent	709-156	10

Accessories			
Marking card; with 6 marking strips; for group marking or safety instructions			
	plain	709-183	1

Spare mounting/securing screw; for cover			
		209-196	200 (25)

Spare knurled nut; for cover			
		210-549	100 (25)



Cover carrier; Type 3; for rail-mount terminal blocks (2000 to 2016 Series, 2102 to 2116 Series, 2200 to 2216 Series); for transformer terminal blocks (2007 Series)		
Color	Item No.	Pack. Unit
 gray	709-169	10

Dimensions in mm

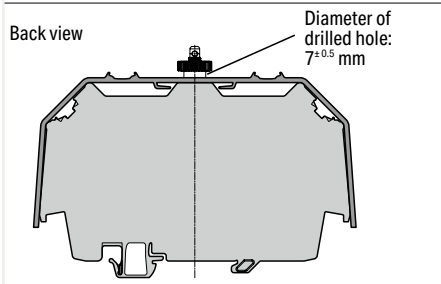
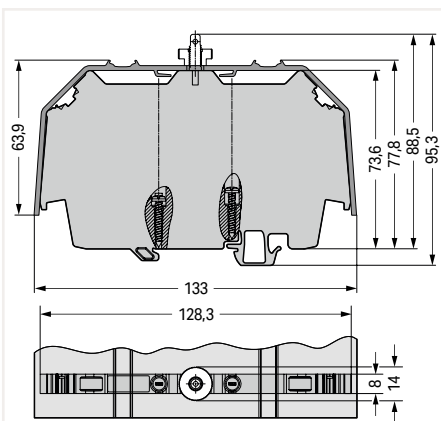

13

DIN-Rail and End Stop; for DIN-15 Rail



Dimensions in mm

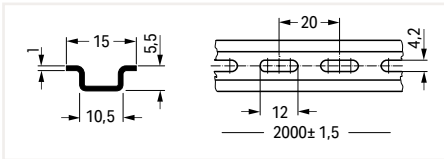

Steel DIN-rail; l, 57 A (based on 1 m length); 15 x 5.5 mm; 1 mm thick; 2 m long; per EN 60715

	Item No.	Pack. Unit
slotted	210-111	10 (1)



Dimensions in mm

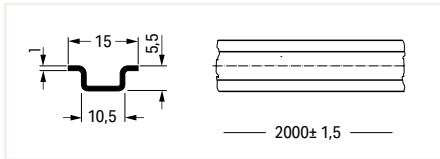

Aluminum DIN-rail; l, 57 A (based on 1 m length); 15 x 5.5 mm; 1 mm thick; 2 m long; similar to EN 60715

	Item No.	Pack. Unit
unslotted	210-296	10 (1)



Screwless end stop; for DIN-15 rail; 6 mm wide; for WMB markers

Color	Item No.	Pack. Unit
○ gray	249-101	25



Dimensions in mm

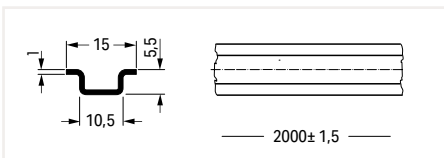

Steel DIN-rail; l, 57 A (based on 1 m length); 15 x 5.5 mm; 1 mm thick; 2 m long; per EN 60715

	Item No.	Pack. Unit
unslotted	210-295	1

Sold & Serviced By:
ELECTROMATE

Toll Free Phone (877) SERV098
www.electromate.com
sales@electromate.com

Operating Tool



Operating tool with a partially insulated shaft; Type 1; (2.5 x 0.4) mm blade

Item No.	Pack. Unit
210-719	50 (1)



Operating tool; Blades: 3.5 mm and 2.5 mm; for installation terminal blocks (TOPJOB® S)

Item No.	Pack. Unit
2009-309	1



Operating tool with a partially insulated shaft; Type 1; (2.5 x 0.4) mm blade; short

Item No.	Pack. Unit
210-647	50 (1)

Operating tool with a partially insulated shaft; Type 2; (3.5 x 0.5) mm blade

210-720	50 (1)
---------	--------

Operating tool; Blades: 3.5 mm and 5.5 mm; for installation terminal blocks (TOPJOB® S)

2009-310	1
----------	---

Operating tool with a partially insulated shaft; (2.5 x 0.4) mm blade; short; angled

210-648	50 (1)
---------	--------

Operating tool with a partially insulated shaft; Type 3; (5.5 x 0.8) mm blade

210-721	25 (1)
---------	--------

Operating tool with a partially insulated shaft; (3.5 x 0.5) mm blade; short

210-657	50 (1)
---------	--------

Set of operating tools with a partially insulated shaft; Type 1; (2.5 x 0.4) mm blade; Type 2; (3.5 x 0.5) mm blade; Type 3; (5.5 x 0.8) mm blade

210-722	1
---------	---

Operating tool with a partially insulated shaft; (3.5 x 0.5) mm blade; short; angled

210-658	50 (1)
---------	--------

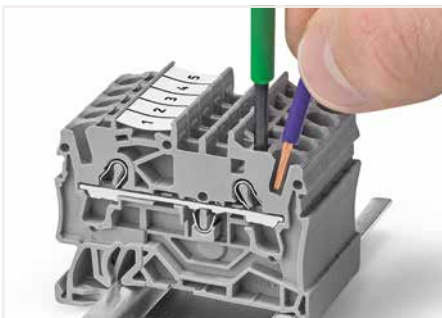

The blade of this operating tool with a partially insulated shaft is ideal for operating front-entry terminal blocks.



Open the clamping unit using an operating tool.

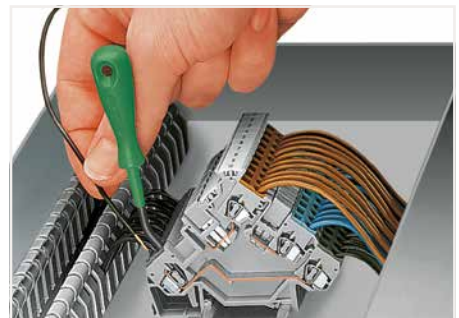

This operating tool with blade dimensions per DIN 5264 is ideal for front-entry sensor/actuator terminal blocks (280 Series).



Set of operating tools in a box (210-722)

Operating Tool



Operating tool; insulated; for 279 Series

	Item No.	Pack. Unit
1-way	209-129	1
2-way	279-432	1
3-way	279-433	1
10-way	279-440	1



Operating pliers; for side-entry rail-mount terminal blocks (281, 282, 283 and 284 Series)

	Item No.	Pack. Unit
	210-141	1



T-wrench with a partially insulated shaft

	Item No.	Pack. Unit
	285-172	1

Operating tool; insulated; for 264 Series (1- and 2-way only), 280, 281 Series (up to 3-way only)

	Item No.	Pack. Unit
1-way	209-130	1
2-way	280-432	1
3-way	280-433	1
4-way	280-434	1
5-way	280-435	1
6-way	280-436	1
7-way	280-437	1
8-way	280-438	1
9-way	280-439	1
10-way	280-440	1

Operating pliers; for side-entry rail-mount terminal blocks (279 and 280 Series)

	Item No.	Pack. Unit
	210-143	1

T-wrench with a partially insulated shaft and anti-rotation protection

	Item No.	Pack. Unit
	285-173	1

Operating tool; insulated; for 281 Series

	Item No.	Pack. Unit
5-way	281-440	1



Commoning front-entry disconnect terminal blocks via comb-style jumper bar using a 10-pole operating tool.

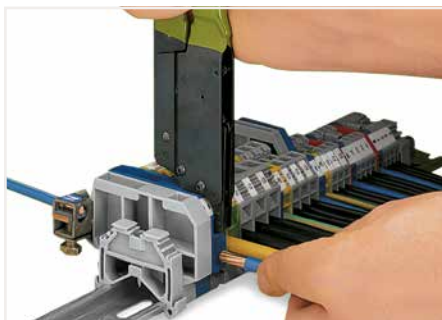

When operating the handles beyond the locked position, the ratchet allows the tool to open and be removed from the terminal block. The operating pliers are placed into the upper operating slot of the rail-mount terminal block and the clamp is hooked into the lateral operating slot. The contact is fully opened by pressing the handles together until they engage. This will allow both hands to be used for wiring the terminal blocks.



T-wrench with a partially insulated shaft and anti-rotation protection (285-173)

Cable Stripper

Never use this tool on or near live electrical circuits!



Cable knife; for Ø 8 ... 28 mm / 0.31 ... 1.10 inch; with a unique, changeable cable bracket system; including cable bracket

Item No.	Pack. Unit
206-1403	1

Cable knife set; for Ø 4 ... 70 mm / 0.16 ... 2.75 inch; including all cable brackets in a Sortimo® Box

Item No.	Pack. Unit
206-1400	1

Item-Specific Accessories

Cable bracket; for Ø 4 ... 16 mm / 0.16 ... 0.63 inch

206-1411	1
----------	---

Cable bracket; for Ø 8 ... 28 mm / 0.31 ... 1.10 inch

206-1412	1
----------	---

Cable bracket; for Ø 27 ... 35 mm / 1.06 ... 1.38 inch

206-1413	1
----------	---

Cable bracket; for Ø 35 ... 50 mm / 1.38 ... 1.97 inch

206-1414	1
----------	---

Cable bracket; for Ø 50 ... 70 mm / 1.97 ... 2.75 inch

206-1415	1
----------	---

Accessories

Spare inside blade

206-1418	3
----------	---

Spare hook blade

206-1419	1
----------	---



Cable Stripper



In-socket cable stripper; for Ø 8 ... 13 mm / 5/16 ... 1/2 inch

Item No.	Pack. Unit
206-1441	1



Universal cable stripper; for Ø 8 ... 13 mm / 5/16 ... 1/2 inch

Item No.	Pack. Unit
206-1442	1



Data cable stripper; for Ø 4.5 ... 10 mm / 3/16 ... 3/8 inch

Item No.	Pack. Unit
206-1451	1



Product features:

- Extra long design and improved force transmission simplifies stripping in deep device connection sockets
- Special four-blade design for an even more precise round cut
- No cutting depth adjustment required
- TiN-coated blades, TÜV/GS tested
- Ø 8 ... 13 mm / 5/16 ... 1/2 inch
- Strips all standard round cables, including NYM 3 x 1.5 mm²/16 AWG ... 5 x 2.5 mm²/14 AWG



Sheath stripping: longitudinal cut

Product features:

- Secure grip achieved with soft padding for non-slip grips
- Technically improved functionality
- New locking mechanism prevents the unwanted opening of the tool
- Absolutely straightforward, quick and easy longitudinal cuts – with innovative internal cable duct
- Redesigned blade layout and intake to stop cable waste from jamming the tool
- Durable and ergonomically designed pocket clip
- Ø 8 ... 13 mm / 5/16 ... 1/2 inch



Product features:

- Strip outer insulation and foil sheathing with one tool
- Ideal for stripping PVC-insulated data cables with thin insulation (e.g., Cat. 5, Cat. 6, Cat. 7, twisted pair cable)
- TiN-coated blades
- Ø 4.5 ... 10 mm / 3/16 ... 3/8 inch



Stripping a cable sheath.



Built-in handy knife



Stripping a wire insulation.

Cable Stripper



Stripping pliers; for sensor cables; for Ø 3.2 ... 4.4 mm / 0.13 ... 0.17 inch

Item No.	Pack. Unit
206-1481	1

Item-Specific Accessories

Replacement blade set; for Ø 3.2 ... 4.4 mm / 0.13 ... 0.17 inch

206-1491	1
----------	---

Stripping pliers; for control cables; for Ø 4.4 ... 7 mm / 0.17 ... 0.27 inch

Item No.	Pack. Unit
206-1482	1

Item-Specific Accessories

Replacement blade set; for Ø 4.4 ... 7 mm / 0.17 ... 0.27 inch

206-1492	1
----------	---

Never use this tool on or near live electrical circuits!

The stripping pliers for sensor cables have a blade geometry specially designed for sensor cables with a smaller cross section and a working range from Ø 3.2 mm / 0.13 inch (for stranded cables and round cables with Ø 3.2 mm ... 4.4 mm / 0.13 ... 0.17 inch).

The stripping pliers for control cables are designed for stronger cables from Ø 4.4 mm / 0.17 inch (for stranded cables and round cables with Ø 4.4 mm ... 7 mm / 0.17 ... 0.27 inch).

These stripping pliers quickly and safely strip cables for connecting, e.g., sensor/actuator distribution boxes, bus couplers and pluggable connectors.

Suitable for:

- Halogen-free PUR sensor/actuator cables
- Highly flexible TPE-U cables
- Control cables
- PUR cables
- PUR/PVC cables
- PVC cables
- Multi-core cables
- Shielded and unshielded cables



Wire Stripper



Wire stripper "Quickstrip Vario"; 0.03 ... 16 mm² / 34 ... 6 AWG; with wire cutter

	Item No.	Pack. Unit
	206-1125	1

Accessories

Blade set; Standard; 0.03 ... 16 mm² / 34 ... 6 AWG

206-1126 1

Blade set; V-blade; 0.14 ... 4 mm² / 24 ... 12 AWG

206-1127 1

Blade set; Oval blade; 10 ... 16 mm² / 8 ... 6 AWG

206-1128 1

Spare stripping stop

206-1129 1

Spare cut protector

206-1131 1

Spare clamping jaws

206-1132 1

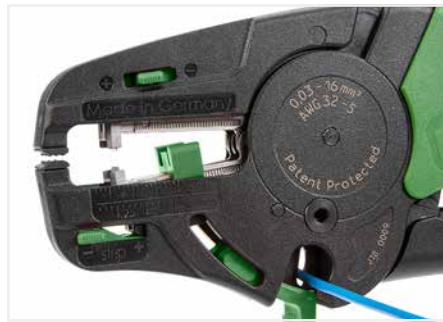

Cutting a conductor.



Partially stripping a conductor.

Wire Stripper:

- Automatically adjust to conductor size
- Stripping blades cause no damage to conductor strands
- Gripping pressure of jaws adjusts automatically to conductor insulation diameter
- Clamping jaws and stripping blades automatically open once the stripping process is completed – no splaying of the conductor strands
- Exact strip length may be set by sliding black setting stop
- Stripping blades can be replaced
- Self-sharpening, fully protected cutter (replaceable)
- Entire body made of glass-fiber-reinforced polyamide
- Cutting capacity of the wire cutter of fine-stranded conductors up to 16 mm² (6 AWG)

Crimping Tool



Crimping tool "Variocrimp 4"; for insulated and uninsulated ferrules; Crimping range: 0.25 ... 4 mm² (24 ... 12 AWG)

Item No.	Pack. Unit
206-1204	1

Crimping tool "Variocrimp 16"; for insulated and uninsulated ferrules; Crimping range: 6 mm² (10 AWG), 10 mm² (8 AWG) and 16 mm² (6 AWG)

Item No.	Pack. Unit
206-1216	1

Spring clamp; large	Pack. Unit
206-1205	1

Spring clamp; small	Pack. Unit
206-1206	1

Spring clamp; small	Pack. Unit
206-1206	1

PUR spring set	Pack. Unit
206-1207	1

Application notes:

- The built-in crimping pressure control of "Variocrimp 4" automatically adjusts the crimping force to the conductor cross section. Select the wire gauge on "Variocrimp 16" before crimping.
- Only one crimping station is needed to handle the specified conductor range.
- Uniform, compact crimping on all four sides for high conductor retention.
- No need to center the ferrules into the terminal blocks.
- Crimping can be performed from either side (for left- or right-handed users).
- Built-in ratchet mechanism ensures gas-tight crimp connection.
- Crimping tools open automatically after crimping operation is complete.
- Ergonomically designed handles.

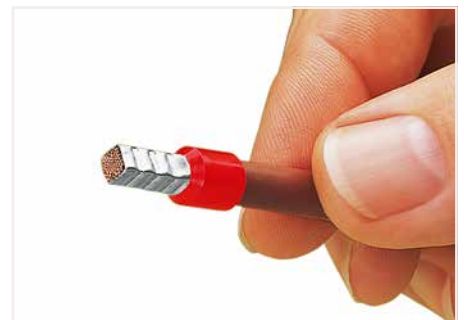

A perfect gas-tight crimp – both electrically and mechanically reliable



Insert the ferruled conductor into the crimping station.



Squeeze handles until ratchet mechanism is released.



Only for "Variocrimp 16":
Adjust conductor cross section with crimping tool in open position.

Insulated ferrule; for Rail-Mount Terminal Block TOPJOB® S

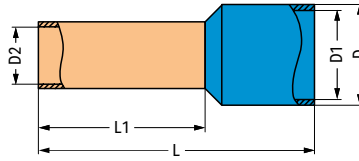

Ferrule; insulated; electro-tin-plated; electrolytic copper; gastight crimped; per DIN 46288 (Part 4/09.09)

Conductor Cross Section	Color	Strip Length	L	L 1	D	D 1	D 2	Item No.	Pack. Unit
0.5 mm ² / 20 AWG	○ white	12 mm / 0.47 inch	16	10	3,1	2,6	1	216-241	1000
0.75 mm ² / 18 AWG	○ gray	12 mm / 0.47 inch	16	10	3,3	2,8	1,2	216-242	1000
0.75 mm ² / 18 AWG	○ gray	14 mm / 0.55 inch	18	12	3,3	2,8	1,2	216-262	1000
1 mm ² / 18 AWG	● red	12 mm / 0.47 inch	16	10	3,5	3	1,4	216-243	1000
1 mm ² / 18 AWG	● red	14 mm / 0.55 inch	18	12	3,5	3	1,4	216-263	1000
1.5 mm ² / 16 AWG	● black	12 mm / 0.47 inch	16	10	4	3,5	1,7	216-244	1000
1.5 mm ² / 16 AWG	● black	14 mm / 0.55 inch	18	12	4	3,5	1,7	216-264	1000
1.5 mm ² / 16 AWG	● black	20 mm / 0.79 inch	24	18	4	3,5	1,7	216-284	500
2.5 mm ² / 14 AWG	● blue	12 mm / 0.47 inch	17	10	4,7	4,2	2,2	216-246	1000
2.5 mm ² / 14 AWG	● blue	14 mm / 0.55 inch	19	12	4,7	4,2	2,2	216-266	1000
2.5 mm ² / 14 AWG	● blue	20 mm / 0.79 inch	25	18	4,7	4,2	2,2	216-286	500
4 mm ² / 12 AWG	○ gray	14 mm / 0.55 inch	20	12	5,4	4,8	2,8	216-267	500
4 mm ² / 12 AWG	○ gray	20 mm / 0.79 inch	26	18	5,4	4,8	2,8	216-287	100
6 mm ² / 10 AWG	● yellow	14 mm / 0.55 inch	20	12	6,9	6,3	3,5	216-208	100
6 mm ² / 10 AWG	● yellow	20 mm / 0.79 inch	26	18	6,9	6,3	3,5	216-288	100
10 mm ² / 8 AWG	● red	20 mm / 0.79 inch	28	18	8,4	7,6	4,5	216-289	100
16 mm ² / 6 AWG	● blue	23 mm / 0.91 inch	28	18	9,6	8,8	5,8	216-210	100

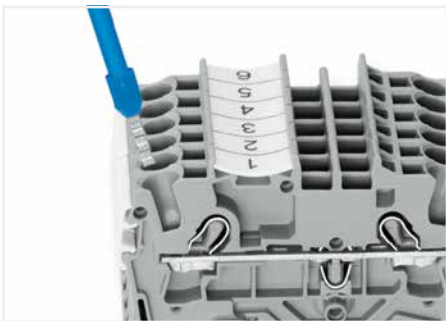

Fine-stranded conductors with ferrules from at least two sizes below the rated cross section up to the rated cross section can also be simply pushed in – without tools.

Insulated and Uninsulated Ferrules; for Chassis-Mount Terminal Strip

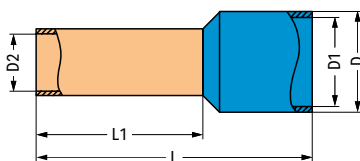

Ferrule; insulated; electro-tin-plated; electrolytic copper; gastight crimped; per DIN 46288 (Part 4/09.09)

Conductor Cross Section	Color	Strip Length	L	L 1	D	D 1	D 2	Item No.	Pack. Unit
0.5 mm ² / 20 AWG	○ white	12 mm / 0.47 inch	16	10	3,1	2,6	1	216-241	1000
0.75 mm ² / 18 AWG	○ gray	12 mm / 0.47 inch	16	10	3,3	2,8	1,2	216-242	1000
1 mm ² / 18 AWG	● red	12 mm / 0.47 inch	16	10	3,5	3	1,4	216-243	1000
1.5 mm ² / 16 AWG	● black	12 mm / 0.47 inch	16	10	4	3,5	1,7	216-244	1000

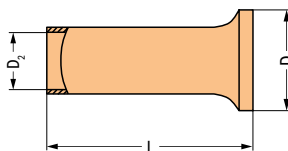

Ferrule; uninsulated; electro-tin-plated; electrolytic copper; gastight crimped; per DIN 46288 (Part 4/09.09)

Conductor Cross Section	Strip Length	L	D	D 2	Item No.	Pack. Unit
0.5 mm ² / 20 AWG	10 mm / 0.39 inch	10	2,1	1	216-141	5000 (1000)
0.75 mm ² / 18 AWG	10 mm / 0.39 inch	10	2,3	1,2	216-142	5000 (1000)
1 mm ² / 18 AWG	10 mm / 0.39 inch	10	2,5	1,4	216-143	5000 (1000)
1.5 mm ² / 16 AWG	10 mm / 0.39 inch	10	2,8	1,7	216-144	5000 (1000)

Insulated and Uninsulated Ferrules

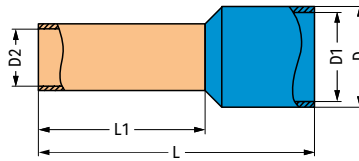

Ferrule; insulated; electro-tin-plated; electrolytic copper; gastight crimped; per DIN 46288 (Part 4/09.09)									
Conductor Cross Section	Color	Strip Length	L	L 1	D	D 1	D 2	Item No.	Pack. Unit
0.25 mm ² / 24 AWG	yellow	7 mm / 0.28 inch	10	6	2,3	1,8	0,85	216-321	1000
0.25 mm ² / 24 AWG	yellow	9 mm / 0.35 inch	12	8	2,3	1,8	0,85	216-301	1000
0.34 mm ² / 22 AWG	green	7 mm / 0.28 inch	10	6	2,5	2	0,85	216-322	1000
0.34 mm ² / 22 AWG	green	9 mm / 0.35 inch	12	8	2,5	2	0,85	216-302	1000
0.5 mm ² / 20 AWG	white	7 mm / 0.28 inch	12	6	3,1	2,6	1	216-221	1000
0.5 mm ² / 20 AWG	white	9 mm / 0.35 inch	14	8	3,1	2,6	1	216-201	1000
0.75 mm ² / 18 AWG	gray	8 mm / 0.31 inch	12	6	3,3	2,8	1,2	216-222	1000
0.75 mm ² / 18 AWG	gray	10 mm / 0.39 inch	14	8	3,3	2,8	1,2	216-202	1000
1 mm ² / 18 AWG	red	8 mm / 0.31 inch	12	6	3,5	3	1,4	216-223	1000
1 mm ² / 18 AWG	red	10 mm / 0.39 inch	14	8	3,5	3	1,4	216-203	1000
1.5 mm ² / 16 AWG	black	8 mm / 0.31 inch	12	6	4	3,5	1,7	216-224	1000
1.5 mm ² / 16 AWG	black	10 mm / 0.39 inch	14	8	4	3,5	1,7	216-204	1000
2.08 mm ² / 14 AWG	yellow	10 mm / 0.39 inch	15	8	4,8	4,2	2,05	216-205	1000
2.5 mm ² / 14 AWG	blue	10 mm / 0.39 inch	15	8	4,7	4,2	2,2	216-206	1000
4 mm ² / 12 AWG	gray	12 mm / 0.47 inch	18	10	5,4	4,8	2,8	216-207	500
6 mm ² / 10 AWG	yellow	14 mm / 0.55 inch	20	12	6,9	6,3	3,5	216-208	100
10 mm ² / 8 AWG	red	16 mm / 0.63 inch	22	12	8,4	7,6	4,6	216-209	100
16 mm ² / 6 AWG	blue	23 mm / 0.91 inch	28	18	9,6	8,8	5,8	216-210	100

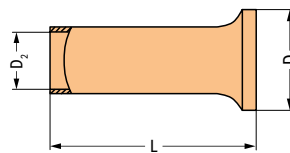

Ferrule; un-insulated; electro-tin-plated; electrolytic copper; gastight crimped; per DIN 46288 (Part 4/09.09)						
Conductor Cross Section	Strip Length	L	D	D 2	Item No.	Pack. Unit
0.25 mm ² / 24 AWG	5 mm / 0.2 inch	5	1,7	0,75	216-151	1000
0.25 mm ² / 24 AWG	7 mm / 0.28 inch	7	1,7	0,75	216-131	1000
0.34 mm ² / 22 AWG	5 mm / 0.2 inch	5	1,8	0,85	216-152	1000
0.34 mm ² / 22 AWG	7 mm / 0.28 inch	7	1,8	0,85	216-132	1000
0.5 mm ² / 20 AWG	6 mm / 0.24 inch	6	2,1	1	216-121	1000
0.5 mm ² / 20 AWG	8 mm / 0.31 inch	8	2,1	1	216-101	1000
0.75 mm ² / 18 AWG	6 mm / 0.24 inch	6	2,3	1,2	216-122	1000
0.75 mm ² / 18 AWG	8 mm / 0.31 inch	8	2,3	1,2	216-102	1000
1 mm ² / 18 AWG	6 mm / 0.24 inch	6	2,5	1,4	216-123	1000
1 mm ² / 18 AWG	8 mm / 0.31 inch	8	2,5	1,4	216-103	1000
1.5 mm ² / 16 AWG	6 mm / 0.24 inch	6	2,8	1,7	216-124	1000
1.5 mm ² / 16 AWG	8 mm / 0.31 inch	8	2,8	1,7	216-104	1000
2.5 mm ² / 14 AWG	10 mm / 0.39 inch	10	3,4	2,2	216-106	1000
4 mm ² / 12 AWG	10 mm / 0.39 inch	10	4	2,8	216-107	1000
6 mm ² / 10 AWG	12 mm / 0.47 inch	12	4,7	3,5	216-108	500
10 mm ² / 8 AWG	12 mm / 0.47 inch	12	5,8	4,5	216-109	500
16 mm ² / 6 AWG	15 mm / 0.59 inch	15	7,5	5,8	216-110	500

Crimping Tool



Crimping tool 25; for insulated and uninsulated ferrules; crimping range: 10 mm² (8 AWG), 16 mm² (6 AWG) and 25 mm² (4 AWG)

Item No.	Pack. Unit
206-1225	1

Crimping tool 50; for insulated and uninsulated ferrules; crimping range: 35 mm² (2 AWG) and 50 mm² (1/0 AWG)

Item No.	Pack. Unit
206-1250	1



Insert the ferruled conductor into the crimping station.



Squeeze handles until ratchet mechanism is released.

Application notes:

- Improved crimping for higher conductor retention
- Crimping can be performed from either side (for left- or right-handed users).
- Built-in ratchet mechanism ensures gas-tight crimp connection.
- Crimping tools open automatically after crimping operation is complete.
- Ergonomically designed handles.

What is a "gas-tight" connection?

In a gas-tight connection, the conductor and the ferrule are compressed, eliminating all spaces. Under normal atmospheric conditions, neither a liquid nor gaseous medium can penetrate the crimped connection. Oxidation between crimped single conductors is prevented, virtually eliminating the possibility of any increase in the crimped connection's resistance. In some exceptional cases, minute, isolated spaces may be present. However, these instances can be considered as closed off due to the twisted conductor. Inadequate crimping can allow the conductor to be pulled out of the connection. Hollow spaces also remain, permitting oxidation formation and an increase in contact resistance. Elevated resistance is detrimental for both signal transmission (signal flow is damped) and power transmission, resulting in power loss and contact heating (risk of fire). Crimping tools with built-in ratchets are recommended (e.g., WAGO Crimping Tools). These tools open automatically after the crimping operation is complete. Space-saving crimping from all four sides is ideal for spring clamp termination. Ferruled conductor cross sections specified for WAGO products are based on this crimping method.

Uninsulated Ferrule

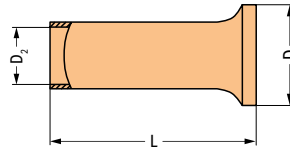

Ferrule; uninsulated; electro-tin-plated; electrolytic copper; gastight crimped; per DIN 46288 (Part 4/09.09)

Conductor Cross Section	Strip Length	L	D	D 2	Item No.	Pack. Unit
25 mm ² / 4 AWG	25 mm / 0.98 inch	25	9,5	7,3	216-413	50
35 mm ² / 2 AWG	25 mm / 0.98 inch	25	11	8,3	216-414	50
35 mm ² / 2 AWG	30 mm / 1.18 inch	30	11	8,3	216-424	50
50 mm ² / 1/0 AWG	30 mm / 1.18 inch	30	13	10,3	216-425	50
50 mm ² / 1/0 AWG	35 mm / 1.38 inch	35	13	10,3	216-435	50

Cable Cutter



Cable cutter; for copper and aluminum cables up to 35 mm² (2 AWG)

Item No.	Pack. Unit
206-118	1



Cutting a cable.

"Alu-Plus" Contact Paste

Terminating Aluminum Conductors



Syringe; contains 20 ml "Alu-Plus" Contact Paste

Item No.	Pack. Unit
249-130	20 (5)



WAGO Lighting Connectors

Push nozzle of the "Alu-Plus" syringe first into the circular entry and then into the square conductor entry hole of the WAGO Lighting Connector.



Press plunger down until the "Alu-Plus" has filled both entry holes.

Note: Not suitable for higher temperature applications!

Terminating Aluminum Conductors

WAGO spring clamp terminal blocks are suitable for solid aluminum conductors ❶ up to 4 mm²/12 AWG if WAGO "Alu-Plus" Contact Paste is used for termination.

Advantages of the "Alu-Plus" Contact Paste:

- Automatically destroys the oxide film during clamping.
- Prevents fresh oxidation at the clamping point.
- Prevents electrolytic corrosion between aluminum and copper conductors (in the same terminal block).
- Provides long-term protection against corrosion.



WAGO Rail-Mount Terminal Blocks (up to 4 mm²/12 AWG)

For each conductor entry: Insert nozzle of the "Alu-Plus" syringe in every open conductor entry hole (one after the other).



Press plunger down until "Alu-Plus" has filled all conductor entry holes.

Using terminal blocks with CAGE CLAMP® Spring Pressure Connection Technology, aluminum conductors must first be cleaned with a blade and then immediately be inserted into the clamping units filled with "Alu-Plus" Contact Paste.

It is also possible to apply WAGO "Alu-Plus" additionally on the whole surface of the aluminum conductor before termination.

Please note that the nominal currents must be adapted to the reduced conductivity of the aluminum conductors:

$$2.5 \text{ mm}^2 (14 \text{ AWG}) = 16 \text{ A}$$

$$4 \text{ mm}^2 (12 \text{ AWG}) = 22 \text{ A}$$

WAGO "Alu-Plus" in the syringe offers a higher degree of reliability and cleanliness when terminating solid aluminum conductors. Filling is quickly performed on selected WAGO connectors and terminal blocks (see pictures).

❶ Aluminum conductors per IEC 61545 standard, Class B, "Alloy 1370" with 90 ... 180 N/mm² tensile strength and 1 ... 4% elongation
Standard values: 90 ... 180 MPa tensile strength, 1 ... 4% elongation (per EN 615.4.1)

Test and Measurement Devices

206 Series



Multi-Tester; digital multimeter with non-contact voltage tester

Item No.	Pack. Unit
206-810	1



Clamp-Multi-Tester

Item No.	Pack. Unit
206-816	1



Testboy; with integrated flashlight, non-contact voltage tester

Item No.	Pack. Unit
206-804	1



Multi-Tester features:

- Contact-less voltage test AC > 100 V (optical and acoustical)
- Resistance measurement up to 20 MΩ
- Acoustical continuity test
- Diode test
- Data hold function
- Auto power-off function
- LED torch lamp function
- CAT IV 600 V
- TÜV/GS tested and approved
- IEC/EN 61010-1 (DIN VDE 0411)



Voltage testing in control cabinet

Clamp-Multi-Tester features:

- DC and AC current up to 600 A
- True RMS and min./max. value measurement
- DC and AC voltage up to 600 V
- Manual or automatic measurement range selection
- Resistance up to 60 MΩ
- Capacitance measurement, acoustical continuity test
- Diode test, data hold function
- Large LCD with backlight
- LED measuring point lighting
- CAT III 600 V overvoltage protection
- IEC/EN 61010-1 (DIN VDE 0411)
- Includes batteries, measurement leads and carrying bag



A device that will reliably detect AC voltage in cables, sockets, fuses, switches, outlets and other installations.

Testboy can detect the following:

- Live conductors
- Cable breaks
- Blown fuses (in cartridges or holders)
- Defective switches
- Defective lamps in strings of lights



Current measurement in a control cabinet

Test and Measurement Devices

206 Series



Profi-LCD+; 2-pole voltage tester with LCD display;
removable 4 mm Ø test probes

	Item No.	Pack. Unit
	206-707	1



Profi-LED+; 2-pole voltage tester with LED display;
removable 4 mm Ø test probes

	Item No.	Pack. Unit
	206-706	1



Spare test probes; 4 mm Ø (2 pieces)

	Item No.	Pack. Unit
	206-808	25



Additional Profi-LCD+ features:

- Automatic measurement range selection
- Single-pole phase testing AC > 100 V
- Two-pole sequence testing (R and L)
- Continuity testing
- RDC/RCD testing (30 mA) via buttons
- One-hand operation for SCHUKO® and CEE sockets
- LED torch lamp function
- Automatic backlight
- Auto power-off function
- CAT IV 1000 V
- TÜV/GS tested and approved
- IEC/EN 61243-3 (DIN VDE 0682-401)



Additional Profi-LED+ features:

- Automatic measurement range selection
- Single-pole phase testing AC > 100 V
- Two-pole sequence testing (R and L)
- Continuity testing
- RDC/RCD testing (30 mA) via buttons
- One-hand operation for SCHUKO® and CEE sockets
- LED torch lamp function
- CAT IV 1000 V
- TÜV/GS tested and approved
- IEC/EN 61243-3 (DIN VDE 0682-401)

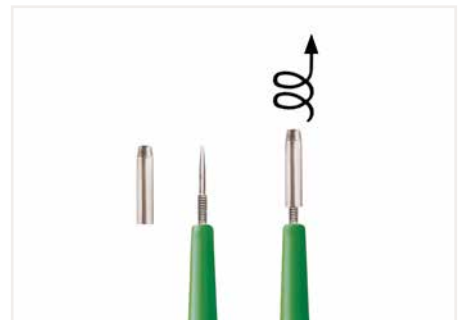

Profi-LED+:

- Improved socket contact via 4 mm Ø test probes
- Removable test probes for small test ports (suitable for all WAGO Terminal Blocks)



Banana Plug (Only for Safety Extra-Low Voltage) 215 Series

Technical Data	
0.08 ... 2.5 mm ²	28 ... 14 AWG
max. 42 V	
Test current: 20 A	
Measuring range category: CAT I	
9 ... 11 mm / 0.35 ... 0.43 inch	



Conductor termination: Press button fully, insert stripped conductor into square entry and release.

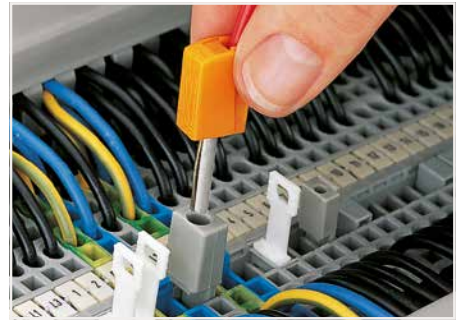

Testing via banana plug. Picture shows a test plug adapter (209-170).

Banana plug; for 4 mm socket diameter; color mixed; 10 x orange, white, black, blue, yellow

Item No.	Pack. Unit
215-111	50

Banana plug; single

Banana plug; for 4 mm socket diameter

orange	215-211	50
--------	---------	----



Banana plug; for 4 mm socket diameter

red	215-212	50
-----	---------	----



Banana plug; for 4 mm socket diameter

black	215-311	50
-------	---------	----



Banana plug; for 4 mm socket diameter

green	215-411	50
-------	---------	----



Banana plug; for 4 mm socket diameter

yellow	215-511	50
--------	---------	----



Banana plug; for 4 mm socket diameter

white	215-611	50
-------	---------	----



Banana plug; for 4 mm socket diameter

blue	215-711	50
------	---------	----



Banana plug; for 4 mm socket diameter

gray	215-811	50
------	---------	----



Banana plug; for 4 mm socket diameter

green-yellow	215-911	50
--------------	---------	----

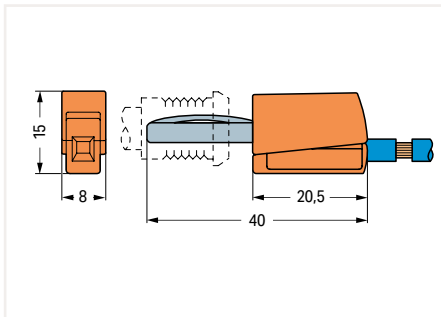

Dimensions in mm

13

Test Plug 210 Series



Test plug; with 500 mm cable; 2 mm Ø; max. 42 V		
Color	Item No.	Pack. Unit
● red	210-136	50

Test plug; with 500 mm cable; 2.3 mm Ø; max. 42 V		
Color	Item No.	Pack. Unit
● yellow	210-137	50



Testing via 2 mm Ø test plug.

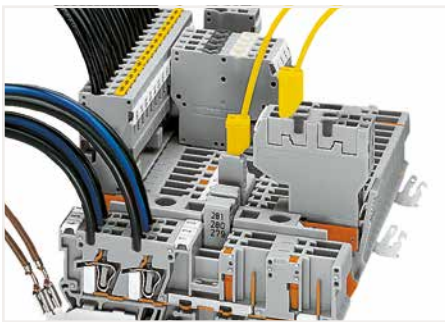







Testing via 2 or 2.3 mm Ø test plugs.

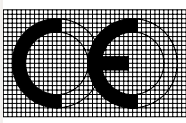

Technical Section

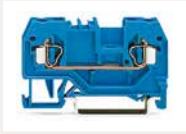
Technical Section

	Page	
	Technical information CE Marking and EC Directives	632
	Tests and testing procedures Mechanical, Electrical, Material and Environmental Tests	634
	UL Specifications – Underwriters Laboratories, USA Tests and Testing Procedures per UL Standards	654
	“Alu-Plus” Contact Paste Terminating aluminum conductors	659
	Material Specifications Insulation Materials, Contact Plating, Contact Materials and Clamping Spring Material	660
	General Technical Information on Electrical Equipment Used in Hazardous Areas	663
	All terminal blocks used in hazardous areas “Ex e II” have their item numbers marked with the Ex symbol.	
	All terminal blocks used in intrinsically safe current circuits “Ex i” have their item numbers marked with a blue circle.	
	International Certification Organizations – Overview	674
	Electrical Engineering Laboratory Product Safety for Our Customers	676
	WAGO Seminars Learn Today – Benefit Tomorrow Benefit from First-Hand Knowledge and Expertise – Training Straight from the Source!	678

CE Marking and EC Directives

CE Conformity Marking

The CE conformity marking consists of the characters "CE" with the following script:

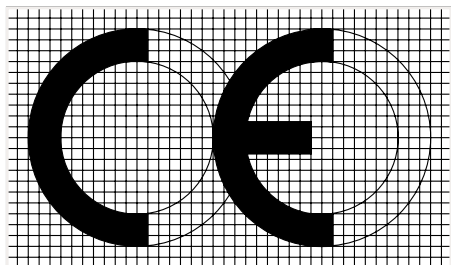

Communauté Européenne
(European Community)

WAGO Kontakttechnik GmbH & Co. KG products are developed, tested and marked in accordance with legally valid international standards and laws.

The CE mark is applied to products intended for the European domestic market; with it, manufacturers declare that the marked electrical equipment conforms with the applicable requirements set out in the Community harmonization legislation (EU Directives), which allows such equipment to carry this mark.

The original intention of this mark was to support the authorities in the EU member states in their market supervision, with the mark acting as a symbol of free movement of products within the EU. According to EC Directive 765/2008, a product can only be given the CE mark if the product requirements are defined in at least one appropriate EU directive. Examples of such directives are the Low Voltage Directive, the EMC Directive, the ATEX Directive, the Building Products Directive and the Machinery Directive. If more than one directive applies to a product, the product must comply with all applicable directives.

Only the basic requirements for achieving the defined aim of the directive are laid out in each respective directive. The individual technical details are specified according to the New Approach using lists with cross references to applicable standards (so-called harmonized standards).

1. Low Voltage Directive (LVD)

The safety of electrical equipment is guaranteed by the Low Voltage Directive (LVD). The LVD covers all electrical equipment operating with a voltage between 50 VAC and 1000 VAC and between 75 VDC and 1500 VDC.

Products falling within the scope of the Low Voltage Directive that are designed in such a way that they can be used in other electrical devices, and whose safety, for the most part, is dependant on how these components were built into the end product and what features the end product has, are defined as basic components in accordance with the Low Voltage Directive.

The LVD doesn't apply to basic components.

The RoHS Directive also applies to electrical equipment covered by the Low Voltage Directive. This

directive regulates the use of hazardous substances in electrical devices and components, with the aim of reducing the quantity of problematic components in electrical waste. Details about the materials used by WAGO are available in our catalogs, on our product packaging and on our Web page.

2. EMC Directive

The EMC Directive stipulates that a product must meet the limits on radiated electromagnetic disturbance and also requires that a product must be immune to electromagnetic interference.

Electromagnetic passive components or components with no direct function, such as terminal blocks, resistors, diodes, capacitors, switching relays or cables (in the form of passive printed circuit boards) are not considered as apparatus within the meaning of the EMC Directive.

3. ATEX Directive on Explosion Protection

The ATEX Directive defines the rules for products (devices and protective systems) intended for use in hazardous locations. A number of products from WAGO are designed for use in hazardous areas.

Based on potential hazards, the ATEX Directive makes a distinction between three different equipment groups, of which Group II and III are subdivided into further zones. Suitability of WAGO products for the different groups and zones is outlined in the specific product documents (catalogs, Internet site, data sheets and product inserts).

These may be either devices that can be used as equipment in these types of areas, or components that are required for safe operation, but which do not fulfill a dedicated function. Such components include rail-mount terminal blocks for use in hazardous areas.

Products in both groups must comply with the ATEX Directive.

4. Radio Communications Directive

The Radio Communications Directive applies to all devices that properly transmit or receive radio waves for wireless communications and/or radio orientation. The basic safety requirements apply to the protection of health for humans and animals and to electrical safety in line with the Low Voltage Directive, but without the application of the voltage limit. In addition, the EMC protection goals of the EMC Directive must also be fulfilled and efficient use of radio frequencies ensured. WAGO products covered by the Radio Communications Directive indicate, in compliance with applicable laws, only the Radio Communication Directive in their EU Declaration of Conformity, as fulfillment of the Low Voltage Directive and of the EMC Directive is implicit in this declaration.

5. Construction Products Regulation

The Construction Products Regulation demands that structures be designed and constructed such that the safety of humans, property and animals is not endangered and that all applicable environmental protection requirements be considered. Here, building products are defined as products or

construction sets which are produced to be built permanently into structures and which make a significant contribution to fulfilling the basic requirements for the structure.

In the unanimous opinion expressed by the German electrical industry, including WAGO Kontakttechnik GmbH & Co. KG, products used in general installation technology are not included among these types of building products and are therefore not covered by this directive.

6. Machinery Directive

The Machinery Directive applies to machines (complete or incomplete) which perform their functions by means other than direct human or animal work, or safety components for these types of machines.

Therefore, this directive usually does not apply to WAGO products.

The manufacturers of machines or systems are required by this directive to use safe products and components in their machines and systems. Directive-compliant production and safe operation is facilitated by the use of WAGO products, with their standard-compliant, up-to-date design.

Significance of CE Mark for WAGO Products

One, several or none of the EU Directives may apply to the various WAGO products. If none of the directives apply, the CE marking will not be affixed to the product, in line with applicable laws. Furthermore, a declaration of conformity must not be issued. All other products are provided with the CE mark – either directly on the product, on its packaging or in the documents included with the product – and a declaration of conformity is issued, or made accessible to the customer.

The data sheets of the technically sound products that, according to the regulations, are not CE marked will refer to the standards used in the development and type and manufacturing testing wherever possible.

IEC/EN specifications

The following standards apply to the design and application of the terminal blocks and connectors contained in this catalog:

IEC 60364-1 HD 60364-1 VDE 0100-100 / Erection of power installations with nominal voltages up to 1000 V – Part 1: Fundamental principles, assessment of general characteristics, definitions	EN 50628 VDE 0118-10 / Installation of electrical equipment in mines	IEC 60999-2 EN 60999-2 VDE 0609-101 /– Part 2: General requirements and particular requirements for clamping units for conductors from 35 mm ² up to 300 mm ² (included)
IEC 60364-7-710 HD 60364-7-710 VDE 0100-710 /– Part 7-718: Requirements for special installations or locations – Medical areas	IEC 60038 EN 60038 VDE 0175-1 / IEC CENELEC standard voltages	IEC 60998-1 EN 60998-1 VDE 0613-1 / Connecting devices for low-voltage circuits for household and similar purposes – Part 1: General requirements
IEC 60364-7-718 HC 60364-7-718 VDE 0100-718 /– Part 7-718: Requirements for special installations or locations – Communal facilities and workplaces	VDE 0298-4 / Use of cables and insulated conductors in power installations – Part 4: Recommended values for current carrying capacities of cables for fixed installation and for flexible cables	IEC 60998-2-1 EN 60998-2-1 VDE 0613-2-1 /– Part 2-1: Particular requirements for connecting devices as separate entities with screw-type clamping units
IEC 50110-1 VDE 0105-1 / Operation of electrical installations – Part 1: General requirements	IEC 60112 EN 60112 VDE 0303-11 / Method for determining the comparative and the proof tracking indices of solid insulation materials	IEC 60998-2-2 EN 60998-2-2 VDE 0613-2-2 /– Part 2-2: Particular requirements for connecting devices as separate entities with screwless-type clamping units
IEC 60664-1 EN 60664-1 VDE 0110-1 / Insulation coordination for equipment within low-voltage systems – Part 1: Principles, requirements and tests	IEC 60529 EN 60529 VDE 0470-1 / Degrees of protection provided by enclosures (IP Code) – Testing equipment and testing method	IEC 60998-2-3 EN 60998-2-3 VDE 0613-2-3 /– Part 2-3: Particular requirements for connecting devices as separate entities with insulation-piercing clamping units
IEC 60204-1 EN 60204-1 VDE 0113-1 / Safety of machinery – Electrical equipment of machines – Part 1: General requirements	IEC 61439-1 EN 61439-1 VDE 0660-600-1 / Low-voltage switchgear and control-gear assemblies – Part 1: General rules	IEC 60947-1 EN 60947-1 VDE 0660-100 / Low-voltage switchgear and controlgear – Part 1: General rules
IEC 61140 EN 61140 VDE 0140-1 / Protection against electric shock – Common aspects for installation and equipment	IEC 61439-3 EN 61439-3 VDE 0660-600-3 /– Low-voltage switchgear and control-gear assemblies – Part 3: Distribution boards intended to be operated by ordinary persons (DBO)	IEC 60947-7-1 EN 60947-7-1 VDE 0611-1 /– Part 7-1: Ancillary equipment – Terminal blocks for copper conductors
IEC 60079-0 EN 60079-0 VDE 0170-1 / Hazardous areas – Part 0: Equipment – General requirements	IEC 61643-1 EN 61643-1 VDE 0675-6-11 / Low-voltage surge protective devices – Part 11: Surge protective devices connected to low-voltage power systems – Requirements and test methods	IEC 60947-7-2 EN 60947-7-2 VDE 0611-3 /– Part 7-2: Ancillary equipment – Ground conductor terminal blocks for copper conductors
IEC 60079-7 EN 60079-7 VDE 0170-6 / Explosive atmospheres – Part 7: Equipment protection by increased safety "e"	IEC 60335-1 EN 60335-1 VDE 0700-1 / Safety of household and similar electrical appliances – Part 1: General requirements	IEC 60947-7-3 EN 60947-7-3 VDE 0611-6 /– Part 7-3: Ancillary equipment – Safety requirements for fuse terminal blocks
IEC 60079-11 EN 60079-11 VDE 0170-7 / Hazardous areas – Part 11: Equipment protection by intrinsic safety "i"	IEC 60598-1 EN 60598-1 VDE 0711-1 / Lighting fixtures – Part 1: General requirements and tests	VDE 0611-4 / Rail-mount terminal blocks for connection of copper conductors; – Multi-level distribution rail-mount terminal blocks up to 6 mm ²
IEC 60079-14 EN 60079-14 VDE 0165-1 / Hazardous areas – Part 14: Electrical installations design, selection and erection	IEC 60715 EN 60715 /– Standardized mounting on rails for mechanical support of electrical devices in switchgear and control-gear installations	IEC 61984 EN 61984 VDE 0627 / Connectors – Safety requirements and tests
IEC 60079-15 EN 60079-15 VDE 0170-16 / Explosive atmospheres – Part 15: Equipment protection by type of protection "n"	IEC 60999-1 EN 60999-1 VDE 0609-1 / Connecting devices – Electrical copper conductors – Safety requirements for screw-type and screwless-type clamping units – Part 1: General requirements and particular requirements for clamping units for conductors from 0.2 mm ² up to 35 mm ²	

Tests and Testing Procedures per IEC/EN Standards

Products such as connecting devices, rail-mount terminal blocks and connectors, etc., have their own product-specific test specifications. The following sections describe the most important tests and are limited to a description of the test procedures and an explanation of the test purpose. The data shown (e.g., voltages, temperatures, forces) only serve as illustration and may differ depending on the test.

Mechanical Tests

All WAGO products meet requirements for the following mechanical tests:

• Termination Requirements

Conductor Termination

Two WAGO connection systems are proven in the field of Spring Pressure Connection Technology:

The **PUSH WIRE®** connection for applications requiring solid conductors (e.g., for lighting and building wiring, telecommunications, house communication or alarm systems).

Conductor range:

0.2 ... 4 mm² / 24 ... 12 AWG

The **universal CAGE CLAMP® spring pressure connection system** for solid, stranded and fine-stranded conductors, designed for a variety of industrial, electrical and electronic applications (e.g., fine-stranded conductors in the elevator industry, in power stations, in the chemical and automotive industry, and aboard ships).

Conductor range:

0.08 ... 35 mm² (28 ... 2 AWG)

The **Push-in CAGE CLAMP®** connection takes universal CAGE CLAMP® connections further by allowing the termination of 0.2 ... 16 mm² (24 ... 6 AWG) solid, stranded and fine-stranded conductors (25 mm²/4 AWG only "f-st") and offering all the benefits and safety of the original CAGE CLAMP®. Furthermore, the Push-in CAGE CLAMP® connection technology allows solid, stranded and fine-stranded conductors with ferrules from 0.5 to 16 mm² (20 ... 6 AWG) to be terminated by simply pushing them in.

The conductor entry hole is perfectly suited for the insulation diameter of the rated conductor cross section, thus providing good conductor guidance.

This is particularly important for vibration-prone applications.

Fine-stranded conductors of a small or very small size are highly flexible, and deform when pushed against the conductor stop in terminal blocks. As a result, the conductor insulation – not the copper conductor – may be clamped, causing intermittent contact or no contact at all.

In order to prevent conductor insulation from being inserted into the clamp, insulation stops are available for WAGO rail-mount terminal blocks up to 4 mm² (12 AWG), even providing protection for 0.08 mm² (28 AWG) conductors (see Section 5).

Rated Cross Sections and Connectable Conductors

I. Per IEC 60999-1 / EN 60999-1 / VDE 0609-1, Table 1:

Rated Cross Section	Theoretical Largest Conductor Diameter							Connectable Conductor	
	Metric			AWG				Rigid	Flexible
	Rigid		Flexible	Rigid		Flexible			
	Solid	Stranded			^{b)} Solid	^{b)} Class B Stranded	^{c)} Class I, K, M Stranded		
mm ²	mm	mm	mm	Conductor Size	mm	mm	mm	To be defined in the corresponding product standard	
0.2	0.51	0.53	0.61	24	0.54	0.61	0.64		
0.34	0.63	0.66	0.8	22	0.68	0.71	0.8		
0.5	0.9	1.1	1.1	20	0.85	0.97	1.02		
0.75	1	1.2	1.3	18	1.07	1.23	1.28		
1	1.2	1.4	1.5	–	–	–	–		
1.5	1.5	1.7	1.8	16	1.35	1.55	1.6		
2.5	1.9	2.2	2.3 ^{a)}	14	1.71	1.95	2.08		
4	2.4	2.7	2.9 ^{a)}	12	2.15	2.45	2.7		
6	2.9	3.3	3.9 ^{a)}	10	2.72	3.09	3.36		
10	3.7	4.2	5.1	8	3.34	3.89	4.32		
16	4.6	5.3	6.3	6	4.32	4.91	5.73		
25	–	6.6	7.8	4	5.45	6.18	7.26		
35	–	7.9	9.2	2	6.87	7.78	9.02		

NOTE: The diameters of the largest rigid and flexible conductors are based on Table 1 of IEC 60228 A/IEC 60344 and on ASTM B172-71 [4], IECA Publication S-19-81 [5], IECA Publication S-66-524 [6], as well as IECA Publication S-66-516 [7] for AWG conductors.

^{a)} Dimensions for Class 5 flexible conductors only (IEC 60228 A)

^{b)} Nominal diameter +5%

^{c)} Largest diameter for conductors of classes I, K, M + 5%

In practical use, the conductor cross sections are approximately 5% below the values stated in the table!

The IEC 60999-1/EN 60999-1/VDE 0609-1 Specification (Section 7.1) requires that:

Clamping units must be able to connect unprepared conductors.

Under normal operating conditions, direct clamping (i.e., directly connecting a conductor to the terminal block's current bar) provides optimal contact quality, because all risk factors arising from anti-splaying methods are prevented.

Occasionally, conductor anti-splaying protection may be required, including various methods (see illustrations below).

Special requirements apply only in special application areas exposed to extremely corrosive atmospheres.

In this case, we recommend using either solid copper conductors or fine-stranded copper conductors with properly crimped, tin-coated copper ferrules or copper pin terminals.

As with solid copper conductors, the fine strands are crimped into a dense inner core. Crimping prevents ingress of aggressive atmospheres (depending on the ppm concentration), which can diffuse into the conductor bundle along the individual strands and deposit between individual strands and the clamping point.

One Conductor per Clamping Unit

A number of DIN VDE, EN, IEC directives mandate or recommend that only one conductor must be connected per clamping unit.

In accordance with DIN VDE 0611, Part 4, 02.91, Section 3.1.9, multi-level distribution rail-mount terminal blocks must be dimensioned so that a single (solid, stranded or fine-stranded) conductor of the nominal cross section can be connected at each terminal point.

Other VDE, EN and IEC specifications also recommend the connection of only one conductor per clamping unit, unless the clamping unit is specifically tested and approved for the connection of several conductors, for example:

- VDE 0609, Part 1, 12.00 / EN 60999-1:2000/ IEC 60999-1:1999, Section 7.1
- VDE 0660, Part 600, 06.12 / EN 61439-1:2011 / IEC 61439-1, Section 8.6.3
- VDE 0113, Part 1, 06.07 / EN 60204-1:2006 / IEC 60204-1:2016, Section 13.1.1.

One conductor per clamping unit is therefore recommended to meet the safety requirements of these relevant specifications. This WAGO principle is the basis for a number of other technical and economic advantages:

- Each conductor may be terminated or removed without affecting previously connected conductors.
- Where re-wiring is required, only the conductor to be changed is removed from the clamping point, all other conductors remain safely clamped.
- Each conductor is clamped independently.
- Any conductor size combination can be connected.

II. Per IEC 60999-2, Table 1:

Rated Cross-Section	Theoretical Largest Conductor Diameter					Connectable Conductor	
	Metric		AWG/kcmil			Rigid	Flexible
	Rigid Stranded	Fine-Stranded ^{a)}	Gauge	Rigid Stranded	Fine-Stranded		
mm ²	mm	mm		mm	mm		
50	9.1	11	1/0	9.64	12.08	To be defined in the corresponding product standard	
70	11	13.1	2/0	11.17	13.54		
95	12.9	15.1	3/0	12.54	15.33		
–	–	–	4/0	14.08	17.22		
120	14.5	17	250	15.34	19.01		
150	16.2	19	300	16.8	20.48		
185	18	21	350	18.16	22.05		
–	–	–	400	19.42	24.05		
240	20.6	24	500	21.68	26.57		
300	23.1	27	600	23.82	30.03		

Dimensions for Class 5 flexible conductors only (IEC 60228 A)

NOTE: The diameters of the largest rigid and flexible conductors are based on Table 1 and Table 3 of IEC 3 A/IEC 60228 and on ASTM B172-71 [1], IECA Publication S-19-81 [2], IECA Publication S-66-524 [3], as well as IECA Publication S-66-516 [7] for AWG conductors.



Tip-bonded conductor



Tin-plated copper ferrule (gas-tight crimped)



Ultrasonically bonded conductor



Crimped pin terminal (gas-tight), preferably made of copper with a tin-plated surface

Anti-splaying methods require a terminal block one size larger than the nominal cross section of the conductor to be terminated. Ferruled conductor cross sections specified for individual products are based on WAGO's Variocrimp square crimping technology. Gas-tight, crimped twin ferrules may be used, provided the ferrule is inserted all the way into the clamping unit and that there is a sufficient clearance and creepage distance between adjacent potentials.

WAGO rail-mount terminal blocks offer different solutions to increase the number of clamping points.

The most common way is by branching one conductor into two or three conductors. WAGO offers 3- and 4-conductor terminal blocks, making additional jumpers unnecessary.

Tests and Testing Procedures per IEC/EN Standards (continued)

Mechanical Tests (continued)

- Pull-Out Test per IEC/EN 60947-7-1, IEC/EN 60998-2-2, IEC/EN 60999-1

The pull-out test simulates the mechanical stress on the clamping unit when, for example, the installer pushes the conductor aside to better access/operate the adjacent clamping unit, or verifies if the conductor is connected properly by briefly pulling on it.

During the test, a pulling force is applied without jerking, for one minute, to the connected conductor. The pulling force is selected according to the cross-sectional area. The larger the cross section of the conductor, the higher the pull-out force that is selected. For example, the pulling force is 40 N for a conductor having a cross section of 1.5 mm² (16 AWG) and 100 N for a conductor with a cross section of 16 mm² (6 AWG). The values specified by these standards are the same for both screw clamp and spring clamp terminal blocks. During the test, the conductor must neither slip out of the clamping unit, nor break near the clamping unit.

Conductor Pull-Out Forces

The clamping units of screwless terminal blocks must withstand the pull-out forces as follows:

IEC 60947-1/EN 60947-1/VDE 0660-100, Table 5:

Low-voltage switchgear and controlgear, General rules

IEC 60947-7-1/EN 60947-7-1/

VDE 0611-1, Rail-mount terminal blocks for copper conductors

IEC 60998-2-1/EN 60998-2-1/

VDE 0613-2-1, Table 104:

IEC 60998-2-2/ EN 60998-2-2

VDE 0613-2-2, Table 103:

Connecting devices for low-voltage circuits for household and similar purposes

Particular requirements for connecting devices as separate entities with screw-clamp or screwless terminal blocks.

IEC 60999-1/EN 60999-1/VDE 0609-1, Table 3:

IEC 60999-2/EN 60999-2/VDE 0609-101, Table 2:

Safety requirements for screw-clamp and screwless clamping units for electrical copper conductors

Rated Cross-Section		Pull-Out Forces per IEC/EN		
mm ²	AWG/kcmil	60947-7-1 N	60998-2-2 N	60999-1/-2 N
0.2	24	10	10	10
0.34	22	15	15	15
0.5	20	20	20	20
0.75	18	30	30	30
1	–	35	35	35
1.5	16	40	40	40
2.5	14	50	50	50
4	12	60	60	60
6	10	80	80	80
10	8	90	90	90
16	6	100	100	100
25	4	135	135	135
–	3	156		
35	2	190	190	190
–	1	236		
50	1/0	236		236
70	2/0	285		285
95	3/0	351		351
–	4/0	427		427
120	250	427		427
150	300	427		427
185	350	503		503
–	400	503		503
240	500	578		578
300	600	578		578

• Shock Test per IEC/EN 60068-2-27; IEC/EN 61373 (Railway Applications)

The shock test is similar to the vibration test except that, instead of continuous vibrations, single shocks are applied to the specimen. Shock tests are usually performed with an acceleration of 20g, for example, over a period of 11 ms. Tests for special requirements often call for much higher values.

Like the vibration tests, shock tests are primarily used to test the voltage drop variation or contact breaks, etc.

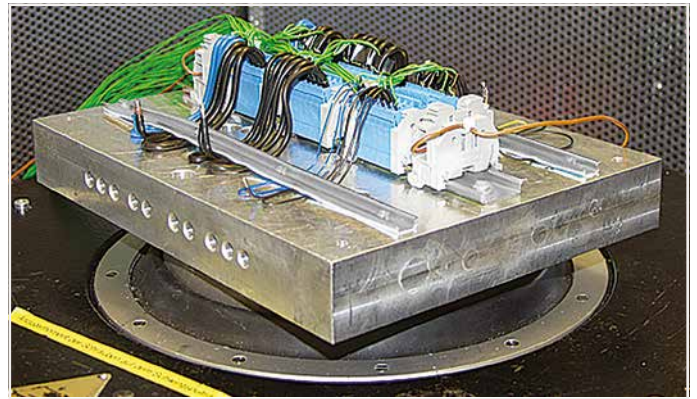
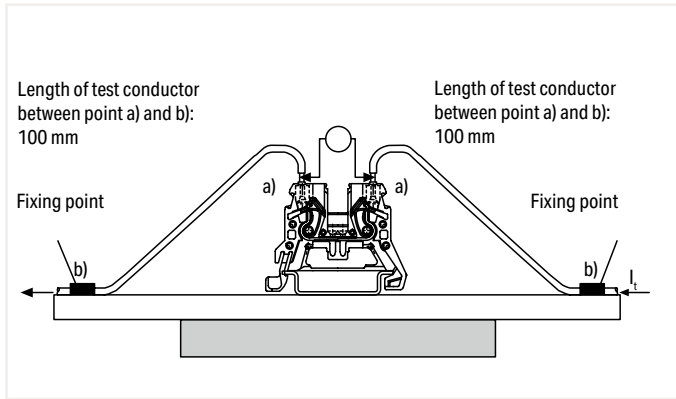

Example: Shock requirement
 per IEC/EN 60068-2-27 (half-sine shock)
 100g acceleration, 6 ms duration
 Shock direction: 3 axes (3 shocks each in positive and negative direction)

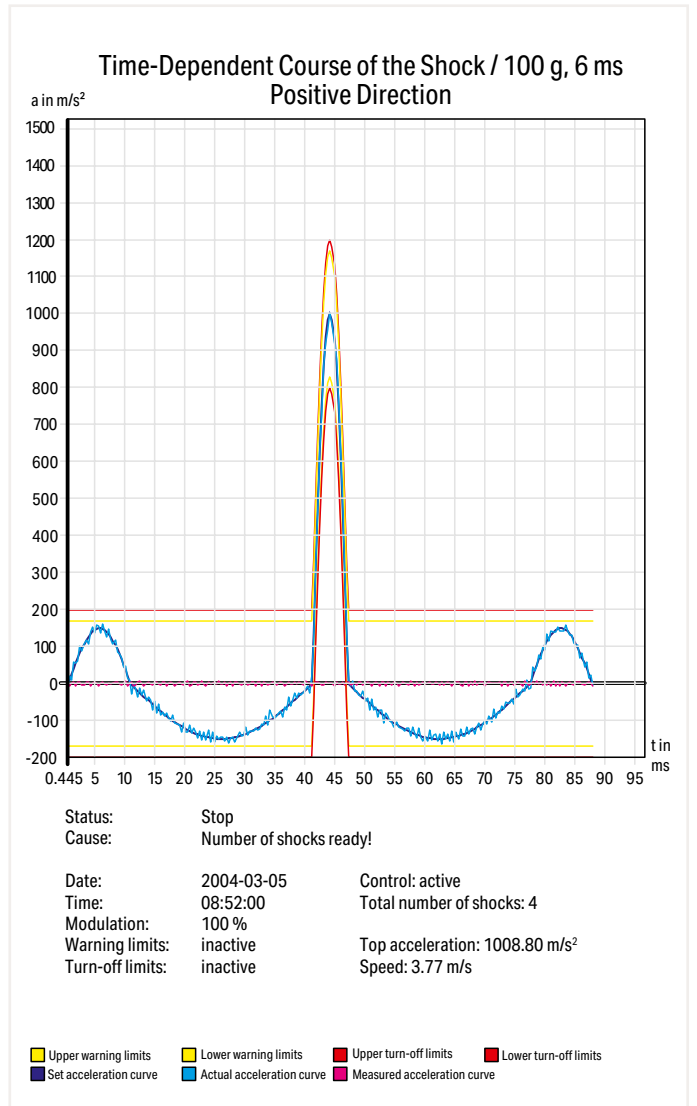
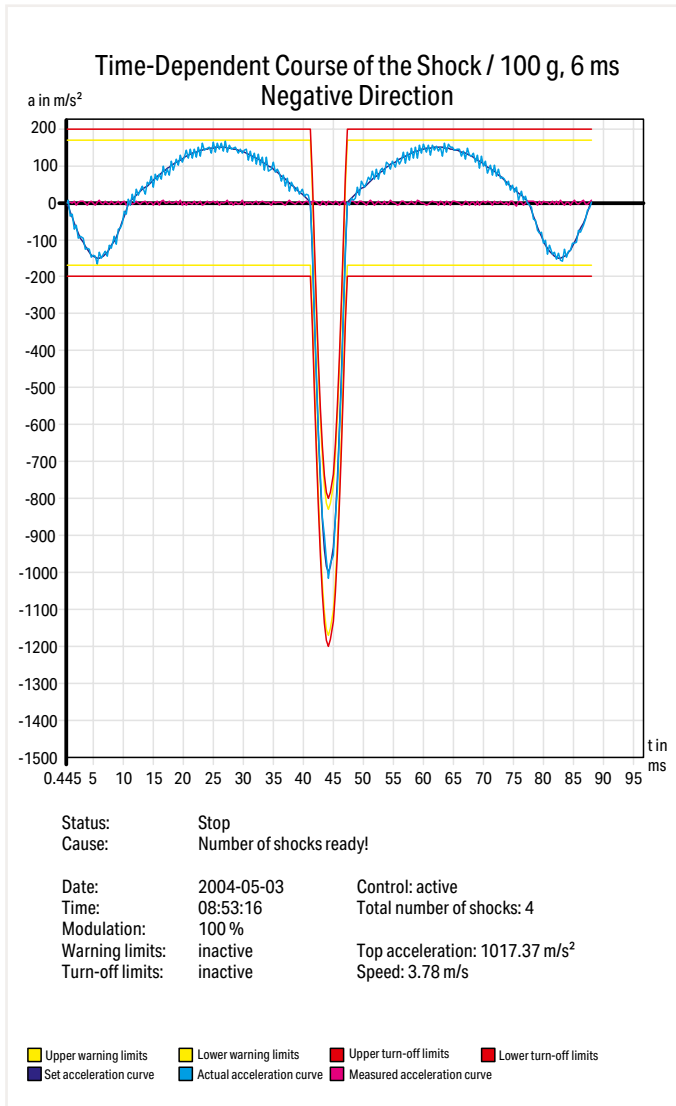

Tests and Testing Procedures per IEC/EN Standards (continued)

Mechanical Tests

- Vibration Test per IEC/EN 60068-2-6; DNV GL, LR (Marine Applications); EN 61373 (Railway Applications)

The vibration test determines whether vibrations, such as those produced in the vicinity of machines or in vehicles, will permanently affect the electrical connection, or if contact breaks will occur during vibrations. Using a vibration table, the test specimen is subjected to vibration in each of the X, Y and Z axes (see pictures).

The amplitude, acceleration and, in particular, the frequency of the vibration must vary during the test.

In a common test procedure, for example, a wide frequency band is continuously run up to 2000 Hz, at different accelerations up to 20g and different amplitudes up to 20 mm. Test duration is 90 minutes per axis.



Other test types are performed using a single fixed frequency. The exact test procedure may vary considerably, depending on how the product will be used. Some test specifications require the determination of possible resonant frequencies, i.e., determining if resonance occurs within the frequency spectrum to be passed through. Analyzing the specimen behavior under the influence of resonant frequencies is performed using a special testing procedure.

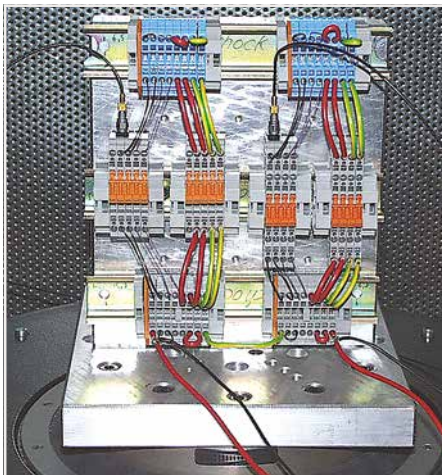

Beyond these standard procedures, each market segment performs additional testing. Examples include railway authorities testing rolling electrical equipment, or the testing performed multiple marine agencies (e.g., DNV GL Group, Lloyd's Register of Shipping). Though the requirements of such testing procedures are particularly demanding, test arrangements are identical for all of them. During vibrations, possible contact breaks are monitored on an oscilloscope. Voltage drop is measured before and after the test to detect permanent failures, i.e., checking if electrical resistance at the clamping unit has not increased beyond the permissible limit. The smaller this value is, the smaller the contact resistance of the clamping unit.

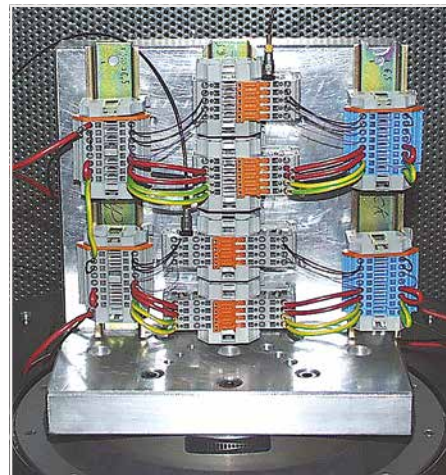

The test is passed if:

- the conductor has neither slipped out of the terminal block nor been damaged
- the maximum permissible voltage drop has not been exceeded
- and neither contact breaks have occurred nor a defined break time has been exceeded.

The test specimen must not be damaged in any way that might affect future use.

Since their inception, both CAGE CLAMP® and Push-in CAGE CLAMP® connections have been routinely tested for their resistance to vibration in connection with approval tests.

Additionally, WAGO conducts special self-resonance behavior tests on clamping systems, using different terminal block and conductor arrangements. In these tests, a wide frequency band is continuously run up to 2000 Hz, at different accelerations up to 20g and different amplitudes up to 20 mm. The figure provides an example of a self-resonance vibration test configuration.

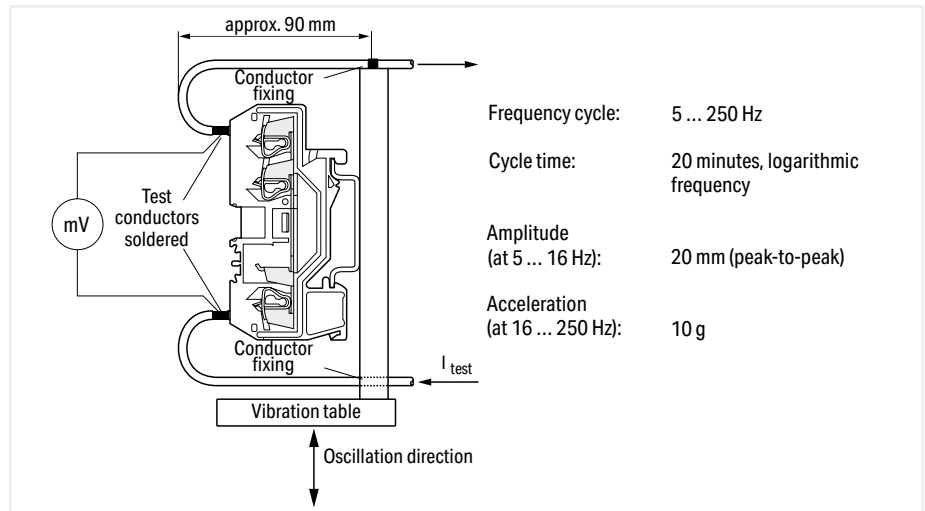

Self-resonance vibration test set-up

All WAGO spring clamp connections meet these test requirements.

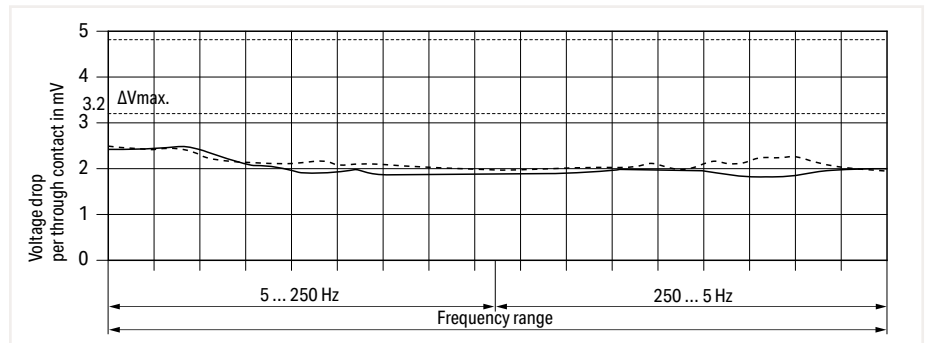

Frequency cycle
 Rail-mount terminal block: Item no. 280-681
 Test current: $1/10 I_N = 2,4 \text{ A}$
 ----- Test specimen no. 1
 - - - - - Test specimen no. 2

Tests and Testing Procedures per IEC/EN Standards (continued)

Electrical Tests

All WAGO products meet requirements for the following electrical tests:

- Temperature-Rise Test per IEC/EN 60947-7-1

The temperature-rise test examines the clamping unit – including the surrounding insulation – at rated current, over-current and short-circuit current levels.

Unless otherwise specified in the related equipment specification, e.g., by specifying the nominal currents of the equipment, terminal blocks and connectors are tested with current loads as specified in the respective construction specification.

For rail-mount terminal blocks complying with IEC 60947-7-1/EN 60947-7-1/VDE 0611-1, or terminal blocks complying with IEC 60998-1/EN 60998-1/VDE 0613-1, the temperature rise must not exceed 45 Kelvin.

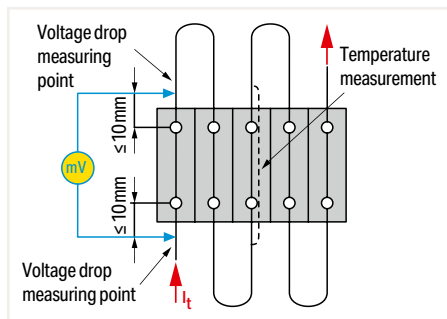

Test arrangement: "Temperature-Rise Test"

Rated Cross-Section	Test Current per IEC/EN		Conductor Size	Test Current per IEC/EN
	60947-7-1 Table 4	60998-1 Table 2		
mm ²	A	A	AWG/kcmil	A
0.2	4	4	24	4
0.34	5	5	22	6
0.5	6	6	20	8
0.75	9	9	18	10
1	13.5	13.5	-	-
1.5	17.5	17.5	16	16
2.5	24	24	14	22
4	32	32	12	29
6	41	41	10	38
10	57	57	8	50
16	76	76	6	67
25	101	101	4	90
35	125	125	2	121
-	-	-	1	139
50	150	-	1/0	162
70	192	-	2/0	185
95	232	-	3/0	217
-	-	-	4/0	242
120	269	-	250 kcmil	271
150	309	-	300 kcmil	309
185	353	-	350 kcmil	353
240	415	-	500 kcmil	415
300	520	-	600 kcmil	520

• Current-Carrying Capacity Curve per IEC/EN 60512-5-2

Both the design requirements and the current-carrying capacity of a connector must be checked by the user when selecting connectors. This data depends on the following factors: connected conductor cross section, surrounding air temperature, number of simultaneously loaded poles, connector's internal resistance, as well as PCB layout and connector materials if required. In accordance with IEC/EN 60512-5-2, the relationship between current, surrounding air temperature and temperature rise up to the connector's upper temperature limit is illustrated via current-carrying capacity curve. The connector must only be operated up to this temperature limit (sum of the self-generated heat and the surrounding air temperature) without being damaged or destroyed during operation.

Functioning of a current-carrying capacity curve per EN 60512-5-2 is shown by an application using a current-carrying capacity curve for the X-COM®-SYSTEM:

This application requires each pole of a 4-pole connector be subjected to a load of 32 A. Based on the basic curve determined for this pole number with a conductor cross section of 4 mm², it has been determined the maximum surrounding air temperature is 42°C (107.6°F). The current must be reduced at higher surrounding air temperatures, e.g., to 19 A at an surrounding air temperature of 80°C (176°F).

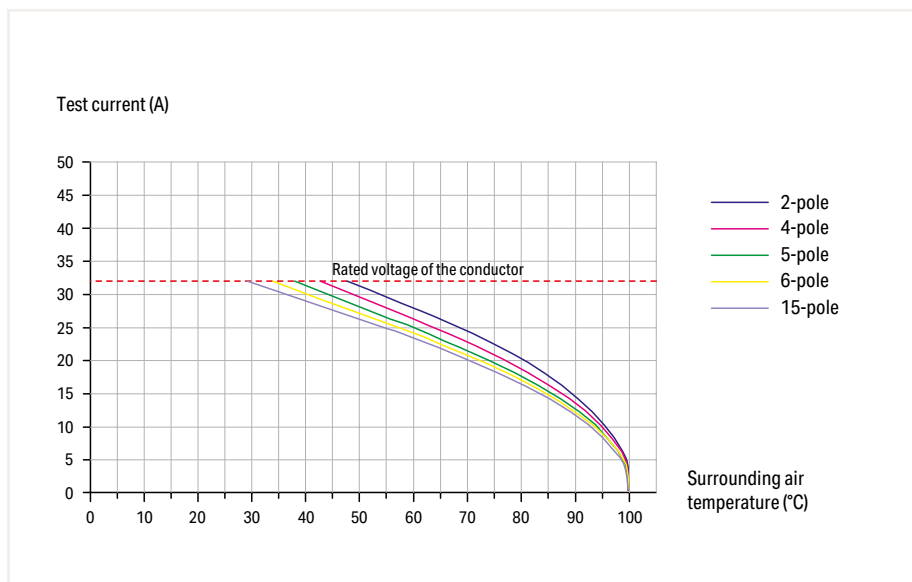

1-conductor/1-pin carrier terminal block (769-176)
Conductor cross section: 4 mm² (12 AWG)

1-conductor female plugs (769-102 to 769-115)
Conductor cross section: 4 mm² (12 AWG)
Conductor loop length: 1 m

Tests and Testing Procedures per IEC/EN Standards (continued)

Electrical Tests (continued)

- Voltage Drop Test per IEC/EN 60947-7-1

The voltage drop test evaluates clamping point quality under stress such as vibration, temperature change, industrial climate and salt spray, in order to verify that the contact point is gas-tight.

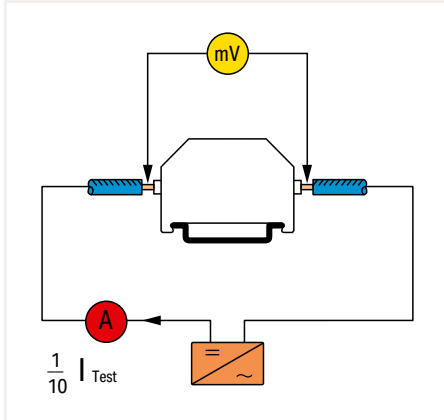

The CAGE CLAMP® and Push-in CAGE CLAMP® connections enclose and contain fine-stranded conductors. Therefore, a variation of the voltage drop with solid and fine-stranded conductors is so small that its influence may be negligible for the practical application of the terminal blocks.

Test arrangement: "Voltage Drop Test"

Typical voltage drop variations for solid and fine-stranded conductors of 280 to 285 Series CAGE CLAMP® Rail-Mount terminal Blocks:

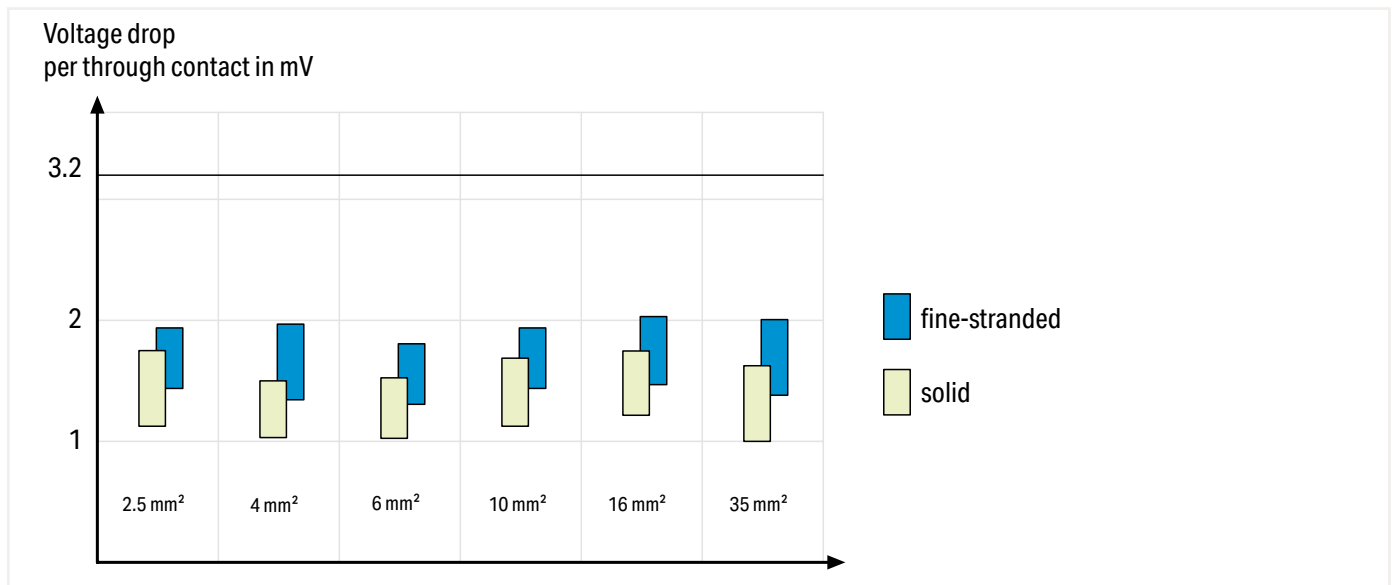

Example: Current load cycling test result for rail-mount terminal blocks (item no. 285-195) using 95 mm² (4/0 AWG) fine-stranded copper conductors:

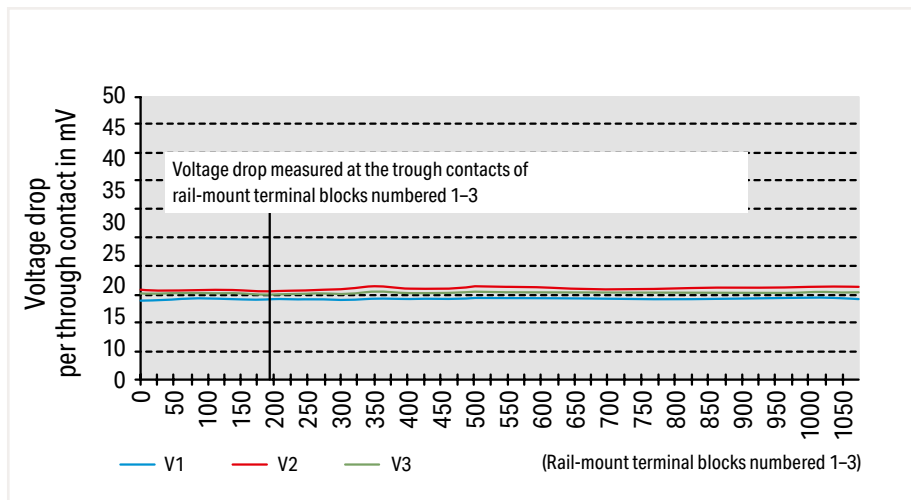

Voltage drop variation over longer periods under current load cycling conditions is shown for WAGO 285-195 (95 mm²/4/0 AWG) Rail-Mount Terminal Blocks using solid copper conductors. The diagram shows that the voltage drop is constant, far beyond the 192 cycles required in IEC 60947-7-1.

(The voltage drop was determined at the rated current.)

- Short-Time Withstand Current Test (Short-Circuit Withstand Capacity) per IEC/EN 60947-7-1

Apart from the rated current that can be constantly applied to an electrical device, operation-related short peak currents consistently occur in electrical installations, e.g., when motors are started. Also, in the event of a short circuit, a high current can flow for a short time until the fuse element melts. Terminal blocks and connecting devices must be able to withstand such conditions. For example, in the short-time withstand current test per IEC/EN 60947-7-1, a through rail-mount terminal blocks must be capable of withstanding for one second the rated short-time withstand current which corresponds to 120 A/mm^2 of its nominal cross section.

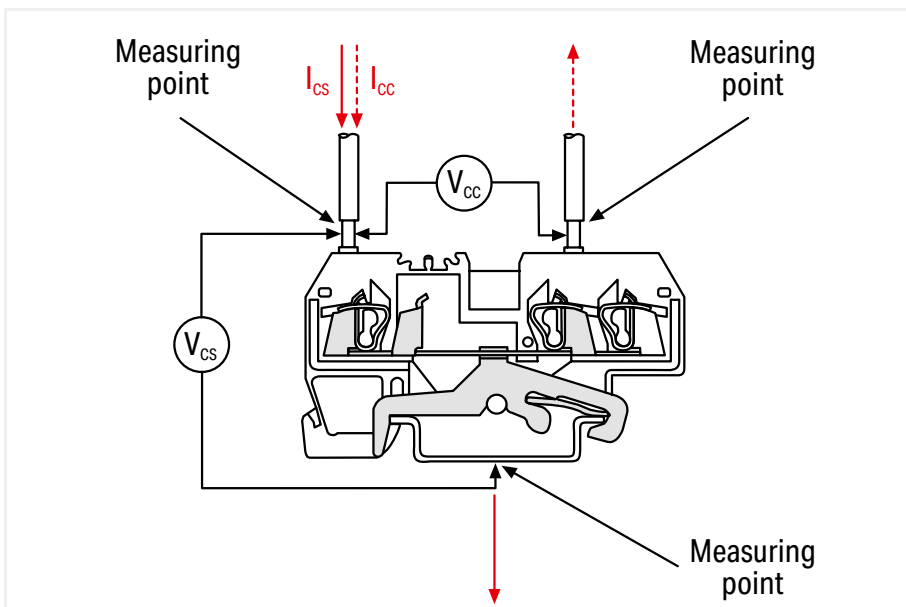
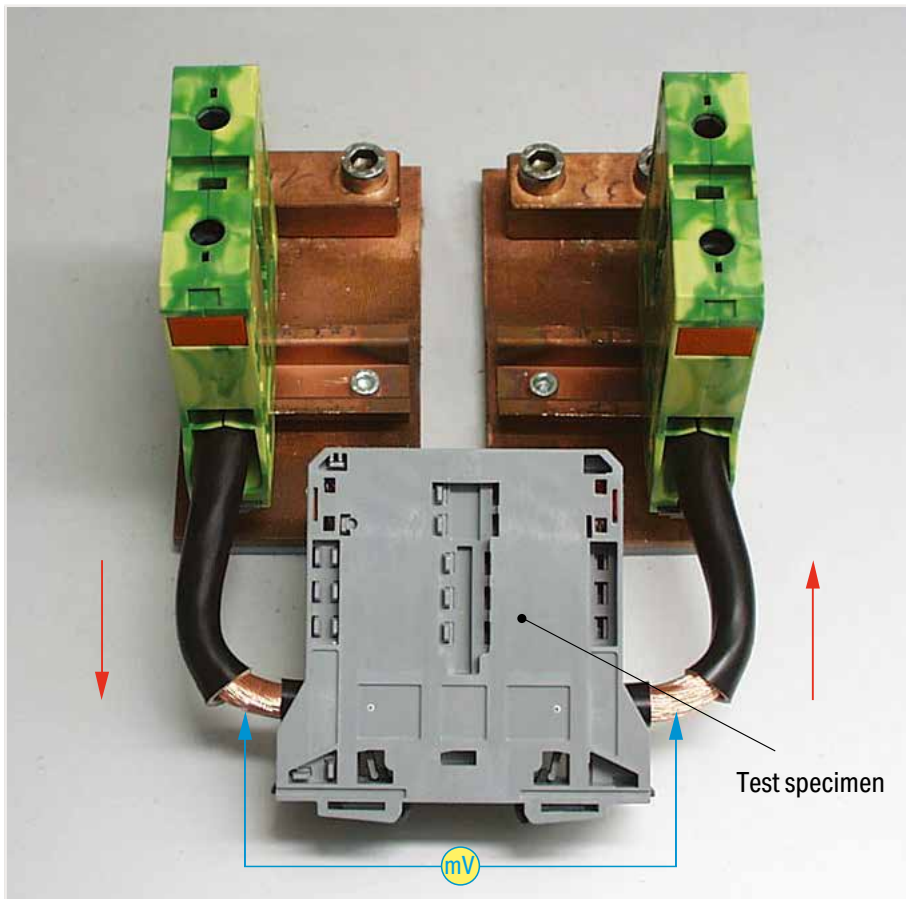

During the short-time withstand current test, the ground conductor rail-mount terminal blocks are subjected three times for one second each to a current load of 120 A/mm^2 . The pass criterion for the test is the voltage drop (limiting value and constant measured values).

Tests and Testing Procedures per IEC/EN Standards (continued)

Electrical Tests (continued)

• Insulation Parameters per IEC/EN 60664-1

Clearances and Creepage Distances

The following generally applies:

The equipment specification contains data for the measurement of clearances and creepage distances, or refers to the data contained in the new revised edition of the basic standard DIN EN 60664-1/VDE 0110-1. This standard contains new clearances and creepage distances in compliance with insulation coordination requirements. That is, the insulation parameters of equipment are assigned to:

- the anticipated surge voltages
- the parameters of the protection device against impulse voltage
- the anticipated environmental conditions and the protection measures against pollution.

This standard is based on IEC 60604-1.

Overvoltage Categories for Electrical Equipment:

A specific overvoltage category must be defined on the basis of the following, general description:

- Equipment in **overvoltage category I** is intended to be connected to the fixed electrical installations of buildings. Protective means are taken outside the equipment – either in the fixed installation or between the fixed installation and the equipment – to limit transient overvoltages to the specific level.
- Equipment in **overvoltage category II** is to be connected to the fixed electrical installations of buildings.

Note: Examples of such equipment are household appliances, portable tools and similar loads.

- Equipment in **overvoltage category III** is part of the fixed electrical installations and other equipment where a higher degree of availability is expected.

Note: Examples of such equipment are distribution boards, circuit breakers, wiring systems (IEV 826-16-08, including cables, bus bars, junction boxes, switches, socket outlets) in the fixed installation and equipment for industrial use and other equipment, e.g., stationary motors with permanent connection to the fixed installation.

- Equipment in **overvoltage category IV** is for use in or near the feed-in of electrical building installations upstream of the main distribution board in the direction of the network.

Note: Examples include electricity meters, primary overcurrent protection devices and ripple control units.

Clearances, Rated Surge Voltages, Overvoltage Categories, Pollution Degrees

Surge voltages (Table 1) are a decisive factor in determining clearances.

The basis forms the **overvoltage category**, i.e., the allocation of the equipment to the expected overvoltage, and the **conductor-ground voltage** derived from the nominal mains voltage in installations with a grounded Y (star) point.

In ungrounded installations, or installations where the conductor is not grounded, the voltage between conductors is applicable in the same way as conductor voltage to ground.

The rated surge voltage must be selected from Table F.1 corresponding to the overvoltage category specified and to the rated voltage of the equipment.

Table F.1 – Rated Surge Voltage for Equipment Energized Directly from the Low-Voltage Mains (DIN EN 60664-1/VDE 0110-1)

Voltage Curve: 1.2/50 μ s per IEC 60060-1/VDE 0432-1

Nominal voltage of the power supply system ¹⁾ (mains) per IEC 60038 ²⁾		Conductor-to-neutral voltage, derived from the nominal AC or DC voltage up to and including: V	Rated surge voltage ²⁾			
Three-phase V	Single-phase V		Overvoltage category ⁴⁾			
		V	I V	II V	III V	IV V
		50	330	500	800	1500
		100	500	800	1500	2500
		120 ... 240	150 ⁵⁾	800	1500	2500
230 / 400 277 / 480		300	1500	2500	4000	6000
400 690		600	2500	4000	6000	8000
1000		1000	4000	6000	8000	12000

¹⁾ See Annex B for application to existing different low-voltage mains and their nominal voltages.

²⁾ Equipment with these rated impulse voltage levels can be used in installations complying with IEC 60364-4-443.

³⁾ The / mark indicates a 3-phase, 4-conductor system. The lower value is the conductor-to-neutral voltage, while the higher value is the conductor-to-conductor voltage. Where only one value is indicated, it refers to 3-phase, 3-conductor systems and specifies the conductor-to-conductor voltage.

⁴⁾ See 4.3.3.2.2 for an explanation of the overvoltage categories.

⁵⁾ The nominal voltages for single-phase systems in Japan are 100 V or 100 ... 200 V. The value for the rated impulse voltage is, however, derived from the voltage gaps conductor-to-neutral for a voltage level of 150 V (see Annex B).

The nominal supply voltage and the corresponding rated impulse voltage values apply for grounded and ungrounded circuits.

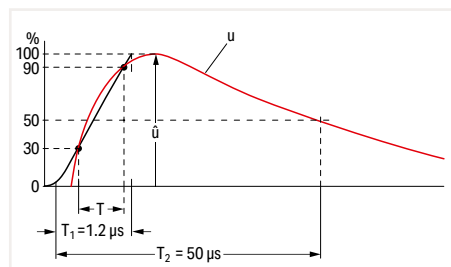

Voltage pulse: 1.2/50 μ s per EN 60060-1/VDE 0432-1

Pollution Degrees

Pollution factors are all solid, liquid or gaseous foreign matter which may reduce the dielectric strength or the specific surface resistance. Factors are divided into four classes based on expected environmental conditions:

		Examples of pollution degrees for assigned areas:
Pollution degree 1:	No pollution, or only dry, non-conductive pollution occurs. Pollution has no influence.	Open, unprotected insulated equipment in air-conditioned or clean, dry rooms
Pollution degree 2:	Only non-conductive pollution occurs. Occasional, temporary conductivity caused by condensation can also be expected.	Open, unprotected insulated equipment in occupied areas, shops, laboratories, mechanical workshops and medical rooms.
Pollution degree 3:	Conductive pollution occurs, or dry, non-conductive pollution occurs which will become conductive due to condensation.	Open, unprotected insulated equipment in industrial, business and farming areas (e.g., unheated rooms, workshops and boiler rooms)
Pollution degree 4:	The pollution generates persistent conductivity caused by conductive dust, rain or wet conditions.	Open, unprotected insulated equipment for outdoor use

Dimensioning Clearances

(DIN EN 60664-1/VDE 0110-1, Table F.2)

Select the minimum clearances in accordance with the rated surge voltages and pollution degrees. To maximize the operating life of the equipment, do not go below these minimum clearances.

Table F.2 contains a list of information for Case A, the inhomogeneous field and for Case B, the homogeneous field.

This involves an electric field with essentially constant (Case B) or non-constant (Case A) voltage gradients between the electrodes.

Equipment with a clearance that is dimensioned per Case A, in other words rated for the most unfavorable case, requires no verification by the impulse voltage test.

Equipment with a clearance that is dimensioned per Case B, or between A and B, requires verification by the impulse voltage test.

The clearances shown in Table F.2 are applicable for an installation height of up to 2000 m above sea level.

Values for clearances above 2000 m must be multiplied by a high correction factor in accordance with Table A.2.

Table F.2 – Clearances to Withstand Transient Overvoltages
DIN EN 60664-1/VDE 0110-1

Required Impulse Withstand Voltage ¹⁾⁵⁾	Minimum Clearances in Air up to 2000 m Above Sea Level					
	Case A Inhomogeneous Field (see 3.15)			Case B Homogeneous Field (see 3.14)		
	Pollution Degree ⁶⁾			Pollution Degree ⁶⁾		
	1 mm	2 mm	3 mm	1 mm	2 mm	3 mm
0.33 ²⁾	0.01	0.2 ³⁾⁴⁾	0.8 ⁴⁾	0.01	0.2 ³⁾⁴⁾	0.8 ⁴⁾
0.4	0.02			0.02		
0.5 ²⁾	0.04			0.04		
0.6	0.06			0.06		
0.8 ²⁾	0.10			0.10		
1	0.15			0.15		
1.2	0.25	0.25	0.2	0.3	0.3	0.3
1.5 ²⁾	0.5	0.5	0.3			
2	1	1	0.45			
2.5 ²⁾	1.5	1.5	1.5	0.6	0.6	0.6
3	2	2	2	0.8	0.8	0.8
4 ²⁾	3	3	3	1.2	1.2	1.2
5	4	4	4	1.5	1.5	1.5
6 ²⁾	5.5	5.5	5.5	2	2	2
8 ²⁾	8	8	8	3	3	3
10	11	11	11	3.5	3.5	3.5
12 ²⁾	14	14	14	4.5	4.5	4.5
15	18	18	18	5.5	5.5	5.5
20	25	25	25	8	8	8
25	33	33	33	10	10	10
30	40	40	40	12.5	12.5	12.5
40	60	60	60	17	17	17
50	75	75	75	22	22	22
60	90	90	90	27	27	27
80	130	130	130	35	35	35
100	170	170	170	45	45	45

¹⁾ This voltage is for:

- Functional insulation: the maximum impulse voltage expected to occur across the clearance (see 5.1.5)
- Basic insulation directly exposed to or significantly influenced by transient overvoltages from the low-voltage mains (see 4.3.3.3, 4.3.3.4.1 and 5.1.6): the rated impulse voltage for the equipment;
- Other basic insulation (see 4.3.3.4.2): the highest impulse voltage that can occur in the circuit
For reinforced insulation, see 5.1.6.

²⁾ Preferred values specified in 4.2.3

³⁾ For printed wiring material, the values for pollution degree 1 apply, except that the value must not be less than 0.04 mm, as specified in Table F.4.

⁴⁾ The minimum clearances given for pollution degree 2 and 3 are based on the reduced withstand characteristics of the associated creepage distance under humidity conditions (see IEC 60664-5).

⁵⁾ For parts or circuit within equipment subject to surge voltages based on 4.3.3.4.2, interpolation of values is allowed. However, standardization is achieved by using the preferred series of impulse voltage values based on 4.2.3.

⁶⁾ The dimensions for pollution degree 4 are as specified for pollution degree 3, except that the minimum clearance is 1.6 mm.

Tests and Testing Procedures per IEC/EN Standards (continued)

Electrical Tests (continued)



• Insulation Parameters per IEC/EN 60664-1 (continued)

Creepage Distances, Rated Voltages, Material Groups

Criteria for dimensioning creepage distances are the rated voltages, pollution degrees and material groups.

The pollution degrees specified for the clearances, and its quoted allocation to locations, is also applicable for creepage distances. Tables F.3 a and F.3 b of DIN EN 60664-1/ VDE 0110-1 contain the rated voltages that have to be considered for dimensioning the minimum creepage distances.

Table F.3a – Single-Phase, 3- or 2-Conductor, AC or DC Systems

Nominal Voltage of the Power Supply System (Mains)*	Voltages for Table F.4	
	For insulation conductor-to-conductor ¹⁾	For insulation conductor-to-ground ¹⁾
	All systems 	Three-conductor systems, center-point grounded 
V	V	V
12.5	12.5	
24 25	25	
30	32	
42 48 50**	50	
60	63	
30 to 60	63	32
100**	100	
110 120	125	
150**	160	
200	200	
110 to 200	200	100
220	250	
110 to 220 120 to 240	250	
300**	320	
220 to 440	500	250
600**	630	
480 to 960	1000	500
1000**	1000	

¹⁾ Conductor-to-ground insulation level for non-grounded or impedance-grounded systems equals that for conductor-to-conductor, as the operating voltage to ground of any conductor can, in practice, approach full conductor-to-conductor voltage. This is because the actual voltage to ground is determined by the insulation resistance and capacitive reactance of each conductor to ground; thus, low (but acceptable) insulation resistance of one conductor can in effect ground it and raise the other two to full conductor-to-conductor voltage to ground.

*For the relationship to rated voltage, see 4.3.2.

**These values correspond to the values given in Table F.1.

Altitude m	Standard Air Pressure (in kPa)	Multiplier for Clearances
2000	80	1
3000	70	1.14
4000	62	1.29
5000	54	1.48
6000	47	1.7
7000	41	1.95
8000	35.5	2.25
9000	30.5	2.62
10000	26.5	3.02
15000	12	6.67
20000	5.5	14.5

Table F.3b – Single-Phase, 4- or 3-Conductor AC Systems

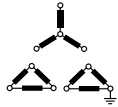
Nominal Voltage of the Power Supply System (Mains)*	Voltages for Table F.4		
	For insulation conductor-to-conductor ¹⁾	For insulation conductor-to-ground ¹⁾	
	All systems	Three-phase, 4-conductor systems with grounded neutral conductor ²⁾	Three-phase, 3-conductor systems, non-grounded ¹⁾ or grounded conductor
V	V		
V	V	V	V
60	63	32	63
110 120 127	125	80	125
150**	160		160
200	200		200
208	200	125	200
220 230 240	250	160	250
300**	320		320
380 400 415	400	250	400
440	500	250	500
480 500	500	320	500
575	630	400	630
600**	630		630
660 690	630	400	630
720 830	800	500	800
960	1000	630	1000
1000**	1000		1000

¹⁾ Conductor-to-ground insulation level for non-grounded or impedance-grounded systems equals that for conductor-to-conductor, as the operating voltage to ground of any conductor can, in practice, approach full conductor-to-conductor voltage. This is because the actual voltage to ground is determined by the insulation resistance and capacitive reactance of each conductor to ground; thus, low (but acceptable) insulation resistance of one conductor can in effect ground it and raise the other two to full conductor-to-conductor voltage to ground.

²⁾ For equipment used on both three-phase, 4-conductor and three-phase, 3-conductor systems, grounded and non-grounded, use only the values for 3-conductor systems.

*For the relationship to rated voltage, see 4.3.2.

**These values correspond to the values given in Table F.1.

Material Groups

Insulation materials are classified into four groups according to their Comparative Tracking Index (CTI) as follows:

Material Group I: $600 \leq \text{CTI}$

Material Group II: $400 \leq \text{CTI} < 600$

Material Group IIIa: $175 \leq \text{CTI} < 400$

Material Group IIIb: $100 \leq \text{CTI} < 175$

The CTI values above refer to values obtained in accordance with DIN EN 60664-1/VDE 0110-1 on samples specially made for this purpose and tested with Solution A.

Tests and Testing Procedures per IEC/EN Standards (continued)

Electrical Tests (continued)

• Insulation Parameters per IEC/EN 60664-1 (continued)

Table F.4 – Creepage Distances to Avoid Failure due to Tracking
DIN EN 60664-1/VDE 0110-1

Voltage ¹⁾ (RMS)	Minimum Creepage Distances								
	Printed Circuits		Pollution Degree						
	Pollution Degree		1	2	2	2	3	3	3
	1 All Material Groups	2 All Material Groups except IIIb	1 All Material Groups	Material Group I	Material Group II	Material Group III	Material Group I	Material Group II	Material Group III ²⁾
V	mm	mm	mm	mm	mm	mm	mm	mm	mm
10	0.025	0.04	0.08	0.4	0.4	0.4	1	1	1
12.5	0.025	0.04	0.09	0.42	0.42	0.42	1.05	1.05	1.05
16	0.025	0.04	0.1	0.45	0.45	0.45	1.1	1.1	1.1
20	0.025	0.04	0.11	0.48	0.48	0.48	1.2	1.2	1.2
25	0.025	0.04	0.125	0.50	0.5	0.5	1.25	1.25	1.25
32	0.025	0.04	0.14	0.53	0.53	0.53	1.3	1.3	1.3
40	0.025	0.04	0.16	0.56	0.8	1.1	1.4	1.6	1.8
50	0.025	0.04	0.18	0.6	0.85	1.2	1.5	1.7	1.9
63	0.04	0.063	0.2	0.63	0.9	1.25	1.6	1.8	2
80	0.063	0.1	0.22	0.67	0.95	1.3	1.7	1.9	2.1
100	0.1	0.16	0.25	0.71	1	1.4	1.8	2	2.2
125	0.16	0.25	0.28	0.75	1.05	1.5	1.9	2.1	2.4
160	0.25	0.4	0.32	0.8	1.1	1.6	2	2.2	2.5
200	0.4	0.63	0.42	1	1.4	2	2.5	2.8	3.2
250	0.56	1	0.56	1.25	1.8	2.5	3.2	3.6	4
320	0.75	1.6	0.75	1.6	2.2	3.2	4	4.5	5
400	1	2	1	2	2.8	4	5	5.6	6.3
500	1.3	2.5	1.3	2.5	3.6	5	6.3	7.1	8 (7.9) ⁴⁾
630	1.8	3.2	1.8	3.2	4.5	6.3	8 (7.9) ⁴⁾	9 (8.4) ⁴⁾	10 (9) ⁴⁾
800	2.4	4	2.4	4	5.6	8	10 (9) ⁴⁾	11 (9.6) ⁴⁾	12.5 (10.2) ⁴⁾
1000	3.2	5	3.2	5	7.1	10	12.5 (10.2) ⁴⁾	14 (11.2) ⁴⁾	16 (12.8) ⁴⁾
1250			4.2	6.3	9	12.5	16 (12.8) ⁴⁾	18 (14.4) ⁴⁾	20 (16) ⁴⁾
1600			5.6	8	11	16	20 (16) ⁴⁾	22 (17.6) ⁴⁾	25 (20) ⁴⁾
2000			7.5	10	14	20	25 (20) ⁴⁾	28 (22.4) ⁴⁾	32 (25.6) ⁴⁾
2500			10	12.5	18	25	32 (25.6) ⁴⁾	36 (28.8) ⁴⁾	40 (32) ⁴⁾
3200			12.5	16	22	32	40 (32) ⁴⁾	45 (36) ⁴⁾	50 (40) ⁴⁾
4000			16	20	28	40	50 (40) ⁴⁾	56 (44.8) ⁴⁾	63 (50.4) ⁴⁾
5000			20	25	36	50	63 (50.4) ⁴⁾	71 (56.8) ⁴⁾	80 (64) ⁴⁾
6300			25	32	45	63	80 (64) ⁴⁾	90 (72) ⁴⁾	100 (80) ⁴⁾
8000			32	40	56	80	100 (80) ⁴⁾	110 (88) ⁴⁾	125 (100) ⁴⁾
10000			40	50	71	100	125 (100) ⁴⁾	140 (112) ⁴⁾	160 (128) ⁴⁾
12500			50 ³⁾	63 ³⁾	90 ³⁾	125 ³⁾			
16000			63 ³⁾	80 ³⁾	110 ³⁾	160 ³⁾			
20000			80 ³⁾	100 ³⁾	140 ³⁾	200 ³⁾			
25000			100 ³⁾	125 ³⁾	180 ³⁾	250 ³⁾			
32000			125 ³⁾	160 ³⁾	220 ³⁾	320 ³⁾			
40000			160 ³⁾	200 ³⁾	280 ³⁾	400 ³⁾			
50000			200 ³⁾	250 ³⁾	360 ³⁾	500 ³⁾			
63000			250 ³⁾	320 ³⁾	450 ³⁾	600 ³⁾			

¹⁾ This voltage is for:

- Functional insulation; the working voltage
- Basic and supplementary insulation of the circuit energized directly from the mains (see 4.3.2.2.1): for the voltage rationalized through Table F.3a or F.3b, based on the rated voltage of the equipment, or the rated insulation voltage
- Basic and supplementary insulation of systems, equipment and internal circuits not energized directly from the mains (see 4.3.2.2.2): the highest rms voltage which can occur in the system, equipment or internal circuit when supplied at rated voltage and under the most taxing combination of operation conditions within equipment rating

²⁾ Material group IIIb is not recommended for applications in pollution degree 3 above 630 V.

³⁾ Provisional data based on extrapolation. Technical committees who have other information based on experience may use their dimensions.

⁴⁾ The values in brackets must only be applied for reducing creepage distances if a rib is used (see 5.2.5).

The high degree of accuracy of the creepage distances given in the table does not imply that the measuring accuracy must be of the same quality.

Depending on the intended use, WAGO's terminal blocks, splicing and pluggable connectors are suitable for pollution degrees 2 or 3 and for overvoltage categories II or III.

Example:

WAGO Rail-Mount Through Terminal Blocks
per IEC 60947-7-1/
EN 60947-7-1/VDE 0611-1, these blocks have the following ratings:

800 V / 8 kV / 3	
Rated voltage:	800 V
Rated surge voltage	8 kV
Pollution Degree	3
Overvoltage category	III

WAGO's connectors for household and similar mounted installations are rated per IEC 60998-1 / EN 60998-1 / VDE 0613-1, Table 3.

Example:

WAGO PUSH WIRE® Connectors for Junction Boxes

According to this standard, these connectors are rated for:

*400 V / 4 kV / 2
*grounded circuits

Rated voltage:	400 V
Rated surge voltage	4 kV
Pollution Degree	2
Overvoltage category	II

Table 3 – Clearances and Creepage Distances
(IEC/EN 60998-1)

Rated Insulation Voltage V	Clearances/Creepage Distances mm
≤ 130	1.5
> 130 and ≤ 250	3
> 250 and ≤ 450	4
> 450 and ≤ 750	6
> 750	8

Sold & Serviced By:

 **ELECTROMATE**

Toll Free Phone (877) SERV098
www.electromate.com
sales@electromate.com

14

Tests and Testing Procedures per IEC/EN Standards (continued)

Electrical Tests (continued)

• Power-Frequency Withstand Voltage Test per IEC/EN 60947-7-1, IEC/EN 60947-1

This testing procedure verifies creepage distances. Creepage distances, i.e., the distances of creeping currents, are caused by conductive impurities on the surface of the insulation housing. Apart from the amount of impurities to which a terminal block is subjected, for example, the plastic material and housing design are also involved in generating creeping currents. The insulation material of the housing may be carbonized by a creeping current, which further increases conductivity.

The specimen is tested using a power-frequency withstand voltage for a short time. For example, a rail-mount terminal block designed to operate at 800 V nominal voltage is usually tested using 2000 V alternating voltage for one minute. The test is passed if no flashovers or breakdowns have occurred.

• Rated Impulse Withstand Voltage Test per IEC/EN 60947-7-1, IEC/EN 60947-1

This test verifies the clearances of a product. In simplified terms, clearance is the distance between two poles of a terminal block. If this distance is too small, voltage peaks may cause flashovers or breakdowns. The arrangement of the rated impulse withstand voltage test is identical to that of the power frequency withstand voltage test; the test voltages, however, are comparatively higher and the testing times shorter, e.g., 9.8 kV over 50 μ s (see figure).

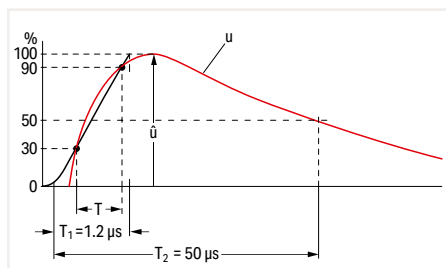

Voltage pulse: measurement curve (red) and auxiliary curve (black) for calculating the rate of rise of the pulse and the resulting (virtual) peak of the curve.

- T: Time interval for calculating the rate of rise
- T1: Front time (duration between start of impulse and reaching the peak)
- T2: Total pulse duration

The test values are the values at sea level as specified in the relevant test specification. The values indicated in the catalog correspond to an altitude of 2000 m.

The test is passed if no flashovers or breakdowns have occurred.

Voltage pulse: 1.2/50 μ s per EN 60060-1/VDE 0432-1

• IP Ratings for Electrical Equipment per IEC/EN 60529

Alphanumeric Nomenclature for Type of Protection				IP vs. NEMA	
Code letters IP	Protection against accidental contact and against the penetration of foreign objects or water	IP (Ingress Protection) = International degree of protection		IP Code	NEMA
First code number 0 to 6	Indicates the degree of protection against accidental contact and the penetration of foreign objects.	If indicating the degree of protection requires only one digit, the other (second) digit must be substituted for with an X.		10	1
Second code number 0 to 8	Indicates the degree of protection against water penetration.			11	2
First code number:		Second code number:		54	3
IP0X	No protection against accidental contact or the penetration of foreign objects	IPX0	No protection against water	14	3R
IP1X	Protection against foreign objects > 50 mm	IPX1	Protection against vertically falling water	54	3S
IP2X	Protection against foreign objects > 12 mm (e.g., finger)	IPX2	Protection against diagonally dripping water (15° angle)	55	4&4X
IP3X	Protection against foreign objects > 2.5 mm	IPX3	Protection against water spray	52	5
IP4X	Protection against foreign objects > 1 mm	IPX4	Protection against water spray	67	6&6P
IP5X	Protection against damaging dust deposits	IPX5	Protection against water jet, e.g., from a nozzle	52	12&12K
IP6X	Protection against dust penetration	IPX6	Protection against flooding	54	13
		IPX7	Protection against temporary immersion		
		IPX8	Protection against continuous immersion		
		IPX9	Protection against high-pressure and high-temperature water jets		

Tests and Testing Procedures per IEC/EN Standards (continued)

Material Tests

All WAGO products meet requirements for the following material tests:

- Needle Flame Test per IEC/EN 60947-7-1, IEC/EN 60695-11-5

This test simulates flames that may arise under certain conditions (e.g. fault current over a creepage distance, overloading of parts or components). Nearby parts can also be affected by such flames.

Not only the ignition of the test specimen resulting from an intrinsic defect is tested, but also its behavior when other parts ignite.

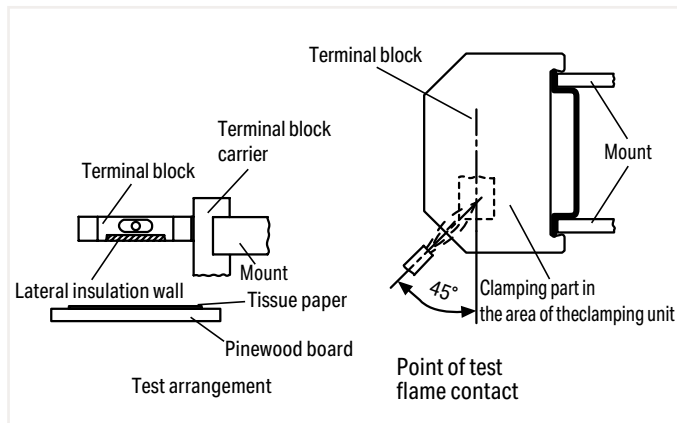

Flames must not be fuelled by the insulation materials used, thus creating a larger fire. The test specimen is exposed to a standard gas flame during a defined time period (e.g., ten seconds).

After the test flame has been removed, the specimen must self-extinguish within 30 seconds. Furthermore, a layer of tissue paper located beneath the specimen must not be ignited by glowing particles falling from the specimen.

- Glow-Wire Test per IEC/EN 60998-1, IEC/EN 60695-2-11

In the event of failure, a high current may cause a conductor to glow.



However, the glowing conductor shall not cause ignition of the product involved (e.g., a rail-mount terminal block). For the glow-wire test, the tip of the glow-wire is pressed against a surface of the test specimen (see picture).

The position of the test specimen, surface to be tested, test duration and glow-wire temperature (e.g., 960°C/1760°F over 30 seconds, or 850°C/1562°F over 5 seconds) are specified in the standards.

The specimen must be positioned such that the tip of the glow-wire acts on the surface section of the specimen (vertical surface of the specimen) that is most likely to be exposed to thermal loading during normal use.

As the highest temperature in the event of a fault is anticipated at the contact insert/wire connection, the tip of the glow-wire must act upon the section of the insulation housing that is the closest to this contact point. The test is passed if there are no visible flames or permanent glowing, or if flames or glowing extinguish within 30 seconds after removal of the glow-wire. Furthermore, a layer of tissue paper located beneath the specimen must not be ignited by glowing particles falling from the specimen.

Tests and Testing Procedures per IEC/EN Standards (continued)

Environmental Tests

The following tests show how a product reacts when exposed to an aggressive environment. Climatic chambers simulate standard atmospheres that could impact the long-term consistency of clamping units.

All WAGO products meet the requirements of the following environmental tests:

- Temperature Cycling Test per IEC/EN 60947-7-1, IEC/EN 60998-2-2

This test shows the change of voltage drop over longer periods under temperature cycling conditions. The test procedure usually consists of 192 temperature cycles, for example, each cycle having a duration of 60 minutes (see diagram).

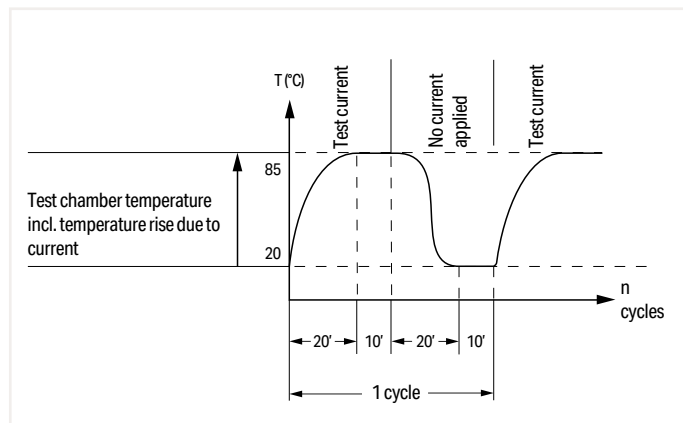

The rated current is applied to the test specimen during temperature rise and when the temperature has reached its maximum value; during the second half of the cycle, the current is zero. Voltage drop is measured every 24 cycles and must not exceed a maximum value or vary greatly. The voltage drop measured at the end of the 192nd cycle must not exceed 1.5 times the value measured after the 24th cycle. After the test, an inspection must show no changes that would impair further use of the product.

- Industrial Atmospheres per EN ISO 6988, IEC/EN 60068-2-42, IEC/EN 60068-2-60

Sulphur and its combustion products are particularly aggressive pollutants commonly found in industrial environments. A test procedure simulating such corrosive conditions consists of exposing a test specimen to water condensation in variable atmospheres containing sulphur dioxide.



A saturated atmosphere is first created in a climatic chamber by heating an aqueous sulphur dioxide solution. After less than half an hour, the test specimen is fully saturated by the condensing vapors and exposed to this atmosphere for eight hours.

After exposure to a humid atmosphere, the test specimen is subjected to dry and cooler conditions at room temperature for 16 hours. Depending on the test severity, the specimen is exposed to both these conditions several times. The gas-tightness of the clamping unit is verified by a voltage drop test.

In other test procedures, products are exposed to a dry corrosive gas atmosphere containing sulfide, nitrogen and sulfur oxides or chloride gas. These tests can be performed over a period of four to 21 days.

• Salt Spray Test per IEC/EN 60068-2-11; DNV GL, LR (Marine Applications)

This test is similar to the test performed in atmospheres with varying water condensation, except that instead of industrial atmospheres, salt mist conditions will be simulated in a heated test chamber (see picture).

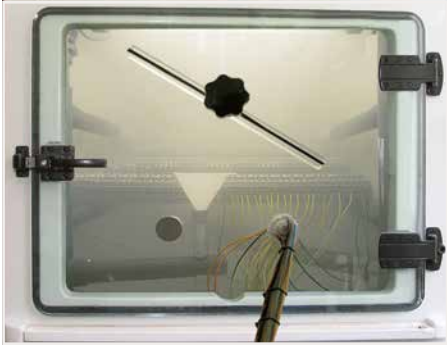

Depending on the test procedure being used, the test specimen is sprayed with salt mist for 16 hours up to 672 hours (4 weeks). Salt spray tests are widely used, especially for marine approvals. However, this test is performed differently than the test procedures described previously for general applications: During a typical test, the test specimen is sprayed with a salt solution for two hours and is then stored for seven days in an atmosphere with a relative humidity between 90 and 95%. This procedure is repeated four times. Voltage drop measurements are used as an evaluation criterion.

• Quick Change of Temperature per IEC/EN 60068-2-14

Without air-conditioning, distribution panels and terminal boxes are exposed to seasonal (and ever-changing) temperature extremes – especially on the open field side. In process technology, for example, a terminal block is exposed to even quicker changes in temperature.

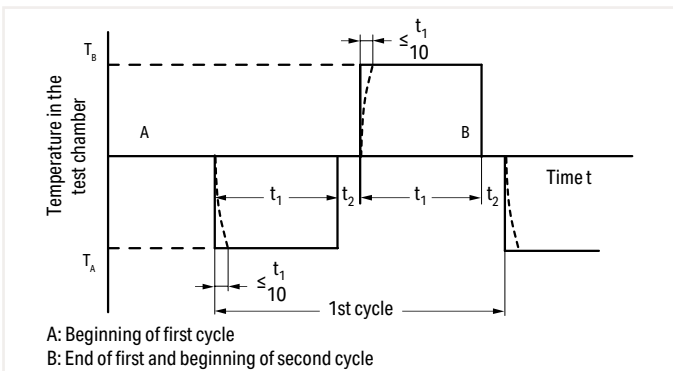

To simulate such conditions, the test specimen is exposed to repeated temperature changes, for example, between TA -40°C (-104°F) and TB +70°C (+158°F). The dwell time t1 depends on the thermal capacity of the test specimen and should be between maximum of 3 h and minimum of 10 min and the transition time t2 2 ... 3 min, 20 ... 30 s or less than 10 s. The mechanical and electrical properties of the product are checked at the end of the test.

• Damp Heat, Cyclic (12 + 12 Hour Cycle) per IEC/EN 60068-2-30, DNV GL, LR (Marine Applications)

This test determines the suitability of electrical equipment for use and storage under conditions of high relative humidity when combined with cyclic temperature changes and, in general, producing condensation on the surface of the specimen.

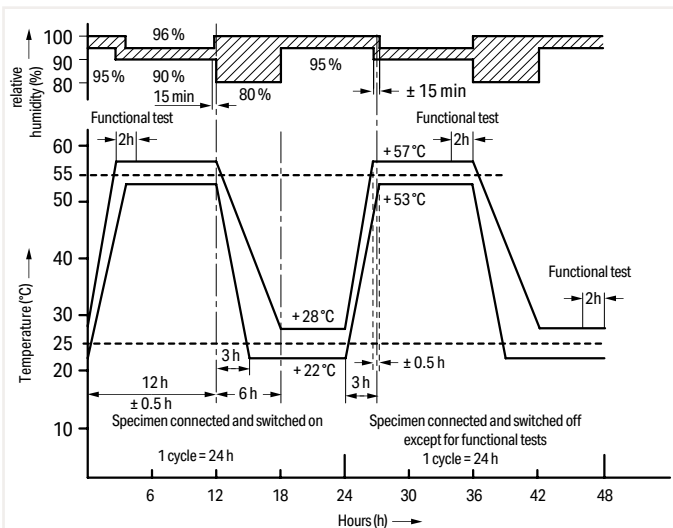

In addition to the salt spray tests, the damp heat test is also used for marine approvals. For this test, the specimens are subjected to temperatures varying cyclically between +25°C (+77°F) and +55°C (+131°F) with a relative humidity of 95% (for tolerances see figure). Functional tests are performed at defined times during the storage period. The mechanical and electrical properties of the product are checked at the end of the test.

UL Specifications – Underwriters Laboratories, USA

WAGO's terminal blocks and connectors are tested by Underwriters Laboratories Inc. according to one or more of the relevant following UL standards:

- | | | |
|---|---------------------|---|
| • The 273 Series PUSH WIRE® Connectors for Junction Boxes or the 224 Series Lighting Connectors are splicing wire connectors and are certified per UL 486C. These stand-alone devices carry the UL Listing Mark ®. | UL 486 C | Splicing wire connectors |
| • Rail-mount terminal blocks or modular terminal blocks (e.g., 280 Series, TOPJOB® S or 260 to 262 Series terminal blocks) are approved as non-stand-alone components per UL 1059 in connection with UL 486E. | UL 1059
UL 486 E | Standard for terminal blocks
Equipment wiring terminals for use with aluminum and/or copper conductors |
| • The X-COM®-SYSTEM is approved as terminal blocks per UL 1059 standard in connection with UL 486 E. It is therefore defined for field and factory wiring with at 300 V. | | |
| • It is also approved as connectors for use in data, signal, control and power applications per UL 1977 for factory wiring at 600 V (i.e., the clamping unit must be wired under controlled manufacturing conditions). | UL 1977 | Component connectors for use in data, signal, control and power applications |
| • Ex e II terminal blocks are approved to UL 60079-7. | UL 60079-7 | Electrical apparatus for explosive gas atmospheres – Part 7: Increased safety |
| • Ground terminal blocks are tested for grounding and bonding applications per UL 467. Components bearing the UR Recognition Mark  are recognized product. Additionally, after being mounted in their special applications, these components are submitted to an end-product test according to the relevant device or equipment standard. | UL 467 | Grounding and bonding equipment |
| • Insulation materials are tested for flammability and performance per UL 94. | UL 94 | Tests for flammability of plastic materials for parts in devices and appliances |

Tests and Testing Procedures per UL Standards

All WAGO products meet requirements for the following tests:

- Pull-Out Test per UL 1059, UL 486 E (Rail-Mount Terminal Blocks), UL 486 C (Splicing Wire Connectors)

In this test, the connected conductors are subjected to the appropriate pull-out forces specified in the following table without jerking for a period of one minute. Different test arrangements are specified for rail-mount terminal blocks and splicing wire connectors.

Conductor Size AWG or kcmil		Pull-Out Force, Pounds (N)			
		UL 486 E, Table 22			
		Copper		Aluminum	
30	(0.05)	0.5	(2.2)	-	-
28	(0.08)	1	(4.5)	-	-
26	(0.13)	2	(8.9)	-	-
24	(0.2)	3	(13.4)	-	-
22	(0.32)	4.5	(20)	-	-
20	(0.52)	6.75	(30)	-	-
18	(0.82)	6.75	(30)	-	-
16	(1.3)	9	(40)	-	-
14	(2.1)	11.5	(50)	-	-
12	(3.3)	13.5	(60)	10	(44)
10	(5.3)	18	(80)	10	(44)
8	(8.4)	20.5	(90)	10	(44)
6	(13.3)	21	(94)	28	(124)
4	(21.2)	30	(133)	36	(160)
3	(26.7)	35	(156)	42	(187)
2	(33.6)	42	(186)	50	(222)
1	(42.4)	53	(236)	61	(271)
1/0	(53.5)	64	(285)	72	(320)
2/0	(67.4)	64	(285)	78	(347)
3/0	(85.0)	79	(351)	97	(432)
4/0	(107)	96	(427)	116	(516)
250	(127)	96	(427)	116	(516)
300	(156)	99	(441)	116	(516)

Test Arrangement per UL 1059, UL 486 E:

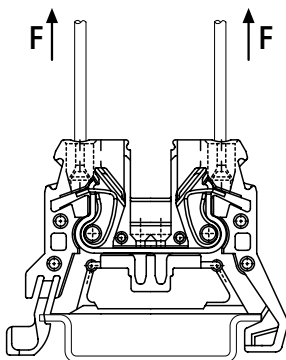

Test Arrangement per UL 486 C:

During the test, the conductors must neither slip out of the clamping unit, nor break near the clamping unit.

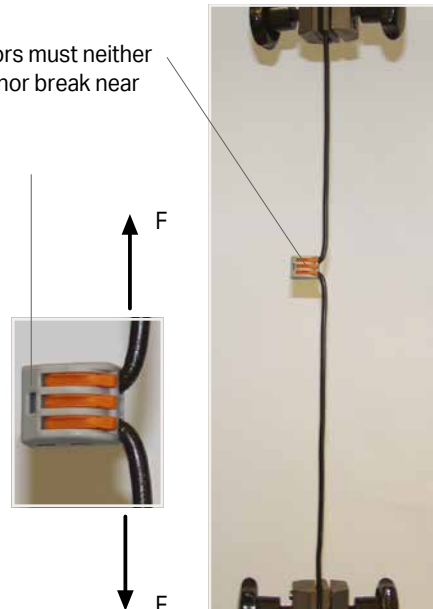

UL Specifications – Underwriters Laboratories, USA (continued)

Tests and Testing Procedures per UL Standards (continued)

• Heat Cycling Test per UL 1059, UL 486 E

Test performed per:

UL 1059

Test performed with maximum rated cross section

Test current: 150% of maximum rated current

84 cycles of: 3 1/2 h ON / 1/2 h OFF

The temperature rise is measured after the first and the 84th cycle.

The temperature rise must not exceed 5°C (41°F) after the 84th cycle, compared to the temperature measured after the first cycle.

UL 486 C (Splicing wire connectors)

UL 486 E (Equipment wiring terminals)

Test performed with maximum rated cross section

Test current: Increased test current per UL 486 C, Table 6
UL 486 E, Table 4

500 cycles of: 1 h ON / 1 h OFF
1 1/2 h ON / 1 1/2 h OFF
(from 4/0 AWG up to 400 kcmil per UL 486 E)

The temperature rises at the terminal blocks and control conductors are measured and recorded after: 1, 25, 50, 75, 100, 125, 175, 225, 275, 350, 425 and 500 cycles.

The temperature rise must not exceed 125°C (257°F) and the stability factor "S" must not exceed ±10.

Conductor Size		Test Current for Copper Conductors in A								
		UL 486 E, Table 4						UL 486 C, Table 6		
		Assigned Maximum Ampere Rating ^b	Static Heating ^{a,c,g}	Heat Cycling Temperature Rating ^a			Static Heating	Heat Cycling		
75°C (167°F) ^{d,g}	90°C (194°F) ^{e,g}									
AWG or kcmil	(mm ²)									
30	(0.05)	-		3		3.5		4	3	3.5
28	(0.08)	-		3.5		4		5	3.5	4
26	(0.13)	-		5.5		6		8	5.5	6
24	(0.2)	-		7		8		10	7	8
22	(0.32)	-		9		12		13	9	12
20	(0.52)	-		12		16		17	12	16
18	(0.82)	-		17		19		24	17	19
16	(1.3)	-		18		20		31	18	20
14	(2.1)	15	[20]	30	[22]	33	[27]	40	30	33
12	(3.3)	20	[25]	35	[28]	39	[40]	54	35	38
10	(5.3)	30	[40]	50	[45]	56	[60]	75	50	56
8	(8.4)	50		70		80		100	70	80
6	(13.3)	65		95		105		131	95	105
4	(21.2)	85		125		140		175		
3	(26.7)	100		145		165		205		
2	(33.6)	115		170		190		240		
1	(42.4)	130		195		220		275		
1/0	(53.5)	150		230		255		320		
2/0	(67.4)	175		265		300		370		
3/0	(85.0)	200		310		345		435		
4/0	(107)	230		360		405		505		
250	(127)	255		405		445		565		
300	(152)	285		445		500		625		

^a See Section 7.2, 8.2 and 9.2 (UL 486 E)

^b Values are for 75°C (167°F), not more than 3 conductors in raceway or cable ampacities, National Electric Code, ANSI/NFPA 70.

^c Values are for 75°C (167°F) single conductors in free air ampacities, National Electric Code, ANSI/NFPA 70.

^d Values are approximately 112% of the static heating test currents.

^e Values for 8 AWG and larger conductors are approximately 140% of the static heating test currents.

^f See Section 9.2.4

^g Values in parentheses apply to connectors with assigned ampere ratings.

- Conditioning – Temperature-Rise Rest per UL 1059, UL 486 C

Test performed per:

UL 1059 (Rail-mount terminal blocks)

UL 486 C

(Splicing wire connectors)

Conditioning:

The clamping units are **pre-wired/pre-inserted nine times** using a conductor with maximum rated cross section. At the tenth time, a new conductor is connected.

After this, a static heating test is performed.

Static Heating Test:

Test current: Terminal block rated current

Test current: Increased test current (see Table 6)

Test duration: 30 days

Test duration: 30 days

Max. permissible temperature rise: 30°C (86°F)

Max. permissible temperature rise: 50°C (122°F)

- Grounding and Bonding Equipment per UL 467

When used in grounding and bonding equipment, e.g., terminal blocks, must withstand a short circuit test using the test currents and test durations as specified in Table 5.

In the following example, a 2 AWG (35 mm²) ground conductor terminal block (285-635) is tested for 6 seconds at 3900 A.

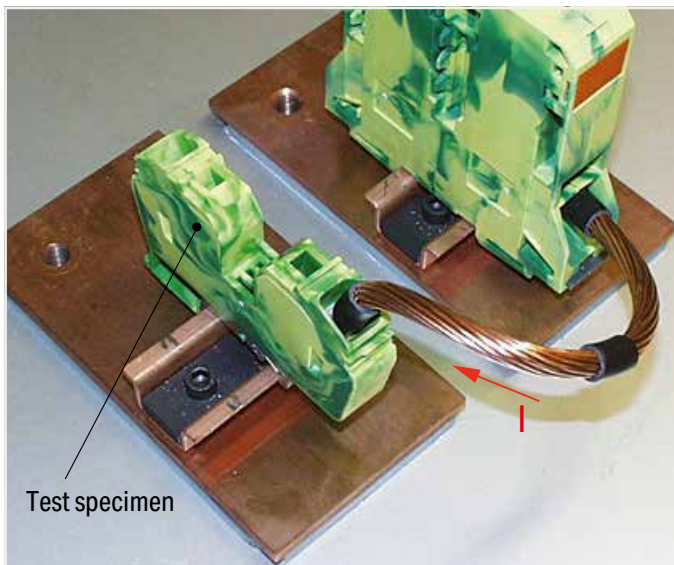

Table 5

Conductor Size Copper		Test Duration	Test Current
AWG	mm ²	s	A
14	(2.1)	4	300
12	(3.3)	4	470
10	(5.3)	4	750
8	(8.4)	4	1180
6	(13.3)	6	1530
4	(21.2)	6	2450
3	(26.7)	6	3100
2	(33.6)	6	3900
1	(42.4)	6	4900
1/0	(53.5)	9	5050
2/0	(67.4)	9	6400
3/0	(85.0)	9	8030
4/0	(107)	9	10100
250 kcmil	(127)	9	12000

After the test, the specimen must neither show evidence of cracking, breaking or melting, nor any changes in electrical properties.

UL Specifications – Underwriters Laboratories, USA (continued) Tests and Testing Procedures per UL Standards (continued)

• Insulation Parameters per UL 1059

The table below shows the potential involved and the corresponding clearances and creepage distances required in different applications.

Table 8.1 – Minimum Acceptable Spacing for Terminal Blocks per UL 1059 Standard

Application:	Potential Involved in Volts	Spacing in inches (mm) between uninsulated live parts of opposite polarity, uninsulated live parts and uninsulated grounded parts other than the enclosure			
		Through Air		Over Surfaces	
A. Dead-front switchboards, panelboards, service equipment and similar applications	51 ... 150 151 ... 300 301 ... 600	1/2 (12.7) 3/4 (19.1) 1 (25.4)	3/4 (19.1) 1-1/4 (31.8) 2 (50.8)		
B. Commercial appliances, including business equipment, electronic data processing equipment and similar applications	51 ... 150 151 ... 300 301 ... 600	1/16 ^a (1.6) ^a 3/32 ^a (2.4) ^a 3/8 (9.5)	1/16 ^a (1.6) ^a 3/32 ^a (2.4) ^a 1/2 (12.7)		
C. Industrial, general	51 ... 150 151 ... 300 301 ... 600	1/8 ^a (3.2) ^a 1/4 (6.4) 3/8 (9.5)	1/4 (6.4) 3/8 (9.5) 1/2 (12.7)		
D. Industrial, devices having limited ratings ^b	51 ... 300 301 ... 600	1/16 ^a (1.6) ^a 3/16 ^a (4.8) ^a	1/8 ^a (3.2) ^a 3/8 (9.5)		
E. Terminal blocks rated 601 ... 1500 V ^c	601 ... 1000 1001 ... 1500	0.55 (14.0) 0.70 (17.8)	0.85 (21.6) 1.20 (30.5)		

Notes:

1 A slot, groove, or similar, 0.013 inch (0.33 mm) wide or less in the contour of the insulating material is to be disregarded.

2 Air space of 0.33 mm or less between a live part and an insulating surface is to be disregarded for the purpose of measuring over surface spacing.

^a The spacing between terminal blocks of opposite polarity and the spacing between a terminal block and a grounded dead metal part shall not be less than 1/4 inch (6.4 mm) if short-circuiting or grounding of such terminal blocks may result from protruding wire strands.

^b See Section 8.5 (UL 1059)

The spacing values indicated in sub-paragraph D in Table 8.1 are applicable to a terminal block for use only in or with industrial control equipment where the load on any single circuit of the terminal block does not exceed 15 A at 51 ... 150 V, 10 A at 151 ... 300 V, 5 A at 301 ... 600 V or the maximum ampere rating, whichever is less.

^c Applies only to terminal blocks investigated to Part II of this standard. See Section 22.1 (UL 1059).

• Flammability Test per UL 94

This test provides an indication of the material's ability to extinguish a flame, once ignited.

Several ratings can be applied, based on the rated of burning, time to extinguish, ability to resist dripping, and afterglow extinguishing time. Each material tested may receive several ratings, depending on the wall thickness.

UL 94 Rating Categories:

V2

- Specimen mounted vertically
- Burning stops within 30 seconds after the flame is removed
- Flaming drips allowed
- Afterglow extinguishes within max. 60 s

V1

- Specimen mounted vertically
- Burning stops within 30 seconds after the flame is removed
- No flaming drips allowed
- Afterglow extinguishes within max. 60 s

V0

- Specimen mounted vertically
- Burning stops within 10 seconds after the flame is removed
- No flaming drips allowed
- Afterglow extinguishes within max. 30 s

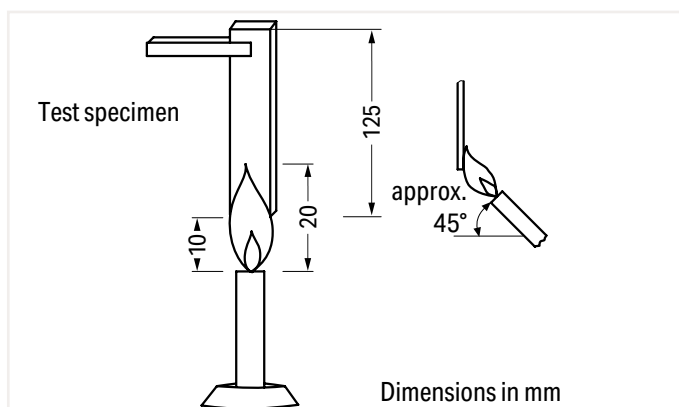

During the test, a 3/4 inch (20 ± 1 mm) flame is applied for two 10-second intervals to the specified bar specimen held vertically.

"Alu-Plus" Contact Paste

Terminating aluminum conductors

Terminating Aluminum Conductors

WAGO spring clamp terminal blocks are suitable for solid aluminum conductors ① up to 4 mm²/12 AWG if WAGO "Alu-Plus" Contact Paste is used for termination.

"Alu-Plus" Contact Paste Advantages:

- Automatically destroys the oxide film during clamping.
- Prevents fresh oxidation at the clamping point.
- Prevents electrolytic corrosion between aluminum and copper conductors (in the same terminal block).
- Provides long-term protection against corrosion.

Using terminal blocks with CAGE CLAMP® Spring Pressure Connection Technology, aluminum conductors must first be cleaned with a blade and then immediately be inserted into the clamping units filled with "Alu-Plus" Contact Paste.

It is also possible to apply WAGO "Alu-Plus" additionally on the whole surface of the aluminum conductor before termination.

Please note that the nominal currents must be adapted to the reduced conductivity of the aluminum conductors:

2.5 mm² (14 AWG) = 16 A
4 mm² (12 AWG) = 22 A

WAGO "Alu-Plus" in the syringe offers a higher degree of reliability and cleanliness when terminating solid aluminum conductors. Filling is quickly performed on selected WAGO connectors and terminal blocks (see pictures).

① Aluminum conductors per IEC 61545 standard, Class B, "Alloy 1370" with 90 ... 180 N/mm² tensile strength and 1 ... 4% elongation
Standard values: 90 ... 180 MPa tensile strength, 1 ... 4% elongation (per EN 615.4.1)



WAGO Lighting Connectors

Push nozzle of the "Alu-Plus" syringe first into the circular entry and then into the square conductor entry hole of the WAGO Lighting Connector.



Press plunger down until the "Alu-Plus" has filled both entry holes.

Note: Not suitable for higher temperature applications!



WAGO Rail-Mount Terminal Blocks (up to 4 mm²/12 AWG)

For each conductor entry: Insert nozzle of the "Alu-Plus" syringe in every open conductor entry hole (one after the other).



Press plunger down until "Alu-Plus" has filled all conductor entry holes.

Material Specifications

Insulation materials

WAGO primarily uses polyamide (PA 66 and PA 46) for housing current-conducting parts, as well as polyphthalamide (PPA) and polycarbonate (PC) for insulation material (see table). For more than 50 years, these materials have proven themselves in WAGO products and all are approved by certified, third-party agencies. All listed halogen-free and flame-retardant polymer materials do not contain any heavy metals, silicone, asbestos, or formaldehyde as formulation components.

Table: Standard Insulation Materials

Material	PA 66	PA 66 GF	PPA GF	PA 46	PC	PC
Flammability UL 94 flammability test ratings	V0	V0	V0	V2	V2	V0
Oxygen Index (OI) per EN ISO 4589-2	> 32 %	> 33 %	> 37 %	> 27 %	> 26 %	> 35 %
Glow-wire test per IEC 60695-2-12 GWF1* IEC 60695-2-13 GWIT*	850°C 775°C	850°C 775°C	850°C 775°C	750°C 725°C	800°C 850°C	960°C 850°C
Comparative Tracking Index (CTI) per IEC 60112	600 V	600 V	600 V	375 V	225 V	225 V
Temperature of the ball indentation hardness test per IEC 60695-10-2	≥ 125 °C	≥ 175 °C	≥ 225 °C	n.s.**	≥ 125 °C	≥ 125 °C
RTI impact per UL 746B	105°C	100°C	115°C	115°C	125°C	120°C
Heat deflection temperature (HDT/B) per ISO 75 (bending stress A*: 1.8 MPa; B: 0.45 MPa)	215°C	235°C	285°C	280°C	130°C (1.8 MPa)	130°C (1.8 MPa)
Surface resistivity per IEC 60093	10 ¹² Ω	10 ¹² Ω	10 ¹⁵ Ω	10 ¹³ Ω	10 ¹⁵ Ω	10 ¹⁵ Ω
Specific contact resistance per IEC 60093	10 ¹⁵ Ω/cm	10 ¹⁵ Ω/cm	10 ¹³ Ω/cm	10 ¹³ Ω/cm	10 ¹¹ Ω/cm	10 ¹³ Ω/cm
Dielectric strength per IEC 60243-1	30 kV/mm	40 kV/mm	25 kV/mm	25 kV/mm	25 kV/mm	29 kV/mm

*Value depends on wall thickness, EN 60335 compliance upon request; **n. s. = not specified

Polyamide (PA 66)

WAGO uses modified, halogen-free, flame-retardant polyamides.

These materials do not corrode, are difficult to ignite and feature self-extinguishing properties (V0 rating per UL 94).

Adhering to UL 746C, the polyamides used at WAGO have a continuous operating temperature of 105°C (221°F) based on the relative temperature index with impact load (RTIimp). This ensures that the necessary electrical and mechanical insulating properties are maintained at a sufficiently guaranteed level over a long period of time.

The short-term upper temperature limit is 200°C (392°F).

In lower temperature ranges, it has been determined that no damage to the insulation material occurs during usage down to -35°C (-31°F). After installation and wiring, WAGO products can even be used at temperatures down to -60°C (-76°F).

Environmental humidity (up to 2.5% in a standard atmosphere) is absorbed, providing the polyamides with optimum elasticity, strength and durability.

In practical use, basic stabilization of WAGO's polyamides has been proven over many years to be sufficient to prevent damage caused by ozone or UV radiation exposure in intended applications.

Polyamides have excellent resilience against the most demanding climates and have proven themselves in tropical applications worldwide. Insulation parts made of polyamide are resistant to insects. The material does not provide oxygen or other biogenic elements to microorganisms.

The presence of anaerobic earth bacteria, mold, fungus and enzymes does not degrade the material.

Polyamides are resistant to most fuels, greases, and oils, as well as the most commonly used cleaners, such as alcohol, Freon, Frigen, and carbon tetrachloride. Acid resistance depends on the acid type and concentration, as well as the exposure time.

The use of insulation materials during in-house production at WAGO only occurs after acceptance of factory test certificates and specified material tests.

Glass Fiber-Reinforced Polyamide (PA 66 GF)

WAGO uses glass-fiber-reinforced polyamides for components with increased mechanical demands, such as levers, push-buttons or housings exposed to high stress, because they have significantly better mechanical characteristic properties than non-reinforced polyamides.

In general, materials are used that have excellent tracking resistance, flammability ratings and high temperature resistance.

More data can be found in the table.

Polyphthalamide (PPA GF)

Glass-fiber-reinforced, high-performance polyamides are ideal for high-temperature applications, due to the material's high level of thermal dimensional stability, its low dependence on ambient conditions and its excellent strength properties. The material's outstanding tracking resistance permits short creepage distances to be incorporated into miniature components. Fire protection equipment enables classification in flammability class V0 per UL 94 – even for extremely thin walls. PPA GF absorbs minute amounts of moisture from the atmosphere making it ideal for reflow soldering applications and for thin-walled, dimensionally stable components.

More data can be found in the table.

Polyamide (PA 46)

In comparison with PA 66, PA 46 has substantially higher dimensional stability under heat. The relative temperature index with impact load (RTIimp) is 115°C (239°F) for PA 4.6.

The permissible short-term temperature for the type used by WAGO is 280°C (536°F).

More data can be found in the table.

Polycarbonate (PC)

Polycarbonate has excellent dimensional stability under heat. The electrical and mechanical properties remain intact at extremely high temperatures up to approximately 120°C (248°F) per UL Yellow Card. Its excellent electrical insulating properties and dimensional stability are virtually independent of environmental conditions, such as humidity and temperature. Highly precise components can be created due to the low shrinkage of the material during injection molding. Polycarbonate has excellent weather resistance and is also highly resistant to high energy radiation. If the PC is not colored, then the components are glass-clear.

Thanks to its desirable properties (e.g., dimensional stability, heat resistance, non-flammability, durability and transparency), PC is a proven and widely used material in the electrical industry.

Depending on the demands placed on the finished product, WAGO uses polycarbonates that carry flammability classifications V2 and V0 per UL 94.

Medium-viscosity PC is used that features excellent chemical resistance.

Material Specifications

Contact Materials

Hard and extra-hard electrolytic copper (ECu), as well as extra-hard copper alloys are the standard materials used for the current-carrying parts of all WAGO products.

These materials combine excellent conductivity and good chemical resistance without the risk of stress-induced cracking.

Contact Materials

The special tin layer, which is the standard layer for all current-carrying parts in WAGO products, ensures perfect long-term protection against corrosive substances. Furthermore, these layers provide a gas-tight contact that ensures a durable transition resistance.

At the clamping unit, the conductor is embedded into the soft tin layer via high contact pressure. This protects the contact area against corrosion.

The thick tin layer also ensures good solderability of both PCB terminal block and connector solder pins.

Clamping Spring Material

Every WAGO clamping spring is made of high-quality, accurately tested austenitic chrome nickel steel (CrNi) with high tensile strength, which boasts proven corrosion resistance through long-term usage.

It is resistant to sea spray, city pollutants and industrial emissions (e.g., sulfur dioxide, hydrogen sulfide).

At room temperatures of approximately 20°C (68°F), the material is resistant to salt solutions up to 30% and dilute phosphoric acids up to 30%.

Even after decades of use, no galvanic corrosion between the chrome nickel spring steel (in connection with the contact materials used by WAGO) and the connected copper conductors has been detected.

The relaxation of the material as a function of time and surrounding temperatures up to 105°C (221°F) can be ignored. Samples loaded with 500 N/mm² at a temperature of 250°C (482°F) showed a relaxation of only 1.5%.

In certain product lines, the clamping springs are thermally treated at temperatures between 350°C (662°F) and 420°C (788°F) after production.

This treatment reduces internal stress due to the material's mechanical deformation, which may result in a slight brown discoloration of the spring surface.

WAGO only accepts deliveries of chrome nickel spring steel against certificates of conformity and after select material tests have been performed.

General Technical Information on Electrical Equipment Used in Hazardous Areas

The formation of an explosive atmosphere is required for the existence of a potentially explosive hazard. Such an atmosphere can be produced at any location where flammable gases or liquids are manufactured, processed, transported and/or stored.

Such hazardous areas can be found in a wide range of industries, including chemical plants, refineries, power plants, paint production facilities, painting shops, filling stations, vehicles, sewage treatment plants, airports, grain mills or harbor facilities.

THE FOLLOWING APPLIES AS A GUIDELINE FOR THE UNDERLYING PRINCIPLE FOR EXPLOSION PROTECTION:

General Requirements

The European EN 60079-0 Standard – VDE 0170-1 Classification – contains general requirements for the design and testing of electrical equipment to be used in hazardous areas.

This ensures this equipment does not cause an explosion in the surrounding atmosphere. EN 60079-0 is supplemented or revised by the European standards indicated on the right which refer to the specifically standardized types of protection.

Electrical Equipment

Electrical equipment includes all items used in whole or in part with electricity. This includes items for generation, transport, distribution, storage, measurement, control, conversion and consumption of electrical power, as well as telecommunications.

Ex Components

Ex components are elements of electrical equipment for hazardous areas that are marked with the "U" letter. These components must not be used on their own in such areas and require an additional certificate when used in such areas when installed in the electrical equipment.

Ignition Protection Categories

Only explosion-proof (protected) equipment must be used in areas in which an explosive atmosphere may still be expected despite the implementation of prevention measures. Explosion-protected electrical equipment can have various types of protection in accordance with the EN 60079 standard requirements.

Protection used by the manufacturer essentially depends on the type and function of the apparatus. From a safety point of view, all standardized types of protection should be viewed as equal.

The ignition protection category "n" exclusively describes the use of explosion-protected electrical components in Zone 2. This zone includes areas in which hazardous, potentially explosive atmospheres are likely to occur rarely or short-term. This represents a transition between Zone 1, in which explosion protection is required, and the safe area in which, for example, welding may be performed at any time.

Regulations covering these electrical components are being prepared worldwide. Organizations such as KEMA in the Netherlands, or PTB in Germany certify that the devices meet the requirements of the EN 60079-15 standard.

Ignition protection category "n" also requires that electrical equipment be provided with additional ID markings as follows:

- nA – non-sparking
- nC – enclosed-break, hermetically sealed, non-incendive, sealed
- nR – restricted-breathing

The table on the opposite page shows an overview of the standardized ignition protection categories and describes their basic principle, as well as typical applications.

General Technical Information on Electrical Equipment Used in Hazardous Areas Continued

Ignition Protection Categories			
Symbol	Standard	Explanation	Application Area
"o"	IEC 60079-6 EN 60079-6	Equipment protection by oil immersion: Electrical equipment or parts of such equipment are immersed in oil.	Zones 1 + 2
"p"	IEC 60079-2 EN 60079-2	Equipment protection by pressurized enclosure: The ingress of the external (explosive) atmosphere into the electrical equipment housing is prevented by maintaining a protective gas internally at a pressure above that of the external atmosphere.	Zones 1 + 2
"q"	IEC 60079-5 EN 60079-5	Equipment protection by sand filling: Filling the electrical equipment housing with fine grain sand prevents the ignition of a surrounding explosive atmosphere by an electric arc generated in the housing.	Zones 1 + 2
"d"	IEC 60079-1 EN 60079-1	Equipment protection by flameproof enclosures: The parts that could ignite an explosive atmosphere are encapsulated in a housing, which will withstand the explosion pressure within the housing.	Zones 1 + 2
"eb" "ec"	IEC 60079-7 EN 60079-7	Equipment protection by increased safety: Additional measures applied to achieve increased security against the possibility of excessive temperatures and the occurrence of arcs or sparks.	Zones 1 + 2
"i"	IEC 60079-11 EN 60079-11	Equipment protection by intrinsic safety: Power circuit in which no sparks or thermal effects can occur and cause the ignition of a certain explosive atmosphere.	Zones 1 + 2 following special testing Zone 0
"nA" "nC" "nR"	IEC 60079-15 EN 60079-15	Equipment protection by type of protection "n": Electrical equipment of group II for use in areas in which an explosive mixture of gas, vapor or mist is unlikely to occur during normal operation and, if it does, will be for a short period.	Zone 2:
"m"	IEC 60079-18 EN 60079-18	Equipment protection by cast encapsulation: Dangerous electrical equipment is embedded in a cast mass. This corresponds approximately to the known special Ex s protection type.	Zones 1 + 2
	IEC 60079-25 EN 60079-25	Intrinsically safe electrical systems "i": Assembly of interconnected electrical equipment in which the circuits intended for use, as a whole or in part, in hazardous environments are intrinsically safe. It is documented accordingly in the system description	Zones 1 + 2 following special testing Zone 0

Hazardous Areas

Hazardous areas are zones in which the atmosphere may become explosive. An explosive atmosphere is a mixture of flammable substances in the form of gases, vapors or mixtures with air under atmospheric conditions in critically mixed ratios such that excessive high temperature, arcs or sparks may cause an explosion.

EN 60079-10-1/EN 60079-10-2 and all other well-known standards rank hazardous areas according to the likelihood of the occurrence of an explosive atmosphere into the following zones:

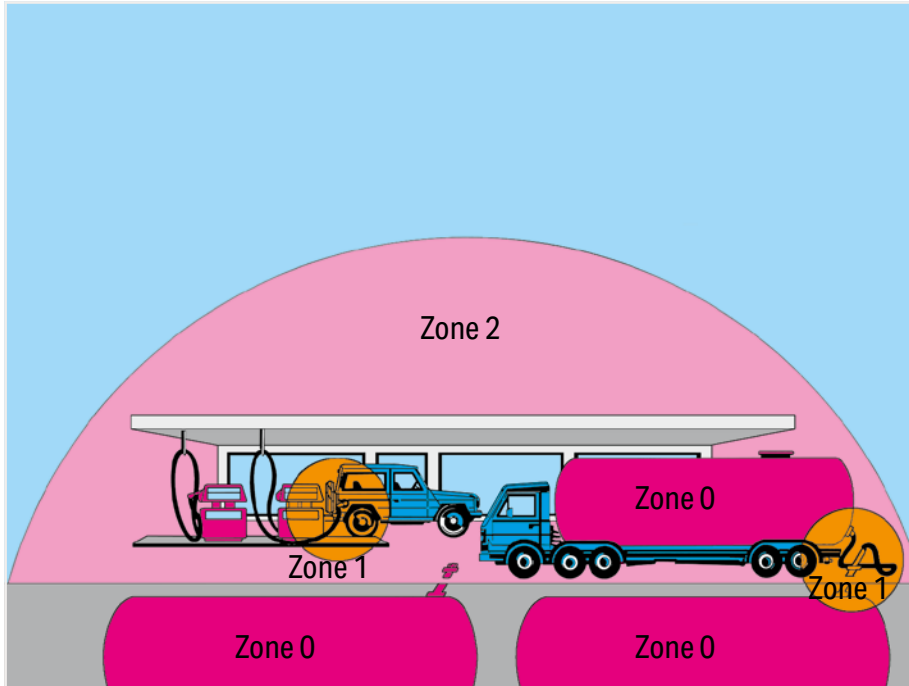

Hazardous areas due to explosive gases, vapors and mists:

Zone 0

Area in which an explosive gas atmosphere is present continuously, for long periods or frequently.

Zone 1

Area in which an explosive gas atmosphere is likely to occur periodically or occasionally during normal operation.

Zone 2:

Area in which an explosive gas atmosphere is unlikely to occur during normal operation; if it does occur, then it is temporarily.

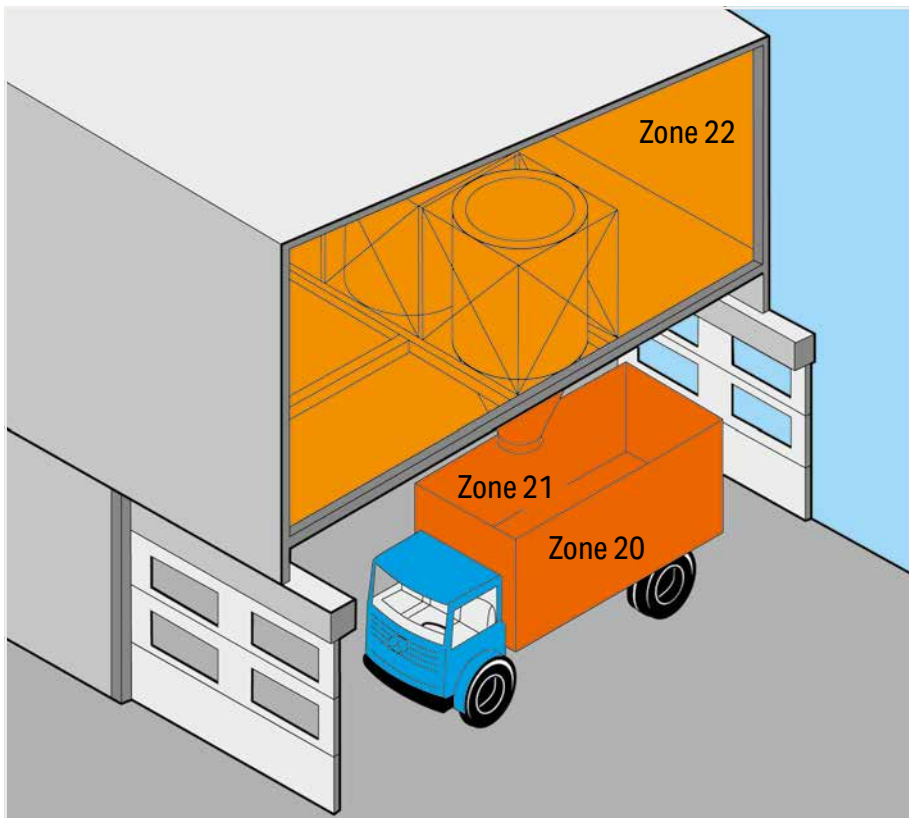

Hazardous areas due to explosive dust/air mixtures:

Zone 20

Area in which an explosive dust atmosphere due to dust/air mixtures is present continuously, for long periods or frequently.

Zone 21

Area in which an explosive dust atmosphere due to dust/air mixtures is likely to occur occasionally during normal operation.

Zone 22

Area in which an explosive dust atmosphere due to flammable dust/air mixtures is unlikely to occur during normal operation; but if it occurs, then only for a short period of time.

General Technical Information on Electrical Equipment Used in Hazardous Areas Continued

EN 60079-0 also classifies electrical equipment for use in hazardous areas into two groups:

Group I:

Electrical equipment for mines susceptible to firedamp

Group II:

Electrical equipment for hazardous areas, except for mines susceptible to firedamp.

As this broad application range encompasses a large number of potentially flammable gases, Group II is broken down into sub-groups IIA, IIB and IIC.

This breakdown is based on different gases/materials exhibiting differing ignition power levels as parameters. Therefore, representative gases have been allocated to these three sub-groups:

- IIA – Propane
- IIB – Ethylene
- IIC – Hydrogen

WAGO's terminal blocks can be used both in Group I and Group II.

This information is given under Item 12 in the EU Prototype Test Certificates, based on which the terminal blocks have been approved for Group I and Group II.

Temperature Class	Maximum Surface Temperature (°C)
T1	450
T2	300
T3	200
T4	135
T5	100
T6	85

Depending on the maximum surface temperature, electrical equipment in Group II are classified in temperature categories T1 to T6 for all protection types. The surrounding air temperature, which must be accounted for in dimensioning, is defined as 40°C/104°F (deviations are acceptable under some conditions).

Terminal blocks for "eb" (increased safety) protection type are generally assigned to temperature category T 6. When rail-mount terminal blocks are used in equipment of temperature categories T1 to T5, ensure that the highest temperature on the insulating parts does not exceed 85°C (185°F). The highest measured surface temperature rise must not exceed 40 K.

Thermal resistance of the insulation material must be at least 20°C (68°F) greater than the highest operating temperature. Low temperature stability is considered to be sufficient when the insulation material can withstand 24-hour storage at a temperature of -60°C (-76°F) without nullifying the type of protection.

Special Requirements "Increased Safety Ex e"

The European EN 60079-7 Standard – VDE 0170-6 Classification – contains special requirements for the design and testing of electrical equipment with "eb" (increased safety) protection type for use in hazardous areas.

This standard is a supplement to EN 60079-0 and applies to equipment or parts thereof that neither generate sparks or arcing under normal operating conditions, nor exhibit hazardous temperatures.

This standard describes special measures, which have to be observed to obtain a safety degree according to the "eb" (increased safety) protection type.

Ex components such as rail-mount terminal blocks are covered by Section 4.2 "Terminal Blocks for External Conductors":

- The terminal blocks must be installed in an enclosure meeting the requirements of a recognized protection type per EN 60079-0, Section 1 or EN 60079-31.
- When installing the terminal blocks in an enclosure of protection type "eb" (increased safety) per EN 60079-7, the clearances and creepage distances of Table 2 must be observed. When using accessories, the installation instructions of the manufacturer must be observed.
- The terminal blocks can be used both in Group II and Group I, as the standard requirements are identical in this case.
- The use of this component requires a new assessment by a notified certification agency.

Minimum Ignition Power of Typical Gases:

Explosion Group	I	IIA	IIB	IIC
Gas	Methane	Propane	Ethylene	Hydrogen
Ignition Power	280	250	82	16

The following are the most important design requirements for terminal blocks for external supply conductors to electrical equipment: These must:

- be sufficiently large to permit reliable connection of external supply conductors with cross section of at least the size required by the nominal current of the equipment
- be protected against self-loosening and designed such that the supply conductors cannot slip out of their clamping units
- be designed such that adequate contact pressure is ensured without damaging the conductors
- be designed such that their contact pres-

sure does not change with temperature cycling

- be equipped with a spring connecting link for the connection of stranded conductors
- be designed so as to allow secure connection of smaller conductors for terminal blocks up to 4 mm² (12 AWG).

Classification of insulation materials according to their tracking resistance is based on their Comparative Tracking Index (CTI) and is defined in Table 1 as follows:

This classification applies to insulating parts without ribs or grooves.

If the insulating parts have ribs or grooves sufficiently large to be considered, the minimum creepage distances must be set according to values for the insulation materials in the next-higher level (e.g., Group I, instead of Group II).

Accounting for the surrounding air temperature of 40°C (104°F) specified for electrical equipment, the current-carrying capacity of rubber-insulated conductors is reduced to 82%, based on DIN VDE 0298-4:2013-06, Table 12 and to 87% for PVC-insulated conductors for the current-carrying capacity defined for 30°C (86°F) in accordance with DIN VDE 0298-4:2013-06, Item 4.3.3.

Conductor Types and Conductor Preparation

In accordance with EN 60079-14/DIN VDE 0165-1, the ends of stranded and fine-stranded conductors must be protected against splaying (e.g., via cable lugs or ferrules) or by the type of terminal blocks used. Soldering alone is not sufficient.

According to EN 60069-7/DIN VDE 0170-6, connecting electrical equipment to terminal blocks having an "eb" (increased safety) protection type must not lead to a reduction of the clearances and creepage distances. Based on experience through the application of terminal blocks in aggressive atmospheres in the chemical industry, WAGO recommends gas-tight tinned copper ferrules or tinned copper pin terminals when connecting fine-stranded conductors to terminal blocks in

Table 1– Tracking Resistance for Insulation Materials

Material Group	Comparative Tracking Index
I	600 ≤ CTI
II	400 ≤ CTI < 600
III a	175 ≤ CTI < 400
III b	100 ≤ CTI < 175

corrosive atmospheres.

Table 2– Minimum Creepage Distances/Clearances and Isolations

Voltage (see ^a and ^b) RMS Value for AC or DC Voltage V	Minimum Creepage Distance mm								Minimum Clearance and Isolations mm		
	Material Group								Clearance mm	Distance under Coat- ing ^d	
	I		II		III a		III b				
	"eb"	"ec"	"eb"	"ec"	"eb"	"ec"	"eb"	"ec"	"eb"	"ec"	"ec"
≤ 10 (see ^c)	1.6	1	1.6	1	1.6	1	–	1	1.6	0.4	0.3
≤ 12.5	1.6	1.05	1.6	1.05	1.6	1.05	–	1.05	1.6	0.4	0.3
≤ 16	1.6	1.1	1.6	1.1	1.6	1.1	–	1.1	1.6	0.8	0.3
≤ 20	1.6	1.2	1.6	1.2	1.6	1.2	–	1.2	1.6	0.8	0.3
≤ 25	1.7	1.25	1.7	1.25	1.7	1.25	–	1.25	1.7	0.8	0.3
≤ 32	1.8	1.3	1.8	1.3	1.8	1.3	–	1.3	1.8	0.8	0.3
≤ 40	1.9	1.4	2.4	1.6	3	1.8	–	1.8	1.9	0.8	0.6
≤ 50	2.1	1.5	2.6	1.7	3.4	1.9	–	1.9	2.1	0.8	0.6
≤ 63	2.1	1.6	2.6	1.8	3.4	2	–	2	2.1	0.8	0.6
≤ 80	2.2	1.7	2.8	1.9	3.6	2.1	–	2.1	2.2	0.8	0.8
≤ 100	2.4	1.8	3	2	3.8	2.2	–	2.2	2.4	0.8	0.8
≤ 125	2.5	1.9	3.2	2.1	4	2.4	–	2.4	2.5	1	0.8
≤ 160	3.2	2	4	2.2	5	2.5	–	2.5	3.2	1.5	1.1
≤ 200	4	2.5	5	2.8	6.3	3.2	–	3.2	4	2	1.7
≤ 250	5	3.2	6.3	3.6	8	4	–	4	5	2.5	1.7
≤ 320	6.3	4	8	4.5	10	5	–	5	6	3	2.4
≤ 400	8	5	10	5.6	12.5	6.3	–	6.3	6	4	2.4
≤ 500	10	6.3	12.5	7.1	16	8	–	8	8	5	2.4
≤ 630	12	8	16	9	20	10	–	10	10	5.5	2.9
≤ 800	16	10	20	11	25	12.5	–	–	12	7	4
≤ 1000	20	11	25	11	32	13	–	–	14	8	5.8
≤ 1250	22	12	26	12	32	15	–	–	18	10	–
≤ 1600	23	13	27	13	32	17	–	–	20	12	–
≤ 2000	25	14	28	14	32	20	–	–	23	14	–
≤ 2500	32	18	36	18	40	25	–	–	29	18	–
≤ 3200	40	22	45	22	50	32	–	–	36	22	–
≤ 4000	50	28	56	28	63	40	–	–	44	28	–
≤ 5000	63	36	71	36	80	50	–	–	50	36	–
≤ 6300	80	45	90	45	100	63	–	–	60	45	–
≤ 8000	100	56	110	56	125	80	–	–	80	56	–
≤ 10000	125	71	140	71	160	100	–	–	100	70	–
≤ 12500	–	90	–	90	–	125	–	–	–	89	–
≤ 13640	–	98	–	98	–	138	–	–	–	97	–

^{a)} When determining the required values for creepage distances and clearances, the working voltage may be 1.1 times higher than the value in the table.

NOTE: The factor of 1.1 takes into account that in many places in a circuit the working voltage is equal to the rated voltage and that a number of rated voltages are used, which are covered by a factor of 1.1.

^{b)} The specified values for creepage distances and clearances already take into account a 10% tolerance for the highest supply voltage. Therefore, further considerations on the voltage fluctuations are unnecessary for determining which voltage value from the table should be used.

^{c)} CTI values are not applicable for voltages of 10 V or less. Materials that do not meet the requirements of material group III a can be used.

^{d)} The specified distances under consideration apply to printed circuit boards in protection level "ec" after 4.5.

It is expressly prohibited to use insulating parts for transferring contact forces. Terminal blocks with sharp edges which could damage supply lines and those types that can be rotated, turned or permanently deformed when fixed in place are not permitted for use. Terminal blocks for internal connections in electrical equipment must not be subjected to excessive mechanical stress. These items must fulfill the requirements for terminal blocks used for external supply conductors.

Clearances between conductive parts having different potentials must be at least 3 mm for external connections, as specified in Table 2. The value of the creepage distances depends on the working voltage, surface geometry of the insulating parts and tracking resistance of the insulation material. Grooves on the surface may only be considered if they are at least 2.5 mm deep and wide; ribs on the surface only if their height is at least 2.5 mm and their width corresponds to the mechanical strength of the material, however not smaller than 1 mm.

General Technical Information on Electrical Equipment Used in Hazardous Areas Continued

Approvals

Terminal blocks may be used in Zones 1 and 2, provided that the terminal blocks are accommodated in an enclosure that has a minimum IP54 protection and an Ex e certification.

Terminal blocks are considered to be Ex components because they are a part of the equipment. Part certificates provided by Ex Certification Agencies serve as a basis for issuing the complete conformity declaration for the unit.

An EC-type examination certificate is issued in accordance with the 2014/34/EU ATEX Directive.

In addition, an IEXEx Certificate may also be obtained from an appropriate, recognized certification agency in accordance with the IECEx Certification Agreement that is accepted throughout Europe and also in countries such as Canada, China and Australia.

These certificates can also be viewed at: www.iecex.com.

Terminal block marking per 2014/34/EU ATEX Directive:

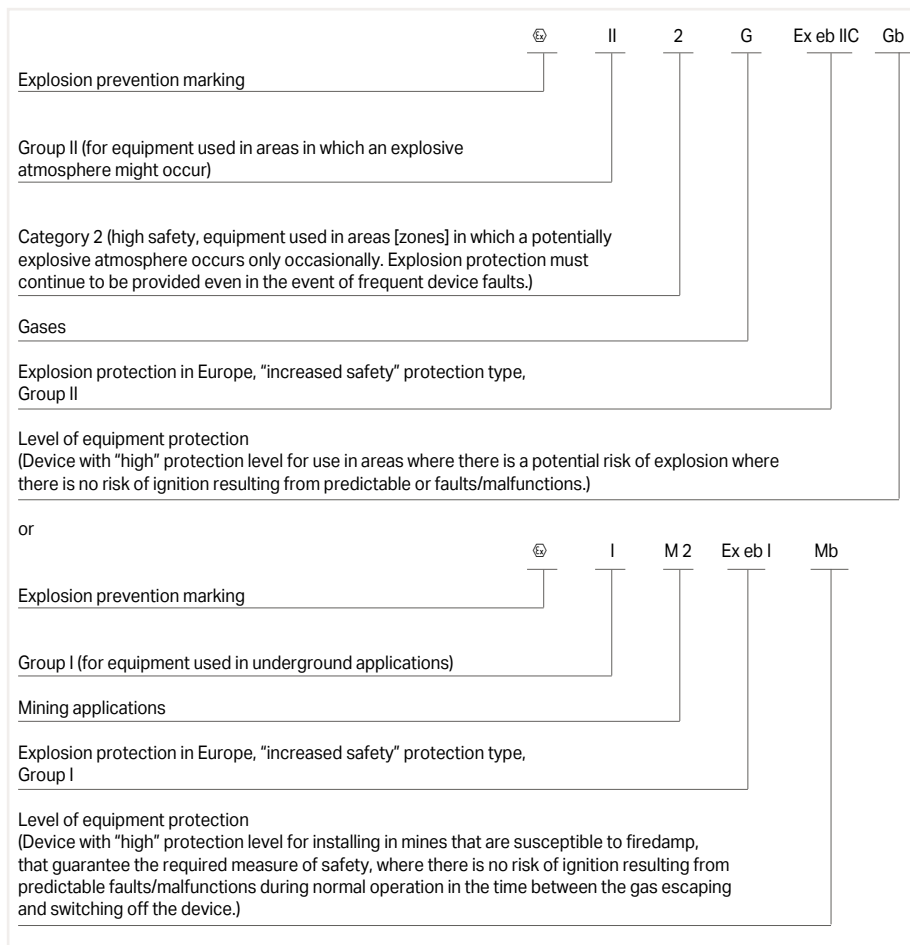

Example of marking (rear):

Series

Manufacturer's name

Nominal isolation voltage

Protection type

Part certification no.

Nominal cross section

(solid, stranded or fine-stranded conductors)

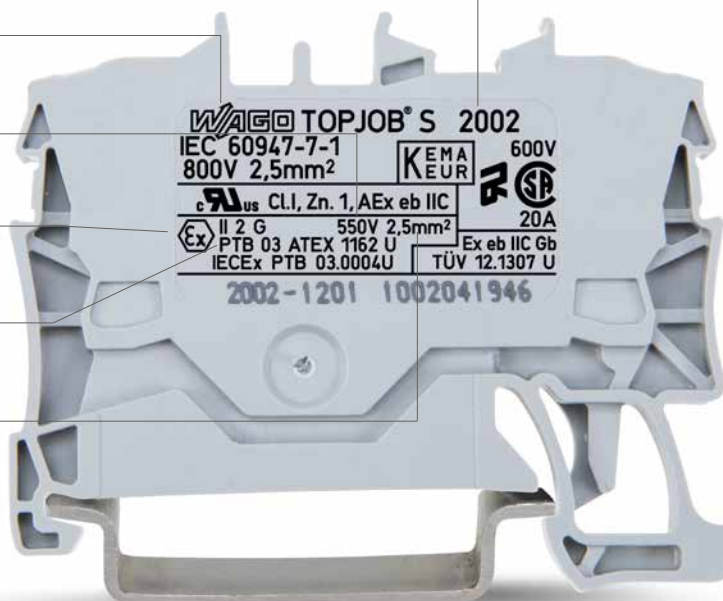

The embossed details on the terminal blocks show the manufacturer's name, the series number, the approval number, the approval data and the name of the testing authority. The type of protection Ex eb IIC Gb shown on the label or on the smallest packaging unit.

Terminal blocks for Class I, Zone 1, Ex eb IIC hazardous locations can be approved for Ex applications per UL 60079-7 standard. As a result of international harmonization efforts, the UL certificate can be issued on the basis of EN 60079-0 or EN 60079-7 standards, provided that the terminal blocks have also been approved per UL 1059 (ordinary location).

If desired by the applicant, terminal blocks can simultaneously be approved in accordance with the Canadian Standards CAN/CSA-C22.2 No. 60079-0 and CAN/CSA C22.2 No. 60079-7 and released for use in Canada. The terminal blocks are marked with **UL** Cl. I, Zn. 1, AEx eb IIC.

EU-type examination certificates have been granted to all WAGO terminal blocks listed in this catalog. WAGO terminal blocks approved for use in Ex eb IIC areas are manufactured of flame-resistant, self-extinguishing Polyamide 66. The same applies to the terminal blocks used in non-hazardous areas. Tracking resistance with a CTI value of 600 as per IEC 60112 and a constant operating temperature of 105°C (22°F) in accordance with IEC 60216-1 and -2 are provided. Factory part quality tests are performed on all CAGE CLAMP® rail-mount terminal blocks with Ex eb IIC approval to monitor and ensure the quality features described above.



IECEX Certificate of Conformity

INTERNATIONAL ELECTROTECHNICAL COMMISSION
IEC Certification Scheme for Explosive Atmospheres
for rules and details of the IECEx Scheme visit www.iecex.com
Ex COMPONENT CERTIFICATE

Certificate No.:	IECEX PTB 18.0012U	Issue No. 0	<u>Certificate history:</u> Issue No. 0 (2018-08-30)
Status:	Current	Page 1 of 3	
Date of Issue:	2018-08-30		
Applicant:	WAGO Kontakttechnik GmbH & Co. KG Hansastraße 27 32423 Minden Germany		
Ex Component:	WAGO type PE & Through terminal blocks type TOPJOB S 2202-**** and TOPJOB S 2202-****		

This component is NOT intended to be used alone and requires additional consideration when incorporated into other equipment or systems for use in explosive atmospheres (refer to IEC 60079-0).

Type of Protection: **Increased Safety "eb"**
Marking: Ex eb IIC Gb and Ex eb I Mb

Approved for issue on behalf of the IECEx Certification Body:

Position:

Signature: *(for printed version)*

Date:

Dipl.-Phys. U. Völkkel

Department "Explosion Protection in Energy Technology"



31.8.18

1. This certificate and schedule may only be reproduced in full.
2. This certificate is not transferable and remains the property of the issuing body.
3. The Status and authenticity of this certificate may be verified by visiting the [Official IECEx Website](http://www.iecex.com).

Certificate issued by:

Physikalisch-Technische Bundesanstalt (PTB)
Bundesallee 100
38116 Braunschweig
Germany



Physikalisch-Technische Bundesanstalt
Braunschweig und Berlin





EU-Baumusterprüfbescheinigung

- (1) Komponente zur bestimmungsgemäßen Verwendung in explosionsgefährdeten Bereichen
Richtlinie 2014/34/EU
- (2) EU-Baumusterprüfbescheinigungsnummer
PTB 18 ATEX 1005 U **Ausgabe: 0**
- (3) Produkt: Durchgangsreihenklammern Typ TOPJOB S 2202-****
Schutzleiterreihenklammern Typ TOPJOB S 2202-****
- (4) Hersteller: WAGO Kontakttechnik GmbH & Co. KG
- (5) Anschrift: Hansastraße 27, 32423 Minden, Deutschland
- (6) Die Bauart dieses Produkts sowie die verschiedenen zulässigen Ausführungen sind in der Anlage und den darin aufgeführten Unterlagen zu dieser Baumusterprüfbescheinigung festgelegt.
- (7) Die Physikalisch-Technische Bundesanstalt, notifizierte Stelle Nr. 0102 gemäß Artikel 17 der Richtlinie 2014/34/EU des Europäischen Parlaments und des Rates vom 26. Februar 2014, bescheinigt, dass dieses Produkt die grundlegenden Sicherheits- und Gesundheitsanforderungen für die Konzeption und den Bau von Produkten zur bestimmungsgemäßen Verwendung in explosionsgefährdeten Bereichen gemäß Anhang II der Richtlinie erfüllt.
- (8) Die Ergebnisse der Prüfung sind in dem vertraulichen Prüfbericht PTB Ex 18-17171 festgehalten.
- (9) Die grundlegenden Sicherheits- und Gesundheitsanforderungen werden erfüllt durch Übereinstimmung mit **IEC 60079-0:2017, EN 60079-7:2015**
- (10) Das Zeichen "U" hinter der Zertifikatsnummer gibt an, dass dieses Zertifikat nicht mit einem für ein Gerät oder Schutzsystem vorgesehenen Zertifikat verwechselt werden darf. Diese Komponenten-Bescheinigung darf als Basis für die Bescheinigung eines Gerätes oder Schutzsystems verwendet werden.
- (11) Diese EU-Baumusterprüfbescheinigung bezieht sich nur auf Konzeption und Prüfung des festgelegten Produkts gemäß Richtlinie 2014/34/EU. Weitere Anforderungen dieser Richtlinie gelten für die Herstellung und das Bereitstellen auf dem Markt. Diese Anforderungen werden nicht durch diese Bescheinigung abgedeckt.
- (12) Die Kennzeichnung des Produkts muss die folgenden Angaben enthalten:



II 2 G Ex eb IIC Gb bzw. I M 2 Ex eb I Mb

Konformitätsbewertungsstelle, Sektor Explosionsschutz Braunschweig, 30. August 2018
Im Auftrag



Dipl.-Phys. U. Völkkel

Physikalisch-Technische Bundesanstalt (PTB)
Bundesallee 100
38116 Braunschweig
Germany



Physikalisch-Technische Bundesanstalt
Braunschweig und Berlin

EU-Baumusterprüfbescheinigungen ohne Unterschrift und ohne Siegel haben keine Gültigkeit.
Diese EU-Baumusterprüfbescheinigung darf nur unverändert weiterverbreitet werden.
Auszüge oder Änderungen bedürfen der Genehmigung der Physikalisch-Technischen Bundesanstalt.
Physikalisch-Technische Bundesanstalt • Bundesallee 100 • 38116 Braunschweig • DEUTSCHLAND

General Technical Information on Electrical Equipment Used in Hazardous Areas

Continued

Special Requirements

Equipment Protection by Intrinsic Safety "i"

The European EN 60079-11 Standard – Classification VDE 0170-7 – contains special requirements for the design and testing of electrical equipment with "i" (intrinsic safety) protection type for use in hazardous areas.

A circuit is "intrinsically safe" when, under normal operating conditions and in the event of specific fault conditions, no sparks or thermal effects can occur and cause the ignition of a certain explosive atmosphere.

A distinction is made here between:

- intrinsically safe electrical equipment when all circuits are intrinsically safe
- associated electrical equipment including both intrinsically and non-intrinsically safe circuits, and being designed such that the non-intrinsically safe circuits cannot affect the intrinsically safe ones.

Intrinsically safe electrical equipment and intrinsically safe parts of associated electrical equipment are classified at "ia", "ib" or "ic" protection level.

Electrical equipment classified Ex "ia" must not ignite when current is applied in the following cases:

- During fault-free operation, with those non-discreet faults present that result in the most adverse condition
- During fault-free operation and with a discreet fault, plus those non-discreet faults that result in unfavorable conditions
- During fault-free operation with two discreet faults, plus those non-discreet faults that result in the most adverse conditions.

Electrical equipment classified Ex "ib" must not ignite when current is applied in the following cases:

- During fault-free operation, with those non-discreet faults present that result in the most adverse condition
- During fault-free operation and with a discreet fault, plus those non-discreet faults that result in unfavorable conditions.

At applied voltages, the intrinsically safe circuits in electrical equipment of protection level "ic" shall not be capable of causing ignition during undisturbed operation and under the conditions specified in this standard.

No special approval is required for terminal blocks used as simple electrical equipment for "Ex i" protection type, as they do not contain a voltage source and precise information is available concerning electrical data and temperature rise performance.

The terminal blocks must be identifiable, for example by their type designation, and the following design requirements must also be upheld:

Clearances and creepage distances between bare conductive parts of terminal blocks of separate intrinsically safe circuits and grounded or floating conductive parts shall be equal to or greater than the values given in Table 5 (see 672). If separate intrinsically safe circuits are to be considered, the air gap between bare conductive parts of the outer connection parts must meet the following requirements:

- at least 6 mm between the separate intrinsically safe circuits
- at least 3 mm from grounded parts, if a possible connection to ground has not been considered in the safety analysis. Each possible motion of metallic parts that are not rigidly secured must be considered.

Terminal block marking must be unique and clearly visible. If a color is used for this, the color must be light blue (similar to RAL 5015).

Note also when using terminal blocks:

Terminal blocks used for intrinsically safe circuits must be isolated from those used in non-intrinsically safe circuits. This is accomplished by several accepted methods. First, intrinsically safe circuits are separated by at least 50 mm of air space from non-intrinsically safe circuits.

Second, intrinsically safe circuits are housed in a separate enclosure. Third, intrinsically safe terminal blocks are separated from non-intrinsically safe terminal blocks by either an insulated partition or grounded metal partition. The partition size must allow for either 1.5 mm or less distance from the sides of the housing or provide at least 50 mm of creepage distance between the intrinsically and non-intrinsically safe circuits in all directions.

The insulation between an intrinsically safe and a non-intrinsically safe circuit has to withstand an effective AC voltage of $2 \times \text{nominal value (U)}$ 1000 V or a minimum of 1500 kV, whereby U represents the total of the effective voltages of the intrinsically safe and the non-intrinsically safe circuit.

Short circuit between different intrinsically safe circuits could cause dangerous conditions. The insulation between these circuits should withstand an effective voltage of at least 500 VAC or 2 UAC where U is the total of the effective voltages of the related circuits.

In accordance with EN 60079-14/ DIN VDE 0165-1, in intrinsically safe circuits, the ends of stranded and fine-stranded conductors must be protected against splaying (e.g., via cable lugs or ferrules) or by the type of terminal blocks used. Soldering alone is not sufficient.

WAGO recommends gas-tight tinned copper ferrules or tinned copper pin terminals when connecting fine-stranded conductors to terminal blocks in corrosive atmospheres.

Requirements pertaining to the necessary distances as appropriate for use of the terminal blocks in the area DIN EN 60079-11 (VDE 0170-7) "Explosive atmosphere – Part 11: Device protection by intrinsically safe features "i" (IEC 60079-11)" are defined under Section 6.2 "Connecting point for external circuits," Section 6.2.1 "Terminal blocks." In general, the following can be stated for terminal blocks based on figure 1: "Example of isolated intrinsically safe terminal blocks with partition" in conjunction with figure 2: "Example of isolation of conductive parts," considering Table 5 – "Clearances, Creepage and Isolation Distances."

Outside:

a) Isolated intrinsically safe circuits: at least 6 mm

All PCB terminal blocks listed on the ordering pages as suitable for Ex "i" applications fulfill these requirements.

b) Intrinsically safe circuits and normal circuits (non-intrinsically safe): ≥ 50 mm

Inside:

a) Ex "i" to Ex "i"

b) Ex "i" to normal circuits

c) Ex "i" to ground

Based on Figure 2 and Table 5 (see next page) in accordance with the selected protection level and the special requirements for isolation distances as described in Sections 6.3.1 to 6.3.13, or in accordance with the alternative procedure for dimensioning of isolation distances given in Annex F.

Terminal blocks with smaller pin spacing may also be used for internal connections, provided they meet the requirements laid out in Table 5 (see below).

The exact clearances and creepage distances as well as separation distances based on Table 5 must be derived from the application items cited above.

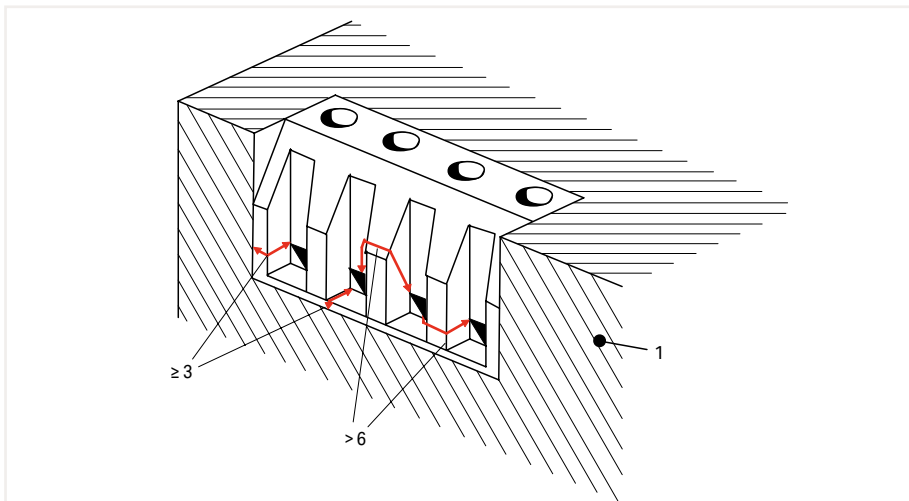
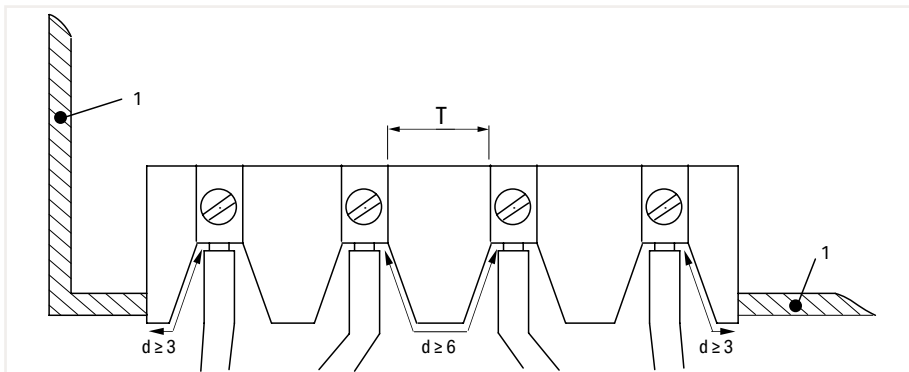

Legend:

- 1 Conductive cover
- T Distances based on Table 5
- d Distance at outer connecting parts of the terminal blocks according to 6.2.1

Note:

The dimensions indicated here represent the clearances and creepage distances around the insulation and not the thickness of the insulation.

Dimensions in mm

Figure 1a: Requirements for clearances and creepage distances for terminal blocks with isolated, intrinsically safe circuits

General Technical Information on Electrical Equipment Used in Hazardous Areas Continued

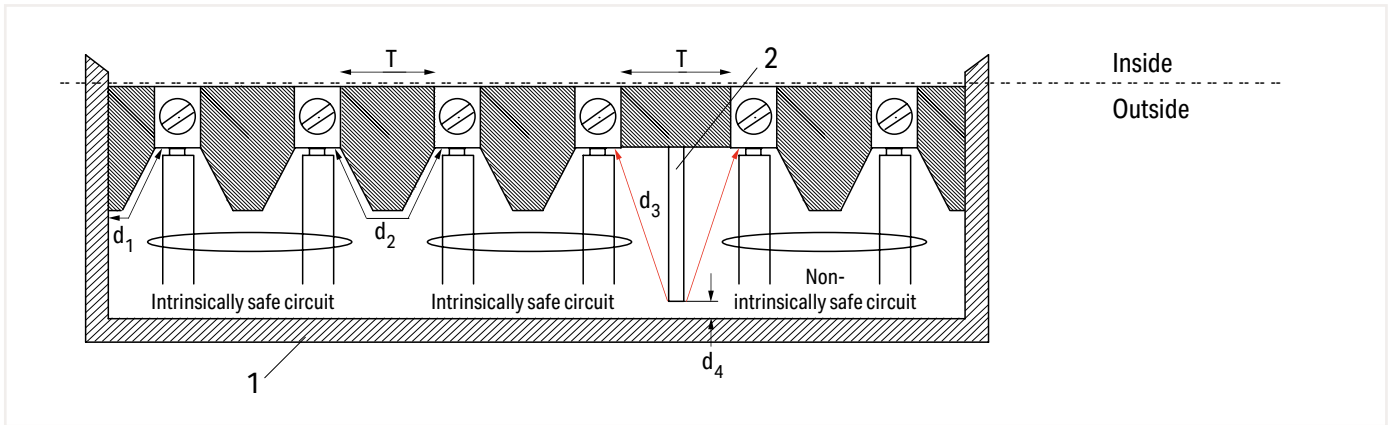

Figure 1b: Example of isolated intrinsically safe and non-intrinsically safe terminal blocks by a partition

Legend:

- 1 Cover: non-conductive or conductive and grounded
- 2 Partition based on 6.2.1 b); in this example, the partition must end at the base
- T Distances based on Table 5
- d1 ≥ 3 mm, when the cover is conductive and grounded
- d2 ≥ 6 mm
- d3 ≥ 50 mm or d4 ≤ 1.5 mm

Note:

The dimensions indicated here represent the clearances around the insulation and not the thickness of the insulation.

1 Voltage (Peak) (V)	2 Clearance (in mm)		3 Separation by Encapsulation (in mm)		4 Separation by Fixed Insulation (in mm)		5 Creepage Distance through Air (in mm)		6 Creepage Distance beneath Protective Layer (in mm)		7 Comparative Tracking Index (CTI)	
	ia, ib	ic	ia, ib	ic	ia, ib	ic	ia, ib	ic	ia, ib	ic	ia	ib, ic
10	1.5	0.4	0.5	0.2	0.5	0.2	1.5	1.0	0.5	0.3	--	
30	2.0	0.8	0.7	0.2	0.5	0.2	2.0	1.3	0.7	0.3	100	100
60	3.0	0.8	1.0	0.3	0.5	0.3	3.0	1.9	1.0	0.6	100	100
90	4.0	0.8	1.3	0.3	0.7	0.3	4.0	2.1	1.3	0.6	100	100
190	5.0	1.5	1.7	0.6	0.8	0.6	8.0	2.5	2.6	1.1	175	175
375	6.0	2.5	2.0	0.6	1.0	0.6	10.0	4.0	3.3	1.7	175	175
550	7.0	4.0	2.4	0.8	1.2	0.8	15.0	6.3	5.0	2.4	275	175
750	8.0	5.0	2.7	0.9	1.4	0.9	18.0	10.0	6.0	2.9	275	175
1000	10.0	7.0	3.3	1.1	1.7	1.1	25.0	12.5	8.3	4.0	275	175
1300	14.0	8.0	4.6	1.7	2.3	1.7	36.0	13.0	12.0	5.8	275	175
1575	16.0	10.0	5.3	*	2.7	*	49.0	15.0	16.3	*	275	175
3.3k	*	18.0	9.0	*	4.5	*	*	32.0	*	*	*	*
4.7k	*	22.0	12.0	*	6.0	*	*	50.0	*	*	*	*
9.5k	*	45.0	20.0	*	10.0	*	*	100.0	*	*	*	*
15.6k	*	70.0	33.0	*	16.5	*	*	150.0	*	*	*	*

Note 1: *At present, no values have been recommended for these voltages.

Note 2: Proof of fulfillment of the CTI requirements for the insulating materials must be provided by the manufacturer. Defining a CTI is not required for insulation materials for voltage levels up to 10 V.

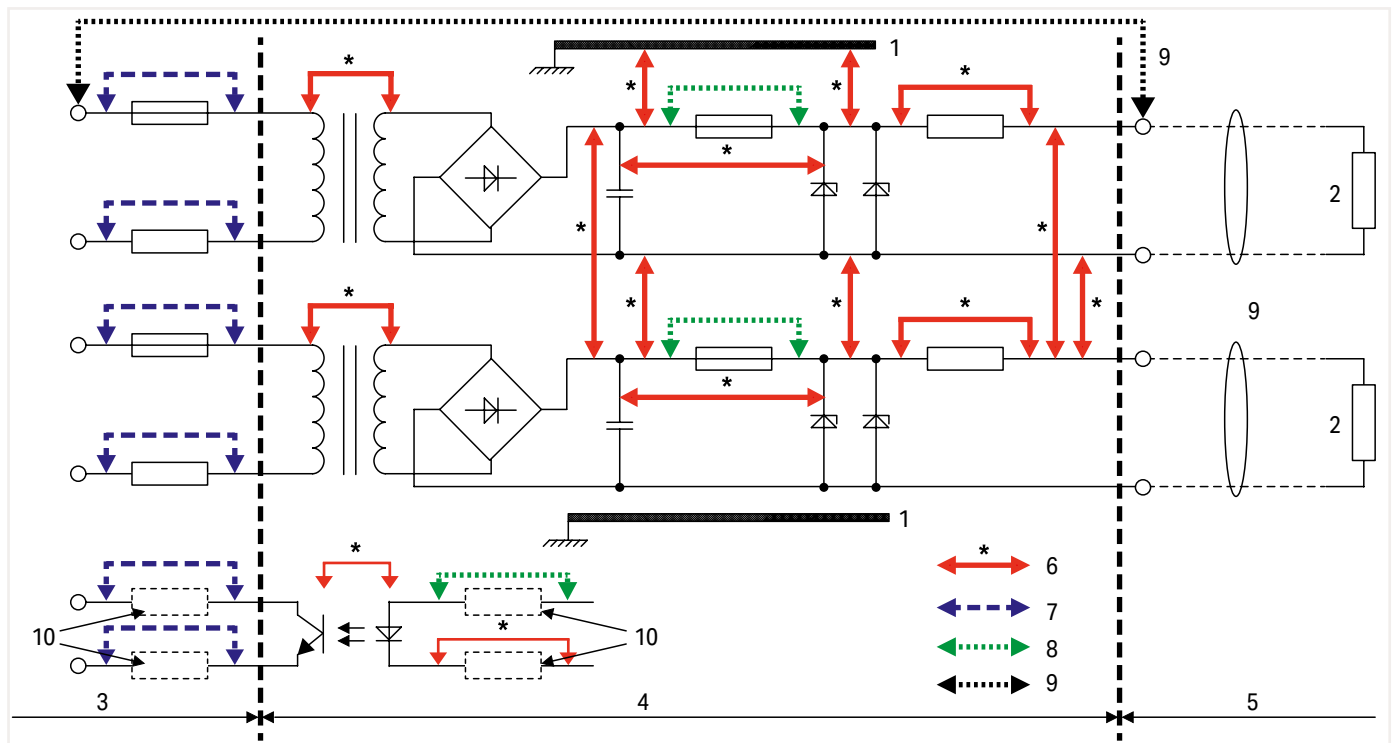

Figure 2: Isolation examples for conductive parts

Legend:

























- 1 Chassis
- 2 Load
- 3 Non-intrinsically safe circuit defined by U_m
- 4 Portion of intrinsically safe circuit, item is not intrinsically safe
- 5 Intrinsically safe circuit
- 6 Dimensions for which Table 5 applies
- 7 Dimensions for which general industrial standards apply
- 8 Dimensions per 7.3
- 9 Dimensions based on 6.2.1 for output terminal blocks between isolated intrinsically safe circuits ($d_2 \geq 6 \text{ mm}$) and between intrinsically safe circuits and non-intrinsically safe circuits ($d_3 \geq 50 \text{ mm}$)
- 10 Where required











In accordance with DIN EN 60079-14 (VDE 0165-1), in intrinsically safe circuits, the ends of stranded and fine-stranded conductors must be protected against splaying (e.g., via cable lugs or ferrules) or by the type of terminal blocks used. Soldering alone is not sufficient.

The conductor entry funnels of WAGO PCB terminal blocks fulfill this requirement.

WAGO recommends gas-tight tinned copper ferrules or tinned copper pin terminals when connecting fine-stranded conductors to terminal blocks in corrosive atmospheres.

International Certification Organizations – Overview

		Abbreviation			Abbreviation
	Underwriters Laboratories USA http://www.ul.com	UL		Danmarks Elektriske Materielkontrol Denmark http://www.demko.dk	DEMKO
	Underwriters Laboratories USA http://www.ul.com	UL		CENELEC CERTIFICATION AGREEMENT Danmarks Elektriske Materielkontrol Denmark http://www.cenelec.org	CCA Zul.-Nr. mit NL
	Underwriters Laboratories USA http://www.ul.com	cURus			
	Underwriters Laboratories USA http://www.ul.com	cULus		SETI – FEMKO Sähkötarastuskeskus Elinspektioncentralen Finland http://www.seti.fi	
	Canadian Standards Association Canada http://www.csa.ca	CSA		Sähkötarastuskeskus Elinspektioncentralen Finland http://www.fimko.com	FIMKO
	VDE-Gutachten mit Fertigungsüberwachung Germany http://www.vde.de/vde/html/e/home.htm	VDE		South African Bureau of Standards South Africa http://www.sabs.co.za	SABS
	VDE – Deutscher Verband für Elektrotechnik Germany http://www.vde.de			RosTeST Russia http://www.rostest.ru	ROTEST
VDE	VDE – Prüfbericht Germany			Departamentul Moldovastandard Moldova http://www.moldova.md/ro/government/oil/D_STAND/en/strcent2.htm	CSM
	Österreichischer Verband für Elektrotechnik Austria http://www.ove.at	ÖVE		Certificate of Registration Great Britain http://www.astacertification.com	ASTA
	Schweizerischer Elektrotechnischer Verein Switzerland http://www.sev.ch/	SEV		Rheinisch-Westfälischer Technischer Überwachungsverein e.V. Germany http://www.rwtuv.de	RWTÜV
	N.V. tot Keuring van Elektrotechnische Materialen Netherlands http://www.kema.nl	KEMA		Elektrotechnický výskumný a projektový ústav Czech Republic http://www.ezu.cz	EZU
CCA	CENELEC CERTIFICATION AGREEMENT N.V. tot Keuring van Elektrotechnische Materialen Netherlands http://www.cenelec.org	CCA Zul.-Nr. mit NL		Stowarzyszenie Elektryków Polskich Poland http://www.sep.com.pl	BBJ
	Norges Elektriske Materialkontroll Norway http://express.nemko.com	NEMKO		Stowarzyszenie Elektryków Polskich Poland http://www.bbj.pl	SEP
	Svenska Elektriska Materielkontrollanstalten AB Sweden http://www.semko.com	SEMKO			

		Abbreviation			Abbreviation
CNET	Centre National d'Etudes des Télécommunications France http://www.lannion.cnet.fr	CNET		Robbanásbiztos Villamos Berendezések Hungary http://www.bki.hu	BKI
LCIE	Laboratoire Central des Industries Electriques France http://www.lcie.fr	LCIE	CB	CB – TEST CERTIFICATE India http://www.ul-europe.com	CB
	Fyzikálne Technické úzkusební Ústav, Ostrava-Radvanice Czech Republic http://www.ftzu.cz	FTZU	CB	CB – TEST CERTIFICATE China http://www.ul-europe.com	CB
				http://www.enec.com	ENEC
Marine Approvals			EX Approvals		
BV	Bureau Veritas France http://www.bureauveritas.fr	BV		Physikalisch Technische Bundesanstalt Germany http://www.ptb.de	PTB
	Lloyd's Register of Shipping Great Britain http://www.lloydsregister.com	LR		Underwriters Laboratories USA http://www.ul.com	AEx
	NV – Det Norske Veritas Norway http://www.dnvgl.com	DNV-GL			
	Russian Maritime Register of Shipping GUS http://www.rs-head.spb.ru	RMR			
	Polski Rejestr Statków Poland http://www.prs.pl	PRS			
	Korean Register of Shipping Korea http://www.krs.co.kr	KR			
ABS	American Bureau of Shipping USA http://www.eagle.org	ABS			

Electrical Engineering Laboratory Product Safety for Our Customers

To use terminal blocks globally, they must satisfy certain standards and obtain test certificates. These requirements apply to every manufacturer. WAGO also conducts its own tests to increase standards and offer greater reliability with its products. Products undergo a full range of mechanical, electrical and climatic testing, and we'll share a few of those processes with you.

Pull-Out Test (per EN 60947-7-1, EN 60998-2-2)

During the pull-out force test, a conductor is pulled on until it is removed from the clamping unit. The design of the terminals means that extraction only occurs after the standard pull-out force has been exceeded many times over.

WAGO Test Lab

This means that WAGO's products can be used safely and reliably both in Europe and anywhere globally for a wide variety of applications. We heavily emphasize the importance of global acceptance during development. As a result, we can present documentation that verifies our high levels of product safety and reliability while ensuring the fulfillment and accuracy of technical data, which are the highest priorities for our customers and users worldwide. On December 22, 2009, our test lab was accredited by the German Accreditation Association (Deutsche Gesellschaft für Akkreditierung GmbH) in accordance with DIN EN ISO/IEC 17025.



Vibration Test (per IEC/EN 60068-2-6)

Depending on the application, such as railway (per EN 61373) or marine (per GL, LR, DNV), there are various testing requirements to determine if the long-term effects of vibrations degrade electrical connections. The test specimen is subjected to different loads on three axes in an electrodynamic vibration system. The amplitude, the acceleration, and particularly the frequency of the vibration vary during the test. The test values are increased many times over the standard values to meet special customer requirements.

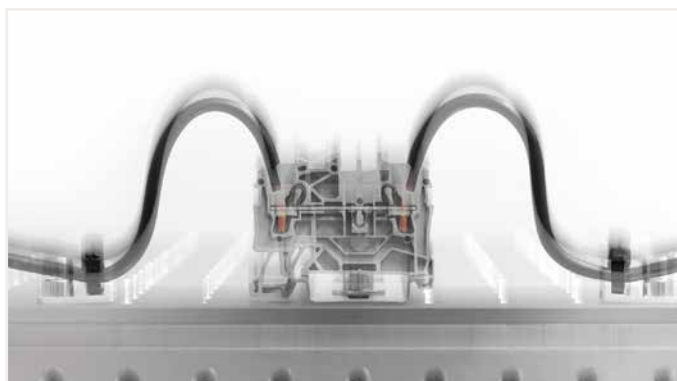

Shock Test (per IEC/EN 60068-2-27)

The shock test is very similar to the vibration test except that, instead of continuous vibrations, single shocks are applied to the test specimen. Shock tests are usually performed, for example, at an acceleration of 20g over a period of 11 ms. Tests for special requirements often call for much higher values and are also conducted in our laboratory. Single-deck TOPJOB® S Rail-Mount Terminal Blocks, for example, pass shock tests up to 500g.



Voltage Drop Test under Bending Stress (per EN 60947-7-1, EN 60999-1)

The voltage drop test under bending stress simulates mechanical stress on the clamping unit. In everyday use, this stress can occur during installation, for example, when an electrician shoves connected conductors to the side in order to access a specific component. The quality of the clamping unit when moving a connected conductor can be validated by the constantly stable measured value of the voltage drop.





Deutsche Akkreditierungsstelle GmbH

Beliehene gemäß § 8 Absatz 1 AkkStelleG i.V.m. § 1 Absatz 1 AkkStelleGBV
Unterzeichnerin der Multilateralen Abkommen
von EA, ILAC und IAF zur gegenseitigen Anerkennung

Akkreditierung



Die Deutsche Akkreditierungsstelle GmbH bestätigt hiermit, dass das Prüflaboratorium

WAGO Kontakttechnik GmbH & Co. KG
Hansastraße 27, 32423 Minden

die Kompetenz nach DIN EN ISO/IEC 17025:2005 besitzt, Prüfungen in folgenden Bereichen durchzuführen:

**Elektrische und mechanische Prüfungen an Klemmen und Steckverbinder
sowie Umweltsimulation**

Die Akkreditierungsurkunde gilt nur in Verbindung mit dem Bescheid vom 18.12.2014 mit der Akkreditierungsnummer D-PL-19704-01 und ist gültig bis 17.12.2019. Sie besteht aus diesem Deckblatt, der Rückseite des Deckblatts und der folgenden Anlage mit insgesamt 5 Seiten.

Registrierungsnummer der Urkunde: **D-PL-19704-01-00**

Frankfurt am Main, 18.12.2014

Im Auftrag Dipl.-Ing. (FH) Ralf Egner
Abteilungsleiter

Siehe Hinweise auf der Rückseite

WAGO-Seminars

Learn Today – Benefit Tomorrow

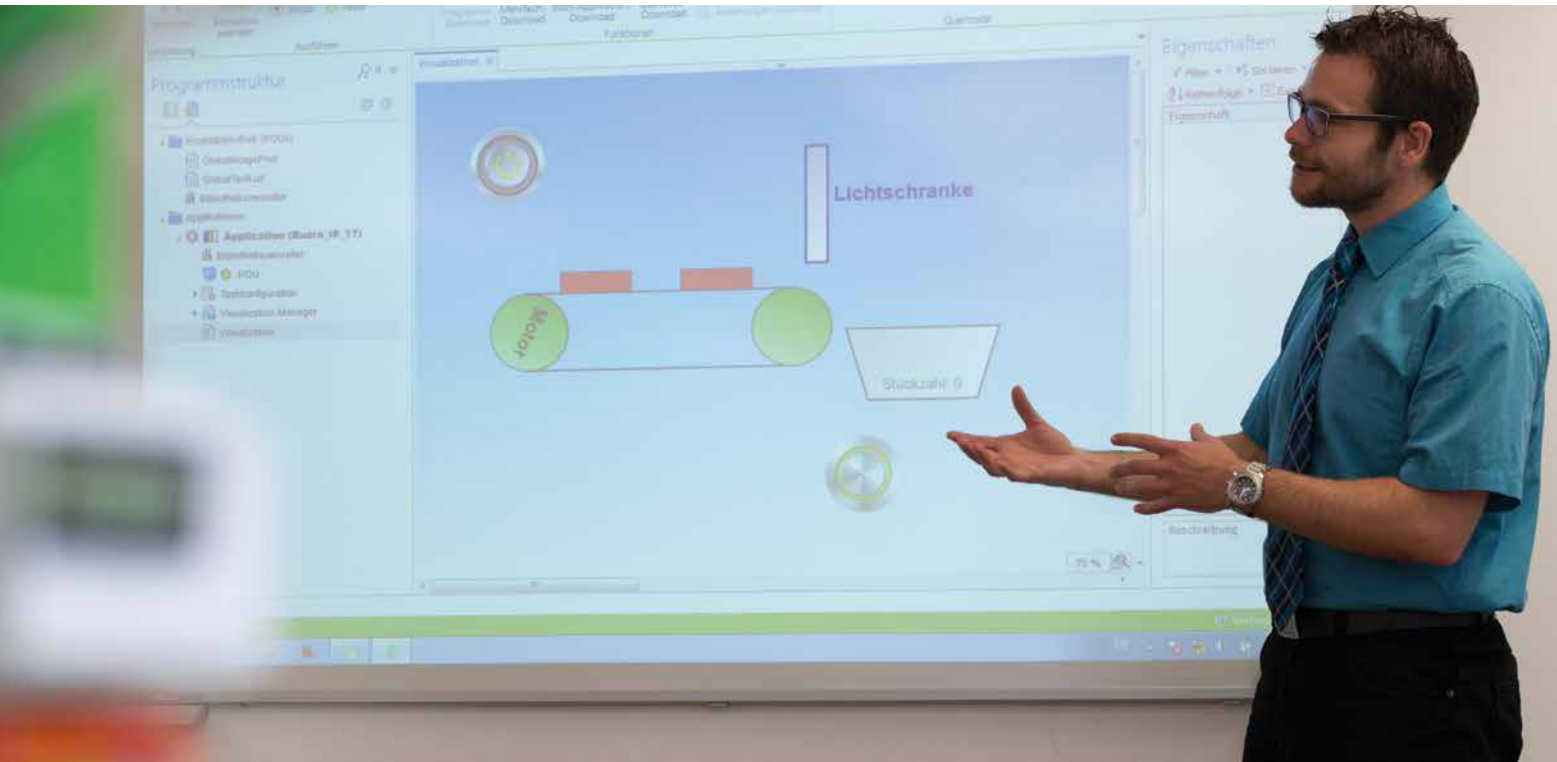

Setting the Bar with Your Goals

Product-Related and Customer-Specific Seminars



Small Groups

The small class sizes of WAGO training seminars ensures that no question goes unanswered and no one is overlooked.



Teamwork

Learning as a group is very effective. Ideas can be discussed and exchanged while experiences can be shared – all for the benefit of the participants.



Practical Topics

Experience has shown that practice makes perfect. This is why the focus of every WAGO training seminar is on practical, hands-on learning.

WAGO-Seminars

Experience the Benefits of First-Hand Knowledge and Expertise – Straight from the Source

Our instructors are specialists who know all the ins and outs of WAGO's products. This ensures that the time devoted to each WAGO training seminar is an effective investment in expanding your own expertise.

Request your registration form by email:
training@wago.com

Contact your local
 WAGO office.

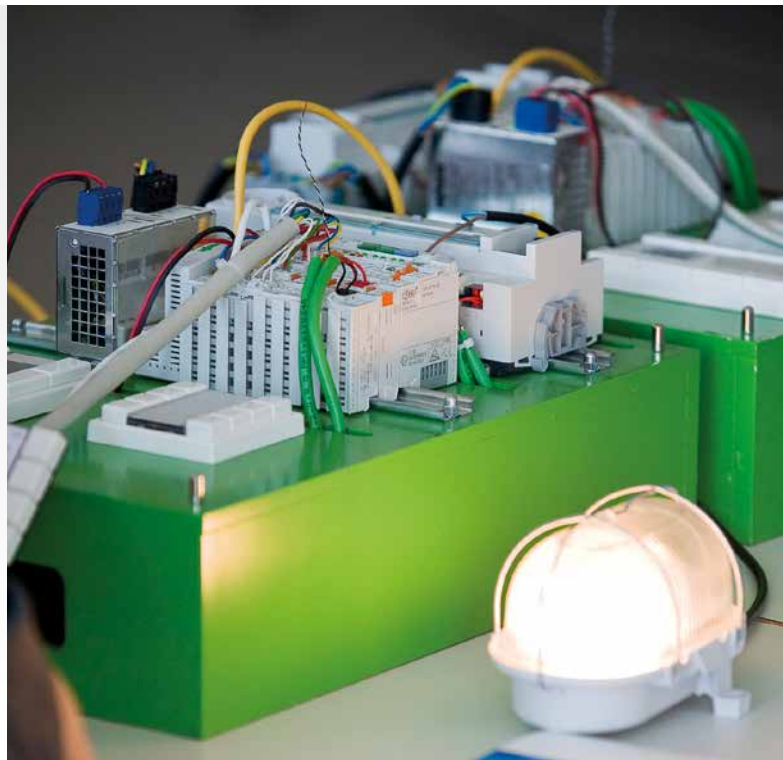

Product-Related Seminars

We regularly offer product-related seminars on the following topics:

- Building and industrial automation
- Programming of automation components
- Fieldbus systems

Current Seminars at:
www.wago.com

Customer-Specific Training Seminars

In addition to these "open" seminars, we also offer seminars specially tailored to your organization and its particular needs.

Upon request, we can also conduct these courses at your location.

Special
 Corporate Seminars



Indexes and Addresses

Indexes and Addresses

	Page
Product Index	682
Item Number Index	686
WAGO Worldwide	704

Product Index

Item	Page	Item	Page	Item	Page
A					
Actuator and actuator LED terminal blocks					
– Rail-mount terminal blocks, TOPJOB® S	122				
– Rail-mount terminal blocks, Classic	321				
– Rail-mount terminal blocks, Compact	445				
Actuator terminal blocks; with a pluggable signal level	125				
Additional modules for matrix patchboards	522				
"Alu-Plus" contact paste	625				
Angled support bracket	605				
Assembly tool; for 294 Series	495				
B					
Banana plugs	628				
B-type test plug modules	343				
Busbar carriers	577				
Busbar terminal blocks	532				
C					
Cable strippers	615				
Cable cutter	624				
CAGE CLAMP® connection	2				
Carrier terminal blocks; f.-e.	302				
– as double-, triple-deck terminal blocks	258				
– TOPJOB® S	114				
– as double-deck terminal blocks	74				
– Multilevel installation terminal blocks, TOPJOB® S	202				
– X-COM®S-SYSTEM-MINI	164				
– X-COM®S-SYSTEM	180				
– X-COM®S-SYSTEM; for Ex nA applications	192				
– X-COM®S-SYSTEM	358				
CE marking	632				
Certification organizations – overview	674				
Chassis-mount terminal strips	480				
CLASSIC splicing connectors for all conductor types	557				
Collective jumper carriers	605				
– TOPJOB® S	155				
Comb-style jumper bars	347				
Common potential and matrix patching terminal blocks (4- and 8-level terminal blocks)	526				
Common potential matrix patchboards	518				
COMPACT PUSH WIRE® connectors for junction boxes	537				
COMPACT splicing connectors (4 mm²/12 AWG) for all conductor types	549				
COMPACT splicing connectors (6 mm²/10 AWG) for all conductor types	555				
COMPACT splicing connectors for all conductor types	549				
Compact terminal blocks					
– see "Mini (rail-mount) terminal blocks"					
Compact terminal blocks	480				
Compact terminal strips	449				
Companies and representatives					
– worldwide	704				
Component plugs on carrier terminal blocks	144				
Control cabinet outlet	603				
Covers for rail-mount terminal blocks	608				
Crimping tools for ferrules	618				
Current-carrying capacity curves					
– X-COM®S-SYSTEM	417				
Current transformer terminal blocks	110				
D					
Delta jumper	155				
Derating curves					
– see "Current-carrying capacity curves"					
DIN-rails	604				
Diode double-deck terminal blocks; f.-e.	334				
– TOPJOB® S	134				
Diode modules on carrier terminal blocks	338				
– TOPJOB® S	138				
Diode modules on through terminal blocks	339				
– TOPJOB® S	139				
Diode terminal blocks; f.-e.	328				
– TOPJOB® S	128				
Diode triple-deck terminal blocks; f.-e.					
– TOPJOB® S	136				
– Compact	438				
D					
Disconnect and test terminal blocks; f.-e.					
– angled type	290				
– Double-deck, TOPJOB® S	74				
– for current and voltage transformer circuits	286				
– TOPJOB® S	110				
– horizontal type					
– Double-deck, TOPJOB® S	80				
– with a pivoting knife disconnect	276				
– TOPJOB® S	82				
– Disconnect tab	278				
Disconnect and test terminal blocks; s.-e.	506				
Disconnection tool; for 294 Series	495				
Disconnect terminal blocks; f.-e.					
– angled type					
– for current and voltage transformer circuits	286				
– Double-deck, TOPJOB® S	74				
– horizontal type					
– with a pivoting knife disconnect	292				
– TOPJOB® S	82				
– with a disconnect tab	278				
– Double-deck terminal blocks	257				
– TOPJOB® S	80				
Disconnect terminal blocks for test and measurement					
– see "Disconnect and test terminal blocks"					
Distribution terminal blocks; f.-e.	249				
Double-deck carrier terminal blocks	258				
– TOPJOB® S	74				
– X-COM®S-SYSTEM-MINI	166				
– X-COM®S-SYSTEM	182				
– X-COM®S-SYSTEM; for Ex nA applications	194				
– X-COM®S-SYSTEM	388				
Double-deck rail-mount terminal blocks; f.-e.	252				
– Compact	432				
– TOPJOB® S	60				
– Disconnect terminal blocks, TOPJOB® S	74				
– Disconnect and test terminal blocks, TOPJOB® S	80				
– Carrier terminal blocks, TOPJOB® S	74				
– Fuse terminal blocks, TOPJOB® S	75				
– Diode and LED terminal blocks	334				
– Compact	436				
– TOPJOB® S	134				
Double-fuse plugs on carrier terminal blocks	208				
Double-potential terminal blocks; f.-e.	234				
– TOPJOB® S	47				
– as terminal blocks for matrix patching	531				
– Compact	431				
E					
EC directives	632				
Electric motor wiring (quadruple-deck) rail-mount terminal blocks	264				
– TOPJOB® S	78				
Empty component plug on carrier terminal blocks	142				
End stops					
– for DIN-15 rail	611				
– for DIN-35 rail	606				
Ex ec IIc					
– Double-deck disconnect/test terminal blocks	80				
– Through terminal blocks	82				
– Protective circuit terminal blocks	84				
– Disconnect and test terminal blocks	82				
E					
Ex e II					
– Through terminal blocks; f.-e.					
– angled type	238				
– TOPJOB® S	52				
– TOPJOB® Classic	267				
– horizontal type	234				
– TOPJOB® S	46				
– Double- and triple-deck terminal blocks, TOPJOB® S	64				
– Double-potential terminal blocks; f.-e.	235				
– TOPJOB® S	51				
– Ground conductor terminal blocks; f.-e.					
– angled type	238				
– TOPJOB® S	52				
– TOPJOB® Classic	267				
– horizontal type	234				
– TOPJOB® S	46				
– High-current through terminal blocks; s.-e.	220				
– High-current ground conductor terminal blocks; s.-e.	220				
– Modular terminal blocks and terminal strips with mounting flanges or snap-in mounting feet					
– f.-e.	454				
– s.-e.	472				
– Compact through terminal blocks; for DIN-35 and DIN-15 rails	430				
– Compact ground conductor terminal blocks; for DIN-35 and DIN-15 rails	430				
– Mini through terminal blocks; for DIN-35 and DIN-15 rails	426				
– Mini ground conductor terminal blocks; for DIN-35 and DIN-15 rails	426				
Ex nA					
X-COM®S-SYSTEM					
– Carrier terminal blocks	192				
– Double-deck carrier terminal blocks	194				
– Female plugs with Push-in CAGE CLAMP® connection	196				
Ex i terminal blocks					
– see "Through terminal blocks"					
Ex applications:					
– Technical information	663				
Ex PUSH WIRE® connectors for junction boxes	542				
F					
Felt-tip pen	599				
Female plugs with Push-in CAGE CLAMP® connection					
– X-COM®S-SYSTEM-MINI	168				
– X-COM®S-SYSTEM	184				
– X-COM®S-SYSTEM; for Ex nA applications	196				
Female plugs with CAGE CLAMP® connection					
– X-COM®S-SYSTEM	408				
Ferrules	621				
– TOPJOB® S	619				
– High-current rail-mount terminal blocks	623				
– 4-conductor chassis-mount terminal strips	620				
Field-wiring terminal blocks	488				
Fuse modules; for carrier terminal blocks	302				
– TOPJOB® S	114				
Fuse terminal blocks; f.-e.					
– angled type					
– for mini-automotive blade-style fuses	294				
– with a pivoting fuse holder	298				
– Double-deck terminal blocks, TOPJOB® S	75				
– horizontal type					
– TOPJOB® S	88				
– with a pivoting fuse holder, TOPJOB® S	90				
Fuse plugs on carrier terminal blocks	302				
– TOPJOB® S	114				
– for double-/triple-deck terminal blocks	258				
– double-, TOPJOB® S	208				
Fuse terminal blocks; s.-e.	508				
– for cylindrical fuses and class CC fuses	306				
G					
Ground conductor disconnect terminal blocks; f.-e.	292				
– TOPJOB® S	98				
Ground conductor disconnect terminal blocks; s.-e.	507				
Ground conductor terminal blocks, Compact					
– for DIN-35 and DIN-15 rails	430				

Item	Page
G	
Ground conductor terminal blocks; f.-e.	
– angled type	238
– TOPJOB® S	52
– TOPJOB® Classic	267
– for current and voltage transformer circuits	287
– TOPJOB® S	111
– horizontal type	234
– TOPJOB® S	46
– with lever and Push-in CAGE CLAMP®	26
– with lever and push-button	29
– with push-button	32
– 5 mm (0.197 inch) wide; 4 mm² (12 AWG)	240
– Double-deck terminal blocks	252
– TOPJOB® S	60
– Triple-deck terminal blocks	262
– TOPJOB® S	76
– Distribution terminal blocks, TOPJOB® S	214
Ground conductor terminal blocks, Mini	
– for DIN-35 and DIN-15 rails	426
Ground conductor terminal blocks; s.-e.	502
– High-current~	220
H	
High-current rail-mount terminal blocks with POWER CAGE CLAMP connection	Section 4
I	
IEC/EN specifications	633
Installation distribution terminal blocks	
– see "Multilevel installation terminal blocks"	
Installation rail-mount terminal blocks	
– see "Multilevel installation terminal blocks"	
Insulation stops	
– TOPJOB® S	44
– for rail-mount terminal blocks, Classic	346
– X-COM®-SYSTEM	358
– for matrix patchboards	523
Item Number Index	686
J	
Jumpers for rail-mount terminal blocks	
– see "Step-down jumpers, staggered jumpers, push-in type wire jumpers"	
Junction box connectors	Section 12
L	
Lamp demonstration connectors ("Service" connectors)	565
L-BOXX® 102	560
L-type test plug modules	342
– TOPJOB® S	150
LED double-deck terminal blocks; f.-e.	334
– TOPJOB® S	136
LED modules on carrier terminal blocks	340
– TOPJOB® S	140
LED modules on through terminal blocks	341
– TOPJOB® S	141
LED terminal blocks; f.-e.	328
– TOPJOB® S	128
LED triple-deck terminal blocks; f.-e.	
– TOPJOB® S	136
– Compact	438
Lighting connectors	565
Longitudinal switching disconnect terminal blocks	290
Luminaire disconnect connectors	566
M	
Male connectors with CAGE CLAMP®connection	
– X-COM®-SYSTEM	398
Male headers with solder pins	
– X-COM®-SYSTEM	402
Marking accessories	Section 13, Volume 6

Item	Page
M	
Material specifications for insulation/contact materials, contact plating	660
Matrix patchboards	514
Matrix patching and common potential terminal blocks (4- and 8-level terminal blocks)	526
MICRO PUSH WIRE® connectors for junction boxes	546
Mini through terminal blocks, f.-e.	
– for DIN-35 and DIN-15 rails	426
Mini ground terminal blocks; f.-e.	
– for DIN-35 and DIN-15 rails	426
Modular connectors	
– TOPJOB® S	146
– X-COM®S-SYSTEM	Section 2
– X-COM®-SYSTEM	Section 6
Modular terminal blocks and terminal strips	
– see "Terminal blocks and terminal strips"	
Modular terminal blocks and terminal strips with mounting flanges or snap-in mounting feet	
– Compact	450
– f.-e.	454
– s.-e.	460
Male connectors with CAGE CLAMP®connection	
– X-COM®-SYSTEM	398
Male headers with solder pins	
– X-COM®-SYSTEM	402
Modular test plug adapters	
– see "Test plug adapters"	
Mounting carrier for splicing connectors	
– 221 Series (4 mm²/12 AWG connectors)	551
– 221 Series (6 mm²/10 AWG connectors)	555
– 222 Series	559
– 243 Series	547
– 773 Series	538
– 2273 Series	537
Mounting foot	
– for isolated DIN-rail mounting	607
– for busbars	572
Multilevel installation terminal blocks as carrier terminal blocks TOPJOB® S	206
Multilevel installation terminal blocks; with an internal Multilevel installation terminal blocks; with an N-disconnect slide link TOPJOB® S	202
Multilevel rail-mount terminal blocks	
– see "Double-, triple-, quadruple-deck terminal blocks"	
Multilevel terminal blocks	
– see "Multilevel installation terminal blocks"	
– see "Double-, triple- and quadruple-deck terminal blocks"	
N	
N-conductor disconnect terminal blocks	
– TOPJOB® S	212
– TOPJOB® Classic	271
Neon lamp modules on carrier terminal blocks	340
N-disconnection TOPJOB® S	204
O	
Operating tools	612
– TOPJOB® S	612
– TOPJOB® Classic	267
– High-current rail-mount terminal blocks	613
Order form available upon request	
Q	
Quadruple-deck rail-mount terminal blocks (for fast electric motor wiring)	264
– TOPJOB® S	78

Item	Page
P	
Patchboard systems	
– Matrix patchboards	514
– Common potential matrix patchboards	518
– Matrix patching and common potential terminal blocks (4- and 8-level terminal blocks)	526
– Terminal blocks for matrix patching (3-conductor, double-potential terminal blocks)	531
Pin modules for rail-mount terminal blocks for Wire-Wrap or Termi-Point connections	531
Pluggable tap-off modules	441
POWER CAGE CLAMP connection	3
Power distribution disconnect terminal blocks	
– TOPJOB® S	212
– TOPJOB® Classic	271
Power taps; for high-current terminal blocks	220
Push-in CAGE CLAMP® connection	2
Push-in type wire jumpers for rail-mount terminal blocks	348
– TOPJOB® S	154
PUSH WIRE® connection	3
PUSH WIRE® connection	3
PUSH WIRE® connectors for junction boxes	538
PUSH WIRE® connectors for junction boxes, Ex e II	542
PUSH WIRE® Connectors for Junction Boxes, COMPACT	537
PUSH WIRE® connectors for junction boxes, MICRO	546
R	
Rail end cap; for DIN-35 rail	604
Rail-mount spacer blocks	236
S	
Screwdrivers	
– see "Operating tools"	
Sensor and sensor LED terminal blocks	
– Rail-mount terminal blocks, TOPJOB® S	120
– Rail-mount terminal blocks, Classic	312
– Rail-mount terminal blocks, Compact	443
Sensor terminal blocks; with a pluggable signal level	125
"Service" connectors	565
Shield clamping saddles	572
Shield clamps	576
Shield terminal blocks	
– angled type	238
– TOPJOB® S	52
– TOPJOB® Classic	267
– horizontal type	234
– TOPJOB® S	48
– Double-deck terminal blocks, TOPJOB® S	61
– Triple-deck terminal blocks	262
– TOPJOB® S	76
Spacers for sensor/actuator terminal blocks	312
Specifications UL – Underwriters Laboratories, USA	654
Splicing connectors (4 mm²/12 AWG) for all conductor types, COMPACT	549
Splicing connectors (6 mm²/10 AWG) for all conductor types, COMPACT	555
Splicing connectors for all conductor types, CLASSIC	557
Splicing connector set	560
Spring-equipped shield clamping saddles	575
Staggered jumpers for rail-mount terminal blocks	348
– TOPJOB® S	154
Star point jumper	155
Step-down jumpers for through terminal blocks	
– TOPJOB® S	59
– High-current; 35 mm²/2 AWG	220
– f.-e.	250
– s.-e.	505
Stickers with operating instructions	
– see www.wago.com	
Strain relief housings	
– X-COM®-SYSTEM	416
Strain relief plates	
– X-COM®S-SYSTEM	170
– X-COM®-SYSTEM	398
– for 294 Series	495
Strain reliefs	495
Switch cabinet drawer	603

Product Index

Item	Page	Item	Page	Item	Page
S					
Subsidiaries and representatives					
– worldwide	704				
Supply terminal blocks					
– Ground conductor terminal block					
– TOPJOB® S	214				
– TOPJOB® Classic	270				
– N-conductor disconnect terminal blocks					
– TOPJOB® S	214				
– TOPJOB® Classic	272				
Supply terminal blocks for distribution boxes TOPJOB® S	214				
T					
Tap-off modules	441				
Technical information					
– general	632				
– hazardous areas	663				
– miniature fuses	308				
Terminal block assemblies for current and voltage circuits	112				
Terminal blocks for matrix patching (3-conductor, double-potential terminal blocks)	531				
Terminal strips and modular terminal blocks with mounting flanges or snap-in mounting feet					
– Compact	449				
– f.-e.	456				
– s.-e.	461				
Terminating aluminum conductors	625				
Testboy	626				
Testing tap, TOPJOB® S	151				
Test pin	164				
Test plug adapter, TOPJOB® S	151				
Test plug modules	345				
– TOPJOB® S	150				
– with CAGE CLAMP® connection	342				
– Mini rail-mount terminal blocks	474				
Tests and testing procedures	634				
Three-phase set; with high-current terminal blocks	220				
Through terminal blocks, Compact					
– for DIN-35 and DIN-15 rails	430				
Through terminal blocks; f.-e.					
– angled type	238				
– TOPJOB® S	52				
– TOPJOB® Classic	267				
– for current and voltage transformer circuits	286				
– TOPJOB® S	110				
– for fuse terminal blocks for mini-automotive blade-style fuses	292				
– horizontal type	234				
– TOPJOB® S	46				
– with lever and Push-in CAGE CLAMP®	26				
– with lever and push-button	29				
– with push-button	32				
– 5 mm (0.197 inch) wide; 4 mm ² (12 AWG)	240				
– Double- and triple-deck terminal blocks	252				
– TOPJOB® S	60				
– Distribution terminal blocks	249				
– TOPJOB® S	214				
Through terminal blocks; Mini					
– for DIN-35 and DIN-15 rails	426				
Through terminal blocks; s.-e.	502				
– High-current-	220				
Tools	Section 13				
TOPJOB® terminal blocks with CAGE CLAMP® connection					
– Through terminal blocks	267				
– Shield terminal blocks	267				
– Protective circuit terminal blocks	267				
– N-conductor disconnect terminal blocks	271				
– Power distribution disconnect terminal blocks:	271				
– Tools	612				
T					
TOPJOB® S terminal blocks with Push-in CAGE CLAMP® connection					
– Carrier terminal blocks	114				
– Through terminal blocks	46				
– Through terminal blocks; with lever and Push-in CAGE CLAMP®	26				
– Through terminal blocks; with lever and push-button	29				
– Through terminal blocks; with push-button	32				
– Double-potential terminal blocks	47				
– Protective circuit terminal blocks	46				
– Ground conductor terminal blocks; with lever and Push-in CAGE CLAMP®	26				
– Ground conductor terminal blocks; with lever and push-button	29				
– Ground conductor terminal blocks; with push-button	32				
– Shield terminal blocks	48				
– Double-deck terminal blocks	60				
– Double-deck disconnect terminal blocks	74				
– Double-deck disconnect/test terminal blocks	80				
– Double-deck carrier terminal blocks	74				
– Double-deck fused disconnect terminal blocks with a pivoting fuse holder	75				
– Triple-deck terminal blocks	76				
– Quadruple-deck terminal blocks	78				
– Disconnect and test terminal blocks	82				
– Disconnect/test terminal blocks for current and voltage transformer circuits	110				
– Fuse terminal blocks	88				
– Fused disconnect terminal blocks with a pivoting fuse holder	90				
– Ground conductor disconnect terminal blocks	98				
– Terminal block assemblies for current and voltage circuits	112				
– Fuse plugs	114				
– Sensor terminal blocks	120				
– Sensor terminal blocks; with a pluggable signal level	125				
– Actuator terminal blocks	122				
– Actuator terminal blocks; with a pluggable signal level	127				
– Diode and LED terminal blocks	128				
– Double-deck diode and LED terminal blocks	134				
– Triple-deck diode and LED terminal blocks	136				
– Diode modules on carrier terminal blocks	138				
– Diode modules on through terminal blocks	139				
– LED modules on carrier terminal blocks	140				
– LED modules on through terminal blocks	141				
– Empty component plug on carrier terminal blocks	142				
– Component plugs on carrier terminal blocks	144				
– Modular connectors and connector strips	146				
– Test plug modules	150				
– Multilevel installation terminal blocks with an N-disconnect slide link	202				
– Multilevel installation terminal blocks with an internal N-disconnection	204				
– Multilevel installation terminal blocks as carrier terminal blocks	206				
– Double-fuse plugs on carrier terminal blocks	208				
– N-conductor disconnect terminal blocks	212				
– Power distribution disconnect terminal blocks:	212				
– Supply terminal blocks for distribution boxes	214				
Transformer terminal blocks					
– see "Disconnect and test terminal blocks"					
Transverse switching terminal blocks	290				
Triple-deck carrier terminal blocks	259				
Triple-deck installation terminal blocks, TOPJOB® S	202				
Triple-deck rail-mount terminal blocks; f.-e.	262				
– Compact	434				
– TOPJOB® S	76				
– Diode and LED terminal blocks					
– Compact	438				
– TOPJOB® S	136				
U					
UL Specifications – Underwriters Laboratories, USA	654				
V					
Vario-T-BOXX	560				
Voltage testers	626				
Voltage transformer terminal blocks	110				
W					
WAGO					
– worldwide	704				
– Connection technologies	2				
WAGO CAGE CLAMP® connection	2				
WAGO POWER CAGE CLAMP connection	3				
WAGO Push-in CAGE CLAMP® connection	2				
WAGO PUSH WIRE® connection	3				
WFB continuous marking strips	599				
Wire jumpers for rail-mount terminal blocks; push-in type	349				
– TOPJOB® S	156				
Wire harness support	531				
Wire strippers	616				
X					
X-COM®S-SYSTEM-MINI					
– Carrier terminal blocks	164				
– Double-deck carrier terminal blocks	166				
– Female plugs with Push-in CAGE CLAMP® connection	168				
X-COM®S-SYSTEM					
– Carrier terminal blocks	180				
– Double-deck carrier terminal blocks	182				
– Female plugs with Push-in CAGE CLAMP® connection	184				
X-COM®S-SYSTEM; for Ex nA applications					
– Carrier terminal blocks	192				
– Double-deck carrier terminal blocks	194				
– Female plugs with Push-in CAGE CLAMP® connection	196				
X-COM®-SYSTEM					
– Carrier terminal blocks	358				
– Double-deck carrier terminal blocks	388				
– Female plugs with CAGE CLAMP® connection	408				
– Male connectors with CAGE CLAMP® connection	398				
– Male headers with solder pins	402				

Item	Page	Item	Page

Item Number Index

Item No.	Page	Item No.	Page	Item No.	Page	Item No.	Page
206 Series		209 Series		210 Series		210 Series	
206-105	611	209-196	609	210-333/600-075	591	210-508	605
206-118	624	209-290	454	210-333/600-076	591	210-549	609
				210-333/600-077	591		
206-294	495	209-500/209-035	514	210-333/600-078	591	210-612	599
		209-501	416	210-333/600-079	591	210-647	612
206-706	627	209-502	514	210-333/600-103	591	210-648	612
206-707	627	209-566	514	210-333/600-104	591	210-657	612
				210-333/600-105	591	210-658	612
206-804	626	209-700/209-124	259	210-333/600-106	591		
206-808	627	209-700/209-125	259	210-333/700-001	592	210-719	612
206-810	626	209-700/209-126	259	210-333/700-020	592	210-720	612
206-816	626	209-700/209-127	259	210-333/700-021	592	210-721	612
		209-701	259	210-333/700-074	592	210-722	612
206-1125	617	209-701/000-002	259	210-333/700-075	592		
206-1126	617	209-701/000-005	259	210-333/700-076	592	215 Series	
206-1127	617	209-701/000-006	259	210-333/700-077	592	215-111	628
206-1128	617	209-701/000-007	259	210-333/700-078	592		
206-1129	617	209-701/000-012	259	210-333/700-079	592	215-211	628
206-1131	617	209-701/000-017	259	210-333/700-108	592	215-212	628
206-1132	617	209-701/000-023	259	210-333/700-109	592		
		209-701/000-024	259	210-333/800-001	590	215-311	628
206-1204	618	209-787	259	210-333/800-002	590		
206-1205	618	210 Series		210-333/800-003	590	215-411	628
206-1206	618	210-103	133	210-333/800-004	590		
206-1207	618	210-110	599	210-333/800-005	590	215-511	628
206-1216	618	210-111	611	210-333/800-006	590		
206-1225	622	210-112	604	210-333/800-007	590	215-611	628
206-1250	622	210-113	604	210-333/800-008	590		
		210-114	604	210-333/800-009	590	215-711	628
206-1400	614	210-115	604	210-333/800-010	590		
206-1403	614	210-118	604	210-333/800-011	590	215-811	628
206-1411	614	210-123	133	210-333/800-074	590		
206-1412	614	210-133	202	210-333/800-075	590	215-911	628
206-1413	614	210-136	629	210-333/800-076	590		
206-1414	614	210-137	629	210-333/800-077	590	216 Series	
206-1415	614	210-141	613	210-333/800-078	590	216-101	615
206-1418	614	210-143	613	210-333/800-079	590	216-102	615
206-1419	614	210-148	605	210-333/800-209	590	216-103	615
206-1441	615	210-149	605	210-333/1000-001	591	216-104	615
206-1442	615	210-154	450	210-333/1000-074	591	216-106	615
206-1451	615	210-196	604	210-333/1000-075	591	216-107	615
206-1481	616	210-197	604	210-333/1000-076	591	216-108	615
206-1482	616	210-198	604	210-333/1000-077	591	216-109	615
206-1491	616			210-333/1000-078	591	216-110	615
206-1492	616			210-333/1000-079	591	216-121	615
		210-254	110	210-333/1000-110	591	216-122	615
209 Series		210-281	202	210-333/1000-111	591	216-123	615
209-100	605	210-295	611	210-333/1000-112	591	216-124	615
209-105	202	210-296	611	210-333/1000-113	591	216-131	615
209-106	607	210-297	271	210-333/1000-202	591	216-132	615
209-107	279			210-333/1000-204	591	216-133	615
209-108	279	210-331	590	210-333/1000-206	591	216-141	613
209-109	604	210-332	590	210-333/1000-208	591	216-142	613
209-112	596	210-333	590	210-333/1200-001	592	216-143	613
209-113	596	210-333/500-001	590	210-333/1200-074	592	216-144	613
209-114	596	210-333/500-002	590	210-333/1200-075	592	216-151	615
209-119	460	210-333/500-003	590	210-333/1200-076	592	216-152	615
209-120	460	210-333/500-004	590	210-333/1200-077	592		
209-122	450	210-333/500-005	590	210-333/1200-078	592	216-201	615
209-123	460	210-333/500-006	590	210-333/1200-079	592	216-202	615
209-128	598	210-333/500-007	590	210-333/1200-103	592	216-202	615
209-129	613	210-333/500-008	590	210-333/1200-104	592	216-203	615
209-130	613	210-333/500-009	590	210-333/1200-105	592	216-204	615
209-132	460	210-333/500-010	590	210-333/1200-106	592	216-205	615
209-137	398	210-333/500-011	590	210-333/1200-107	592	216-206	615
209-140	596	210-333/500-021	590	210-333/1200-107	592	216-207	615
209-141	596	210-333/500-074	590	210-333/1200-203	592	216-208	613
209-142	596	210-333/500-075	590	210-334	590	216-209	615
209-143	598	210-333/500-076	590	210-335	590	216-210	613
209-144	598	210-333/500-077	590	210-345	596	216-221	615
209-145	596	210-333/500-078	590			216-222	615
209-170	235	210-333/500-079	590	210-412	287	216-223	615
209-173	416	210-333/600-001	591	210-413	287	216-224	615
209-174	416	210-333/600-006	591	210-414	287	216-241	613
209-183	599	210-333/600-007	591	210-415	287	216-242	613
209-184	599	210-333/600-008	591	210-423	291	216-243	613
209-185	599	210-333/600-009	591	210-424	291	216-244	613
209-190	46	210-333/600-010	591	210-490	399	216-246	613
209-191	46	210-333/600-011	591			216-262	613
209-192	65	210-333/600-021	591	210-504	605	216-263	613
		210-333/600-074	591	210-505	605	216-264	613
				210-506	605	216-266	613

Item No.	Page	Item No.	Page	Item No.	Page	Item No.	Page
216 Series		243 Series		260 Series		261 Series	
216-267	613	243-308	546	260-202	461	261-108/331-000	465
216-284	613	243-504	546	260-203	461	261-108/341-000	467
216-286	613	243-508	546	260-204	461	261-109	463
216-287	613	243-804	546	260-205	461	261-109/331-000	465
216-288	613	243-808	546	260-206	461	261-109/341-000	467
216-289	613	248 Series		260-207	461	261-110	463
216-301	615	248-501	589	260-208	461	261-110/331-000	465
216-302	615	248-501/000-002	589	260-209	461	261-110/341-000	467
216-321	615	248-501/000-005	589	260-210	461	261-111	463
216-322	615	248-501/000-006	589	260-211	461	261-111/331-000	465
216-413	617	248-501/000-007	589	260-212	461	261-111/341-000	467
216-414	617	248-501/000-012	589	260-252	461	261-112	463
216-424	617	248-501/000-017	589	260-253	461	261-112/331-000	465
216-425	617	248-501/000-023	589	260-254	461	261-112/341-000	467
216-435	617	248-501/000-024	589	260-255	461	261-152	463
216-545	307	249 Series		260-256	461	261-152/331-000	465
216-546	307	249-101	611	260-257	461	261-152/341-000	467
216-547	307	249-105	599	260-258	461	261-153	463
221 Series		249-106	343	260-259	461	261-153/331-000	465
221-412	549	249-107	343	260-260	461	261-153/341-000	467
221-413	549	249-109	526	260-261	461	261-154	463
221-415	549	249-116	606	260-262	461	261-154/331-000	465
221-500	551	249-117	606	260-301	460	261-154/341-000	467
221-502	553	249-118	597	260-303	460	261-155	463
221-502/000-004	553	249-119	597	260-304	460	261-155/331-000	465
221-503	553	249-120	597	260-306	460	261-155/341-000	467
221-503/000-004	553	249-125	349	260-307	460	261-156	463
221-505	553	249-126	349	260-311	460	261-156/331-000	465
221-505/000-004	553	249-127	349	260-313	460	261-156/341-000	467
221-510	555	249-130	625	260-314	460	261-157	463
221-512	553	249-135	474	260-316	460	261-157/331-000	465
221-512/000-004	553	249-136	474	260-317	460	261-157/341-000	467
221-513	553	249-137	474	260-321	460	261-158	463
221-513/000-004	553	249-138	474	260-323	460	261-158/331-000	465
221-515	553	249-139	474	260-324	460	261-158/341-000	467
221-515/000-004	553	249-140	474	260-326	460	261-159	463
221-522	553	249-141	342	260-327	460	261-159/331-000	465
221-522/000-004	553	249-142	342	260-331	460	261-159/341-000	467
221-523	553	249-143	342	260-333	460	261-160	463
221-523/000-004	553	249-144	342	260-334	460	261-160/331-000	465
221-525	553	249-145	342	260-336	460	261-160/341-000	467
221-525/000-004	553	249-146	342	260-337	460	261-161	463
221-612	555	249-147	343	260-341	460	261-161/331-000	465
221-613	555	249-148	343	260-343	460	261-161/341-000	467
221-615	555	249-197	606	260-344	460	261-162	463
222 Series		258 Series		260-346	460	261-162/331-000	465
222-412	557	258-5000	601	260-347	460	261-162/341-000	467
222-413	557	258-5030	601	260-351	460	261-202	463
222-415	557	260 Series		260-353	460	261-202/332-000	465
222-500	559	260-102	461	260-354	460	261-202/342-000	467
222-505	551	260-103	461	260-356	460	261-203	463
222-510	551	260-104	461	260-357	460	261-203/332-000	465
224 Series		260-105	461	260-361	460	261-203/342-000	467
224-101	561	260-106	461	260-371	460	261-204	463
224-104	561	260-107	461	260-402	460	261-204/332-000	465
224-112	561	260-108	461	260-404	474	261-204/342-000	467
224-114	561	260-109	461	260-405	474	261-205	463
224-201	561	260-110	461	261 Series		261-205/332-000	465
243 Series		260-111	461	261-102	463	261-205/342-000	467
243-110	547	260-112	461	261-102/331-000	465	261-206	463
243-112	547	260-152	461	261-102/341-000	467	261-206/332-000	465
243-113	547	260-153	461	261-103	463	261-206/342-000	467
243-144	546	260-154	461	261-103/331-000	465	261-207	463
243-204	546	260-155	461	261-103/341-000	467	261-207/332-000	465
243-208	546	260-156	461	261-104	463	261-207/342-000	467
243-304	546	260-157	461	261-104/331-000	465	261-208	463
		260-158	461	261-104/341-000	467	261-208/332-000	465
		260-159	461	261-105	463	261-208/342-000	467
		260-160	461	261-105/331-000	465	261-209	463
		260-161	461	261-105/341-000	467	261-209/332-000	465
		260-162	461	261-106	463	261-209/342-000	467
				261-106/331-000	465	261-210	463
				261-106/341-000	467	261-210/332-000	465
				261-107	463	261-210/342-000	467
				261-107/331-000	465	261-211	463
				261-107/341-000	467	261-211/332-000	465
				261-108	463	261-211/342-000	467
						261-212	463
						261-212/332-000	465

Item Number Index

Item No.	Page	Item No.	Page	Item No.	Page	Item No.	Page
261 Series		261 Series		261 Series		262 Series	
261-212/342-000	467	261-331/332-000	464	261-431	469	262-254	471
261-252	463	261-331/342-000	466	261-431/331-000	469	262-255	471
261-252/332-000	465	261-333	462	261-431/341-000	469	262-256	471
261-252/342-000	467	261-333/332-000	464	261-432	469	262-257	471
261-253	463	261-333/342-000	466	261-432/331-000	469	262-258	471
261-253/332-000	465	261-334	462	261-432/341-000	469	262-259	471
261-253/342-000	467	261-334/332-000	464			262-260	471
261-254	463	261-334/342-000	466	262 Series		262-261	471
261-254/332-000	465	261-336	462	262-102	471	262-262	471
261-254/342-000	467	261-336/332-000	464	262-103	471	262-280	472
261-255	463	261-336/342-000	466	262-104	471	262-281	472
261-255/332-000	465	261-337	462	262-105	471	262-282	473
261-255/342-000	467	261-337/332-000	464	262-106	471	262-283	473
261-256	463	261-337/342-000	466	262-107	471	262-284	473
261-256/332-000	465	261-341	462	262-108	471	262-285	473
261-256/342-000	467	261-341/332-000	464	262-109	471	262-286	473
261-257	463	261-341/342-000	466	262-110	471	262-287	473
261-257/332-000	465	261-343	462	262-111	471	262-288	473
261-257/342-000	467	261-343/332-000	464	262-112	471	262-289	473
261-258	463	261-343/342-000	466	262-130	472	262-290	473
261-258/332-000	465	261-344	462	262-132	473	262-291	473
261-258/342-000	467	261-344/332-000	464	262-133	473	262-292	473
261-259	463	261-344/342-000	466	262-134	473		
261-259/332-000	465	261-346	462	262-135	473	262-301	470
261-259/342-000	467	261-346/332-000	464	262-136	473	262-304	470
261-260	463	261-346/342-000	466	262-137	473	262-306	470
261-260/332-000	465	261-347	462	262-138	473	262-307	470
261-260/342-000	467	261-347/332-000	464	262-139	473	262-311	470
261-261	463	261-347/342-000	466	262-140	473	262-314	470
261-261/332-000	465	261-351	462	262-141	473	262-316	470
261-261/342-000	467	261-351/332-000	464	262-142	473	262-317	470
261-262	463	261-351/342-000	466	262-152	471	262-321	470
261-262/332-000	465	261-353	462	262-153	471	262-324	470
261-262/342-000	467	261-353/332-000	464	262-154	471	262-326	470
		261-353/342-000	466	262-155	471	262-327	470
261-301	462	261-354	462	262-156	471	262-331	470
261-301/331-000	464	261-354/332-000	464	262-157	471	262-334	470
261-301/341-000	466	261-354/342-000	466	262-158	471	262-336	470
261-303	462	261-356	462	262-159	471	262-337	470
261-303/331-000	464	261-356/332-000	464	262-160	471	262-341	470
261-303/341-000	466	261-356/342-000	466	262-161	471	262-344	470
261-304	462	261-357	462	262-162	471	262-346	470
261-304/331-000	464	261-357/332-000	464	262-180	472	262-347	470
261-304/341-000	466	261-357/342-000	466	262-181	472	262-351	470
261-306	462	261-361	462	262-182	473	262-354	470
261-306/331-000	464	261-371	462	262-183	473	262-356	470
261-306/341-000	466			262-184	473	262-357	470
261-307	462	261-402	462	262-185	473	262-361	470
261-307/331-000	464	261-404	474	262-186	473	262-363	472
261-307/341-000	466	261-405	474	262-187	473	262-371	470
261-311	462	261-410	468	262-188	473	262-373	472
261-311/331-000	464	261-411	468	262-189	473		
261-311/341-000	466	261-411/331-000	468	262-190	473	262-402	470
261-313	462	261-411/341-000	468	262-191	473		
261-313/331-000	464	261-422	469	262-192	473		
261-313/341-000	466	261-422/331-000	469				
261-314	462	261-422/341-000	469	262-202	471	264 Series	
261-314/331-000	464	261-423	469	262-203	471	264-102	456
261-314/341-000	466	261-423/331-000	469	262-204	471	264-103	456
261-316	462	261-423/341-000	469	262-205	471	264-104	456
261-316/331-000	464	261-424	469	262-206	471	264-105	456
261-316/341-000	466	261-424/331-000	469	262-207	471	264-106	456
261-317	462	261-424/341-000	469	262-208	471	264-107	456
261-317/331-000	464	261-425	469	262-209	471	264-108	456
261-317/341-000	466	261-425/331-000	469	262-210	471	264-109	456
261-321	462	261-425/341-000	469	262-211	471	264-110	456
261-321/331-000	464	261-426	469	262-212	471	264-111	456
261-321/341-000	466	261-426/331-000	469	262-213	471	264-112	456
261-323	462	261-426/341-000	469	262-230	472	264-120	427
261-323/331-000	464	261-427	469	262-232	473	264-125	426
261-323/341-000	466	261-427/331-000	469	262-233	473	264-130	454
261-324	462	261-427/341-000	469	262-234	473	264-131	454
261-324/331-000	464	261-428	469	262-235	473	264-132	456
261-324/341-000	466	261-428/331-000	469	262-236	473	264-133	456
261-326	462	261-428/341-000	469	262-237	473	264-134	456
261-326/331-000	464	261-429	469	262-238	473	264-135	456
261-326/341-000	466	261-429/331-000	469	262-239	473	264-136	456
261-327	462	261-429/341-000	469	262-240	473	264-137	456
261-327/331-000	464	261-430	469	262-241	473	264-138	456
261-327/341-000	466	261-430/331-000	469	262-242	473	264-139	456
261-331	462	261-430/341-000	469	262-252	471	264-140	456
				262-253	471	264-141	456

Item No.	Page	Item No.	Page	Item No.	Page	Item No.	Page
264 Series		264 Series		279 Series		279 Series	
264-142	456	264-316	455	279-101	502	279-904	234
264-152	456	264-317	455	279-104	502	279-905	234
264-153	456	264-321	454			279-906	234
264-154	456	264-324	454	279-308	234	279-907	234
264-155	456	264-326	454	279-309	234	279-907/999-950	234
264-156	456	264-327	454	279-325	234	279-915/281-410	328
264-157	456	264-331	454	279-326	234	279-915/281-411	328
264-158	456	264-334	454	279-328	234	279-992	234
264-159	456	264-336	454	279-329	234	279-993	234
264-160	456	264-337	454	279-330	234	279-994	234
264-161	456	264-341	455	279-331	234	279-995	235
264-162	456	264-344	455	279-339	234		
264-180	455	264-346	455	279-340	234	280 Series	
264-182	456	264-347	455	279-341	234	280-101	502
264-183	456	264-351	454	279-342	234	280-104	502
264-184	456	264-354	454	279-344	234	280-107	502
264-185	456	264-356	454	279-345	234		
264-186	456	264-357	454	279-346	234	280-301	502
264-187	456	264-361	454	279-347	234	280-302	502
264-188	456	264-363	454	279-348	234	280-303	259
264-189	456	264-364	454	279-349	234	280-304	259
264-190	456	264-367	426			280-305	262
264-191	456	264-368	426	279-402	234	280-306	262
264-192	456	264-369	426	279-405	502	280-308	236
		264-370	426	279-409	234	280-309	236
264-202	456	264-371	455	279-415	235	280-310	236
264-203	456	264-373	455	279-422	234	280-311	236
264-204	456	264-374	455	279-432	613	280-312	238
264-205	456			279-433	613	280-313	238
264-206	456	264-402	426	279-440	613	280-314	236
264-207	456			279-470	346	280-315	236
264-208	456	264-701	427	279-471	346	280-318	238
264-209	456	264-704	427	279-482	347	280-319	313
264-210	456	264-706	427	279-483	347	280-320	315
264-211	456	264-711	426	279-490	347	280-321	313
264-212	456	264-714	426	279-492	347	280-322	502
264-220	427	264-716	426			280-323	315
264-225	426	264-721	427	279-501	252	280-324	236
264-230	454	264-724	427	279-504	252	280-325	531
264-231	454	264-726	427	279-507	252	280-326	236
264-232	457	264-727	427	279-508	252	280-332	502
264-233	457	264-727/999-950	427	279-509	252	280-333	531
264-234	457	264-731	426	279-512	252	280-334	236
264-235	457	264-734	426	279-513	252	280-335	236
264-236	457	264-736	426	279-517	252	280-336	259
264-237	457	264-737	426	279-518	253	280-339	262
264-238	457	264-737/999-950	426	279-519	253	280-340	256
264-239	457			279-527	252	280-341	256
264-240	457	264-900	589	279-529	253	280-342	256
264-241	457	264-901	589			280-343	256
264-242	457	264-902	589	279-673/281-410	328	280-344	236
264-252	456	264-903	589	279-673/281-411	328	280-346	236
264-253	456	264-904	589	279-674/281-413	328	280-348	238
264-254	456	264-905	589	279-674/281-434	328	280-352	236
264-255	456			279-681	234	280-353	236
264-256	456	270 Series		279-682	234	280-354	238
264-257	456	270-319	445	279-683	234	280-355	238
264-258	456	270-320	443	279-684	234	280-356	236
264-259	456	270-321	445	279-685	234	280-357	236
264-260	456	270-322	443	279-686	234	280-358	236
264-261	456			279-687	234	280-359	236
264-262	456	270-409	443	279-687/999-950	234	280-366	256
264-280	455	270-417	443			280-369	256
264-282	457	270-480	443	279-809/281-413	328	280-371	276
264-283	457			279-809/281-434	328	280-373	277
264-284	457	270-560	444	279-815/281-410	328	280-374	276
264-285	457	270-560/281-434	444	279-815/281-411	328	280-376	277
264-286	457	270-560/281-507	444	279-826	235	280-394	531
264-287	457	270-564	444	279-831	234	280-395	531
264-288	457	270-564/281-483	444	279-832	234		
264-289	457	270-570	443	279-833	234	280-402	237
264-290	457	270-570/281-434	443	279-834	234	280-404	235
264-291	457	270-570/281-507	443	279-835	234	280-405	431
264-292	457	270-572	445	279-836	234	280-409	237
		270-572/281-434	445	279-837	234	280-415	237
264-301	454	270-574	443	279-837/999-950	234	280-418	344
264-304	454	270-574/281-483	443	279-838	234	280-419	344
264-306	454	270-577	445			280-422	237
264-307	454	270-585	445	279-901	234	280-432	613
264-311	455	270-585/281-507	445	279-902	234	280-433	613
264-314	455	270-586	445	279-903	234		

Item Number Index

Item No.	Page	Item No.	Page	Item No.	Page	Item No.	Page
280 Series		280 Series		280 Series		281 Series	
280-434	613	280-572/281-434	326	280-831	236	281-322	502
280-435	613	280-573	316	280-832	236	281-324	242
280-436	613	280-574	316	280-833	236	281-326	242
280-437	613	280-574/281-483	315	280-834	236	281-328	242
280-438	613	280-575	324	280-835	236	281-329	242
280-439	613	280-575/281-320	324	280-835/056-000	236	281-330	242
280-440	613	280-575/281-323	324	280-836	278	281-331	242
280-470	346	280-576	324	280-837	236	281-332	502
280-471	346	280-576/281-496	315	280-837/999-950	236	281-333	505
280-472	346	280-577	316	280-838	236	281-334	242
280-473	531	280-577/281-496	315	280-839	278	281-335	242
280-474	531	280-578	324	280-850	304	281-336	505
280-477	531	280-580	318	280-850/281-413	304	281-338	242
280-478	531	280-580/281-434	320	280-852	304	281-339	242
280-482	347	280-581/281-413	320	280-852/281-413	304	281-340	260
280-483	347	280-582	316	280-854	304	281-341	260
280-490	347	280-583	327	280-854/281-413	304	281-342	260
280-492	347	280-584	318	280-856	304	281-343	260
280-494	531	280-584/281-483	320	280-856/281-413	304	281-344	242
		280-585	327	280-868	276	281-345	242
280-510	259	280-586	327	280-869	276	281-346	242
280-513	257	280-586/281-496	320	280-870	276	281-347	242
280-514	258	280-587	318	280-871	276	281-348	243
280-515	327	280-588	318	280-874	277	281-349	242
280-517	256	280-588/280-320	318	280-875	277	281-350	242
280-519	256	280-588/280-323	318	280-876	276	281-355	242
280-520	256	280-592	322	280-879	276	281-356	242
280-521	257	280-593	324	280-880	276	281-357	243
280-522	257	280-597	262	280-881	277	281-358	243
280-523	256			280-882	277	281-365	264
280-524	256	280-610	304	280-883	277	281-366	264
280-525	257	280-637	238	280-884	277		
280-526	257	280-637/999-950	238	280-885	277	281-402	243
280-527	256	280-640	238	280-889	259	281-405	502
280-528	258	280-641	238	280-891	258	281-407	237
280-529	256	280-646	239			281-409	243
280-530	256	280-650	236	280-901	236	281-415	243
280-531	258	280-650/056-000	236	280-902	236	281-418	344
280-532	258	280-651	238	280-902/056-000	236	281-419	344
280-533	256	280-653	236	280-903	236	281-421	257
280-534	256	280-654	238	280-904	236	281-422	243
280-537	256	280-654/056-000	238	280-905	236	281-440	613
280-543	257	280-656	239	280-906	236	281-470	346
280-547	262	280-671	236	280-907	236	281-471	346
280-548	262	280-672	236	280-907/999-950	236	281-472	346
280-549	262	280-673/281-410	330	280-912	278	281-482	347
280-550	262	280-673/281-411	330	280-913	278	281-483	347
280-551	262	280-675	531	280-914	278	281-485	347
280-552	262	280-681	236	280-915/281-410	330	281-490	347
280-553	312	280-683	278	280-915/281-411	330	281-492	347
280-554	321	280-684	236	280-916	304		
280-555	321	280-687	236	280-940/281-410	334	281-503	114
280-556	321	280-687/999-950	236	280-940/281-411	334	281-511	302
280-557	262			280-941/281-489	334	281-512	302
280-558	262	280-801/281-411	338	280-941/281-490	334	281-512/281-417	302
280-559	312	280-801/281-413	340	280-941/281-491	334	281-512/281-418	302
280-560	312	280-801/281-414	340	280-941/281-492	334	281-512/281-501	302
280-560/281-434	314	280-801/281-415	340	280-942/281-487	334	281-530	264
280-561	312	280-801/281-416	340	280-942/281-488	334	281-531	264
280-561/281-413	314	280-801/281-417	340	280-943/281-413	334	281-532	264
280-562	322	280-801/281-418	340	280-943/281-434	334		
280-562/281-411	322	280-801/281-420	338	280-946	239	281-610	302
280-562/281-420	326	280-801/281-421	338	280-992	236	281-611	298
280-562/281-434	326	280-803/281-411	339	280-993	236	281-611/281-417	298
280-563	312	280-803/281-413	341	280-994	236	281-611/281-418	298
280-564	312	280-803/281-414	341	280-995	237	281-611/281-541	298
280-564/281-483	314	280-803/281-415	341	280-996	239	281-611/281-542	298
280-565	322	280-803/281-416	341	280-998	238	281-612	298
280-565/281-319	322	280-803/281-417	341			281-612/281-417	298
280-565/281-321	322	280-803/281-418	341	281 Series		281-612/281-418	298
280-566	322	280-803/281-420	339	281-101	502	281-612/281-541	298
280-566/281-496	314	280-803/281-421	339	281-104	502	281-612/281-542	298
280-567	312	280-805	278	281-107	502	281-613	300
280-568	322	280-809/281-413	330			281-613/281-417	300
280-570	316	280-809/281-434	330	281-301	502	281-613/281-418	300
280-570/281-434	315	280-815/281-410	330	281-302	502	281-613/281-541	300
280-571	316	280-815/281-411	330	281-309	299	281-613/281-542	300
280-571/281-413	315	280-816	304	281-311	299	281-616	298
280-572	324	280-826	237	281-312	243	281-619	260
280-572/281-411	324	280-829	278	281-313	243	281-620	260
280-572/281-420	326	280-830	236	281-318	243	281-622	298

Item No.	Page	Item No.	Page	Item No.	Page	Item No.	Page
281 Series		282 Series		282 Series		283 Series	
281-622/281-417	298	282-120	508	282-437/012-000	110	283-335	505
281-622/281-418	298	282-122	508	282-438	110	283-350	247
281-622/281-541	298	282-124	509	282-438/300-000	110	283-351	247
281-622/281-542	298	282-126	508	282-438/301-000	110	283-352	247
281-623	300	282-128	508	282-439	110	283-353	247
281-623/281-417	300	282-128/281-413	509	282-439/011-000	110	283-354	247
281-623/281-418	300	282-128/281-417	509	282-440	110	283-355	247
281-623/281-541	300	282-128/281-418	509	282-442	290	283-357	246
281-623/281-542	300	282-131	506	282-443	290	283-367	246
281-624	299	282-133	506	282-444	290		
281-629	260	282-135	506	282-445	290	283-400	246
281-630	260	282-137	506	282-446	290	283-402	246
281-631	243	282-138	507	282-451	508	283-404	220
281-633/281-410	336	282-139	507	282-452	508	283-405	504
281-633/281-411	336	282-140	507	282-453	508	283-407	220
281-634/281-413	336	282-141	507	282-454	508	283-409	246
281-634/281-434	336			282-457	508	283-414	246
281-635/281-489	336	282-301	503	282-458	508	283-415	246
281-635/281-490	336	282-302	503			283-422	246
281-635/281-491	336	282-308	244	282-638	292		
281-635/281-492	336	282-309	244	282-639	292	283-671	247
281-636/281-487	336	282-311	508	282-640	292	283-672	247
281-636/281-488	336	282-312	508	282-641	292	283-674	247
281-637	243	282-314	506	282-681	244	283-677	247
281-637/999-950	243	282-315	506	282-682	244	283-677/999-950	247
281-651	243	282-322	503	282-684	244		
281-652	242	282-325	244	282-687	244	283-901	246
281-653	242	282-326	244	282-687/999-950	244	283-902	246
281-654	242	282-328	244	282-694	292	283-904	246
281-656	302	282-329	244	282-695	292	283-907	246
281-657	242	282-330	244	282-696	294	283-907/999-950	246
281-657/999-950	242	282-331	244	282-697	292	283-992	246
281-658	242	282-332	503	282-698/281-413	294	283-998	247
281-659	280	282-333	292	282-698/281-429	294		
281-660	280	282-334	292	282-698/281-434	294		
281-663	242	282-339	244	282-698/281-449	294		
281-664	242	282-340	244	282-699	292		
281-665/281-400	332	282-341	244			284 Series	
281-665/281-401	332	282-342	244	282-811	290	284-101	504
281-665/281-410	332	282-357	244	282-821	290	284-104	504
281-665/281-411	332	282-358	244	282-841	290	284-107	504
281-666	280	282-360	290	282-841/049-000	291		
281-668	242	282-361	290	282-860	286	284-301	504
281-672	299	282-365	290	282-865	286	284-302	504
281-673/281-400	332	282-366	290	282-866	287	284-308	245
281-673/281-401	332	282-367	244	282-868	287	284-309	245
281-673/281-410	332	282-368	244	282-870	286	284-322	504
281-673/281-411	332	282-369	605	282-881	110	284-325	245
281-678	242	282-370	290	282-882	110	284-326	245
281-679	242	282-372	290	282-883	110	284-328	245
281-681	242	282-373	290	282-884	110	284-329	245
281-683	280	282-374	290	282-885	110	284-330	245
281-684	242	282-384	286	282-886	110	284-331	245
281-685	242	282-385	286	282-887	110	284-332	504
281-686	242	282-386	286	282-888	110	284-333	505
281-687	242	282-387	286			284-334	235
281-687/999-950	242	282-390	286			284-336	234
		282-391	286	282-901	244	284-339	245
		282-392	286	282-902	244	284-340	245
				282-904	244	284-341	245
				282-907	244	284-342	245
				282-907/999-950	244	284-343	505
				282-992	244	284-344	235
				282-993	244	284-346	234
						284-357	245
						284-358	245
						284-367	245
						284-368	245
				283 Series			
				283-101	504		
				283-104	504	284-400	245
				283-107	504	284-402	245
						284-405	504
						284-409	245
						284-412	249
						284-413	243
						284-414	235
						284-415	226
						284-422	245
						284-621	249
						284-624	249
						284-681	245
						284-682	245
282 Series							
282-101	503						
282-104	503						
282-107	503						

Item Number Index

Item No.	Page	Item No.	Page	Item No.	Page	Item No.	Page
284 Series		285 Series		294 Series		709 Series	
284-684	245	285-1167/999-950	229	294-4425	493	709-119	597
284-687	245	285-1169	228	294-4435	493	709-120	597
284-687/999-950	245	285-1171	228	294-4453	491	709-153	609
		285-1175	228	294-4455	493	709-154	609
284-901	245	285-1176	228	294-4475	493	709-156	610
284-902	245	285-1177	228			709-167	609
284-904	245	285-1178	228	294-5002	489	709-168	609
284-907	245	285-1179	229	294-5003	489	709-169	610
284-907/999-950	245	285-1181	228	294-5004	491	709-170	279
284-992	245	285-1184	228	294-5005	493	709-177	264
284-993	245	285-1185	228	294-5012	489	709-178	480
		285-1187	228	294-5013	489	709-183	609
		285-1187/999-950	228	294-5014	491	709-193	597
		285-1189	228	294-5015	493	709-196	435
				294-5022	489		
285 Series		294 Series		294-5023	489	709-310	345
285-131	220	294-199	495	294-5024	491	709-311	345
285-134	220			294-5025	493	709-312	345
285-135	220	294-364	495	294-5032	489	709-322	345
285-137	220	294-370	495	294-5035	493	709-324	345
285-137/999-950	220	294-375	495	294-5042	489	709-326	345
285-139	220	294-384	495	294-5043	489	709-332	345
285-141	225			294-5044	491	709-334	345
285-143	225	294-4002	489	294-5045	493	709-336	345
285-144	225	294-4003	489	294-5052	489	709-350	576
285-147	225	294-4004	491	294-5053	489	709-352	576
285-147/999-950	225	294-4005	493	294-5055	493		
285-148	225	294-4006	494	294-5072	489	709-581	603
285-150	224	294-4007	494	294-5075	493	709-582	603
285-151	224	294-4012	489	294-5094/4025-000	491	709-583	603
285-154	224	294-4013	489	294-5095/5025-000	493	709-591	603
285-157	224	294-4014	491	294-5095/5026-000	493		
285-157/999-950	224	294-4015	493	294-5095/5027-000	493		
285-159	224	294-4022	489			726 Series	
285-168	227	294-4023	489	294-5113	489	726-121	514
285-169	226	294-4024	491	294-5114	491	726-122	514
285-170	226	294-4025	493	294-5123	489	726-141	514
285-172	613	294-4032	489	294-5124	491	726-142	514
285-173	613	294-4035	493	294-5153	489		
285-175	226	294-4042	489	294-5155	493	726-221	514
285-181	227	294-4043	489	294-5175	493	726-222	514
285-184	227	294-4044	491			726-241	514
285-187	227	294-4045	493	294-5213	491	726-242	514
285-188	227	294-4052	489	294-5214	493		
285-191	226	294-4053	489	294-5215	493	726-321	517
285-194	226	294-4055	493	294-5223	491	726-322	517
285-195	226	294-4072	489	294-5224	493	726-325	517
285-197	226	294-4075	493	294-5225	493	726-326	517
285-197/999-950	226	294-4093/3025-000	489	294-5235	493	726-341	517
285-199	226	294-4094/4025-000	491	294-5253	491	726-342	517
		294-4095/5025-000	493	294-5255	493	726-345	517
		294-4095/5026-000	493	294-5275	493	726-346	517
		294-4095/5027-000	493				
285-401	248			294-5313	491	726-421	515
285-407	226	294-4213	491	294-5314	493	726-441	515
285-416	248	294-4214	493	294-5315	494		
285-420	220	294-4215	493	294-5323	491	726-521	515
285-421	220	294-4223	491	294-5324	493	726-541	515
285-427	220	294-4224	493	294-5325	494		
285-430	220	294-4225	493	294-5335	494	726-601	518
285-435	220	294-4235	493	294-5353	491	726-602	518
285-440	224	294-4253	491	294-5355	494	726-611	518
285-441	224	294-4255	493	294-5375	494	726-612	518
285-442	591	294-4275	493			726-621	518
285-447	224			294-5413	491	726-622	518
285-448	225	294-4313	491	294-5414	491	726-631	519
285-449	224	294-4314	493	294-5415	493	726-632	519
285-450	224	294-4315	493	294-5423	491	726-651	520
285-495	226	294-4323	491	294-5424	491	726-652	520
		294-4324	493	294-5425	493	726-661	520
285-634	248	294-4325	494	294-5435	493	726-662	520
285-635	248	294-4335	494	294-5453	491	726-671	520
285-637	248	294-4353	491	294-5455	493	726-672	520
285-637/999-950	248	294-4355	494	294-5475	493		
		294-4375	494			726-721	516
285-935	220			709 Series		726-741	516
285-950	224	294-4413	491	709-107	514	726-770	521
285-992	248	294-4414	491	709-110	287	726-771	521
285-995	226	294-4415	493	709-111	287	726-780	521
		294-4423	491	709-112	287		
285-1161	229	294-4424	491	709-118	597	726-800	521
285-1163	229						
285-1164	229						
285-1165	229						
285-1167	229						

Item No.	Page	Item No.	Page	Item No.	Page	Item No.	Page
726 Series		727 Series		769 Series		769 Series	
726-801	521	727-234	526	769-110/000-037	414	769-207	364
726-821	516	727-235	527	769-110/000-038	414	769-208/281-410	373
726-841	516	727-236	527	769-110/000-039	415	769-208/281-411	373
		727-237	527	769-110/021-000	409	769-209/281-413	375
726-901	523	727-238	527	769-110/022-000	411	769-209/281-434	375
726-902	514	727-255	526	769-111	408	769-211	362
726-903	522	727-256	526	769-111/000-036	414	769-212	371
726-904	522	727-257	526	769-111/000-037	414	769-213	371
726-906	523	727-258	526	769-111/000-038	414	769-214	368
726-907	523			769-111/000-039	415	769-217	362
				769-111/021-000	409	769-218/281-410	373
				769-111/022-000	411	769-218/281-411	373
727 Series		734 Series				769-219/281-413	375
727-105	528	734-326	147	769-112	408	769-219/281-434	375
727-106	528	734-327	147	769-112/000-036	414	769-221	360
727-107	528	734-328	147	769-112/000-037	414	769-222	370
727-108	528	734-329	147	769-112/000-038	414	769-223	370
727-113	528			769-112/000-039	415	769-227	360
727-114	528	734-430	184	769-112/021-000	409	769-227	360
727-115	528	734-431	184	769-112/022-000	411	769-228/281-410	372
727-116	528			769-113	408	769-228/281-411	372
727-117	528			769-113/000-036	414	769-229/281-413	374
727-119	528			769-113/000-037	414	769-229/281-434	374
727-121	528			769-113/000-038	414	769-231	358
727-122	528			769-113/000-039	415	769-232	370
727-123	528			769-113/021-000	409	769-233	370
727-124	528			769-113/022-000	411	769-237	358
727-125	529			769-114	408	769-238/281-410	372
727-126	529			769-114/000-036	414	769-238/281-411	372
727-127	529			769-114/000-037	414	769-239/281-413	374
727-128	529			769-114/000-038	414	769-239/281-434	374
727-129	528			769-114/000-039	415	769-242	378
727-130	528			769-114/021-000	409	769-243	378
727-131	528			769-114/022-000	411	769-251	366
727-132	528			769-115	408	769-251/000-006	366
727-133	528			769-115/000-036	414	769-257	366
727-134	528			769-115/000-037	414		
727-135	529			769-115/000-038	414	769-301	364
727-136	529			769-115/000-039	415	769-302	364
727-137	529			769-115/021-000	409	769-303	362
727-138	529			769-115/022-000	411	769-304	362
727-155	528			769-121	410	769-305	360
727-156	528			769-122	410	769-306	360
727-157	528			769-123	410	769-307	358
727-158	528			769-124	410	769-308	358
727-159	528			769-125	410	769-309	371
727-160	528			769-126	410	769-310	371
727-161	528			769-127	410	769-311	371
727-162	528			769-128	410	769-312	371
727-163	528			769-129	410	769-313	371
727-164	528			769-130	410	769-314	371
727-165	528			769-131	410	769-315	368
727-166	528			769-132	410	769-316	368
727-167	528			769-133	410	769-317	378
727-168	528			769-134	410	769-318	378
727-169	528			769-135	410	769-319	378
727-170	528			769-151	364	769-320	366
727-197	526			769-156	360	769-321	366
727-198	526			769-161	382		
727-199	526			769-162/769-313	382	769-402	408
				769-163/769-313	382	769-410	220
727-205	526			769-164/769-313	382	769-411	398
727-206	526			769-165/769-313	382	769-412	398
727-207	526			769-171	362	769-413	398
727-208	526			769-171/000-006	362	769-414	398
727-213	526			769-176	358	769-428	408
727-217	526			769-176/000-006	358	769-429	408
727-219	526			769-176/000-012	358	769-430	408
727-220	526			769-181	380	769-431	408
727-221	526			769-182/769-314	380	769-434	399
727-222	526			769-183/769-314	380	769-435	358
727-223	526			769-184/769-314	380	769-436	408
727-224	526			769-185/769-314	380	769-438	358
727-225	527			769-191	384	769-439	358
727-226	527			769-192/769-319	384	769-470	358
727-227	527			769-193/769-319	384	769-471	358
727-228	527			769-194/769-319	384	769-472	358
727-229	526			769-195/769-319	384	769-499	398
727-230	526						
727-231	526			769-201	364	769-501	412
727-232	526			769-202	371	769-501/000-006	412
727-233	526			769-203	371	769-501/000-016	412

Item Number Index

Item No.	Page	Item No.	Page	Item No.	Page	Item No.	Page
769 Series		769 Series		769 Series		773 Series	
769-502	412	769-611/002-000	398	769-643	402	773-498	542
769-502/000-006	412	769-611/004-000	399	769-643/003-000	403		
769-502/000-016	412	769-611/005-000	400	769-643/004-000	404	773-514	541
769-503	412	769-611/006-000	401	769-643/007-000	406		
769-503/000-006	412	769-612	398	769-644	402	773-602	540
769-503/000-016	412	769-612/001-000	398	769-644/003-000	403	773-604	540
769-504	412	769-612/002-000	398	769-644/004-000	404	773-606	540
769-504/000-006	412	769-612/004-000	399	769-644/007-000	406		
769-504/000-016	412	769-612/005-000	400	769-645	402		
769-505	412	769-612/006-000	401	769-645/003-000	403		
769-505/000-006	412	769-613	398	769-645/004-000	404	777 Series	
769-505/000-016	412	769-613/001-000	398	769-645/007-000	406	777-300	271
769-506	412	769-613/002-000	398	769-662	402	777-303	202
769-506/000-006	412	769-613/004-000	399	769-662/003-000	403	777-305	269
769-506/000-016	412	769-613/005-000	400	769-662/004-000	404	777-310	267
769-512	412	769-613/006-000	401	769-663	402		
769-512/000-006	412	769-614	398	769-663/003-000	403	780 Series	
769-512/000-016	412	769-614/001-000	398	769-663/004-000	404	780-317	267
769-513	412	769-614/002-000	398	769-664	402	780-321	271
769-513/000-006	412	769-614/004-000	399	769-664/003-000	403		
769-513/000-016	412	769-614/005-000	400	769-664/004-000	404	780-452	348
769-515	412	769-614/006-000	401	769-665	402	780-453	348
769-515/000-006	412	769-615	398	769-665/003-000	403	780-454	348
769-515/000-016	412	769-615/001-000	398	769-665/004-000	404	780-455	348
		769-615/002-000	398	769-666	402	780-456	348
769-602	398	769-615/004-000	399	769-666/003-000	403	780-457	348
769-602/001-000	398	769-615/005-000	400	769-666/004-000	404	780-458	348
769-602/002-000	398	769-615/006-000	401	769-667	402		
769-602/004-000	399	769-632	402	769-667/003-000	403	780-601	267
769-602/005-000	400	769-632/000-036	402	769-667/004-000	404	780-602	267
769-602/006-000	401	769-632/003-000	403	769-668	402	780-604	267
769-603	398	769-632/003-036	403	769-668/003-000	403	780-607	267
769-603/001-000	398	769-632/004-000	404	769-668/004-000	404	780-607/999-950	267
769-603/002-000	398	769-632/007-000	406	769-669	402	780-613	271
769-603/004-000	399	769-633	402	769-669/003-000	403	780-631	267
769-603/005-000	400	769-633/000-036	402	769-669/004-000	404	780-637	267
769-603/006-000	401	769-633/003-000	403	769-670	402	780-637/999-950	267
769-604	398	769-633/003-036	403	769-670/003-000	403	780-640	267
769-604/001-000	398	769-633/004-000	404	769-670/004-000	404	780-651	267
769-604/002-000	398	769-633/007-000	406	769-671	402	780-654	267
769-604/004-000	399	769-634	402	769-671/003-000	403		
769-604/005-000	400	769-634/000-036	402	769-671/004-000	404	780-992	267
769-604/006-000	401	769-634/003-000	403	769-672	402	780-993	267
769-605	398	769-634/003-036	403	769-672/003-000	403		
769-605/001-000	398	769-634/004-000	404	769-672/004-000	404	781 Series	
769-605/002-000	398	769-634/007-000	406	769-673	402	781-452	348
769-605/004-000	399	769-635	402	769-673/003-000	403	781-453	348
769-605/005-000	400	769-635/000-036	402	769-673/004-000	404	781-454	348
769-605/006-000	401	769-635/003-000	403	769-674	402	781-455	348
769-606	398	769-635/003-036	403	769-674/003-000	403	781-456	348
769-606/001-000	398	769-635/004-000	404	769-674/004-000	404		
769-606/002-000	398	769-635/007-000	406	769-675	402	781-601	268
769-606/004-000	399	769-636	402	769-675/003-000	403	781-604	268
769-606/005-000	400	769-636/003-000	403	769-675/004-000	404	781-607	268
769-606/006-000	401	769-636/003-036	403			781-607/999-950	268
769-607	398	769-636/004-000	404	769-1602	416	781-613	271
769-607/001-000	398	769-636/007-000	406	769-1603	416	781-623	271
769-607/002-000	398	769-637	402	769-1604	416	781-631	268
769-607/004-000	399	769-637/003-000	403	769-1605	416	781-637	268
769-607/005-000	400	769-637/004-000	404	769-1606	416	781-637/999-950	268
769-607/006-000	401	769-637/007-000	406	769-1607	416	781-643	271
769-608	398	769-638	402	769-1608	416	781-651	268
769-608/001-000	398	769-638/003-000	403	769-1609	416	781-653	271
769-608/002-000	398	769-638/004-000	404	769-1610	416		
769-608/004-000	399	769-638/007-000	406	769-1611	416	781-992	268
769-608/005-000	400	769-639	402	769-1612	416	781-993	268
769-608/006-000	401	769-639/003-000	403	769-1613	416		
769-609	398	769-639/004-000	404	769-1614	416		
769-609/001-000	398	769-639/007-000	406	769-1615	416	782 Series	
769-609/002-000	398	769-640	402			782-300	272
769-609/004-000	399	769-640/003-000	403	773 Series		782-317	269
769-609/005-000	400	769-640/004-000	404	773-173	541	782-321	272
769-609/006-000	401	769-640/007-000	406				
769-610	398	769-641	402	773-331	543	782-601	269
769-610/001-000	398	769-641/003-000	403	773-332	539	782-604	269
769-610/002-000	398	769-641/004-000	404			782-607	269
769-610/004-000	399	769-641/007-000	406	773-492	542	782-607/999-950	269
769-610/005-000	400	769-642	402	773-493	542	782-613	272
769-610/006-000	401	769-642/003-000	403	773-494	542	782-623	272
769-611	398	769-642/004-000	404	773-496	542		
769-611/001-000	398	769-642/007-000	406			782-992	269

Item Number Index

Item No.	Page	Item No.	Page	Item No.	Page	Item No.	Page
869 Series		869 Series		870 Series		870 Series	
869-102	449	869-328	450	870-504	432	870-946	430
869-103	449	869-329	450	870-507	432	870-947	430
869-104	449	869-331	450	870-508	432	870-948	430
869-105	449	869-334	450	870-509	432	870-949	430
869-106	449	869-337	450	870-517	432	870-951	434
869-107	449	869-339	450	870-518	432	870-957/999-950	434
869-108	449	869-341	450	870-519	432	870-961	432
869-109	449	869-344	450	870-527	432	870-967/999-950	432
869-110	449	869-347	450	870-531	433		
869-111	449	869-349	450	870-532	433	870-1131	390
869-112	449	869-351	450	870-533	433	870-1137	390
869-132	449	869-354	450	870-534	433	870-1138	390
869-133	449	869-357	450	870-535	433	870-1148	390
869-134	449	869-359	450	870-536	433	870-1149	390
869-135	449	869-375	450	870-537	433		
869-136	449	869-377	450	870-538	433	873 Series	
869-137	449	869-378	450	870-539	433	873-902	566
869-138	449	869-379	450	870-540/281-410	436	873-903	566
869-139	449	869-385	450	870-540/281-411	436	873-953	567
869-140	449	869-387	450	870-541/281-489	436		
869-141	449	869-388	450	870-541/281-490	436		
869-142	449	869-389	450	870-541/281-491	436	880 Series	
869-152	449	869-395	450	870-541/281-492	436	880-308	240
869-153	449	869-397	450	870-542/281-487	436	880-309	240
869-154	449	869-398	450	870-542/281-488	436	880-325	240
869-155	449	869-399	450	870-543/281-413	436	880-326	240
869-156	449			870-543/281-434	436	880-328	240
869-157	449	870 Series		870-551	434	880-329	240
869-158	449	870-101	388	870-553	434	880-339	240
869-159	449	870-102	388	870-556	434	880-340	240
869-160	449	870-103	388	870-557	434	880-344	240
869-161	449	870-104	388	870-558	434	880-345	240
869-162	449	870-107	388	870-559	434	880-346	240
869-182	449	870-108	388	870-567	434	880-347	240
869-183	449	870-109	388	870-568	434		
869-184	449	870-117	388	870-569	434	880-681/999-940	240
869-185	449	870-118	388	870-573	433	880-682/999-940	240
869-186	449	870-119	388	870-574	433	880-684/999-940	240
869-187	449	870-127	388	870-577	434	880-687/999-940	240
869-188	449	870-131	394	870-590/281-410	438		
869-189	449	870-137	394	870-590/281-411	438	880-831/999-940	240
869-190	449	870-138	394	870-590/281-675	438	880-832/999-940	240
869-191	449	870-148	394	870-590/281-676	438	880-834/999-940	240
869-192	449	870-149	394	870-593/281-413	438	880-837/999-940	240
		870-151	392	870-593/281-434	438		
869-202	449	870-157	392	870-596/281-673	438	880-901/999-940	240
869-203	449	870-158	392	870-596/281-674	438	880-902/999-940	240
869-204	449	870-168	392			880-904/999-940	240
869-205	449	870-169	392	870-681	430	880-907/999-940	240
869-206	449	870-182	435	870-682	430		
869-207	449	870-183	435	870-684	430		
869-208	449	870-184	435	870-687	430		
869-209	449					887 Series	
869-210	449	870-402	388	870-826	431	887-910	562
869-211	449	870-403	388	870-831	430	887-912	562
869-212	449	870-404	388	870-832	430	887-913	562
869-232	449	870-405	388	870-834	430	887-917	563
869-233	449	870-405/011-000	435	870-837	430	887-918	563
869-234	449	870-406	388			887-920	563
869-235	449	870-406/020-000	435	870-901	430	887-921	562
869-236	449	870-407	388	870-902	430	887-952	564
869-237	449	870-407/011-000	435	870-904	430	887-953	564
869-238	449	870-408	388	870-907	430	887-955	564
869-239	449	870-409	388	870-907/999-950	430	887-957	565
869-240	449	870-409/011-000	435	870-909	430	887-959	565
869-241	449	870-410	388	870-911	431	887-960	565
869-242	449	870-425	441	870-912	431		
		870-426	441	870-914	431		
869-301	450	870-427	441	870-917	431	2000 Series	
869-304	450	870-433	388	870-919	431	2000-115	46
869-307	450	870-434	388	870-923	430	2000-121	595
869-309	450	870-435	388	870-924	430		
869-311	451	870-436	388	870-925	430	2000-402	32
869-314	451	870-437	388	870-926	430	2000-402/000-005	152
869-316	451	870-438	388	870-926	430	2000-402/000-006	152
869-317	451	870-439	388	870-928	430	2000-402/000-018	152
869-319	451	870-440	388	870-929	430	2000-403	32
869-321	450			870-929	430	2000-403/000-005	152
869-324	450	870-501	432	870-933	430	2000-403/000-006	152
869-326	450	870-502	432	870-934	430	2000-404	32
869-327	450	870-503	432	870-943	430	2000-404/000-005	152
				870-944	430	2000-404/000-006	152

Item Number Index

Item No.	Page	Item No.	Page	Item No.	Page	Item No.	Page
2002 Series		2002 Series		2002 Series		2002 Series	
2002-800/1000-411	138	2002-1674	82	2002-2207	64	2002-2608	72
2002-800/1000-541	140	2002-1674/401-000	82	2002-2207/099-000	66	2002-2609	72
2002-800/1000-542	140	2002-1681	88	2002-2208	64	2002-2611	75
2002-800/1000-836	140	2002-1691	82	2002-2208/099-000	66	2002-2611/1000-541	75
2002-810	142	2002-1692	82	2002-2209	64	2002-2611/1000-542	75
2002-820	142			2002-2209/099-000	66	2002-2611/1000-836	75
2002-880	139	2002-1701	84	2002-2211/1000-410	134	2002-2611/1000-867	75
2002-880/1000-411	139	2002-1702	84	2002-2211/1000-411	134	2002-2612	75
2002-880/1000-541	141	2002-1704	84	2002-2213/1000-487	134	2002-2647	72
2002-880/1000-542	141	2002-1707	84	2002-2213/1000-488	134	2002-2657	72
2002-880/1000-836	141	2002-1711	90	2002-2214/1000-489	134	2002-2661	74
		2002-1711/1000-541	90	2002-2214/1000-490	134	2002-2662	74
2002-991	90	2002-1711/1000-542	90	2002-2214/1000-491	134	2002-2667	74
2002-992	90	2002-1711/1000-836	90	2002-2214/1000-492	134	2002-2671	74
		2002-1711/1000-867	90	2002-2217	64	2002-2672	74
2002-1091	75	2002-1761	114	2002-2217/099-000	66	2002-2678	74
2002-1092	75	2002-1771	84	2002-2218	65	2002-2691	73
		2002-1771/401-000	84	2002-2218/099-000	67	2002-2692	73
2002-1201	50	2002-1772	84	2002-2221/1000-413	134		
2002-1202	50	2002-1772/401-000	84	2002-2221/1000-434	134	2002-2701	69
2002-1203	50	2002-1774	84	2002-2227	64	2002-2702	69
2002-1204	50	2002-1774/401-000	84	2002-2227/099-000	66	2002-2703	69
2002-1205	50	2002-1781	88	2002-2228	65	2002-2704	69
2002-1206	50	2002-1791	84	2002-2228/099-000	67	2002-2707	69
2002-1207	50	2002-1792	84	2002-2231	64	2002-2707/999-950	69
2002-1208	50			2002-2231/099-000	66	2002-2708	69
2002-1211/1000-410	130	2002-1801	86	2002-2232	64	2002-2709	69
2002-1211/1000-411	130	2002-1802	86	2002-2232/099-000	66	2002-2717	69
2002-1291	34	2002-1804	86	2002-2233	64	2002-2727	69
2002-1292	34	2002-1811	90	2002-2233/099-000	66	2002-2791	69
2002-1293	34	2002-1811/1000-541	90	2002-2234	64	2002-2792	69
2002-1294	34	2002-1811/1000-542	90	2002-2234/099-000	66		
		2002-1811/1000-836	90	2002-2237	64	2002-2941	208
2002-1301	50	2002-1811/1000-867	90	2002-2237/099-000	66	2002-2951	80
2002-1302	50	2002-1861	114	2002-2238	64	2002-2952	80
2002-1303	50	2002-1871	86	2002-2238/099-000	66	2002-2954	80
2002-1304	50	2002-1871/401-000	86	2002-2239	64	2002-2958	80
2002-1305	50	2002-1872	86	2002-2239/099-000	66	2002-2959	80
2002-1306	50	2002-1872/401-000	86	2002-2247	64	2002-2961	114
2002-1307	50	2002-1874	86	2002-2247/099-000	66	2002-2963	114
2002-1308	50	2002-1874/401-000	86	2002-2248	65	2002-2971	80
2002-1311/1000-410	130	2002-1881	88	2002-2248/099-000	67	2002-2972	80
2002-1311/1000-411	130	2002-1891	86	2002-2257	64	2002-2974	80
2002-1321/1000-413	130	2002-1892	86	2002-2257/099-000	66	2002-2991	80
2002-1321/1000-434	130			2002-2258	65	2002-2992	80
2002-1391	34	2002-1901	92	2002-2258/099-000	67		
2002-1392	34	2002-1902	92	2002-2291	65	2002-3201	76
2002-1393	34	2002-1904	92	2002-2292	65	2002-3203	76
2002-1394	34	2002-1907	92	2002-2295	68	2002-3204	76
		2002-1911	96	2002-2296	68	2002-3207	76
2002-1401	50	2002-1911/1000-541	96			2002-3208	76
2002-1402	50	2002-1911/1000-542	96	2002-2401	70	2002-3209	76
2002-1403	50	2002-1911/1000-836	96	2002-2402	70	2002-3211/1000-410	136
2002-1404	50	2002-1911/1000-867	96	2002-2403	70	2002-3211/1000-411	136
2002-1405	50	2002-1961	114	2002-2404	70	2002-3211/1000-675	136
2002-1406	50	2002-1971	92	2002-2407	70	2002-3211/1000-676	136
2002-1407	50	2002-1971/401-000	92	2002-2408	70	2002-3212/1000-673	136
2002-1408	50	2002-1972	92	2002-2409	70	2002-3212/1000-674	136
2002-1411/1000-410	130	2002-1972/401-000	92	2002-2417	70	2002-3217	76
2002-1411/1000-411	130	2002-1974	92	2002-2418	71	2002-3218	77
2002-1421/1000-413	130	2002-1974/401-000	92	2002-2427	70	2002-3221/1000-413	136
2002-1421/1000-434	130	2002-1981	95	2002-2428	71	2002-3221/1000-434	136
2002-1441	51	2002-1981/1000-413	94	2002-2431	70	2002-3227	76
2002-1491	34	2002-1981/1000-414	94	2002-2432	70	2002-3228	77
2002-1492	34	2002-1981/1000-429	94	2002-2433	70	2002-3231	76
2002-1493	34	2002-1981/1000-434	94	2002-2434	70	2002-3233	76
2002-1494	34	2002-1981/1000-435	94	2002-2437	70	2002-3234	76
		2002-1981/1000-449	94	2002-2438	70	2002-3237	76
2002-1601	82	2002-1991	92	2002-2439	70	2002-3238	76
2002-1602	82	2002-1992	92	2002-2447	70	2002-3239	76
2002-1604	82			2002-2448	71	2002-3247	76
2002-1611	90	2002-2201	64	2002-2457	70	2002-3248	77
2002-1611/1000-541	90	2002-2201/097-000	68	2002-2458	71	2002-3257	76
2002-1611/1000-542	90	2002-2201/098-000	68	2002-2491	71	2002-3258	77
2002-1611/1000-836	90	2002-2201/099-000	66	2002-2492	71	2002-3291	77
2002-1611/1000-867	90	2002-2202	64			2002-3292	77
2002-1661	114	2002-2202/099-000	66	2002-2601	72		
2002-1671	82	2002-2203	64	2002-2602	72	2002-4101	78
2002-1671/401-000	82	2002-2203/099-000	66	2002-2603	72	2002-4111	78
2002-1672	82	2002-2204	64	2002-2604	72	2002-4127	78
2002-1672/401-000	82	2002-2204/099-000	66	2002-2607	72	2002-4131	78

Item No.	Page	Item No.	Page	Item No.	Page	Item No.	Page
2002 Series		2004 Series		2005 Series		2006 Series	
2002-4141	78	2004-406	38	2005-7692	210	2006-1621/1000-867	102
2002-4157	78	2004-406/020-000	155			2006-1631	102
2002-4191	78	2004-407	38			2006-1631/099-000	103
2002-4192	78	2004-408	38	2006 Series		2006-1631/1000-541	102
		2004-409	38	2006-115	27	2006-1631/1000-542	102
2002-6301	52	2004-410	38	2006-191	159	2006-1631/1000-836	102
2002-6302	52	2004-433	38			2006-1631/1000-859	102
2002-6303	52	2004-434	38	2006-401	158	2006-1631/1000-867	102
2002-6304	52	2004-435	38	2006-401/000-050	158	2006-1631/1099-541	103
2002-6305	52	2004-436	38	2006-402	27	2006-1631/1099-542	103
2002-6306	52	2004-437	38	2006-403	27	2006-1631/1099-836	103
2002-6307	52	2004-438	38	2006-404	27	2006-1631/1099-859	103
2002-6308	52	2004-439	38	2006-405	27	2006-1631/1099-867	103
2002-6391	52	2004-440	38	2006-405/011-000	155	2006-1661	116
2002-6392	52			2006-433	27	2006-1664	116
		2004-511	148	2006-434	27	2006-1671	98
2002-6401	53	2004-541	148	2006-435	27	2006-1671/1000-848	98
2002-6402	53	2004-549	148	2006-451	158	2006-1671/1000-849	98
2002-6403	53	2004-552	148	2006-499	48	2006-1671/1000-850	98
2002-6404	53	2004-553	148			2006-1671/1000-851	98
2002-6405	53	2004-554	148	2006-511	148	2006-1674	98
2002-6406	53	2004-555	148	2006-549	148	2006-1681	101
2002-6407	53					2006-1681/1000-413	100
		2004-911	114	2006-911	116	2006-1681/1000-414	100
2002-7111	212	2004-911/1000-541	114	2006-911/1000-541	116	2006-1681/1000-429	100
2002-7114	212	2004-911/1000-542	114	2006-911/1000-542	116	2006-1681/1000-434	100
2002-7192	212	2004-911/1000-836	114	2006-911/1000-836	116	2006-1681/1000-435	100
		2004-911/1000-867	114	2006-911/1000-867	116	2006-1681/1000-449	100
2002-7211	212			2006-921	116	2006-1691	98
2002-7214	212	2004-1201	54	2006-921/1000-541	116	2006-1692	98
2002-7292	212	2004-1202	54	2006-921/1000-542	116	2006-1695	116
		2004-1203	54	2006-921/1000-836	116	2006-1696	116
		2004-1204	54	2006-921/1000-859	116		
2003 Series		2004-1205	54	2006-921/1000-867	116	2006-7111	212
2003-499	204	2004-1206	54	2006-931	116	2006-7114	212
		2004-1207	54	2006-931/099-000	116	2006-7192	212
2003-500	204	2004-1211/1000-400	132	2006-931/1000-541	116		
		2004-1211/1000-401	132	2006-931/1000-542	116	2006-7300	212
2003-911	208	2004-1291	38	2006-931/1000-836	116		
2003-911/1000-923	208	2004-1292	38	2006-931/1000-859	116	2006-8401	104
		2004-1293	38	2006-931/1000-867	116		
2003-6640	206	2004-1294	38	2006-931/1099-541	117	2006-8601	104
2003-6641	204			2006-931/1099-542	117	2006-8604	104
2003-6642	204	2004-1301	54	2006-931/1099-836	117	2006-8661	104
2003-6643	206	2004-1302	54	2006-931/1099-859	117	2006-8664	104
2003-6644	204	2004-1303	54	2006-931/1099-867	117	2006-8671	104
2003-6645	204	2004-1304	54	2006-991	102	2006-8674	104
2003-6646	204	2004-1305	54	2006-992	102	2006-8691	104
2003-6649	204	2004-1306	54			2006-8692	104
2003-6650	204	2004-1307	54	2006-1201	56		
2003-6651	204	2004-1311/1000-400	132	2006-1202	56	2007 Series	
2003-6660	206	2004-1311/1000-401	132	2006-1204	56	2007-8442	110
2003-6661	206	2004-1391	38	2006-1207	56	2007-8443	110
2003-6692	204	2004-1392	38	2006-1208	56	2007-8444	110
2003-6693	206	2004-1393	38	2006-1291	40	2007-8445	110
2003-6694	206	2004-1394	38	2006-1292	40	2007-8446	110
				2006-1293	40	2007-8447	110
2003-7300	202	2004-1401	54	2006-1294	40	2007-8448	110
		2004-1402	54				
2003-7640	202	2004-1403	54	2006-1301	56	2007-8801	110
2003-7641	202	2004-1404	54	2006-1302	56	2007-8804	110
2003-7642	202	2004-1405	54	2006-1304	56	2007-8807	111
2003-7645	202	2004-1406	54	2006-1305	56	2007-8811	110
2003-7646	202	2004-1407	54	2006-1307	56	2007-8821	110
2003-7649	202	2004-1408	54	2006-1391	40	2007-8821	110
2003-7650	202	2004-1411/1000-400	132	2006-1392	40	2007-8873	112
2003-7651	202	2004-1411/1000-401	132	2006-1393	40	2007-8876	113
2003-7659	202	2004-1491	38	2006-1394	40	2007-8891	110
2003-7692	202	2004-1492	38			2007-8892	110
		2004-1493	38	2006-1601	98	2007-8893	110
		2004-1494	38	2006-1604	98	2007-8894	110
				2006-1611	102	2007-8899	110
				2006-1611/1000-541	102		
2004 Series		2005 Series		2006-1611/1000-542	102	2009 Series	
2004-115	54	2005-7300	210	2006-1611/1000-836	102	2009-110	588
2004-171	38			2006-1611/1000-867	102	2009-113	588
2004-172	38			2006-1621	102	2009-114	588
		2005-7641	210	2006-1621/1000-541	102	2009-115	588
2004-402	38	2005-7642	210	2006-1621/1000-542	102	2009-145	589
2004-403	38	2005-7645	210	2006-1621/1000-836	102	2009-163	597
2004-404	38	2005-7646	210	2006-1621/1000-859	102	2009-174	151
2004-405	38	2005-7649	210				
2004-405/011-000	155						

Item No.	Page	Item No.	Page	Item No.	Page	Item No.	Page
2020 Series		2022 Series		2022 Series		2022 Series	
2020-214/000-038	174	2022-101/122-016	190	2022-109/135-000	190	2022-1304/999-953	192
2020-214/000-039	175	2022-101/132-000	190	2022-109/145-000	190	2022-1307	180
2020-214/125-000	178	2022-101/132-006	190	2022-110	184	2022-1307/999-953	192
2020-214/135-000	178	2022-101/132-016	190	2022-110/000-036	188	2022-1391	180
2020-214/145-000	178	2022-101/142-000	190	2022-110/000-037	188	2022-1392	180
2020-215	168	2022-101/142-006	190	2022-110/000-038	188		
2020-215/000-036	174	2022-101/142-016	190	2022-110/000-039	189	2022-1401	180
2020-215/000-037	174	2022-102	184	2022-110/123-000	190	2022-1401/999-953	192
2020-215/000-038	174	2022-102/000-016	184	2022-110/135-000	190	2022-1402	180
2020-215/000-039	175	2022-102/122-000	190	2022-110/145-000	190	2022-1404	180
2020-215/125-000	178	2022-102/132-000	190	2022-111	184	2022-1404/999-953	192
2020-215/135-000	178	2022-102/142-000	190	2022-111/000-036	188	2022-1407	180
2020-215/145-000	178	2022-102/999-953	196	2022-111/000-037	188	2022-1407/999-953	192
2020-261	170	2022-103	184	2022-111/000-038	188	2022-1491	180
2020-264	170	2022-103/000-036	188	2022-111/000-039	189	2022-1492	180
2020-267	170	2022-103/000-037	188	2022-111/126-000	190		
2020-281	170	2022-103/000-038	188	2022-111/136-000	190	2022-2201	182
2020-284	170	2022-103/000-038/999-953	197	2022-111/146-000	190	2022-2201/999-953	194
2020-287	170	2022-103/000-039	189	2022-112	184	2022-2202	182
		2022-103/000-039/999-953	197	2022-112/000-036	188	2022-2202/999-953	194
2020-1201	164	2022-103/123-000	190	2022-112/000-037	188	2022-2203	182
2020-1204	164	2022-103/133-000	190	2022-112/000-038	188	2022-2203/999-953	194
2020-1207	164	2022-103/143-000	190	2022-112/000-039	189	2022-2204	182
2020-1291	164	2022-103/999-953	196	2022-112/126-000	190	2022-2204/999-953	194
2020-1292	164	2022-104	184	2022-112/136-000	190	2022-2207	182
		2022-104/000-036	188	2022-112/146-000	190	2022-2207/999-953	194
2020-1301	164	2022-104/000-037	188	2022-113	184	2022-2208	182
2020-1304	164	2022-104/000-038	188	2022-113/000-036	188	2022-2208/999-953	194
2020-1307	164	2022-104/000-038/999-953	197	2022-113/000-037	188	2022-2209	182
2020-1391	164	2022-104/000-039	189	2022-113/000-038	188	2022-2209/999-953	194
2020-1392	164	2022-104/000-039/999-953	197	2022-113/000-039	189	2022-2217	182
		2022-104/123-000	190	2022-113/126-000	190	2022-2217/999-953	194
2020-1401	164	2022-104/133-000	190	2022-113/136-000	190	2022-2227	182
2020-1404	164	2022-104/143-000	190	2022-113/146-000	190	2022-2227/999-953	194
2020-1407	164	2022-104/999-953	196	2022-114	184	2022-2231	182
2020-1491	164	2022-105	184	2022-114/000-036	188	2022-2231/999-953	194
2020-1492	164	2022-105/000-036	188	2022-114/000-037	188	2022-2232	182
		2022-105/000-037	188	2022-114/000-038	188	2022-2232/999-953	194
2020-2201	166	2022-105/000-038	188	2022-114/000-039	189	2022-2233	182
2020-2202	166	2022-105/000-038/999-953	197	2022-114/126-000	190	2022-2233/999-953	194
2020-2203	166	2022-105/000-039	189	2022-114/136-000	190	2022-2234	182
2020-2204	166	2022-105/000-039/999-953	197	2022-114/146-000	190	2022-2234/999-953	194
2020-2207	166	2022-105/123-000	190	2022-115	184	2022-2237	182
2020-2208	166	2022-105/134-000	190	2022-115/000-036	188	2022-2237/999-953	194
2020-2209	166	2022-105/144-000	190	2022-115/000-037	188	2022-2238	182
2020-2217	166	2022-105/999-953	196	2022-115/000-038	188	2022-2238/999-953	194
2020-2227	166	2022-106	184	2022-115/000-039	189	2022-2239	182
2020-2231	166	2022-106/000-036	188	2022-115/127-000	190	2022-2239/999-953	194
2020-2232	166	2022-106/000-037	188	2022-115/137-000	190	2022-2247	182
2020-2233	166	2022-106/000-038	188	2022-115/147-000	190	2022-2247/999-953	194
2020-2234	166	2022-106/000-038/999-953	197	2022-141	168	2022-2257	182
2020-2237	166	2022-106/000-039	189	2022-142	168	2022-2257/999-953	194
2020-2238	166	2022-106/000-039/999-953	197	2022-151	168	2022-2291	183
2020-2239	166	2022-106/123-000	190	2022-152	168	2022-2292	183
2020-2247	166	2022-106/134-000	190	2022-161	186		
2020-2257	166	2022-106/144-000	190	2022-162	186	2042 Series	
2020-2291	167	2022-106/999-953	196	2022-164	186	2042-321	144
2020-2292	167	2022-107	184	2022-167	186	2042-331	144
		2022-107/000-036	188	2022-171	186	2042-341	144
2020-5311	125	2022-107/000-037	188	2022-172	186	2042-351	144
2020-5311/1102-950	125	2022-107/000-038	188	2022-174	186		
2020-5317/102-000	127	2022-107/000-039	189	2022-177	186	2102 Series	
2020-5317/1102-950	127	2022-107/123-000	190	2022-181	186	2102-1201	26
2020-5372	125	2022-107/135-000	190	2022-182	186	2102-1204	26
2020-5372/1102-953	125	2022-107/145-000	190	2022-184	186	2102-1207	26
2020-5377/102-000	127	2022-107/999-953	196	2022-187	186	2102-1291	26
2020-5391	125	2022-108	184			2102-1292	26
		2022-108/000-036	188	2022-1201	180		
2020-5417	126	2022-108/000-037	188	2022-1201/999-953	192	2102-1301	26
2020-5417/1102-950	126	2022-108/000-038	188	2022-1202	180	2102-1304	26
2020-5477	126	2022-108/000-039	189	2022-1204	180	2102-1307	26
2020-5477/1102-953	126	2022-108/123-000	190	2022-1204/999-953	192	2102-1391	26
2020-5491	126	2022-108/135-000	190	2022-1207	180	2102-1392	26
		2022-108/145-000	190	2022-1207/999-953	192		
		2022-108/999-953	196	2022-1291	180	2102-5201	29
		2022-109	184	2022-1292	180	2102-5204	29
		2022-109/000-036	188			2102-5207	29
2022 Series		2022-109/000-037	188	2022-1301	180		
2022-100	180	2022-109/000-037	188	2022-1301/999-953	192	2102-5301	29
2022-101	184	2022-109/000-038	188	2022-1302	180	2102-5304	29
2022-101/000-016	184	2022-109/000-039	189	2022-1304	180	2102-5307	29
2022-101/122-000	190	2022-109/123-000	190				
2022-101/122-006	190						

Item Number Index

Item No.	Page	Item No.	Page	Item No.	Page	Item No.	Page
2106 Series		2202 Series					
2106-1201	27	2202-1401	36				
2106-1204	27	2202-1404	36				
2106-1207	27	2202-1407	36				
2106-1291	27						
2106-1292	27	2204 Series					
		2204-1201	38				
2106-1301	27	2204-1204	38				
2106-1304	27	2204-1207	38				
2106-1307	27						
2106-1391	27	2204-1301	38				
2106-1392	27	2204-1304	38				
		2204-1307	38				
2106-5201	30						
2106-5204	30	2204-1401	38				
2106-5207	30	2204-1404	38				
		2204-1407	38				
2106-5301	30						
2106-5304	30	2206 Series					
2106-5307	30	2206-1201	40				
		2206-1204	40				
2116 Series		2206-1207	40				
2116-1201	28						
2116-1204	28	2206-1301	40				
2116-1207	28	2206-1304	40				
2116-1291	28	2206-1307	40				
2116-1292	28						
		2210 Series					
2116-1301	28	2210-1201	41				
2116-1304	28	2210-1204	41				
2116-1307	28	2210-1207	41				
2116-1391	28						
2116-1392	28	2210-1301	41				
		2210-1304	41				
2116-5201	31	2210-1307	41				
2116-5204	31						
2116-5207	31	2216 Series					
		2216-1201	42				
2116-5301	31	2216-1204	42				
2116-5304	31	2216-1207	42				
2116-5307	31						
		2216-1301	42				
2200 Series		2216-1304	42				
2200-1201	32	2216-1307	42				
2200-1204	32						
2200-1207	32	2273 Series					
		2273-202	537				
2200-1301	32	2273-203	537				
2200-1304	32	2273-204	537				
2200-1307	32	2273-205	537				
		2273-208	537				
2200-1401	32						
2200-1404	32	2273-500	537				
2200-1407	32						
		2201 Series					
2201-1201	34	2201-1201	34				
2201-1204	34	2201-1204	34				
2201-1207	34	2201-1207	34				
2201-1301	34	2201-1301	34				
2201-1304	34	2201-1304	34				
2201-1307	34	2201-1307	34				
2201-1401	34	2201-1401	34				
2201-1404	34	2201-1404	34				
2201-1407	34	2201-1407	34				
2202 Series		2202 Series					
2202-1201	36	2202-1201	36				
2202-1203	36	2202-1203	36				
2202-1204	36	2202-1204	36				
2202-1205	36	2202-1205	36				
2202-1207	36	2202-1207	36				
2202-1301	36	2202-1301	36				
2202-1304	36	2202-1304	36				
2202-1307	36	2202-1307	36				

Item No.	Page	Item No.	Page	Item No.	Page	Item No.	Page

WAGO Worldwide Companies and Representatives

Sold & Serviced By:



Toll Free Phone (877) SERV098
www.electromate.com
sales@electromate.com

Sold & Serviced By:



Toll Free Phone (877) SERV098
www.electromate.com
sales@electromate.com

Notes

A large grid of graph paper, consisting of 20 columns and 40 rows of small squares, intended for writing notes. The grid is empty.

Notes

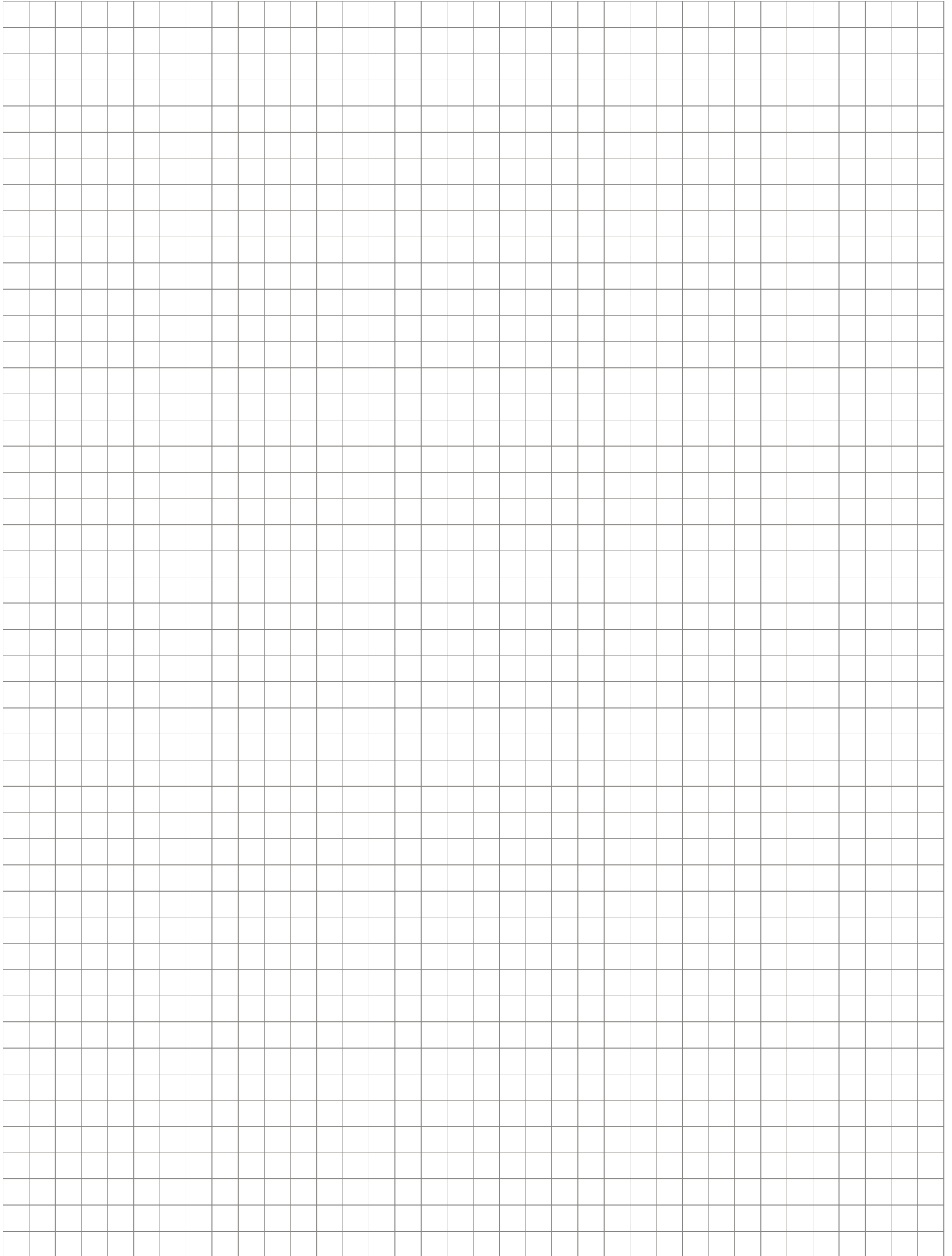

Sold & Serviced By:



Toll Free Phone (877) SERV098

www.electromate.com

sales@electromate.com

Sold & Serviced By:



Toll Free Phone (877) SERV098

www.electromate.com

sales@electromate.com