

FLANGE MOUNT SUPERNUTS™

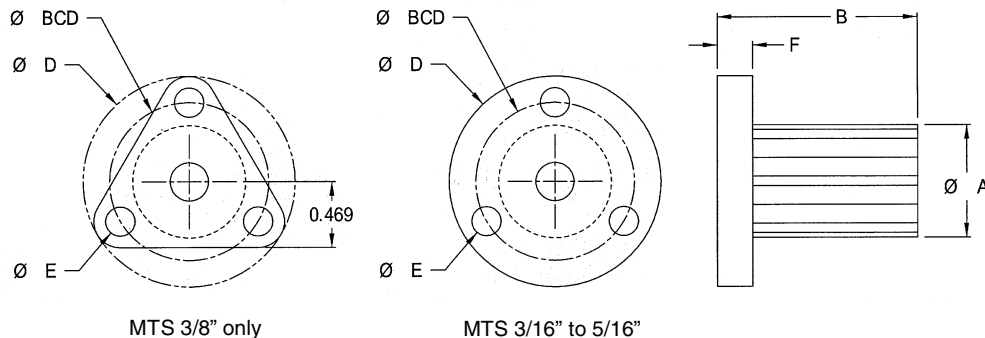

MTS INTEGRAL FLANGE MOUNT

The MTS models provide the excellent lubricity and dimensional stability of our proprietary Acetal with the convenience of an integral flange.



MTS 3/16\"/>

DIA.	LEAD	PART NO.	SUPERNUT DIMENSIONS						DESIGN LOAD	EFFICIENCY %	DRAG TORQUE
			A	B	D	E	F	BCD			
3/16"	0.050	MTS1820	0.50	0.75	1.00	0.14	0.15	0.75	10 lbs	49	Free Wheeling
1/4"	0.050	MTS2520	0.50	0.75	1.00	0.14	0.15	0.75	25 lbs	41	
	0.063	MTS2516								48	
	0.250	MTS4-2516								76	
	0.500	MTS7-2514								81	
5/16"	0.083	MTS3112	0.50	0.75	1.00	0.14	0.15	0.75	50 lbs	49	
	0.167	MTS2-3112								65	
	0.250	MTS2-3108								72	
	0.500	MTS4-3108								80	
3/8"*	0.063	MTS3716	0.71	1.50	1.5	0.20	0.20	1.125	60 lbs	36	
	2mm	MTS37x2M								42	
	0.083	MTS3712								44	
	0.100	MTS3710								49	
	0.125	MTS3708								53	
	0.167	MTS2-3712								60	
	0.200	MTS2-3710								65	
	0.250	MTS2-3708								68	
	0.375	MTS4-3711								75	
	0.500	MTS4-3708								79	
	1.000	MTS5-3705								82	
1.200	MTS5-3704	82									

*3/8" to 7/16" with tri-flange.

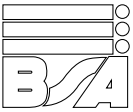

FLANGE MOUNT SUPERNUTS™



**MTS
10MM TO 3/4"
DIAMETER**

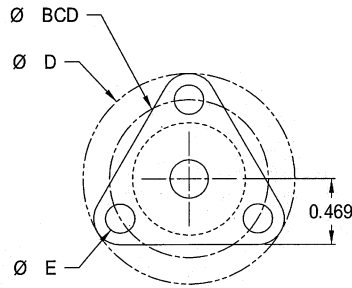

MTS 10mm to 7/16" only

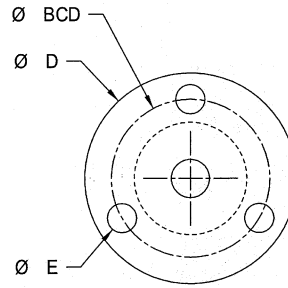

MTS 12mm to 3/4"

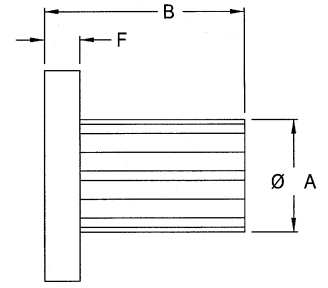

DIA.	LEAD	PART NO.	SUPERNUT DIMENSIONS						DESIGN LOAD	EFFICIENCY %	DRAG TORQUE
			A	B	D	E	F	BCD			
10mm*	2mm	MTS10x2M	0.71	1.50	1.5	0.20	0.200	1.125	75 lbs	41	Free Wheeling
	3mm	MTS10x3M								53	
	6mm	MTS4-10x1.5M								67	
	20mm	MTS6-10x3.3M								81	
7/16"*	0.125	MTS2-4316	0.71	1.50	1.5	0.20	0.200	1.125	75 lbs	55	
	0.250	MTS2-4308								65	
	0.500	MTS4-4308								76	
12mm	5mm	MTS2-12x2.5M	0.75	1.50	1.5	0.20	0.250	1.125	125 lbs	59	
	10mm	MTS4-12x2.5M								73	
1/2"	0.0625	MTS5016	0.75	1.50	1.5	0.20	0.250	1.125	125 lbs	30	
	0.100	MTS5010								41	
	0.200	MTS2-5010								57	
	0.250	MTS2-5008								62	
	0.500	MTS4-5008								75	
	0.800	MTS8-5010								80	
	1.000	MTS8-5008								81	
5/8"	0.100	MTS6210	0.88	1.63	1.5	0.20	0.300	1.188	175 lbs	35	
	0.125	MTS6208								40	
	4mm	MTS62x4M								46	
	0.200	MTS2-6210								51	
	0.250	MTS2-6208								57	
	0.500	MTS4-6208								71	
16mm	4mm	MTS16x4M	0.88	1.63	1.5	0.20	0.300	1.188	175 lbs	47	
3/4"	0.100	MTS7510	1.125	1.75	2.0	0.20	0.300	1.438	275 lbs	31	
	0.125	MTS7508								36	
	0.167	MTS7506								44	
	0.200	MTS7505								49	
	0.500	MTS5-7510								69	
	1.000	MTS8-7508								79	
	2.000	MTS10-7505								82	

*3/8" to 7/16" with tri-flange.

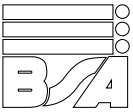

PRECISION LEAD SCREWS & SUPERNUTS™



FEATURES/ADVANTAGES

LOW COST

Considerable savings when compared to ball screw assemblies.

VARIETY

Largest range of leads and diameters 3/16" to 4" to match your requirements.

LUBRICATION

Internally lubricated plastic nuts will operate without lubrication. However, additional lubrication or PTFE coating of the screw is recommended. See page 8-4.

VIBRATION AND NOISE

No ball recirculating vibration and often less audible noise compared to ball screws.

CUSTOM

Option of custom designs to fit into your design envelope.

NON-CORROSIVE*

Stainless Steel and internally lubricated Acetal.

ENVIRONMENT

Less susceptible to particulate contamination compared to ball screws.

LIGHTWEIGHT

Less mass to move.

DESIGN CONSIDERATIONS

LOAD

Supernuts provide a cost effective solution for moderate to light loads. For vertical applications, anti backlash supernuts should be mounted with thread/flange on the bottom.

CANTILEVERED LOADS

Cantilevered loads that might cause a moment on the nut will cause premature failure. Refer to Precision Linear Rails for our complete line-up of linear guides or our stage selection in **Section 4**, **Section 5** and **Section 6** for a complete linear motion solution.

COLUMN LOADING

Refer to column loading chart on page 9-3.

CRITICAL SPEED

Refer to critical speed chart on page 9-2.

SELF-LOCKING

Lead screws can be self locking at low leads. Generally, the lead of the screw should be more than 1/3 of the diameter to satisfactorily backdrive.

TEMPERATURE

Ambient and friction generated heat are the primary causes of premature plastic nut failure. Observe the temperature limits below and discuss your design with our application engineers for continuous duty, high load and high speed applications. BS&A recommends bronze nuts for very high temperature environments or can aid in your selection of high temperature plastic for a custom assembly.

EFFICIENCY

Except at very high leads, efficiency increases as lead increases. Although the internally lubricated Acetal provides excellent lubricity, Ball Screw Assemblies remain significantly more efficient than any Acme design.

LENGTH LIMITATIONS

3/16" to 1/4"	3'
5/16" to 10mm	4'
7/16" to 5/8"	6'
> 5/8"	12'

LEAD ACCURACY

Standard Grade (SRA)	.010 in/ft
Precision Grade (SPR)	.003 in/ft

MATERIAL PROPERTIES

ASSEMBLY		SCREWS	NUTS**			
MAXIMUM TEMPERATURE	FRICTION COEFFICIENT	MATERIAL	MATERIAL	TENSILE STRENGTH	WATER ABSORPTION (24 HRS %)	THERMAL EXPANSION COEFFICIENT
180°F	0.08–0.14	Stainless Steel*	Acetal with PTFE	8,000 psi	0.15	5.4 x 10 ⁻⁵ in/in/°F

*Other materials available on a custom basis.

**Plastic nuts only. See bronze nut section for information on our bronze nut products, page 2-18.



OVERVIEW

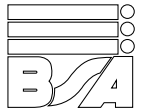

PRECISION LEAD SCREWS & SUPERNUTS™



Rolled Acme lead screws are an excellent economical solution for your linear motion requirements. For over 15 years Ball Screws and Actuators has manufactured the highest quality lead screw assemblies. Our precision rolling machines ensure accurate positioning to 0.003 in/ft and our PTFE coating process produces assemblies that have less drag torque and last longer.

Ball Screws and Actuators provides a large array of standard plastic nut assemblies in anti-backlash or standard Supernut™ designs. For significantly higher loads, standard bronze nuts are available. BS&A also provides engineering design services to aid in your custom design requirements producing a lead—screw assembly to your specifications.

With the introduction of our new unique patent pending Zero-Backlash designs, BS&A provides assemblies with high axial stiffness, zero backlash and the absolute minimum drag torque to reduce motor requirements. These designs produce products that cost less, perform better and last longer. Both automatically adjust for wear insuring zero backlash for the life of the nut.

Our large selection of standard plastic nut assemblies all use an internally lubricated Acetal providing excellent lubricity and wear resistance with or without lubrication. For bronze nuts, BS&A uses SAE 660 bearing bronze which provides high load capacity with good PV performance.

BS&A offers end machining to your specification or can provide you with stock bearing mount, motor mount or complete stage assemblies as shown in **Section 4**.