

Temposonics®

Magnetostrictive, Linear-Position Sensors

PRODUCT CATALOG
Industrial Sensors



The Measurable Difference

REFERENCE INFORMATION

Notices in this Catalog

This manual contains notices to highlight specific information as follows:

Notes:

These notices provide important tips, guidance, or advice.

Important:

These notices provide information that might help you avoid inconvenient or problem situations.

Attention:

These notices indicate possible damage to programs, devices, or data. An attention notice is placed just before the instruction or situation in which damage could occur.

Caution:

These notices indicate situations that can be potentially hazardous to you. A Caution notice is placed just before a description of a potentially hazardous procedure, step, or situation.

Related literature and media

Related support literature and software listed by part number and description below may be referenced within this Industrial Product Catalog. Current literature is provided in Adobe Acrobat Portable Document Format (PDF) and programming software can be downloaded at <http://www.mtssensors.com/>

Product Data Sheets

(Contains product specifications, features, standard accessories and ordering information)

Quick-start guides

(Contains installation, configuration, operation guidelines)

Document number 551024

G-Series handheld programmer for analog output sensors

Document number 550958

Summit high-pressure housing for R-Series model RH and G-Series model GH sensors

Document number 551084

R-Series cabinet programmer

Document number 551192 & 551193

R-Series Model RH Handheld Address Programmer Accessory

Operating Manuals

Contains Installation, operation and technical reference information.

Document number 550966

G-Series Models GP/GH sensors with analog and digital-pulse outputs

Document number 551152

R-Series models RP/RH sensors with SSI output

Document number 550815

R-Series models RP/RH with Profibus output

This Industrial Product Catalog (Document number 551075)

Contains application overviews, market segments, high-level product features, product specifications, standard accessories and ordering information.

Accessories Catalog (Document number 550929)

Provides a comprehensive list of product accessories, installation, mounting and ordering information for standard and retrofit sensor applications.

Related literature and media (Cont.)

Product Overview

Contains current industrial product offerings with high-level feature and specification overviews

Document number 550937

Industrial Product Overview

Introduction

Contact information	i
Reference information	ii
Temposonics® technology	vi

Markets We Serve

Plastics and rubber manufacturing	viii
Woodworking and fluid power	ix
Motion simulation, steel manufacturing and metal forming	x
Process industries and other applications	xi

Product Overview

Linear-position sensor products (High-level overview)	xii
---	-----

R-Series Analog

R-Series Models RP and RH linear-position sensors with Analog Outputs (Voltage/Current)

Features, benefits, applications	1
Product overview	2
Product specifications	2
Output options	3
Enhanced monitoring and diagnostics	3
Advanced communication and programmability	3
Field programming	3
Model RP profile-style sensor dimension references	5
Model RH rod-style sensor dimension references	6
Connections and wiring	7
Sensor ordering information	8

R-Series SSI

R-Series Models RP and RH linear-position sensors with Synchronous Serial Interface (SSI) Output

Features, benefits, applications	11
Product overview	12
Product specifications	12
Output options, SSI interface	13
Measuring modes	13
Advanced output options	14
Enhanced monitoring and diagnostics	15
Advanced communication and programmability	15
Field programming	15
Model RP profile-style sensor dimension references	16
Model RH rod-style sensor dimension references	17
Connections and wiring	18
Sensor ordering information	19

R-Series CANbus

R-Series Models RP and RH linear-position sensors with CANbus Output

Features, benefits, applications	21
Product overview	22
Product specifications	22
Enhanced monitoring and diagnostics	23
CANbus protocol	23

R-Series CANbus (Cont.)

CANopen communication and functionality	23
CANbus outputs	24
Field programming	24
Model RP profile-style sensor dimension references	25
Model RH rod-style sensor dimension references	26
Connections and wiring	27
Sensor ordering information	28

R-Series DeviceNet

R-Series Models RP and RH linear-position sensors with DeviceNet Output

Features, benefits, applications	29
Product overview	30
Product specifications	30
Enhanced monitoring and diagnostics	31
DeviceNet protocol	31
Model RP profile-style sensor dimension references	31
Model RH rod-style sensor dimension references	32
Connections and wiring	33
Cable connector options	34
Sensor ordering information	34

R-Series Profibus-DP

R-Series Models RP and RH linear-position sensors with Profibus-DP Output

Features, benefits, applications	35
Product overview	36
Product specifications	36
Enhanced monitoring and diagnostics	37
Profibus-DP Output parameters	37
Profibus-DP communication and functionality	37
Field programming	38
Model RP profile-style sensor dimension references	38
Model RH rod-style sensor dimension references	39
Connections and wiring	41
Sensor ordering information	43

R-Series EtherCAT®

R-Series Models RP and RH linear-position sensors with EtherCAT® Interface

Features, benefits, applications	45
Product overview	46
Product specifications	46
Enhanced monitoring and diagnostics	47
EtherCAT interface	47
Operation modes and output	47
Model RP profile-style sensor dimension references	48
Model RH rod-style sensor dimension references	49
Connections and wiring	50
Sensor ordering information	51

TABLE OF CONTENTS

R-Series EtherNet/IP™

R-Series Models RP/RH linear-position sensors with Industrial Ethernet

Features, benefits, applications	53
Product overview	54
Product specifications.....	54
Enhanced monitoring and diagnostics	55
Operation mode and output	55
Model RP profile-style sensor dimension references	56
Model RH rod-style sensor dimension references	57
Connections and wiring	58
Sensor ordering information	59

R-Series Profinet

R-Series Models RP/RH linear-position sensors with Profinet interface

Features, benefits, applications	61
Product overview	62
Product specifications.....	62
Enhanced monitoring and diagnostics	63
Operation modes and output.....	63
Model RP profile-style sensor dimension references	64
Model RH rod-style sensor dimension references	65
Connections and wiring	66
Sensor ordering information	67

R-Series RD4

R-Series Model RD4 linear-position sensor with direct position and velocity outputs

Features, benefits, applications	69
Product overview	70
Product specifications.....	70
Model RD4 rod-style M or T sensor dimension references ..	71
Model RD4 rod-style C or D sensor dimension references ..	71
Model RD4 rod-style S sensor dimension references	72
Model RD4 rod-style sensor cylinder install styles M & T ..	73
Model RD4 rod-style sensor cylinder install styles C & D ..	73
Model RD4 rod-style sensor style S w/pressure fit rod.....	74
Model RD4 rod-style sensor cylinder install style S	74
Sensor ordering information	75

R-Series RF Flex

R-Series Model RF - Flex housing for linear-position sensors

Features, benefits, applications	77
Product overview	78
Product specifications.....	78
Model RF rod-style sensor dimension references	79
Model RF rod-style sensor mounting references	80
Pressure pipe and flange selections	81
Pressure pipe and flange Ordering information	83
Sensor ordering information	83

R-Series RS (IP68/IP69K SSH)

R-Series Model RS linear-position sensor with IP68/IP69K super-shield housing

Features, benefits, applications	85
Product overview	86
Product specifications.....	86
Model RS rod-style sensor dimension references	87
Cable gland references	88
Sensor ordering information	89

G-Series Analog/Digital pulse

G-Series Models GP/GH linear-position sensor with analog/digital-pulse sensor outputs

Features, benefits, applications	91
Product overview	92
Product specifications.....	92
Output options	93
Enhanced monitoring and diagnostics	94
Advanced communication and programmability	94
Setup and configuration software	95
Model GP profile-style sensor dimension references	96
Model GH rod-style sensor dimension references	97
Connections and wiring	98
Retrofit connections and wiring (Analog output)	99
Retrofit connections and wiring (Digital output)	99
Sensor ordering information.....	100

G-Series GT2/GT3 Redundant

G-Series Models GT2/GT3 linear-position redundant sensors

Features, benefits, applications	103
Product overview	104
Product specifications.....	104
Output options	105
Advanced communication and programmability	105
Setup and configuration software	105
Model GT rod-style sensor dimension references	106
Connections and wiring	107
Sensor ordering information	108

E-Series EH Rod Style

E-Series Models EH rod-style sensor with analog and Start/Stop outputs

Features, benefits, applications	109
Product overview	110
Product specifications.....	110
Outputs	111
Communication	112
Sensor dimension references	112
Connections and wiring	113
Sensor ordering information	114

E-Series Models EH rod-style sensor with CANopen output

Features, benefits, applications.....	115
Product overview	116
Product specifications.....	116

CANopen communication and functionality 117
 Dual Magnet Outputs 118
 Sensor dimension references 118
 Connections and wiring 119
 Sensor ordering information 120

E-Series Models EH rod-style sensor with SSI output

Features, benefits, applications 121
 Product overview 122
 Product specifications 122
 Synchronous Serial Interface (SSI) 123
 Sensor dimension references 123
 Connections and wiring 124
 Sensor ordering information 125

E-Series EP/EL

E-Series Models EP/EL profile-style sensors with analog and Start/Stop outputs

Features, benefits, applications 127
 Product overview 128
 Product specifications 128
 Outputs 129
 Communication 130
 Sensor dimension references 130
 Connections and wiring 132
 Sensor ordering information 133

E-Series Models EP/EL profile-style sensors with CANopen output

Features, benefits, applications 135
 Product overview 136
 Product specifications 136
 CANopen communication and functionality 137
 Dual Magnet Outputs 138
 Sensor dimension references 138
 Connections and wiring 140
 Sensor ordering information 141

E-Series Models EP/EL profile-style sensors with SSI output

Features, benefits, applications 143
 Product overview 144
 Product specifications 144
 Synchronous Serial Interface (SSI) 145
 Sensor dimension references 145
 Connections and wiring 147
 Sensor ordering information 148

E-Series ER Rod and Cylinder

E-Series Models ER rod-and-cylinder sensor with analog and Start/Stop outputs

Features, benefits, applications 149
 Product overview 150
 Product specifications 150
 Output 151
 Communication 151
 Model ER rod-and-cylinder sensor dimension references .. 152
 Connections and wiring 152
 Sensor ordering information 153

E-Series EE Embedded Analog

E-Series Model EE sensor with current outputs

Features, benefits, applications 155
 Product overview 156
 Product specifications 156
 Outputs 157
 Sensor dimension references 157
 Sensor magnet options 158
 Connections and wiring 158
 Sensor ordering information 160

Industrial Product Accessories

Temposonics® linear-position sensor accessories and ordering information for current production and retrofit options. (Includes mounting, installation and application references)

Mounting & installation reference, Models RH, RF, RD4 ... 162
 Mounting & Installation reference, Models GH and GT 163
 Mounting & Installation reference, Models RP and GP 164
 Mounting & Installation reference, Models EH/EP/EL 165
 Mounting & Installation reference, Models ER and EP2..... 166
 Magnet selections 167
 Extension cable length limitations 171
 Extension cable with 6-pin (D60) connector options 172
 Extension cable with connector options, RP/RH-Profibus .. 173
 Extension cable with connector options RP/RH-SSI 174
 Extension cable with 10-pin connector options 175
 Connector and bus cables, Industrial Ethernet 176
 Connector and bus cables assemblies (M12) cord sets 177
 Adapter cable retrofit options 178
 Connectors 182
 Connectors (retrofit) legacy sensor models 188
 Pressure pipe 189
 Installation hardware 190
 Sensor programming; tools and kits 194

Summit HPH

Summit High-Pressure Housing (HPH) Option for R-Series Model RH and G-Series Model GH linear-position sensors

Features, benefits, applications 197
 Product overview 198
 Product specifications 198
 HPH dimension reference 199
 Design compatibility chart 200
 HPH accessories 201
 Ordering information 201

Magnetostrictive principle - Technology at its best

Time-Based Magnetostrictive Position Sensing Principle

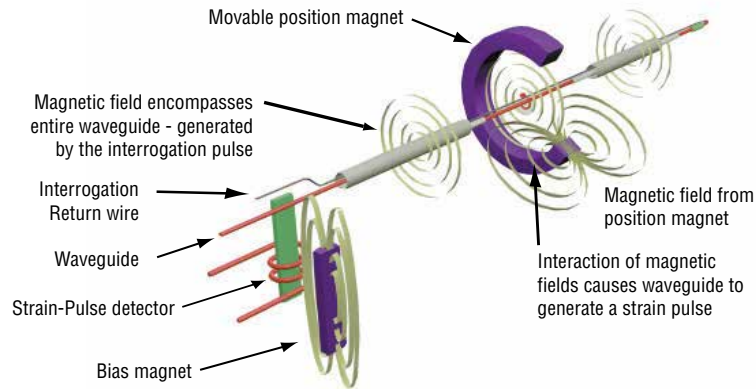

**Temposonics®
Technology**

Technology that guarantees precision and reliability

The best linear-position sensors provide absolute position measurement giving higher productivity and greater safety for machine and automation devices. MTS linear-position sensors outperform the competition, deliver accuracy and reliability under the most difficult conditions, providing excellent value for our customers. Our success is a result of more than 35 years of technology leadership, vertically integrated manufacturing processes and unsurpassed levels of customer support.

MTS Sensors was the first to realize the promising advantages for linear-position measurement contained in the magnetostrictive measuring principle developed by J. Tellermann. Tellermann's original design was used to develop Temposonics brand sensors: the first magnetostrictive position sensors, a technology that guarantees precision and reliability without equal.

Magnetostriction - what it is and how it works

The heart of MTS sensors is the ferromagnetic measuring element, also known as the waveguide, and a movable position magnet that generates a direct-axis magnetic field in the waveguide. When a current or interrogation pulse passes through the waveguide, a second magnetic field is created radially around the waveguide.

The interaction between the magnetic field in the waveguide and the magnetic field produced by the position magnet generates a strain pulse which travels at a constant sonic speed from its point of generation, the measurement point, to the end of the waveguide where it is detected by the sensor electronics.

The position of the magnet is determined with high precision and speed by accurately measuring the time elapsed between the application of the interrogation pulse and the arrival of the resulting strain pulse with a high speed counter. Using the elapsed time to determine position of the permanent magnet provides an absolute position reading that never needs recalibration or re-homing after a power loss. Non-contact sensing eliminates wear, and guarantees the best durability and output repeatability.

With our extensive know-how of ferromagnetic materials, magnetic effects and time-based measurement processes, MTS remains unrivaled in performance standards for non-contacting position measurement of the highest precision.

Sold & Serviced By:

ELECTROMATE

Toll Free Phone (877) SERV098

Toll Free Fax (877) SERV099

www.electromate.com

sales@electromate.com

MTS Temposonics® linear-position sensors

Technology Positioned for Cost-Effective, Accurate, Reliable Performance in Industrial Machine Control Applications

R-Series sensors

Rod and Profile-style sensors



G-Series sensors

Rod and Profile-style sensors



Flexible mounting options

Including external machine mounting or in-cylinder installations (hydraulic & pneumatic)



E-Series sensors

Economical profile and rod-and-cylinder style sensors



Whether you call them position transducers, linear-displacement sensors, distance or linear-position sensors, MTS Sensors provides the most reliable and accurate magnetostrictive position sensors in the world. Temposonics sensors are ideal for monitoring and measurement systems, for machine control involving hydraulic, pneumatic, electromechanical or even manual positioning in industrial or commercial applications.

Temposonics® linear-position sensors out perform, out measure and out last the competition

MTS Sensors enable applications to work smarter and harder. Our full line of standard and custom linear-position sensors can fit virtually every type of industrial and commercial application imaginable.

Temposonics® linear-position sensors provide unmatched flexibility

With a variety of mounting, output and configuration options and can be easily installed in a cylinder or externally mounted to your machine.

Temposonics sensors are a cost-effective, high-performance, high-quality alternative to linear pots or linear encoders. When you add affordable cost to reliable, repeatable performance and zero maintenance, the choice is obvious, Temposonics.

Temposonics®
Technology

Sold & Serviced By:

 **ELECTROMATE**

Toll Free Phone (877) SERV098

Toll Free Fax (877) SERV099

www.electromate.com

sales@electromate.com

Temposonics® Technology



Superior Performance

High performance machines require high performance sensing solutions, and Temposonics technology has been the leader in precision magnetostrictive-based linear position sensing for more than 35 years.

Continuous investment in research and development has enabled MTS to produce the world's highest resolution magnetostrictive sensors, with the fastest update rates for high speed motion control, the tightest non-linearity specifications, and the latest in high performance fieldbus compatible outputs.

The wide range of Temposonics high performance sensors allow you to design, manufacture, and deliver the world's most productive manufacturing machines, and for your customers to deliver high quality and cost optimized products. In a globally competitive environment, superior performance enables high quality, high productivity solutions. Don't settle for less, choose MTS Temposonics Technology!

Markets
We Serve

Plastics & Rubber Manufacturing



Higher Performance, Lower Cost

The world's highest performance injection molding machines, blow molding machines, tire presses, and extrusion filtration systems utilize Temposonics technology to deliver high speed, high quality results. High speed industrial networks combined with precision Temposonics sensors, help these machines produce highly precise products while delivering world-class productivity. Multi-position sensing optimizes costs by controlling two or more motion axes with a single sensor. Resolutions to 0.5 μm enable precision clamp and mold positioning. Legendary Temposonics reliability means that your machine is up and running. High quality and world class productivity – Temposonics Technology delivers.

Primary & Secondary Woodworking



Optimizing Productivity

MTS Temposonics sensors are designed and built to withstand the rigors of sawmill applications and have been that industry's standard for more than 35 years. Recent advances in high speed serial interfaces, enhanced shock and vibration resistance, and the availability of a precision velocity signal (simultaneous with position signal) have enabled new machine control algorithms that increase speed and improve yields. This adds up to increasing productivity and more profitable mill operations. MTS has led the way for more than 35 years, and our newest generation of sensors carries the tradition forward.

Fluid Power; Hydraulic & Pneumatic Cylinders



Operational Efficiency Plus High Performance

High performance, durability and value have made MTS' Temposonics sensor technology the standard for in-cylinder applications in the hydraulics industry for more than 35 years. In addition to superior features like linearity compensation, resistance to shock and vibration and EMI immunity, our innovative modular design allows for easy replacement of the sensing element and electronics without breaking the cylinder's high-pressure seal, thus significantly reducing maintenance costs and downtime. This means your machines are up and your operations are running at peak efficiency.

Markets
We Serve

Motion Simulation



Entertainment Industry

For coordination with video display, position feedback of audience seat movement is a growing need in the entertainment industry.

Temposonics sensors deliver:

- Superior response and accuracy; achieves higher simulated motion fidelity
- Replaceable sensing element eliminates the need to drop hydraulic pressure or break hydraulic seal
- Embedded or detached electronics available for short installation envelopes
- Simultaneous position and velocity outputs enable high performance servohydraulic positioning

Markets
We Serve

Steel Manufacturing and Metal Forming



Superior Speed and Accuracy

Our high-speed R-Series SSI position sensors continue to get faster and more accurate making them an ideal choice for a wide range of machine tool applications. Our SSI sensor also comes with a host of housing and installation options such as the NEMA Type 4X housing and high shock and vibration mechanics to improve immunity and operation in the harshest production environments.

- Resolution down to 0.5 μm (0.00002 in.)
- Accuracy as good as $\pm 10 \mu\text{m}$ (± 0.0004 in.)
- Cycle times as low as 100 μsec .

Process Industries



Quality Manufacturing

By optimizing machine performance and product flow control, Temposonics sensors offer:

- Superior accuracy with higher consistency between changeovers and reduced setup time
- Precise and repeatable positioning for smoother, more controlled motion
- Improved efficiency, yield, and throughput while maintaining quality

Other Application Examples







MTS Sensors Continue to Provide More Application Solutions

Where ever demanding performance is required, Temposonics sensor's provide the trusted solution. A wide range of industries and automation processes that rely on Temposonics state-of-the-art technology is continuously increasing.

- Assembly automation
- Primary metal production
- Paper and textiles
- Robotics
- Glass cutting
- Food and beverage
- Adhesive dispensing
- Material handling and packaging
- Test & measurement
- Wind turbines
- Medical equipment
- Power generation
- Control systems

**Markets
We Serve**

			
Model RH Rod style housing for use in hydraulic/pneumatic cylinders	Model RP Aluminum extrusion profile housing easily mounts on machine surface	Model RF Flexible rod housing for mounting along an arc or for limited installation space	Model RD4 Rod style housing with detached electronics and mounting block. Ideal for use in clevis mounted cylinders.

OUTPUT	Voltage: 0 to 10 Vdc, 10 to 0 Vdc, -10 to +10 Vdc, +10 to -10 Vdc Additional output ranges available between -10 and +10 Vdc			
	Current: 4 to 20 mA, 20 to 4 mA Additional output ranges available between 0 and 20 mA.			
	SSI (Synchronous Serial Interface): Gray or binary format, data length selectable, synchronous / asynchronous measurement, optional parity and error bit.			
	Industrial Ethernet and Fieldbus: CANbus, DeviceNet, Profibus-DP, Profinet RT, EtherCAT® and EtherNet/IP			
MEASURING RANGE	25 to 7,620 mm (1 to 300 in.)	25 to 5,080 mm (1 to 200 in.)	250 to 10,060 mm (10 to 396 in.) Contact factory for longer lengths.	25 to 5,080 mm (1 to 200 in.)
	Resolution and Current: 16 Bit, 0.0015%			
RESOLUTION	Digital: SSI: 0.5 µm (0.00002 in.), Profibus, Profinet, EtherCAT® and EtherNet/IP: 1 µm (0.00004 in.), CANbus, DeviceNet: 2 µm (0.00008 in.).			
	Position + Velocity Measurement (see data sheets)			
FEATURES	Simultaneous Multi-Position Measurements:			
	<ul style="list-style-type: none"> • Voltage or Current; 2 positions • Profibus, CANbus, EtherCAT, EtherNet/IP; up to 20 positions • Profinet: up to 19 positions • SSI: 2 magnet differential 			
DIAGNOSTICS	Handheld programmers and PC programming kits allow adjustment of the measurement stroke length and sensor parameters.			
	Sensor LEDs indicate sensor status, field bus activity and diagnostics.			

CUSTOM AND SPECIAL FUNCTION SENSORS (REFER TO WWW.MTSENSORS.COM)







				
MODEL GB SENSOR	MODEL MH SENSOR	C-SERIES MODELS CS/CM SENSORS	MODEL GT REDUNDANT	C-SERIES WITH H2 HOUSING AND FLOAT OPTIONS

G-SERIES

Backward compatibility and upgraded performance for legacy sensor retrofits

E-SERIES

Economical sensor models for simplistic position feedback applications

					
Model GH & GP Rod or profile style housings	Model EE Compact housing for in-cylinder integration	Model EH Compact rod style housing for use in hydraulic / pneumatic cylinders	Model EP Aluminum extrusion profile housing easily mounts on machine surface	Model EL Low height profile housing for lower clearance on machine	Model ER Rod-and-cylinder housing provides versatile mounting options and internal magnet

Voltage: Ranges between -10 and +10 Vdc		Voltage: 0 to 10 Vdc and / or 10 to 0 Vdc			
Current: Ranges between 0 and 20 mA		Current: 4 to 20 mA or 20 to 4 mA			
		SSI (Synchronous Serial Interface): Gray or binary format, data length selectable, asynchronous measurement			
		CANbus			
Digital Pulse: Start / Stop or PWM		Digital Pulse: Start / Stop			
Voltage and Current: 50 to 2540 mm (2 to 100 in.) Digital Pulse: 50 to 5080 mm (2 to 200 in.) Rod style up to 7620 mm (300 in.)	50 to 2500 mm (2 to 100 in.)	50 to 2500 mm (2 to 100 in.) For EP Start/Stop only: 50 to 3000 mm (2 to 120 in.)			50 to 1500 mm (2 to 60 in.)
Voltage and Current: Infinite (restricted by output ripple)		Voltage and Current: Infinite (restricted by output ripple)			
Digital Pulse: 5 µm, dependent on controller		Digital Pulse: 5 µm, dependent on controller SSI: 20 µm CANbus: 10 µm			
Position Measurement		Position Measurement			
Simultaneous Multi-Position Measurement for Start / Stop (controller dependent)		Simultaneous Multi-Position Measurement: • Voltage or current; 2 positions • Start/Stop (controller dependent)			
		Sensor parameters upload feature for Start/Stop models			
Change measurement stroke length and output using handheld programmers and PC programming kits					
Sensor LEDs indicate status and diagnostics					

ACCESSORIES

				
CONNECTORS & CABLES	MAGNETS & FLOATS	PROGRAMMING TOOLS	EXPLOSION-PROOF HOUSING	PROTECTIVE HOUSINGS

Sold & Serviced By:

 **ELECTROMATE**

Toll Free Phone (877) SERV098

Toll Free Fax (877) SERV099

www.electromate.com

sales@electromate.com

Temposonics®

Magnetostrictive, Absolute, Non-contact
Linear-Position Sensors



R-Series
Analog

R-Series Models RP and RH Analog Outputs (Voltage/Current)

Document Part Number
550992 Revision F

Data Sheet



Model RP Profile-style position sensor

Model RH Rod-style position sensor

FEATURES

- Linear, Absolute Measurement
- LEDs For Sensor Diagnostics
- Non-Contact Sensing Technology
- Linearity Deviation Less Than 0.01%
- Repeatability Within 0.001%
- Direct Analog Outputs (Voltage or Current)
- Single or Dual Channel Outputs (Position + Speed)

BENEFITS

- Rugged Industrial Sensor
- Dual Magnet Position Measurement
- 100% Field Adjustable Null And Span Setpoints

APPLICATIONS

- Continuous Operation In Harsh Industrial Conditions
- High Pressure Conditions
- For Accurate, Dual-Magnet Position Measurement

TYPICAL INDUSTRIES

- Fluid Power
- Factory Automation
- Material Handling and Packaging
- Woodworking, Metalworking and Assembly Tools
- Plastic Injection and Blow Molding



Sold & Serviced By:

ELECTROMATE

Toll Free Phone (877) SERV098

Toll Free Fax (877) SERV099

www.electromate.com

sales@electromate.com

R-Series Models RP and RH Sensors Product Overview and Specifications

Product overview

R-Series model RH and RP sensors are extremely robust and are ideal for continuous operation under harsh industrial conditions. MTS offers two standard sensor housings, rod and profile extrusion. The rod housing is capable of withstanding high pressures such as those found in hydraulic cylinders. The profile extrusion housing provides convenient mounting options and captive sliding magnets which utilize slide bearings of special material that reduce friction, and help mitigate dirt build up. The sensor head contains the active signal conditioning and a complete integrated electronics interface. Double shielding is used to ensure EMI protection for unsurpassed reliability and operating safety.

Product specifications

Parameters	Specifications	Parameters	Specifications
OUTPUT		ENVIRONMENTAL	
Measured output variables:	Position + speed (magnitude) or velocity (with direction) for single or dual magnets	Operating conditions:	Operating temperature: -40 °C (-40 °F) to +75 °C (+167 °F) Relative humidity: 90% no condensation Temperature coefficient: < 30 ppm/ °C
Resolution:	Position measurement: 16 bit; 0.0015% (minimum 1 µm) Speed measurement: 0.1 mm/s	EMC test:	Electromagnetic emission: IEC/EN 50081-1 Electromagnetic susceptibility: IEC/EN 50082-2, IEC/EN 61000-4-2/3/4/6, level 3/4 criterium A, CE qualified
Linearity deviation:	< ± 0.01% full stroke (minimum ± 50 µm)	Shock rating:	100 g (single hit)/ IEC standard 68-2-27 (survivability)
Repeatability:	< ± 0.001% full stroke (minimum ± 2.5 µm)	Vibration rating:	15 g (30 g with HVR option)/10 to 2000 Hz, IEC standard 68-2-6
Hysteresis:	< 4 µm	WIRING	
Analog Outputs:	Voltage: 0 to 10, 10 to 0, -10 to +10, +10 to -10 Vdc (minimum controller load >5k ohms) Current: 4(0) to 20 mA, 20 to 4(0) mA (minimum/maximum load 0/500 ohms)	Connection type:	6-pin male D60 (M16) connector or integral cable
Stroke lengths:	Range (Profile style): 25 to 5080 mm (1 to 200 in.) Range (Rod style): 25 to 7620 mm (2 to 300 in.) Update times: 0.5 ms up to 1200 mm, 1.0 ms up to 2400 mm, 2.0 ms up to 4800 mm, 5.0 ms up to 7620 mm stroke length	PROFILE STYLE SENSOR (MODEL RP)	
Speed measurement:	Range: 0.025 - 10 m/s (1.0 - 400.0 in./s) Deviation: <0.5% Resolution: 0.1 mm/s (0.004 in./s) Update times: Refer to update times in 'stroke lengths' above	Electronic head:	Aluminum housing with diagnostic LED display (LEDs located beside connector/cable exit)
ELECTRONICS		Sealing:	IP 65 **
Operating voltage:	+24 Vdc nominal: -15% or +20% * Polarity protection: up to -30 Vdc Over voltage protection: up to 36 Vdc Current drain: 100 mA typical Dielectric withstand voltage: 500 Vdc (DC ground to machine ground)	Sensor extrusion:	Aluminum (Temposonics profile style)
Setpoints:	Setpoint adjustment (Null/Span): 100% of electrical stroke length. 25 mm (0.98 in.) min. distance between setpoints. For dual-magnet outputs: 76 mm (3 in.) min. distance between magnets	Mounting:	Any orientation. Adjustable mounting feet or T-slot nut (M5 threads) in bottom groove
		Magnet types:	Captive-sliding magnet or open-ring magnet
		ROD STYLE SENSOR (MODEL RH)	
		Electronic head:	Aluminum housing with diagnostic LED display (LEDs located beside connector/cable exit)
		Sealing:	IP 67 or IP 68 for integral cable models **
		Sensor rod:	304L stainless steel
		Operating pressure:	350 bar static, 690 bar peak (5000 psi static, 10,000 psi peak)
		Mounting:	Any orientation. Threaded flange M18 x 1.5 or 3/4 - 16 UNF-3A
		Typical mounting torque:	45 N-m (33 ft. - lbs.)
		Magnet types:	Ring magnet, open-ring magnet, or magnet float

* UL Recognition requires an approved power supply with energy limitation (UL 61010-1), or Class 2 rating according to the National Electrical Code (USA) / Canadian Electrical Code.

** The IP rating is not part of the IEC Recognition

Output options

R-Series analog sensors provide single or dual-magnet sensor options along with single or dual-channel outputs (see 'Figure 1').

The R-Series analog sensor can be ordered for single-position magnet applications which provide one position output, and/or one velocity output over the active stroke length.

The R-Series sensor can also be ordered for dual-position magnet applications which provide two position outputs, or two velocity outputs, or one of each.

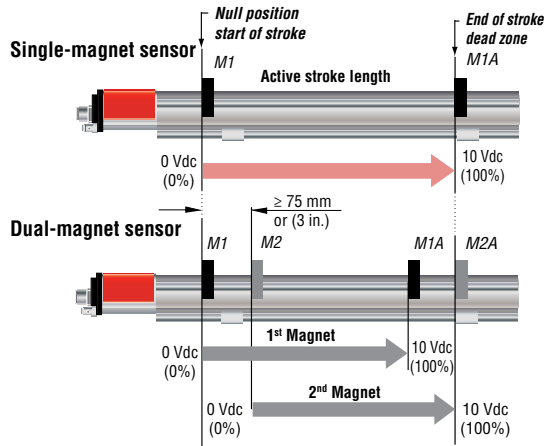

Figure 1. Single and dual-magnet output diagram

When using dual magnets, the minimum allowed distance between the magnets is 75 mm (3 in.) to maintain proper sensor output.

Enhanced monitoring and diagnostics

SENSOR STATUS AND DIAGNOSTIC DISPLAY

Diagnostic LEDs (green/red), located beside the connector or cable exit (see 'Figure 2'), provide basic visual monitoring for normal sensor operation and troubleshooting. Diagnostic display LEDs indicate four modes described in 'Table 1'.



Figure 2. R-Series sensor diagnostic LEDs

Green	Red	Operation status/mode
ON	OFF	Normal function (operation mode)
ON	Flashing	Magnet out of setup range
ON	ON	Magnet not detected or wrong quantity of magnets
Flashing	ON	Programming mode

Table 1. Diagnostic LED codes

Advanced communication and programmability

SENSOR FIELD PROGRAMMING

Temposonics R-Series Analog sensors are pre-configured at the factory by model number designation. For many applications, normal sensor installation and operation does not require additional adjustment. If however, sensor parameter changes are required in the field, the 'R-Series Analog PC Programming Kit, part no. 253309-1' (see 'Figure 3') can be used to easily program the sensor electronically without opening the sensor's housing.

Field programming to adjust the output values is available for any setting needed, within the selected output range. Each sensor's output range is selected from the available options when ordering a particular sensor model number. There are six different manufacturing build types available, three single channel and three dual channel outputs in various ranges as described below:

Single-channel output for either position or speed:

- Voltage output between 0 and +10 volts
- Voltage output between -10 and +10 volts
- Current output between 0 (or 4) and 20 mA

Dual-channel outputs for position and/or speed:

- Voltage outputs between 0 and +10 volts
- Voltage outputs between -10 and +10 volts
- Current outputs between 0 (or 4) and 20 mA

Field Programming Notes:

Field programming allows for numerous custom sensor configurations, however, please note that field programming can not be used to change the R-Series Analog sensor from one manufacturing build type to another.

Field programming (output voltages):

1. Sensor models ordered with *one output channel* can not be reprogrammed in the field to provide a second output channel.
2. Sensor models ordered with *positive only output voltages* can not be reprogrammed in the field to include negative output voltages.
3. Sensor models ordered with *both positive and negative output voltages* can be reprogrammed in the field for positive only voltages, or negative only voltages. However, resolution is then reduced.



Figure 3. R-Series Analog PC Programming Kit, Part no. 253309-1 (For single or dual magnet sensor applications)

Advanced communication and programmability

SENSOR FIELD PROGRAMMING

R-Series Analog PC Programming Kit (Part no.: 253309-1) includes the following components:

- Wall adapter style power supply (24 Vdc output)
- USB Serial converter box with USB cable to connect to PC
- Two connection cables:
 - Cable with connector if sensor is ordered with the D60 integral connector option.
 - Cable with quick connects if sensor is ordered with the integral cable option.
- R-Series Analog PC Setup software, available for download at www.mtssensors.com.

The R-Series Analog PC Setup software user-friendly interface (see 'Figure 4') enables the operator to take advantage of customizing the following settings:

- Magnet positions and sensor output values for Setpoint 1 (Null) and Setpoint 2 (Span) for single or dual magnets. For additional information about setpoints, refer to section 'R-Series analog handheld programmer for single-magnet sensors'.
- Output range settings for speed, or for speed with direction.
- Assign position or velocity output functions for the single or dual magnets, and for the one or two output channels. Output function assignments are limited to the manufacturing build type of the sensor.
- Assign error output values when the magnet moves beyond the programmed setpoints.

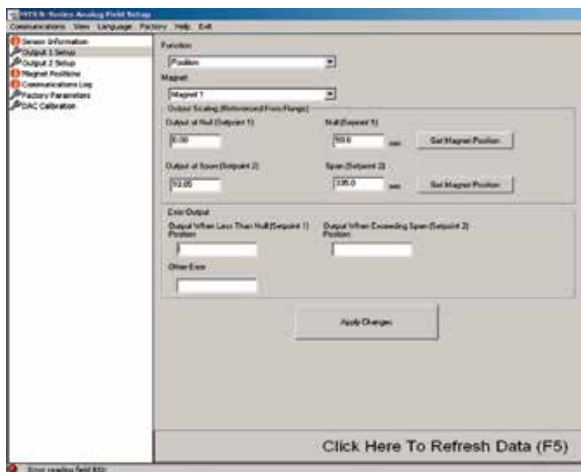

Figure 4. R-Series PC Setup software interface

R-SERIES ANALOG HANDHELD PROGRAMMER FOR SINGLE MAGNET SENSOR APPLICATIONS

The R-Series Analog Handheld Programmer (shown in Figure 5) can be used to program the magnet positions for the start of output, (0% = 0 Vdc, -10 Vdc, 4 mA, or 0 mA), and the end of output, (100% = 10 Vdc or 20 mA), for the single magnet version of the R-Series analog sensor.



Figure 5. R-Series Analog Handheld Programmer, Part no.: 253124

Standard factory settings place the setpoint 1 'Null' and setpoint 2 'Span' at the limits of the sensor's active stroke range. For example, a sensor ordered with 4 - 20 mA output will be factory set for 4 mA output at the bottom limit of the stroke range at the 'Null' position. Likewise, the 20 mA output will be factory set at the top limit of the stroke range at the 'Span' position.

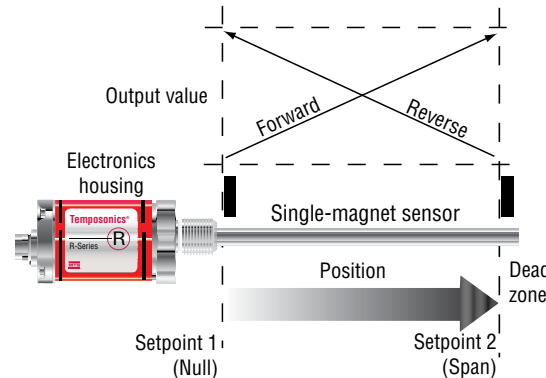

Figure 6. Standard factory settings

Setpoint 1 and setpoint 2 can be re-positioned for the actual measuring length needed anywhere within the active stroke range.

Note:

The minimum distance allowed between setpoint 1 and setpoint 2 is 25 mm (0.98 in.).

These adjustments are easily performed, even when the sensor is not directly accessible, by connecting the analog handheld programmer to the sensor's integral cable or extension cable.

When programming new setpoints, the R-Series Analog Handheld Programmer adjusts the sensor output values to either 0% or 100% at the two selected magnet positions. To program other setpoint output values, use the 'R-Series Analog PC Programming Kit' (Part no.: 253309-1).

Note:

The R-Series Analog Handheld Programmer can also be used to change the output direction from forward-acting (e.g. 4 - 20 mA output) to reverse-acting (20 - 4 mA output), as well as, reverse-acting to forward-acting.

R-SERIES ANALOG CABINET PROGRAMMER FOR SINGLE MAGNET SENSORS

The R-Series Analog Cabinet Programmer (see 'Figure 7') provides the same programming functions as the R-Series Analog Handheld Programmer and is designed to mount in a control cabinet. The R-Series Analog Cabinet Programmer includes a rear snap-in mounting feature that allows the unit to mount on standard 35 mm DIN rail.

After installation, the programmer can remain wired up to both the sensor and PLC interface module if reprogramming or a different machine setup is later required, a built-in 'Program/Run' switch allows this programmability.



Figure 7. R-Series Analog Cabinet Programmer (two shown) , Part no.: 253408 (for single-magnet sensor applications)

Model RP profile-style sensor dimension references

MODEL RP, PROFILE-STYLE SENSOR WITH CAPTIVE-SLIDING MAGNET

Drawing is for reference only, contact applications engineering for tolerance specific information.

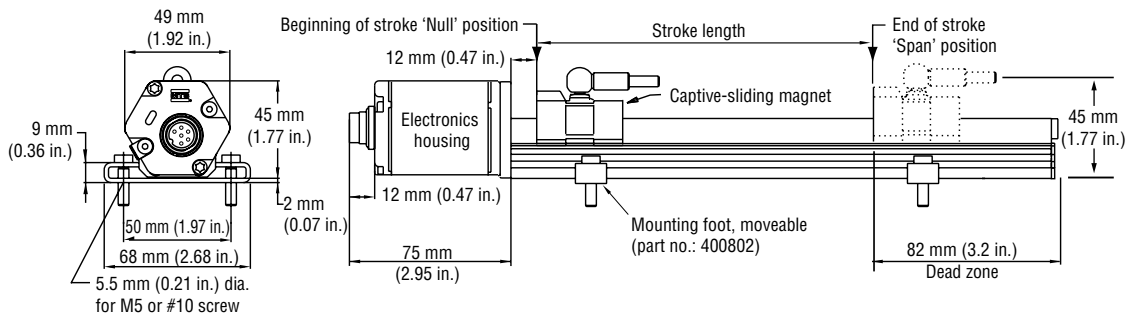

Figure 8. R-Series Model RP Profile-style sensor dimension reference (Shown with the **D60** integral connection type option)

MODEL RP, PROFILE-STYLE SENSOR WITH OPEN-RING MAGNET

Drawing is for reference only, contact applications engineering for tolerance specific information.

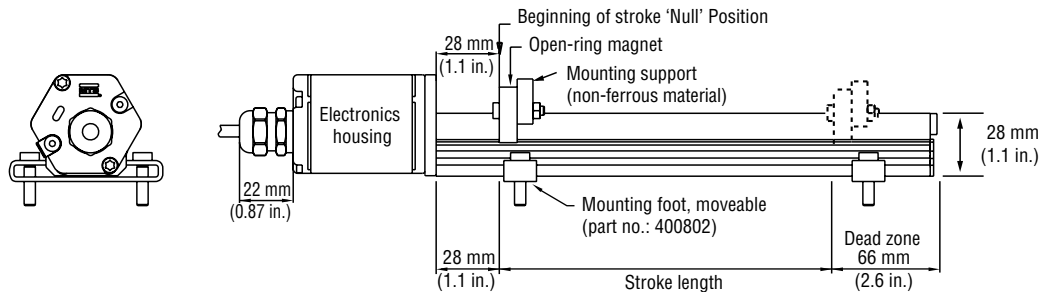



Figure 9. R-Series Model RP Profile-style sensor dimension reference (Shown with the **R05** integral cable connection type option)

Standard magnet selections, mounting and installation (Model RP)

SELECTION OF POSITION MAGNETS (ONE MAGNET INCLUDED WITH MODEL RP SENSOR)

Temposonics Model RP profile-style sensors offer two basic mounting methods; side grooves for use with mounting feet or a bottom groove that accepts special T-Slot nuts. Both the mounting feet and T-Slot nuts can be positioned along the sensor extrusion to best secure the sensor for each particular application.

 Refer to the Accessories section of this catalog for magnet selections and detailed mounting and installation information.

**R-Series Model RH Rod-Style Sensor
Dimension References**

Model RH rod-style sensor dimension references

The Temposonics R-Series rod-style sensor (Model RH) offers modular construction, flexible mounting configurations, and easy installation. The Model RH sensor is designed for mounting in applications where high pressure conditions exist, (5000 psi continuous, 10,000 psi spike), such as inside hydraulic cylinders. The Model RH sensor may also be mounted externally in many applications.

Stroke-dependent Dead Zones:	
Stroke length:	Dead zone:
25 mm (1 in.) - 5000 mm (197 in.)	63.5 mm (2.5 in.)
5005 mm (197.1 in.) - 7620 mm (300 in.)	66 mm (2.6 in.)

MODEL RH, ROD-STYLE SENSOR WITH RING MAGNET (MAGNET ORDERED SEPARATELY)

Drawing is for reference only, contact applications engineering for tolerance specific information.

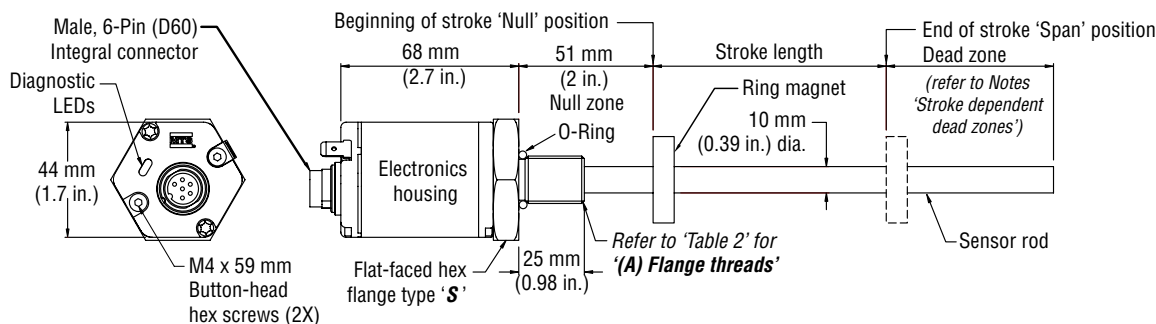

Figure 10. Model RH Rod-style sensor dimension reference (shown with the *D60* integral connection)

MODEL RH, ROD-STYLE SENSOR WITH 6-PIN DIN MATING CABLE CONNECTOR (MAGNET ORDERED SEPARATELY)

Drawing is for reference only, contact applications engineering for tolerance specific information.

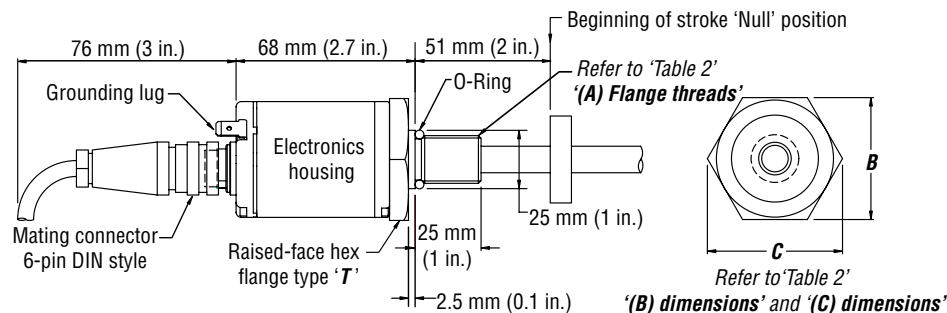

Figure 11. Model RH Rod-style sensor dimension reference (shown with mating cable connector)

Housing style Flange type	Description	(A) Flange threads	(B) Dimensions	(C) Dimensions
T	US customary threads with raised-face flange	3/4" - 16 UNF-3A	1.75 in.	2 in.
S	US customary threads with flat-faced flange	3/4" - 16 UNF-3A	1.75 in.	2 in.
M	Metric threads with flat-faced flange	M18 x 1.5	46 mm	53 mm

Table 2. Model RH Rod-style sensor housing style and flange type references

Standard magnet selections, mounting and installation (Model RH)

Magnets must be ordered separately with Model RH position sensors. The standard ring magnet (part number 201542-2) is suitable for most applications.

Refer to the Accessories section of this catalog for magnet selections and detailed mounting and installation information.

Models RP and RH connections and wiring

STANDARD MALE (D60) 6-PIN DIN INTEGRAL CONNECTOR (M16)

Note:

When using the single channel output, (pins 1 and 2), the unused pins for output 2 (pins 3 and 4) should be left floating (unconnected), unless sensor programming is being performed.



Male, 6-pin (D60) integral connector pin-out as viewed from the end of the sensor

Pin number	Wire color	Function / Analog outputs
1	Gray	Output 1/ Position 1: 0 to 10, 10 to 0, -10 to +10, +10 to -10 Vdc 4 to 20, 20 to 4, 0 to 20, 20 to 0 mA <i>(Required for programming mode / 0% setting)</i>
2	Pink	Return for pin 1
3	Yellow	Output 2/ Position 2 or Speed: 0 to 10, 10 to 0, -10 to +10, +10 to -10 Vdc 4 to 20, 20 to 4, 0 to 20, 20 to 0 mA <i>(Required for programming mode / 100% setting)</i>
4	Green	Return for pin 3
5	Red or Brown	+24 Vdc (-15/+20%) <i>(Required for programming mode)</i>
6	White	DC ground (for supply) <i>(Required for programming mode)</i>

**Models RP and RH Sensors
Ordering Information**

**R-Series
Analog**

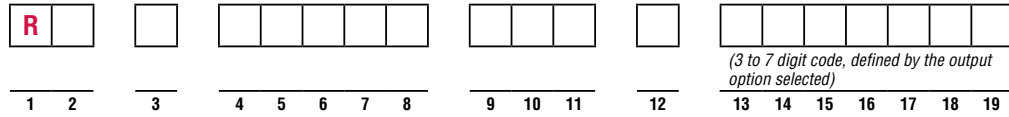

2 Output channels with 2 magnets (3 digit code) _____ = **13 - 15**

Choose a value described below to encode 3 digits (sensor part number boxes 13-15) refer to 'Setpoint Note'

Output #1 = Magnet #1 position	Output #2 = Magnet #2 position
V02 = 0 to +10 Vdc	0 to +10 Vdc
V12 = +10 to 0 Vdc	+10 to 0 Vdc
V22 = -10 to +10 Vdc	-10 to +10 Vdc
V32 = +10 to -10 Vdc	+10 to -10 Vdc
A02 = 4 to 20 mA	4 to 20 mA
A12 = 20 to 4 mA	20 to 4 mA
A22 = 0 to 20 mA	0 to 20 mA
A32 = 20 to 0 mA	20 to 0 mA

2 Output channels with 1 magnet (7 digit code) _____ = **13 - 19**

(Choose a maximum speed value described below in Table 3 to encode all 7 digits (sensor part number boxes 13 - 19))

Output #1 = Magnet position	Output #2 = Speed magnitude	
V01 _____ = 0 to +10 Vdc	+10 (towards head)	0 (at rest)
V11 _____ = +10 to 0 Vdc	+10 (towards head)	0 (at rest)
A01 _____ = 4 to 20 mA	20 (towards head)	4 (at rest)
A11 _____ = 20 to 4 mA	20 (towards head)	4 (at rest)
V01 _____ = 0 to +10 Vdc	+10 (towards tip)	Vdc
V11 _____ = +10 to 0 Vdc	+10 (towards tip)	Vdc
A01 _____ = 4 to 20 mA	20 (towards tip)	mA
A11 _____ = 20 to 4 mA	20 (towards tip)	mA
Output #1 = magnet position	Output #2 = Velocity (speed with direction)	
V41 _____ = 0 to +10 Vdc	0 (towards head)	5 (at rest)
V51 _____ = +10 to 0 Vdc	+10 (towards head)	5 (at rest)
V61 _____ = 0 to +10 Vdc	-10 (towards head)	0 (at rest)
V71 _____ = +10 to 0 Vdc	+10 (towards head)	0 (at rest)
V81 _____ = -10 to +10 Vdc	-10 (towards head)	0 (at rest)
V91 _____ = +10 to -10 Vdc	+10 (towards head)	0 (at rest)
A41 _____ = 4 to 20 mA	4 (towards head)	12 (at rest)
A51 _____ = 20 to 4 mA	20 (towards head)	12 (at rest)
V41 _____ = 0 to +10 Vdc	+10 (towards tip)	Vdc
V51 _____ = +10 to 0 Vdc	0 (towards tip)	Vdc
V61 _____ = 0 to +10 Vdc	+10 (towards tip)	Vdc
V71 _____ = +10 to 0 Vdc	-10 (towards tip)	Vdc
V81 _____ = -10 to +10 Vdc	+10 (towards tip)	Vdc
V91 _____ = +10 to -10 Vdc	-10 (towards tip)	Vdc
A41 _____ = 4 to 20 mA	20 (towards tip)	mA
A51 _____ = 20 to 4 mA	4 (towards tip)	mA
Output #1 = Magnet position (forward-acting)	Output #2 = Magnet position (reverse-acting)	
V03 = 0 to +10 Vdc (3 digit code)	+10 to 0 Vdc	

TABLE 3. FOR SENSOR MODELS WITH SPEED OUTPUT

(Choose a maximum speed value described below to encode the last 4 digits (sensor part number boxes 16-19))

For US customary stroke lengths, encode speed for in./s.

_____ = Speed output maximum
 Available range for US customary stroke lengths is 1.0 to 400.0 in./s, (0010 ... 4000)
Example:
 Maximum speed of 12.0 in./s, and output produced for velocity = [-10(towards head) ... 0(at rest) ... +10(towards tip) Volts]
 Encode: **V 6 1 0 1 2 0** or **V 8 1 0 1 2 0**

For metric stroke lengths, encode speed for m/s (range #1) or mm/s (range #2) using the information provided below:

Speed range #1, (0 _ _ _)
 _____ = Speed output maximum
 Speed range #1 for metric stroke lengths is 0.1 to 10.0 m/s, (0001 ... 0100)
Example:
 Maximum speed of 5.5 m/s, and output produced for speed = [+10(towards head) ... 0(at rest) ... +10(towards tip) Volts],
 Encode: **V 0 1 0 0 5 5** or **V 1 1 0 0 5 5**

Speed range #2, (1 _ _ _)
 _____ = Speed output maximum.
 Speed range #2 for metric stroke lengths is 25 to 90 mm/s, (1025 ... 1090)
Example:
 Maximum speed of 50 mm/s, and output produced for velocity = [4(towards head) ... 12(at rest) ... 20(towards tip) mA]
 Encode: **A 4 1 1 0 5 0**

Temposonics®

Magnetostrictive, Absolute, Non-contact
Linear-Position Sensors



R-Series Models RP and RH Synchronous Serial Interface (SSI) Output

Document Part Number
550989 Revision F

Data Sheet



R-Series
SSI

Model RP Profile-style position sensor

Model RH Rod-style position sensor

FEATURES

- Linear, Absolute Measurement
- LEDs For Sensor Diagnostics
- Non-Contact Sensing Technology
- Linearity Deviation Less Than 0.01%
- Repeatability Within 0.001%
- Direct 24/25/26 Bit SSI Output, Gray/Binary Formats
- Synchronous Measurement for Accurate Velocity/Acceleration Calculations

BENEFITS

- Superior Accuracy; Resolution Down to 0.5 Micron
- Rugged Industrial Sensor
- High-Speed Update Options
- Linearity Correction Options
- Velocity Output Option
- Optional Differential Measurement Between Two Magnets

APPLICATIONS

- Continuous Operation In Harsh Industrial Conditions
- High Pressure Conditions
- For Fast, Precision Motion Control

TYPICAL INDUSTRIES

- Factory Automation
- Fluid Power
- Plastic Injection and Blow Molding
- Material Handling and Packaging
- Woodworking, Metalworking and Machine Tools



Sold & Serviced By:

ELECTROMATE

Toll Free Phone (877) SERV098

Toll Free Fax (877) SERV099

www.electromate.com

sales@electromate.com

R-Series Models RP and RH Sensors (SSI) Product Overview and Specifications

Product overview

R-Series model RP and RH sensors are extremely robust and are ideal for continuous operation under harsh industrial conditions. MTS offers two standard sensor housings, rod and profile extrusion. The rod housing is capable of withstanding high pressures such as those found in hydraulic cylinders. The profile extrusion housing provides convenient mounting options and captive-sliding magnets which utilize slide bearings of special material that reduce friction, and help mitigate dirt build up. The sensor head contains the active signal conditioning and a complete integrated electronics interface. Double shielding is used to ensure EMI protection for unsurpassed reliability and operating safety.

Product specifications

R-Series
SSI

Parameters	Specifications
OUTPUT	
Measured output variables:	Position, or position difference between 2 magnets, or velocity, internal temperature
Resolution:	0.5 µm, 1 µm, 2 µm, 5 µm, 10 µm, 20 µm, 50 µm, 100 µm
Update Rate	
Measuring length:	300 750 1000 2000 5000 mm
Measurements/Sec:	3.7 3.0 2.3 1.2 0.5 kHz <i>(Up to 10 kHz for high-speed update option)</i>
Linearity deviation:	< ± 0.01% full stroke, (minimum ± 40 µm) <i>(Linearity Correction Option (LCO) available)</i>
Repeatability:	< ± 0.001% full stroke (minimum ± 2.5 µm)
Hysteresis:	< 4 µm (2 µm is typical)
Outputs:	Interface: Synchronous Serial Interface (SSI) (RS-422 type differential signal pairs) Data format: Binary or gray, optional parity and error bit, optional internal temperature. Data length: 8 to 32 bit Data speed (Baud rate): 70 kBd* to 1 MBd, depending on cable length (see below):
Length:	<3 <50 <100 <200 <400 m
Baud rate:	1.0 MBd <400 kBd <300 kBd <200 kBd <100 kBd
Stroke length:	Range (Profile style): 25 to 5080 mm (1 to 200 in.) Range (Rod style): 25 to 7620 mm (1 to 300 in.)
Distance between magnets:	75 mm (3 in.) Minimum for 2 magnet differential output * <i>With standard monoflop of 16 µs</i>
ELECTRONICS	
Operating voltage:	+24 Vdc nominal: -15% or +20% * Polarity protection: up to -30 Vdc Oversvoltage protection: up to 36 Vdc Current drain: 100 mA typical Dielectric withstand voltage: 500 Vdc (DC ground to machine ground)

* UL Recognition requires an approved power supply with energy limitation (UL 61010-1), or Class 2 rating according to the National Electrical Code (USA) / Canadian Electrical Code.

** The IP rating is not part of the UL Recognition.

Parameters	Specifications
ENVIRONMENTAL	
Operating conditions:	Operating temperature: -40 °C (-40 °F) to +75 °C (+167 °F) Relative humidity: 90% no condensation Temperature coefficient: < 15 ppm/ °C
EMC test:	Electromagnetic emission: IEC/EN 50081-1 Electromagnetic susceptibility: IEC/EN 50082-2, IEC/EN 61000-4-2/3/4/6, level 3/4 criterium A, CE qualified
Shock rating:	100 g (single hit)/ IEC standard 68-2-27 (survivability)
Vibration rating:	15 g (30 g with HVR option)/ 10 to 2000 Hz, IEC standard 68-2-6
WIRING	
Connection type:	7-pin male D70 (M16) connector, 10-pin male MS connector or integral cable
PROFILE STYLE SENSOR (MODEL RP)	
Electronic head:	Aluminum housing with diagnostic LED display (LEDs located beside connector/cable exit)
Sealing:	IP 65**
Sensor extrusion:	Aluminum (Temposonics profile style)
Mounting	Any orientation. Adjustable mounting feet or T-slot nut (M5 threads) in bottom groove
Magnet types:	Captive-sliding magnet or open-ring magnet
ROD STYLE SENSOR (MODEL RH)	
Electronic head:	Aluminum housing with diagnostic LED display (LEDs located beside connector/cable exit)
Sealing:	IP 67 or IP 68 for integral cable models**
Sensor rod:	304L stainless steel
Operating pressure:	350 bar static, 690 bar peak (5000 psi, 10,000 psi peak)
Mounting:	Any orientation. Threaded flange M18 x 1.5 or 3/4 - 16 UNF-3A
Typical mounting torque:	45 N-m (33 ft. - lbs.)
Magnet types:	Ring magnet, open-ring magnet, or magnet float

Sold & Serviced By:
ELECTROMATE

Toll Free Phone (877) SERV098
Toll Free Fax (877) SERV099
www.electromate.com
sales@electromate.com

Synchronous Serial Interface (SSI)

Temposonics R-Series sensors with SSI fulfill all requirements of the SSI standard for an absolute encoder. The position value is encoded in a 24/25/26 code format and is transmitted at high speed in SSI standard format to the control device. The main feature of SSI is the synchronized data transfer. Data transfer synchronization simplifies the closed-loop control system.

A clock pulse train from a controller is used to gate out sensor data. One bit of position data is transmitted to the controller for each clock pulse received by the sensor (see 'Figures 1 and 2'). The absolute position data is continually updated by the sensor and converted by the shift register into serial information. (see 'Figure 3').

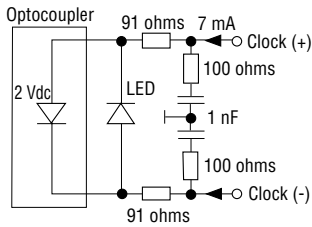

Figure 1. Sensor input

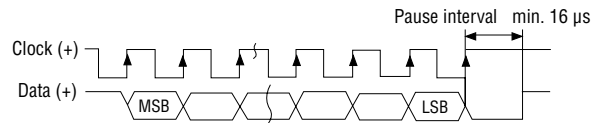

Figure 2. Timing Diagram

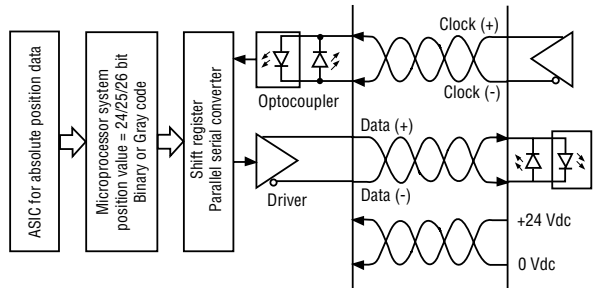

Figure 3. Logic Diagram

R-Series
SSI

Measuring modes

THE SENSOR MEASUREMENT CYCLE

For all Temposonics position sensors, the measurement cycle begins with a very short electrical current pulse being applied to the sensor's waveguide. This is called the 'interrogation pulse'. It creates a magnetic field that interacts with another magnetic field emanating from the position magnet. This interaction produces the magnetostrictive effect and results in a localized mechanical strain in the sensor's waveguide. When the interrogation pulse ends, the strain is suddenly released, sending a rotational sonic strain pulse down the waveguide. The measurement cycle ends when the sonic strain pulse arrives at the end of the waveguide and is detected by the sensor's electronics. By accurately measuring the travel time of the sonic strain pulse the magnet's precise position is determined.

ASYNCHRONOUS MEASURING MODE

For the SSI sensor, the position data is always communicated to the controller or PLC using the Synchronous Serial Interface format. When the SSI sensor is operated as fast as possible, i.e. in Asynchronous Measuring Mode, the position data is updated and stored inside the sensor as quickly as the sensor's measurement cycle will allow. The minimum time for the measurement cycle is determined by the sensor's overall stroke length.

The controller's loop time will determine when the sensor's stored data is collected. For this mode the controller loop time is not synchronized with the sensor's measurement cycle time. However, if it is always slower than the sensor's cycle time then there will always be new position data available in the sensor's shift register, waiting to be clocked out over the SSI interface.

As shown in 'Figure 4', although the sensor is updating the position data as fast as possible, the actual data values collected by the controller can have varying delay times. This is shown as the delays from when the magnet's position was captured, (at the instant the interrogation pulse had started the relevant measurement cycle), to when the data is delivered at the end of the controller loop cycle.

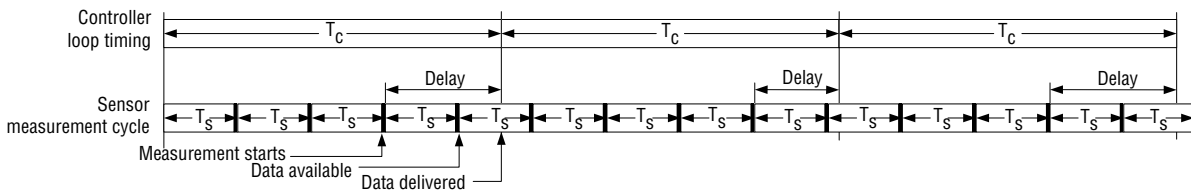

Figure 4. Asynchronous measuring mode, controller loop timing

R-Series Models RP and RH Sensors (SSI) Measuring Modes and Advanced Output Options

SYNCHRONOUS MEASURING MODE ('SYNC 1' OPTION)

Using the Synchronous Measuring Mode, the Temposonics SSI sensor has timing capabilities to optimize the communication link to the controller. Many motion control applications require velocity and/or acceleration be calculated, and therefore, must rely on position data having minimal delay, and minimal timing variability. With the Synchronous Measuring Mode, MTS Sensors has developed a proprietary algorithm to not only guarantee true measurement synchronization but at the same time minimize any propagation delay relative to the controller loop rate.

First, the sensor quickly determines the controller's loop timing – typically after one stable cycle period. Once this is known, and determined to be repeatable to specified limits, the sensor knows exactly when data will be required. The sensor then determines when to start the next measurement cycle, delaying the interrogation pulse, so that the measurement cycle will complete just in time to deliver the freshest data possible when the controller makes the next request, (see 'Figure 5').

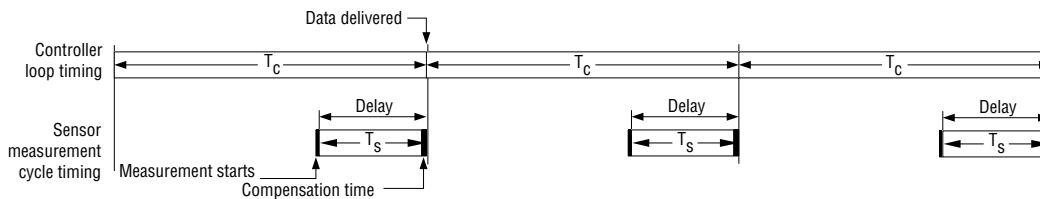

Figure 5. Synchronous measuring mode, Sync 1 option

This form of synchronization to the controller provides the high quality position data needed for complex motion control algorithms and for multiple axes machines requiring tight coordination. When developing applications that will use the Synchronous Measuring Mode, the designer must choose a controller or PLC input module that supports this mode.

Advanced output options

The Temposonics SSI sensor has advanced output options that are helpful for maximizing system performance in demanding applications requiring very high accuracy and speed.

ENHANCEMENTS FOR THE SYNCHRONOUS MEASURING MODE ('SYNC 2' & 'SYNC 3' OPTIONS)

The 'Sync 2' option provides a high speed update feature. When motion control applications require new position data faster than the sensor's measurement cycle time, the high speed update feature provides extrapolated data values, calculated on the fly. A prediction algorithm generates usable position data for delivery to the controller whenever the sensor has not yet completed the next measurement cycle. These extrapolated values are used by the controller as normally updated position data, allowing very fast controller loop times that are necessary for tight control of high speed applications.

The 'Sync 3' option provides an additional enhancement to the high speed update feature of Sync 2. For this mode the prediction algorithm is used for all of the sensor's position data to compensate for the inherent lag time due to the sensor's measurement cycle.

LINEARITY CORRECTION OPTION (LCO)

The Linearity Correction Option (LCO) provides improved sensor output accuracy. For most stroke lengths linearity accuracy is improved up to a factor of 5 resulting in deviations from actual position of less than +/- 20 microns (0.0008 in.). For stroke lengths over 5000 mm (197 in.), the linearity accuracy is improved up to a factor of 10. Selecting the sensor style and magnet is important (both must be matched together). Contact the factory for assistance when designing for the LCO in your application.

ERROR DELAY (SKIP FILTER)

For applications having very high shock and vibration levels that exceed the sensor specification ratings the Error Delay (Skip Filter) can be used to prevent errors being produced on some types of controllers. During these very high shock events the sensor may fail to capture the magnet return signal, and if so, will normally output a zero position value. The Error Delay will instead repeat the last good output value. For long duration shock events the Error Delay will continue to repeat the good output value up to the number of times selected.

NOISE REDUCTION FILTER

Complex systems can have various noise sources sometime significant enough to require filtering. If needed, a Simple Moving Average (SMA) filter function is available to reduce noise effects. The filter algorithm can be adjusted to include the last 2, 4, or 8 output values in the calculated average.

PEAK REDUCTION FILTER

A variation of the filter function is the Weighted Infinite Average (WIA) filter. If needed, this filter can provide a greater smoothing effect and has an adjustable weight parameter.

TEMPERATURE MONITORING

A temperature monitoring device is included inside the sensor electronics housing. Its output can be used to track the general operating conditions for the sensor and to monitor for over temperature. It cannot be used for calculating temperature compensation.

Enhanced monitoring and diagnostics

SENSOR STATUS AND DIAGNOSTIC DISPLAY

Diagnostic LEDs (green/red), located beside the connector or cable exit (see 'Figure 6'), provide basic visual monitoring for normal sensor operation and troubleshooting. Diagnostic display LEDs indicate four modes described in 'Table 1'.



Figure 6. R-Series sensor Integrated diagnostic LEDs

Green	Red	Operation status/mode
ON	OFF	Normal function (operation mode)
ON	ON	Magnet not detected or wrong quantity of magnets
ON	Flashing	Sensor not synchronous (For synchronous measurement mode only)
Flashing	ON	Programming mode

Table 1. Diagnostic display indicator modes

Advanced communication and programmability

SENSOR FIELD PROGRAMMING

Temposonics R-Series sensors with SSI are pre configured at the factory by model number designation. In the event that sensor parameter changes are required in the field, the 'R-Series SSI PC Programming Kit, part no. 253310-1' (see 'Figure 7') can be used to easily program the sensor electronically without opening the sensor's housing.



Figure 7. R-Series SSI PC Programming Kit, Part no. 253310-1

R-SERIES SSI PC PROGRAMMING KIT (PART NO.: 253310-1) INCLUDES THE FOLLOWING COMPONENTS:

- Wall adapter style power supply (24 Vdc output).
- USB Serial converter box with USB cable to connect to PC
- Two connection cables:
 - Cable with connector if sensor is ordered with the D70 integral connector option.
 - Cable with quick connects if sensor is ordered with the integral cable option.

The Utility software included in the R-Series SSI PC Setup software provides a user-friendly interface (see 'Figure 8').

The setup software allows the following set of parameters to be field programmed.

FIELD PROGRAMMABLE PARAMETERS:

- Data length
- Data format
- Resolution
- Measuring direction
- Synchronous / asynchronous measurement
- Measurement filter

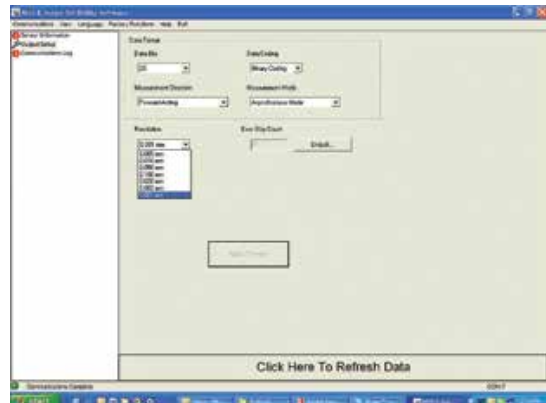

Figure 8. R-Series SSI PC Setup software interface

R-Series Model RP Profile-Style Sensor Dimension References
Model RP - Magnet Selection and Mounting Reference

Model RP profile-style sensor dimension references

MODEL RP, PROFILE-STYLE SENSOR WITH CAPTIVE-SLIDING MAGNET

Drawing is for reference only, contact applications engineering for tolerance specific information.

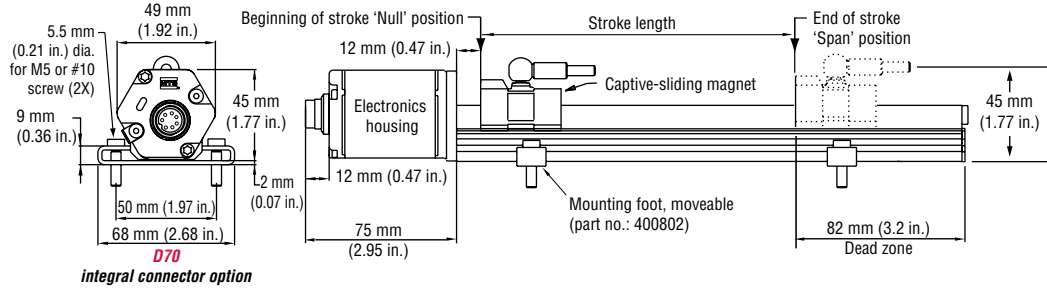

Figure 9. R-Series Model RP Profile-style sensor dimension reference (Shown with **D70** Integral connector option)

MODEL RP, PROFILE-STYLE SENSOR WITH OPEN-RING MAGNET

Drawing is for reference only, contact applications engineering for tolerance specific information.

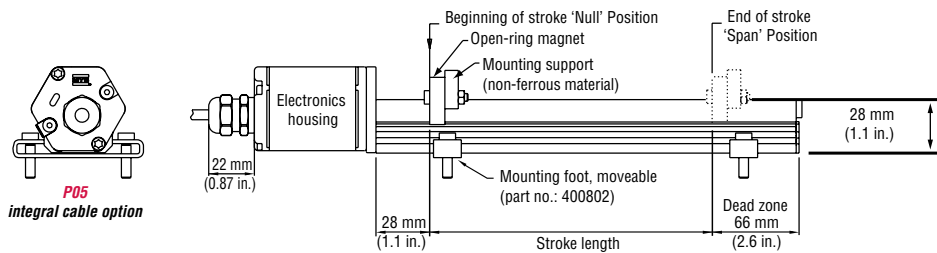

Figure 10. R-Series Model RP Profile-style sensor dimension reference (Shown with **P05** Integral cable option)

Standard magnet selections, mounting and installation (Model RP)

SELECTION OF POSITION MAGNETS (ONE MAGNET INCLUDED WITH MODEL RP SENSOR)

Temposonics Model RP profile-style sensors offer two basic mounting methods; side grooves for use with mounting feet or a bottom groove that accepts special T-Slot nuts. Both the mounting feet and T-Slot nuts can be positioned along the sensor extrusion to best secure the sensor for each particular application.



Refer to the Accessories section of this catalog for magnet selections and detailed mounting and installation information.

**R-Series
SSI**

Model RH rod-style sensor dimension references

The Temposonics R-Series rod-style sensor (Model RH) offers modular construction, flexible mounting configurations, and easy installation. The Model RH sensor is designed for mounting in applications where high pressure conditions exist, (5000 psi continuous, 10,000 psi spike), such as inside hydraulic cylinders. The Model RH sensor may also be mounted externally in many applications.

Stroke-dependent Dead Zones:	
Stroke length:	Dead zone:
25 mm (1 in.) - 5000 mm (197 in.)	63.5 mm (2.5 in.)
5005 mm (197.1 in.) - 7620 mm (300 in.)	66 mm (2.6 in.)

MODEL RH, ROD-STYLE SENSOR WITH RING MAGNET (MAGNET ORDERED SEPARATELY)

Drawing is for reference only, contact applications engineering for tolerance specific information.

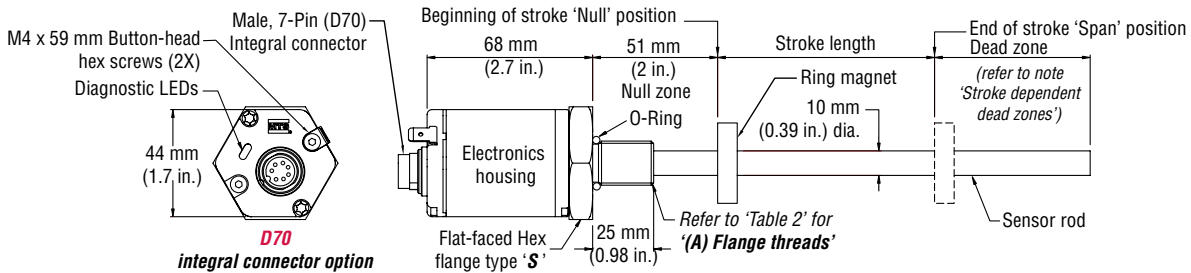

Figure 11. Model RP Profile-style sensor dimension reference (Shown with **D70** Integral connector option)

MODEL RH, ROD-STYLE SENSOR WITH 7-PIN MATING CONNECTOR (MAGNET ORDERED SEPARATELY)

Drawing is for reference only, contact applications engineering for tolerance specific information.

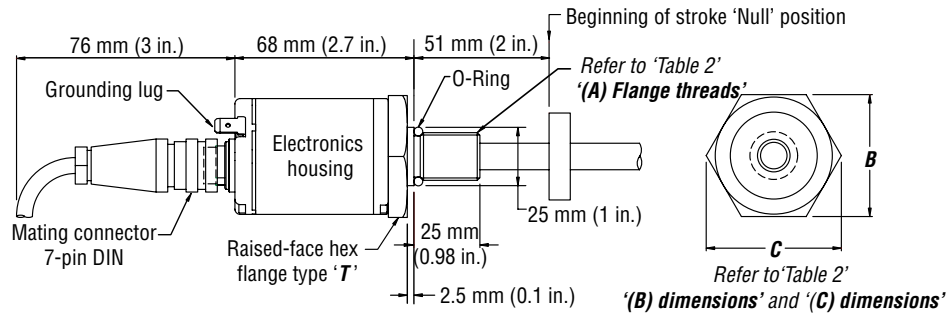

Figure 12. Model RH Rod-style sensor dimension reference (Shown with mating cable connector)

Housing style flange type	Description	(A) Flange threads	(B) Dimensions	(C) Dimensions
T	US customary threads with raised-face flange	3/4" - 16 UNF-3A	1.75 in.	2 in.
S	US customary threads with flat-faced flange	3/4" - 16 UNF-3A	1.75 in.	2 in.
M	Metric threads with flat-faced Flange	M18 x 1.5	46 mm	53 mm

Table 2. Model RH Rod-style sensor housing style and flange type references

Standard magnet selections, mounting and installation (Model RH)

Magnets must be ordered separately with Model RH position sensors. The standard ring magnet (part number 201542-2) is suitable for most applications.

Refer to the Accessories section of this catalog for magnet selections and detailed mounting and installation information.

R-Series Models RP and RH Sensors
Connections and Wiring

Connections and wiring

STANDARD MALE 7-PIN DIN (D70) INTEGRAL CONNECTOR WIRING



Male, 7-pin (D70) integral connector
 (pin-out as viewed from the end of the sensor)

Pin no.	Ext. cable	Function / SSI outputs
1	Gray	Data (-)
2	Pink	Data (+)
3	Yellow	Clock (+)
4	Green	Clock (-)
5	Brown	+24 Vdc (-15/+20%)
6	White	DC ground (for supply)
7	N.C.	N/A

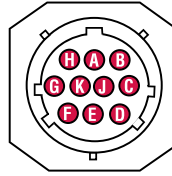

Male, 10-pin (MS) integral connector
 (pin-out as viewed from the end of the sensor)

Pin no.	Ext. cable	Function / SSI outputs
A	White	DC Ground
B	-	No connection
C	Gray	Data (-)
D	Pink	Data (+)
E	Red	+24 Vdc (-15 / +20%)
F	-	No connection
G	Yellow	Clock (+)
H	Green	Clock (-)
I	-	No connection
J	-	No connection
K	-	No connection

Notes:

1. Sensor diagnostics LED's are not available with the MS connector option.
2. MS style cable connector, part no.: 370013, (field installed) mates with the integral MS connector.

**R-Series
SSI**

R-Series Models RP and RH Sensors

Ordering Information

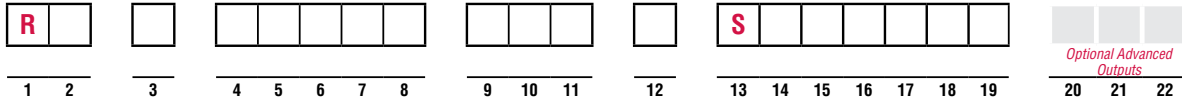

OUTPUT (13 - 19)

S + the 6 digit Output code

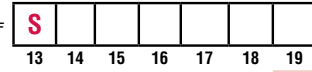

13-19

R-Series SSI

[14] Data length

- 1** = 25 bits
- 2** = 24 bits
- 3** = 26 bits

[15] Output Format

- B** = Binary
- G** = Gray code

[16] Resolution

- 1** = 0.005 mm
- 2** = 0.01 mm
- 3** = 0.05 mm
- 4** = 0.1 mm
- 5** = 0.02 mm
- 6** = 0.002 mm
- 8** = 0.001 mm
- 9** = 0.0005 mm

[17] Filtering Performance

- 1** = Standard, no filter
- A** = No filter + error delay (4 cycles)
- C** = No filter + error delay (8 cycles)
- D** = No filter + error delay (10 cycles)
- G** = Noise reduction filter (8 values) + error delay (10 cycles)
- K** = Peak reduction filter (8 values)
- N** = Peak reduction filter (8 values) + error delay (10 cycles)

[18] [19] Signal Options (scale orientation)

- 00** = Measuring direction forward, async
- 01** = Measuring direction reverse, async
- 02** = Measuring direction forward, sync1
- 05** = Measuring direction forward, bit-25 = Alarm, bit-26 = Parity even, (select data length 26 bits), async
- 16** = Measuring direction forward, LCO
- 99** = **Advanced output options (Enter 99 and an additional 3 character suffix as shown below for boxes 18-22). Advanced outputs are optional and are not required to complete a valid model number.**

OPTIONAL ADVANCED OUTPUTS (18- 22)

99 + 3 digit Output code



18-22

[20] Measurement Contents

- 1** = Position
- 2** = Position difference between 2 magnets
- 3** = Velocity
- 4** = Position + temperature
- 5** = Position difference between 2 magnets + temperature
- 6** = Velocity + temperature

[21] Direction and Sync Mode

- 1** = Forward async
- 2** = Forward sync1
- 3** = Forward sync2
- 4** = Forward sync3
- 5** = Reverse async
- 6** = Reverse sync1
- 7** = Reverse sync2
- 8** = Reverse sync3

[22] Linearity Correction Option (LCO) and Communication Diagnostics

- 0** = No further option
- 1** = LCO
- 2** = Additional alarm bit + even parity bit (data length 26 bits)
- 4** = Additional alarm bit + even parity bit + LCO (data length 26 bits)

Temposonics®

Magnetostrictive, Absolute, Non-contact
Linear-Position Sensors



R-Series Models RP and RH CANbus Outputs (CANopen/CANbasic)

Document Part Number
550991 Revision E

Data Sheet



Model RP Profile-style position sensor

Model RH Rod-style position sensor

R-Series
CANbus

FEATURES

- Linear, Absolute Measurement
- LEDs For Sensor Diagnostics
- Superior Accuracy, Resolution down to 2 μm
- Non-Contact Sensing Technology
- Linearity Deviation Less Than 0.01%
- Repeatability Within 0.001%
- Direct CAN Output (Position + Velocity)

BENEFITS

- Rugged Industrial Sensor
- Selectable Bus Termination (CANopen)
- CANopen with Heartbeat Function

APPLICATIONS

- Continuous Operation In Harsh Industrial Conditions
- High Pressure Conditions
- For Accurate, Multi-Magnet Position Measurement
(up to 20 positions per sensor)

TYPICAL INDUSTRIES

- Factory Automation
- Fluid Power
- Plastic Injection and Blow Molding
- Material Handling and Packaging



Sold & Serviced By:

ELECTROMATE

Toll Free Phone (877) SERV098

Toll Free Fax (877) SERV099

www.electromate.com

sales@electromate.com

R-Series Models RP and RH Sensors CANbus
Product Overview and Specifications

Product overview

R-Series model RH and RP sensors are extremely robust and are ideal for continuous operation under harsh industrial conditions.

MTS offers two standard sensor housings, rod and profile extrusion. The rod housing is capable of withstanding high pressures such as those found in hydraulic cylinders.

The profile extrusion housing provides convenient mounting options and captive sliding magnets which utilize slide bearings of special material that reduce friction, and help mitigate dirt build up.

The sensor head contains the active signal conditioning and a complete integrated electronics interface. Double shielding is used to ensure EMI protection for unsurpassed reliability and operating safety.

Product specifications

**R-Series
CANBUS**

Parameters	Specifications
OUTPUT	
Measured output variables:	Position, velocity, optional multi-magnet position measurements (up to 20 magnet positions simultaneously)
Resolution:	CANopen: Position: 5 µm 2 µm Velocity: 0.5 mm/s 0.2 mm/s CANbasic: Position: 5 µm 2 µm Velocity: 1.0 mm/s 0.1 mm/s
Update times:	1.0 ms up to 2400 mm, 2.0 ms up to 4800 mm, 4.0 ms up to 7600 mm stroke length Add 0.5 ms for CANbasic up to 1200 mm
Linearity deviation:	< ± 0.01% full stroke (minimum ± 40 µm) (Linearity Correction Option (LCO) available)
Repeatability:	< ± 0.001% full stroke (minimum ± 2.5 µm)
Hysteresis:	< 4 µm
Outputs:	Interface: CAN-Fieldbus system ISO DIS 11898 Data protocol CANopen: CIA standard DS-301 V4.02 encoder profile DS-406 V3.1 CANbasic: CAN 2.0 A
Baud rate, kBit/s:	1000 800 500 250 125 50 20
Cable length, m:	<25 <50 <100 <250 <500 <1000 <2500 <i>Sensors will be supplied with ordered Baud rate which can be changed by the customer.</i>
Stroke length:	Range (Profile style): 25 mm to 5080 mm (1 in. to 200 in.) Range (Rod style): 25 mm to 7620 mm (1 in. to 300 in.)
ELECTRONICS	
Operating voltage:	+24 Vdc nominal: -15% or +20%* Polarity protection: up to -30 Vdc Over voltage protection: up to 36 Vdc Current drain: 100 mA typical Dielectric withstand voltage: 500 Vdc (DC ground to machine ground)

Parameters	Specifications
ENVIRONMENTAL	
Operating conditions:	Operating temperature: -40 °C (-40 °F) to +75 °C (+167 °F) Relative humidity: 90% no condensation Temperature coefficient: < 15 ppm/ °C
EMC test:	Electromagnetic emission: IEC/EN 50081-1 Electromagnetic susceptibility: IEC/EN 50082-2, IEC/EN 61000-4-2/3/4/6, level 3/4 criterium A, CE qualified
Shock rating:	100 g (single hit)/IEC standard 68-2-27 (survivability)
Vibration rating:	15 g / 10 to 2000 Hz / IEC standard 68-2-6
WIRING	
Connection type:	Single or dual 6-pin male D60 (M16) connector or two 5-pin Male/Female D54 (M12) connectors with 4-pin male (MS) connector or integral cable
PROFILE STYLE SENSOR (MODEL RP)	
Electronic head:	Aluminum housing with diagnostic LED display (LEDs located beside connector/cable exit)
Sealing:	IP 65**
Sensor extrusion:	Aluminum (Temposonics, profile style)
Mounting:	Any orientation. Adjustable mounting feet or T-slot nut (M5 threads) in bottom groove
Magnet types:	Captive-sliding magnet or open-ring magnet
ROD STYLE SENSOR (MODEL RH)	
Electronic head:	Aluminum housing with diagnostic LED display (LEDs located beside connector/cable exit)
Sealing:	IP 67 or IP 68 for integral cable models**
Sensor rod:	304L stainless steel
Operating pressure:	350 bar static, 690 bar peak (5000 psi static, 10,000 psi peak)
Mounting:	Any orientation. Threaded flange M18 x 1.5 or 3/4 - 16 UNF-3A
Typical mounting torque:	45 N-m (33 ft. - lbs.)
Magnet types:	Ring magnet, open-ring magnet, or magnet float

* UL Recognition requires an approved power supply with energy limitation (UL 61010-1), or Class 2 rating according to the National Electrical Code (USA) / Canadian Electrical Code.

** The IP rating is not part of the IEC Recognition

Enhanced monitoring and diagnostics

SENSOR STATUS AND DIAGNOSTIC DISPLAY

Integrated diagnostic LEDs (green/red), located on top of the sensor housing (see 'Figure 1'), provide basic visual monitoring for normal sensor operation and troubleshooting. Diagnostic display LEDs indicate four modes described in 'Table 1'.



Figure 1. R-Series sensor Integrated diagnostic LEDs

Green	Red	Operation status/mode
ON	OFF	Normal function (operation mode)
ON	ON	Magnet not detected or wrong quantity of magnets
OFF	ON	Initialization error
Flashing	Flashing	Power out of range (high or low)

Table 1. Diagnostic display indicator modes

CANbus protocol

Temposonics R-Series models RP and RH linear-position sensors, as slave devices, fulfill all requirements of the CANbus (ISO 11898) protocol. The sensor's electronics convert the position measurements into bus oriented outputs and transfer this data directly to the controller.

The bus interface is appropriate for serial data transfer up to 1 Mbps maximum. Sensor integrated software supports bus profiles CANopen, CANbasic and DeviceNet for a comprehensive customized configuration of the sensor-bus system.

DeviceNet documentation is available from the MTS website at <http://www.mtssensors.com/products/linear-position-sensors/index.html>.

OPERATION MODES

R-Series sensors with CANbus protocol provide the following single or multi-magnet measurements:

Standard measurements:

- CANbasic; Position + velocity (using one magnet)
- CANopen; Position + velocity (using one to four magnets) + sensor internal electronics temperature

Multi-magnet measurement:

CANbasic; Positions for each of two to twenty magnets simultaneously.

When using multiple magnets, the minimum allowed distance between magnets is 75 mm (3 in.) to maintain proper sensor output (see 'Figure 2').

Single-magnet sensor

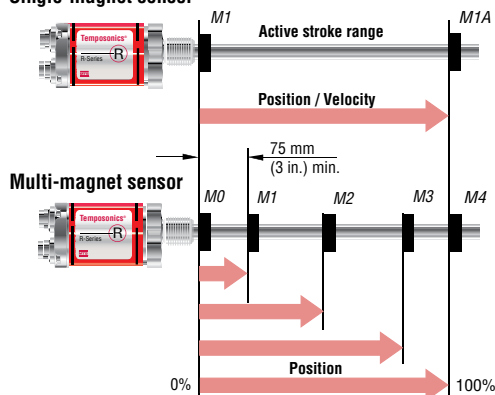

Figure 2. Single and multi-magnet output diagram

CANopen communication and functionality

CANopen corresponds to encoder profile 'DS-406 V3.1 (CIA standard DS-301 V4.02)'. The CANopen functionality is described below in the following communication objects.

Note:

Conformance Test Certificate No. CIA199902-301V30/I-004 is provided by the CANbus user organization CIA (CAN in Automation) for MTS CANopen sensors.

LINEARITY CORRECTION OPTION (LCO)

The Linearity Correction Option (LCO) provides improved sensor output accuracy. For most stroke lengths linearity accuracy is improved up to a factor of 5 resulting in deviations from actual position of less than +/- 20 microns (0.0008 in.). For stroke lengths over 5000 mm (197 in.), the linearity accuracy is improved up to a factor of 10. Selecting the sensor style and magnet is important (both must be matched together). Contact the factory for assistance when designing for the LCO in your application.

SERVICE DATA OBJECT (SDO)

The SDO is mainly used for sensor configuration. Selectable parameters are as follows:

- Resolution for position + velocity
- 4 set points
- Preset of the operation range and the null position for four magnets

PROCESS DATA OBJECT (PDO)

The PDO provides real-time data transfer of sensor measurements in up to 8-byte data blocks. The sensor uses PDO's to relay information about magnet position, velocity, limit status, cam control and operation range for up to four magnets.

Data formats:

- 32-bits for position
- 16-bits for velocity
- 8-bits for value limit.

R-Series Models RP and RH Sensors - CANbus Outputs Enhanced Monitoring Diagnostics, Functionality and Programmability

CANbus outputs

PDO TRANSMISSION TYPE

Asynchronous (cycle time of 1 to 65.535 ms) or synchronous

- Synchronization Object (SYNC)
- Emergency Object
- Nodeguard Object
- Heartbeat function
- Selectable bus termination
- Monitoring for the sensor internal electronics temperature

CANopen communication and functionality

CANOPEN CONFIGURATION

A software file is used as an Electronic Data Sheet (EDS) for sensor configuration. The EDS file is available on the R-Series Setup software mini diskette, part number: 551052 that comes with the sensor. To download the latest software go to MTS website at: <http://www.mtssensors.com>.

Note: Factory default node address = 127 (7F hex).

CANbasic (MTS)

CANbasic (MTS) allows a simple, flexible adaptation to customized profiles with a short bus access. The CANbasic protocol complies with CAN the 2.0A standard and includes applications data for single-magnet measurement (position, velocity, sensor status and five setpoints).

Note: Factory default node address = 00.

CANbasic (Multi-magnet measurement)

CANbasic (Multi-magnet measurement) provides position measurement on a single sensor using a maximum of twenty magnets. Setup and operation are accomplished through the on-site control system.

Note: Factory default node address = 00.

CANopen handheld address programmer

The *CANopen Handheld Address Programmer* (see 'Figure 3') is offered as an accessory used to setup the Node-Address for sensors with the CANopen interface. This setup is usually completed by the bus' LMT/LSS-Service. If the master system or customer controller does not support this service, connecting the CANopen Handheld Address Programmer to the sensor will bypass the service and allow direct setup.



Figure 3. R-Series CANopen Handheld Address Programmer (part no. 252382-D62) Installation Instructions (part no.: 551192)

R-Series
CANbus

Sold & Serviced By:

 **ELECTROMATE**

Toll Free Phone (877) SERV098

Toll Free Fax (877) SERV099

www.electromate.com

sales@electromate.com

Model RP profile-style sensor dimension references

MODEL RP, PROFILE-STYLE SENSOR WITH CAPTIVE-SLIDING MAGNET

Drawing is for reference only, contact applications engineering for tolerance specific information.

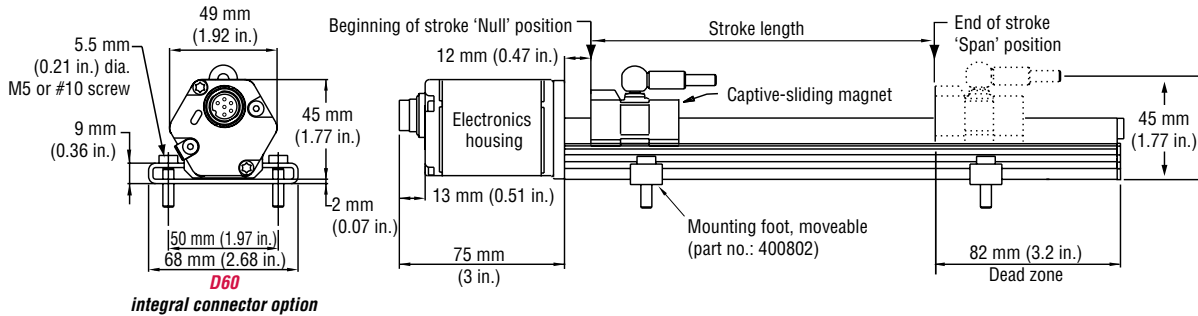

Figure 4. R-Series Model RP Profile-style sensor dimension reference (Shown with the **D60** integral connector option)

MODEL RP, PROFILE-STYLE SENSOR WITH OPEN-RING MAGNET

Drawing is for reference only, contact applications engineering for tolerance specific information.

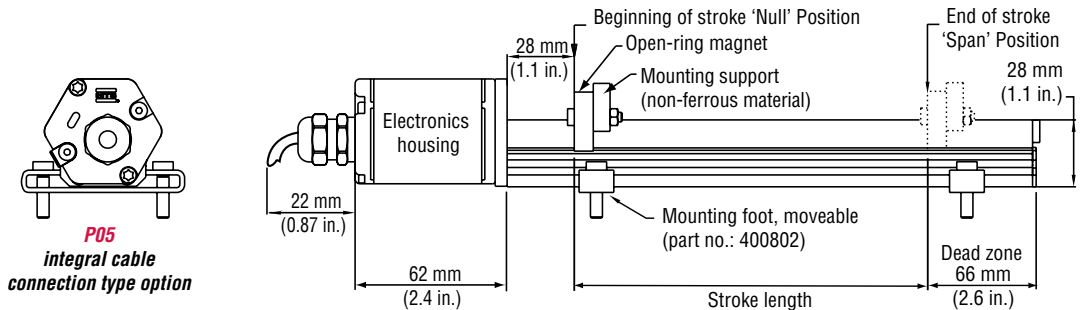

Figure 5. R-Series Model RP Profile-style sensor dimension reference (Shown with the **P05** integral cable option)

MODEL RP, PROFILE-STYLE SENSOR WITH CAPTIVE-SLIDING MAGNET

Drawing is for reference only, contact applications engineering for tolerance specific information.

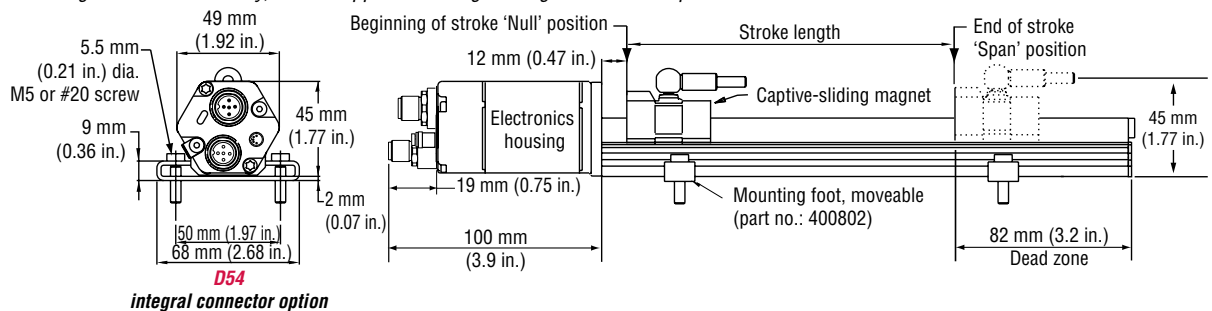



Figure 6. R-Series Model RP Profile-style sensor dimension reference (Shown with the **D54** integral connector option)

Standard magnet selections, mounting and installation (Model RP)

SELECTION OF POSITION MAGNETS (ONE MAGNET INCLUDED WITH MODEL RP SENSOR)

Temposonics Model RP profile-style sensors offer two basic mounting methods; side grooves for use with mounting feet or a bottom groove that accepts special T-Slot nuts. Both the mounting feet and T-Slot nuts can be positioned along the sensor extrusion to best secure the sensor for each particular application.

 Refer to the Accessories section of this catalog for magnet selections and detailed mounting and installation information.

**R-Series
CANBUS**

R-Series Model RH Rod-Style Sensor
Dimension References

Model RH rod-style sensor dimension reference

The Temposonics R-Series rod-style sensor (Model RH) offers modular construction, flexible mounting configurations, and easy installation. The Model RH sensor is designed for mounting in applications where high pressure conditions exist, (5000 psi continuous, 10,000 psi spike), such as inside hydraulic cylinders. The Model RH sensor may also be mounted externally in many applications.

Stroke-dependent Dead Zones:

Stroke length:	Dead zone:
25 mm (1 in.) - 5000 mm (197 in.)	63.5 mm (2.5 in.)
5005 mm (197 in.) - 7620 mm (300 in.)	66 mm (2.6 in.)

MODEL RH, ROD-STYLE SENSOR WITH RING MAGNET (MAGNET ORDERED SEPARATELY)

Drawing is for reference only, contact applications engineering for tolerance specific information.

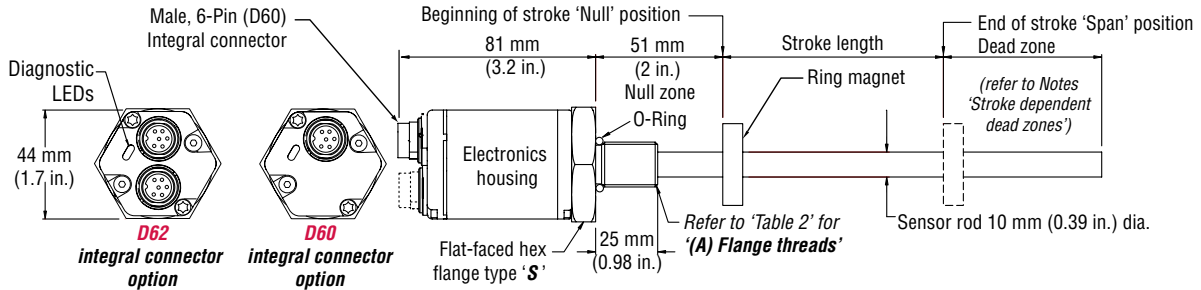

Figure 7. Model RH Rod-style sensor dimension reference (shown with **D60 / D62** integral connector options)

MODEL RH, ROD-STYLE SENSOR

Drawing is for reference only, contact applications engineering for tolerance specific information.

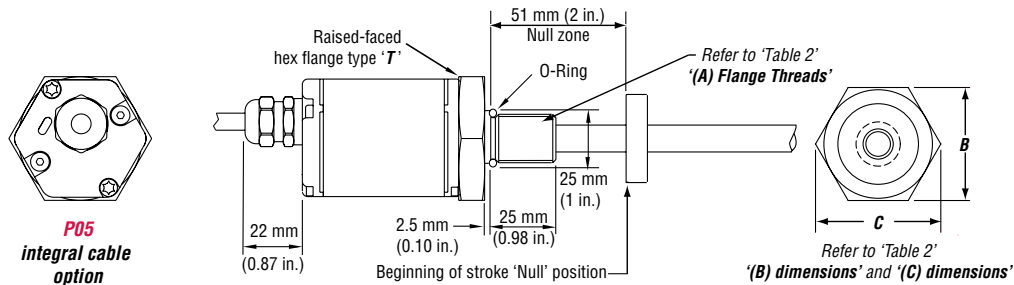

Figure 8. Model RH Rod-style sensor dimension reference (shown with **P05** integral cable option)

MODEL RH, ROD-STYLE SENSOR WITH RING MAGNET (MAGNET ORDERED SEPARATELY)

Drawing is for reference only, contact applications engineering for tolerance specific information.

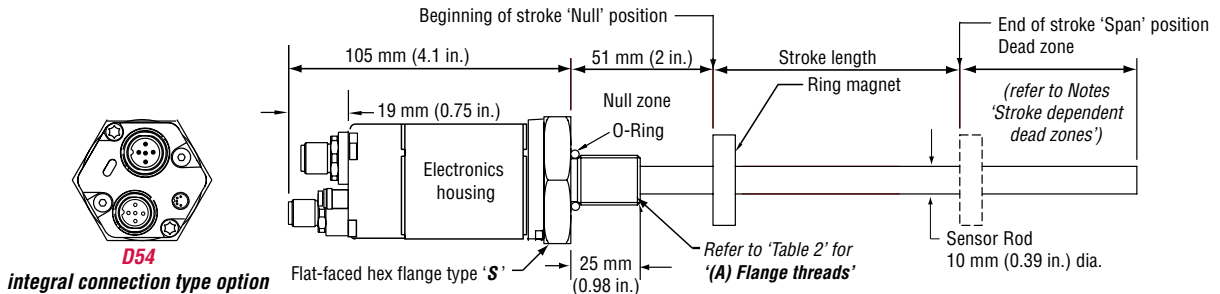

Figure 9. Model RH Rod-style sensor dimension reference (Shown with the **D54** Integral cable connection type option)

Housing style Flange type	Description	(A) Flange threads	(B) Dimensions	(C) Dimensions
T	US customary threads with raised-face flange	3/4" - 16 UNF-3A	1.75 in.	2 in.
S	US customary threads with flat-faced flange	3/4" - 16 UNF-3A	1.75 in.	2 in.
M	Metric threads with flat-faced flange	M18 x 1.5	46 mm	53 mm

Table 2. Model RH Rod-style sensor housing style and flange type references

R-Series CANBUS

Standard magnets, cable connector selections, mounting and installation (Model RH)

Magnets must be ordered separately with Model RH position sensors. The standard ring magnet (part number 201542-2) is suitable for most applications.

 Refer to the Accessories section of this catalog for magnet selections and detailed mounting and installation information.

Connections and wiring

STANDARD MALE (M16) INTEGRAL CONNECTOR FOR SINGLE (D60) AND DUAL (D62) TYPE CONNECTIONS



Male, 6-pin (D60) integral connector pin-out as viewed from the end of the sensor

Pin number	Cable Wire color	Function / CANbus outputs
1	Gray	CAN (-)
2	Pink	CAN (+)
3	Yellow	N.C.
4	Green	N.C.
5	Red or Brown	+24 Vdc (-15/+20%)
6	White	DC ground (for supply)

MALE/FEMALE (M12) INTEGRAL CONNECTORS FOR (D54) TYPE CONNECTIONS



Male, 5-pin (D54) integral connector pin-out as viewed from the end of the sensor



Female, 5-pin (D54) integral connector pin-out as viewed from the end of the sensor

Pin number	Function / CANbus outputs
1	Shield
2	N.C.
3	N.C.
4	CAN (+)
5	(CAN (-)



Input voltage, male, 4-pin (D54) integral connector pin-out as viewed from the end of the sensor

Pin number	Cable wire color	Function
1	Brown	+24 Vdc (-15/+20%)
2	White	N.C.
3	Blue	DC ground (for supply)
4	Black	N.C.

**R-Series
CANbus**

Temposonics®

Magnetostrictive, Absolute, Non-contact
Linear-Position Sensors



R-Series Models RP and RH DeviceNet Output

Document Part Number
550651 Revision F

Data Sheet



Model RP Profile-style position sensor

Model RH Rod-style position sensor

FEATURES

- Linear, Absolute Measurement
- LEDs For Sensor Diagnostics
- Superior Accuracy, Resolution down to 2 μm
- Non-Contact Sensing Technology
- Linearity Deviation Less Than 0.01%
- Repeatability Within 0.001%
- Direct DeviceNet Output

BENEFITS

- Rugged Industrial Sensor
- Cost-effective Communications Network linking Industrial Measurement and Control Devices
- Interface Up to 64 Devices using one cable

APPLICATIONS

- Continuous Operation In Harsh Industrial Conditions
- High Pressure Conditions

TYPICAL INDUSTRIES

- Factory Automation
- Fluid Power
- Plastic Injection and Blow Molding
- Material Handling and Packaging

R-Series
DeviceNet



Sold & Serviced By:



Toll Free Phone (877) SERV098

Toll Free Fax (877) SERV099

www.electromate.com

sales@electromate.com

R-Series Model RH Rod-Style Sensor Product Overview and Specifications

Product overview

R-Series model RH and RP sensors are extremely robust and are ideal for continuous operation under harsh industrial conditions.

MTS offers two standard sensor housings, rod and profile extrusion. The rod housing is capable of withstanding high pressures such as those found in hydraulic cylinders.

The profile extrusion housing provides convenient mounting options and captive sliding magnets which utilize slide bearings of special material that reduce friction, and help mitigate dirt build up. The sensor head contains the active signal conditioning and a complete integrated electronics interface. Double shielding is used to ensure EMI protection for unsurpassed reliability and operating safety.

Controller Area Network (CAN) is a standard for device level communications and the foundation of fieldbus systems like DeviceNet, CANopen and CANbus. These fieldbus systems can provide high speed transmission appropriate for position indication and for motion control in industrial applications.

DeviceNet allows users to interface up to 64 devices using a single cable, thus eliminating the need for conventional methods of multiple wire runs. DeviceNet provides a way to define how, and in which priority, data will be transmitted over the network. The result is a lower complexity, cost-effective communications network linking industrial measurement and control devices. Together, the open DeviceNet protocol and the MTS "smart" R-Series sensors offer an effective, high-precision data transfer system that is well suited for industrial automation.

Product specifications

Parameters	Specifications
OUTPUT	
Measured output variable:	Position
Resolution:	2 µm or 5 µm
Update times:	0.5 ms up to 1200 mm, 1.0 ms up to 2400 mm, 2.0 ms up to 4800 mm, 4.0 ms up to 7600 mm stroke length
Linearity deviation:	< ± 0.01% full stroke (minimum ± 40 µm)
Repeatability:	< ± 0.001% full stroke (minimum ± 2.5 µm)
Hysteresis:	< 4 µm
Output:	Interface: CAN-Fieldbus system ISO DIS 11898 Data protocol DeviceNet release 2.0
Baud rate, kBit/s:	500 250 125
Cable length, m:	<100 <250 <500
	<i>Sensors will be supplied with ordered Baud rate which can be changed by the customer.</i>
Stroke length:	Range (Profile style): 25 mm to 5080 mm (1 in. to 200 in.) Range (Rod style): 25 mm to 7620 mm (1 in. to 300 in.)
ELECTRONICS	
Operating voltage:	+24 Vdc nominal: -15% or +20%* Polarity protection: up to -30 Vdc Overvoltage protection: up to 36 Vdc Current drain: 90 mA typical Dielectric withstand voltage: 500 Vdc (DC ground to machine ground)

* UL Recognition requires an approved power supply with energy limitation (UL 61010-1), or Class 2 rating according to the National Electrical Code (USA) / Canadian Electrical Code.

** The IP rating is not part of the UL Recognition.

Parameters	Specifications
ENVIRONMENTAL	
Operating conditions:	Operating temperature: -40 °C (-40 °F) to +75 °C (+167 °F) Relative humidity: 90% no condensation Temperature coefficient: 15 ppm/ °C
EMC test:	Electromagnetic emission: IEC/EN 50081-1 Electromagnetic susceptibility: IEC/EN 50082-2, IEC/EN 61000-4-2/3/4/6, level 3/4 criterium A, CE qualified
Shock rating:	100 g (single hit)/IEC standard 68-2-27 (survivability)
Vibration rating:	15 g / 10 to 2000 Hz / IEC standard 68-2-6
WIRING	
Connection type:	5-pin male D51 DeviceNet connector
PROFILE STYLE SENSOR (MODEL RP)	
Electronic head:	Aluminum housing with diagnostic LED display (LEDs located beside connector/cable exit)
Sealing:	IP 65**
Sensor extrusion:	Aluminum (Temposonics profile style)
Mounting:	Any orientation. Adjustable mounting feet or T-slot nut (M5 threads) in bottom groove
Magnet types:	Captive-sliding magnet or open-ring magnet
ROD STYLE SENSOR (MODEL RH)	
Electronic head:	Aluminum housing with diagnostic LED display (LEDs located beside connector/cable exit)
Sealing:	IP 67 or IP 68 for integral cable models**
Sensor rod:	304L stainless steel
Operating pressure:	350 bar static, 690 bar peak (5000 psi static, 10,000 psi peak)
Mounting:	Any orientation. Threaded flange M18 x 1.5 or 3/4 - 16 UNF-3A
Typical mounting torque:	45 N-m (33 ft. - lbs.)
Magnet types:	Ring magnet, open-ring magnet, or magnet float

R-Series
DeviceNet

Enhanced monitoring and diagnostics

SENSOR STATUS AND DIAGNOSTIC DISPLAY

Integrated diagnostic LEDs (green/red), located beside sensor connector (see 'Figure 1'), provide basic visual monitoring for normal sensor operation and DeviceNet communications. Diagnostic display LEDs indicate two modes, Network and Module status as described in 'Table 1'.



Figure 1. R-Series sensor Integrated diagnostic LEDs

DeviceNet protocol

R-Series models RP and RH linear-position sensors as slave devices fulfill all requirements of the CANbus (ISO 11898) standard. The sensors electronics and integrated software implement the DeviceNet protocol to convert the displacement measurements into bus oriented outputs and transfer this data directly to the controller. The DeviceNet protocol is appropriate for serial data transfer up to 500 kBit/sec.

When using the DeviceNet protocol with R-series sensors, functionality always includes but is not limited to the following:

- Position
- Error Detection
- Polling & bit-strobe communications modes

PLUG AND PLAY

R-Series sensors with DeviceNet output can be directly connected to a DeviceNet network. The plug and play design makes installation quick and easy. The sensor acts as a "slave" device that transmits

Network Status LED	Operation status/mode
Green	Normal function (operation mode)
Green Flashing	Waiting for instructions from DeviceNet master
Red	Initialization error
Red Flashing	No answer from DeviceNet master

Module Status LED	Operation status/mode
Green	Normal function (operation mode)
Red	Magnet not detected

Table 1. Diagnostic display indicator modes

its position and status data upon request to the "master" device such as a PLC or IPC. After initial system configuration, the user is not required to have extensive knowledge concerning network timing and sensor technology to execute operations within DeviceNet environment. Sensor-specific parameters are installed into the network using the Electronic Data Sheet (EDS). To obtain the EDS, go to www.mtssensors.com.

There are only two programmable parameters, which are, the node identifier and the baud rate. If desired, a PC programming tool, such as DeviceNet Manager offered by Allen Bradley, can be used to change their values. **The node identifier is factory set at node 63.**

The selected baud rate is shown in the sensor's model number. Note that the sensor will only be recognized on a network running at the same baud rate.

R-Series
DeviceNet

Model RP profile-style sensor dimension references

MODEL RP, PROFILE-STYLE SENSOR WITH CAPTIVE-SLIDING MAGNET

Drawing is for reference only, contact applications engineering for tolerance specific information.

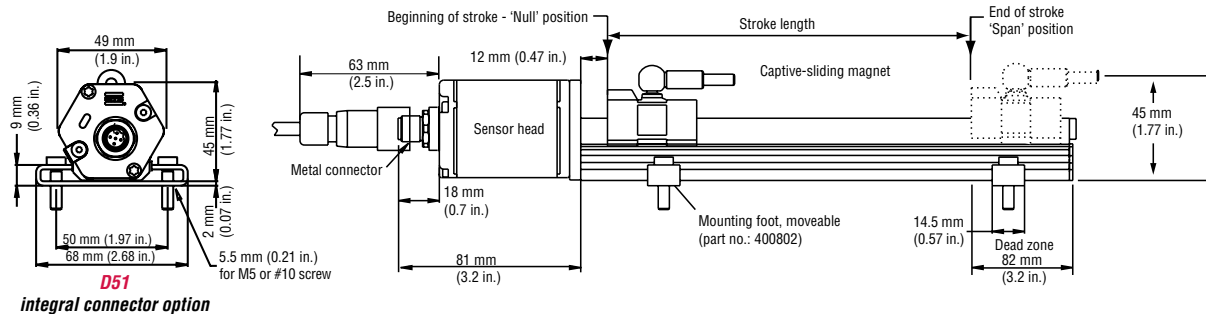

Figure 2. R-Series Model RP Profile-style sensor dimension reference (Shown with the **D51** integral connector option)

Model RP Profile-Style Sensor Dimensions
Model RP Sensors - Standard Magnet and Installation References

MODEL RP, PROFILE-STYLE SENSOR WITH OPEN-RING MAGNET

Drawing is for reference only, contact applications engineering for tolerance specific information.

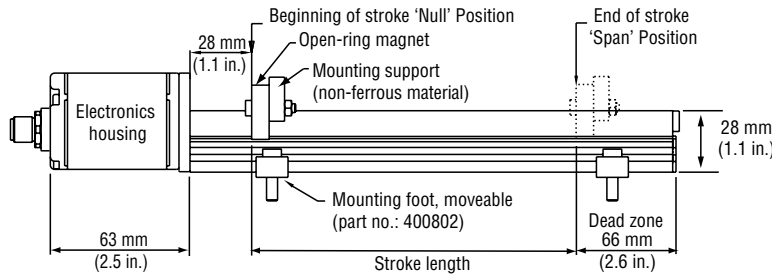



Figure 3. R-Series Model RP Profile-style sensor dimension reference (Shown with the **D51** integral connector option)

Standard magnet selections, mounting and installation (Model RP)

SELECTION OF POSITION MAGNETS (ONE MAGNET INCLUDED WITH MODEL RP SENSOR)

Temposonics Model RP profile-style sensors offer two basic mounting methods; side grooves for use with mounting feet or a bottom groove that accepts special T-Slot nuts. Both the mounting feet and T-Slot nuts can be positioned along the sensor extrusion to best secure the sensor for each particular application.

 Refer to the Accessories section of this catalog for magnet selections and detailed mounting and installation information.

Model RH rod-style sensor dimension reference

The Temposonics R-Series rod-style sensor (Model RH) offers modular construction, flexible mounting configurations, and easy installation. The Model RH sensor is designed for mounting in applications where high pressure conditions exist, (5000 psi continuous, 10,000 psi spike), such as inside hydraulic cylinders. The Model RH sensor may also be mounted externally in many applications.

Stroke-dependent Dead Zones:

Stroke length:	Dead zone:
25 mm (1 in.) - 5000 mm (197 in.)	63.5 mm (2.5 in.)
5005 mm (197 in.) - 7620 mm (300 in.)	66 mm (2.6 in.)

MODEL RH, ROD-STYLE SENSOR WITH RING MAGNET (MAGNET ORDERED SEPARATELY)

Drawing is for reference only, contact applications engineering for tolerance specific information.

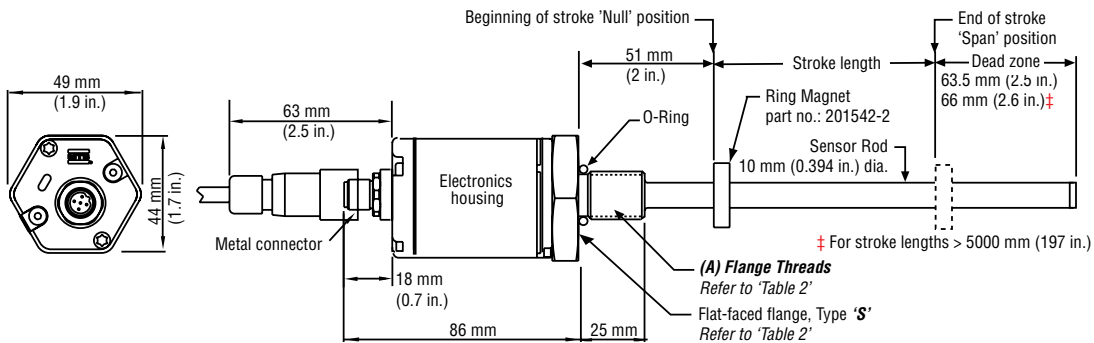

Figure 4. Model RH Rod-style sensor dimension reference (shown with **D51** integral connector options)

**R-Series
DeviceNet**

Model RH Rod-Style Sensor Dimensions
Model RH Sensors - Standard Magnet and Installation References
Connection and Wiring

MODEL RH, ROD-STYLE SENSOR WITH RING MAGNET (MAGNET ORDERED SEPARATELY)

Drawing is for reference only, contact applications engineering for tolerance specific information.

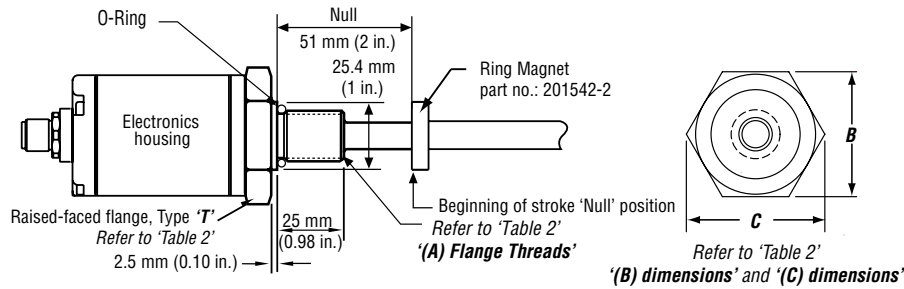

Figure 5. Model RH Rod-style sensor dimension reference (shown with **D51** integral connector option)

Housing style Flange type	Description	(A) Flange threads	(B) Dimensions	(C) Dimensions
T	US customary threads with raised-face flange	3/4" - 16 UNF-3A	1.75 in.	2 in.
S	US customary threads with flat-faced flange	3/4" - 16 UNF-3A	1.75 in.	2 in.
M	Metric threads with flat-faced flange	M18 x 1.5	46 mm	53 mm

Table 2. Model RH Rod-style sensor housing style and flange type references

Standard magnet selections, mounting and installation (Model RH)

Magnets must be ordered separately with Model RH position sensors. The standard ring magnet (part number 201542-2) is suitable for most applications.

Refer to the Accessories section of this catalog for magnet selections and detailed mounting and installation information.

Connections and wiring

CABLE CONNECTOR (FIELD INSTALLED FEMALE MICRO DEVICENET)



Male, 5-pin (DeviceNet micro connector) pin-out as viewed from the end of the sensor

Pin number	Function / DeviceNet outputs
1	Shield
2	+24 Vdc (+20% / -15%)
3	DC ground (for supply)
4	CAN (+)
5	CAN (-)

**R-Series
DeviceNet**

Temposonics®

Magnetostrictive, Absolute, Non-contact
Linear-Position Sensors



R-Series Models RP and RH Profibus-DP Output Data Sheet

Document Part Number
550990 Revision D



Model RP Profile-style position sensor

Model RH Rod-style position sensor

FEATURES

- Linear, Absolute Measurement
- LEDs For Sensor Diagnostics
- Superior Accuracy, Resolution down to 1 μm
- Non-Contact Sensing Technology
- Linearity Deviation Less Than 0.01%
- Repeatability Within 0.001%
- Direct Profibus-DP Output (Position +Velocity)
- Standard and Multi-magnet position measurements (up to 20 positions per sensor)

BENEFITS

- Rugged Industrial Sensor
- Fulfills All Requirements of Profibus-DP (EN 50170) Protocol
- Profibus-DP Provides Powerful Functions for Diagnostics and Configuration
- Linearity Correction Options

APPLICATIONS

- Continuous Operation In Harsh Industrial Conditions
- High Pressure Conditions
- For Accurate, Multi-Magnet Position Measurement (up to 20 positions per sensor)

TYPICAL INDUSTRIES

- Factory Automation
- Fluid Power
- Plastic Injection and Blow Molding
- Material Handling and Packaging

R-Series
Profibus



Sold & Serviced By:



Toll Free Phone (877) SERV098

Toll Free Fax (877) SERV099

www.electromate.com

sales@electromate.com

R-Series Models RP/RH Sensors with Profibus-DP Output Product Overview and Specifications

Product overview

R-Series model RH and RP sensors are extremely robust and are ideal for continuous operation under harsh industrial conditions. MTS offers two standard sensor housings, rod and profile extrusion. The rod housing is capable of withstanding high pressures such as those found in hydraulic cylinders. The profile extrusion housing provides convenient mounting options and captive sliding magnets which utilize slide bearings of special material that reduce friction, and help mitigate dirt build up. The sensor head contains the active signal conditioning and a complete integrated electronics interface. Double shielding is used to ensure EMI protection for unsurpassed reliability and operating safety.

Temposonics R-Series models RP and RH linear-position sensors fulfill all requirements of Profibus-DP (EN 50170) protocol. They also provide absolute position data to Profibus control units by using a serial, bit synchronous, RS-485 format at a baud rate up to 12 Mbps maximum.

In addition to data transmission, Profibus-DP provides powerful functionality for diagnostics and configuration, which is loaded into the bus using the GSD electronic device data sheet file. The downloadable .gsd file for Temposonics Profibus model sensors is available at <http://www.mtssensors.com>.

Product specifications

Parameters	Specifications
OUTPUT	
Measured output variables:	Position, up to 20 magnet positions simultaneously Position + Velocity, up to 5 magnets simultaneously
Resolution:	1 μ m, other values are selectable when using the .gsd file
Update times:	0.5 ms at 500 mm, 1 ms at 2000 mm, 2 ms at 4500 mm, 3.1 ms at 7600 mm stroke length. For each additional magnet add 0.05 ms. Add 0.03 ms for approximate values for velocity measurements.
Linearity deviation:	< \pm 0.01% full stroke (minimum \pm 50 μ m) <i>(Linearity Correction Option (LCO) available)</i>
Repeatability:	< \pm 0.001% full stroke (minimum \pm 2.5 μ m)
Hysteresis:	< 4 μ m
Outputs:	Interface: Profibus-DP system ISO 74498 Data format: Profibus-DP (EN 50 170)
Data transmission rates:	12 MBd 1.5 MBd 500 kBd 187.5 kBd \leq 93.75 kBd
Cable length, m:	<100 <200 <400 <1000 <1200
Stroke length:	Range (Profile style): 25 mm to 5080 mm (1 in. to 200 in.) Range (Rod style): 25 mm to 7620 mm (1 in. to 300 in.)
ELECTRONICS	
Operating voltage:	+24 Vdc nominal: -15% or +20%* Polarity protection: up to -30 Vdc Over voltage protection: up to 36 Vdc Current drain: 90 mA typical Dielectric withstand voltage: 500 Vdc (DC ground to machine ground)

Parameters	Specifications
ENVIRONMENTAL	
Operating conditions:	Operating temperature: -40 °C (-40 °F) to 75 °C (167 °F) Relative humidity: 90% no condensation Temperature coefficient: < 15 ppm/°C
EMC test:	Electromagnetic emission: IEC/EN 50081-1 Electromagnetic susceptibility: IEC/EN 50082-2, IEC/EN 61000-4-2/3/4/6, level 3/4 criterium A, CE qualified
Shock rating:	100 g (single hit)/IEC standard 68-2-27 (survivability)
Vibration rating:	15 g / 10 to 2000 Hz / IEC standard 68-2-6
WIRING	
Connection type:	D63 option: Two 6-pin (M16) connectors one male and one female D53 option: Two 5-pin (M12) connectors one male and one female. plus one 4-pin connector (M8) male
PROFILE STYLE SENSOR (MODEL RP)	
Electronic head:	Aluminum housing with diagnostic LED display (LEDs located beside connectors)
Sealing:	IP 65**
Sensor extrusion:	Aluminum (Temposonics profile style)
Mounting:	Any orientation. Adjustable mounting feet or T-Slot nut (M5 threads) in bottom groove
Magnet types:	Captive-sliding magnet or open-ring magnet
ROD STYLE SENSOR (MODEL RH)	
Electronic head:	Aluminum housing with diagnostic LED display (LEDs located beside connectors)
Sealing:	IP 67**
Sensor rod:	304L stainless steel
Operating pressure:	350 bar static, 690 bar peak (5000 psi static, 10,000 psi peak)
Mounting:	Any orientation. Threaded flange M18x1.5 or 3/4-16 UNF-3A
Typical mounting torque:	45 N-m (33 ft. - lbs.)
Magnet types:	Ring magnet, open-ring magnet, or magnet float

* UL Recognition requires an approved power supply with energy limitation (UL 61010-1), or Class 2 rating according to the National Electrical Code (USA) / Canadian Electrical Code.

** The IP rating is not part of the UL Recognition.

R-Series
Profibus

Enhanced monitoring and diagnostics

SENSOR STATUS AND DIAGNOSTIC DISPLAY

Integrated diagnostic LEDs (green/red), located beside sensor connectors (see 'Figure 1'), provide basic visual monitoring for normal sensor operation and troubleshooting. diagnostic display LEDs indicate four modes described in 'Table 1'.



Figure 1. R-Series sensor Integrated diagnostic LEDs

Profibus-DP output parameters

R-Series sensors with Profibus-DP output are compliant with Profibus DP slave class 2 and have the following features:

Selectable outputs:

- Absolute position measurement
- Velocity measurement
- Sensor Status
- Error detection (e.g. magnet status)

Selectable parameters:

- Offset / preset for each magnet
- Measuring direction; forward and reverse acting
- Intel® and Motorola® data format transfers

OPERATION MODES

R-Series sensors with Profibus-DP protocol provide the following single or multi-magnet measurements:

Standard measurement (P102 output code):

- Position (using one magnet)

Multi-magnet measurement (P101 output code):

- Position (using up to 20 magnets simultaneously)

Multi-magnet measurement (P103 output code):

- Position + velocity (using up to 5 magnets simultaneously)

Profibus-DP communication and functionality

DATA EXCHANGE

For multi-magnet measurement, 1 status byte and 3 bytes of position data for each position are transmitted. The status byte contains an error bit and the position number for the following measurement value. Dependent on sensor parameters, sensor data can be transferred in different data formats, (e.g. Intel® or Motorola®)

Note: Factory default node address = 125 (7D hex)

Green	Red	Operation status/mode
ON	OFF	Normal function (operation mode)
ON	ON	Magnet not detected or wrong quantity of magnets
Flashing	OFF	Waiting for master parameters
Flashing	ON	Programming mode

Table 1. Diagnostic display indicator modes

When using multiple magnets, the minimum allowed distance between magnets is 75 mm (3. in.) to maintain proper sensor output (see 'Figure 2').

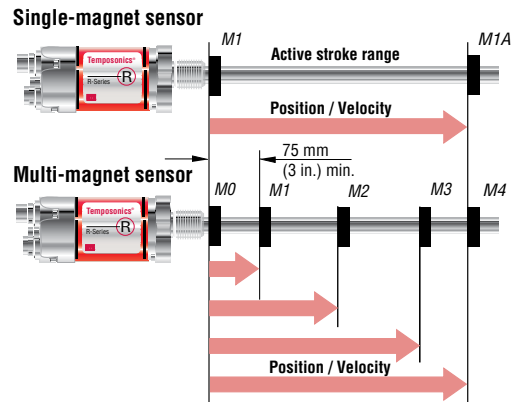

Figure 2. Single and multi-magnet output diagram

LINEARITY CORRECTION OPTION (LCO)

The Linearity Correction Option (LCO) provides improved sensor output accuracy. For most stroke lengths linearity accuracy is improved up to a factor of 5, resulting in deviations from actual position of less than ± 20 microns (0.0008 in.). For stroke lengths over 5000 mm (197 in.) the linearity accuracy is improved up to a factor of 10. Selecting the sensor style and magnet is important (both must be matched together). Contact the factory for assistance when designing for the LCO in your application.

Profibus-DP Programming Accessories
Model RP Profile-Style Sensor Dimension References

Profibus-DP handheld address programmer

The *Profibus-DP Handheld Address Programmer* (see 'Figure 3') is offered as an accessory used to setup the *Slave Address* via the Profibus-DP interface. Addressing is usually performed by the Profibus-DP SetSlaveAddress command. If the master system or controller does not support this service, connecting the Profibus-DP Handheld Address Programmer to the sensor will bypass the service and allow direct setup. Default Node ID is 125 (7D Hex).



Figure 3. R-Series Profibus-DP Handheld Address Programmer, part no.: 280640

When ordering the *Profibus-DP Node and Field Address Programmer* accessory, for D53 and D63 style connections, order part no.: 280640. The Profibus-DP Node and Address Programmer Installation instructions (document part no.: 551193) is available in PDF format at <http://www.mtssensors.com>.

Programming accessory	Function	Part number
Profibus handheld address programmer	For sensors with the D63 connection type	280640
Profibus handheld address programmer	For sensors with the D53 connection type	280640
Profibus master simulator	Check sensor operation using Bihl + Wiedemann, Model 1131	401727
Master simulator cable	For sensors with the D63 connection type	401726
Master simulator cable	For sensors with the D53 connection type	252383
Profibus noise filter box	Junction box with noise filter for connecting 24 Vdc input power on to the bus when using the hybrid Profibus cable, (D63 connection type).	252916

Model RP profile-style sensor dimension references

MODEL RP, PROFILE-STYLE SENSOR WITH STYLE S CAPTIVE-SLIDING MAGNET

Drawing is for reference only, contact applications engineering for tolerance specific information.

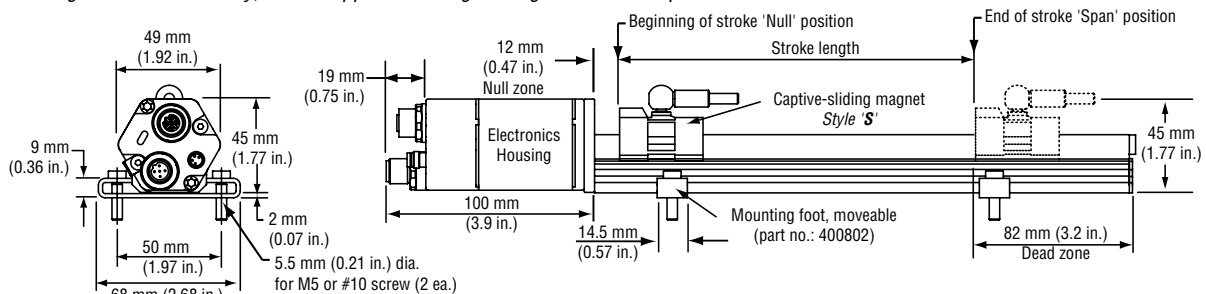

D53 Connector option

Figure 4. R-Series Model RP Profile-style sensor dimension reference (Shown with the **D53** connector option)

MODEL RP, PROFILE-STYLE SENSOR WITH STYLE M OPEN-RING MAGNET

Drawing is for reference only, contact applications engineering for tolerance specific information.

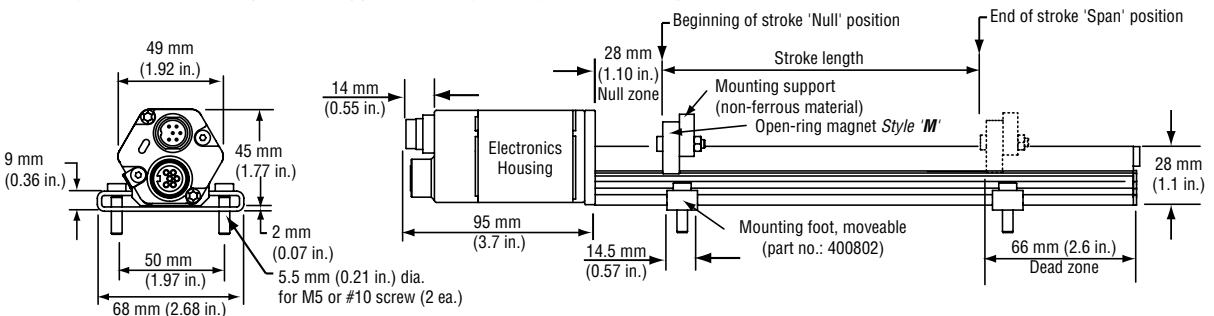

D63 Connector option

Figure 5. R-Series Model RP Profile-style sensor dimension reference (Shown with the **D63** connector option)

R-Series Profibus

Models RP Profile-Style and RH Rod-Style Sensor Dimensions Standard Magnet, Mounting and Installation References

MODEL RP, PROFILE-STYLE SENSOR WITH STYLE V CAPTIVE-SLIDING MAGNET Drawing is for reference only, contact applications engineering for tolerance specific information.

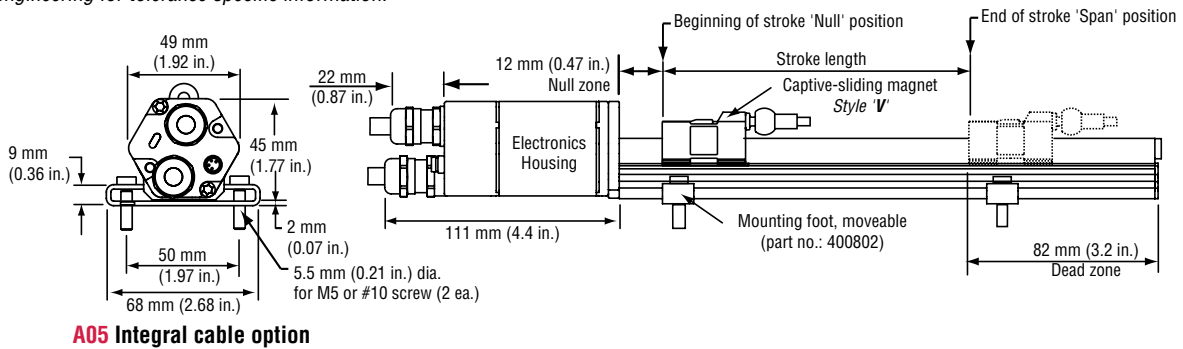

Figure 6. R-Series Model RP Profile-style sensor dimension reference (Shown with the **A05** integral cable option)

Standard magnet selections, mounting and installation (Model RP)

SELECTION OF POSITION MAGNETS (ONE MAGNET INCLUDED WITH MODEL RP SENSOR)

Temposonics Model RP profile-style sensors offer two basic mounting methods; side grooves for use with mounting feet or a bottom groove that accepts special T-Slot nuts. Both the mounting feet and T-Slot nuts can be positioned along the sensor extrusion to best secure the sensor for each particular application.

Refer to the Accessories section of this catalog for magnet selections and detailed mounting and installation information.

Model RH rod-style sensor dimension reference

The Temposonics R-Series rod-style sensor (Model RH) offers modular construction, flexible mounting configurations, and easy installation. The Model RH sensor is designed for mounting in applications where high pressure conditions exist (5000 psi continuous, 10,000 psi spike), such as inside hydraulic cylinders. The Model RH sensor may also be mounted externally in many applications.

Stroke-dependent Dead Zones:

Stroke length:	Dead zone:
25 mm (1 in.) - 5000 mm (197 in.)	63.5 mm (2.5 in.)
5005 mm (197 in.) - 7620 mm (300 in.)	66 mm (2.6 in.)

MODEL RH, ROD-STYLE SENSOR DIMENSION REFERENCE

Drawing is for reference only, contact applications engineering for tolerance specific information.

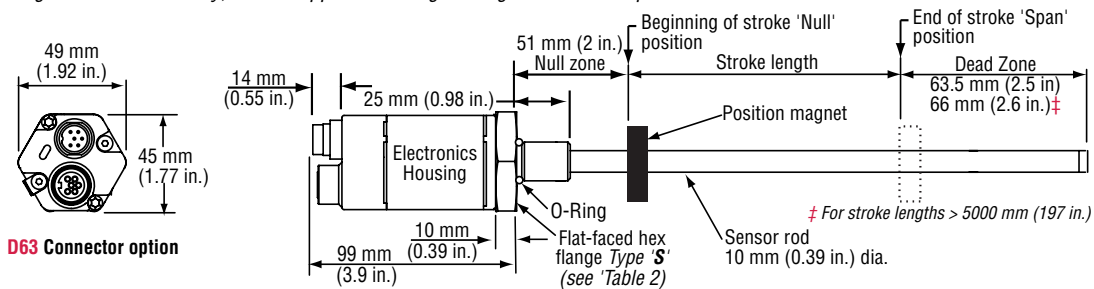

Figure 7. Model RH Rod-style sensor dimension reference (shown with **D63** connector option)

**R-Series
Profibus**

Connection and wiring options

BUS / INPUT VOLTAGE CONNECTION OPTIONS (DAISY-CHAIN TOPOLOGIES)

(D63) CONNECTOR OPTION

The shielded hybrid cable (5 wires; two bus, two power supply and 1 machine ground, part no.: 530040) is used for both bus and supply voltage (D63) connections. This provides convenient daisy-chain connections for applications with multiple Profibus-DP sensors.

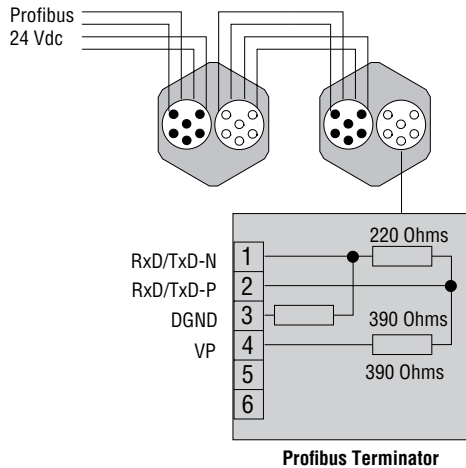

(D53) CONNECTOR OPTION

For (D53) connection types, a separate 4-pin connector and cable is used for the supply voltage.

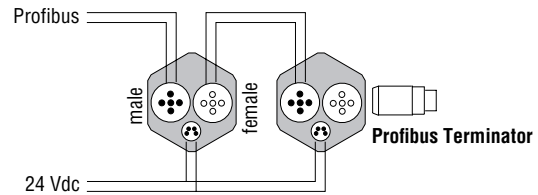

(D53) CONNECTOR OPTION WITH THE 'T' CONNECTOR

A 'T' connector is used with the separate bus cable to enable the bus to remain active when a sensor is disconnected.

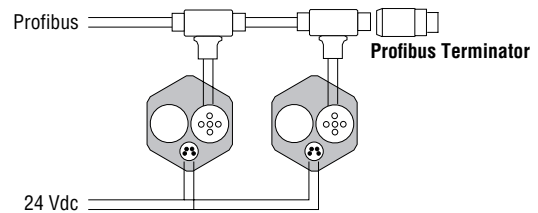

Bus connector option (D63)

(D63) BUS CONNECTOR OPTION PINOUTS/FUNCTIONS



D63 Male
6-pin outlet

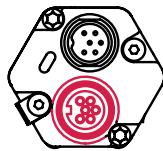

D63 Female
6-pin outlet

MALE/FEMALE, 6-PIN (D63) INTEGRAL CONNECTOR OPTION FOR SHIELDED HYBRID CABLE FOR BUS AND INPUT VOLTAGE

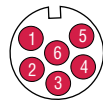

Male, 6-pin (M16) integral connector pin-out as viewed from the end of the sensor

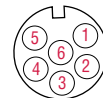

Female, 6-pin (M16) integral connector pin-out as viewed from the end of the sensor

Pin number	Cable wire color	Function
1	Green	RxD/TxD-N (Bus)
2	Red	RxD/TxD-P (Bus)
3	N/A	DGnd (Bus termination) <i>female connector only</i>
4	N/A	VP (Bus termination) <i>female connector only</i>
5	Black	+24 Vdc (-15/+20%)
6	Blue	DC ground (for supply)
N/A	Yellow/ Green	Shielding, machine ground

**R-Series
Profibus**

**R-Series Models RP and RH Sensors - Profibus-DP
Connection and Wiring**

Connections and wiring (D53)

(D53) BUS CONNECTOR OPTION PINOUTS/FUNCTIONS



D53
Male, 4-pin
Input voltage



D53
Male
5-pin outlet



D53
Female
5-pin outlet

MALE/FEMALE, 5-PIN (D53) INTEGRAL CONNECTOR OPTION

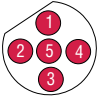

Male, 5-pin (M12) integral connector pin-out as viewed from the end of the sensor

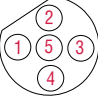

Female, 5-pin (M12) integral connector pin-out as viewed from the end of the sensor

Pin number	Cable wire color	Function
1	N/A	VP+5 (Bus termination) <i>female connector only</i>
2	Green	RxD/TxD-N (Bus)
3	N/A.	DGnd (Bus termination) <i>female connector only</i>
4	Red	RxxD / TxD-P (Bus)
5	Shield	Shield

(D53) INPUT VOLTAGE INTEGRAL CONNECTOR OPTION



Input voltage, male, 4-pin (M8) integral connector pin-out as viewed from the end of the sensor

Pin number	Wire color	Function
1	Brown	+24 Vdc (-15/+20%)
2	White	No connection
3	Blue	DC ground (for supply)
4	Black	No connection

**R-Series
Profibus**

Sold & Serviced By:

ELECTROMATE

Toll Free Phone (877) SERV098

Toll Free Fax (877) SERV099

www.electromate.com

sales@electromate.com

Temposonics®

Magnetostrictive, Absolute, Non-contact
Linear-Position Sensors



R-Series Models RP and RH

EtherCAT® Industrial Ethernet Interface

Document Part Number
551074 Revision C

Data Sheet



Model RP Profile-style position sensor



Model RH Rod-style position sensor



FEATURES

- Linear, Absolute Measurement
- LEDs For Sensor Diagnostics
- Superior Accuracy, Resolution down to 1 μm
- Non-Contact Sensing Technology
- Linearity Deviation Less Than 0.01%
- Repeatability Within 0.001%
- Direct EtherCAT® Interface, Position + Velocity
- 100 μs Position / Velocity Update Time, Regardless of Overall Stroke Length

BENEFITS

- Rugged Industrial Sensor
- Position + Velocity Measurements For Up to 20 Magnets

APPLICATIONS

- Continuous Operation In Harsh Industrial Conditions
- High Pressure Conditions
- For Accurate, High-Speed, Simultaneous Multi-Position and Velocity Measurements

TYPICAL INDUSTRIES

- Factory Automation
- Fluid Power
- Plastic Injection and Blow Molding
- Material Handling and Packaging

R-Series
EtherCAT®

EtherCAT® is a registered trademark and patented technology licenced by
Beckhoff Automation GmbH, Germany



Sold & Serviced By:



Toll Free Phone (877) SERV098

Toll Free Fax (877) SERV099

www.electromate.com

sales@electromate.com

R-Series Models RP and RH Sensors Product Overview and Specifications

Product overview

Temposonics R-Series EtherCAT sensors represent MTS Sensors' development and product offering in high-speed networked position feedback. EtherCAT (Ethernet for Control Automation Technology) is a unique interface developed by Beckhoff Automation and is supported by the EtherCAT Technology Group (ETG).

This interface is used for industrial Ethernet, providing the fastest, most deterministic industrial networking solution possible using the base Ethernet physical layer. By using this format, coupled with our high speed networked sensing capability, machine builders and automation engineers will be able to overcome bandwidth and node limitation issues found with other commercially available industrial networks.

Product specifications

Parameters	Specifications	Parameters	Specifications
OUTPUT		ENVIRONMENTAL	
Measured output variables:	Simultaneous multi-position and velocity measurements up to 20 magnets or up to 5 magnets when using high-speed update (for EtherCAT distributed clock mode). Option for acceleration measurements up to 2 magnets.	Operating conditions:	Operating temperature: 0 °C (32 °F) to +75 °C (+167 °F) Relative humidity: 90% no condensation Temperature coefficient: < 15 ppm/ °C
Resolution:	1 to 1000 µm selectable	EMC test:	Electromagnetic emission: IEC/EN 50081-1 Electromagnetic susceptibility: IEC/EN 50082-2, IEC/EN 61000-4-2/3/4/6, level 3/4 criterion A, CE qualified
Update time:	100 µs min. (high speed update feature is active when the controller's loop time is less than the sensor's measurement cycle time)	Shock rating:	100 g (single hit)/IEC standard 68-2-27 (survivability)
Linearity deviation:	< ± 0.01% full stroke (minimum ± 50 µm) (Linearity Correction Option (LCO) available)	Vibration rating:	15 g / 10 to 2000 Hz / IEC standard 68-2-6
Repeatability:	< ± 0.001% full stroke (minimum ± 2.5 µm)	WIRING	
Hysteresis:	< 4 µm	Connection type:	D56 option: Two female 4-pin (M12-D) plus one 4-pin male (M8) connector
Outputs:	Interface: EtherCAT Data format: EtherCAT 100 Base-Tx, fast Ethernet Data transmission rate: 100 Mbit/s max.	PROFILE STYLE SENSOR (MODEL RP)	
Stroke length:	Range (Profile style): 25 mm to 5080 mm (1 in. to 200 in.) Range (Rod style): 25 mm to 7620 mm (1 in. to 300 in.)	Electronic head:	Aluminum housing with diagnostic LED display (LEDs located beside connectors)
ELECTRONICS		Sealing:	IP 65**
Operating voltage:	+24 Vdc nominal: -15% or +20%* Polarity protection: up to -30 Vdc Over voltage protection: up to 36 Vdc Current drain: 80 mA typical Dielectric withstand voltage: 500 Vdc (DC ground to machine ground)	Sensor extrusion:	Aluminum (Temposonics profile style)
		Mounting:	Any orientation. Adjustable mounting feet or T-slot nut (M5 threads) in bottom groove
		Magnet types:	Captive-sliding magnet or open-ring magnet
		ROD STYLE SENSOR (MODEL RH)	
		Electronic head:	Aluminum housing with diagnostic LED display (LEDs located beside connectors)
		Sealing:	IP 67**
		Sensor rod:	304L stainless steel
		Operating pressure:	350 bar static, 690 bar peak (5000 psi static, 10,000 psi peak)
		Mounting:	Any orientation. Threaded flange M18 x 1.5 or 3/4 - 16 UNF-3A
		Typical mounting torque:	45 N-m (33 ft. - lbs.)
		Magnet types:	Ring magnet, open-ring magnet, or magnet float

* UL Recognition requires an approved power supply with energy limitation (UL 61010-1), or Class 2 rating according to the National Electrical Code (USA) / Canadian Electrical Code.

** The IP rating is not part of the UL Recognition.

R-Series
EtherCAT®

Sold & Serviced By:
ELECTROMATE

Toll Free Phone (877) SERV098
Toll Free Fax (877) SERV099
www.electromate.com
sales@electromate.com

Enhanced monitoring and diagnostics

SENSOR STATUS AND DIAGNOSTIC DISPLAY



Integrated diagnostic LEDs (green/red), located beside sensor connectors (see 'Figure 1'), provide basic visual monitoring for normal sensor operation and troubleshooting. Diagnostic display LEDs indicate four modes described in 'Table 1. Diagnostic display indicator modes'

Figure 1. R-Series sensor Integrated diagnostic LEDs

Status LED (Green)	Off: On: Flashing:	Initializing Normal function Various flashing codes show different operational status
Error LED (Red)	Off: On: Flashing:	Normal function missing magnet Supply voltage beyond limits (high or low)
IN Port LED (Green)	Off: On: Flashing:	No link Link detected Traffic
OUT Port LED (Green)	Off: On: Flashing:	No link Link detected Traffic

Table 1. Diagnostic display indicator modes

EtherCAT interface

EtherCAT is an open field bus system which is based on Ethernet technology, (IEEE 802.3), with a high data rate and short response time, resulting in very good real-time performance. It is standardized in the IEC/PAS 62407 and is part of the ISO 15745-4 standard. The EtherCAT protocol is also being integrated into the IEC 61158, IEC 61784, and IEC 61800-7 standards.

The Temposonics EtherCAT sensor is connected as a slave device, and as such, fulfils all the requirements of the EtherCAT field bus system. Adding the sensor to an EtherCAT bus system is very easy. The system manager (e.g. TwinCAT from Beckhoff Automation) gets all the parameters of the sensor from the XML file, available from the MTS website at <http://www.mtssensors.com>. There are no adjustments necessary on the sensor itself. For some applications, optimum system performance is obtained using the sensor's high speed updates, up to 10 kHz, by synchronizing to the EtherCAT's 'distributed clock mode' (available on the "E101" sensor output option).

Operation modes and output

There are two operation modes available:

E101 - Fast update position and velocity:

- Designed for high-speed motion control
- Up to 5 simultaneous magnet measurements
- 100 μ s update rate, (independent of stroke length)

E102 Multi-magnet position and velocity:

- Designed for gauging systems having many magnet positions
- Up to 20 simultaneous magnet measurements
- Standard update rates, (stroke length dependent)

When using multiple magnets, the minimum allowed distance between magnets is 75 mm (3 in.) to maintain proper sensor output (see 'Figure 2').

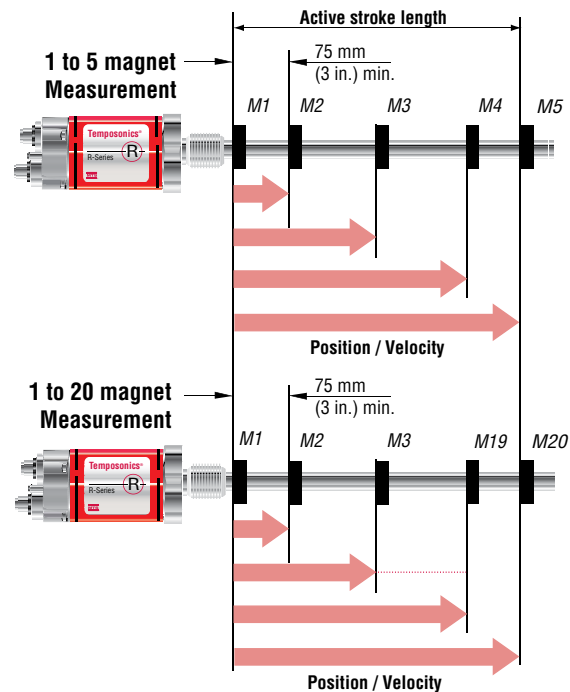

Figure 2. Single to multi-magnet output diagram

LINEARITY CORRECTION OPTION (LCO)

The Linearity Correction Option (LCO) provides improved sensor output accuracy. For most stroke lengths linearity accuracy is improved up to a factor of 5 resulting in deviations from actual position of less than $\pm 20 \mu$ m (0.0008 in.). For stroke lengths over 5000 mm (197 in.), the linearity accuracy is improved up to factor of 10. Selecting the sensor style and magnet is important (both must be matched together). Contact the factory for assistance when designing for the LCO in your application.

R-Series
EtherCAT®

R-Series Model RP Profile-Style Sensor Dimension References
Model RP - Standard Magnet and Mounting References

Model RP profile-style sensor dimension references

MODEL RP, PROFILE-STYLE SENSOR WITH CAPTIVE-SLIDING MAGNET Drawing is for reference only, contact applications engineering for tolerance specific information.

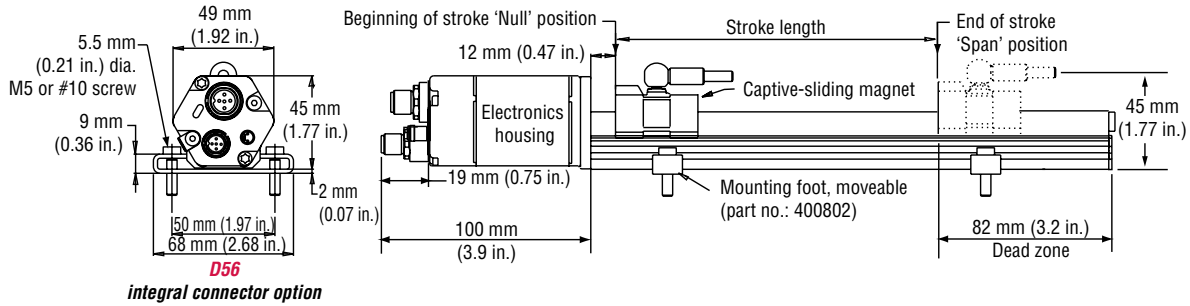

Figure 3. R-Series Model RP Profile-style sensor dimension reference (Shown with the **D56** connector option)

MODEL RP, PROFILE-STYLE SENSOR WITH OPEN-RING MAGNET Drawing is for reference only, contact applications engineering for tolerance specific information.

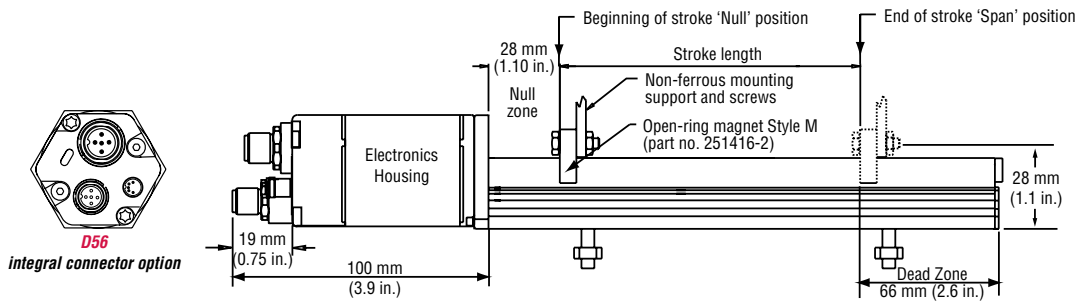



Figure 4. R-Series Model RP Profile-style sensor dimension reference (Shown with the **D56** connector option)

Standard magnet selections, mounting and installation (Model RP)

SELECTION OF POSITION MAGNETS (ONE MAGNET INCLUDED WITH MODEL RP SENSOR)

Temposonics Model RP profile-style sensors offer two basic mounting methods; side grooves for use with mounting feet or a bottom groove that accepts special T-Slot nuts. Both the mounting feet and T-Slot nuts can be positioned along the sensor extrusion to best secure the sensor for each particular application.

 Refer to the Accessories section of this catalog for magnet selections and detailed mounting and installation information.



Model RH rod-style sensor dimension reference

The Temposonics R-Series rod-style sensor (Model RH) offers modular construction, flexible mounting configurations, and easy installation. The Model RH sensor is designed for mounting in applications where high pressure conditions exist (5000 psi continuous, 10,000 psi spike) such as inside hydraulic cylinders. The Model RH sensor may also be mounted externally in many applications.

Stroke-dependent Dead Zones:	
Stroke length:	Dead zone:
25 mm (1 in.) - 5000 mm (197 in.)	63.5 mm (2.5 in.)
5005 mm (197 in.) - 7620 mm (300 in.)	66 mm (2.6 in.)

MODEL RH, ROD-STYLE SENSOR WITH RING MAGNET (MAGNET ORDERED SEPARATELY) Drawing is for reference only, contact applications engineering for tolerance specific information.

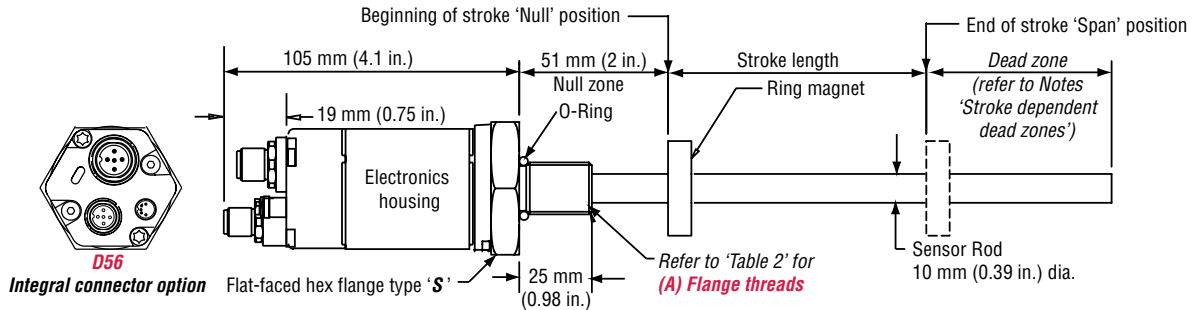

Figure 5. Model RH Rod-style sensor dimension reference (shown with **D56** integral connector options)

MODEL RH, ROD-STYLE SENSOR WITH RING MAGNET (MAGNET ORDERED SEPARATELY) Drawing is for reference only, contact applications engineering for tolerance specific information.

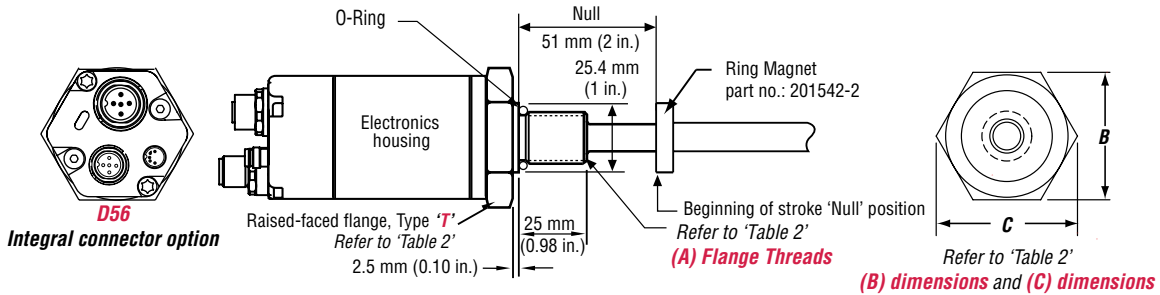



Figure 6. Model RH Rod-style sensor dimension reference (Shown with the **D56** Integral cable connection type option)

Housing style Flange type	Description	(A) Flange threads	(B) Dimensions	(C) Dimensions
T	US customary threads with raised-face flange	3/4" - 16 UNF-3A	1.75 in.	2 in.
S	US customary threads with flat-faced flange	3/4" - 16 UNF-3A	1.75 in.	2 in.
M	Metric threads with flat-faced flange	M18 x 1.5	46 mm	53 mm

Table 2. Model RH Rod-style sensor housing style and flange type references

Standard magnets, mounting and installation (Model RH)

Magnets must be ordered separately with Model RH position sensors. The standard ring magnet (part number 201542-2) is suitable for most applications.

 Refer to the Accessories section of this catalog for magnet selections and detailed mounting and installation information.



**R-Series Models RP and RH Sensors
Connections and Wiring**

Connections and wiring

(D56) BUS CONNECTOR OPTION

D56 connector option for 'daisy chain' topologies. A separate cable is used for the supply voltage. Unused connectors should be covered by a protective cap (part no.: 370537).



D56
Female
4-pin Bus In



D56
Female
4-pin Bus Out

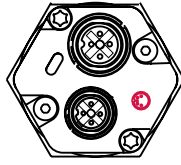

D56
Male, 4-pin
Input voltage

BUS CONNECTIONS IN/OUT



**Female, 4-pin (M12-D) Integral connector
pin-out as viewed from the end of the sensor**

Pin number	Cable color	Function
1	Yellow	Tx+
2	White	Rx+
3	Orange	Tx-
4	Blue	Rx-

INPUT VOLTAGE



**Input voltage, male, 4-pin (M8) integral
connector pin-out as viewed from the end of
the sensor**

Pin number	Cable color	Supply voltage
1	Brown	+24 Vdc (-15/+20%)
2	White	No connection
3	Blue	DC ground (for supply)
4	Black	No connection



Temposonics®

Magnetostrictive, Absolute, Non-contact
Linear-Position Sensors



R-Series Models RP and RH
EtherNet/IP™ Industrial Ethernet Interface

Document Part Number
551253 Revision C

Data Sheet

R-Series
EtherNet/IP



Model RP Profile-style position sensor



Model RH Rod-style position sensor

EtherNet/IP™
conformance tested

FEATURES

- Linear, Absolute Measurement
- LEDs For Sensor Diagnostics
- Superior Accuracy, Resolution down to 1 µm
- Non-Contact Sensing Technology
- Linearity Deviation Less Than 0.01%
- Repeatability Within 0.001%
- Direct EtherNet/IP Interface, Position + Velocity

BENEFITS

- Rugged Industrial Sensor
- Position + Velocity Measurements For Up to 20 Magnets

APPLICATIONS

- Continuous Operation In Harsh Industrial Conditions
- High Pressure Conditions
- For Accurate, Simultaneous Multi-Position and Velocity Measurements

TYPICAL INDUSTRIES

- Factory Automation
- Fluid Power
- Plastic Injection and Blow Molding
- Material Handling and Packaging



EtherNet/IP™ is a trademark used under license by ODVA.
EtherNet/IP CONFORMANCE TESTED™ is a certification mark of ODVA.



Sold & Serviced By:

ELECTROMATE

Toll Free Phone (877) SERV098

Toll Free Fax (877) SERV099

www.electromate.com

sales@electromate.com

R-Series RP and RH Sensors - EtherNet/IP™ Product Overview and Specifications

Product overview

Temposonics R-Series EtherNet/IP™ sensors represent MTS Sensors' development and product offering in networked position feedback. EtherNet/IP™ systems require only a single point of connection for both configuration and control, because EtherNet/IP supports both I/O (or implicit) messages—those that typically contain time-critical control data—and explicit messages—those in which the data field carries both protocol information and instructions for service performance. And, as a producer-consumer network that supports multiple communication hierarchies and message prioritization, EtherNet/IP™ provides more efficient use of bandwidth than a device network based on a source-destination model. EtherNet/IP systems can be configured to operate either in a master/slave or distributed control architecture using peer-to-peer communication.

Product specifications

R-Series
EtherNet/IP

Parameters	Specifications
OUTPUT	
Measured output variables:	Simultaneous multi-position and velocity measurements up to 20 magnets.
Resolution:	1 to 1000 µm selectable
Update time:	1.0 ms up to 2000 mm 2.0 ms up to 4800 mm, 4.0 ms up to 7600 mm stroke length
Linearity deviation:	< ± 0.01% full stroke (minimum ± 50 µm)
Repeatability:	< ± 0.001% full stroke (minimum ± 2.5 µm)
Hysteresis:	< 4 µm
Outputs:	Interface: EtherNet/IP™ Data transmission rate: 100 Mbit/s max.
Stroke length:	Range (Profile style): 25 mm to 5080 mm (1 in. to 200 in.) Range (Rod style): 25 mm to 7620 mm (1 in. to 300 in.)

ELECTRONICS

Operating voltage:	+24 Vdc nominal: -15% or +20%* Polarity protection: up to -30 Vdc Over voltage protection: up to 36 Vdc Current drain: 110 mA typical Dielectric withstand voltage: 500 Vdc (DC ground to machine ground)
---------------------------	--

* UL Recognition requires an approved power supply with energy limitation (UL 61010-1), or Class 2 rating according to the National Electrical Code (USA) / Canadian Electrical Code.

** The IP rating is not part of the UL Recognition.

Parameters	Specifications
ENVIRONMENTAL	
Operating conditions:	Operating temperature: -40 °C (-40 °F) to +75 °C (+167 °F) Relative humidity: 90% no condensation Temperature coefficient: < 15 ppm/°C
EMC test:	Electromagnetic emission: EN 61000-6-4 Electromagnetic susceptibility: EN 61000-6-2, EN 61000-4-2/3/4/6 CE qualified
Shock rating:	100 g (single hit)/IEC standard 68-2-27 (survivability)
Vibration rating:	15 g / 10 to 2000 Hz / IEC standard 68-2-6
WIRING	
Connection type:	D56 option: Two female 4-pin (M12-D) plus one 4-pin male (M8) connector

PROFILE STYLE SENSOR (MODEL RP)

Electronic head:	Aluminum housing with diagnostic LED display (LEDs located beside connectors)
Sealing:	IP 65**
Sensor extrusion:	Aluminum (Temposonics profile style)
Mounting:	Any orientation. Adjustable mounting feet or T-slot nut (M5 threads) in bottom groove
Magnet types:	Captive-sliding magnet or open-ring magnet

ROD STYLE SENSOR (MODEL RH)

Electronic head:	Aluminum housing with diagnostic LED display (LEDs located beside connectors)
Sealing:	IP 67**
Sensor rod:	304L stainless steel
Operating pressure:	350 bar static, 690 bar peak (5000 psi static, 10,000 psi peak)
Mounting:	Any orientation. Threaded flange M18 x 1.5 or 3/4 - 16 UNF-3A
Typical mounting torque:	45 N-m (33 ft. - lbs.)
Magnet types:	Ring magnet, open-ring magnet, or magnet float

Sold & Serviced By:
ELECTROMATE

Toll Free Phone (877) SERV098
Toll Free Fax (877) SERV099
www.electromate.com
sales@electromate.com

Enhanced monitoring and diagnostics

SENSOR STATUS AND DIAGNOSTIC DISPLAY

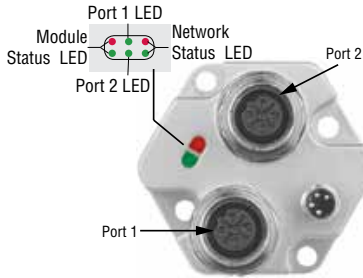

Integrated green and red diagnostic LEDs are located beside the sensor's connectors as shown in 'Figure 1', the LEDs provide basic visual monitoring for normal sensor operation and troubleshooting. These diagnostic display LEDs indicate four modes as described in 'Table 1. Diagnostic display indicator modes'

Figure 1. R-Series sensor Integrated diagnostic LEDs

ETHER-NET		
PORT 1 (INLET)		
Green	On:	Ethernet connection established
Green	Flickering:	Data activity
Red	On:	Magnet not detected or wrong quantity of magnets
PORT 2 (OUTLET)		
Green	On:	Ethernet connection established
Green	Flickering:	Data activity
NETWORK STATUS		
Green	On:	At least one connection established
Green	Flashing:	No connection established
Red	On:	Unrecoverable fault detected
Red	Flashing:	Recoverable fault detected
MODULE STATUS		
Green	On:	IP address configured
Green	Flashing:	IP address not configured
Red	Flashing:	Duplicate IP address detected

Table 1. Diagnostic display indicator modes

EtherNet/IP™ interface

EtherNet/IP™ is an Industrial Ethernet implementation of the Common Industrial Protocol (CIP), managed by the Open DeviceNet Vendors Association (ODVA), which defines communication services for automation. Ethernet/IP uses standard IEEE 802.3 technology at both the Physical Layer and Data Layers for compatibility with other applications and protocols. The protocol is also compliant with IEC 61158-2 for the physical layer and IEC 61784-1, -2 for measurement and control profiles.

Note:

Go to www.mtssensors.com to download latest EDS file.

This Ethernet/IP device also offers Device-Level-Ring (DLR) capability to directly connect devices to a ring topology without the use of external switches. DLR provides device-level network re-routing and failure point identification to improve reliability and network recovery time.

Operation modes and output

N101 Single and Multi-magnet position and velocity:

Up to 20 simultaneous magnet measurements are possible when using multiple magnets. The minimum allowed distance between magnets is 75 mm (3 in.) to maintain proper sensor output (see 'Figure 2').

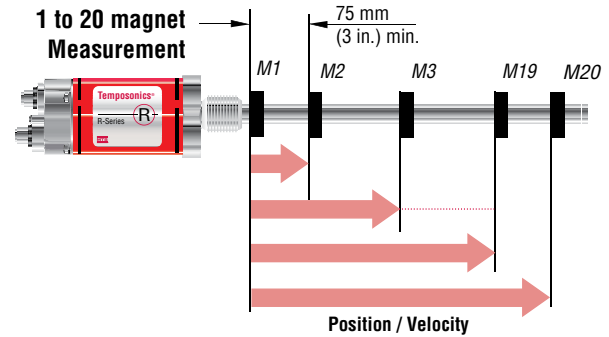

Figure 2. Single to multi-magnet output diagram

R-Series
 EtherNet/IP

R-Series Model RP Profile-Style Sensor Dimension References
Model RP - Standard Magnet and Mounting References

Model RP profile-style sensor dimension references

MODEL RP, PROFILE-STYLE SENSOR WITH CAPTIVE-SLIDING MAGNET

Drawing is for reference only, contact applications engineering for tolerance specific information.

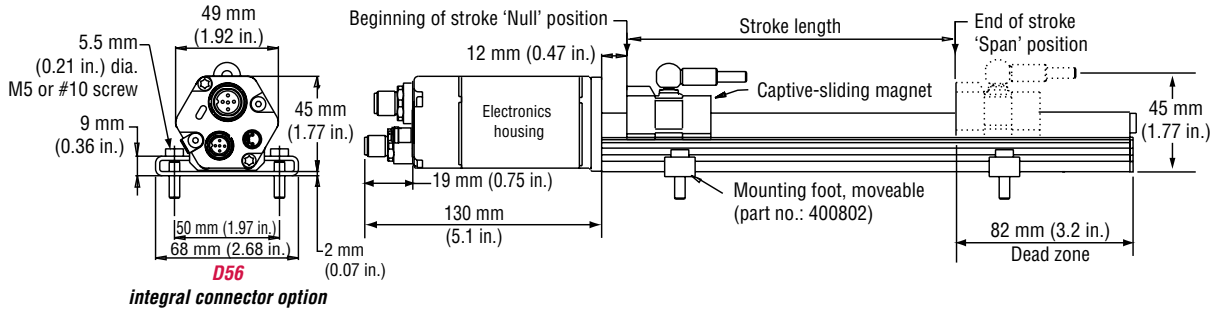

Figure 3. R-Series Model RP Profile-style sensor dimension reference (Shown with the **D56** connector option)

MODEL RP, PROFILE-STYLE SENSOR WITH OPEN-RING MAGNET

Drawing is for reference only, contact applications engineering for tolerance specific information.

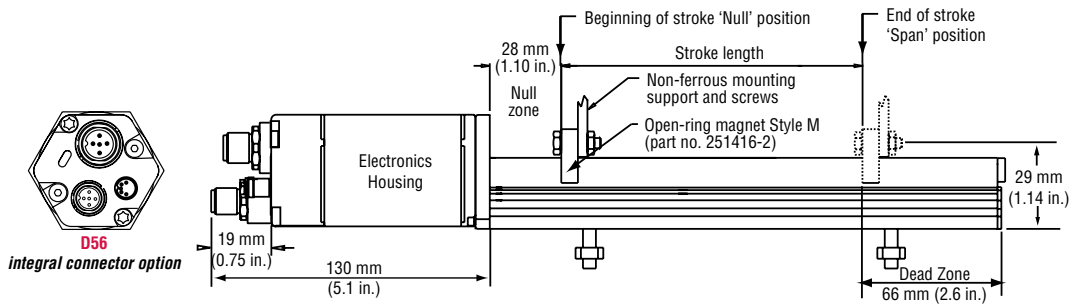



Figure 4. R-Series Model RP Profile-style sensor dimension reference (Shown with the **D56** connector option)

Standard magnet selections, mounting and installation (Model RP)

SELECTION OF POSITION MAGNETS (ONE MAGNET INCLUDED WITH MODEL RP SENSOR)

Temposonics Model RP profile-style sensors offer two basic mounting methods; side grooves for use with mounting feet or a bottom groove that accepts special T-Slot nuts. Both the mounting feet and T-Slot nuts can be positioned along the sensor extrusion to best secure the sensor for each particular application.

 Refer to the Accessories section of this catalog for magnet selections and detailed mounting and installation information.

**R-Series
EtherNet/IP**

Model RH rod-style sensor dimension reference

The Temposonics R-Series rod-style sensor (Model RH) offers modular construction, flexible mounting configurations, and easy installation. The Model RH sensor is designed for mounting in applications where high pressure conditions exist (5000 psi continuous, 10,000 psi spike) such as inside hydraulic cylinders. The Model RH sensor may also be mounted externally in many applications.

Stroke-dependent Dead Zones:	
Stroke length:	Dead zone:
25 mm (1 in.) - 5000 mm (197 in.)	63.5 mm (2.5 in.)
5005 mm (197 in.) - 7620 mm (300 in.)	66 mm (2.6 in.)

MODEL RH, ROD-STYLE SENSOR WITH RING MAGNET (MAGNET ORDERED SEPARATELY)

Drawing is for reference only, contact applications engineering for tolerance specific information.

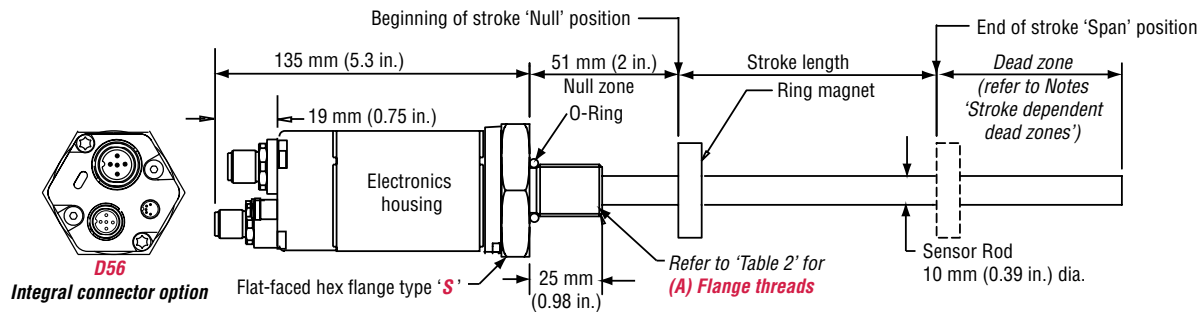

Figure 5. Model RH Rod-style sensor dimension reference (shown with **D56** integral connector options)

MODEL RH, ROD-STYLE SENSOR WITH RING MAGNET (MAGNET ORDERED SEPARATELY)

Drawing is for reference only, contact applications engineering for tolerance specific information.

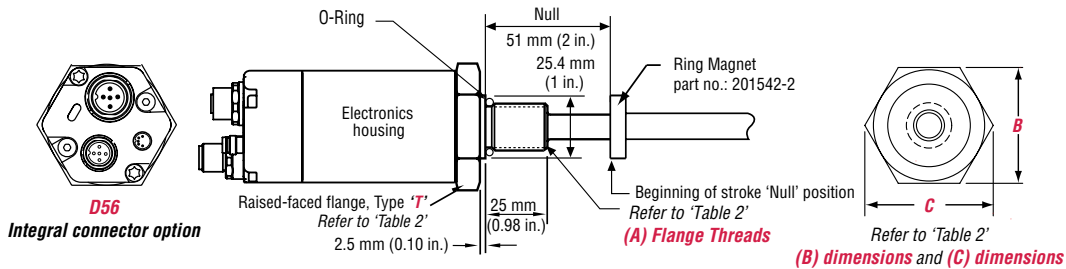

Figure 6. Model RH Rod-style sensor dimension reference (Shown with the **D56** Integral cable connection type option)

Housing style Flange type	Description	(A) Flange threads	(B) Dimensions	(C) Dimensions
T	US customary threads with raised-face flange	3/4" - 16 UNF-3A	1.75 in.	2 in.
S	US customary threads with flat-faced flange	3/4" - 16 UNF-3A	1.75 in.	2 in.
M	Metric threads with flat-faced flange	M18 x 1.5	46 mm	53 mm

Table 2. Model RH Rod-style sensor housing style and flange type references

Standard magnets, mounting and installation (Model RH)

Magnets must be ordered separately with Model RH position sensors. The standard ring magnet (part number 201542-2) is suitable for most applications.

Refer to the Accessories section of this catalog for magnet selections and detailed mounting and installation information.

**Models RP and RH Sensors
Connections and Wiring**

Connections and wiring

(D56) BUS CONNECTOR OPTION

D56 connector option for 'daisy chain' topologies. A separate cable is used for the supply voltage. Unused connectors should be covered by a protective cap (part no.: 370537).

**R-Series
EtherNet/IP**



D56
Female
4-pin Bus
Port 1



D56
Female
4-pin Bus
Port 2

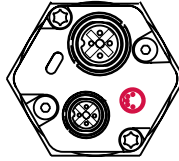

D56
Male, 4-pin
Input voltage

BUS CONNECTIONS PORTS 1 AND 2



**Female, 4-pin (M12-D) Integral connector
pin-out as viewed from the end of the sensor**

Pin number	Cable color	Function
1	Yellow	Tx+
2	White	Rx+
3	Orange	Tx-
4	Blue	Rx-

INPUT VOLTAGE



**Input voltage, male, 4-pin (M8) integral
connector pin-out as viewed from the end of
the sensor**

Pin number	Cable color	Supply voltage
1	Brown	+24 Vdc (-15/+20%)
2	White	No connection
3	Blue	DC ground (for supply)
4	Black	No connection

Sold & Serviced By:

ELECTROMATE

Toll Free Phone (877) SERV098

Toll Free Fax (877) SERV099

www.electromate.com

sales@electromate.com

Temposonics®

Magnetostrictive, Absolute, Non-contact
Linear-Position Sensors



R-Series Models RP and RH Profinet Interface

Document Part Number
551451 Revision B

Data Sheet



Model RP Profile-style position sensor



Model RH Rod-style position sensor

R-Series
Profinet

FEATURES

- Linear, Absolute Measurement
- LEDs For Sensor Diagnostics
- Superior Accuracy, Resolution down to 1 μm
- Non-Contact Sensing Technology
- Linearity Deviation Less Than 0.01%
- Repeatability Within 0.001%
- Intergrated Profinet IRT switch

BENEFITS

- Rugged Industrial Sensor
- Position + Velocity Measurements For Up to 19 Magnets

APPLICATIONS

- Continuous Operation In Harsh Industrial Conditions
- High Pressure Conditions
- For Accurate, Simultaneous Multi-Position and Velocity Measurements

TYPICAL INDUSTRIES

- Factory Automation
- Fluid Power
- Plastic Injection and Blow Molding
- Material Handling and Packaging



Sold & Serviced By:



Toll Free Phone (877) SERV098
Toll Free Fax (877) SERV099
www.electromate.com
sales@electromate.com

Product Overview and Specifications

Product overview

The sensor meets the requirements of the Profinet IO industrial Ethernet standards and can be directly operating in a network with decentralized peripherals. Profinet is characterized by a high data transfer and high real-time capability. It's officially certified by the PNO (Profinet user organization).

Product specifications

Parameters	Specifications
OUTPUT	
Measured output variables:	Simultaneous multi-position or velocity measurements up to 19 magnets.
Resolution:	1 to 100 μm selectable
Update time:	Dependent on stroke length
Motion control cycle time:	Minimum 1 ms
Linearity deviation:	$< \pm 0.01\%$ full stroke (minimum $\pm 50 \mu\text{m}$)
Repeatability:	$< \pm 0.001\%$ full stroke (minimum $\pm 2.5 \mu\text{m}$)
Hysteresis:	$< 4 \mu\text{m}$
Outputs:	Interface: Profinet IO RT Data transmission rate: 100 Mbit/s max.
Stroke length:	Range (Profile style): 25 mm to 5080 mm (1 in. to 200 in.) Range (Rod style): 25 mm to 7620 mm (1 in. to 300 in.)
ELECTRONICS	
Operating voltage:	+24 Vdc nominal: -15% or +20%* Polarity protection: up to -30 Vdc Over voltage protection: up to 36 Vdc Current drain: 110 mA typical Dielectric withstand voltage: 500 Vdc (DC ground to machine ground)

Parameters	Specifications
ENVIRONMENTAL	
Operating conditions:	Operating temperature: -40 °C (-40 °F) to +75 °C (+167 °F) Relative humidity: 90% no condensation Temperature coefficient: $< 15 \text{ ppm}/^\circ\text{C}$
EMC test:	Electromagnetic emission: EN 61000-6-4 (for industrial environments) Electromagnetic immunity: EN 61000-6-2 (The sensor meets the requirements of the EC directives and is marked with CE)
Shock rating:	100 g (single hit)/IEC standard 60068-2-27 (survivability)
Vibration rating:	15 g / 10 to 2000 Hz / IEC standard 60068-2-6 (resonance frequencies excluded)
WIRING	
Connection type:	D58 option: Two female 4-pin (M12-D) plus one 4-pin male (M12-A) connector
PROFILE STYLE SENSOR (MODEL RP)	
Electronic head:	Aluminum housing with diagnostic LED display (LEDs located beside connectors)
Sealing:	IP 65**
Sensor extrusion:	Aluminum (Temposonics profile style)
Mounting:	Any orientation. Adjustable mounting feet or T-slot nut (M5 threads) in bottom groove
Magnet types:	Captive-sliding magnet or open-ring magnet
ROD STYLE SENSOR (MODEL RH)	
Electronic head:	Aluminum housing with diagnostic LED display (LEDs located beside connectors)
Sealing:	IP 67**
Sensor rod:	304L stainless steel
Operating pressure:	350 bar static, 690 bar peak (5000 psi static, 10,000 psi peak)
Mounting:	Any orientation. Threaded flange M18 x 1.5 or 3/4 - 16 UNF-3A
Typical mounting torque:	45 N-m (33 ft. - lbs.)
Magnet types:	Ring magnet, open-ring magnet, or magnet float

* UL Recognition requires an approved power supply with energy limitation (UL 61010-1), or Class 2 rating according to the National Electrical Code (USA) / Canadian Electrical Code.

** The IP rating is not part of the UL Recognition.

R-Series
Profinet

Enhanced monitoring and diagnostics

SENSOR STATUS AND DIAGNOSTIC DISPLAY



Integrated LED (green/red) provides basic visual feedback for normal sensor operation and troubleshooting.

Figure 1. R-Series sensor Integrated diagnostic LEDs

Green	Red	Description
ON	OFF	Normal function
ON	ON	No master contact
ON	Flashing	Parametrization failed

Table 1. Diagnostic display indicator modes

Profinet interface

Profinet versions

The sensor can be ordered in following versions:

- Encoder Profile 4.1: PNO standardized profile
- MTS Communication Profile: It allows a simultaneous position measurement up to 19 positions. The configuration is similar to the sequence of Temposonics® Profibus sensors

Operation modes and output

Single and Multi-magnet position and velocity:

Up to 19 simultaneous magnet measurements are possible when using multiple magnets. The minimum allowed distance between magnets is 75 mm (3 in.) to maintain proper sensor output (see 'Figure 2').

U401

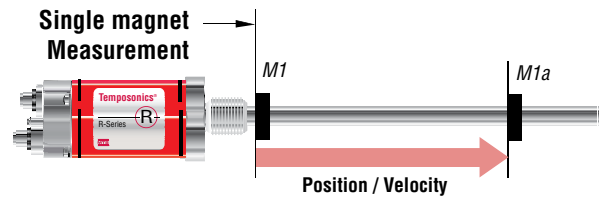

U402

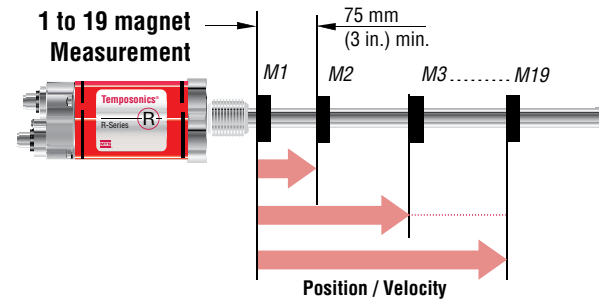

Figure 3. Single and multi-magnet output diagram

R-Series
Profinet

Model RP Profile-Style Sensor
Sensor Dimension References

Model RP profile-style sensor dimension references

MODEL RP, PROFILE-STYLE SENSOR WITH CAPTIVE-SLIDING MAGNET

Drawing is for reference only, contact applications engineering for tolerance specific information.

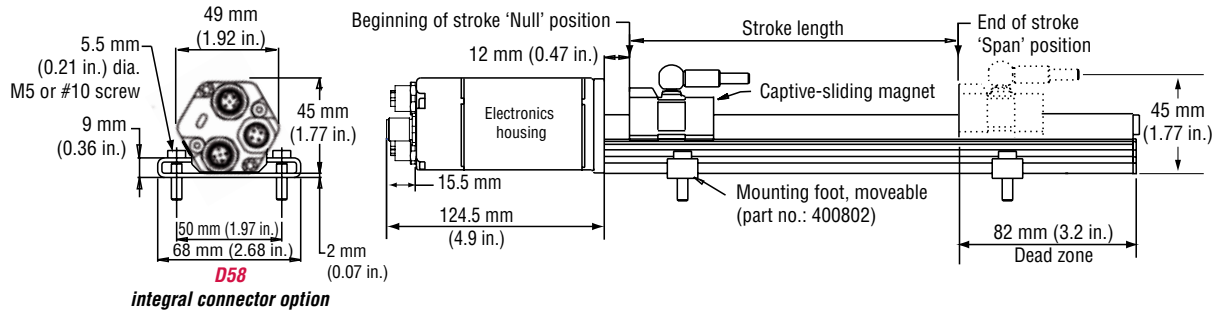

Figure 4. R-Series Model RP Profile-style sensor dimension reference (Shown with the **D58** connector option)

MODEL RP, PROFILE-STYLE SENSOR WITH OPEN-RING MAGNET

Drawing is for reference only, contact applications engineering for tolerance specific information.

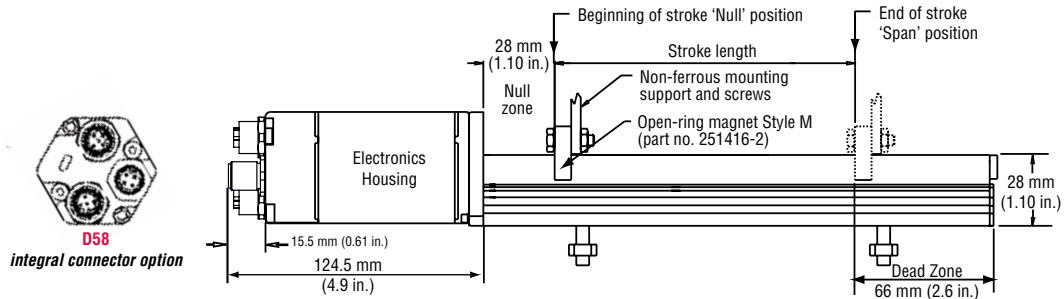



Figure 5. R-Series Model RP Profile-style sensor dimension reference (Shown with the **D58** connector option)

Standard magnet selections, mounting and installation (Model RP)

SELECTION OF POSITION MAGNETS (ONE MAGNET INCLUDED WITH MODEL RP SENSOR)

Temposonics Model RP profile-style sensors offer two basic mounting methods; side grooves for use with mounting feet or a bottom groove that accepts special T-Slot nuts. Both the mounting feet and T-Slot nuts can be positioned along the sensor extrusion to best secure the sensor for each particular application.

 Refer to the Accessories section of this catalog for magnet selections and detailed mounting and installation information.

**R-Series
Profinet**

Model RH rod-style sensor dimension reference

The Temposonics R-Series rod-style sensor (Model RH) offers modular construction, flexible mounting configurations, and easy installation. The Model RH sensor is designed for mounting in applications where high pressure conditions exist (5000 psi continuous, 10,000 psi spike) such as inside hydraulic cylinders. The Model RH sensor (see 'Figure 5') may also be mounted externally in many applications.

Stroke-dependent Dead Zones:	
Stroke length:	Dead zone:
25 mm (1 in.) - 5000 mm (197 in.)	63.5 mm (2.5 in.)
5005 mm (197 in.) - 7620 mm (300 in.)	66 mm (2.6 in.)

MODEL RH, ROD-STYLE SENSOR WITH RING MAGNET (MAGNET ORDERED SEPARATELY)

Drawing is for reference only, contact applications engineering for tolerance specific information.

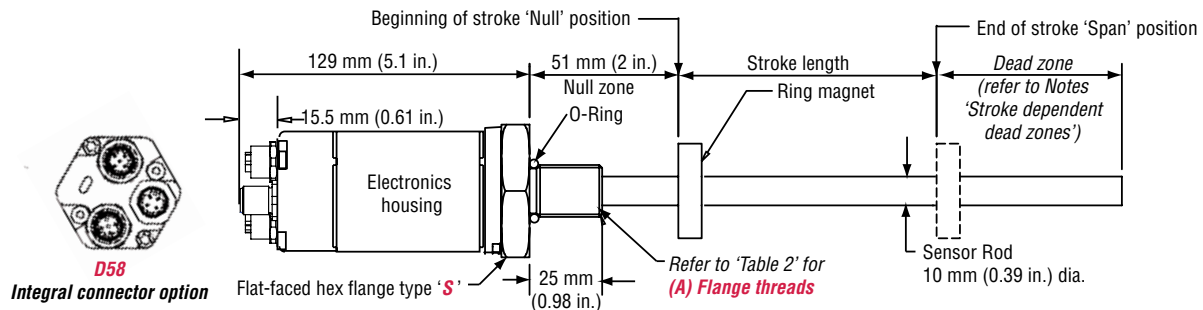

Figure 6. Model RH Rod-style sensor dimension reference (shown with **D58** integral connector options)

MODEL RH, ROD-STYLE SENSOR WITH RING MAGNET (MAGNET ORDERED SEPARATELY)

Drawing is for reference only, contact applications engineering for tolerance specific information.

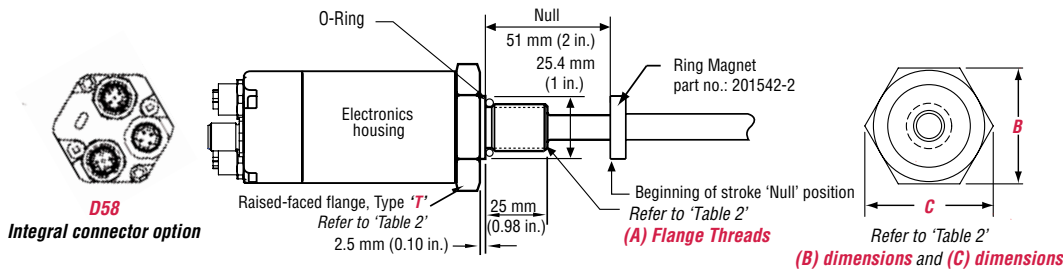



Figure 7. Model RH Rod-style sensor dimension reference (Shown with the **D58** Integral cable connection type option)

Housing style Flange type	Description	(A) Flange threads	(B) Dimensions	(C) Dimensions
T	US customary threads with raised-face flange	3/4" - 16 UNF-3A	1.75 in.	2 in.
S	US customary threads with flat-faced flange	3/4" - 16 UNF-3A	1.75 in.	2 in.
M	Metric threads with flat-faced flange	M18 x 1.5	46 mm	53 mm

Model RH Rod-style sensor housing style and flange type references

Standard magnets, mounting and installation (Model RH)

Magnets must be ordered separately with Model RH position sensors. The standard ring magnet (part number 201542-2) is suitable for most applications.

 Refer to the Accessories section of this catalog for magnet selections and detailed mounting and installation information.

**R-Series
Profinet**

**Model RH Rod-Style Sensor Mounting
Cylinder Installation and Connections**

Connections and wiring

(D58) BUS CONNECTOR OPTION

D58 connector option for 'daisy chain' topologies. A separate cable is used for the supply voltage. Unused connectors should be covered by a protective cap (part no.: 370537).

BUS CONNECTIONS PORTS 1 AND 2



Female, 4-pin (M12-D) Integral connector pin-out as viewed from the end of the sensor

Pin number	Cable color	Function
1	Yellow	Tx+
2	White	Rx+
3	Orange	Tx-
4	Blue	Rx-

INPUT VOLTAGE



Input voltage, male, 4-pin (M12-A) integral connector pin-out as viewed from the end of the sensor

Pin number	Cable color	Supply voltage
1	Brown	+24 Vdc (-15/+20%)
2	White	No connection
3	Blue	DC ground (for supply)
4	Black	No connection



Temposonics®

Magnetostrictive, Absolute, Non-contact
Linear-Position Sensors



R-Series Model RD4 Direct Position and Velocity Output

Document Part Number
551166 Revision B

Data Sheet



Model RD4 compact sensor with detached electronics

R-Series
RD4

FEATURES

- R-Series Detached Electronics Sensor
- Linear, Absolute Measurement
- Non-Contact Sensing Technology
- Linearity Deviation Less Than 0.02%
- Repeatability Within 0.001%
- Full Range of Outputs: Voltage, Current, SSI, CANbus, DeviceNet, Profibus, EtherCAT® and EtherNet/IP
- Simultaneous Multi-Position and Velocity Measurements
- LEDs For Sensor Status and Diagnostics

BENEFITS

- Detached Sensor Electronics Provide for the Smallest R-Series sensor Head
- Allows Isolating the Sensor Electronics From High Temperatures, High Vibration / Shock, or Other Environmental Extremes

APPLICATIONS

- Clevis Mount Cylinders Having Minimal Space Available
- High Temperatures or High Vibration / Shock Levels that Require Remote Mounting of the Sensor Electronics
- Space Limited Applications

TYPICAL INDUSTRIES

- Fluid Power
- Steel Mills
- Material Handling and Packaging
- Woodworking, Metalworking and Assembly Tools



EtherNet/IP™ is a trademark used under license by ODVA.
EtherNet/IP CONFORMANCE TESTED™ is certification mark of ODVA.

Sold & Serviced By:

Toll Free Phone (877) SERV098
Toll Free Fax (877) SERV099
www.electromate.com
sales@electromate.com

R-Series Model RD4
Product Overview, Output and Specifications

Product overview

The Temposonics RD4 position sensor provides an added degree of flexibility compared to the standard R-Series rod style sensor package. The RD4 design utilizes a separate electronics housing and interconnection cable to allow installation of the sensor rod into small spaces. By relocating the electronics, the head of the sensor rod is reduced to its minimal size. This makes the RD4 ideal for use with clevis mount cylinders or any space limited cylinder application. Also, the RD4 sensor can be used for applications that require remote mounting of the sensor electronics due to environmental factors, such as, high temperatures or high levels of shock and vibration.

The RD4 interconnection cable exits the head of the sensor rod and connects to the electronics housing. The electronics housing, along with its mounting block, can be configured with either a side cable connection or a bottom cable connection. The side cable connection is for use with threaded rod styles; 'M', 'T', 'C' and 'D'. These threaded rod styles provide for easy sensor installation into a standard threaded port opening on the top of the cylinder end cap.

The bottom cable connection is for use with the pressure-fit rod style (i.e. style 'S'). The rod style 'S' requires an appropriately machined cavity in the cylinder end cap to house the head of the sensor rod. Also, a hole going through the end cap is needed to channel the interconnection cable to the electronics housing that mounts on the side of the end cap. Proper design and careful sensor installation is required to assure the correct fit and o-ring sealing. MTS factory assistance is recommended when designing for the rod style 'S' in all new RD4 applications.

Output options

The R-Series Model RD4 sensor is available in voltage, current, SSI, CANbus, DeviceNet, Profibus, EtherCAT® and EtherNet/IP outputs.

Important specification note:

For R-Series model specific specifications, consult the individual data sheets applicable to the sensor output(s) for your application.

Product specifications

**R-Series
RD4**

Parameters	Specifications
OUTPUT	
Measured output variables:	Position, velocity, simultaneous multi-position and velocity measurements. (Measured output variables depend on the complete sensor model used.)
Resolution:	Output dependent
Update times:	Output dependent
Linearity deviation:	< ± 0.02% full stroke (minimum ± 50 µm) ‡
	‡ For rod style 'S' the linearity deviation can be higher in the first 30 mm (1.2 in.) of stroke length.
Repeatability:	< ± 0.001% full stroke (minimum ± 2.5 µm)
Hysteresis:	< 4 µm, 2 µm typical
Outputs:	Voltage, current, SSI, CANbus, DeviceNet, Profibus, EtherCAT and EtherNet/IP
Stroke length:	25 to 5080 mm (1 to 200 in.) 25 to 2540 mm (1 to 100 in.) for rod style 'S'
ELECTRONICS	
Operating voltage:	+24 Vdc nominal: -15% or +20% Polarity protection: up to -30 Vdc Over voltage protection: up to 36 Vdc Current drain: Output dependent Dielectric withstand voltage: 500 Vdc (DC ground to machine ground)
ENVIRONMENTAL	
Operating conditions:	Operating temperature: Sensor electronics: Output dependent Sensor rod: -40 °C (-40 °F) to +100 °C (+212 °F) Relative humidity: 90% no condensation

Parameters	Specifications
EMC test‡:	Electromagnetic emission: IEC/EN 50081-1 Electromagnetic susceptibility: IEC/EN 50082-2 IEC/EN 61000-4-2/3/4/6, level 3/4 criterium A, CE qualified ‡ Sensor rod and interconnection cable is mounted inside a hydraulic housing or metal housing.
Shock rating:	100 g (single hit)/ IEC standard 68-2-27 (survivability)
Vibration rating:	10 g/10 to 2000 Hz, IEC standard 68-2-6
WIRING	
Connection type:	Connector or integral cable (output dependent)
ROD STYLE SENSOR (MODEL RD4)	
Electronic head:	Aluminum housing with diagnostic LED display. (LEDs located beside connector/cable exit)
Sealing:	Sensor electronics: IP 67 (with professionally mounted housing and connectors) Sensor rod head with interconnection cable: Threaded style (IP 65) and pressure fit style (IP 30)
Sensor rod:	304L stainless steel
Operating pressure:	350 bar static, 690 bar peak (5000 psi, 10,000 psi peak)
Mounting:	Any orientation. Threaded flange M18 x 1.5 or 3/4 - 16 UNF-3A or non-threaded pressure fit
Typical mounting torque:	45 N-m (33 ft. -Lbs.)
Magnet types:	Ring magnet, open-ring magnet or magnet float

Model RD4 sensor dimension references

R-SERIES RD4 SENSOR WITH SIDE CABLE ELECTRONICS CONNECTION AND ROD STYLE 'M' OR 'T'

Drawing is for reference only, contact applications engineering for tolerance specific information.

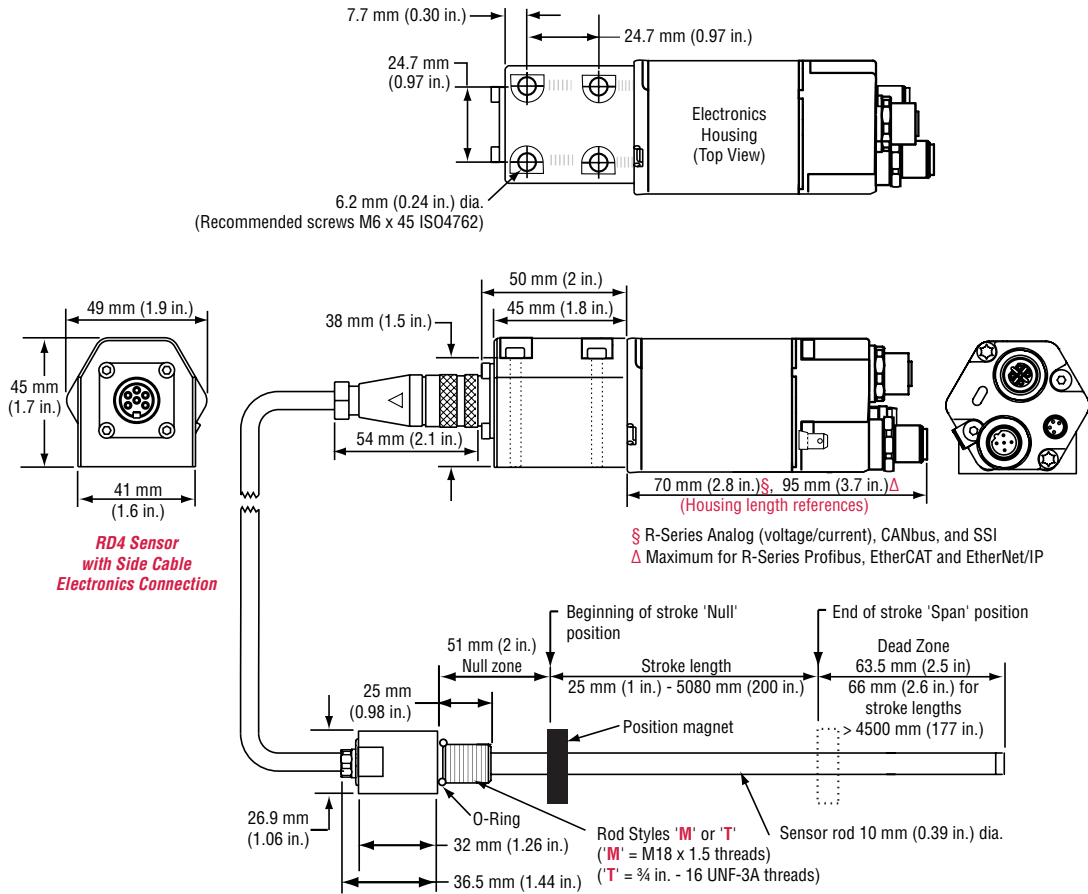

R-Series
RD4

Figure 1. R-Series Model RD4 sensor with side cable electronics connection and rod style 'M' or 'T'

R-SERIES RD4 SENSOR WITH SIDE CABLE ELECTRONICS CONNECTION AND ROD STYLE 'C' OR 'D'

Drawing is for reference only, contact applications engineering for tolerance specific information.

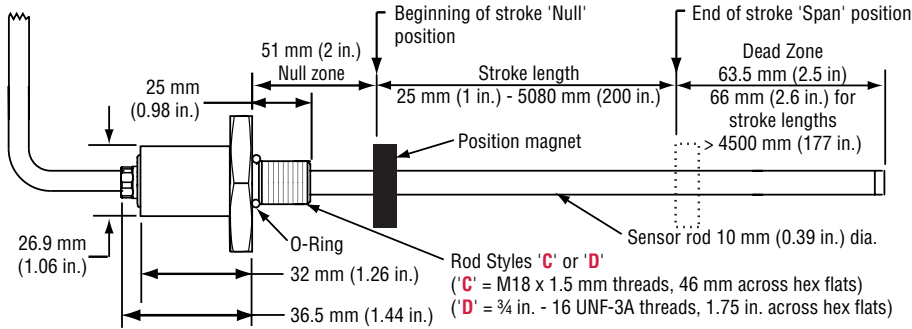
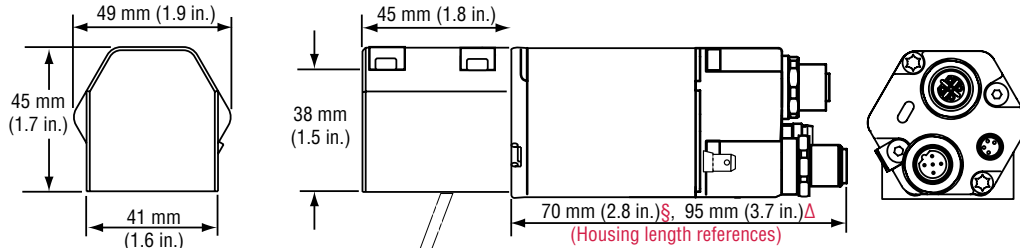
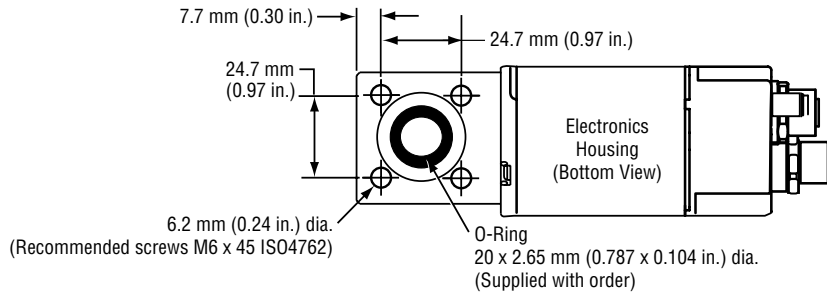
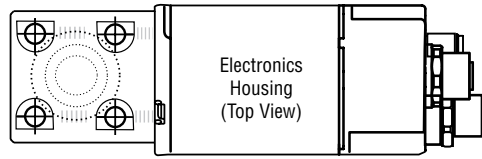

Figure 2. R-Series Model RD4 sensor with side cable electronics connection and rod style 'C' or 'D'

R-Series Model RD4 Sensor
Dimension and Magnet Selection References

R-SERIES RD4 SENSOR WITH BOTTOM CABLE ELECTRONICS CONNECTION AND ROD STYLE 'S'
 Drawing is for reference only, contact applications engineering for tolerance specific information.



RD4 Sensor with Bottom Cable Electronics Connection

§ R-Series Analog (voltage/current), CANbus and SSI outputs
 Δ Maximum for R-Series Profibus, EtherCAT and EtherNet/IP outputs

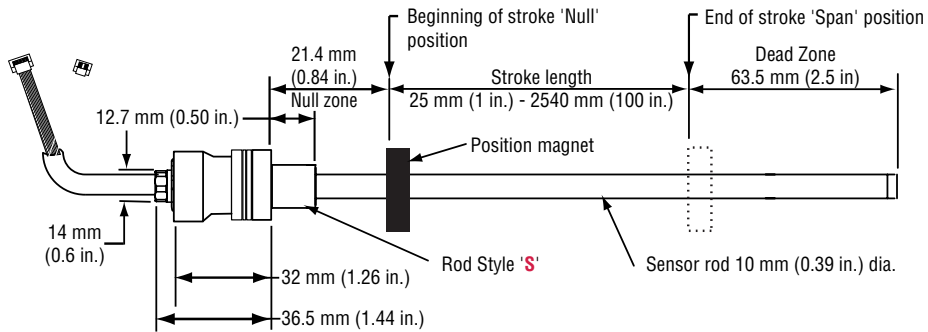

Figure 3. R-Series Model RD4 sensor with bottom cable electronics connection and rod style 'S'

Standard magnet selections (Model RD4)

Magnets must be ordered separately with Model RD4 position sensors. The standard ring magnet (part number 201542-2) is suitable for most applications.

Refer to the Accessories section of this catalog for magnet selections.

R-Series RD4

Sensor cylinder installation for side cable connection and threaded rod styles

Cylinder Installation Note:

The position magnet requires minimum distances away from ferrous metals to allow proper sensor output. The minimum distance from the front of the magnet to the cylinder end cap is 15 mm (0.6 in.). The minimum distance from the back of the magnet to the piston head is 3.2 mm (0.125 in.). However, a minimum distance of at least 5 mm (0.197 in.) is preferred for added performance margin. The non-ferrous spacer (part no.: 400633), provides this minimum distance when used along with the standard ring magnet (part no.: 201542-2).

R-SERIES RD4 SENSOR CYLINDER INSTALLATION WITH SIDE CABLE CONNECTION AND ROD STYLES 'M' AND 'T'

Drawing is for reference only, contact applications engineering for tolerance specific information.

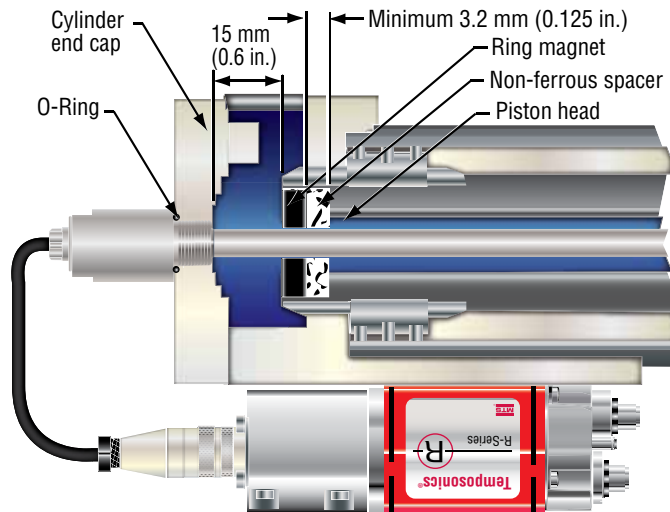

R-Series
RD4

Figure 4. R-Series Model RD4 sensor installation using side cable connection and rod styles 'M' or 'T'

R-SERIES RD4 SENSOR CYLINDER INSTALLATION FOR SIDE CABLE CONNECTION AND ROD STYLES 'C' AND 'D'

Drawing is for reference only, contact applications engineering for tolerance specific information.

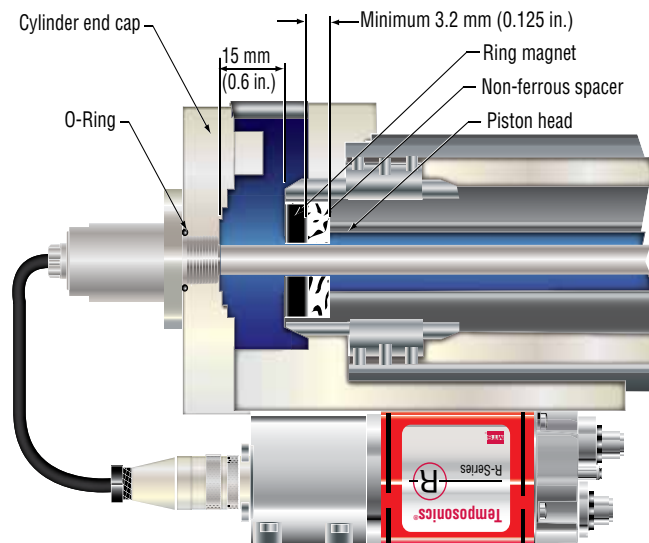

Figure 5. R-Series Model RD4 sensor installation using side cable connection and rod styles 'C' and 'D'

R-Series Model RD4 Sensors
Installation and Mounting References

Sensor cylinder installation for bottom cable connection and pressure fit rod style

R-SERIES RD4 SENSOR CYLINDER INSTALLATION FOR BOTTOM CABLE CONNECTION AND PRESSURE FIT ROD STYLE 'S'

Drawing is for reference only, contact applications engineering for tolerance specific information.

Pressure fit rod style 'S' installation Notes:

1. The position magnet requires minimum distances away from ferrous metals to allow proper sensor output. When using rod style 'S' mounted inside a cylinder end cap, the minimum distance from the front of the magnet to the cylinder end cap is 21 mm (0.83 in.).
2. The minimum distance from the back of the magnet to the piston head is 3.2 mm (0.125 in.). However, a minimum distance of at least 5 mm (0.197 in.) is preferred for added performance margin. The non-ferrous spacer (part no.: 400633), provides this minimum distance when used along with the standard ring magnet (part no.: 201542-2).
3. In the event that the position magnet is to be secured in the piston head by using a ferrous circlip, then an additional non-ferrous spacer is recommended on the front side of the magnet (as shown below ‡).

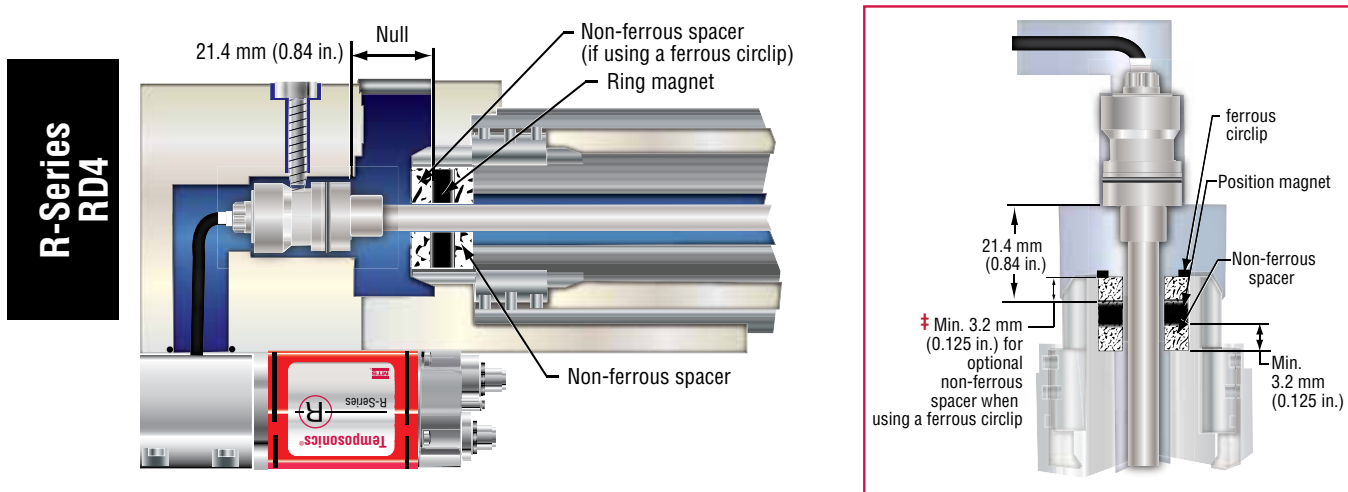

Figure 6. R-Series Model RD4 sensor installation using bottom cable connection and pressure fit rod style 'S'

Cylinder end cap mounting and pressure-fit rod style 'S' detail references

Drawings are for reference only, contact applications engineering for tolerance specific information.

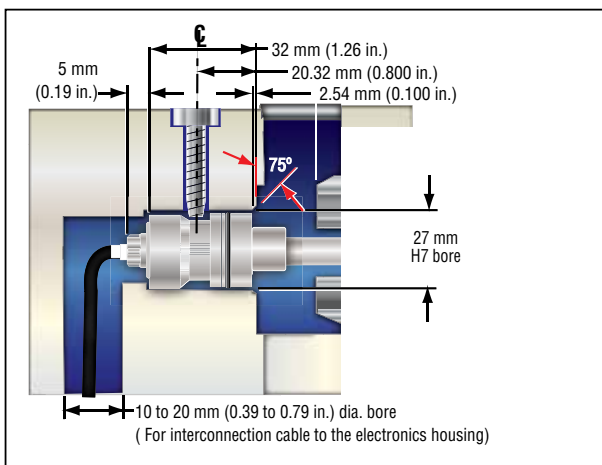

Figure 7. Cylinder end cap mounting detail reference

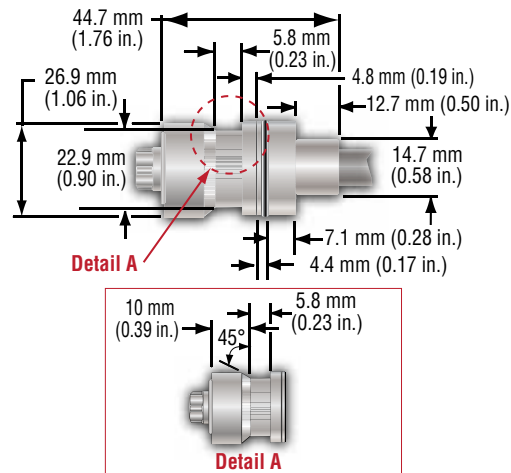

Figure 8. Pressure fit rod style 'S' details

Temposonics®

Magnetostrictive, Absolute, Non-contact
Linear-Position Sensors



R-Series Model RF Flexible Housing Option

Document Part Number
551081 Revision C

Data Sheet



Model RF flexible housing option for R-Series sensors with voltage, current, SSI, CANbus, DeviceNet, Profibus, EtherCAT® and EtherNet/IP™ outputs

FEATURES

- Linear, Absolute Measurement Along an Arc
- LEDs For Sensor Diagnostics
- Non-Contact Sensing Technology
- Linearity Deviation Less Than 0.02%
- Repeatability Within 0.001%
- Flexible Housing is Optional For MTS R-Series Sensors With The Following Full Range of Outputs:
Voltage, Current, SSI, CANbus, DeviceNet, Profibus, EtherCAT® and EtherNet/IP™
- Measuring Stroke Range:
255 mm (10 in.) to 10,060 mm (396 in.)
(Contact factory for longer stroke lengths)

BENEFITS

- Rugged Industrial Sensor
- Multi-Magnet Position Measurement: Up to 20 Positions
- 100% Field Adjustable Null And Span Setpoints
- Cost Effective, Convenient Shipping for Long Measuring Lengths

APPLICATIONS

- Hydraulic Cylinder Applications with Limited Sensor Installation Space
- Accurate Position Measurement Along an Arc
- Very Long Measurement Lengths

TYPICAL INDUSTRIES

- Fluid Power
- Steel Mills Using Long Cylinders
- Material Handling and Packaging
- Woodworking, Metalworking and Assembly Tools
- Converting Machines

EtherNet/IP™ is a trademark used under license by ODVA.
EtherNet/IP CONFORMANCE TESTED™ is certification mark of ODVA.

EtherCAT® Technology Group **EtherNet/IP™**
conformance tested



R-Series
RF Flex

Sold & Serviced By:

Toll Free Phone (877) SERV098
Toll Free Fax (877) SERV099
www.electromate.com
sales@electromate.com

R-Series Model RF
Product Overview and Specifications

Product overview

MTS offers the Model RF Flexible housing as an option with our R-Series family of extremely robust, highly accurate, linear-position sensors.

Constructing a R-Series sensor with the RF flexible housing results in a flexible style sensor that offers trouble-free performance in applications that require very long stroke lengths and linear measurements on an arc.

The Model RF flexible sensors are available in all R-Series sensor outputs including analog, serial, digital, and bus interfaces. Standard stroke lengths for the sensor are up to 10 meters (396 in.) and for special applications, longer lengths are available by consulting the factory.

Flexible sensors incorporate the Temposonics SE (Sensing Element) technology that is the same building block all MTS sensor models use. The SE is housed in a fluoroelelastomer coated stainless steel housing that is flexible and can be bent in an arc to an 8 inch minimum bend radius.

Most operating parameters are identical to their rigid cousins. Model RF sensors are recommended for long-length applications because they are simply coiled inside a 40-inch diameter box for shipping, which simplifies logistics and handling.

The model RF sensor can easily bend around corners or obstacles and provides a simple solution for applications where installation space is too confined, or has limited access, making installation or replacement too difficult and costly for a standard rigid type sensor.

Output options

The Model RF Flexible Housing option is available for R-Series Sensors with voltage, current, SSI, CANBus, DeviceNet, Profibus, EtherCAT and EtherNet/IP outputs.

Important specification notes:

1. For R-Series model specific specifications, consult the individual R-Series data sheets applicable to the sensor output(s) being used.
2. All sensors constructed with the flexible housing have their specifications measured while laying flat.

*Sensor's flexible rod is installed inside the optional stainless steel half inch O.D. pressure pipe housing.

Product specifications

Parameters	Specifications
OUTPUT	
Measured output variables:	Position, velocity, simultaneous multi-position and velocity measurements. (Measured output variables depend on the complete sensor model used.)
Resolution:	Output dependent
Update times:	Output dependent
Linearity deviation:	< ± 0.02% full stroke (minimum ± 100 µm) Linearity Correction Option (LCO) available for some R-Series models
Repeatability:	< ± 0.001% full stroke (minimum ± 2.5 µm)
Hysteresis:	< 4 µm, 2 µm typical
Outputs:	Voltage, current, SSI, CANbus, DeviceNet, Profibus, EtherCAT and EtherNet/IP
Measuring range:	255 to 10,060 mm (10 to 396 in.) (Contact factory for longer stroke lengths)
ELECTRONICS	
Operating voltage:	+24 Vdc nominal: -15% or +20% Polarity protection: up to -30 Vdc Over voltage protection: up to 36 Vdc Current drain: Output dependent Dielectric withstand voltage: 500 Vdc (DC ground to machine ground)
ENVIRONMENTAL	
Operating conditions:	Operating temperature: -40 °C (-40 °F) to +75 °C (+167 °F) Relative humidity: 90% no condensation
EMC test:*	Emissions: IEC/EN 50081-1 Immunity: IEC/EN 50082-2 IEC/EN 61000-4-2/3/4/6, level 3/4 criterion A, CE qualified
Shock rating:	100 g (single hit)/ IEC standard 68-2-27 (survivability)
Vibration rating:	5 g/10 to 2000 Hz, IEC standard 68-2-6 (operational)
WIRING	
Connection type:	Connector or integral cable (output dependent)
ROD STYLE SENSOR (MODEL RF)	
Electronic head:	Aluminum die cast housing with diagnostic LED display (LEDs located beside connector/cable exit)
Sensor stroke:	Flexible stainless-steel pipe (PTFE plastic coated), minimum bend radius 200 mm (8 in.)
Sealing:	IP30: (IP67 or IP68 rating when installed inside the optional 1/2 inch O.D. pressure housing pipe)
Mounting:	Any orientation. Threaded flange M18 x 1.5 or 3/4 - 16 UNF-3A
Magnet types:	Ring magnet or open-ring magnet or block magnet

**R-Series
RF Flex**

Model RF flexible housing option dimension references

R-SERIES SENSOR WITH MODEL RF FLEXIBLE HOUSING OPTION

Drawing is for reference only, contact applications engineering for tolerance specific information.

Notes:

1. Total sensor length tolerances are:
+8 mm (0.3 in.)/-5mm (0.2 in.) up to 7600 mm (300 in.) stroke length.
+15 mm ((0.6 in.)/-5 mm (0.2 in.) over 7600 mm (300 in.) stroke length.
2. Tolerances of total length do not influence the measuring stroke length.

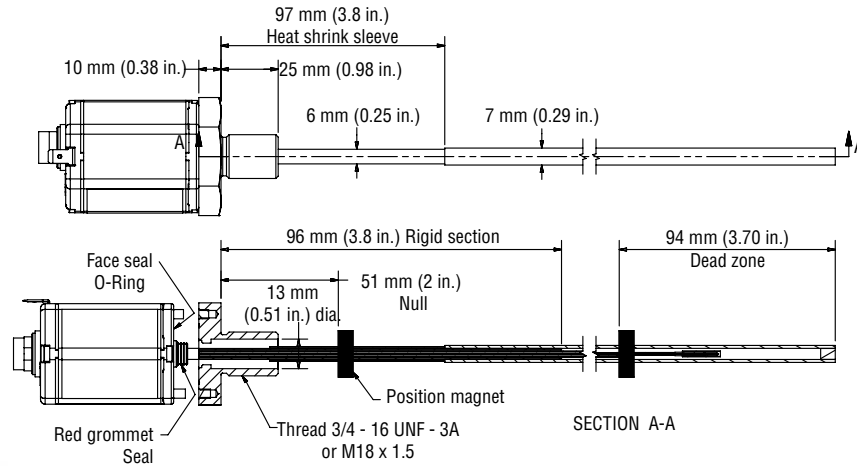



Figure 1. R-Series Model RF flexible housing dimension reference

Standard magnet selections (Model RF)

Magnets must be ordered separately with Model RF position sensors.

 Refer to the Accessories section of this catalog for magnet selections and detailed mounting and installation information.

**R-Series
RF Flex**

Model RF Flexible Housing Option for R-Series Sensors Mounting and Installation References

Sensor mounting and Installation references

R-SERIES MODEL RF SENSOR MOUNTING AND INSTALLATION *Flexible installation in any position!*

The model RF flexible sensor housing can be mounted to provide straight or curvilinear measurements. The sensor's flexible housing requires supports or anchoring to maintain proper alignment between the sensor rod and the magnet. Without proper alignment, the sensor's output signal can be interrupted or lost.

A hex flange comes mounted on the sensor head having either U.S. customary threads (3/4 - 16 UNF inches) or metric threads (M18 x 1.5). The flange is secured to the sensor head by 2 metric screws (M4 x 59 mm, 2.5 mm hex socket head). The flange can be used, or removed, to best accommodate the installation requirements. If the sensor is mounted without the flange, the red grommet seal can be cut off to provide a flush mounting surface for the sensor's face seal O-Ring (shown in 'Figure 1' and 'Figure 2').

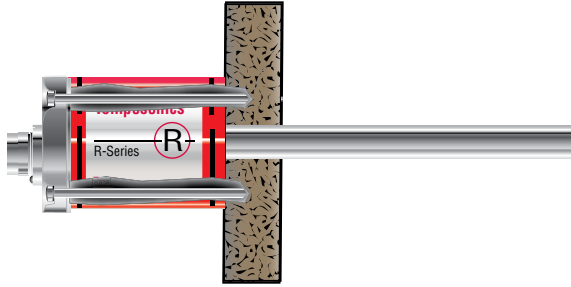

Figure 2. Installation example for flush mounting with red grommet seal removed.

R-Series
RF Flex

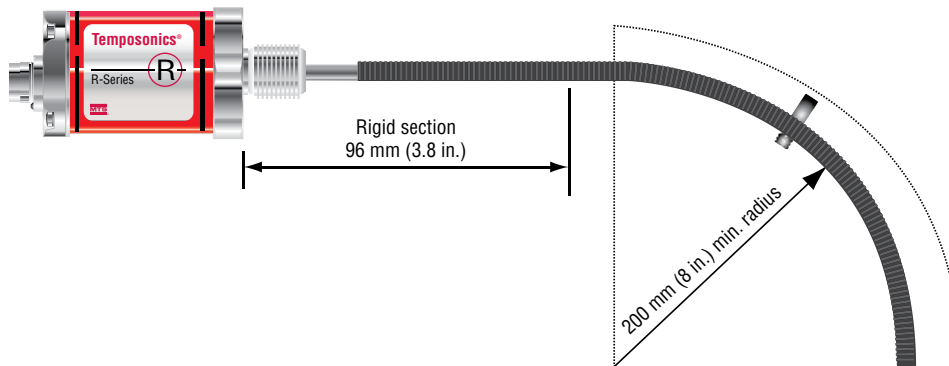

Figure 3. Installation example showing minimum bend radius for curvilinear measurements.

Most applications require that the RF flexible sensor housing be supported, such as, placed inside a guide pipe made of non-ferrous material, straight or bent to the desired shape.

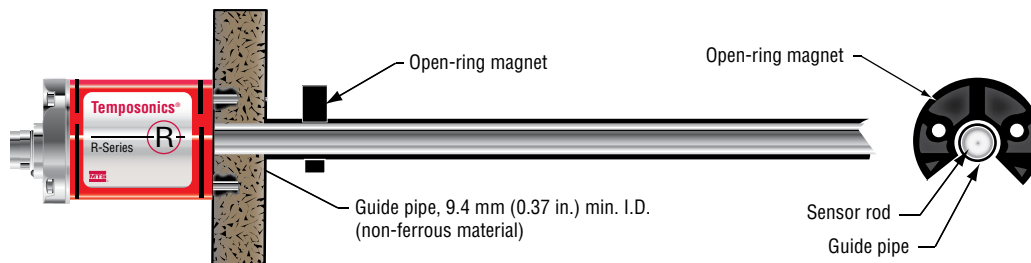

Figure 4. Installation example using non-ferrous guide pipe (customer supplied).

When installed inside the MTS half-inch O.D. pressure housing pipe, the RF flexible sensor housing is suitable for use in hydraulic cylinders, and can simplify installation where installation or mounting space is limited (see 'Figure 7').

Half inch O.D. pressure pipe and flange (Optional)

PIPE AND FLANGE SELECTIONS

The half inch O.D. pressure pipe with flange is designed specifically for R-Series sensors with the model RF flexible housing option. The pressure pipe and flange provide protection from high pressures, as found in hydraulic cylinders, up to 5,000 psi static, 10,000 psi spike. For large cylinders, using the half-inch O.D. pressure pipe requires a larger gun-drilled bore in the piston head/rod assembly. Typically, a 0.75 inch bore is used to match the I.D. of the ring magnet used (e.g. part no.: 201554 or part no.: 400424).

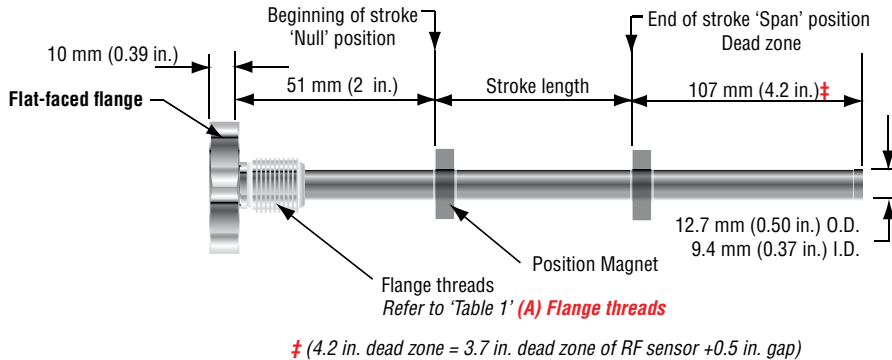

Figure 5. Style 'HL' pressure pipe (flat-faced flange shown with U.S. customary threads)

HALF INCH O.D. PRESSURE HOUSING PIPE AND FLANGE SELECTIONS (CONTINUED)

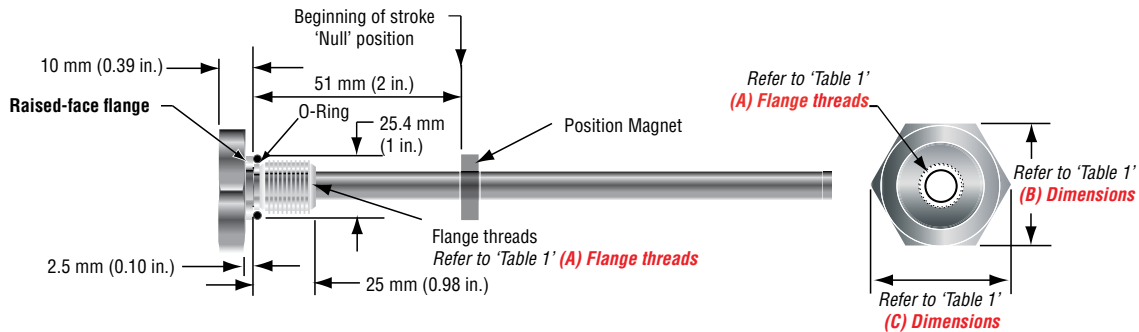

Figure 6. Style 'HP' pressure pipe (raised-face flange shown with U.S. customary threads)

FLANGE TYPE	DESCRIPTION	(A) FLANGE THREADS	(B) DIMENSIONS	(C) DIMENSIONS
HP	US customary threads with raised-face flange	3/4" - 16 UNF-3A	1.75 in.	2 in.
HL	US customary threads with flat-faced flange	3/4" - 16 UNF-3A	1.75 in.	2 in.
HD	Metric threads with flat-faced flange	M18 x 1.5	46 mm	53 mm

Table 1. Flange options and specifications

R-Series
RF Flex

R-Series Model RF Flexible Housing Option Pressure Pipe and Flange Installation

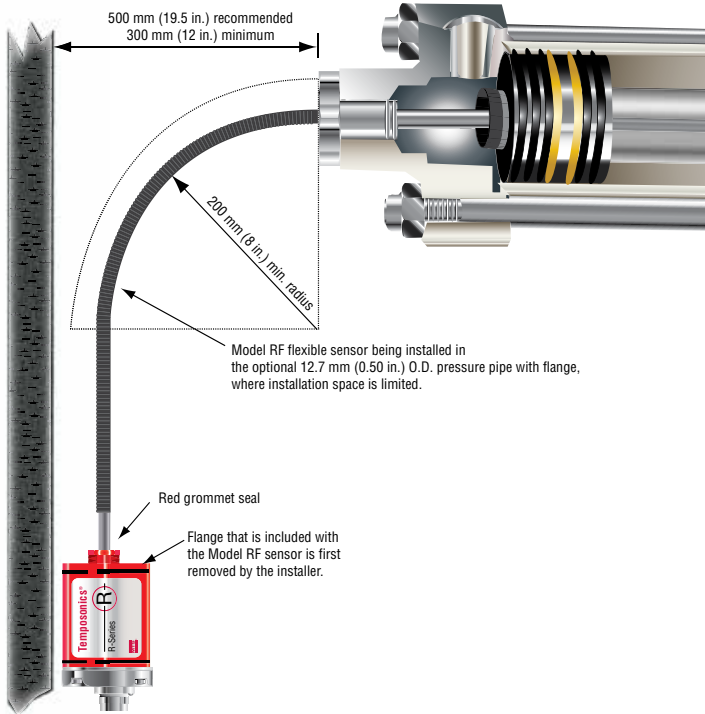

**R-Series
RF Flex**

Figure 7. Installation example using optional 12.7 mm (0.50 in.) O.D. pressure pipe inside hydraulic cylinder

Sold & Serviced By:

 **ELECTROMATE**

Toll Free Phone (877) SERV098

Toll Free Fax (877) SERV099

www.electromate.com

sales@electromate.com

R-Series Model RF Flexible Housing Option Ordering Information

H									
1	2	3	4	5	6	7			

HALF INCH O.D. PRESSURE PIPE AND FLANGE STYLE _____ =

H	
---	--

 1-2

HL = US customary threads, flat-faced flange and 1/2 inch pressure pipe **HP** = US customary threads, raised-faced flange and 1/2 inch pressure pipe, **HD** = Metric threads, flat-faced flange and 1/2 inch pressure pipe

STROKE LENGTH _____ =

--	--	--	--	--	--

 3-7

----- **M** = Millimeters
(Encode in 5 mm increments)

----- **U** = Inches and tenths
(Encode in 0.1 in. increments)

Stroke Length Notes:

1. Half inch O.D. pressure pipe and flange stroke range = 255 mm (10 in.) to 5840 mm (230 in.)
2. Contact factory for longer lengths.

Ordering examples:

HL0120U = 1/2 inch O.D. pressure pipe with flat-faced flange, US customary threads, for a 12.0 inch stroke length
HD1000M = 1/2 inch O.D. pressure pipe with flat-faced flange, metric threads, for a 1000 mm stroke length

Ordering Information R-Series Model RF Flexible Housing Option

R	F								
1	2	3	4	5	6	7	8	9	

To complete the sensor model number, consult the specific ordering information page for the R-Series model you need.

R-SERIES HOUSING MODEL _____ =

R	F
---	---

 1-2

RF = Flexible style
Magnet must be ordered separately.

FLANGE TYPE _____ =

--

 3

S = US customary threads, flat-faced flange **M** = Metric threads, flat-faced flange

STROKE LENGTH _____ =

--	--	--	--	--	--

 4-9

----- **M** = Millimeters
(Encode in 5 mm increments)

----- **U** = Inches and tenths
(Encode in 0.1 in. increments)

Stroke Length Notes:

1. Flexible housing style sensor (model RF) stroke range = 255 mm (10 in.) - 10,060 mm (396 in.)
2. Contact factory for longer lengths.

**R-Series
RF Flex**

Sensor Parameters

Refer to the individual R-Series data sheet to complete the order number beyond position '9' for outputs: Analog, SSI, CANbus, DeviceNet, Profibus, EtherCAT, and EtherNet/IP.

Ordering Examples:

RFS03937UD701S1B1100 = 393.7 in. stroke length for RF sensor with SSI output

RFM10000MD631P102 = 10,000 mm stroke length for RF sensor with Profibus output

Temposonics®

Magnetostrictive, Absolute, Non-contact
Linear-Position Sensors



R-Series Rod Model RS

Document Part Number
551251 Revision B

Data Sheet



Model RS Rod-style sensor with IP68/IP69K Super Shield Housing

FEATURES

- Robust Sealed Housing IP68/IP69K
- Analog, SSI, DeviceNet, Profibus, EtherCAT and CANbus Outputs

BENEFITS

- Available for R-Series Rod-Style Sensors
- Rugged Industrial Sensor
- Linear, Absolute Measurement
- Non-Contact Sensing Technology

APPLICATIONS

- Ideal For Hydraulic and Pneumatic Cylinders in Wash Down Environments
- Continuous Operation In Harsh Industrial Conditions
- Additional Protection for Exposed Outdoor Environments

TYPICAL INDUSTRIES

- Fluid Power
- Material Handling and Packaging
- Valve and Gate Positioning

R-Series
RS

EtherCAT.
Technology Group



Sold & Serviced By:

ELECTROMATE

Toll Free Phone (877) SERV098

Toll Free Fax (877) SERV099

www.electromate.com

sales@electromate.com

Product Overview and Specifications

Product overview

The extremely robust Temposonics® Rod-style Model RS sensor with super shield housing ensures long-term linear position measurement in the harshest environments. Hermetically sealed with a housing completely made of stainless steel, it meets protection modes IP68 and IP69K requirements and are reliably shielded against corrosion and penetration of dirt and water.

Due to non-contact measuring technology, sensor integration into a hermetically sealed housing is possible. A position magnet moves along the outside of the pressure-resistant sensor pipe and marks the position without mechanical contact.

For level measurement, an optional float can be used. The modular sensor cartridge design enables the customer to choose the specific sensor output configurations to be installed within the super shield housing to best fit their application requirements. The measuring accuracy and all technical data correspond to the features of the sensor selected inside the housing.

A wide choice of interfaces (Analog, Profibus, SSI, CANbus, DeviceNet and EtherCAT) is available. Moreover, integration of ATEX-certified and intrinsically safe sensors is possible with the protective housing. For specific information, refer to the specific R-Series sensor data sheet.

Temposonics® Model RS sensors are made to fit Temposonics® R-Series with analog and digital outputs. Fixed cable and connector versions can be used on the sensor side. When using standard sensors in this housing, you get a cost efficient solution for use in rugged applications. Several design combinations are available to fit your application: M18 or 3/4" UNF mounting flange thread, various housing lengths, and single, dual or triple cable glands.

Serial communication and a simple PC-based user interface enable remote sensor programmability and diagnostics without the need to compromise the housing's protection rating. These features can be used to simplify machine design, sensor setup and field programming.

Product specifications

Consult the individual R-series sensor data sheet for product specifications and ordering information at www.mtsensors.com

Parameters	Specifications
OUTPUT	
Outputs:	Analog, SSI, Profibus, EtherCAT, CANbus and DeviceNet
Stroke length:	Range (Rod style): 50 mm to 7620 mm (2 in. to 300 in.)
ENVIRONMENTAL	
Operating conditions:	Relative humidity: 100% Sealing: IP68/IP69K
FORM FACTOR MATERIAL (MODEL RS)	
Electronic head:	303/304 stainless steel or 316L on request
Sensor rod:	303/304 stainless steel or 316L on request
Operating pressure:	350 bar static, 690 bar peak (5000 psi static, 10,000 psi peak)
Mounting:	Any orientation. Threaded flange M18 x 1.5 or 3/4 - 16 UNF-3A
Typical mounting torque:	45 N-m (33 ft. - lbs.)
Magnet types:	Ring magnet, open-ring magnet, or magnet float

R-Series
RS

Sold & Serviced By:

 **ELECTROMATE**

Toll Free Phone (877) SERV098

Toll Free Fax (877) SERV099

www.electromate.com

sales@electromate.com

Model RS rod-style sensor dimension reference

The Temposonics R-Series rod-style sensor (Model RS) offers modular construction, flexible mounting configurations, and easy installation. The Model RS sensor is designed for mounting in applications where high pressure conditions exist, (5000 psi continuous, 10,000 psi spike), such as inside hydraulic cylinders. The Model RS sensor may also be mounted externally in many applications.

MODEL RS, ROD-STYLE SENSOR WITH IP68/IP69K HOUSING

Drawing is for reference only, contact applications engineering for tolerance specific information.

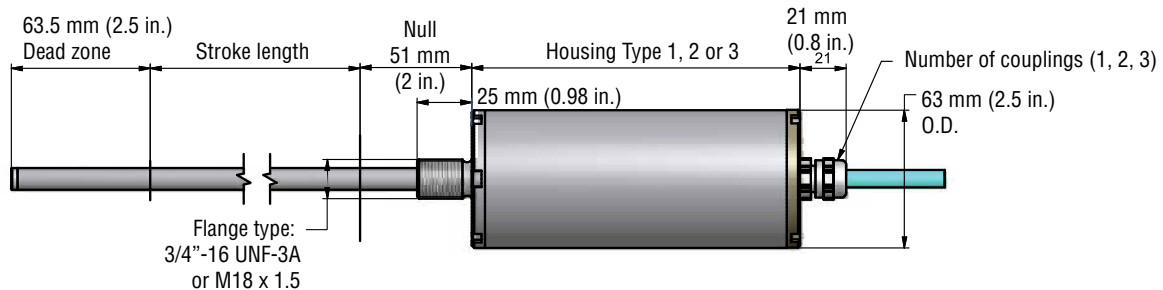

Figure 1. Model RS Rod-style sensor dimension reference. (See Figures 5, 6 and 7 for cable gland exits)

MODEL RS, ROD-STYLE SENSOR WITH TYPE 1 HOUSING

Drawing is for reference only, contact applications engineering for tolerance specific information.

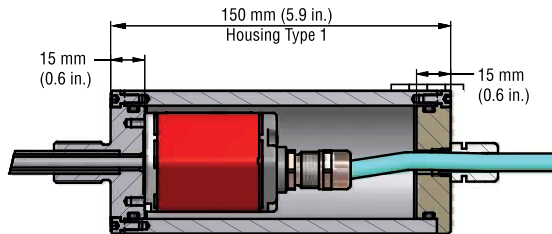

Figure 2. Model RS Rod-style sensor dimension reference (shown with *Type 1* housing)

MODEL RS, ROD-STYLE SENSOR WITH TYPE 2 HOUSING

Drawing is for reference only, contact applications engineering for tolerance specific information.

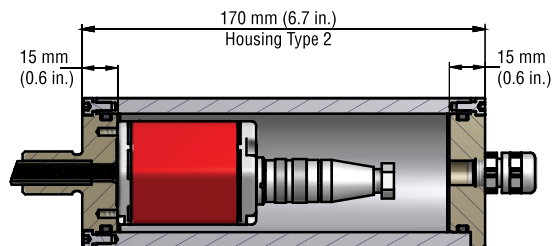

Figure 3. Model RS Rod-style sensor dimension reference (shown with *Type 2* housing)

MODEL RS, ROD-STYLE SENSOR WITH TYPE 3 HOUSING

Drawing is for reference only, contact applications engineering for tolerance specific information.

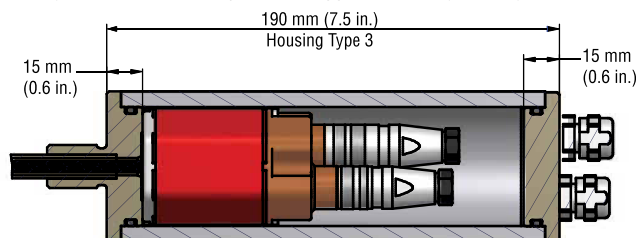

Figure 4. Model RS Rod-style sensor dimension reference (shown with *Type 3* housing)

R-Series
RS

Model RS Rod-Style Sensor Cable Gland Exits and Magnet Reference

Single, dual or triple cable glands are required for your specific R-Series Rod-style sensor selection (as shown in Figures 5, 6 and 7). Consult the R-Series Sensor Data Sheet for specific connection, wiring and mounting information.

MODEL RS, ROD-STYLE SENSOR CABLE GLAND EXITS

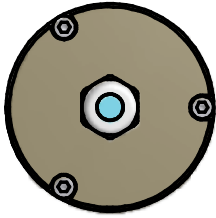

Figure 5. Model RS Rod-style sensor (shown with *Single* cable gland exit)

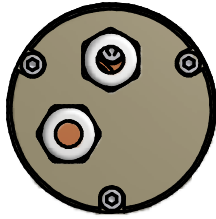

Figure 6. Model RS Rod-style sensor (shown with *Dual* cable gland exit)

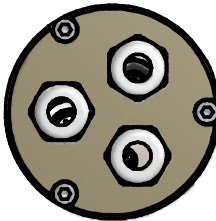



Figure 7. Model RS Rod-style sensor (shown with *Triple* cable gland exit)

Standard magnet selections (Model RS)

Magnets must be ordered separately with Model RS position sensors. The standard ring magnet (part number 201542-2) is suitable for most applications.

 Refer to the Accessories section of this catalog for magnet selections and detailed mounting and installation information.

R-Series
RS

Sold & Serviced By:

 **ELECTROMATE**

Toll Free Phone (877) SERV098

Toll Free Fax (877) SERV099

www.electromate.com

sales@electromate.com

**Models RS Sensors
Ordering Information**

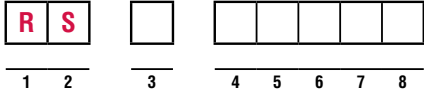

SENSOR MODEL _____ = R S **1-2**

RS = Rod style sensor with Super Shield Housing

PRESSURE PIPE FLANGE _____ = **3**

M = Flange M18 x 1.5 **S** = Flange 3/4 in. -16 UNF - 3A

STROKE LENGTH _____ = **4-8**

_____ **M** = Millimeters
(Encode in 5 mm increments)

_____ **U** = Inches and tenths
(Encode in 0.1 in. increments)

Stroke Length Notes:
Rod-style sensor (model RS) stroke range = 50 mm (2 in.) - 7620 mm (300 in.)

SENSOR PARAMETERS

Refer to the individual R-Series data sheet to **complete the order number beyond position '8'** for outputs: Analog, SSI, CANbus, DeviceNet, Profibus and EtherCAT.



Temposonics®

Magnetostrictive, Absolute, Non-contact
Linear-Position Sensors



G-Series Models GP and GH
Analog (Voltage/Current)/Digital-Pulse Outputs

Document Part Number
550959 Revision G

Data Sheet



Model GP Profile-style position sensor

Model GH Rod-style position sensor

FEATURES

- Linear, Absolute Measurement
- Non-Contact Sensing Technology
- LEDs For Enhanced Sensor Diagnostics
- Programmability, Analog Output Models:
Voltage or Current, Fully Adjustable Outputs Within:
-10 to +10 Vdc or 0 to 20 mA
- Programmability, Digital-Pulse Output Models:
PWM or Start/Stop
- Simultaneous Multi-Magnet Measurements Using Start/Stop
- Linearity Deviation Less Than 0.02%
- Repeatability Within 0.001%
- Designed for Backward Compatibility with Legacy Temposonics Products
- Standard 24 Vdc and extended input power supply options for compatibility with older controller interfaces
- Integral connector replacement options including: Hanging (inline) connectors, Adapter cables, Field-installed connector kits

BENEFITS

- Rugged Industrial Sensor, Backward Compatible with Tempo I, Tempo II and L-Series Legacy Products
- Compact electronics housing for applications with limited space
- Offers Supply Options for Compatibility with Older Controller Interfaces

APPLICATIONS

- Continuous Operation In Harsh Industrial Conditions
- High Pressure Conditions

TYPICAL INDUSTRIES

- Fluid Power
- Lumber and Woodworking
- Stamping and Diecasting
- Metalworking, Presses and Assembly Tools
- Material Handling and Packaging

G-Series
Analog/Digital



Sold & Serviced By:

ELECTROMATE

Toll Free Phone (877) SERV098

Toll Free Fax (877) SERV099

www.electromate.com

sales@electromate.com

Product Overview and Specifications

Product overview

G-Series sensors feature a microprocessor-based design with enhanced diagnostics and programmability offering the flexibility to fit a wide range of applications. The sensor's head contains the active signal conditioning and a complete integrated electronics interface. Double shielding is used to ensure EMI protection for unsurpassed reliability and operating safety. G-Series model GH and GP sensors are extremely robust and are ideal for continuous operation under harsh industrial conditions. Backward compatibility with upgraded performance is one of the primary benefits of choosing a G-Series sensor. The G-Series sensor provides the same functionality as our legacy Temposonics I, II and L-Series sensor products which make it an ideal direct replacement.

MTS offers two standard sensor housings, rod and profile extrusion. The rod housing is capable of withstanding high pressures such as those found in hydraulic cylinders. The profile extrusion housing provides convenient mounting options and captive-sliding magnets which utilize slide bearings of special material that reduce friction, and help mitigate dirt build up.

Product specifications

Parameters	Specifications	Parameters	Specifications
OUTPUT		ENVIRONMENTAL	
Measured output variables:	Position	Operating conditions:	Operating temperature: -40 °C (-40 °F) to 80 °C (176 °F) 85 °C (185 °F) max.‡ ‡ +80 °C max. for UL Recognition. Contact factory for high temperature applications.
Resolution:	Analog: Infinite (restricted by output ripple) Digital Pulse: 0.1, 0.01 and 0.005 mm (controller dependent)		Relative humidity: 90% no condensation
Update times:	Analog: < 1 ms (typical) Digital (Controller dependent, design reference) = (null + stroke+ dead zone) inches x 10.0 µsec/in. x (number of circulations)	EMC test:	Emissions: IEC/EN 61000-6-3 Immunity: IEC/EN 61000-6-2 IEC/EN 61000-4-2/3/4/5/6/8, level 3/4 criterion A, CE qualified
Linearity deviation:	< ± 0.02% full stroke (minimum ± 50 µm)	Shock rating:	100 g (single hit)/ IEC standard 68-2-27 (survivability)
Repeatability:	< ± 0.001% full stroke (minimum ± 2.5 µm)	Vibration rating:	15 g (30 g with HVR option)/10 to 2000 Hz, IEC standard 68-2-6 (operational)
Hysteresis:	< 4 µm	WIRING	
Analog Outputs:	Voltage (Fully adjustable): 0 to 10, 10 to 0, -10 to +10, +10 to -10 Vdc (minimum controller load > 5k ohms) Current (Fully Adjustable): 4(0) to 20 mA, 20 to 4(0) mA (Minimum/maximum load, 0/500 ohms)	Connection type:	6-pin male D60 (M16) connector, 10-pin MS style connector, integral cable, or hanging (inline) connectors
Digital-Pulse Outputs:	Start/Stop or Pulse Width Modulation (PWM)	PROFILE STYLE SENSOR (MODEL GP)	
Stroke Lengths:	GP (Profile style): Analog: 50 to 2540 mm (2 to 100 in.)Δ Digital: 50 to 5080 mm (2 to 200 in.) GH (Rod style): Analog: 50 to 2540 mm (2 to 100 in.)Δ Digital: 50 to 7620 mm (2 to 300 in.)	Electronic head:	Aluminum housing with diagnostic LED display (LEDs located beside connector/cable exit)
	Δ Contact factory for stroke lengths longer than 2540 mm (100 in.) for Analog outputs	Sealing:	IP 65**
ELECTRONICS		Sensor extrusion:	Aluminum (Temposonics profile style)
Operating voltage:	+24 Vdc nominal: 20.4 - 28.8 Vdc standard +9 to +28.8 Vdc optional*	Mounting:	Any orientation, adjustable mounting feet or T-slot nut (M5 threads) in bottom groove
	Polarity protection: up to -30 Vdc Over voltage protection: Up to 36 Vdc Dielectric withstand voltage: 500 Vdc (DC ground to machine ground).	Magnet types:	Captive-sliding magnet or open-ring magnet
Setpoints:	Setpoint adjustment (Null/Span): 100% of electrical stroke length, 50 mm (2 in.) min. distance between setpoints.	ROD STYLE SENSOR (MODEL GH)	
		Electronic head:	Aluminum housing with diagnostic LED display (LEDs located beside connector/cable exit)
		Sealing:	IP 67 or IP 68 for integral cable models**
		Sensor rod:	304L stainless steel
		Operating pressure:	350 bar static, 690 bar peak (5000 psi static, 10,000 psi peak)
		Mounting:	Any orientation. Threaded flange M18 x 1.5 or 3/4 - 16 UNF-3A
		Typical mounting torque:	45 N-m (33 ft. - lbs.)
		Magnet types:	Ring magnet, open-ring magnet, or magnet float

* UL Recognition requires an approved power supply with energy limitation (UL 61010-1), or Class 2 rating according to the National Electrical Code (USA) / Canadian Electrical Code.

** The IP rating is not part of the UL Recognition.

G-Series
Analog/Digital

Output options

G-Series profile-style and rod-style sensors are available in analog and digital-pulse outputs. The G-Series sensor can also provide a square wave neuter output to support legacy Temposonics I, II, and L-Series product backward compatibility.

ANALOG OUTPUTS (VOLTAGE/CURRENT)

G-Series analog sensors provide direct signals, including voltage (0 to 10 Vdc or -10 to +10 Vdc, forward or reverse acting) and current (4 to 20 mA, or 0 to 20 mA, forward or reverse acting). (See 'Figure 1'). Both voltage and current outputs allow full adjustments of null and span setpoints, (minimum 2 in. between setpoints). Since the outputs are direct, no signal-conditioning electronics are needed when interfacing with controllers or meters.

DIGITAL-PULSE OUTPUTS (START/STOP AND PWM)

G-Series digital-pulse sensors provide either PWM (Pulse Width Modulation) or Start/Stop output signals (see 'Figure 2'). For Start/Stop, the sensor requires a start signal from a controller or interface module to initiate the measurement cycle. The sensor generates a stop signal at the end of the measurement cycle that is used to stop the controller's counter clock.

The elapsed time between the start and stop signals is directly proportional to the magnet's position along the active stroke length. The controller can calculate the absolute position of the magnet from the time value and the sensor's unique gradient value, (inverse of the speed for the sonic strain pulse traveling in the sensor's waveguide).

For PWM output, the elapsed time of the measurement cycle is represented as a varying pulse width of the output signal. The duration of the pulse is directly proportional to the magnet's position along the active stroke length. When operated in the PWM mode the sensor can be configured for internal interrogations or external interrogations. Using external interrogations, a signal is required from the controller or interface module to initiate every measurement cycle (i.e. same as Start/Stop). When using the mode for internal interrogations, no signal is needed from the controller as the sensor itself initiates the next measurement cycle upon the completion of the current cycle. Sensor resolution can be improved by using multiple back to back measurement cycles that are grouped together to generate a single PWM output signal.

Using multiple measurement cycles in this fashion is referred to as circulations. Setting the sensor to use 2 circulations improves the measurement resolution 2 times. Likewise, using 3 circulations improves the resolution 3 times, and so on. When using multiple circulations the resulting pulse width is longer, indicating the total time elapsed for all of the circulations added together. Once this elapsed time is measured by the counter clock in the controller, the time value is divided by the number of circulations used. The result can then be divided by the sensor's gradient value to determine the magnet's absolute position.

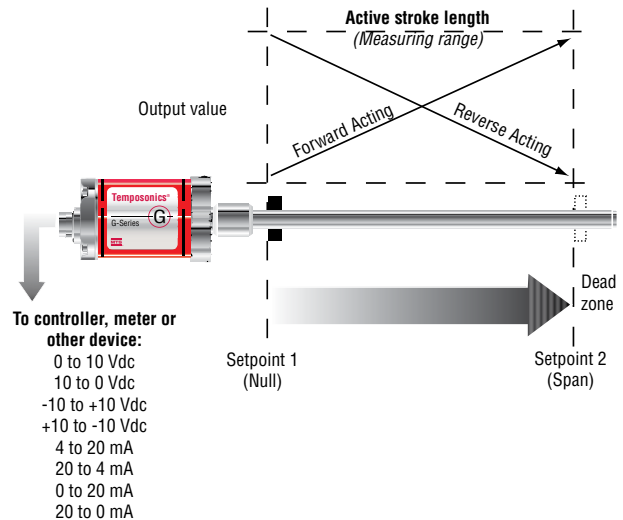

Figure 1. Single magnet analog output diagram

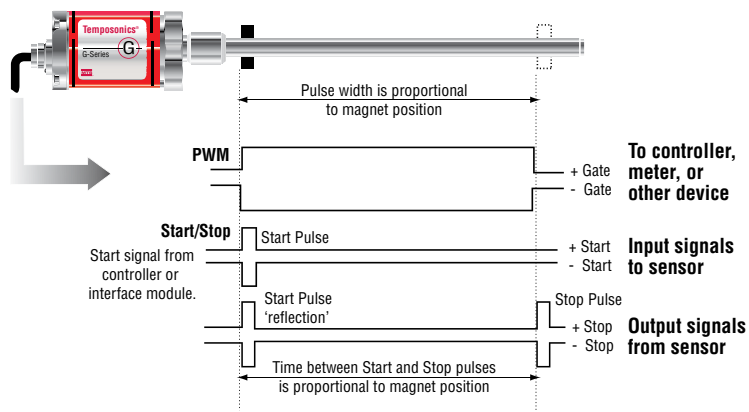

Figure 2. Direct Start/Stop and PWM output diagram

Using multiple circulations will slow down the sensor's update time. However, using multiple circulations has the same effect for improving the measured resolution as it would be to increase the frequency of the counter clock in the controller (Xtal [MHz]), as indicated in the equation below.

$$Resolution (in.) = \frac{1}{(gradient \mu s/in.) \times (Xtal [MHz]) \times (\# \text{ of circulations})}$$

G-Series
Analog/Digital

G-Series Models GP and GH Sensors
Monitoring, Diagnostics and Advanced Programmability

Enhanced monitoring and diagnostics

SENSOR STATUS AND DIAGNOSTIC DISPLAY

Diagnostic LEDs (green/red) located beside the connector or cable exit (see 'Figure 3'), provide basic visual monitoring for normal sensor operation and troubleshooting.



Figure 3. G-Series sensor diagnostic LEDs

Green	Red	Operation status/mode
OFF OFF	OFF ON	No power to sensor Self-diagnostic error
ON ON ON	OFF ON FLASHING	Normal sensor function Magnet not detected Missing external Start/interrogation signal
FLASHING FLASHING FLASHING	OFF ON FLASHING	Serial programming mode Magnet signal is weak Supply voltage beyond limits (high or low)

Table 1. Diagnostic LED codes

Advanced communication and programmability

SENSOR FIELD PROGRAMMING AND G-SERIES PC PROGRAMMING KITS

Temposonics G-Series Analog and Digital-pulse output sensors are pre-configured at the factory by model number designation. For many applications, normal sensor installation and operation does not require additional adjustment.

If however, sensor parameter changes are required in the field, MTS has developed the 'G-Series Analog PC Programming Kits', part no. 253311-1 and part no. 253312-1 (see 'Figure 4') which can be purchased separately to easily program the sensor.

G-Series PC setup software is shipped with the sensor and can also be downloaded from www.mtssensors.com. You can use the PC setup software to configure, diagnose, monitor and program your G-Series sensor in the field without opening the sensor's electronics housing.

This can simplify installation and commissioning, saving valuable time. Keeping the sensor electronics isolated ensures that seal integrity and the highest product reliability are maintained.

G-Series PC Programming Kits (part no.: 253311-1 and 253312-1) include the following components:

- Wall adapter style power supply (24 Vdc output)
- USB Serial converter box with USB cable to connect to PC
- Two connection cables:
 - Cable for sensor ordered with the D60 integral connector option.
 - Cable with quick connects for sensor ordered with the integral cable option.
- G-Series PC Setup software, available for download at <http://www.mtssensors.com>.



Figure 4. G-Series PC Programming Kit, part no. 253311-1 (Analog) or 253312-1 (Digital-pulse) outputs

Software upgrades can be downloaded free of charge from the MTS Sensors website at <http://www.mtssensors.com>.

**G-Series
 Analog/Digital**

G-Series PC Setup and Configuration Software Interface

VISUAL SOFTWARE INTERFACE

The G-Series PC Setup and configuration software provides a user-friendly interface (see 'Figure 5') along with the sensor's advanced technology enables the operator to take advantage of the following features:

- Built-in serial interfaces for robust hard-wired serial communication, (RS-422 for digital-pulse output and RS-485 for analog output).
- Remote programmability for operational modes and sensor parameters as shown below.

Analog output	Digital-pulse output
Voltage or current output mode	Start/Stop or PWM output mode
Voltage or current output range	Internal or external interrogation mode when using the PWM mode
Full adjustment for Null and Span setpoints	Number or circulations (1 to 20) when using the PWM mode

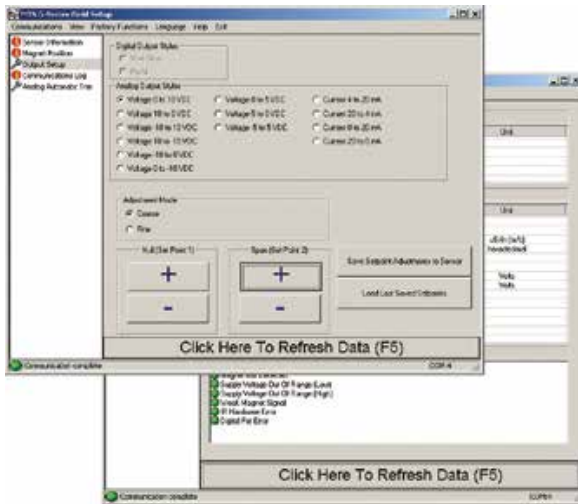

Figure 5. G-Series PC setup software interface examples

G-SERIES ANALOG HANDHELD PROGRAMMER ACCESSORY

Programming for your G-Series analog output sensor can be achieved in the field using the G-Series Analog Handheld Programmer accessory, part no. 253853 (see 'Figure 6').



Figure 6. G-Series Analog Handheld Programmer (part no.: 253853). Front and back views shown.

Using the G-Series Analog Handheld Programmer the magnet positions, and corresponding output values, can be adjusted for the beginning of stroke (Setpoint 1) and for the end of stroke (Setpoint 2) that is actually needed for the specific application. These adjustments are easily done, even when the sensor is not directly accessible, by connecting the programmer to the sensor's integral cable or extension cable. Additionally, the programmer has its own red and green LEDs to provide a remote display of the sensor's LEDs, used for indicating the sensor status and error diagnostics.

For detailed information refer to the G-Series Analog Handheld Programmer Operating Instructions (document part no. 551024) available in PDF format at www.mtssensors.com.

**G-Series
Analog/Digital**

Model GP Profile-Style Sensor

Dimension References

Model GP profile-style sensor dimension references

MODEL GP, PROFILE-STYLE SENSOR WITH STYLE S CAPTIVE-SLIDING MAGNET

Drawing is for reference only, contact applications engineering for tolerance specific information.

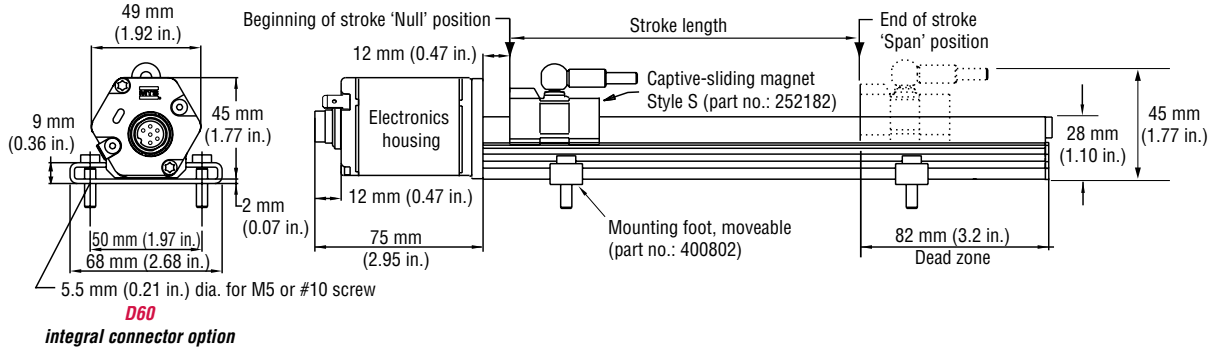

Figure 7. G-Series Model GP Profile-style sensor dimension reference (Shown with the **D60** integral connector option)

MODEL GP, PROFILE-STYLE SENSOR WITH STYLE V CAPTIVE-SLIDING MAGNET

Drawing is for reference only, contact applications engineering for tolerance specific information.

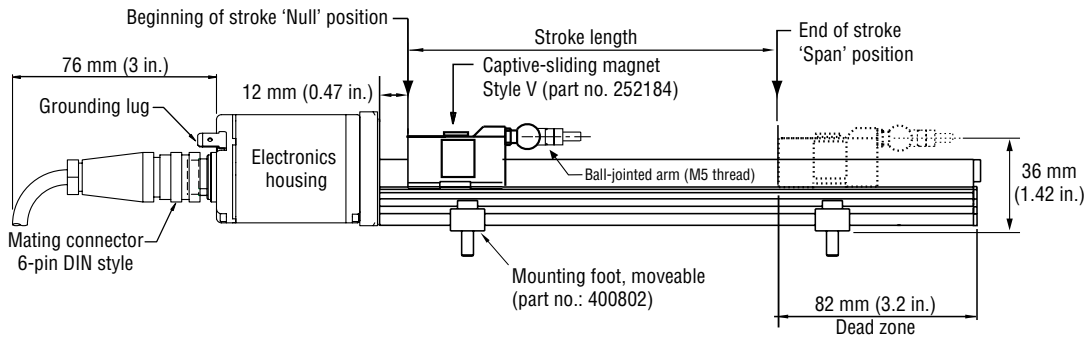

Figure 8. G-Series Model GP Profile-style sensor dimension reference (Shown with mating cable connector)

MODEL GP, PROFILE-STYLE SENSOR WITH STYLE M OPEN-RING MAGNET

Drawing is for reference only, contact applications engineering for tolerance specific information.

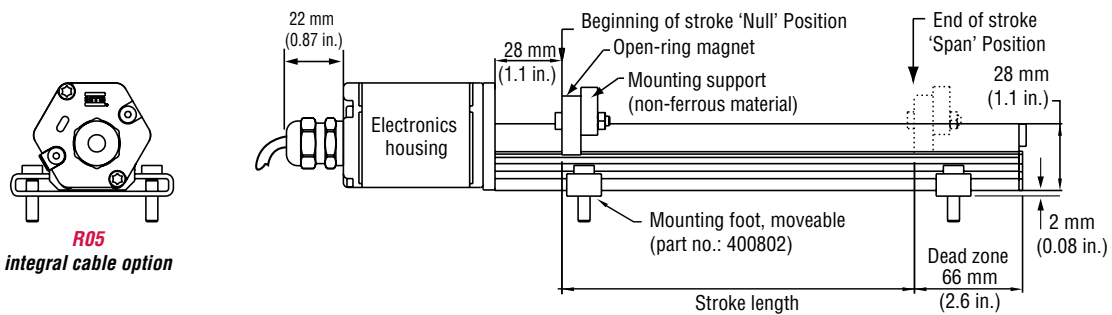



Figure 9. G-Series Model GP Profile-style sensor dimension reference (Shown with the **R05** integral cable option)

Standard magnet selections, mounting and installation (Model GP)

Temposonics Model GP profile-style sensors offer two basic mounting methods; side grooves for use with mounting feet or a bottom groove that accepts special T-Slot nuts. Both the mounting feet and T-Slot nuts can be positioned along the sensor extrusion to best secure the sensor for each particular application.

 Refer to the Accessories section of this catalog for magnet selections and detailed mounting and installation information.

G-Series
Analog/Digital

Model GH rod-style sensor dimension references

The Temposonics G-Series rod-style sensor (Model GH) offers modular construction, flexible mounting configurations, and easy installation. The Model GH sensor is designed for mounting in applications where high pressure conditions exist (5000 psi continuous, 10,000 psi spike) such as inside hydraulic cylinders. The Model GH sensor may also be mounted externally in many applications.

Stroke-dependent Dead Zones:	
Stroke length:	Dead zone:
50 mm (2 in.) - 5000 mm (197 in.)	63.5 mm (2.5 in.)
5005 mm (197.1 in.) - 7620 mm (300 in.)	66 mm (2.6 in.)

MODEL GH, ROD-STYLE SENSOR WITH RING MAGNET (MAGNET ORDERED SEPARATELY)

Drawing is for reference only, contact applications engineering for tolerance specific information.

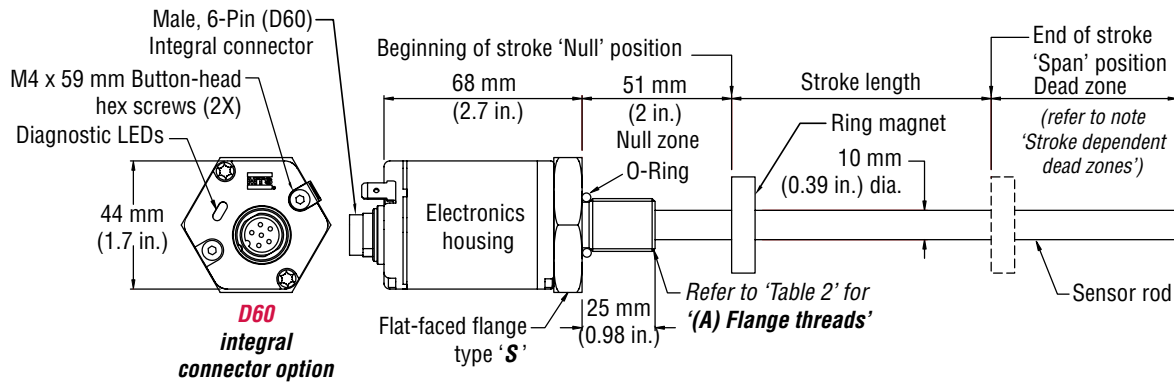

Figure 10. Model GH Rod-style sensor dimension reference (shown with **D60** integral connector option)

MODEL GH, ROD-STYLE SENSOR WITH 6-PIN DIN MATING CABLE CONNECTOR (MAGNET ORDERED SEPARATELY)

Drawing is for reference only, contact applications engineering for tolerance specific information.

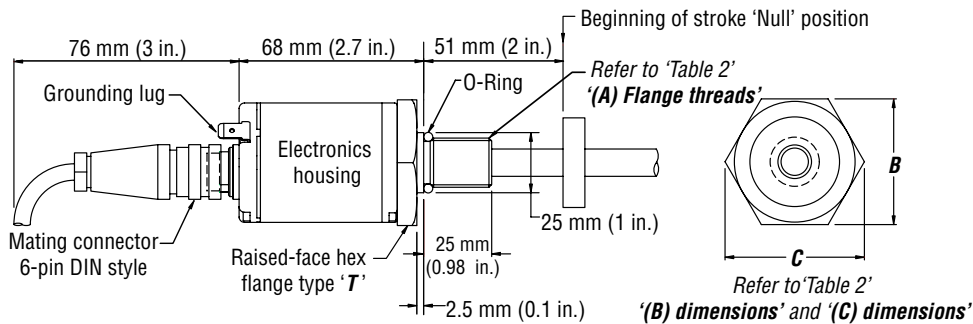

Figure 11. Model GH Rod-style sensor dimension reference (shown with mating cable connector)

Housing style Flange type	Description	(A) Flange threads	(B) Dimensions	(C) Dimensions
T	US customary threads with raised-face flange	3/4" - 16 UNF-3A	1.75 in.	2 in.
S	US customary threads with flat-faced flange	3/4" - 16 UNF-3A	1.75 in.	2 in.
M	Metric threads with flat-faced flange	M18 x 1.5	46 mm	53 mm

Table 2. Model GH Rod-style sensor housing style and flange type references

Standard magnets, mounting and installation (Model GH)

Magnets must be ordered separately with Model GH position sensors. The standard ring magnet (part number 201542-2) is suitable for most applications.

Refer to the Accessories section of this catalog for magnet selections and detailed mounting and installation information.

G-Series
Analog/Digital

**Models GP and GH Sensor
Connections and Wiring**

Models GP and GH connections and wiring

STANDARD MALE (D60) 6-PIN DIN INTEGRAL CONNECTOR (M16)

Male, 6-pin (D60) integral connector pin-out as viewed from the end of the sensor.



Important Notes:

1. A grounding lug on the end of the sensor is provided for convenient connection to earth ground.
2. Appropriate grounding of cable shield is required at the controller end.
3. For analog output sensors, the yellow wire (pin 3) and green wire (pin 4) provide serial communications. If possible, during sensor installation these wires should be placed for easy access if future programming or diagnostics are needed. When these wires are not used, they should be isolated with electrical tape to avoid unintended contact with other nearby wires or machine surfaces.

Pin Number	Wire Color	Function / Digital-pulse outputs	Function / Analog outputs
1	Gray	(-) Gate for PWM (-) Stop for Start/Stop or programming (RS-422 TX-)	0 to 10, -10 to +10 Vdc or 4 to 20 mA, 0 to 20 mA or reverse acting: 10 to 0, 10 to -10 Vdc or 20 to 4 mA, 20 to 0 mA
2	Pink	(+) Gate for PWM (+) Stop for Start/Stop or programming (RS-422 TX+)	Return for pin 1
3	Yellow	(+) Interrogation for PWM (+) Start for Start/Stop or Programming (RS-422 RX+)	Programming (RS-485+)
4	Green	(-) Interrogation for PWM (-) Start for Start/Stop or Programming (RS-422 RX-)	Programming (RS-485-)
5	Red or Brown	Supply voltage (+Vdc)	Supply voltage (+Vdc)
6	White	DC ground (for supply)	DC ground (for supply)

Table 2. Wiring, Male, 6-pin (D60) integral connector



Retrofit/replacement references - integral adapter cables with in-line connectors

Tables 4 and 5 describe a variety of retrofit connection options for analog and digital-pulse sensors to provide direct backward compatibility for your application.

ANALOG OUTPUT

Important Notes (Table 4):

1. This format used to show the voltage and current output range is: [Value at Null (Setpoint 1) to [Value at Span (setpoint 2)]. Not all of the available output ranges for voltage are shown.
2. When replacing a L-Series sensor with a G-Series sensor, and reverse-acting output is being used, the wire connections must be changed at the controller. Refer to the *G-Series Cross Reference, document part no.: 550967* for detailed information.
3. If possible, during sensor installation, these wires should be placed for easy access if future programming or diagnostics are needed. When these wires are not used, they should be isolated with electrical tape to avoid unintended contact with other nearby wires or machine surfaces.

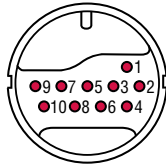

Male, 10-pin In-line RB connector (Option RB_)

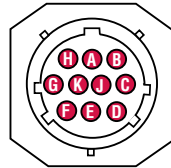

Male, 10-pin in-line or integral MS connector (Option FM_ or MS0)

DIGITAL-PULSE (START/STOP OR PWM) OUTPUTS

Important Notes (Table 5):

The G-Series sensor can provide a square wave neuter output for backwards compatibility to replace Temposonics I, Temposonics II, and L-Series sensors that produced a neuter output signal. The neuter output option was used for connection to the Analog Output module (AOM), Digital Interface Box (DIB), and to some custom interface/controllers. Reference the G-Series Cross Reference, document part no. 550967, for neuter output connection information, including adapter cables and field-installed connections.

‡ When using PWM output with internal interrogation, both interrogation input signals are not used. Therefore, the designated connector pin(s) can be left unconnected or connected to ground.

Analog output connections (voltage or current)

In-line RB connector (Option RB_)	in-line MS connector (Option FM_)	integral MS connector (Option MS0)	Function / Analog output (see Note 1)
Pin number	Pin number	Pin number	
4	D	D	0 to 10, -10 to +10 Vdc or 4 to 20 mA, 0 to 20 mA or reverse acting (see Note 2): 10 to 0, +10 to -10 Vdc or 20 to 4 mA, 20 to 0 mA
3	C	C	Ground for Signal Return
7	G	G	Programming (RS-485+) (See Note 3)
8	H	H	Programming (RS-485-) (See Note 3)
5	E	E	Supply voltage (+Vdc)
1	A	A	DC ground (for supply)
2	B	B	No connection
6	F	F	No connection
9	J	J	No connection
10	K	K	No connection

Table 4. Integral adapter cable connections (analog output)

Digital-pulse output connections (Start/Stop or PWM)

In-line RB connector (Option RB_)	in-line MS connector (Option FM_)	Integral MS connector (Option MS0)	Function / Digital-pulse output
Pin Number	Pin number	Pin number	
3	C	C	(-) Gate for PWM (-) Stop for Start/Stop or programming (RS-422 TX-)
4 and 8	D	D	(+) Gate for PWM (+) Stop for Start/Stop or programming (RS-422 TX+)
9	G	G	(+) Interrogation for PWM ‡ (+) Start for Start/Stop or Programming (RS-422 RX+)
10	H	H	(-) Interrogation for PWM ‡ (-) Start for Start/Stop or Programming (RS-422 RX-)
5	E	E	Supply voltage (+Vdc)
1	A	A	DC ground (for supply)
2	B	B	No connection
6	F	F	No connection
7	J	J	No connection
-	K	K	No connection

Table 5. Integral adapter cable connections (analog output)

**G-Series
Analog/Digital**

Models GP and GH Sensors
Ordering Information

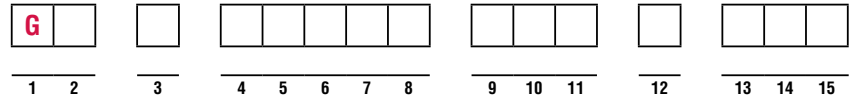

SENSOR MODEL _____ = **1-2**
GP = Profile style **GH** = Hydraulic rod style

HOUSING STYLE _____ = **3**

Model GP profile-style sensor (includes one magnet):
S = Captive-sliding magnet with ball joint at top (part no. 252182) **V** = Captive-sliding magnet with ball joint at front (part no. 252184) **M** = Open-ring magnet (part no. 251416-2)
Model GH rod-style sensor (magnet(s) must be ordered separately):
T = US customary threads, raised-faced flange and pressure tube, standard **U** = Same as option "T", except uses fluoroelastomer seals for the electronics housing **B** = Sensor cartridge only (no flange and pressure tube, stroke length < 1830 mm (72 in.))
S = US customary threads, flat-faced flange and pressure tube, standard **H** = Same as option "S", except uses fluoroelastomer seals for the electronics housing
M = Metric threads, flat-faced flange and pressure tube, standard **V** = Same as option "M", except uses fluoroelastomer seals for the electronics housing

STROKE LENGTH _____ = **4-8**
 - - - - **M** = Millimeters (Encode in 5 mm increments)
 - - - - . **U** = Inches and tenths (Encode in 0.1 in. increments)

Stroke Length Notes:

1. Rod-style sensor (model GH) Voltage or Current = 50 mm (2 in.) - 2540 mm (100 in.) (See 'Note 6' on page 16).
2. Rod-style sensor (model GH) Digital-pulse = 50 mm (2 in.) - 7620 mm (300 in.)
3. Profile-style sensor (model GP) Voltage or Current = 50 mm (2 in.) - 2540 mm (100 in.) (See 'Note 6' on page 16).
4. Profile-style sensor (model GP) Digital-pulse = 50 mm (2 in.) - 5080 mm (200 in.)

CONNECTION TYPE _____ = **9-11**

Integral connector:
D60 = 6-pin DIN (M16), male, standard
MSO = 10-pin MS Style male

Integral cables:
R _____ = Integral cable, PVC jacket, pigtail termination
F _____ = Integral cable, black polyurethane jacket with pigtail termination (See 'Note 1' on page 16)

Cable Length Note:
 MTS recommends the maximum integral cable length to be 10 meters (33 ft.). Cables greater than 10 m (33 ft.) in length are available, however, proper care must be taken during handling and installation.

Cable length:
 Encode in feet if using US customary stroke length
 Encode in meters if using metric stroke length
 - - - = 3 (03) to 98 (98) ft. or 1 (01) to 30 (30) meters.

RB1 = 1 ft. inetgral cable, PVC jacket, with male in-line RB connector † **FM1** = 1 ft. inetgral cable, PUR jacket, with male in-line 10-pin MS connector ‡ **FD1** = 1 ft. inetgral cable, PUR jacket, with male in-line 6-pin DIN (M16) connector
RB2 = 5 ft. inetgral cable, PVC jacket, with male in-line RB connector † **FM2** = 5 ft. inetgral cable, PUR jacket, with male in-line 10-pin MS connector ‡ **FD2** = 5 ft. inetgral cable, PUR jacket, with male in-line 6-pin DIN (M16) connector
 † See 'Note 2' on page 101. ‡ See 'Note 3' on page 101.

INPUT VOLTAGE _____ = **12**
1 = +24 Vdc (+20% - 15%) standard **2** = +9 Vdc to +28.8 Vdc (See 'Note 4' on page 16)

A = Same as option '1' except includes the High Vibration-Resistant (HVR) option for Model GH only, stroke range = 50 mm (2 in.) to 2000 mm (78.7 in.), Refer to 'HVR Option' (See 'Note 8' on page 101). **B** = Same as option '2' except includes the High Vibration-Resistant (HVR) option for Model GH only, stroke range = 50 mm (2 in.) - 2000 mm (78.7 in.), Refer to 'HVR Option'. (See 'Note 8' on page 101)

OUTPUT (13 - 15) _____ = **13-15**

2 to 3 digit code defined by the output option selected. Output options continued on next page.

G-Series
Analog/Digital

Models GP and GH Sensors
Ordering Information

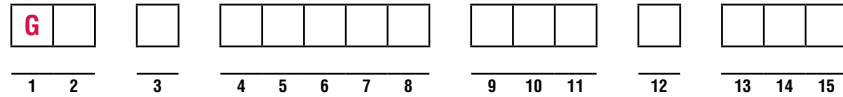

Choose output option from below (2 to 3 digit code) _____ = 13 - 15

Choose a value described below to encode in 2 to 3 digits (sensor part number boxes 13-15)

Voltage

- V0** = 0 to +10 Vdc **V4** = 0 to +5 Vdc **V8** = -5 to +5 Vdc
- V1** = +10 to 0 Vdc **V5** = +5 to -5 Vdc **V9** = +5 to 0 Vdc
- V2** = -10 to +10 Vdc
- V3** = +10 to -10 Vdc **V6** = -10 to 0 Vdc
- V7** = 0 to -10 Vdc

Current

- A0** = 4 to 20 mA **A2** = 0 to 20 mA
- A1** = 20 to 4 mA **A3** = 20 to 0 mA

Digital pulse

- RO X** = Start/Stop. If more than one magnet, the X denotes the number of magnets in hexadecimal (2 to F).
- RF X** = Start/Stop with Closed-Error Signal Utility (see 'Note 7'). If more than one magnet, the X denotes the number of magnets in hexadecimal (2 to F).
- DI X** = PWM, internal interrogation, the X denotes the number of circulations in hexadecimal (1 to F), and G = 16, K = 20 circulations.
- FI X** = PWM, internal interrogation with Closed Error Signal Utility (see 'Note 7').The X denotes the number of circulations in hexadecimal (1 to F), and G = 16, K = 20 circulations.
- DE X** = PWM, external interrogation, the X denotes the number of circulations in hexadecimal (1 to F), and G = 16, K = 20 circulations.
- FE X** = PWM, external interrogation with Closed Error Signal Utility (see 'Note 7').The X denotes the number of circulations in hexadecimal (1 to F), and G = 16, K = 20 circulations.
- NO X** = Start/Stop output wired for square wave neuter ("+ Stop" used for neuter output pulse). If more than one magnet, the X denotes the number of magnets in hexadecimal (2 to F) (see 'Note 5').

Notes:

1. Polyurethane jacketed cable for use where higher resistance to moisture, oil, and other environmental conditions are required.
2. Wired for analog, digital-pulse, or neuter, depending on output selected. For Temposonics II and model LH replacements/ retrofits only. Refer to G-Series Cross Reference part numbers 550967 and 550956 for more information.
3. Wired for analog and digital-pulse depending on output selected. Use for model LH replacements or retrofits. Refer to the G-Series Cross Reference document, part number 550956 for more information.
4. Selected when retrofitting sensors with ± 15 Vdc input voltages.
5. For Temposonics I, Temposonics II, and model LH neutered output sensor retrofits only. Refer to the G-Series Cross Reference documents, part numbers 550956 and 550967 for more information.
6. Stroke lengths longer than 2540 mm (100 in.) for analog outputs are available on a custom basis.
7. When shock and vibration events exceed the sensor specification rating, the Closed Error Signal Utility (option "F") will provide either PWM or Start/ Stop outputs, which are backwards compatible to interface cards/controllers designed for the legacy Temposonics II and L-Series sensor models. For more information about the Closed Error Signal Utility (option "F"), refer to Application Note, part number 550983.
8. The High Vibration-Resistant (HVR) option provides the model GH rod-style sensors with increased resistance to shock and vibration for use in heavy duty machinery. Refer to "G-Series and R-Series Sensors for High Shock and Vibration Applications", part no. 551073 for more information.

Reference table

Decimal:	1	2	3	4	5	6	7							
Ordering Code:	1	2	3	4	5	6	7							
Decimal:	8	9	10	11	12	13	14	15	16	20				
Ordering Code:	8	9	A	B	C	D	E	F	G	K				

G-Series
Analog/Digital

Temposonics®

Magnetostrictive, Absolute, Non-contact
Linear-Position Sensors



G-Series Redundant Models GT2 and GT3 Analog (Voltage/Current)

Document Part Number
551102 Revision B

Data Sheet



Model GT3 rod-style redundant position sensor

FEATURES

- Offers Redundancy for Enhanced Safety Applications
- Linear, Absolute Measurement
- Contains Up to Three Separate, Independent Measuring Systems in a Single Compact Housing
- Non-Contact Sensing Technology
- Superior Accuracy, Linearity Deviation Less Than 0.02%
- Repeatability Within 0.001%
- Fully Adjustable Analog Outputs (Voltage or Current) Within:
-10 to +10 Vdc or 0 to 20 mA

BENEFITS

- Rugged Industrial Sensor
- Compact Design with a Standard Size 10 mm (0.39 in.) O.D. Stainless-Steel Rod
- Uses Standard Mounting

APPLICATIONS

- Ideal for High-Safety Applications Requiring Redundancy
- Continuous Operation In Harsh Industrial Conditions
- High Pressure Conditions

TYPICAL INDUSTRIES

- Power Plants
- Water and Wind Turbine Pitch Settings
- Marine Propellers
- Ship Control Systems
- Floodgate Control



G-Series GT
Redundant

Sold & Serviced By:

ELECTROMATE

Toll Free Phone (877) SERV098

Toll Free Fax (877) SERV099

www.electromate.com

sales@electromate.com

G-Series Models GT2 and GT3 Redundant Sensors

Product Overview and Specifications

Product overview

G-Series model GT sensors are extremely robust and are ideal for continuous operation under harsh industrial conditions. The rod housing is capable of withstanding high pressures such as those found in hydraulic cylinders. G-Series redundant sensors provide accurate, linear-position measurement for applications that benefit from redundancy due to safety relevant functions.

G-Series Redundant sensors feature two or three independent measuring systems contained in one compact housing. Each measuring system contains its own channel with sensor element, power and evaluation electronics and output signal. Each channel has its own output connector or cable.

All sensor elements are integrated in one pressure proofed, high-grade steel rod. Rod and housing style feature the approved standard dimensions with 10 mm (0.39 in.) diameter rod and 3/4-16 UNF or M18 x 1.5 threaded hex flanges. The redundant sensor easily installs in applications measuring linear movements of control valves, linear drives, fluid cylinders and machines.

Product specifications

Parameters	Specifications	Parameters	Specifications
OUTPUT		ENVIRONMENTAL	
Measured output variables:	Position	Operating conditions:	Operating temperature: -40 °C (-40 °F) to +75 °C (167 °F) Relative humidity: 90% no condensation
Resolution:	Analog: Infinite (restricted by output ripple)	EMC test:	Emissions: IEC/EN 61000-6-3 Immunity: IEC/EN 61000-6-2 IEC/EN 61000-4-2/3/4/5/6/8, level 3/4 criterium A, CE qualified
Update times:	< 1 ms (typical)	Shock rating:	100 g (single hit)/ IEC standard 68-2-27 (survivability)
Linearity deviation:	< ± 0.02% full stroke (minimum ± 50 µm)	Vibration rating:	5 g /10 to 2000 Hz, IEC standard 68-2-6 (operational)
Repeatability:	< ± 0.001% of full stroke (minimum ± 2.5 µm)	WIRING	
Hysteresis:	< 4 µm	Connection type:	6-pin male D60 (M16) connector or integral cable
Analog Outputs:	Model GT2: 2 output channels Model GT3: 3 output channels Voltages (Fully adjustable): 0 to 10, 10 to 0, -10 to +10, +10 to -10 Vdc (minimum controller load >5k ohms) Current (Fully Adjustable): 4 (0) to 20 mA, 20 to 4 (0) mA (min./max. load 0/500 ohms)	ROD STYLE SENSOR (MODEL GT2/GT3)	
Stroke Length:	GT2/GT3: Analog: 50 mm (2 in.) to 2900 mm (114 in.)	Electronic head:	Aluminum housing
ELECTRONICS		Sealing:	IP 67
Operating voltage:	+24 Vdc nominal: -15 or +20% Polarity protection: up to -30 Vdc Overvoltage protection: up to 36 Vdc Current drain: 100 mA typical per channel Dielectric withstand voltage: 500 Vdc (DC ground to machine ground)	Sensor rod:	304L stainless steel
Setpoints:	Setpoint adjustment (Null/Span): 100% of electrical stroke length, 50 mm (2 in.) minimum distance between setpoints.	Operating pressure:	350 bar static, 690 bar peak (5000 psi static, 10,000 psi peak)
		Mounting:	Any orientation. Threaded flange M18 x 1.5 or 3/4 - 16 UNF-3A
		Typical mounting torque:	45 N-m (33 ft. - lbs.)
		Magnet types:	Ring magnet, open-ring magnet, or magnet float

**G-Series GT
Redundant**

Sold & Serviced By:

ELECTROMATE

Toll Free Phone (877) SERV098

Toll Free Fax (877) SERV099

www.electromate.com

sales@electromate.com

Output options

G-Series rod-style redundant sensors are available with analog (voltage and current) outputs. The G-Series redundant, model GT2 sensor provides two output channels, and model GT3 provides three output channels.

ANALOG (VOLTAGE/CURRENT)

G-Series analog sensors provide direct signals, including voltage (0 to 10 Vdc or -10 to +10 Vdc, forward or reverse acting) and current (4 to 20 mA, or 0 to 20 mA, forward or reverse acting). (see 'Figure 1'). Both voltage and current outputs allow full adjustments of null and span setpoints (minimum 2 in. between setpoints). Since the outputs are direct, no signal-conditioning electronics are needed when interfacing with controllers or meters.

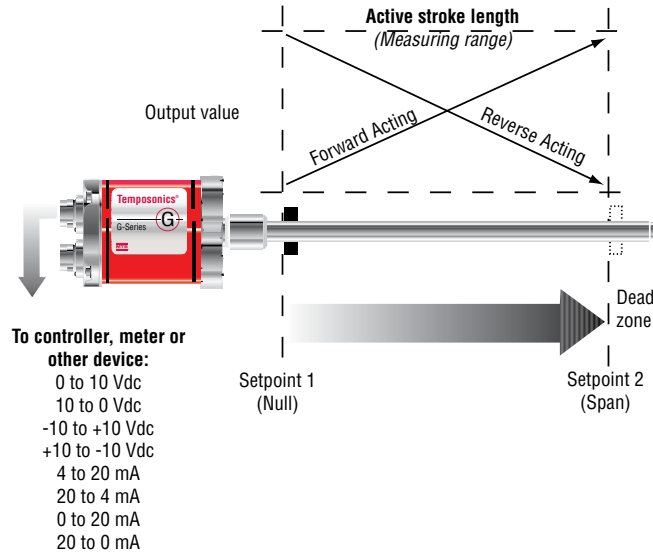

Figure 1. Single magnet analog output diagram

Advanced communications and programmability

SENSOR FIELD PROGRAMMING AND G-SERIES PC PROGRAMMING KIT

Temposonics G-Series Redundant sensors are preconfigured at the factory by model code designation. For many applications no adjustments are required for normal installation and operation. If, however, sensor parameter changes are desired while in the field, the G-Series Redundant sensor is easily programmed by using the G-Series PC Programming kit (see 'Figure 2').



Figure 2. G-Series PC Programming Kit, part no. 253311-1

G-Series PC setup software is shipped with the sensor and can also be downloaded from www.mtssensors.com. You can use the PC setup software to configure, diagnose, monitor and program your G-Series sensor in the field without opening the sensor's electronics housing.

This can simplify installation and commissioning, saving valuable time. Keeping the sensor electronics isolated ensures that seal integrity and the highest product reliability are maintained.

G-Series Analog PC Programming Kit (part no.: 253311-1) includes the following components:

- Wall adapter style power supply (24 Vdc output)
- USB Serial converter box with USB cable to connect to PC
- Two connection cables:
 - Cable for sensor ordered with the D60 integral connector option.
 - Cable with quick connects for sensor ordered with the integral cable option.
- G-Series Analog PC Setup software, available for download at <http://www.mtssensors.com>

G-Series PC Setup and Configuration Software Interface

VISUAL SOFTWARE INTERFACE

The G-Series PC Setup and configuration software provides a user-friendly interface (see 'Figure 3') along with the sensor's advanced technology enables the operator to take advantage of the following features:

- Built-in serial interfaces for robust hard-wired serial communication (RS-485).
- Remote programmability for operational modes and sensor parameters (see 'Table 1').

**G-Series GT
Redundant**

G-Series Models GT2 and GT3 Redundant Sensors
Monitoring, Diagnostics/Advanced Programmability and Dimensions

G-Series PC Setup and Configuration Software Interface (Cont.)

ANALOG (VOLTAGE/CURRENT) OUTPUT FEATURES
Voltage or current output mode
Voltage or current output range
Full adjustment for Null and Span setpoints

G-SERIES HANDHELD PROGRAMMER ACCESSORY FOR ANALOG OUTPUT

Programming for your G-Series analog output sensor can be achieved in the field using the G-Series Analog Handheld programmer accessory, part no. 253853 (see 'Figure 4').

Table 1. Remote programmability and operational modes

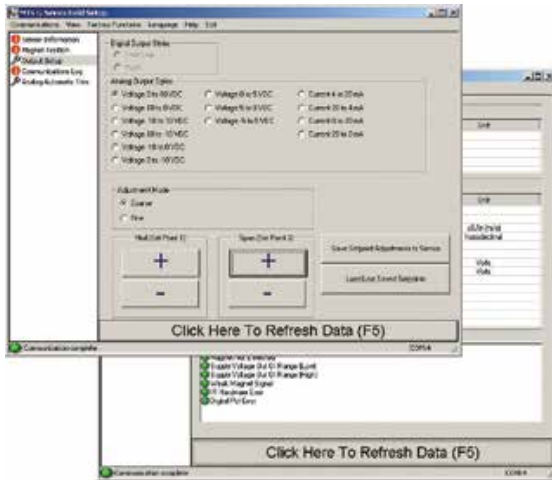

Figure 3. G-Series PC setup software interface examples



Figure 4. G-Series Analog Handheld Programmer (part no.: 253853). Front and back views shown.

Using the G-Series Analog Handheld Programmer, magnet positions and corresponding output values can be adjusted for the beginning of stroke (Setpoint 1) and for the end of stroke (Setpoint 2) that is actually needed for the specific application. These adjustments are easily done, even when the sensor is not directly accessible, by connecting the programmer to the sensor's integral cable or extension cable. Additionally, the programmer has its own red and green LEDs to provide a remote display of the sensor's status and error diagnostics. For detailed information refer to the G-Series Analog Handheld Programmer Operating Instructions (document part no.: 551024) available at <http://www.mtsensors.com>.

Model GT2 rod-style sensor dimension references

Note:
 When mounting the sensor, use a basic wrench (see 'Figure 5') with a maximum 8 mm (0.31 in.) thickness to ensure tightening torque is only applied to the hex flange and not to the electronics housing.

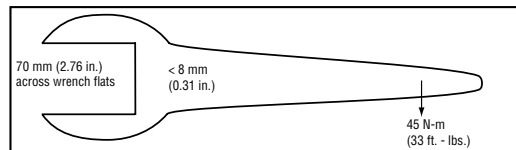

Figure 5. Basic wrench

Temposonics G-Series rod-style sensors (Models GT2/GT3) offer modular construction, flexible mounting configurations, and easy installation. Models GT2/GT3 sensors are designed for mounting in applications where high pressure conditions exist (5000 psi continuous, 10,000 psi spike), such as inside hydraulic cylinders (see 'Figure 8'). Both GT2 and GT3 sensor models can also be mounted externally in many applications.

MODEL GT3 ROD-STYLE SENSOR WITH RING MAGNET (MAGNET ORDERED SEPARATELY)

Drawing is for reference only, contact applications engineering for tolerance specific information.

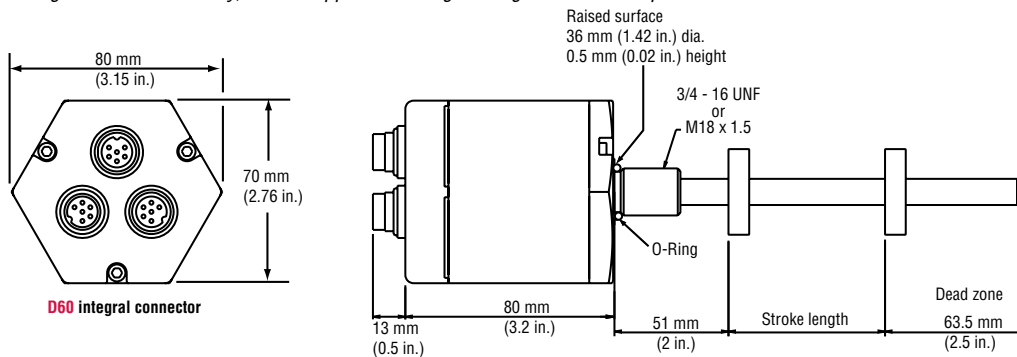

Figure 6. Models GT3 Rod-style sensor dimension reference (shown with D60 integral connection type)

**G-Series GT
 Redundant**

Model GT3 rod-style sensor dimension references

MODEL GT3 ROD-STYLE SENSOR WITH INTEGRAL CABLE (MAGNET ORDERED SEPARATELY)

Drawing is for reference only, contact applications engineering for tolerance specific information.

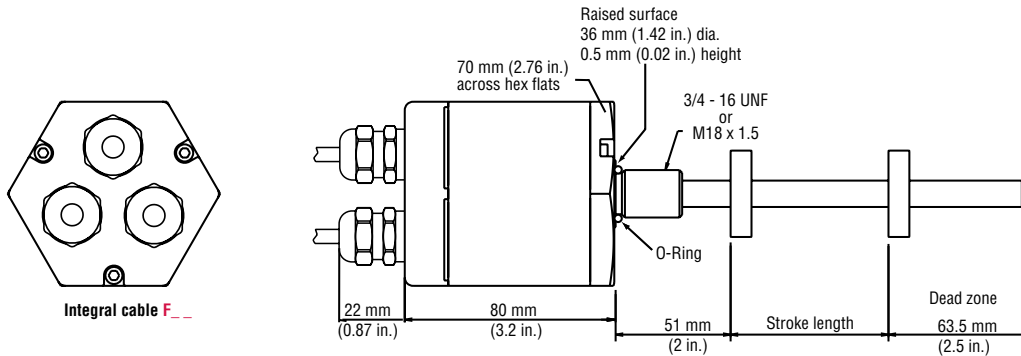



Figure 7. Model GT3 Rod-style sensor dimension reference (shown with integral cable)

Standard magnets, mounting and installation (Model GT2 and GT3)

Magnets must be ordered separately with Model GT2 and GT3 position sensors. The standard ring magnet (part number 201542-2) is suitable for most applications.

 Refer to the Accessories section of this catalog for magnet selections and detailed mounting and installation information.

Models GT2/GT3 connections and wiring

STANDARD MALE (D60) 6-PIN DIN INTEGRAL CONNECTOR (M16)



Male, 6-pin (D60) integral connector pin-out as viewed from the end of the sensor.

Important Notes:

1. A grounding lug on the end of the sensor is provided for convenient connection to earth ground.
2. Appropriate grounding of cable shield is required at the controller end.
3. For analog output sensors, the yellow wire (pin 3) and green wire (pin 4) provide serial communications. If possible, during sensor installation these wires should be placed for easy access if future programming or diagnostics are needed. When these wires are not used, they should be isolated with electrical tape to avoid unintended contact with other nearby wires or machine surfaces.

Pin Number	Wire Color	Function / Analog output
1	Gray	0 to 10, -10 to +10, or 4 to 20 mA, 0 to 20 mA or reverse acting: 10 to 0, 10 to -10 Vdc or 20 to 4 mA, 20 to 0 mA
2	Pink	Return for pin 1
3	Yellow	Programming (RS-485+)
4	Green	Programming (RS-485-)
5	Red or Brown	Supply voltage (+Vdc)
6	White	DC ground (for supply)

G-Series GT
Redundant

Models GT2 and GT3 Sensors
Ordering Information

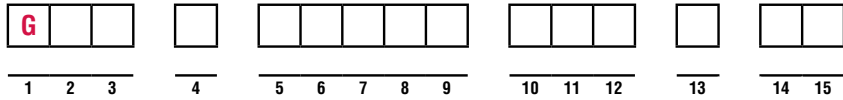

SENSOR MODEL _____ = **G** **T** **1-3**

GT2 = Double-redundant rod-style sensor

GT3 = Triple-redundant rod-style sensor

HOUSING STYLE _____ = **4**

Model GT rod-style sensor (magnet(s) must be ordered separately):

S = US customary threads and pressure tube, standard **M** = Metric threads and pressure tube, standard

STROKE LENGTH _____ = **5-9**

_____ **M** = Millimeters
(Encode in 5 mm increments)

_____ **U** = Inches and tenths
(Encode in 0.1 in. increments)

Stroke Length Note:
 Rod-style sensor (model GT) stroke range = 50 mm (2 in.) - 2900 mm (114 in.)

CONNECTION TYPE _____ = **10-12**

Integral connector:

D60 = 6-pin DIN (M16), male, standard (2X or 3X)

Integral cables:

F _____ = Integral cable, black polyurethane jacket with pigtail termination (2X or 3X)

Cable length:
 Encode in feet if using US customary stroke length
 Encode in meters if using metric stroke length
 _____ = 3 (**03**) to 98 (**98**) ft. or 1 (**01**) to 30 (**30**) meters.

Cable Length Note:
 MTS recommends the maximum integral cable length to be 10 meters (33 ft.). Cables greater than 10 m (33 ft.) in length are available, however, proper care must be taken during handling and installation.

INPUT VOLTAGE _____ = **13**

1 = +24 Vdc (+20% - 15%)

OUTPUT _____ = **14-15**

- | | |
|----------------------------|------------------------|
| V0 = 0 to +10 Vdc | A0 = 4 to 20 mA |
| V1 = +10 to 0 Vdc | A1 = 20 to 4 mA |
| V2 = -10 to +10 Vdc | A2 = 0 to 20 mA |
| V3 = +10 to -10 Vdc | A3 = 20 to 0 mA |

Note:
 Standard factory settings configure all outputs to be the same per the output option selected (when configuring the model number). If needed, an output can be individually reprogrammed in the field to best fit the application.



Temposonics®

Magnetostrictive, Absolute, Non-contact
Linear-Position Sensors



E-Series Model EH
Analog/Digital-Pulse (Start/Stop) Outputs

Document Part Number:
551250 Revision C

Data Sheet

E-Series
Model EH



Model EH rod-style position sensor
Stroke Length: 50 mm to 2500 mm (2 in. to 100 in.)

FEATURES

- Linear, Absolute Measurement
- Non-Contact Sensing Technology
- Linearity Deviation Less Than 0.02% F.S.
- Repeatability Within 0.005% F.S.
- Two Outputs Available:
 - Analog (Voltage/Current) Forward or Reverse Acting
 - Start/Stop Output
- Simple Sensor Parameter Upload (for Start/Stop)
- Stroke Length Range: 50 mm to 2500 mm (or 2 in. to 100 in.)
- Hermetically-Sealed Stainless Steel For IP69K Ingress Protection
- EMI Shielded and CE Certified
- Also with Stainless Steel 1.4404 / AISI 316L available

BENEFITS

- Compact Stainless Steel Position Sensor, Designed For Use In Hydraulic Cylinders
 - Standard 10 mm dia. Sensor Rod For Typical Applications
 - Optional 7 mm dia. Sensor Rod For Use In Small Bore Cylinders
- Simultaneous Multi-position Measurements
- Over Voltage Protection to 36 Vdc and Polarity Protection up to -30 Vdc

APPLICATIONS

- Clevis Mounted or Space Limited Cylinder Applications
- Harsh Industrial Conditions
- High-Pressure Washdown
- Gates and Valve Control

TYPICAL INDUSTRIES

- Fluid Power
- Factory Automation
- Steel Mills
- Material Handling and Packaging
- Water Management



Sold & Serviced By:

ELECTROMATE

Toll Free Phone (877) SERV098

Toll Free Fax (877) SERV099

www.electromate.com

sales@electromate.com

E-Series Model EH Sensor, Analog and Start/Stop Outputs
Product Overview/Specifications

**E-Series
Model EH**

Product overview

MTS Sensors continues to establish new performance standards for low-cost, fully-industrial, durable position sensors using the widely preferred magnetostrictive technology. This principle for accurate and non-contact measurement of linear-position sensing was developed 30 years ago by MTS and is used with outstanding success in a large variety of industrial applications. The Temposonics model EH sensor provides as much performance as you need for your application - you benefit from the advantages of magnetostrictive position measurement at optimum costs.

The Temposonics® Model EH sensor features a pressure resistant sensor rod for direct stroke measurement inside hydraulic cylinders. With its minimized sensor head and either a 7 mm or 10 mm rod, it is the ideal solution when space is critical. For long strokes, the model EH is available with measuring ranges up to 2500 mm (or 100 in.).

The model EH sensor offers completely sealed stainless-steel housing for long life position measurement for rugged environments. When installed with the appropriate mating connector and cable, it features protection up to IP69K and is suitable for high-pressure washdown applications.

Product specifications

Parameters	Specifications	Parameters	Specifications
OUTPUT		ENVIRONMENTAL	
Measured output variable:	Position	Operating conditions:	Operating temperature: -40 °C (-40 °F) to 75 °C (167 °F) Relative humidity: 90% no condensation Ingress protection: IP69K** <i>(when appropriate mating connector is correctly fitted)</i>
Resolution:	Analog: Infinite (restricted by output ripple) Start/Stop: 0.1, 0.01 and 0.005 mm (controller dependent)	EMC test:	Electromagnetic emission: EN 61000-6-4 Electromagnetic susceptibility: EN 61000-6-2 The sensor meets the requirements of the EC directives and is marked with CE.
Linearity deviation:	< ± 0.02% full stroke (minimum ± 60 µm)	Shock rating:	100 g (single hit)/ IEC standard EN 60068-2-27
Repeatability:	< ± 0.005% full stroke (minimum ± 20 µm)	Vibration rating:	15 g/10 to 2000 Hz, IEC standard EN 60068-2-6 (resonance frequencies excluded)
Outputs:	Analog (voltage or current) Voltage: 0 to 10 Vdc or 10 to 0 Vdc or Two outputs: 0 to 10 Vdc and/or 10 to 0 Vdc (controller input resistance RL ≥ 5k Ohm) Current: 4 to 20 mA or 20 to 4 mA or Two outputs: 4 to 20 mA or 20 to 4 mA (controller input resistance RL ≤ 500 Ohm)	WIRING	
	Digital-pulse (Start/Stop): RS-422 differential signal Serial parameter upload available for: Measuring range, offset, gradient, status and manufacturer number	Connection types:	Analog output: 5-pin (M12) male integral connector Start/Stop output: 8-pin (M12) male integral connector
Stroke length:	Range: 50 mm to 2500 mm (or 2 to 100 in.)	ROD-STYLE SENSOR (MODEL EH)	
ELECTRONICS		Sensor housing:	Stainless Steel 1.4305 / AISI 303; Stainless Steel 1.4404 / AISI 316L
Operating voltage:	+24 Vdc nominal: -15% or +20%* Polarity protection: up to -30 Vdc Over voltage protection: up to 36 Vdc Current drain: <i>Analog:</i> 50 to 140 mA <i>Start/Stop:</i> 50 to 100 mA <i>(Stroke length dependent)</i> Dielectric withstand voltage: 500 Vdc (DC ground to machine ground)	Sensor rod:	Stainless Steel 1.4301 / AISI 304; Stainless Steel 1.4404 / AISI 316L for 10 mm diameter rod only
		Operating pressure:	7 mm Rod: 300 bar static, 350 bar peak (4350 psi static, 5076 psi peak) 10 mm Rod: 350 bar static, 450 bar peak (5000 psi static, 6526 psi peak)
		Mounting:	Any orientation. Threaded flange M18 x 1.5 or 3/4 - 16 UNF-3A
		Typical mounting torque:	45 N-m (33 ft. - lbs.)
		Magnet types:	Ring magnet, open-ring magnet or magnet float

* UL Recognition requires an approved power supply with energy limitation (UL 61010-1), or Class 2 rating according to the National Electrical Code (USA) / Canadian Electrical Code.

** The IP rating is not part of the UL Recognition.

Outputs

Analog (voltage/current) outputs

Analog outputs include voltage (0 to 10 Vdc forward or reverse acting), and current (4 to 20 mA forward or reverse acting). Since the outputs are direct, no signal conditioning electronics are needed when interfacing with controllers or meters (see 'Figure 1').

Analog output ranges:

- 0 to 10 Vdc
- 10 to 0 Vdc
- 0 to 10 Vdc and 10 to 0 Vdc
- 4 to 20 mA
- 20 to 4 mA

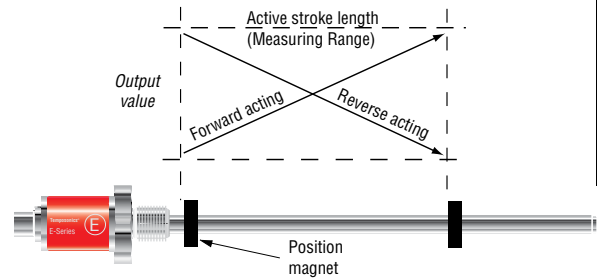

DIGITAL (START/STOP) OUTPUTS

The Temposonics E-Series Model EH Start/Stop output sensor requires a start signal from a controller or interface module to initiate the measurement cycle. The sensor generates a stop signal at the end of the measurement cycle that is used to stop the controller's counter clock.

The elapsed time between the Start and Stop signals is directly proportional to the magnet's position along the active stroke length. The controller can calculate the absolute position of the magnet from the time value and the sensor's unique gradient value (inverse of the speed for the sonic pulse traveling in the sensor's waveguide). (see 'Figure 2').

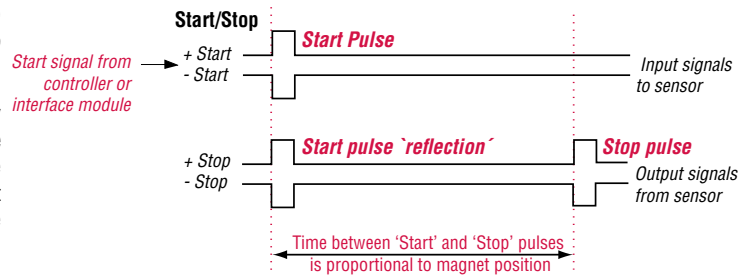

Dual magnet outputs

MEASUREMENT OPTIONS

E-Series sensors provide options for simultaneous multi-position measurements by using more than one magnet per sensor. When using Start/Stop sensor output the ability to process multiple magnets depends on the capability of the controller or interface module that is used. When using analog type outputs (voltage or current) the sensor is limited to a maximum of two magnets.

For analog output types the options for single-magnet or dual-magnets is specified in the sensor model number when ordered. For single-magnet sensors the sensor's full active stroke length is utilized by the one magnet. For example when using forward-acting outputs, the output is 0% of its value when the magnet is at the null position (start of stroke) and 100% of its value when at the edge of the dead zone (end of stroke), (see 'Figure 3').

However, for dual-magnet sensors the sensor's active stroke length must be shared by the two magnets, and a separation \geq 75 mm (3 in.) must be maintained between the two magnets (front side of the first magnet to front side of the second magnet). This minimum distance between magnets is needed to maintain proper sensor output. Therefore, for the second magnet the start of stroke (0% output) is set at 75 mm away from the sensor's null position. Likewise, for the first magnet the end of stroke (100% output) is now set 75 mm away from the edge of the dead zone (see 'Figure 3').

The result of using the dual-magnet E-Series options is that the stroke length available for each magnet is 75 mm less (or 3 inches less when specifying stroke length in inches) than the sensor's full active stroke length as indicated in the model number.

When ordering the single-magnet E-Series sensor the minimum stroke length available is 50 mm or 2 inches. However when ordering dual magnet E-Series sensors the minimum stroke length available is 125 mm (i.e. 50 mm minimum, plus 75 mm for the minimum distance between magnets). Likewise, when specifying stroke length in inches the minimum stroke length available is 5 inches (i.e. 2 inch minimum, plus 3 inches for the minimum distance between magnets).

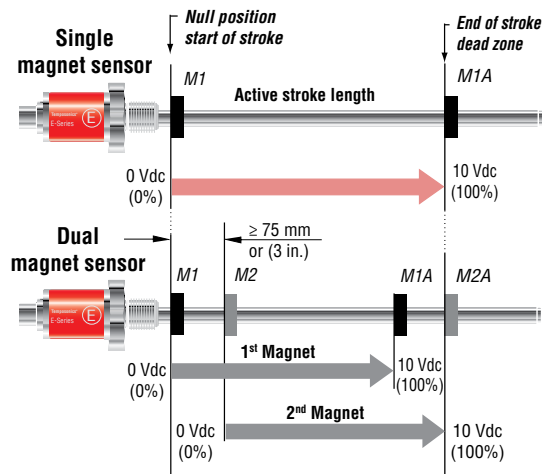

E-Series Model EH Sensor, Analog and Start/Stop Outputs Sensor Communications, Dimension and Magnet References

Communication

SENSOR PARAMETER UPLOAD FEATURE

For applications using smart sensor interfaces, the Model EH sensor with Start/Stop output (*Option R3*) comes with the ability to perform sensor parameter uploads. This feature replaces the task of entering sensor data manually, saving time and preventing possible entry errors during start-up or for system maintenance.

Note: Start/Stop output (option R3)

When the sensor parameter upload feature is not activated the Start/Stop output (Option **R3**) remains fully compatible with the Start/Stop output (Option **R0**) used in the previous generation E-Series sensor family.

The upload feature supports the following sensor parameters:

- Measuring range
- Offset
- Gradient - (Shown as speed of the sonic-strain pulse (m/s) or inverse speed (µs/in.)
- Status
- Manufacturer number

The sensor's specific parameters can be retrieved by the controller and interface module at any time, via the sensor's Start/Stop signal lines.

The sensor parameter upload feature requires a customer supplied RS-422 interface. The data format is serial, 4800 Baud, 8-bit data length. Please contact the factory for additional parameter upload protocol details.

Sensor dimension references

Drawings are for reference only, contact applications engineering for tolerance specific information.

The model EH sensor shown in 'Figure 4' can be ordered with flange styles M18 x1.5 or 3/4 -16 UNF-3A and a 7 mm or 10 mm diameter sensor rod. Magnets must be purchased separately; refer to 'Standard magnet Selections (Model EH)' for standard magnet ordering information.

MODEL EH

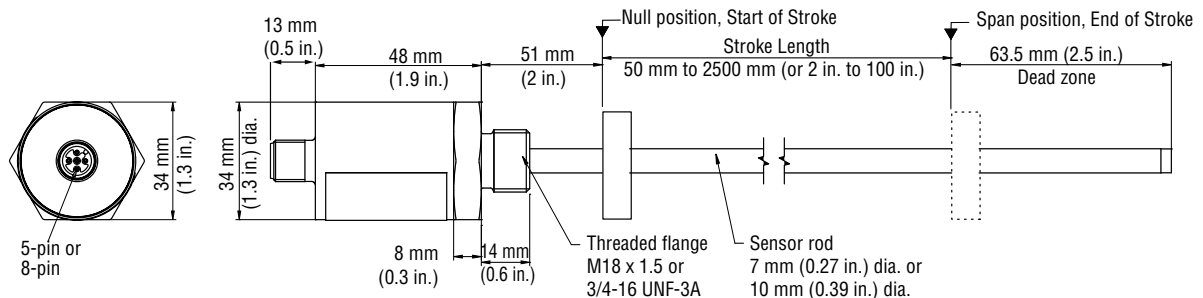

Refer to the model EH sensor ordering information for rod housing and flange types

Figure 4. E-Series model EH sensor dimension reference

Standard magnets, mounting and installation (Model EH)

Magnets must be ordered separately with Model EH rod-style sensors. The standard ring magnet (part number 201542-2) is suitable for most applications.

 Refer to the Accessories section of this catalog for magnet selections and detailed mounting and installation information.

Connections and wiring (Model EH)

SENSOR INTEGRAL CONNECTOR (D34 AND D84) PINOUT/WIRE COLOR CODES

The E-Series Model EH sensor connects directly to a controller or interface module with the standard male, 5-pin or 8-pin integral connector and an extension cable as described in 'Table 1' and 'Table 2'.



Integral D34 connector (male) as viewed from the end of the sensor

Pin no.	Extension cable wire color	Signal/function Analog outputs
1	Brown	+24 Vdc
2	White	Output signal
3	Blue	DC ground (for power return)
4	Black	2nd Output signal (optional)
5	Gray	Ground for signal return

Table 1. Integral D34 sensor connector
(mates with cable connectors 370618 and 370619)



Integral D84 connector (male) as viewed from the end of the sensor

Pin no.	Extension cable wire color	Signal/function Start/Stop outputs
1	White	(+) Start
2	Brown	(-) Start
3	Green	(+) Stop
4	Yellow	(-) Stop
5	Gray	No connection
6	Pink	No connection
7	Blue	+24 Vdc
8	Red	DC Ground (0 Vdc) for power return

Table 2. Integral D84 sensor connector
(mates with cable connectors 370671 and 370672)

E-Series Model EH Sensor, Analog and Start/Stop Outputs

Ordering Information

**E-Series
Model EH**

Use the order matrix below to configure your Model EH sensor order number.

E	H							D			1			
1	2	3	4	5	6	7	8	9	10	11	12	13	14	15

2 or 3 digit code

- SENSOR MODEL** _____ = **E H** **1 - 2**
- EH** = E-Series model EH rod-style sensor (Magnet(s) must be ordered separately)
- ROD HOUSING AND FLANGE TYPE** _____ = **3**
- K** = Flange M18 x 1.5 / Rod 7 mm dia.
- M** = Flange M18 x 1.5 / Rod 10 mm dia.
- W** = Flange M18 x 1.5 / Rod 10 mm dia. (316L)
- L** = Flange 3/4 in. -16 / Rod 7 mm dia.
- S** = Flange 3/4 in. -16 / Rod 10 mm dia.
- F** = Flange 3/4 in. - 16 / Rod 10 mm dia. (316L)
- STROKE LENGTH** _____ = **4 - 8**
- **M** = Millimeters (Encode in 5, 10, 25 or 50 mm increments) as indicated in 'Stroke length notes' below.
- **U** = Inches (Encode in 0.2, 0.5, 1 or 2 in. increments) as indicated in 'Stroke length notes' below.

Stroke length Notes:

Stroke length ranges:
M = 50 mm to 2500 mm
U = 2 in. to 100 in.

The increment size between standard stroke lengths vary as shown below:

Stroke length (mm)	Ordering increment
≤ 500 mm	5 mm
> 500 mm and ≤ 750 mm	10 mm
> 750 mm and ≤ 1000 mm	25 mm
> 1000 mm and ≤ 2500 mm	50 mm
Stroke length (IN)	Ordering increment
≤ 20 in.	0.2 in.
> 20 in. and ≤ 30 in.	0.5 in.
> 30 in. and ≤ 40 in.	1 in.
> 40 in. and ≤ 100 in.	2 in.

- SENSOR CONNECTION TYPES** _____ = **D** **9 - 11**
- D34** = 5-Pin (M12), male (Analog output)
- D84** = 8-Pin (M12), male (Start/Stop output)
- INPUT VOLTAGE** _____ = **1** **12**
- 1** = +24 Vdc (+20%, -15%), standard
- OUTPUT** _____ = **13 - 15**
- VOLTAGE**
- V01** = 0 to 10 Vdc (1 output channel with 1 magnet)
- V11** = 10 to 0 Vdc (1 output channel with 1 magnet)
- V02** = 0 to 10 Vdc (2 output channels with 2 magnets) Refer to 'Dual magnet outputs' for more information.
- V12** = 10 to 0 Vdc (2 output channels with 2 magnets) Refer to 'Dual magnet outputs' for more information.
- V03** = 0 to 10 Vdc and 10 to 0 Vdc (2 output channels with 1 magnet)
- CURRENT**
- A01** = 4 to 20 mA (1 output channel with 1 magnet)
- A11** = 20 to 4 mA (1 output channel with 1 magnet)
- A02** = 4 to 20 mA (2 output channels with 2 magnets) Refer to 'Dual magnet outputs' for more information.
- A12** = 20 to 4 mA (2 output channels with 2 magnets) Refer to 'Dual magnet outputs' for more information.
- START/STOP**
- R3** = Start/Stop with sensor parameters upload function
- Start/Stop output (Option **R3**) is fully compatible with the Start/Stop output (Option **R0**) used in the previous generation E-Series sensors.

Temposonics®

Magnetostrictive, Absolute, Non-contact
Linear-Position Sensors



E-Series Model EH CANopen Output Data Sheet

Document Part Number:
551313 Revision D

E-Series
Model EH



Model EH rod-style position sensor
Stroke Length: 50 mm to 2500 mm (or 2 in. to 100 in.)

FEATURES

- Linear, Absolute Measurement
- Non-Contact Sensing Technology
- Linearity Deviation Less Than 0.02% F.S.
- Repeatability Within 0.005% F.S.
- CANopen Interface:
 - Direct Position Output
 - Velocity Output
- Single or Dual Magnet Measurements
- Stroke Length Range: 50 mm to 2500 mm (or 2 in. to 100 in.)
- Hermetically-Sealed Stainless Steel For IP69K Ingress Protection
- EMI Shielded and CE Certified
- Also with Stainless Steel 1.4404 / AISI 316L available

BENEFITS

- Compact Stainless Steel Position Sensor, Designed For Use In Hydraulic Cylinders
 - Standard 10 mm dia. Sensor Rod For Typical Applications
 - Optional 7 mm dia. Sensor Rod For Use In Small Bore Cylinders
- Simultaneous Multi-position Measurements for 2 Magnets
- Over Voltage Protection to 36 Vdc and Polarity Protection up to -30 Vdc

APPLICATIONS

- Clevis Mounted or Space Limited Cylinder Applications
- Harsh Industrial Conditions
- High-Pressure Washdown
- Gates and Valve Control

TYPICAL INDUSTRIES

- Fluid Power
- Factory Automation
- Steel Mills
- Material Handling and Packaging
- Water Management



Sold & Serviced By:

ELECTROMATE

Toll Free Phone (877) SERV098

Toll Free Fax (877) SERV099

www.electromate.com

sales@electromate.com

E-Series Model EH Sensor, CANopen Output Product Overview/Specifications

Product overview

MTS Sensors continues to establish new performance standards for low-cost, fully-industrial, durable position sensors using the widely preferred magnetostrictive technology. This principle for accurate and non-contact measurement of linear-position sensing was developed 30 years ago by MTS and is used with outstanding success in a large variety of industrial applications. The Temposonics model EH sensor provides as much performance as you need for your application - you benefit from the advantages of magnetostrictive position measurement at optimum costs.

The Temposonics® Model EH sensor features a pressure resistant sensor rod for direct stroke measurement inside hydraulic cylinders. With its minimized sensor head and either a 7 mm or 10 mm rod, it is the ideal solution when space is critical. For long strokes, the model EH is available with measuring ranges up to 2500 mm (or 100 in.).

The model EH sensor offers completely sealed stainless-steel housing for long life position measurement for rugged environments. When installed with the appropriate mating connector and cable, it features protection up to IP69K and is suitable for high-pressure washdown applications.

Product specifications

Parameters	Specifications
OUTPUT	
Measured output variables:	Position, Velocity for single or dual magnets
Resolution:	Position: 10 µm, 20 µm Velocity: 1mm/s
Update times:	1.0 ms up to 2400 mm
Linearity deviation:	< ± 0.02% full stroke (minimum ± 60 µm)
Repeatability:	< ± 0.005% full stroke (minimum ± 10 µm)
Outputs:	Interface: CAN-Fieldbus System according to ISO/DIS 11898 Data protocol: CANopen Encoder Profile DS 406 V3.1 CiA Standard DS 301 v3.0
Baud rate, kBit/s:	1000 800 500 250 125
Cable length, m:	< 25 < 50 < 100 < 250 < 500
Stroke length:	Range: 50 mm to 2500 mm (or 2 in. to 100 in.)

ELECTRONICS

Operating voltage:	+24 Vdc nominal: -15% or +20% * Polarity protection: ≥ -30 Vdc Over voltage protection: ≤ 36 Vdc Current drain: 40 to 60 mA (Stroke length dependent) Dielectric withstand voltage: 500 Vdc (DC ground to machine ground)
---------------------------	--

* UL Recognition requires an approved power supply with energy limitation (UL 61010-1), or Class 2 rating according to the National Electrical Code (USA) / Canadian Electrical Code.

** The IP rating is not part of the UL Recognition.

Parameters	Specifications
ENVIRONMENTAL	
Operating conditions:	Operating temperature: -40 °C (-40 °F) to 75 °C (167 °F) Relative humidity: 90% no condensation Ingress protection: IP69K (when appropriate mating connector is correctly fitted) **
EMC test:	Electromagnetic emission: EN 61000-6-4 (for use in industrial environment) Electromagnetic immunity: EN 61000-6-2. The sensor meets the requirements of the EC directives and is marked with CE.
Shock rating:	100 g (single hit)/ IEC standard EN 60068-2-27
Vibration rating:	15 g/10 to 2000 Hz, IEC standard EN 60068-2-6 (resonance frequencies excluded)
WIRING	
Connection type:	5-pin (M12) male integral connector
ROD-STYLE SENSOR (MODEL EH)	
Sensor housing:	Stainless Steel 1.4305 / AISI 303; Stainless Steel 1.4404 / AISI 316L
Sensor rod:	Stainless Steel 1.4301 / AISI 304; Stainless Steel 1.4404 / AISI 316L for 10 mm diameter rod only
Operating pressure:	7 mm Rod: 300 bar static, 350 bar peak (4350 psi static , 5076 psi peak) 10 mm rod: 350 bar static, 450 bar peak (5076 psi static , 6526 psi peak)
Mounting:	Any orientation. Threaded flange M18x1.5 or 3/4-16 UNF-3A
Typical mounting torque:	45 N-m (33 ft. - lbs.)
Magnet types:	Ring magnet, open-ring magnet or magnet float

CANopen communication and functionality

Temposonics linear-position sensors fulfill all requirements of CANbus (ISO 11898). The sensor's electronics convert the position measurements into bus oriented outputs and transfer this data directly to the controller. The CANbus interface is appropriate for serial data transfer up to 1 Mbps maximum. Sensor integrated software supports bus profile CANopen. This communication protocol allows for a comprehensive customized configuration of the sensor-bus system.

TEMPOSONICS E-SERIES SENSORS WITH CANOPEN INTERFACE

E-Series sensors with CANopen protocol are based as bus-nodes on the OSI reference model and are available with application data for single or dual-magnet measurements:

APPLICATION DATA:

- Position measurement
- Velocity measurement
- Setpoints
- Status

CANopen corresponds to encoder profile 'DS-406 V3.1 (CiA Draft standard DS-301 V3.0)'. The CANopen functionality is described below in the following communication objects.

CANopen CONFIGURATION TOOL

The EDS (Electronic Data Sheet) download is available at www.mtssensors.com for configuration.

SERVICE DATA OBJECT (SDO)

The SDO is mainly used for sensor configuration. SDO messages are used for read and write access to all entries in the object directory.

Selectable parameters are as follows:

- Operational range setup for magnets 1 and 2
- Zero adjustment preset for magnets 1 and 2
- 4 set points for each magnet

PROCESS DATA OBJECT (PDO)

The PDO provides data transfer of sensor measurements in up to 8-byte data blocks. The sensor uses PDO's to relay parameters for each magnet in one or two PDO's

DATA FORMATS:

- Position
- Velocity
- Limit status
- Limit status of operational range

PDO TRANSMISSION TYPES

- Asynchronous (cycle time of 1 to 65.535 ms) or synchronous
- Synchronization Object (SYNC) messages are sent from the controller to the sensor, the sensor then transmits measurement values

SYNC OBJECT

Is responsible for synchronized bus communication

EMERGENCY OBJECT

Emergency messages are transmitted as:

- Sensor signal breakdown
- Communication fault

E-Series Model EH Sensor, CANopen Output Measurement Options and Dimension References

E-Series
Model EH

Dual magnet outputs

MEASUREMENT OPTIONS

E-Series sensors provide options for simultaneous multi-position measurements by using up to two magnets per sensor.

The options for single-magnet or dual-magnets is specified in the sensor model number when ordered. For single-magnet sensors the sensor's full active stroke length is utilized by the one magnet. For example when using forward-acting outputs, the output is 0% of its value when the magnet is at the null position (start of stroke) and 100% of its value when at the edge of the dead zone (end of stroke), (see 'Figure 1').

However, for dual-magnet sensors the sensor's active stroke length must be shared by the two magnets, and a separation \geq or $=$ to 75 mm (3 in.) must be maintained between the two magnets (front side of the first magnet to front side of the second magnet). This minimum distance between magnets is needed to maintain proper sensor output. Therefore, for the second magnet the start of stroke (0% output) is set at 75 mm away from the sensor's null position. Likewise, for the first magnet the end of stroke (100% output) is now set 75 mm away from the edge of the dead zone (see 'Figure 1').

The result of using the dual-magnet E-Series options is that the stroke length available for each magnet is 75 mm less (or 3 inches less when specifying stroke length in inches) than the sensor's full active stroke length as indicated in the model number.

When ordering the single-magnet E-Series sensor the minimum stroke length available is 50 mm or 2 inches. However when ordering dual magnet E-Series sensors the minimum stroke length available is 125 mm (i.e. 50 mm minimum, plus 75 mm for the minimum distance between magnets). Likewise, when specifying stroke length in inches the minimum stroke length available is 5 inches (i.e. 2 inch minimum, plus 3 inches for the minimum distance between magnets).

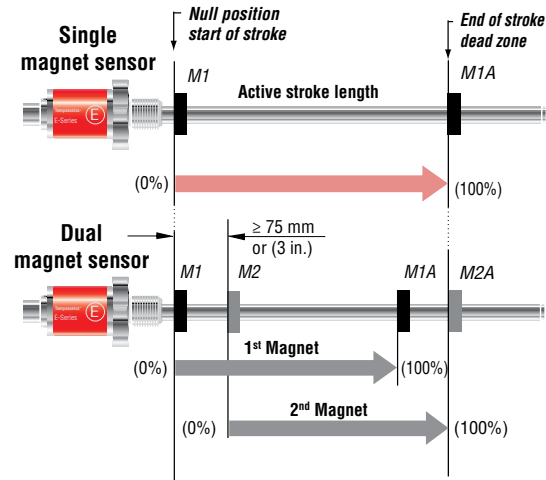

Figure 3. Single and dual-magnet measurements

Sensor dimension references

Drawings are for reference only, contact applications engineering for tolerance specific information.

The model EH sensor shown in 'Figure 2' can be ordered with flange styles M18 x 1.5 or 3/4 -16 UNF-3A and a 7 mm or 10 mm diameter sensor rod. Magnets must be purchased separately; refer to 'Standard magnet Selections (Model EH)' for standard magnet ordering information.

MODEL EH

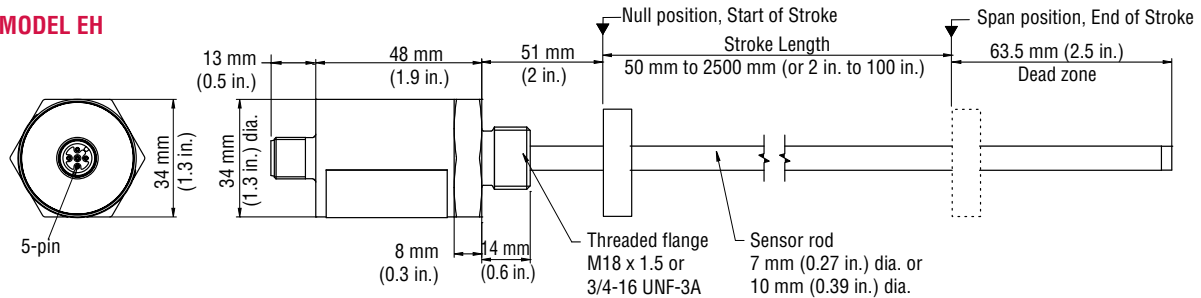



Figure 2. E-Series model EH sensor dimension reference

Refer to the model EH sensor ordering information for rod housing and flange types

Standard magnets, mounting and installation (Model EH)

Magnets must be ordered separately with Model EH rod-style sensors. The standard ring magnet (part number 201542-2) is suitable for most applications.

 Refer to the Accessories section of this catalog for magnet selections and detailed mounting and installation information.

Connections and wiring (Model EH)

SENSOR INTEGRAL CONNECTOR (D34) PINOUT/WIRE COLOR CODES

The E-Series Model EH sensor connects directly to a controller or interface module with the standard male, 5-pin integral connector and an extension cable as described in 'Table 1'



Integral D34 connector (male) as viewed from the end of the sensor

Pin no.	Signal/function CANopen outputs
1	Shield
2	+24 Vdc
3	DC ground (for power return)
4	CAN (+)
5	CAN (-)

Integral D34 sensor connector

Temposonics®

Magnetostrictive, Absolute, Non-contact
Linear-Position Sensors



E-Series
Model EH

E-Series Model EH Synchronous Serial Interface (SSI) Output Data Sheet

Document Part Number:
551314 Revision D



Model EH rod-style position sensor
Stroke Length: 50 mm to 2500 mm (or 2 in. to 100 in.)

FEATURES

- Linear, Absolute Measurement
- Non-Contact Sensing Technology
- Linearity Deviation Less Than 0.02% F.S.
- Repeatability Within 0.005% F.S.
- SSI Provides a High-Speed Noise Immune and Cost Effective Sensor interface
- Stroke Length Range: 50 mm to 2500 mm (or 2 in. to 100 in.)
- Hermetically-Sealed Stainless Steel For IP69K Ingress Protection
- EMI Shielded and CE Certified
- Also with Stainless Steel 1.4404 / AISI 316L available

BENEFITS

- Compact Stainless Steel Position Sensor, Designed For Use In Hydraulic Cylinders
 - Standard 10 mm dia. Sensor Rod For Typical Applications
 - Optional 7 mm dia. Sensor Rod For Use In Small Bore Cylinders
- Resolution Down to 20 µm
- Direct 24/25 Bit SSI Output, Gray/Binary Formats
- Over Voltage Protection to 36 Vdc and Polarity Protection up to -30 Vdc

APPLICATIONS

- Clevis Mounted or Space Limited Cylinder Applications
- Harsh Industrial Conditions
- High-Pressure Washdown
- Gates and Valve Control

TYPICAL INDUSTRIES

- Fluid Power
- Factory Automation
- Steel Mills
- Material Handling and Packaging
- Water Management



Sold & Serviced By:



Toll Free Phone (877) SERV098

Toll Free Fax (877) SERV099

www.electromate.com

sales@electromate.com

E-Series Model EH Sensor, SSI Output
Product Overview/Specifications

**E-Series
Model EH**

Product overview

MTS Sensors continues to establish new performance standards for low-cost, fully-industrial, durable position sensors using the widely preferred magnetostrictive technology. This principle for accurate and non-contact measurement of linear-position sensing was developed 30 years ago by MTS and is used with outstanding success in a large variety of industrial applications. The Temposonics model EH sensor provides as much performance as you need for your application - you benefit from the advantages of magnetostrictive position measurement at optimum costs.

The Temposonics® Model EH sensor features a pressure resistant sensor rod for direct stroke measurement inside hydraulic cylinders. With its minimized sensor head and either a 7 mm or 10 mm rod, it is the ideal solution when space is critical. For long strokes, the model EH is available with measuring ranges up to 2500 mm (or 100 in.).

The model EH sensor offers completely sealed stainless-steel housing for long life position measurement for rugged environments. When installed with the appropriate mating connector and cable, it features protection up to IP69K and is suitable for high-pressure washdown applications.

Product specifications

Parameters	Specifications
OUTPUT	
Measured output variable:	Position
Resolution:	20 µm, 50 µm, 100 µm
Update rate:	
Measuring length:	300 mm 750 mm 1000 mm 2000 mm
Measurements/Sec.:	3.7 kHz 3.0 kHz 2.3 kHz 1.2 kHz
Linearity deviation:	< ± 0.02% full stroke (minimum ± 60 µm)
Repeatability:	< ± 0.005% full stroke (minimum ± 20 µm)
Outputs:	Interface: Synchronous Serial Interface (SSI). (RS-422 type differential signal pairs) Data format: Binary or gray Data length: 24 or 25 bit Data speed (Baud rate): 70 kBd to 1 MBd, depending on cable length (see below)
Length (m):	<3 <50 <100 <200 <400
Baud rate:	1.0 MBd <400 kBd <300 kBd <200 kBd <100 kBd
Stroke length:	Range: 50 mm to 2500 mm (or 2 to 100 in.)

Parameters	Specifications
ELECTRONICS	
Operating voltage:	+24 Vdc nominal: -15% or +20% * Polarity protection: ≥ -30 Vdc Over voltage protection: ≤ 36 Vdc Current drain: 90 mA typical Dielectric withstand voltage: 500 Vdc (DC ground to machine ground)

* UL Recognition requires an approved power supply with energy limitation (UL 61010-1), or Class 2 rating according to the National Electrical Code (USA) / Canadian Electrical Code.

** The IP rating is not part of the UL Recognition.

Parameters	Specifications
ENVIRONMENTAL	
Operating conditions:	Operating temperature: -40 °C (-40 °F) to 75 °C (167 °F) Relative humidity: 90% no condensation Ingress protection: IP69K (when appropriate mating connector is correctly fitted) **
EMC test:	Electromagnetic emission: EN 61000-6-3 Electromagnetic immunity: EN 61000-6-2 The sensor meets the requirements of the EC directives and is marked with CE
Shock rating:	100 g (single hit)/ IEC standard EN 60068-2-27
Vibration rating:	15 g/10 to 2000 Hz, IEC standard EN 60068-2-6 (resonance frequencies excluded)
WIRING	
Connection type:	8-pin (M12) male integral connector
ROD-STYLE SENSOR (MODEL EH)	
Sensor housing:	Stainless Steel 1.4305 / AISI 303; Stainless Steel 1.4404 / AISI 316L
Sensor rod:	Stainless Steel 1.4301 / AISI 304; Stainless Steel 1.4404 / AISI 316L for 10 mm diameter rod only
Operating pressure:	7 mm Rod: 300 bar static, 350 bar peak (4350 psi static, 5076 psi peak) 10 mm Rod: 350 bar static, 450 bar peak (5076 psi static, 6526 psi peak)
Mounting:	Any orientation. Threaded flange M18 x 1.5 or 3/4 - 16 UNF-3A
Typical mounting torque:	45 N-m (33 ft. - lbs.)
Magnet types:	Ring magnet, open-ring magnet or magnet float

Synchronous Serial Interface (SSI)

Temposonics E-Series sensors with SSI fulfill all requirements of the SSI standard for an absolute encoder. The position value is encoded in a 24/25 code format and is transmitted at high speed in SSI standard format to the control device. The main feature of SSI is the synchronized data transfer. Data transfer synchronization simplifies the closed-loop control system. A clock pulse train from a controller is used to gate out sensor data. One bit of position data is transmitted to the controller for each clock pulse received by the sensor (see 'Figures 1 and 2'). The absolute position data is continually updated by the sensor and converted by the shift register into serial information. (see 'Figure 3').

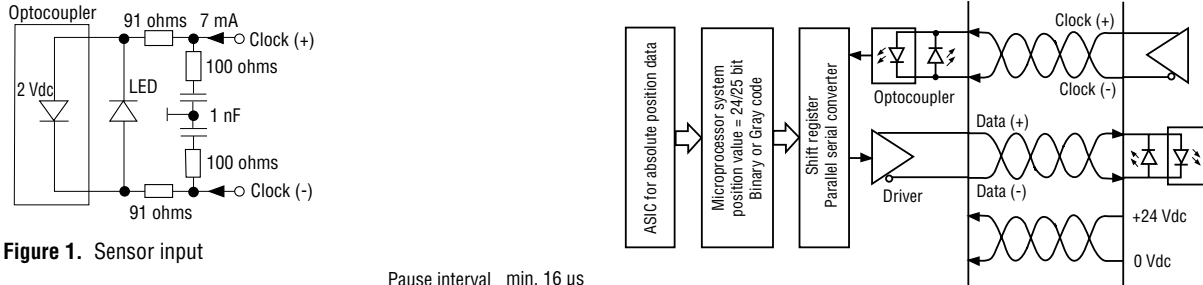
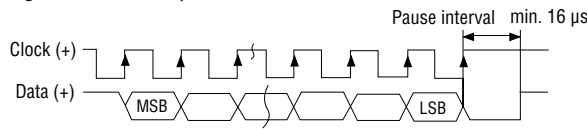

Figure 1. Sensor input



Timing Diagram

Sensor dimension references

Drawings are for reference only, contact applications engineering for tolerance specific information.

The model EH sensor shown in 'Figure 4' can be ordered with flange styles M18 x1.5 or 3/4 -16 UNF-3A and a 7 mm or 10 mm diameter sensor rod. Magnets must be purchased separately; refer to 'Standard magnet Selections (Model EH)' for standard magnet ordering information.

MODEL EH

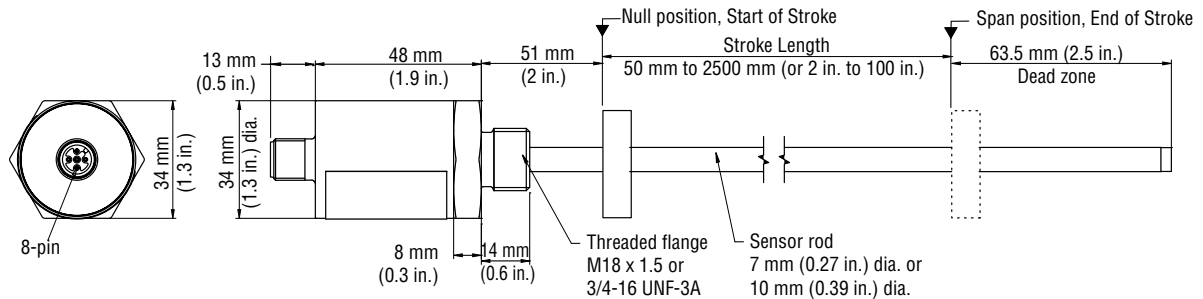

Refer to the model EH sensor ordering information for rod housing and flange types

Figure 4. E-Series model EH sensor dimension reference

Standard magnets, mounting and installation (Model EH)

Magnets must be ordered separately with Model EH rod-style sensors. The standard ring magnet (part number 201542-2) is suitable for most applications.

 Refer to the Accessories section of this catalog for magnet selections and detailed mounting and installation information.

E-Series Model EH Sensor, SSI Output Connections and Wiring

E-Series
Model EH

Connections and wiring (Model EH)

SENSOR INTEGRAL CONNECTOR (D84) PINOUT/WIRE COLOR CODES

The E-Series Model EH sensor connects directly to a controller or interface module with the standard male, 8-pin integral connector and an extension cable as described in 'Table 1'



Integral D84 connector (male) as viewed from the end of the sensor

Pin no.	Extension cable wire color	Signal/function
1	White	Clock (+)
2	Brown	Clock (-)
3	Green	Data (+)
4	Yellow	Data (-)
5	Gray	No connection
6	Pink	No connection
7	Blue	+24 Vdc
8	Red	DC ground (for power return)

Table 1. Integral D84 sensor connector

Sold & Serviced By:

 **ELECTROMATE**

Toll Free Phone (877) SERV098

Toll Free Fax (877) SERV099

www.electromate.com

sales@electromate.com

Temposonics®

Magnetostrictive, Absolute, Non-contact
Linear-Position Sensors



E-Series Models EP and EL Analog and Start/Stop Outputs

Document Part Number:
551248 Revision A

Data Sheet



E-Series
Models EP/EL

Model EP position sensor - Full Size Profile Housing
Stroke Length: 50 mm to 3000 mm (2 in. to 120 in.)

Model EL position sensor - Low Height Profile Housing
Stroke Length: 50 mm to 2500 mm (2 in. to 100 in.)

FEATURES

- Linear, Absolute Measurement
- Non-Contact Sensing Technology
- Linearity Deviation Less Than 0.02% F.S.
- Repeatability Within 0.005% F.S.
- Two Outputs Available:
 - Analog (Voltage/Current) Forward or Reverse Acting
 - Start/Stop outputs
- Simple Sensor Parameter Upload (for Start/Stop)
- Stroke Length Ranges:
 - 50 mm to 2500 mm (2 in. to 100 in.)
 - 50 mm to 3000 mm (2 in. to 120 in.)
For Model EP Start/Stop
- EMI Shielded and CE Certified

BENEFITS

- Rugged, Cost Effective, Precise and Durable Non-wear Alternative to Potentiometers
- Simultaneous Multi-position Measurements
- Over Voltage Protection to 36 Vdc and Polarity Protection up to -30 Vdc

APPLICATIONS

- Continuous Operation In Harsh Industrial Conditions

TYPICAL INDUSTRIES

- Factory Automation
- Woodworking and Metal Forming
- Material Handling and Packaging



Sold & Serviced By:

ELECTROMATE

Toll Free Phone (877) SERV098

Toll Free Fax (877) SERV099

www.electromate.com

sales@electromate.com

E-Series Models EP and EL Sensors
Product Overview/Specifications

Product overview

MTS Sensors continues to establish new performance standards for low-cost, fully-industrial, durable position sensors using the widely preferred magnetostrictive technology. This principle for accurate and non-contact measurement of linear-position sensing was developed 30 years ago by MTS and is used with outstanding success in a large variety of industrial applications.

The Temposonics models EP and EL sensors consists of robust aluminum profile-style housings that offer flexible mounting configurations and easy installation. Sensor models EP and EL are ideal for demanding industrial applications where simple, reliable non-contact feedback is essential.

**E-Series
Models EP/EL**

Product specifications

Parameters	Specifications	Parameters	Specifications
OUTPUT		ELECTRONICS	
Measured output variables:	Position	Operating voltage:	+24 Vdc nominal: -15% or +20%* Polarity protection: up to -30 Vdc Over voltage protection: up to 36 Vdc Current drain: Analog: 50 - 140 mA Start/Stop: 50 - 100 mA <i>(Stroke length dependent)</i> Dielectric withstand voltage: 500 Vdc (DC ground to machine ground)
Resolution:	Analog: Infinite (restricted by output ripple) Start/Stop: 0.1, 0.01 and 0.005 mm (controller dependent)	ENVIRONMENTAL	
Linearity deviation:	< ± 0.02% full stroke (minimum ± 60 µm)	Operating conditions:	Operating temperature: -40 °C (-40 °F) to 75 °C (167 °F) Relative humidity: 90% no condensation Ingress protection: IP 67** <i>(when mating connector is correctly fitted)</i>
Repeatability:	< ± 0.005% full stroke (minimum ± 20 µm)	EMC test:	Electromagnetic emission: EN 61000-6-4 Electromagnetic susceptibility: EN 61000-6-2 This sensor meets the requirements of the EC directives and is marked with CE.
Outputs:	Analog (voltage or current) Voltage: 0 to 10 Vdc or 10 to 0 Vdc or Two outputs: 0 to 10 Vdc and/or 10 to 0 Vdc (controller input resistance RL ≥ 5k Ohm) Current: 4 to 20 mA or 20 to 4 mA (Controller input resistance RL ≤ 500 Ohm) Digital-pulse (Start/Stop): RS-422 differential signal Serial parameter upload available for: Measuring range, offset, gradient, status and manufacturer number	Shock rating:	100 g (single hit)/ IEC standard EN 60068-2-27
Stroke length:	Range: 50 mm to 2500 mm (2 in. to 100 in.) or 50 mm to 3000 mm (2 in. to 120 in.) <i>For Model EP Start/Stop output</i>	Vibration rating:	15 g/10 to 2000 Hz, IEC standard EN 60068-2-6 (resonance frequencies excluded)
		WIRING	
		Connection types:	Analog output: 5-pin (M12) male integral connector Start/Stop output: 8-pin (M12) male integral connector
		PROFILE-STYLE SENSOR	
		Electronic head:	Aluminum housing
		Sensor extrusion:	Aluminum (Temposonics profile style)
		Mounting:	Adjustable mounting clamps
		Magnet types:	Captive-sliding magnets, open-ring magnet or block magnet

* UL Recognition requires an approved power supply with energy limitation (UL 61010-1), or Class 2 rating according to the National Electrical Code (USA) / Canadian Electrical Code.

** The IP rating is not part of the UL Recognition.

Outputs

ANALOG (VOLTAGE/CURRENT) OUTPUTS

Analog outputs include voltage (0 to 10 Vdc forward or reverse acting), and current (4 to 20 mA forward or reverse acting). Since the outputs are direct, no signal conditioning electronics are needed when interfacing with controllers or meters (see 'Figure 1').

Analog output voltages ranges:

- 0 to 10 Vdc
- 4 to 20 mA
- 10 to 0 Vdc
- 20 to 4 mA
- 0 to 10 Vdc and 10 to 0 Vdc

DIGITAL START/STOP OUTPUT

Temposonics E-Series Models EP and EL Start/Stop output sensors require a start signal from a controller or interface module to initiate the measurement cycle. The sensor generates a stop signal at the end of the measurement cycle that is used to stop the controller's counter clock.

The elapsed time between the Start and Stop signals is directly proportional to the magnet's position along the active stroke length. The controller can calculate the absolute position of the magnet from the time value and the sensor's unique gradient value (inverse of the speed for the sonic pulse traveling in the sensor's waveguide). (see 'Figure 2').

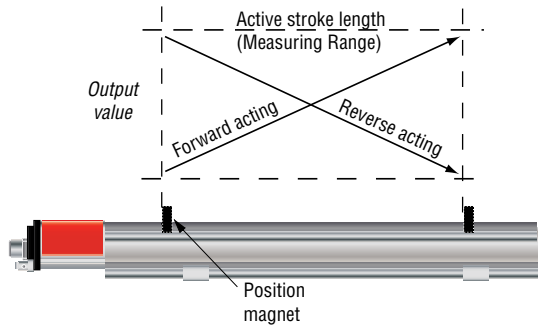

Figure 1. Analog Output signals

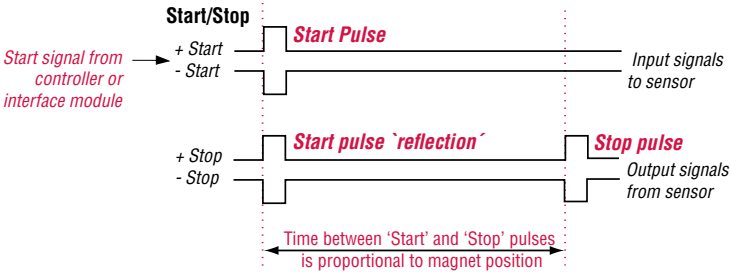

Figure 2. Start/Stop output signals (RS-422 differential pairs)

Dual magnet outputs

MEASUREMENT OPTIONS

E-Series sensors provide options for simultaneous multi-position measurements by using more than one magnet per sensor. When using Start/Stop sensor output the ability to process multiple magnets depends on the capability of the controller or interface module that is used. When using analog type outputs (voltage or current) the sensor is limited to a maximum of two magnets.

For analog output types the options for single-magnet or dual-magnets is specified in the sensor model number when ordered. For single-magnet sensors the sensor's full active stroke length is utilized by the one magnet. For example when using forward-acting outputs, the output is 0% of its value when the magnet is at the null position (start of stroke) and 100% of its value when at the edge of the dead zone (end of stroke), (see 'Figure 3').

However, for dual-magnet sensors the sensor's active stroke length must be shared by the two magnets, and a separation > or = to 75 mm (3 in.) must be maintained between the two magnets (front side of the first magnet to front side of the second magnet). This minimum distance between magnets is needed to maintain proper sensor output. Therefore, for the second magnet the start of stroke (0% output) is set at 75 mm away from the sensor's null position. Likewise, for the first magnet the end of stroke (100% output) is now set 75 mm away from the edge of the dead zone (see 'Figure 3').

The result of using the dual-magnet E-Series options is that the stroke length available for each magnet is 75 mm less (or 3 inches less when specifying stroke length in inches) than the sensor's full active stroke length as indicated in the model number.

When ordering the single-magnet E-Series sensor the minimum stroke length available is 50 mm or 2 inches. However when ordering dual magnet E-Series sensors the minimum stroke length available is 125 mm (i.e. 50 mm minimum, plus 75 mm for the minimum distance between magnets). Likewise, when specifying stroke length in inches the minimum stroke length available is 5 inches (i.e. 2 inch minimum, plus 3 inches for the minimum distance between magnets).

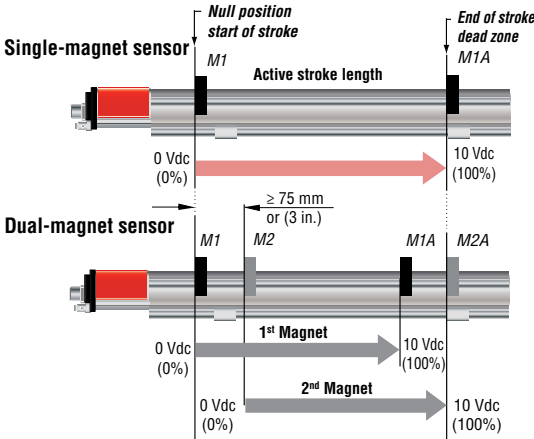

Figure 3. Single and dual magnet measurements

E-Series Models EP/EL

E-Series Models EP and EL Sensors
Sensor Communications and Dimension References

Communication

SENSOR PARAMETER UPLOAD FEATURE

For applications using smart sensor interfaces, the Models EP and EL sensors with Start/Stop output (*Option R3*) comes with the ability to perform sensor parameter uploads. This feature replaces the task of entering sensor data manually, saving time and preventing possible entry errors during start-up or for system maintenance.

The upload feature supports the following sensor parameters:

- Measuring range
- Offset
- Gradient - (Shown as speed of the sonic-strain pulse (m/s) or inverse speed (µs/in.)
- Status
- Manufacturer number

Note: Start/Stop output (option R3)

When the sensor parameter upload feature is not activated the Start/Stop output (Option **R3**) remains fully compatible with the Start/Stop output (Option **R0**) used in the previous generation E-Series sensors.

The sensor's specific parameters can be retrieved by the controller/interface module at any time, via the sensor's Start/Stop signal lines.

The sensor parameter upload feature requires a customer supplied RS-422 interface. The data format is serial, 4800 Baud, 8-bit data length. Please contact the factory for additional parameter upload protocol details.

**E-Series
Models EP/EL**

Sensor dimension references

Drawings are for reference only, contact applications engineering for tolerance specific information.

A robust aluminum extrusion forms the sensor housing containing the sensing element and electronics. The position magnet moves along the top of the profile extrusion housing.

MODEL EP

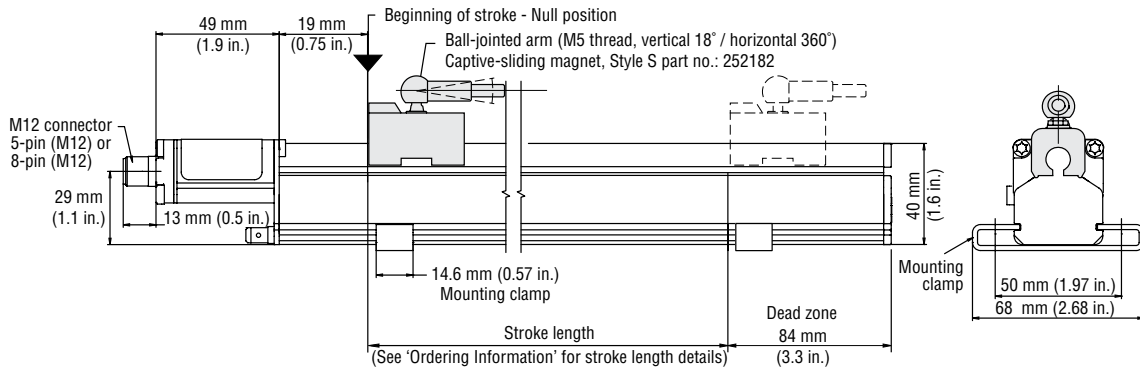

Figure 4. E-Series model EP sensor dimension reference (Shown with Style S captive-sliding magnet)

MODEL EL

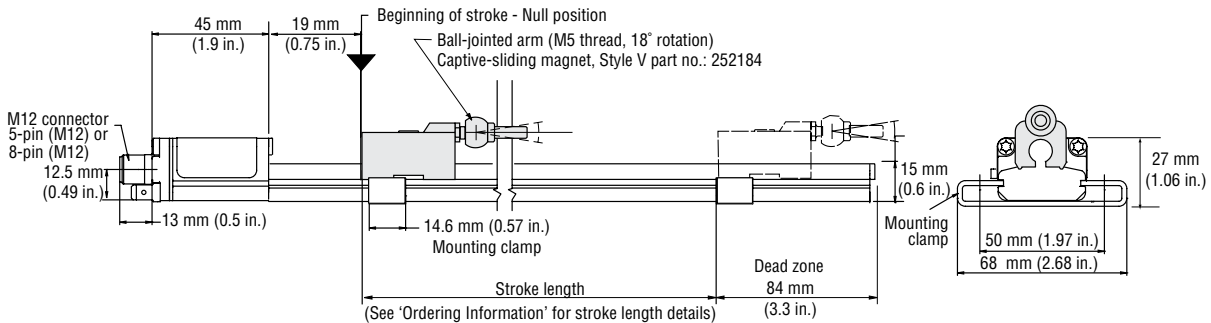

Figure 5. E-Series model EL sensor dimension reference (Shown with Style V captive-sliding magnet)

Sensor dimension references

Drawings are for reference only, contact applications engineering for tolerance specific information.

MODEL EP

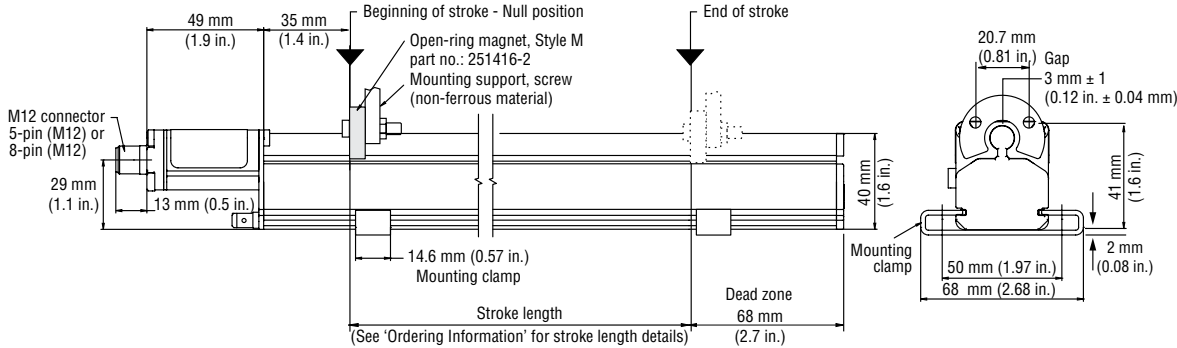

Figure 6. E-Series model EP sensor dimension reference (Shown with Style M open-ring magnet)

MODEL EP

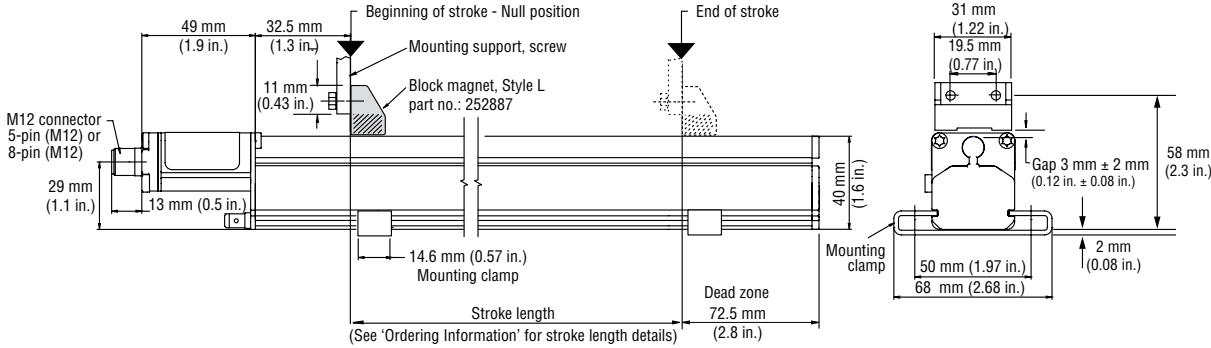



Figure 7. E-Series model EP sensor dimension reference (Shown with Style L block magnet)

Standard magnet selections, mounting and installation (Model EP and EL)

Temposonics Model EP full-size profile-style and EL low height profile-style sensors have side grooves for use with mounting clamps. The mounting clamps can be positioned along the sensor extrusion to best secure the sensor for each particular application.

 Refer to the Accessories section of this catalog for magnet selections and detailed mounting and installation information.

**E-Series
 Models EP/EL**

**E-Series Models EP and EL Sensors
Connections and Wiring**

Connections and wiring (Models EP and EL)

SENSOR INTEGRAL CONNECTOR (D34 AND D84) PINOUT/WIRE COLOR CODES

The E-Series models EP and EL sensors connect directly to a controller or interface module with the standard male, 5-pin or 8-pin integral connector and an extension cable as described in 'Table 1' and 'Table 2'.

Attention:

The sensors aluminum housing has an anodic coating which prevents the sensor's mounting clamps from providing the appropriate grounding. A grounding lug (see 'Figure 78') is provided near the connector end of the sensor for a convenient connection to earth ground. The appropriate grounding of the cable shield is also required at the controller end.

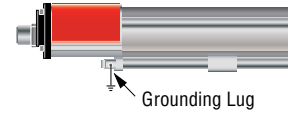

Figure 8. Grounding lug location.

**E-Series
Models EP/EL**



Integral D34 connector (male) as viewed from the end of the sensor

Pin no.	Extension cable wire color	Signal/function analog outputs
1	Brown	+24 Vdc
2	White	Output signal
3	Blue	DC ground (for power return)
4	Black	2nd Output signal (optional)
5	Gray	Ground for signal return

Table 2. Integral D34 sensor connector (mates with cable connectors 370618 and 370619)



Integral D84 connector (male) as viewed from the end of the sensor

Pin no.	Extension cable wire color	Signal/function Start/Stop outputs
1	White	(+) Start
2	Brown	(-) Start
3	Green	(+) Stop
4	Yellow	(-) Stop
5	Gray	No connection
6	Pink	No connection
7	Blue	+24 Vdc
8	Red	DC ground (for power return)

Table 3. Integral D84 sensor connector (mates with cable connectors 370671 and 370672)

E-Series Models EP and EL Sensors, Analog and Start/Stop Outputs Ordering Information

Use the order matrix below to configure your Model EP or EL sensor order number.

E		0					D		1			
1	2	3	4	5	6	7	8	9	10	11	12	13 14 15 <small>(2 or 3 digit-code defined by the output option selected)</small>

- SENSOR MODEL** _____ = **E** **1 - 2**
- EP** = E-Series model EP profile-style sensor (Magnet(s) must be ordered separately)
- EL** = E-Series model EL low-height profile-style sensor (Magnet(s) must be ordered separately)
- HOUSING STYLE** _____ = **0** **3**
- 0** = (Zero) EP and EL sensors do not have housing options or magnet types included in the standard model number. Magnets must be purchased separately by part number. Refer to 'Standard magnet selections (Models EP and EL)' in this document for part numbers.

- STROKE LENGTH** _____ = **4 - 8**
- **M** = Millimeters (Encode in 25, 50, or 100 mm increments as indicated in 'Stroke length notes' below).
- **U** = Inches (Encode in 1, 2, or 4 in. increments as indicated in 'Stroke length notes' below).
(Digit for tenths of inches is always '0').

Stroke Length Notes:

Stroke length ranges:
M = 50 mm to 2500 mm (up to 3000 mm for model EP Start/Stop only)
U = 2 in. to 100 in. (up to 120 in. for model EP Start/Stop only)

The increment size between standard stroke lengths vary as shown below:

Stroke length (mm)	Ordering increment
≤ 500 mm	25 mm
> 500 mm and ≤ 2500 mm	50 mm
> 2500 mm and ≤ 3000 mm (For Model EP Start/Stop only)	100 mm
Stroke length (IN)	Ordering increment
≤ 20 in.	1 in.
> 20 in. and ≤ 100 in.	2 in.
> 100 in. and ≤ 120 in. (For Model EP Start/Stop only)	4 in.

- SENSOR CONNECTION TYPES** _____ = **D** **9 - 11**
- D34** = 5-Pin (M12), male, (Analog output)
- D84** = 8-Pin (M12), male, (Start/Stop output)
- INPUT VOLTAGE** _____ = **1** **12**
- 1** = + 24 Vdc (+20%, -15%), standard
- OUTPUT** _____ = **13 - 15**
- (2 or 3 digit code defined by output option selected).

- VOLTAGE**
- V01** = 0 to 10 Vdc (1 output channel with 1 magnet)
- V11** = 10 to 0 Vdc (1 output channel with 1 magnet)
- V02** = 0 to 10 Vdc (2 output channels with 2 magnets) Refer to 'Dual magnet outputs' for more information.
- V12** = 10 to 0 Vdc (2 output channels with 2 magnets) Refer to 'Dual magnet outputs' for more information.
- V03** = 0 to 10 Vdc and 10 to 0 Vdc (2 output channels with 1 magnet)
- CURRENT**
- A01** = 4 to 20 mA (1 output channel with 1 magnet)
- A11** = 20 to 4 mA (1 output channel with 1 magnet)
- A02** = 4 to 20 mA (2 output channels with 2 magnets) Refer to 'Dual magnet outputs' for more information.
- A12** = 20 to 4 mA (2 output channels with 2 magnets) Refer to 'Dual magnet outputs' for more information.
- START/STOP**
- R3** = Start/Stop with sensor parameters upload function
Start/Stop output (Option **R3**) is fully compatible with the Start/Stop output (Option **R0**) used in the previous generation E-Series sensors.

**E-Series
Models EP/EL**

Sold & Serviced By:



Toll Free Phone (877) SERV098

Toll Free Fax (877) SERV099

www.electromate.com

sales@electromate.com

Temposonics®

Magnetostrictive, Absolute, Non-contact
Linear-Position Sensors



E-Series Models EP and EL CANopen Output Data Sheet

Document Part Number:
551298 Revision C



E-Series
Models EP/EL

Model EP position sensor - Full Size Profile Housing
Stroke Length: 50 mm to 2500 mm (or 2 in. to 100 in.)

Model EL position sensor - Low Height Profile Housing
Stroke Length: 50 mm to 2500 mm (or 2 in. to 100 in.)

FEATURES

- Linear, Absolute Measurement
- Non-Contact Sensing Technology
- Linearity Deviation Less Than 0.02% F.S.
- Repeatability Within 0.005% F.S.
- CANopen Interface, Direct Position and Velocity Outputs
- Single or Dual Magnet Position/Velocity Measurements
- Stroke Length Range:
 - 50 mm to 2500 mm (or 2 in. to 100 in.)
- EMI Shielded and CE Certified

BENEFITS

- Rugged, Cost Effective, Precise and Durable
- Simultaneous Multi-position Measurements for 2 Magnets
- Over Voltage Protection to 36 Vdc and Polarity Protection up to -30 Vdc

APPLICATIONS

- Continuous Operation In Harsh Industrial Conditions

TYPICAL INDUSTRIES

- Factory Automation
- Woodworking and Metal Forming
- Material Handling and Packaging



Sold & Serviced By:

ELECTROMATE

Toll Free Phone (877) SERV098

Toll Free Fax (877) SERV099

www.electromate.com

sales@electromate.com

E-Series Models EP and EL Sensors
Product Overview/Specifications

Product overview

MTS Sensors continues to establish new performance standards for low-cost, fully-industrial, durable position sensors using the widely preferred magnetostrictive technology. This principle for accurate and non-contact measurement of linear-position sensing was developed 30 years ago by MTS and is used with outstanding success in a large variety of industrial applications.

The Temposonics models EP and EL sensors consists of robust aluminum profile-style housings that offer flexible mounting configurations and easy installation. Sensor models EP and EL are ideal for demanding industrial applications where simple, reliable non-contact feedback is essential.

Product specifications

**E-Series
Models EP/EL**

Parameters	Specifications
OUTPUT	
Measured output variables:	Position, Velocity for single or dual magnets
Resolution:	Position: 10 µm, 20 µm Velocity: 1mm/s
Update times:	1.0 ms up to 2400 mm
Linearity deviation:	< ± 0.02% full stroke (minimum ± 60 µm)
Repeatability:	± 0.005% full stroke (minimum ± 10 µm)
Outputs:	Interface: CAN-Fieldbus System according to ISO-DIS 11898 Data protocol: CANopen Encoder Profile DS 406 V3.1 CiA Standard DS 301 v3.0
Baud rate, kBit/s:	800 500 250 125
Cable length, m:	< 25 < 50 < 100 < 250 < 500
Stroke length:	Range: 50 mm to 2500 mm (2 in. to 100 in.)

Parameters	Specifications
ELECTRONICS	
Operating voltage:	+24 Vdc nominal: -15% or +20%* Polarity protection: ≥ -30 Vdc Over voltage protection: ≤ 36 Vdc Current drain: 90 mA Typical Dielectric withstand voltage: 500 Vdc (DC ground to machine ground)
ENVIRONMENTAL	
Operating conditions:	Operating temperature: -40 °C (-40 °F) to 75 °C (167 °F) Relative humidity: 90% no condensation Ingress protection: IP 67** <i>(when appropriate mating connector is correctly fitted)</i>
EMC test:	Electromagnetic emission: EN 61000-6-4 <i>(for use in industrial environment)</i> Electromagnetic immunity: EN 61000-6-2 <i>(The sensor meets the requirements of the EC directives and is marked with CE)</i>
Shock rating:	100 g (single hit)/ IEC standard EN 60068-2-27
Vibration rating:	15 g/10 to 2000 Hz, IEC standard EN 60068-2-6 (resonance frequencies excluded)

WIRING	
Connection type:	5-pin (M12) male integral connector

PROFILE-STYLE SENSOR	
Electronic head:	Aluminum housing
Sensor extrusion:	Aluminum (Temposonics profile style)
Mounting:	Adjustable mounting clamps
Magnet types:	Captive-sliding magnet, block magnet or open-ring magnet <i>(for Model EP)</i>

* UL Recognition requires an approved power supply with energy limitation (UL 61010-1), or Class 2 rating according to the National Electrical Code (USA) / Canadian Electrical Code.

** The IP rating is not part of the UL Recognition.

CANopen communication and functionality

Temposonics linear-position sensors fulfill all requirements of CANbus (ISO 11898). The sensor's electronics convert the position measurements into bus oriented outputs and transfer this data directly to the controller. The CANbus interface is appropriate for serial data transfer up to 1 Mbps maximum. Sensor integrated software supports bus profile CANopen. This communication protocol allows for a comprehensive customized configuration of the sensor-bus system.

TEMPOSONICS E-SERIES SENSORS WITH CANOPEN INTERFACE

E-Series sensors with CANopen protocol are based as bus-nodes on the OSI reference model and are available with application data for single or dual-magnet measurements:

APPLICATION DATA:

- Position measurement
- Velocity measurement
- Setpoints
- Status

CANopen corresponds to encoder profile 'DS-406 V3.1 (CIA Draft standard DS-301 V3.0)'. The CANopen functionality is described below in the following communication objects.

CANopen CONFIGURATION TOOL

The EDS (Electronic Data Sheet) download is available at www.mtssensors.com for configuration.

SERVICE DATA OBJECT (SDO)

The SDO is mainly used for sensor configuration. SDO messages are used for read and write access to all entries in the object directory.

Selectable parameters are as follows:

- Operational range setup for magnets 1 and 2
- Zero adjustmet preset for magnets 1 and 2
- 4 set points for each magnet

PROCESS DATA OBJECT (PDO)

The PDO provides data transfer of sensor measurements in up to 8-byte data blocks. The sensor uses PDO's to relay parameters for each magnet in one or two PDO's

DATA FORMATS:

- Position
- Velocity
- Limit status
- Limit status of operational range

PDO TRANSMISSION TYPES

- Asynchronous (cycle time of 1 to 65.535 ms) or synchronous
- Synchronization Object (SYNC) messages are sent from the controller to the sensor, the sensor then transmits measurement values

SYNC OBJECT

Is responsible for synchronized bus communication

EMERGENCY OBJECT

Emergency messages are transmitted as:

- Sensor signal breakdown
- Communication fault

E-Series Models EP and EL Sensors
Dual Magnet Outputs / Sensor Dimension References

Dual magnet outputs

MEASUREMENT OPTIONS

E-Series sensors provide options for simultaneous multi-position measurements by using more than one magnet per sensor. When using the CANopen output, the E-Series sensor is limited to a maximum of two magnets.

For single-magnet sensors the sensor's full active stroke length is utilized by the one magnet. For example when using forward-acting outputs, the output is 0% of its value when the magnet is at the null position (start of stroke) and 100% of its value when at the edge of the dead zone (end of stroke), (see 'Figure 1').

However, for dual-magnet sensors the sensor's active stroke length must be shared by the two magnets, and a separation \geq 75 mm (3 in.) must be maintained between the two magnets (front side of the first magnet to front side of the second magnet). This minimum distance between magnets is needed to maintain proper sensor output. Therefore, for the second magnet the start of stroke (0% output) is set at 75 mm away from the sensor's null position. Likewise, for the first magnet the end of stroke (100% output) is now set 75 mm away from the edge of the dead zone (see 'Figure 1').

The result of using the dual-magnet E-Series options is that the stroke length available for each magnet is 75 mm less (or 3 inches less when specifying stroke length in inches) than the sensor's full active stroke length as indicated in the model number.

When ordering the single-magnet E-Series sensor the minimum stroke length available is 50 mm or 2 inches.

However, when ordering dual magnet E-Series sensors the minimum stroke length available is 125 mm (i.e. 50 mm minimum, plus 75 mm for the minimum distance between magnets). Likewise, when specifying stroke length in inches the minimum stroke length available is 5 inches (i.e. 2 inch minimum, plus 3 inches for the minimum distance between magnets).

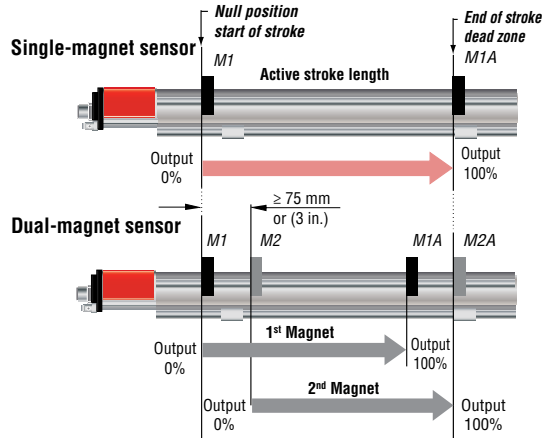

Sensor dimension references

Drawings are for reference only, contact applications engineering for tolerance specific information.

A robust aluminum extrusion forms the sensor housing containing the sensing element and electronics. The position magnet moves along the top of the profile extrusion housing.

MODEL EP

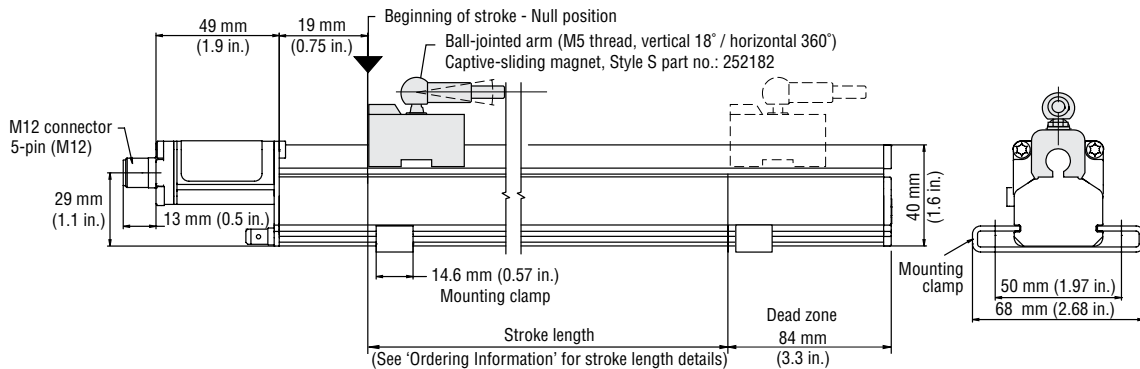

Figure 3. Figure 2. E-Series model EP sensor dimension reference (Shown with Style S captive-sliding magnet)

MODEL EL

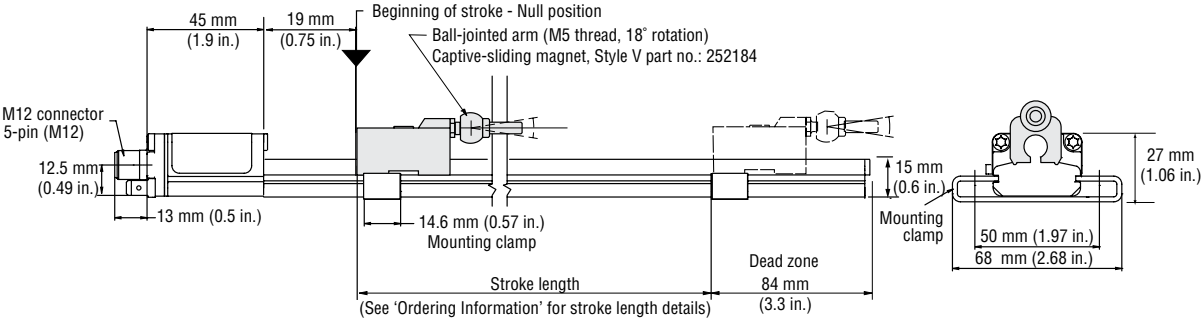

Figure 3. E-Series model EL sensor dimension reference (Shown with Style V captive-sliding magnet)

MODEL EP

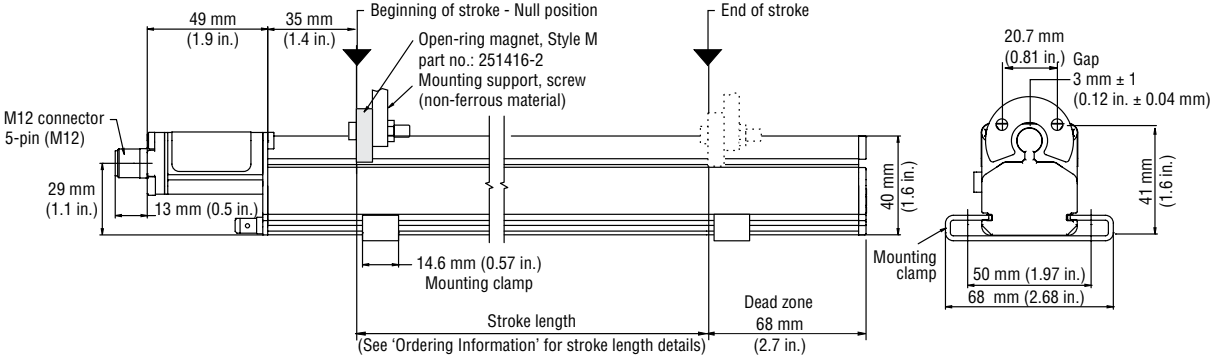

Figure 3. Figure 4. E-Series model EP sensor dimension reference (Shown with Style M open-ring magnet)

MODEL EP

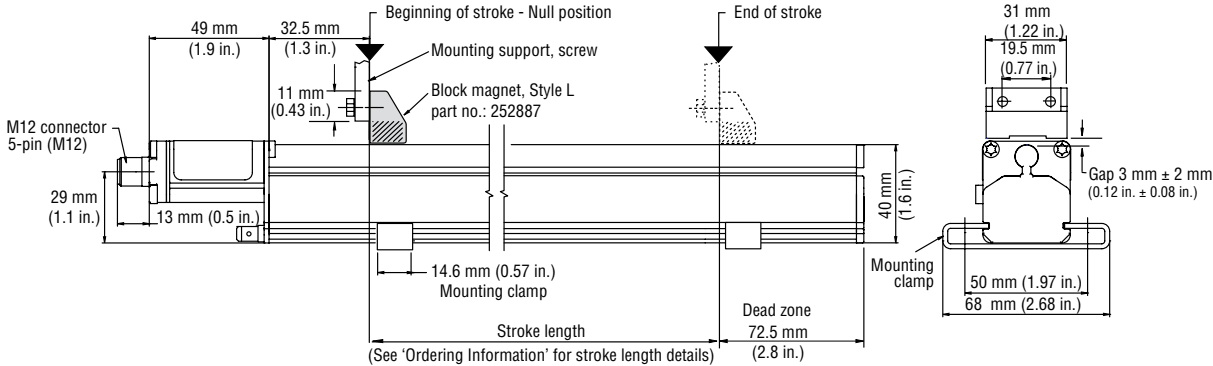



Figure 5. E-Series model EP sensor dimension reference (Shown with Style L block magnet)

Standard magnet selections, mounting and installation (Model EP and EL)

Temposonics Model EP full-size profile-style and EL low height profile-style sensors have side grooves for use with mounting clamps. The mounting clamps can be positioned along the sensor extrusion to best secure the sensor for each particular application.

 Refer to the Accessories section of this catalog for magnet selections and detailed mounting and installation information.

**E-Series
Models EP/EL**

E-Series Models EP and EL Sensors
Connections and wiring

Connections and wiring (Model EP and EL)

SENSOR INTEGRAL CONNECTOR (D34) PINOUT/WIRE COLOR CODES

The E-Series models EP and EL sensors connect directly to a controller or interface module with a male, 5-pin integral connector and an extension cable as described in 'Table 1'.

**E-Series
Models EP/EL**

Attention:

The sensors aluminum housing has an anodic coating which prevents the sensor's mounting clamps from providing the appropriate grounding. A grounding lug (see 'Figure 6') is provided near the connector end of the sensor for a convenient connection to earth ground. The appropriate grounding of the cable shield is also required at the controller end.

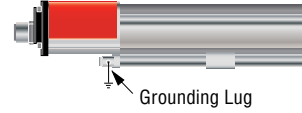

Figure 3. Figure 6. Grounding lug location.



Integral D34 connector (male) as viewed from the end of the sensor

Pin no.	Signal/function CANopen outputs
1	Shield
2	+24 Vdc
3	DC ground (for power return)
4	CAN (+)
5	CAN (-)

Integral D34 sensor connector

E-Series Models EP and EL Sensors, CANopen Output Ordering Information

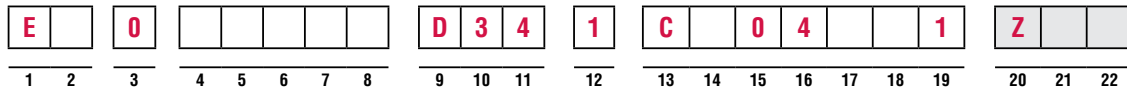

(Use the order matrix above to configure your Model EP or EL sensor order number)

- SENSOR MODEL** _____ = E 1 - 2
- EP** = E-Series model EP profile-style sensor (Magnet(s) must be ordered separately)
- EL** = E-Series model EL low-height profile-style sensor (Magnet(s) must be ordered separately)
- HOUSING STYLE** _____ = 0 3
- 0** = (Zero) EP and EL sensors do not have housing options or magnet types included in the standard model number. Magnets must be purchased separately by part number. Refer to 'Standard magnet selections (Models EP and EL)' in this document for part numbers.

- STROKE LENGTH** _____ = 4 - 8
- **M** = Millimeters (Encode in 25 or 50 mm increments as indicated in 'Stroke length notes' below).
- **U** = Inches (Encode in 1 or 2 in. increments as indicated in 'Stroke length notes' below). (Digit for tenths of inches is always '0').

Stroke Length Notes:

Stroke length ranges:
M = 50 mm to 2500 mm
U = 2 in. to 100 in.

The increment size between standard stroke lengths vary as shown below:

Stroke length (mm)	Ordering increment
≤ 500 mm	25 mm
> 500 mm and ≤ 2500 mm	50 mm
Stroke length (IN)	Ordering increment
≤ 20 in.	1 in.
> 20 in. and ≤ 100 in.	2 in.

- SENSOR CONNECTION TYPES** _____ = D 3 4 9 - 11
- D34** = 5-Pin (M12), male, (CANopen output)
- INPUT VOLTAGE** _____ = 1 12
- 1** = +24 Vdc (+20%, -15%), standard
- OUTPUT** _____ = C 0 4 1 13-19
- C** _____ = CANopen output - Enter the 6-digit output code (1-6) defined by the selections below:
- [1] [2] [3] [4] [5] [6]

[1] [2] [3] Protocol	[4] Baud rate	[5] Resolution	[6] type
304 = CANopen 1 or 2 magnets	1 = 1000 kBit/s 2 = 500 kBit/s	4 = 10 μm 5 = 20 μm	1 = Standard
404 = CANopen 1 or 2 magnets with integrated bus terminator resistor (120 Ohms)	3 = 250 kBit/s 4 = 125 kBit/s		

- NUMBER OF MAGNETS (20-22) FOR MULTI-POSITION MEASUREMENT ONLY** _____ = Z 20-22
- Z** + Enter a 2-digit code
- Z** - - = Enter 02 for 2 magnets

 E-Series
Models EP/EL

Temposonics®

Magnetostrictive, Absolute, Non-contact
Linear-Position Sensors



E-Series Models EP and EL Synchronous Serial Interface (SSI) Output Data Sheet

Document Part Number:
551299 Revision C



E-Series
Models EP/EL

Model EP position sensor - Full Size Profile Housing
Stroke Length: 50 mm to 2500 mm (or 2 in. to 100 in.)

Model EL position sensor - Low Height Profile Housing
Stroke Length: 50 mm to 2500 mm (or 2 in. to 100 in.)

FEATURES

- Linear, Absolute Measurement
- Non-Contact Sensing Technology
- Linearity Deviation Less Than 0.02% F.S.
- Repeatability Within 0.005% F.S.
- SSI Provides a High-Speed Noise Immune and Cost Effective Sensor Interface
- Stroke Length Range:
 - 50 mm to 2500 mm (or 2 in. to 100 in.)
- EMI Shielded and CE Certified

BENEFITS

- Resolution Down to 20 μm
- Rugged, Cost Effective, Precise and Durable
- Direct 24/25 Bit SSI Output, Gray/Binary Formats
- Over Voltage Protection to 36 Vdc and Polarity Protection up to -30 Vdc

APPLICATIONS

- Continuous Operation In Harsh Industrial Conditions

TYPICAL INDUSTRIES

- Factory Automation
- Woodworking and Metal Forming
- Material Handling and Packaging



Sold & Serviced By:

ELECTROMATE

Toll Free Phone (877) SERV098

Toll Free Fax (877) SERV099

www.electromate.com

sales@electromate.com

E-Series Models EP and EL Sensors
Product Overview/Specifications

Product overview

MTS Sensors continues to establish new performance standards for low-cost, fully-industrial, durable position sensors using the widely preferred magnetostrictive technology. This principle for accurate and non-contact measurement of linear-position sensing was developed 30 years ago by MTS and is used with outstanding success in a large variety of industrial applications.

The Temposonics models EP and EL sensors consists of robust aluminum profile-style housings that offer flexible mounting configurations and easy installation. Sensor models EP and EL are ideal for demanding industrial applications where simple, reliable non-contact feedback is essential.

Product specifications

**E-Series
Models EP/EL**

Parameters	Specifications			
OUTPUT				
Measured output variables:	Position			
Resolution:	20 µm, 50 µm, 100 µm			
Update rate:				
Measuring length:	300	750	1000	2000 mm
Measurements/Sec:	3.7	3.0	2.3	1.2 kHz
Linearity deviation:	< ± 0.02% full stroke (minimum ± 60 µm)			
Repeatability:	± 0.005% full stroke (minimum ± 20 µm)			
Outputs:	Interface: Synchronous Serial Interface (SSI) (RS-422 type differential signal pairs) Data format: Binary or gray Data lengths: 24 or 25 bit Data speed (Baud rate): 70 kBd to 1 MBd, depending on cable length (see below):			
Length:	<3	<50	<100	<200 <400 m
Baud rate:	1.0 MBd	<400 kBd	<300 kBd	<200 kBd <100 kBd
Stroke length:	Range: 50 mm to 2500 mm (2 in. to 100 in.)			

Parameters	Specifications
ELECTRONICS	
Operating voltage:	+24 Vdc nominal: -15% or +20%* Polarity protection: ≥ -30 Vdc Over voltage protection: ≤ 36 Vdc Current drain: 90 mA Dielectric withstand voltage: 500 Vdc (DC ground to machine ground)
ENVIRONMENTAL	
Operating conditions:	Operating temperature: -40 °C (-40 °F) to 75 °C (167 °F) Relative humidity: 90% no condensation Ingress protection: IP 67** (when appropriate mating connector is correctly fitted)
EMC test:	Electromagnetic emission: EN 61000-6-3 Electromagnetic immunity: EN 61000-6-2 <i>The sensor meets the requirements of the EC directives and is marked with CE.</i>
Shock rating:	100 g (single hit)/ IEC standard EN 60068-2-27
Vibration rating:	15 g/10 to 2000 Hz, IEC standard EN 60068-2-6 (resonance frequencies excluded)

WIRING	
Connection type:	8-pin (M12) male integral connector

PROFILE-STYLE SENSOR	
Electronic head:	Aluminum housing
Sensor extrusion:	Aluminum (Temposonics profile style)
Mounting:	Adjustable mounting clamps
Magnet types:	Captive-sliding magnet, block magnet or Open-ring magnet (for Model EP)

* UL Recognition requires an approved power supply with energy limitation (UL 61010-1), or Class 2 rating according to the National Electrical Code (USA) / Canadian Electrical Code.

** The IP rating is not part of the UL Recognition.

Synchronous Serial Interface (SSI)

Temposonics E-Series sensors with SSI fulfill all requirements of the SSI standard for an absolute encoder. The position value is encoded in a 24/25 code format and is transmitted at high speed in SSI standard format to the control device. The main feature of SSI is the synchronized data transfer. Data transfer synchronization simplifies the closed-loop control system. A clock pulse train from a controller is used to gate out sensor data. One bit of position data is transmitted to the controller for each clock pulse received by the sensor (see 'Figures 1 and 2'). The absolute position data is continually updated by the sensor and converted by the shift register into serial information. (see 'Figure 3').

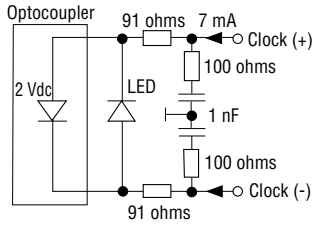
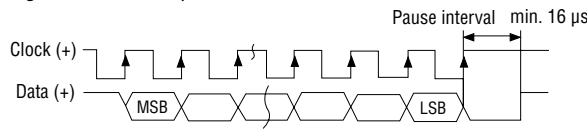

Figure 1. Sensor input



Timing Diagram

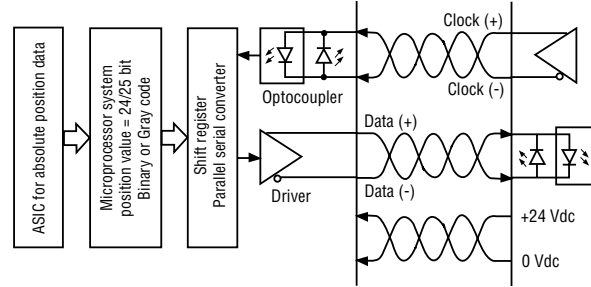

Figure 3. Logic Diagram

E-Series
Models EP/EL

Sensor dimension references

Drawings are for reference only, contact applications engineering for tolerance specific information.

A robust aluminum extrusion forms the sensor housing containing the sensing element and electronics. The position magnet moves along the top of the profile extrusion housing.

MODEL EP

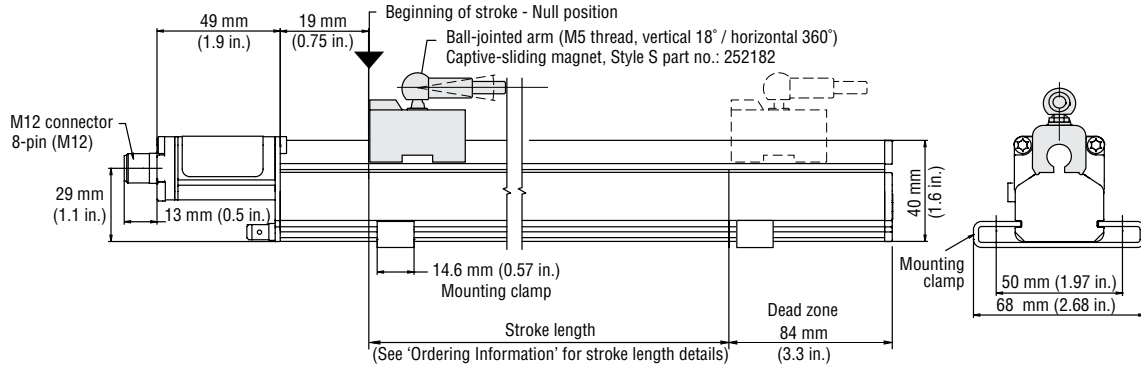
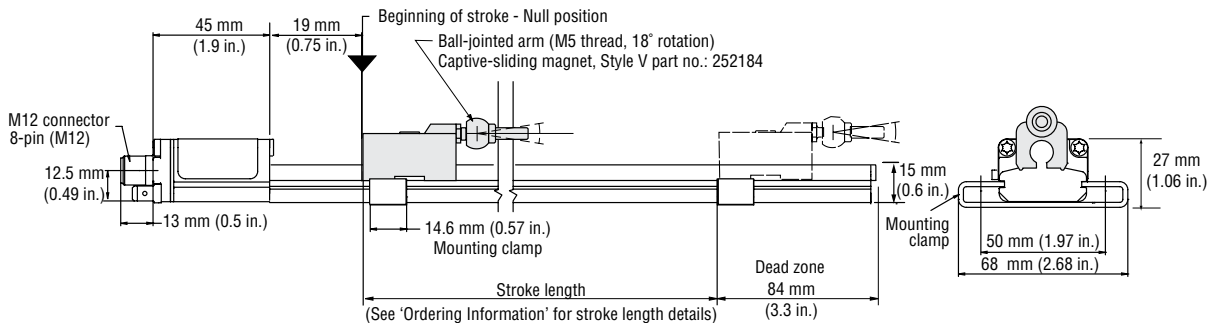

Figure 3. Figure 4. E-Series model EP sensor dimension reference (Shown with Style S captive-sliding magnet)

MODEL EL



E-Series Models EP and EL Sensors
Sensor Dimension References

Figure 5. E-Series model EL sensor dimension reference (Shown with Style V captive-sliding magnet)

Sensor dimension references

MODEL EP

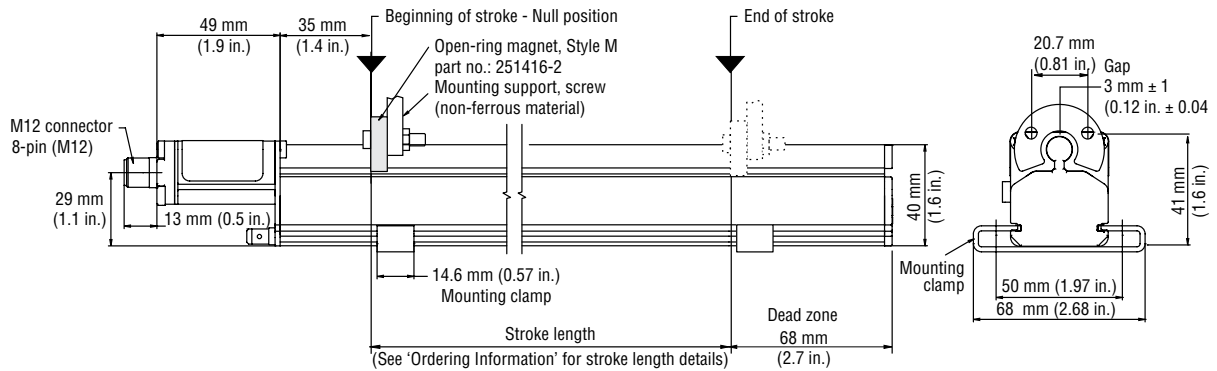
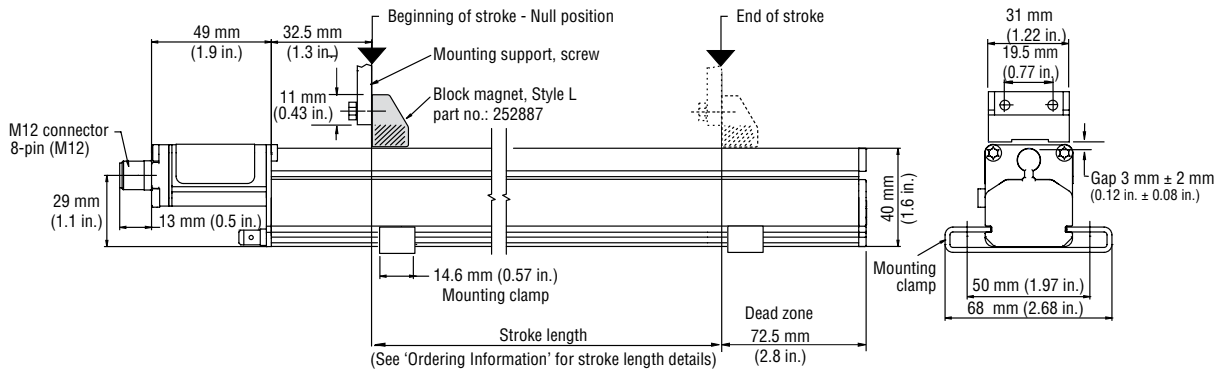



Figure 3. Figure 4. E-Series model EP sensor dimension reference (Shown with Style M open-ring magnet)

MODEL EP



Standard magnet selections, mounting and installation (Model EP and EL)

Temposonics Model EP full-size profile-style and EL low height profile-style sensors have side grooves for use with mounting clamps. The mounting clamps can be positioned along the sensor extrusion to best secure the sensor for each particular application.

 Refer to the Accessories section of this catalog for magnet selections and detailed mounting and installation information.

**E-Series
Models EP/EL**

Connections and wiring (Model EP and EL)

SENSOR INTEGRAL CONNECTOR (D84) PINOUT/WIRE COLOR CODES

The E-Series models EP and EL sensors connect directly to a controller or interface module with a male, 8-pin integral connector and an extension cable as described in 'Table 1'.

Attention:
The sensors aluminum housing has an anodic coating which prevents the sensor's mounting clamps from providing the appropriate grounding. A grounding lug (see 'Figure 6') is provided near the connector end of the sensor for a convenient connection to earth ground. The appropriate grounding of the cable shield is also required at the controller end.



Integral D84 connector (male) as viewed from the end of the sensor

Pin no.	Extension cable wire color	Signal/function Start/Stop outputs
1	White	Clock (+)
2	Brown	Clock (-)
3	Green	Data (+)
4	Yellow	Data (-)
5	Gray	No connection
6	Pink	No connection
7	Blue	+24 Vdc
8	Red	DC ground (for power return)

Table 1. Integral D84 sensor connector

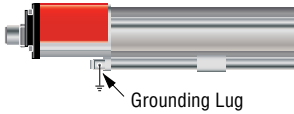
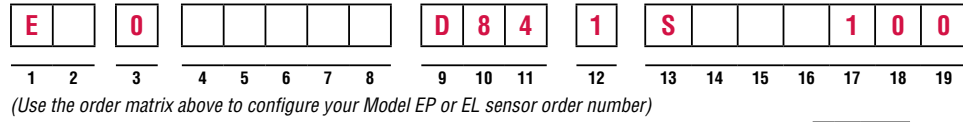

Figure 3. Figure 6. Grounding lug location.

E-Series Models EP/EL

E-Series Models EP and EL Sensors, SSI Output
Ordering Information



E-Series Models EP/EL

SENSOR MODEL _____ = **E** **1 - 2**
EP = E-Series model EP profile-style sensor (Magnet(s) must be ordered separately)
EL = E-Series model EL low-height profile-style sensor (Magnet(s) must be ordered separately)

HOUSING STYLE _____ = **0** **3**
0 = (Zero) EP and EL sensors do not have housing options or magnet types included in the standard model number. Magnets must be purchased separately by part number. Refer to 'Standard magnet selections (Models EP and EL)' in this document for part numbers.

STROKE LENGTH _____ = **4 - 8**
M = Millimeters (Encode in 25 or 50 mm increments as indicated in 'Stroke length notes' below).
U = Inches (Encode in 1 or 2 in. increments as indicated in 'Stroke length notes' below). (Digit for tenths of inches is always '0').

Stroke Length Notes:

Stroke length ranges:
M = 50 mm to 2500 mm
U = 2 in. to 100 in.

The increment size between standard stroke lengths vary as shown below:

Stroke length (mm)	Ordering increment
≤ 500 mm	25 mm
> 500 mm and ≤ 2500 mm	50 mm
Stroke length (IN)	Ordering increment
≤ 20 in.	1 in.
> 20 in. and ≤ 100 in.	2 in.

SENSOR CONNECTION TYPES _____ = **D** **8** **4** **9 - 11**
D84 = 8-Pin (M12), male, (SSI output)

INPUT VOLTAGE _____ = **1** **12**
1 = +24 Vdc (+20%, -15%), standard

OUTPUT _____ = **S** **13-19**
S _____ = SSI output - Enter the 6-digit output code (1-6) defined by the selections below:
 [1] [2] [3] [4] [5] [6]

[14] Data length	[15] Output format	[16] Resolution	[17] Performance
1 = 25 bits	B = Binary	3 = 0.05 mm	1 = Standard
2 = 24 bits	G = Gray code	4 = 0.1 mm	
		5 = 0.02 mm	

[18] [19] Signal options (scale orientation)
00 = Measuring direction forward, async

Temposonics®

Magnetostrictive, Absolute, Non-contact
Linear-Position Sensors



E-Series Model ER Analog and Start/Stop Outputs

Document Part Number:
550996 Revision F

Data Sheet



Model ER position sensor-
Stroke Length: 50 mm to 1500 mm (2 in. to 60 in.)

E-Series
Model ER

FEATURES

- Linear, Absolute Measurement
- Non-Contact Sensing Technology
- Linearity Deviation Less Than 0.02% F.S.
- Repeatability Within 0.005% F.S.
- Two Outputs Available:
 - Analog (Voltage/Current) Forward or Reverse Acting
 - Start/Stop Outputs
- Simple Sensor Parameter Upload (for Start/Stop)
- Stroke Length Range: 50 mm to 1500 mm (2 in. to 60 in.)
- Internal Electronics are Sealed for IP67 Ingress Protection
- EMI Shielded and CE Certified

BENEFITS

- Rugged, Cost Effective, Precise and Durable Non-wear Alternative to Linear Potentiometers
- Extendable and Retractable Dual Rod Ends
- The Magnet is Contained and Protected Inside The Sensor Housing
- Over Voltage Protection to 36 Vdc and Polarity Protection up to -30 Vdc

APPLICATIONS

- Continuous Operation In Harsh Industrial Conditions

TYPICAL INDUSTRIES

- Factory Automation
- Woodworking and Metal Forming
- Material Handling and Packaging



Sold & Serviced By:

ELECTROMATE

Toll Free Phone (877) SERV098

Toll Free Fax (877) SERV099

www.electromate.com

sales@electromate.com

E-Series Model ER Sensor, Analog and Start/Stop Outputs

Product Overview and Specifications

Product overview

MTS Sensors continues to establish new performance standards for low-cost, fully-industrial, durable position sensors using the widely preferred magnetostrictive technology. This principle for accurate and non-contact measurement of linear-position sensing was developed 30 years ago by MTS and is used with outstanding success in a large variety of industrial applications. The innovative Temposonics model ER sensor brings proven benefits of magnetostrictive feedback to the versatile rod-and-cylinder sensor package.

It is ideal for demanding industrial applications where high performance non-contact feedback is essential for maximum productivity and overall reliability. The model ER sensor's rod-and-cylinder design has a rod that can extend from the sensor housing. As the rod is extended and retracted, the sensing magnet remains completely contained and protected at all times, ensuring reliable sensor performance in the toughest industrial environments.

Product specifications

E-Series
Model ER

Parameters	Specifications	Parameters	Specifications
OUTPUT		ENVIRONMENTAL	
Measured output variables:	Position	Operating conditions:	Operating temperature: -40 °C (-40 °F) to 75 °C (167 °F) Relative humidity: 90% no condensation Ingress protection: IP 67** <i>(when mating connector is correctly fitted)</i>
Resolution:	Analog: Infinite (restricted by output ripple) Start/Stop: 0.1, 0.01 and 0.005 mm (controller dependent)	EMC test:	Electromagnetic emission: EN 61000-6-4 Electromagnetic susceptibility: EN 61000-6-2. This sensor meets the requirements of the EC directives and is marked with CE.
Linearity deviation:	< ± 0.02% full stroke (minimum ± 60 µm)	Shock rating:	100 g (single hit)/ IEC standard EN 60068-2-27
Repeatability:	< ± 0.005% full stroke (minimum ± 20 µm)	Vibration rating:	10 g/10 to 2000 Hz, IEC standard EN 60068-2-6 (resonance frequencies excluded)
Outputs:	Analog (voltage or current) Voltage: 0 to 10 Vdc and 10 to 0 Vdc or Two outputs: 0 to 10 Vdc and 10 to 0 Vdc (controller input resistance RL ≥ 5k Ohm) Current: 4 to 20 mA or 20 to 4 mA (Controller input resistance RL ≤ 500 Ohm) Digital-pulse (Start/Stop): RS-422 differential signal Serial parameter upload available for: Measuring range, offset, gradient, status and manufacturer number	WIRING	Connection types: Analog output: 5-pin (M12) male integral connector Start/Stop output: 8-pin (M12) male integral connector
Stroke length:	Range: 50 mm to 1500 mm (2 in. to 60 in.)	ROD-AND-CYLINDER STYLE SENSOR	Sensor rod: Aluminum Sensor housing: Aluminum Mounting options: Adjustable mounting clamps or dual rod ends
ELECTRONICS			
Operating voltage:	+24 Vdc nominal: -15% or +20%* Polarity protection: up to -30 Vdc Over voltage protection: up to 36 Vdc Current drain: Analog: 50 - 140 mA Start/Stop: 50 - 100 mA <i>(Stroke length dependent)</i> Dielectric withstand voltage: 500 Vdc (DC ground to machine ground)		

* UL Recognition requires an approved power supply with energy limitation (UL 61010-1), or Class 2 rating according to the National Electrical Code (USA) / Canadian Electrical Code.

** The IP rating is not part of the UL Recognition.

Outputs

ANALOG (VOLTAGE/CURRENT) OUTPUTS

Analog outputs include voltage (0 to 10 Vdc forward or reverse acting), and current (4 to 20 mA forward or reverse acting). Since the outputs are direct, no signal conditioning electronics are needed when interfacing with controllers or meters (see 'Figure 1').

Analog output voltages ranges:

- 0 to 10 Vdc
- 10 to 0 Vdc
- 0 to 10 Vdc and 10 to 0 Vdc
- 4 to 20 mA
- 20 to 4 mA

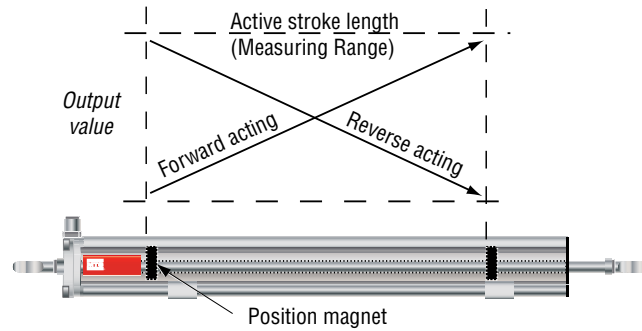

Figure 1. Analog Output signals

DIGITAL START/STOP OUTPUT

The Temposonics E-Series Model ER Start/Stop output sensors require a start signal from a controller or interface module to initiate the measurement cycle. The sensor generates a stop signal at the end of the measurement cycle that is used to stop the controller's counter clock.

The elapsed time between the Start and Stop signals is directly proportional to the magnet's position along the active stroke length. The controller can calculate the absolute position of the magnet from the time value and the sensor's unique gradient value (inverse of the speed for the sonic pulse traveling in the sensor's waveguide). (see 'Figure 2').

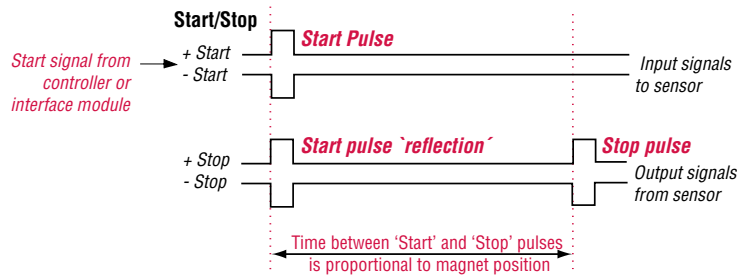

Figure 2. Start/Stop output signals (RS-422 differential pairs)

E-Series
Model ER

Communication

SENSOR PARAMETER UPLOAD FEATURE

For applications using smart sensor interfaces, the Model ER sensor with Start/Stop output (Option R3) comes with the ability to perform sensor parameter uploads. This feature replaces the task of entering sensor data manually, saving time and preventing possible entry errors during start-up or for system maintenance.

Note: Start/Stop output (option R3)

When the sensor parameter upload feature is not activated the Start/Stop output (Option R3) remains fully compatible with the Start/Stop output (Option R0) used in the previous generation E-Series sensor family.

The upload feature supports the following sensor parameters:

- Measuring range
- Offset
- Gradient - (Shown as speed of the sonic-strain pulse (m/s) or inverse speed ($\mu\text{s}/\text{in.}$))
- Status
- Manufacturer number

The sensor's specific parameters can be retrieved by the controller and interface module at any time, via the sensor's Start/Stop signal lines.

The sensor parameter upload feature requires a customer supplied RS-422 interface. The data format is serial, 4800 Baud, 8-bit data length. Please contact the factory for additional parameter upload protocol details.

E-Series Model ER Sensor, Analog and Start/Stop Outputs Sensor Dimensions, Connections and Wiring

Model ER rod-and-cylinder sensor dimension references

Drawings are for reference only, contact applications engineering for tolerance specific information.

A robust aluminum extrusion forms the sensor housing containing the sensor rod, magnet, sensing element and electronics. The permanent magnet is mounted on a sliding carrier attached to the end of the rod. As the rod moves in and out, the magnet travels above the sensing element inside the sensor housing.

MODEL ER ROD-AND-CYLINDER SENSOR

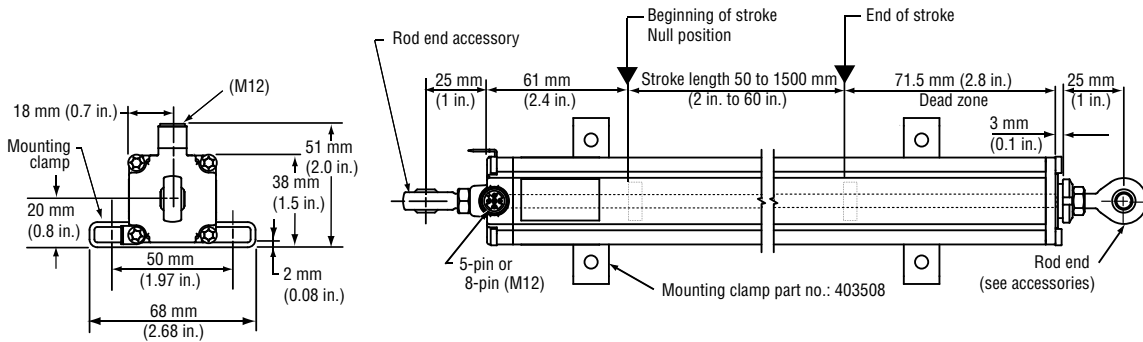

Figure 3. E-Series model ER rod-and cylinder sensor dimension reference

Connections and wiring (Model ER)

SENSOR INTEGRAL CONNECTOR (D34 AND D84) PINOUT/WIRE COLOR CODES

The E-Series model ER sensor connects directly to a controller or interface module with the standard male, 5-pin or 8-pin integral connector and an extension cable as described in 'Table 1' and 'Table 2' below.

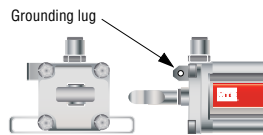

Figure 4. Grounding lug location.

Attention:

The sensors aluminum housing has an anodic coating which prevents the sensor's mounting clamps from providing the appropriate grounding. A grounding lug (see 'Figure 4') is provided near the connector end of the sensor for a convenient connection to earth ground. The appropriate grounding of the cable shield is also required at the controller end.



Integral D34 connector (male) as viewed from the end of the sensor

Pin no.	Extension Cable Wire color	Signal/Function Analog outputs
1	Brown	+24 Vdc
2	White	Output signal
3	Blue	DC ground (for power return)
4	Black	2nd Output signal (optional)
5	Gray	Ground for signal return

Table 1. Integral D34 sensor connector
(mates with cable connectors 370618 and 370619)



Integral D84 connector (male) as viewed from the end of the sensor

Pin no.	Extension cable wire color	Signal/function Start/Stop outputs
1	White	(+) Start
2	Brown	(-) Start
3	Green	(+) Stop
4	Yellow	(-) Stop
5	Gray	No connection
6	Pink	No connection
7	Blue	+24 Vdc
8	Red	DC ground (for power return)

Table 2. Integral D84 sensor connector
(mates with cable connectors 370671 and 370672)

E-Series Model ER Sensor, Analog and Start/Stop Outputs Ordering Information

Use the order matrix below to configure your Model ER sensor order number.

E	R													
1	2	3	4	5	6	7	8	9	10	11	12	13	14	15

2 or 3 digit code

- SENSOR MODEL** _____ = **E** **R** **1 - 2**
- ER** = E-Series model ER position sensor
- HOUSING STYLE** _____ = **3**
- S** = Inside thread 1/4 - 28 at end of rod
- M** = Inside thread M6 at end of rod
- STROKE LENGTH** _____ = **4 - 8**
- _____ **M** = Millimeters (Encode in 25 or 50 mm increments) as indicated in 'Stroke length notes' below.
- _____ **U** = Inches (Encode in 1 or 2 in. increments) as indicated in 'Stroke length notes' below.
(Digit for tenths of inches is always '0')

Stroke length Notes:	
Stroke length ranges:	
M = 50 to 1500 mm (Preferred stroke lengths are: 75,100, 150, 200, 300, 400, 500, 600, 750, 1000 and 1250 mm)	
U = 2 to 60 in. (Preferred stroke lengths are: 3, 6, 9,12, 15, 18, 21, 24, 30, 36, 42, 48 and 54 in.)	
The increment size between standard stroke lengths vary as shown below:	
Stroke length (mm)	Ordering increment
≤ 500 mm	25 mm
> 500 mm and ≤ 1500 mm	50 mm
Stroke length (IN)	Ordering increment
≤ 22 in.	1 in.
> 22 in. and ≤ 60 in.	2 in.

- SENSOR CONNECTION TYPES** _____ = **D** **9 - 11**
- D34** = 5-Pin (M12), male, (Analog output)
- D84** = 8-Pin (M12), male, (Start/Stop output)
- INPUT VOLTAGE** _____ = **1** **12**
- 1** = + 24 Vdc (+20%, -15%), standard
- OUTPUT** (2 or 3 digit code defined by output option selected below) _____ = **13 - 15**
- VOLTAGE**
- V01** = 0 to 10 Vdc
- V11** = 10 to 0 Vdc
- V03** = 0 to 10 Vdc and 10 to 0 Vdc (2 output channels)
- CURRENT**
- A01** = 4 to 20 mA
- A11** = 20 to 4 mA
- START/STOP**
- R3** = Start/Stop with sensor parameters upload function
Start/Stop output (Option **R3**) is fully compatible with the Start/Stop output (Option **R0**) used in the previous generation E-Series sensors.

**E-Series
Model ER**

Sold & Serviced By:



Toll Free Phone (877) SERV098

Toll Free Fax (877) SERV099

www.electromate.com

sales@electromate.com

Temposonics®

Magnetostrictive, Absolute, Non-contact
Linear-Position Sensors



E-Series Model EE Embedded Sensor Analog Output

Document Part Number:
551334 Revision A

Data Sheet



Model EE Embeddable Position Sensor
Stroke Length: 50 mm to 2500 mm (2 in. to 100 in.)

FEATURES

- Linear, Absolute Measurement
- Non-Contact Sensing Technology
- Linearity Less Than 0.02% F.S.
- Repeatability Less Than 0.002% F.S.
- Direct Analog Output:
 - 4 to 20 mA or 20 to 4 mA
 - Min/max. load 0/500 Ohms
- Stroke Length Range: 50 mm to 2500 mm (or 2 in. to 100 in.)

BENEFITS

- Compact Design for Embedded Cylinder Applications
- Continuous Absolute Position Measurement
- Over Voltage Protection to 36 Vdc and Polarity Protection up to -30 Vdc
- Increased Operating Temperature

APPLICATIONS

- Space Limited Cylinder Applications
- Embedded Continuous Position Measurement

TYPICAL INDUSTRIES

- Industrial Applications
- Fluid Power

E-Series
Model EE



Sold & Serviced By:

ELECTROMATE

Toll Free Phone (877) SERV098

Toll Free Fax (877) SERV099

www.electromate.com

sales@electromate.com

E-Series Model EE Embedded Sensor, Analog Output Product Overview and Specifications

Product overview

The Temposonics® E-Series embedded (EE) position sensor is designed to be embedded into a hydraulic cylinder. The compact sensor design makes the embeddable E-Series the perfect solution for small cylinders with limited space for the integration of a measuring system. The increased temperature range allows an operation of the sensor in high temperature industrial applications.

MTS Sensors continues to establish new performance standards for low-cost, fully-industrial, durable position sensors using the widely preferred magnetostrictive technology. This principle for accurate and non-contact measurement of linear-position sensing was developed 30 years ago by MTS and is used with outstanding success in a large variety of industrial applications.

Product specifications

Parameters	Specifications
OUTPUT	
Measured output variable:	Position
Resolution:	Analog: Infinite (restricted by output ripple)
Linearity deviation:	< ± 0.02% full stroke (minimum ± 60 µm)
Repeatability:	< ± 0.002% full stroke (minimum ± 20 µm)
Output:	Direct Analog / Current: 4 to 20 mA or 20 to 4 mA (Controller input resistance: RL ≤ 500 Ohms)
Stroke length:	Range: 50 mm to 2500 mm (or 2 to 100 in.)
Update Time:	≤ 3 kHz (Stroke length dependent)
ELECTRONICS	
Operating voltage:	+24 Vdc nominal: -15% or +20% Polarity protection: up to -30 Vdc Over voltage protection: up to 36 Vdc Current drain: 50 to 140 mA

Parameters	Specifications
ENVIRONMENTAL	
Operating conditions:	Operating temperature: -40 °C (-40 °F) to +85 °C (185 °F) Relative humidity: 90% no condensation Ingress protection: IP67 (With professionally mounted housing and connectors.) IP30 (Sensor with flat connector)
EMC test:	Electromagnetic emission: EN 55011, cl. B:2009 + A1:2010 Electromagnetic immunity: EN 61326-1:2006
Shock rating:	100 g (single shock) IEC-Standard 60068-2-27
Vibration rating:	15 g / 10 to 2000 Hz IEC-Standard 60068-2-6 (resonance frequencies excluded)
WIRING	
Connection types:	6-Pin Molex connector
ROD-STYLE SENSOR (MODEL EE)	
Electronic head:	Stainless Steel 1.4301 / AISI 304
Sensor rod:	Stainless Steel 1.4301 / AISI 304 10 mm rod: 350 bar static, 530 bar peak (5000 psi static, 7700 psi peak)
Mounting:	Any orientation. According to installation conditions.
Magnet types:	Ring magnet

E-Series
Model EE

Sold & Serviced By:

 **ELECTROMATE**

Toll Free Phone (877) SERV098

Toll Free Fax (877) SERV099

www.electromate.com

sales@electromate.com

Outputs

ANALOG (CURRENT) OUTPUT

The direct analog output range is 4 to 20 mA or 20 to 4 mA. Since the outputs are direct, no signal conditioning electronics are needed when interfacing with controllers or meters.

Analog output ranges:

- 4 to 20 mA
- 20 to 4 mA

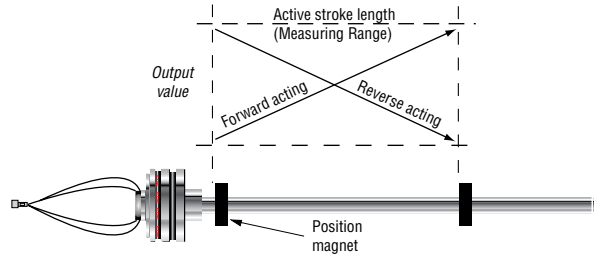
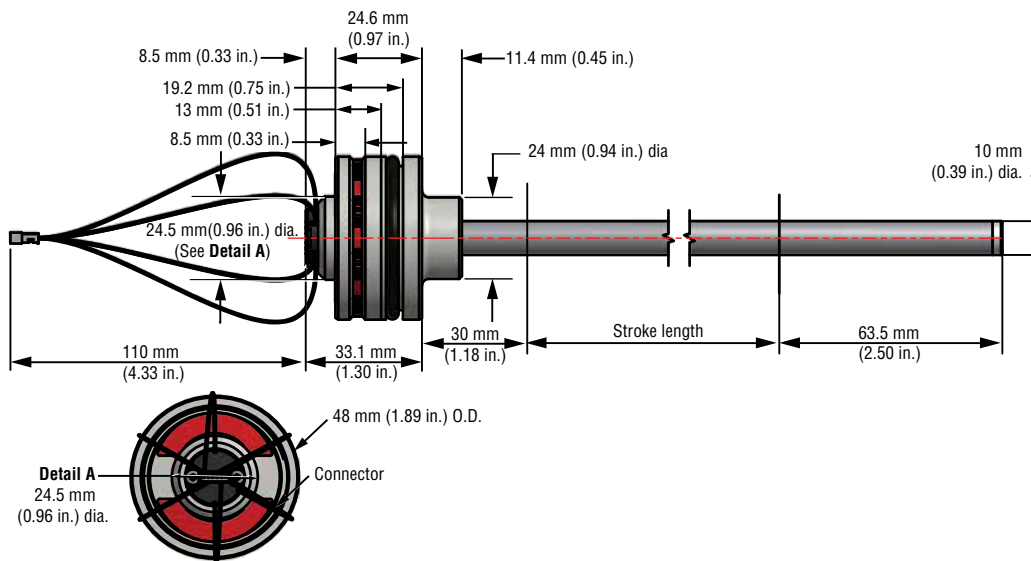

Figure 1. Analog Output signals

Sensor dimension references

Drawings are for reference only, contact applications engineering for tolerance specific information.

MODEL EE



E-Series
Model EE

Figure 3. E-Series Model EE Sensor Component dimension reference

E-Series Model EE Embedded Sensor, Analog Output Magnet Options, Connections and Wiring

Standard magnet options (Model EE)

Magnets must be ordered separately with Model EE position sensors.

 Refer to the Accessories section of this catalog for magnet selections and detailed mounting and installation information.

Connections and wiring (Model EE)

MOLEX MATING CONNECTOR CABLE (M12) 5-PIN AND 6-PIN PINOUT/WIRING INFORMATION

The E-Series Model EE Sensor Component connects directly to a controller or interface module with the standard male, 5-pin or 6-pin connector and an extension cable as described in 'Table 1'

Analog (M12) 5-pin connector (male) as viewed from the face of the sensor plug

5-Pin connector	Molex Pin no.:	(M12) Pin no.:	Signal/function Analog outputs
	6	1	+24 Vdc
	3	2	Output signal
	4	3	DC ground (for power return)
	1	4	n.c.
	5	5	Ground for signal return
	2	-	n.c.

M12 connector cable part no.: 254256

**E-Series
Model EE**

Sold & Serviced By:

 **ELECTROMATE**

Toll Free Phone (877) SERV098

Toll Free Fax (877) SERV099

www.electromate.com

sales@electromate.com

E-Series Model EE Embedded Sensor, Analog Output Cable and Connector Options

CABLE CONNECTOR OPTIONS FOR 5-PIN (M12) CONNECTOR TYPES *(Photo and drawing dimensions are for reference only)*

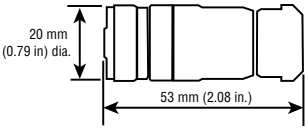
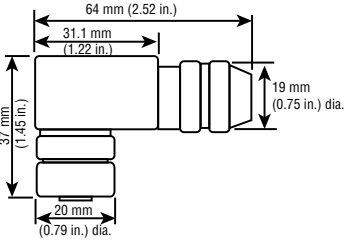
Connector and dimensions	Description	Part number
	<p style="color: red;">Female cable connector, straight exit (Field installable)</p> <p>5-Pin (M12) Mates with 5-pin (M12) connector cable part no.: 254256 Sensor component output: Analog Termination: Screw terminals Cable gland: for 4-8 mm dia. cable Ingress protection: IP 67</p>	370677
	<p style="color: red;">Female cable connector, 90° exit (Field installable)</p> <p>5-Pin (M12) Mates with 5-pin (M12) connector cable part no.: 254256 Sensor component output: Analog Termination: Screw terminals Cable gland: for 6 mm dia. cable Ingress protection: IP 67</p>	370678

MATING CABLE CONNECTOR SELECTIONS *(Drawing dimensions are for reference only)*

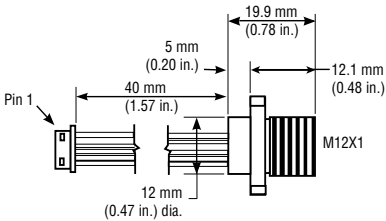
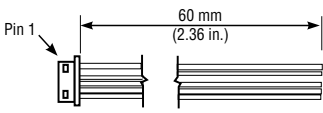
Connector and dimensions	Description	Part number
	<p style="color: red;">Mating cable connector</p> <p>5-Pin (M12)</p>	254256
	<p style="color: red;">Pigtail mating connector</p>	254266

MATING CABLE CONNECTOR SELECTION *(Drawing dimensions are for reference only)*

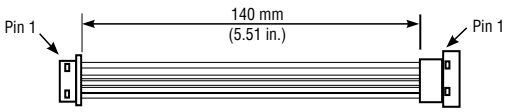
Connector and dimensions	Description	Part number
	<p style="color: red;">Extension cable, Molex to Molex</p>	254243

**E-Series
Model EE**

E-Series Model EE Embedded Sensor, Analog Output Ordering Information

Use the order matrix below to configure your Model EE sensor order number.

E	E	S						M	0	0	1			
1	2	3	4	5	6	7	8	9	10	11	12	13	14	15

- SENSOR MODEL** _____ = **E E** 1 - 2
EE = E-Series Model EE rod-style sensor (Magnet must be ordered separately)
- ROD HOUSING AND FLANGE TYPE** _____ = **S** 3
S = Pressure fit housing, 10 mm OD rod
- STROKE LENGTH** _____ = 4 - 8
- **M** = Millimeters (Encode in 5, 10, 25 or 50 mm increments) as indicated in 'Stroke length notes' below.
- **U** = Inches (Encode in 0.2, 0.5, 1 or 2 in. increments) as indicated in 'Stroke length notes' below.

Stroke length Notes:	
Stroke length ranges:	
M = 50 mm to 2500 mm	
U = 2 in. to 100 in.	
The increment size between standard stroke lengths vary as shown below:	
Stroke length (mm)	Ordering increment
≤ 500 mm	5 mm
> 500 mm and ≤ 750 mm	10 mm
> 750 mm and ≤ 1000 mm	25 mm
> 1000 mm and ≤ 2500 mm	50 mm
Stroke length (in.)	Ordering increment
≤ 20 in.	0.2 in.
> 20 in. and ≤ 30 in.	0.5 in.
> 30 in. and ≤ 40 in.	1 in.
> 40 in. and ≤ 100 in.	2 in.

- SENSOR CONNECTION TYPE** _____ = **M 0 0** 9 - 11
M00 = 6-Pin Molex, male
- INPUT VOLTAGE** _____ = **1** 12
1 = + 24 Vdc (+20%, -15%), standard
- OUTPUT CURRENT** _____ = 13 - 15
- A01** = 4 to 20 mA
A11 = 20 to 4 mA

**E-Series
Model EE**

Temposonics®

Magnetostrictive, Absolute, Non-contact
Linear-Position Sensor Accessories



Document Part Number
550929 Revision E

**Includes Installation, Mounting and
Application References**
Current Production and Retrofit Options for
R-Series, G-Series and E-Series Sensors



Industrial Product Accessories

Contents

Mounting & installation reference, Models RH, RF, RD4 ...	162
Mounting & Installation reference, Models GH and GT	163
Mounting & Installation reference, Models RP and GP	164
Mounting & Installation reference, Models EH/EP/EL	165
Mounting & Installation reference, Models ER and EP2.....	166
Magnet selections	167
Extension cable length limitations.....	171
Extension cable with 6-pin (D60) connector options	172
Extension cable with connector options, RP/RH-Profibus ..	173
Extension cable with connector options RP/RH-SSI	174
Extension cable with 10-pin connector options	175
Connector and bus cables, Industrial Ethernet	176
Connector and bus cables assemblies (M12) cord sets.....	177
Adapter cable retrofit options	178
Connectors	182
Connectors (retrofit) legacy sensor models	188
Pressure pipe	189
Installation hardware	190
Sensor programming; tools and kits.....	194

Mounting and Installation

Rod-Style Sensors

Model RH Rod-Style sensor mounting

The position magnet requires minimum distances away from ferrous metals to allow proper sensor output. The minimum distance from the front of the magnet to the cylinder end cap is 15 mm (0.6 in.).

The minimum distance from the back of the magnet to the piston head is 3.2 mm (0.125 in.). However, a minimum distance of at least 5 mm (0.197 in.) is preferred for added performance margin. The non-ferrous spacer (part no.: 400633) provides this minimum distance when used along with the standard ring magnet (part no.: 201542-2), as shown in 'Figure 1'.

 For applicable magnet selections, refer to 'Magnet Selections'.

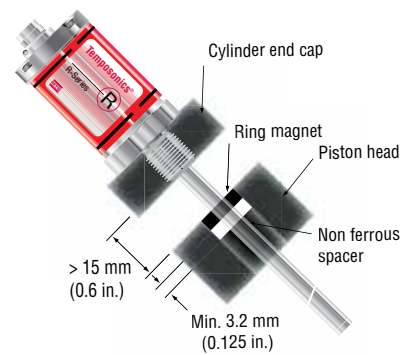

Figure 1. Model RH rod-style mounting

MODEL RH CYLINDER INSTALLATION

When used for direct-stroke measurement in fluid cylinders, the sensor's high pressure, stainless steel rod installs into a bore in the piston head/rod assembly as illustrated. This method guarantees a long-life and trouble-free operation.

The sensor cartridge can be removed from the flange and rod housing while still installed in the cylinder. This procedure allows quick and easy sensor cartridge replacement, without the loss of hydraulic pressure.

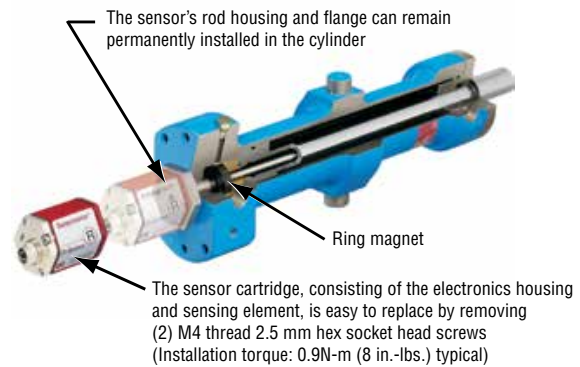



Figure 3. Fluid cylinder installation

Model GH rod-style sensor mounting

The position magnet requires minimum distances away from ferrous metals to allow proper sensor output. The minimum distance from the front of the magnet to the cylinder end cap is 15 mm (0.6 in.).

The minimum distance from the back of the magnet to the piston head is 3.2 mm (0.125 in.). However, a minimum distance of at least 5 mm (0.197 in.) is preferred for added performance margin. The non-ferrous spacer (part no.: 400633) provides this minimum distance when used along with the standard ring magnet (part no.: 201542-2), as shown in 'Figure 3'.

 For applicable magnet selections, refer to 'Magnet Selections'.

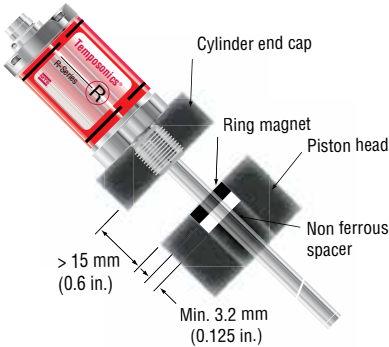

Figure 3. Model GH rod-style mounting

MODEL GH CYLINDER INSTALLATION

When used for direct-stroke measurement in fluid cylinders, the sensor's high pressure, stainless steel rod installs into a bore in the piston head/rod assembly (See 'Figure 4'). This method guarantees a long-life and trouble-free operation.

The sensor cartridge can be removed from the flange and rod housing while still installed in the cylinder. This procedure allows quick and easy sensor cartridge replacement, without the loss of hydraulic pressure.

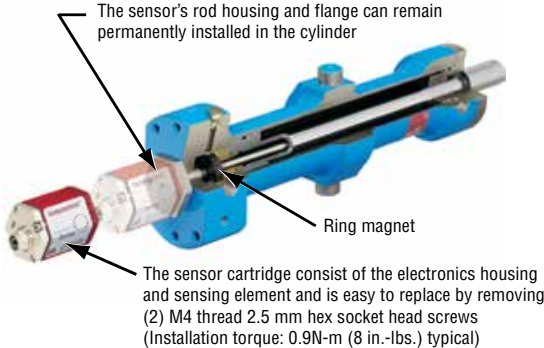
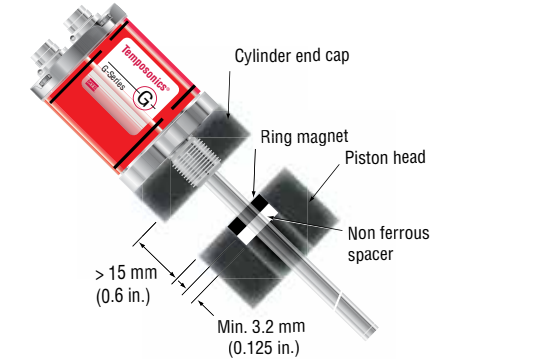

Figure 4. Fluid cylinder installation

Models GT2/GT3 rod-style sensor mounting

The position magnet requires minimum distances away from ferrous metals to allow proper sensor output. The minimum distance from the front of the magnet to the cylinder end cap is 15 mm (0.6 in.).

The minimum distance from the back of the magnet to the piston head is 3.2 mm (0.125 in.). However, a minimum distance of at least 5 mm (0.197 in.) is preferred for added performance margin. The non-ferrous spacer (part no.: 400633) provides this minimum distance when used along with the standard ring magnet (part no.: 201542-2), as shown in 'Figure 5'.



 For applicable magnet selections, refer to 'Magnet Selections'.

Figure 5. Models GT2/GT3 rod-style mounting

MODELS GT2/GT3 CYLINDER INSTALLATION

When used for direct-stroke measurement in fluid cylinders, the sensor's high pressure, stainless steel rod installs into a bore in the piston head/rod assembly (See 'Figure 6'). This method guarantees a long-life and trouble-free operation.

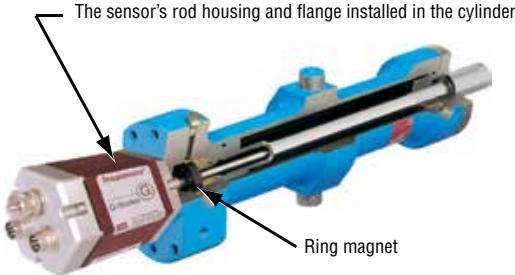

Figure 6. Fluid cylinder installation example

Note:
Unlike the G-Series Model GH sensor (shown in figure 4), GT2/GT3 redundant sensor models do not have a replaceable sensor cartridge feature.

Mounting and Installation
Rod-Style Sensors

**Models RP and GP Profile-Style Sensor
Mounting References**

Models RP and GP sensor mounting references

PROFILE-STYLE SENSOR MOUNTING

Temposonics models RP and GP profile-style sensors offer two basic mounting methods; side grooves for use with mounting feet or a bottom groove that accepts a special T-Slot nut (part no.: 401602). Both the mounting feet and T-Slot nuts can be positioned along the sensor extrusion to best secure the sensor for each particular application.

Notes:

1. Models RP and GP sensors include two mounting feet, (part no. 400802) for sensors stroke lengths up to 1250 mm (50 in.)
2. One additional mounting foot is included for stroke lengths over 1250 mm (50 in.) and for each additional 500 mm (20 in.), thereafter.
3. MTS recommends using 10-32 cap screws (customer supplied) at a maximum torque of 44 in. lbs. when fastening mounting feet.
4. The T-Slot nut (part no.: 401602) requires a **customer supplied** M5 threaded stud and nut.

 For applicable magnet selections, refer to 'Magnet Selections'.

Models RP and GP profile-style sensor mounting and installation references

T-Slot nut (M5 threaded)



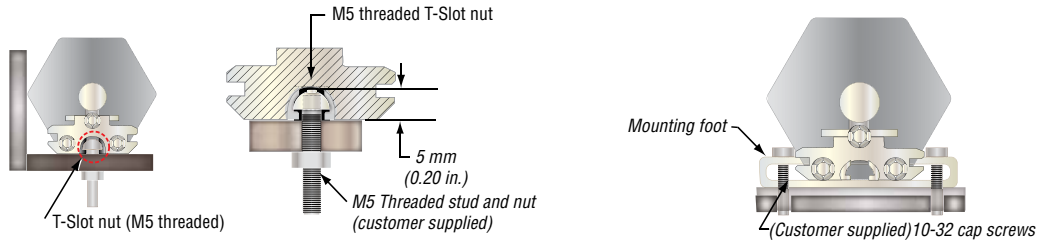

Nut for mounting model RP and GP sensors.

Mounting feet and screws

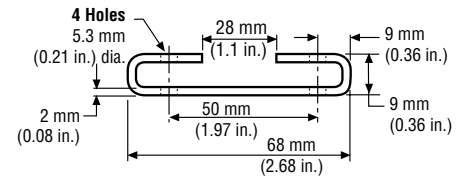

**Mounting and Installation
Profile-Style Sensors**

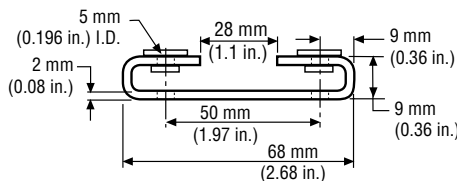
Models RP and GP sensor mounting and installation accessory reference

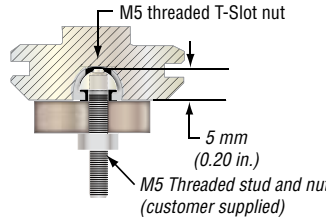
	Description	Part number
  <p>(Width = 14.5 mm (0.57 in.))</p>	<p>Mounting feet, standard (304 SS) Profile-style sensor mounting for sensor models RP and GP</p>	400802
  <p>(Width = 14.5 mm (0.57 in.))</p>	<p>Mounting feet, Insulated (304 SS) Profile-style sensor mounting for sensor models RP and GP. Nylon washers and cloth tape on the bottom provide electrical isolation.</p>	252004
 	<p>T-Slot nut (M5 threaded) Nut for mounting model RP and GP sensors.</p>	401602

Model EH Rod-Style sensor mounting

MODEL EH SENSOR MOUNTING

The model EH sensor is designed for direct stroke measurement inside prepared hydraulic cylinders. At the head of the sensor, a threaded flange and O-Ring provides for mounting and sealing the sensor into a port opening in the cylinder end cap. The sensor's pressure resistant rod fits into a bore drilled through the center of the piston head and rod assembly. The sensor's position magnet is mounted on the top of the piston head or installed in a shallow counter-bore inside the piston head.

The position magnet requires minimum distances away from ferrous metals to allow proper sensor output. The minimum distance from the front of the magnet to the cylinder end cap is 15 mm (0.6 in.).

The minimum distance from the back of the magnet to the piston head is 3.2 mm (0.125 in.). However, a minimum distance of at least 5 mm (0.197 in.) is preferred for performance margin. The non-ferrous spacer (part no. 400633), provides this minimum distance when used along with the standard ring magnet (part no. 201542-2), as shown in 'Figure 7'.

The magnet is usually secured using non-ferrous fastening material (customer supplied). Screws must be made of nonmagnetic stainless steel or brass. In the event that a ferrous circlip or retaining ring will be used to secure the magnet in a counter-bore then an additional non-ferrous spacer (> or = 3.2 mm) must be placed between the circlip or retaining ring and the front side of the magnet.

The cylinder's design ratings for hydraulic pressure and piston velocity will determine the appropriate size for the bore that is drilled through the center of the piston head and rod assembly. The recommended minimum size for this bore is 10 mm (0.39 in.) when using the 7 mm (0.27 in.) diameter sensor rod.

Likewise, the recommended minimum size of 13 mm (0.51 in.) should be used when installing the 10 mm diameter sensor rod. Some applications using long sensor rods may benefit by adding a bushing (e.g. made of flourelastomer material) to prevent wear on the magnet and sensor rod (customer supplied).

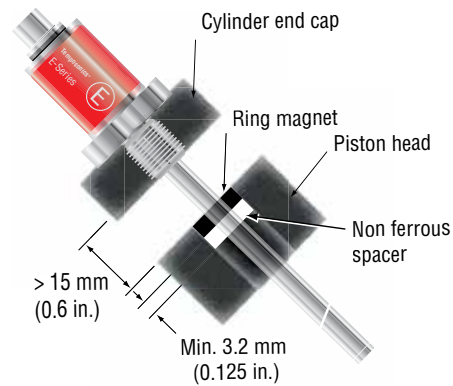

Figure 7. Model EH rod-style mounting

Sensor mounting (Models EP and EL)

SENSOR MOUNTING CLAMPS

E-Series models EP and EL sensors are mounted onto the machine with moveable mounting clamps. Mounting clamps slide into side grooves and should be evenly distributed along the sensor extrusion to best secure the sensor for each particular application.

Notes:

1. Models EP and EL sensors include two mounting clamps, (part number 403508), for stroke lengths up to 1250 mm (50 in.). One additional mounting clamp is included for stroke lengths over 1250 mm (50 in.) and for each additional 500 mm (20 in.) thereafter.
2. MTS recommends using 10-32 cap screws (customer supplied) at a maximum torque of 44 in. lbs. when fastening mounting clamps.

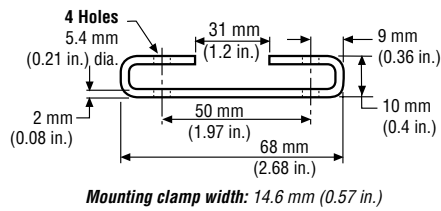
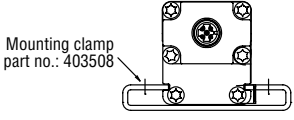
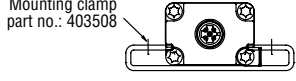
Models EP and EL sensor mounting and installation reference		Mounting method	Part number
 		<p>Mounting clamp Sensor mounting for sensor models EP and EL</p>	403508
<p>Model EP mounting</p> 	<p>Model EL mounting</p> 	<p>Mounting configuration using mounting clamp and screws</p>	<p>Mounting clamp, part number 403508</p>

Sensor Mounting
Models ER and EP2
Sensor mounting (Model ER)

SENSOR MOUNTING CLAMPS

The E-Series model ER sensor is mounted onto the machine with moveable mounting clamps. Grooves for mounting clamps are available on three sides of the sensor housing, allowing versatile mounting orientations for the sensor's connector and extension cable. The rod is then attached to the moving machine part. Optional rod ends can be used to simplify sensor installation design and facilitate articulated motion sensing. Using dual rod ends the model ER sensor can be mounted between two independent moving points, such as swinging door applications. Please note for model ER sensors having stroke lengths over 750 mm (30 in.) only the first 90% of the stroke length can be used for articulated type applications when the weight of the sensor is supported only by rod ends.

Notes:

1. Mounting clamps are ordered separately. Two mounting clamps, (part number 403508) are required for stroke lengths up to 750 mm (30 in.). A least one additional mounting clamp is required for longer stroke lengths.
2. MTS recommends using 10-32 cap screws (customer supplied) at a maximum torque of 44 in. lbs. when fastening mounting clamps.

Model ER sensor mounting and installation reference

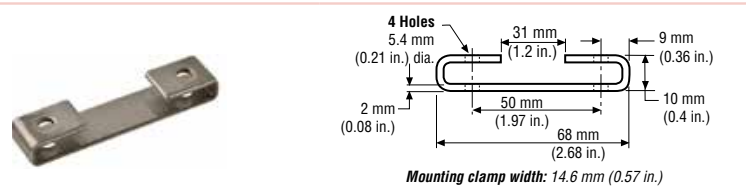

Mounting method

Mounting clamp
 Sensor mounting for sensor model ER

Part number

403508

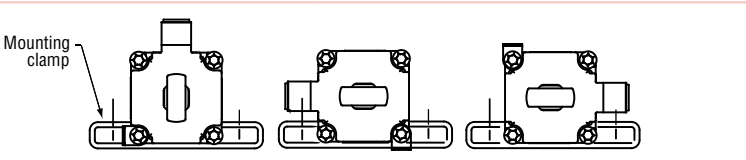

Three possible mounting configuration using mounting clamp and screws

Mounting clamp, part number 403508

Sensor mounting

MODEL EP2 SENSOR MOUNTING

Temposonics model EP2 profile-style sensors are mounted onto a flat straight surface of the machine with moveable mounting feet. A pair (2) mounting feet are provided with each sensor. Two additional mounting feet (part no. 400802) are included for measurement stroke lengths greater than 48 inches. Mounting feet slide into side grooves and should be evenly distributed along the sensor extrusion to best secure the sensor for each particular application.

Notes:

1. Additional mounting feet can be ordered separately.
2. MTS recommends using 10-32 cap screws (customer supplied) at a maximum torque of 44 in. lbs. when fastening mounting feet.

Profile-Style sensor mounting and installation reference

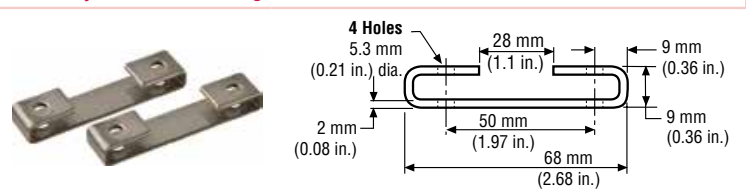

Mounting method

Mounting feet, standard (304 SS)
 Profile-style sensor mounting for sensor model EP2
 (Width = 14.5 mm (0.57 in.))

Part number

400802

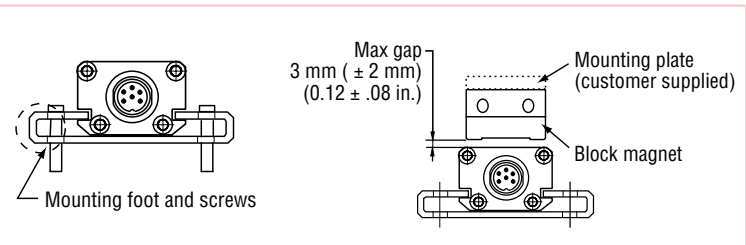

Mounting feet and screws

Profile-style sensor foot installation
Secure mounting feet with customer supplied 10-32 Cap screws. (recommended)
Block magnet, Style L mounting
 Magnet installs on a mounting plate (customer supplied) or flat surface of the machine's moving part.

Mounting feet, part number 400802







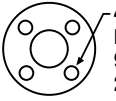

Block magnet, style L part number 252887

Mounting and Installation E-Series Sensors

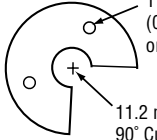
Magnet selections

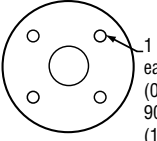
The standard ring magnet (part number 201542-2) is suitable for most applications.

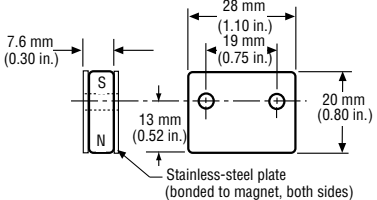

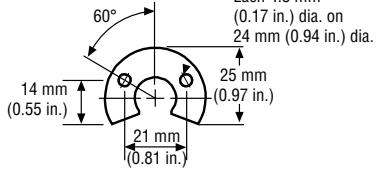



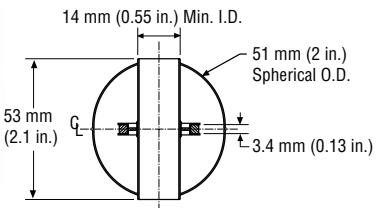

POSITION MAGNET SELECTIONS (Magnet must be ordered separately) (Drawing dimensions are for reference only)

Magnet and magnet dimensions	Description and specifications	Sensor model reference			Part number
  <p>4 Holes Each 4.3 mm (0.17 in.) dia. 90° apart on 24 mm (0.94 in.) dia.</p>	<p>Standard ring magnet Material: Composite PA ferrite GF20 I.D.: 13.5 mm (0.53 in.) O.D.: 33 mm (1.3 in.) Thickness: 8 mm (0.3 in.) Weight: Approx. 14g Operating temperature: - 40 °C to +100 °C</p>	<p>RH RF RD4</p>	<p>GH GT</p>	<p>EH EE</p>	<p>201542-2</p>
  <p>1 of 2 holes each, 4.5 mm (0.18 in.) dia. 120° apart on 41.3 mm (1.625 in.) dia. 11.2 mm (0.44 in.) opening 90° Cut out</p>	<p>Large open-ring magnet Material: PA 66-GF30 Magnet slugs potted with epoxy. I.D.: 15.9 mm (0.625 in.) O.D.: 63.25 mm (2.49 in.) Thickness: 9.5 mm (0.375 in.) Weight: Approx. 26g Operating temperature: - 40 °C to +75 °C</p>	<p>RH RF RD4</p>	<p>GH GT</p>	<p>EH</p>	<p>201553</p>
  <p>1 of 4 holes each 4.6 mm (0.18 in.) dia. 90° apart on 41.3 mm (1.625 in.) dia.</p>	<p>Large ring magnet Material: PA 66-GF30 Magnet slugs potted with epoxy. I.D.: 19.05 mm (0.75 in.) O.D.: 63.25 mm (2.49 in.) Thickness: 9.3 mm (0.375 in.) Weight: Approx. 35g Operating temperature: - 40 °C to +75 °C</p>	<p>RH RF RD4</p>	<p>GH GT</p>	<p>EH EE</p>	<p>201554</p>
  <p>7.6 mm (0.30 in.) 28 mm (1.10 in.) 19 mm (0.75 in.) 20 mm (0.80 in.) 13 mm (0.52 in.) Stainless-steel plate (bonded to magnet, both sides)</p>	<p>Bar magnet, Style L Material: Stainless-steel plate bonded to both magnet sides. Magnet installs on a mounting plate (customer supplied) or flat surface of the machine's moving part. This magnet may influence the sensor performance specifications for some applications.</p>	<p>RH RP RF RD4</p>	<p>GH GP GT</p>	<p>EP EH EL</p>	<p>251298-2</p>
  <p>2 Holes Each 4.3 mm (0.17 in.) dia. on 24 mm (0.94 in.) dia. 60° 14 mm (0.55 in.) 25 mm (0.97 in.) 21 mm (0.81 in.)</p>	<p>Open-ring magnet, Style M Material: Composite PA ferrite GF20 I.D.: 13.5 mm (0.53 in.) O.D.: 33 mm (1.3 in.) Thickness: 8 mm (0.3 in.) Weight: Approx. 11g Operating temperature: - 40 °C to +100 °C This magnet may influence the sensor performance specifications for some applications.</p>	<p>RH RF RD4 RP</p>	<p>GH GT GP</p>	<p>EP EH EL</p>	<p>251416-2</p>

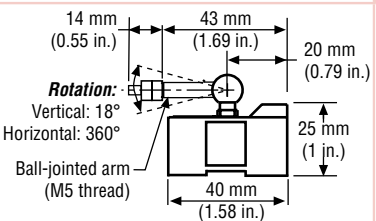
Magnet Selections

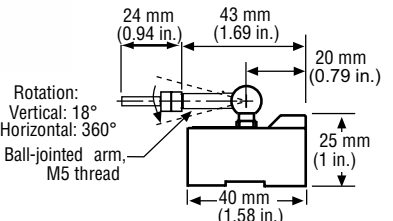
Rod and Profile-Style Position Sensor
Magnet Selections

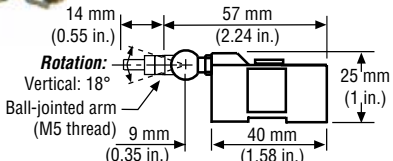

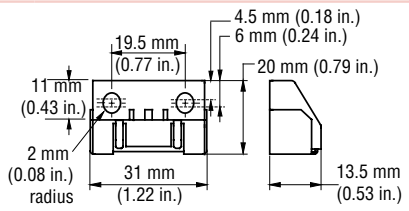





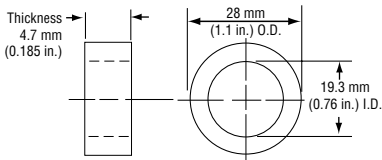

POSITION MAGNET SELECTIONS (Magnet must be ordered separately) (Drawing dimensions are for reference only)

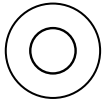
Magnet and magnet dimensions	Description and specifications	Sensor model reference			Part number
		RH RD4	GH GT	EH	
  <p>14 mm (0.55 in.) Min. I.D. 53 mm (2.1 in.) 51 mm (2 in.) Spherical O.D. 3.4 mm (0.13 in.)</p>	<p>Magnet float (Level sensing applications) Material: Stainless steel Weight: Approx. 42 ± 3g Density: 720 kg/m³ Specific gravity: 0.70 maximum Pressure: 870 psi maximum <i>(This float is used with Rod-style sensors for hydraulic fluid or fresh water applications only)</i></p>	RH RD4	GH GT	EH	251447
  <p>14 mm (0.55 in.) 43 mm (1.69 in.) 20 mm (0.79 in.) 25 mm (1 in.) 40 mm (1.58 in.) Rotation: Vertical: 18° Horizontal: 360° Ball-jointed arm (M5 thread)</p>	<p>Captive-sliding magnet, Style S Material: GFK, magnet hard ferrite Weight: Approx. 30g Operating temperature: -40 °C to +75 °C</p>	RP	GP	EP EL	252182
  <p>24 mm (0.94 in.) 43 mm (1.69 in.) 20 mm (0.79 in.) 25 mm (1 in.) 40 mm (1.58 in.) Rotation: Vertical: 18° Horizontal: 360° Ball-jointed arm, M5 thread</p>	<p>Captive-sliding magnet, Style N with longer ball-jointed arm Material: GFK, magnet hard ferrite Weight: Approx. 30g Operating temperature: -40 °C to +75 °C</p>	RP	GP	EP EL	252183
  <p>14 mm (0.55 in.) 57 mm (2.24 in.) 25 mm (1 in.) 9 mm (0.35 in.) 40 mm (1.58 in.) Rotation: Vertical: 18° Ball-jointed arm (M5 thread)</p>	<p>Captive-sliding magnet, Style V Material: GFK, magnet hard ferrite Weight: Approx. 30g Operating temperature: -40 °C to +75 °C</p>	RP	GP	EP EL	252184
  <p>11 mm (0.43 in.) 19.5 mm (0.77 in.) 4.5 mm (0.18 in.) 6 mm (0.24 in.) 20 mm (0.79 in.) 2 mm (0.08 in.) radius 31 mm (1.22 in.) 13.5 mm (0.53 in.)</p>	<p>Block magnet, Style L Material: Magnet hard ferrite with stainless -steel carrier Weight: Approx. 20g ± 2g Operating temperature: -40 °C to +100 °C This magnet may influence the sensor performance specifications for some applications.</p>	RP RH RD4 RF	GH GP GT	EP EP2 EL EH	252887

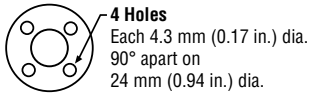
Magnet Selections

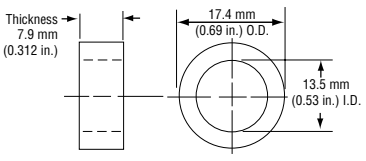
**Rod and Profile-Style Position Sensor
Magnet Selections**

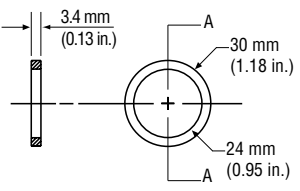

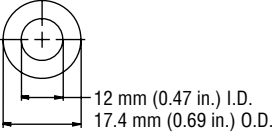







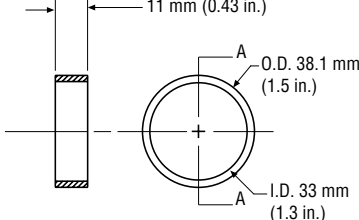

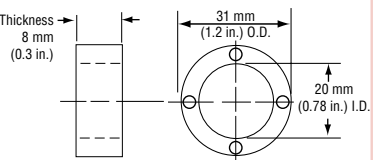
POSITION MAGNET SELECTIONS (Magnet must be ordered separately) (Drawing dimensions are for reference only)

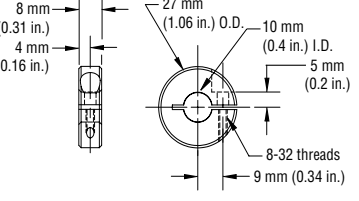
Magnet and magnet dimensions	Description and specifications	Sensor model reference			Part number
 	<p>Large Ring magnet</p> <p>Material: Composite PA ferrite GF20 I.D.: 19.3 mm (0.76 in.) O.D.: 28 mm (1.1 in.) Thickness: 4.7 mm (0.185 in.) Weight: Approx. 6g Operating temperature: -40 °C to +100 °C</p>	<p>RF RH RD4</p>	<p>GH GT</p>	<p>EH EE</p>	<p>400424 Replaces 401467</p>
 	<p>Small ring magnet</p> <p>Material: PA ferrite coated Weight: Approx. 10g I.D.: 13.5 mm (0.53 in.) O.D.: 25.4 mm (1 in.) Thickness: 8 mm (0.3 in.) Operating temperature: -40 °C to +100 °C</p>	<p>RH RF RD4</p>	<p>GH GT</p>	<p>EH EE</p>	<p>400533</p>
 	<p>Magnet spacer (Non-ferrous, use with ring magnet part no.: 201542-2)</p> <p>I.D.: 14 mm (0.56 in.) O.D.: 32 mm (1.25 in.) Thickness: 3.2 mm (0.125 in.)</p>	<p>RH RD4</p>	<p>GH GT</p>	<p>EH EE</p>	<p>400633</p>
 	<p>Small ring magnet</p> <p>Material: PA surface coated Weight: Approx. 5g I.D.: 13.5 mm (0.53 in.) O.D.: 17.4 mm (0.69 in.) Thickness: 7.9 mm (0.312 in.) Operating temperature: -40 °C to +100 °C</p>	<p>RH RD4</p>	<p>GH GT</p>	<p>EH EE</p>	<p>401032</p>
 	<p>Large ring magnet</p> <p>Material: PA ferrite Weight: Approx. 10g I.D.: 24 mm (0.95 in.) O.D.: 30 mm (1.18 in.) Thickness: 3.4 mm (0.13 in.) Operating temperature: -40 °C to +100 °C Contact applications engineering for handling guidelines</p>				<p>401467 Replaced with 400424</p>
 	<p>Ring magnet (Use with Model EH sensors having a 7 mm O.D. rod)</p> <p>I.D.: 12 mm (0.47 in.) O.D.: 17.4 mm (0.69 in.) Thickness: 10.5 mm (0.41 in.) Operating temperature: -40 °C to +100 °C</p>			<p>EH 7 mm O.D. pipe</p>	<p>253572</p>

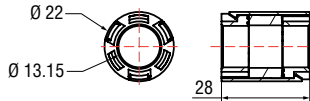
Magnet Selections

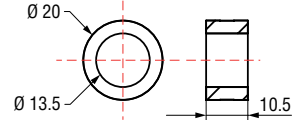
**Rod and Profile-Style Position Sensor
Magnet Selections**

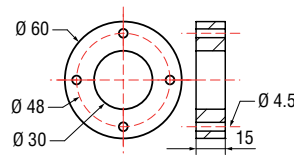
POSITION MAGNET SELECTIONS (Magnet must be ordered separately) (Drawing dimensions are for reference only)

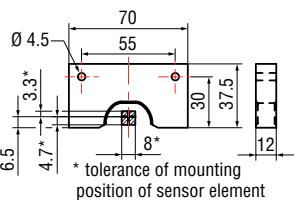
Magnet and magnet dimensions		Description and specifications	Sensor model reference			Part number
		<p>Large ring magnet Material: PA ferrite Weight: Approx. 10g I.D.: 33 mm (1.3 in.) O.D.: 38.1 mm (1.5 in.) Thickness: 3.4 mm (0.13 in.) Operating temperature: -40 °C to +100 °C Contact applications engineering for handling guidelines</p>	RH RF RD4	GH GT	EH EE	401468
		<p>Ring magnet Material: Weight: I.D.: 19.8 mm (0.78 in.) O.D.: 31 mm (1.2 in.) Thickness: 8 mm (0.3 in.)</p>	RH RF RD4	GH GT	EH EE	402316
		<p>Collar Provides end of stroke stops for magnet float (part no.: 251447)</p>	RH RD4	GH GT	EH	560777
		<p>System magnet Material: composite POM Weight: 14 g Operating temperature: -40...+75 °C Surface pressure: 20 N/mm²</p>	RH RD4	GH GT	EH EE	253928
		<p>Multipole magnet Material: composite neobonded Weight: 8.5 g Operating temperature: -40...+75 °C Surface pressure: 20 N/mm²</p>	RH RD4	GH GT	EH EE	254012
		<p>Ring magnet OD60 Material: Al CuMgPb, Magnets compound-filled; Weight: ca. 90 g Operating temperature: -40...+75 °C Surface pressure: 20 N/mm² Fastening torque for M4 screws: max. 1 Nm</p>	RH RD4 RF	GH GT	EH	MT0162
		<p>U-magnet Material: AlMg4.5Mn, black anodised; magnets compound-filled Weight: 125 g Operating temperature: -40...+75 °C Fastening torque for M4 screws: max. 4 Nm This magnet may influence the sensor performance specifications for some applications.</p>	RH RF RP	GH GP	EH EP	252185

Notes:

If your application requires a magnet that is not shown, contact the Factory and consult Applications Engineering for custom or additional non-standard magnet options.

Magnet Selections

Cable length limitations (bus and serial communications industry standards)

Please apply good industry practices for long cable runs. Cables must be kept away from high-power AC lines and all motor drive cables.

R-SERIES SENSORS



SSI	CANbus	DeviceNet	Profibus	Baud rate	Maximum cable or bus length	
●				1.0 MBd	10 ft.	3 m
●				400 kBd	160 ft.	50 m
●				300 kBd	320 ft.	100 m
●				200 kBd	650 ft.	200 m
●				100 kBd	1300 ft.	400 m
	●			1.0 MBd	80 ft.	25 m
	●			500 kBd	320 ft.	100 m
	●			250 kBd	820 ft.	250 m
	●			125 kBd	1640 ft.	500 m
		●		500 kBd	420 ft.	130 m
		●		250 kBd	800 ft.	270 m
		●		125 kBd	1730 ft.	530 m
			●	12 MBd	330 ft.	100 m
			●	1.5 MBd	650 ft.	200 m
			●	500 kBd	1300 ft.	400 m
			●	187.5 kBd	3280 ft.	1000 m
			●	≤ 93.75 kBd	3940 ft.	1200 m

Extension Cable Length Limitations

G-SERIES SENSORS



Analog (Voltage/Current) Outputs	Digital (PWM or Start/Stop) Outputs	Neuter (Start/Stop) Output	Maximum Cable Length	
●			150 ft.	45 m
	●		300 ft. Δ	90 m
		●	250 ft. \dagger	75 m

Δ 300 ft.. maximum when using the \pm differential pair for the interrogation or **Start** signal and for the gate or **Stop** signal.

\dagger 250 ft. maximum when using the single-ended interrogation or **Start** signal. The unused differential signal **MUST** be terminated to ground at the control box.

EXTENSION CABLE OPTION AND SENSOR MODEL COMPATIBILITY REFERENCE

Extension Cable with Connection types	R-Series	G-Series	E-Series
Standard 6-pin (D60)	Analog, CANbus	Analog, Digital-pulse	
6-pin (D63)	Profibus		
7-pin DIN (D70)	SSI		
10-pin MS (MS0)	SSI	Analog, Digital-pulse	
Continued on next page			

Extension Cable with Connector / Ordering Information
D6 (D60) Connection Type Options

Extension Cable with Connection types	R-Series	G-Series	E-Series
5-pin M12 (D54)	CANbus		
5-pin M12 (D53)	Profibus		
4-pin M12 (D56)	EtherCAT, EtherNet/IP		
5-pin M12 (D34)			Analog
8-pin M12 (D84)			Digital-pulse

EXTENSION CABLE WITH CONNECTORS FOR D6 (D60) CONNECTION TYPES (R-SERIES AND G-SERIES SENSORS)

Extension Cable and Connector	Description	Connection type
	Female Connector, Straight Exit with Standard PVC Jacket Cable (Assembly Includes D6 Connector, Part No.: 560700 and Cable, Part No.:530026)	D6
	Female Connector, 90° Exit with Standard PVC Jacket Cable (Assembly Includes D6 Connector, Part No.: 560778 and Cable, Part No.:530026)	DA
	Female Connector, Straight Exit with Black Polyurethane Jacket Cable (for higher resistance to moisture, oil and cold temperatures) (Assembly Includes D6 Connector, Part No.: 370423 and Cable, Part No.:530052)	DJ
	Female Connector, 90° Exit with Black Polyurethane Jacket Cable (for higher resistance to moisture, oil and cold temperatures) (Assembly Includes D6 Connector, Part No.: 560778 and Cable, Part No.:530052)	DK

Extension Cables Std. 6-Pin (D60)

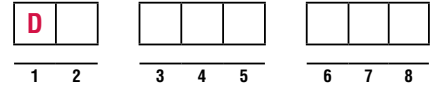

Ordering Information
Extension Cable with Connector for D6 (D60) Connection Types



- SENSOR CONNECTION TYPES** _____ = D **1 - 2**
- D6** = Female connector, straight exit (part no. 560700), and PVC jacket cable (part no. 530026)
 - DA** = Female connector, 90° exit (part no. 560778), and PVC jacket cable (part no. 530026)
 - DJ** = Female connector, straight exit (part no. 560700), and black polyurethane jacket cable (part no. 530052)
 - DK** = Female connector, 90° exit (part no. 560778), and black polyurethane jacket cable (part no. 530052)
- CABLE LENGTHS** _____ = **3 - 5**
- For standard length cables up to 100 ft.**
- 005** = 5 ft.
 - 015** = 15 ft.
 - 025** = 25 ft.
 - 050** = 50 ft.
 - 100** = 100 ft.
- For custom length cables over 100 ft.**
 = Cable length (maximum cable length is dependent on the output selected; consult MTS Applications Engineering)
- CABLE TERMINATION** _____ = **6 - 8**
- P0** = Pigtail cable without connector (2 digit code)
 - D6M** = D6 male connector (straight exit). Only available with the **D6** option above.
 - D6F** = D6 female connector (straight exit). Only available with the **D6** option above.
 - DAF** = D6 female connector (90° exit). Only available with the **DA** option above.

**Extension Cable with Connector / Ordering Information
R-Series Profibus D6 (D63) Connection Type Options**

EXTENSION CABLE WITH CONNECTORS FOR R-SERIES PROFIBUS SENSORS WITH (D63) CONNECTION TYPES

Extension cable and connector assemblies	Description	Connection type
	Hybrid Profibus Bus Cable, straight exit, 6-pin DIN female connector, with PG9 strain relief for (D63) sensor connection types <i>(Assembly Includes D63 Connector, Part no.: 370423 and Cable, Part no.:530040)</i>	DF
	Hybrid Profibus Bus Cable, 90° exit, 6-pin DIN female connector with PG9 strain relief for (D63) sensor connection types <i>(Assembly Includes D63 Connector, Part no.: 560778 and Cable, Part no.:530040)</i>	DG

ORDERING INFORMATION - EXTENSION CABLE WITH CONNECTORS FOR R-SERIES PROFIBUS SENSORS WITH (D63) CONNECTION TYPES



- SENSOR CONNECTION TYPES** _____ =

D	
---	--

1 - 2
- DF** = Female connector, straight exit (part no. 370423), and Profibus cable (part no.: 530040) with (D63) type connector
- DG** = Female connector, 90° exit (part no. 560778), and Profibus cable (part no.: 530040) with (D63) type connector
- CABLE LENGTHS** _____ =

--	--	--

3 - 5
- For standard length cables up to 100 ft.**
- 005** = 5 ft.
015 = 15 ft.
025 = 25 ft.
050 = 50 ft.
100 = 100 ft.
- For custom length cables over 100 ft.**
- — — = Cable length (maximum cable length is dependent on baud rate).
- CABLE TERMINATION** _____ =

--	--	--

6 - 8
- P0** = Pigtail cable without connector (2-digit code)
- DFM** = Male connector, (Straight exit). For daisy-chain connections of Profibus sensors with D63 connector.
- DGM** = Male connector, (90° exit). For daisy-chain connections of Profibus sensors with D63 connector.

**Extension Cables
Profibus D6 (D63)**

Extension Cable with the Standard 7-pin DIN Connector / Ordering Information
R-Series SSI D7 (D70) Connection Type Options

EXTENSION CABLE WITH CONNECTORS FOR R-SERIES SENSORS WITH THE 7-PIN DIN (D70) CONNECTION TYPE

Extension cable and connector assemblies	Description	Connection Type
	Female Connector, Straight Exit and Orange Polyurethane Jacket Cable with High-Performance Shielding (Assembly Includes D7 Connector, Part No.: 560701 and Cable, part no.: 530029)	D7
	Female Connector, 90° Exit and Orange Polyurethane Jacket Cable with High-Performance Shielding (Assembly Includes D7 Connector, Part No.: 560779 and Cable, part no.: 530029)	DR
	Female Connector, Straight Exit and Standard PVC Jacket Cable (Assembly Includes D7 Connector, Part No.: 560701 and Cable, part no.: 530026)	DS
	Female Connector, 90° Exit and Standard PVC Jacket Cable (Assembly Includes D7 Connector, Part No.: 560779 and Cable, part no.: 530026)	DT
	Female Connector, Straight Exit and Black Polyurethane Jacket Cable (for higher resistance to moisture, oil and cold temperatures) (Assembly Includes D7 Connector, Part No.: 560701 and Cable, part no.: 530052)	DU
	Female Connector, 90° Exit and Black Polyurethane Jacket Cable (for higher resistance to moisture, oil and cold temperatures) (Assembly Includes D7 Connector, Part No.: 560779 and Cable, part no.: 530052)	DV

**Extension Cables
SSI D7 (D70)**

ORDERING INFORMATION - EXTENSION CABLE WITH CONNECTORS FOR R-SERIES SENSORS WITH THE (D70) CONNECTION TYPE

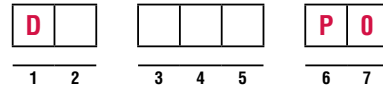

SENSOR CONNECTION TYPES _____ =

D	
---	--

1 - 2

- D7** = Female connector, straight exit (part no. 560701), and orange polyurethane jacket cable (part no.: 530029)
- DR** = Female connector, 90° exit (part no. 560779), and orange polyurethane jacket cable (part no.: 530029)
- DS** = Female connector, straight exit (part no. 560701), and PVC jacket cable (part no. 530026)
- DT** = Female connector, 90° exit (part no. 560779), and PVC jacket cable (part no.: 530026)
- DU** = Female connector, straight exit (part no. 560701), and black polyurethane jacket cable (part no. : 530052)
- DV** = Female connector, 90° exit (part no. 560779), and black polyurethane jacket cable (part no.: 530052)

CABLE LENGTHS _____ =

--	--	--

3 - 5

For standard length cables up to 100 ft.

- 005** = 5 ft.
- 015** = 15 ft.
- 025** = 25 ft.
- 050** = 50 ft.
- 100** = 100 ft.

For custom length cables over 100 ft.

— — — = Cable length (maximum cable length is dependent on baud rate).

CABLE TERMINATION _____ =

P	0
---	---

6 - 7

- P0** = Pigtail cable without connector

**Extension Cable with 10-pin Connector / Ordering Information
G-Series and R-Series MS (MS0) Connection Type Options**

EXTENSION CABLE WITH CONNECTORS FOR G-SERIES AND R-SERIES (SSI OUTPUT) SENSORS WITH MS (MS0), CONNECTION TYPES

Extension cable and connector assemblies	Description	Connection Type
	Female Connector, Straight Exit and Black Polyurethane Jacket Cable (for higher resistance to moisture, oil and cold temperatures) <i>(Assembly Includes MS Connector with adapter and boot)</i>	<p align="center">MF</p>

ORDERING INFORMATION - EXTENSION CABLE WITH CONNECTORS FOR G-SERIES RETROFITS AND R-SERIES SENSORS (SSI OUTPUT) WITH THE (MS0) CONNECTION TYPE

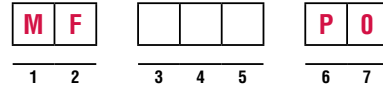

- SENSOR CONNECTION TYPES** _____ =

D	
---	--

 1 - 2
- MF** = Female connector, straight exit with adapter and boot and black polyurethane jacket cable (part no. 530052)
- CABLE LENGTHS** _____ =

--	--	--

 3 - 5
- For standard length cables up to 100 ft.**
- 005** = 5 ft.
 - 015** = 15 ft.
 - 025** = 25 ft.
 - 050** = 50 ft.
 - 100** = 100 ft.
- For custom length cables over 100 ft.**
- — — = Cable length (maximum cable length is dependent on baud rate).
- CABLE TERMINATION** _____ =

P	0
---	---

 6 - 7
- P0** = Pigtail cable without connector

**Extension Cables
10-Pin MS (MS0)**

**Connector and Bus Cable Assembly Options
For Industrial Ethernet Sensors**

BUS CABLE WITH CONNECTORS FOR R-SERIES ETHERNET SENSOR MODELS WITH (D56) CONNECTION TYPES

**Extension Cables
Industrial Ethernet**

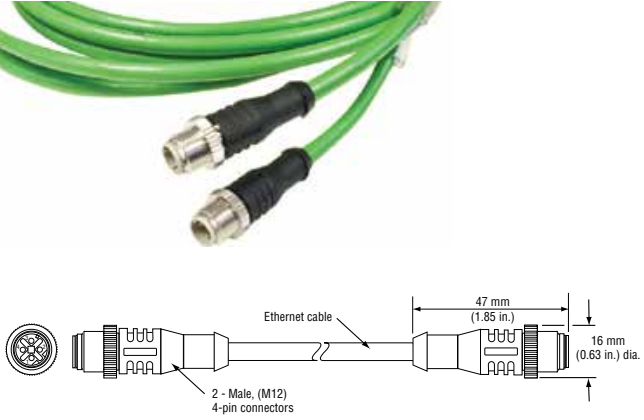
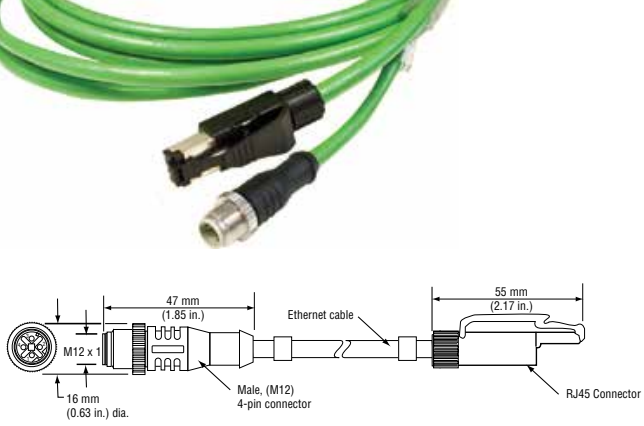
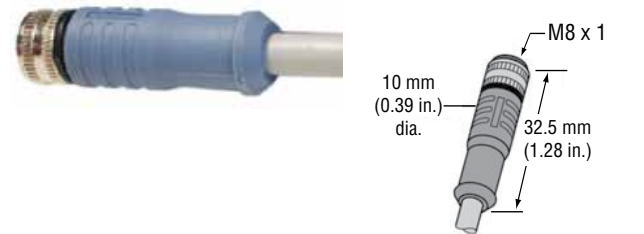
Bus Cable Connector and Dimensions <i>(Drawing dimensions are for reference only)</i>	Description / Specifications	Sensor Model	Cable Length	Part number
<p>Bus cable connector option</p>  <p>Ethernet cable</p> <p>47 mm (1.85 in.)</p> <p>16 mm (0.63 in.) dia.</p> <p>2 - Male, (M12) 4-pin connectors</p>	<p>Industrial Ethernet cable (Cat 5e Es) D-Coded</p> <p>Connector type: Two Male, 4-pin (M12)</p> <p>Cable jacket: PUR cable jacket (green)</p> <p>Installation: Field installable</p>	<p>RP/RH RF, RD4 EtherCAT EtherNet/IP</p>	<p>5 m</p>	<p>530064</p>
 <p>Ethernet cable</p> <p>47 mm (1.85 in.)</p> <p>16 mm (0.63 in.) dia.</p> <p>M12 x 1</p> <p>Male, (M12) 4-pin connector</p> <p>55 mm (2.17 in.)</p> <p>RJ45 Connector</p>	<p>Industrial Ethernet cable (Cat 5e Es) D-Coded</p> <p>Connector type: One RJ45 connector and one male, 4-pin (M12)</p> <p>Cable jacket: PUR cable jacket (green)</p> <p>Installation: Cables using the RJ45 connector provide convenient sensor connection to a PC for setup and programming but are not recommended for factory floor installations.</p>	<p>RP/RH RF, RD4 EtherCAT EtherNet/IP</p>	<p>5 m</p>	<p>530065</p>
<p>Power Cable Connector and Dimensions <i>(Drawing dimensions are for reference only)</i></p>  <p>10 mm (0.39 in.) dia.</p> <p>32.5 mm (1.28 in.)</p> <p>M8 x 1</p>	<p>Power cable, Female 4-pin (M8) and cable with pigtail termination</p> <p>Input: 24 Vdc</p> <p>Wire gage: 4x0.25 mm² shielded</p> <p>Cable jacket: PUR</p>	<p>RP/RH RF, RD4 EtherCAT EtherNet/IP Profibus (D53 connection)</p>	<p>Cable Length 5 m 10 m 15 m</p>	<p>Part number 530066 530096 530093</p>

Connector and Bus Cable Assembly Options
M12 Cord Sets and Adapter Cable Options

M12 CORD SETS AND (M16) ADAPTER CABLE OPTIONS (Photo and drawing dimensions are for reference only)

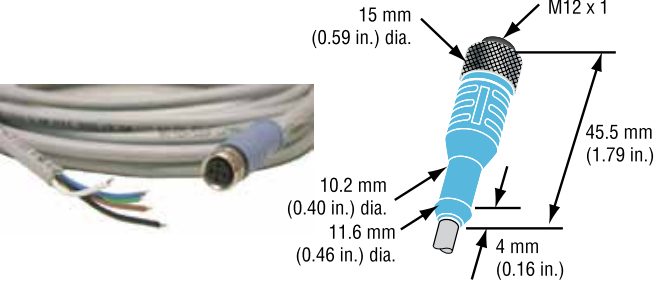
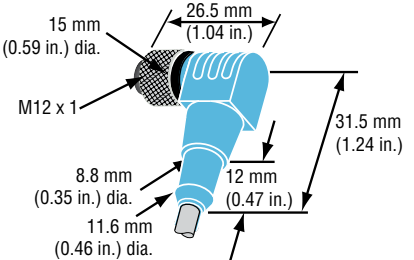
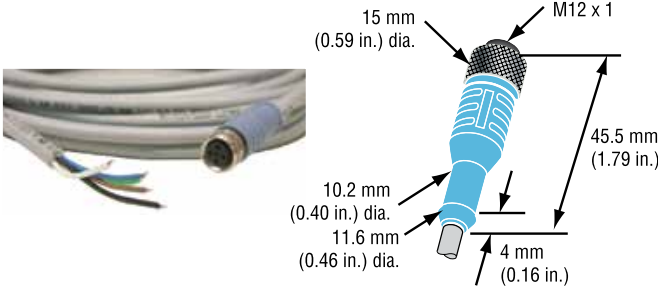
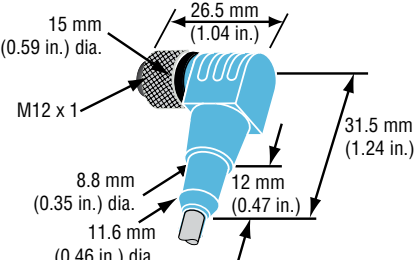
Cord set and dimensions	Description	Sensor Model	Part number
	<p>M12 Cord set, female connector, Straight exit 5-Pin (M12) mates with standard male (D34) integral connector Ingress protection: IP67 Cable: 5 m, shielded, pigtail end, PVC jacket</p>	<p align="center">EH EP EL ER Analog</p>	<p align="center">370685</p>
<p>(Image not available)</p> 	<p>M12 Cord set, female connector 90° exit 5-Pin (M12) mates with standard male (D34) integral connector Ingress protection: IP67 Cable: 5 m, shielded, pigtail end, PVC jacket</p>	<p align="center">EH EP EL ER Analog</p>	<p align="center">370675</p>
	<p>M12 Cord set, female connector, straight exit 8-Pin (M12) mates with standard male (D84) integral connector Ingress protection: IP67 Cable: 5 m, shielded, pigtail end, PVC jacket</p>	<p align="center">EH EP EL ER Start/Stop</p>	<p align="center">370686</p>
<p>(Image not available)</p> 	<p>M12 Cord set, Female, Connector 90° Exit 8-Pin (M12) mates with standard male (D84) integral connector Ingress protection: IP67 Cable: 5 m, shielded, pigtail end, PVC jacket</p>	<p align="center">EH EP EL ER Start/Stop</p>	<p align="center">370676</p>

Notes:

When connecting to sensor, maximum torque for coupling nut is 0.6 N-m (5 in.-lbs.)

**Extension Cables
M12 Cord Sets**

Adapter Cable Retrofit Options
Temposonics® I and II, L-Series Sensor

CABLE RETROFITS WHEN REPLACING TEMPOSONICS II AND L-SERIES MODEL LH SENSORS WITH INTEGRAL RB CONNECTORS

Adapter Cable Description and Specifications	Sensor Replacement	Cable Length		Part number
		1 ft.	5 ft.	
Female, straight exit D6 to male RB cable connections 	GH/GP Analog	●		253243-1
	GH/GP Digital-pulse or Neuter	●		253243-2
Female, straight exit D6 to male RB cable connections 	GH/GP Analog		●	253244-1
	GH/GP Digital-pulse and Neuter		●	253244-2

CABLE RETROFITS WHEN REPLACING TEMPOSONICS II SENSORS WITH INTEGRAL RC CONNECTORS

Adapter Cable Description and Specifications	Sensor Replacement	Cable Length		Part number
		1 ft.	5 ft..	
Female, straight exit D6 to male RC cable connections 	GH/GP Analog	●		201612-1
	GH/GP Digital-pulse and Neuter	●		201612-2
Male RC to female RB cable connections 	Adapter RC to RB		6 in.	401327

Adapter Cable Retrofits

Adapter Cable Retrofit Options
Temposonics® I and II, L-Series Sensors

CABLE RETROFITS WHEN REPLACING MODEL LH SENSORS WITH IN-LINE 10-PIN MS CONNECTORS

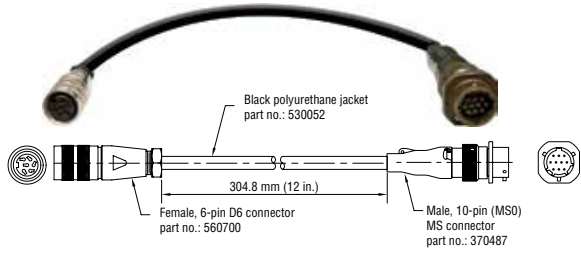
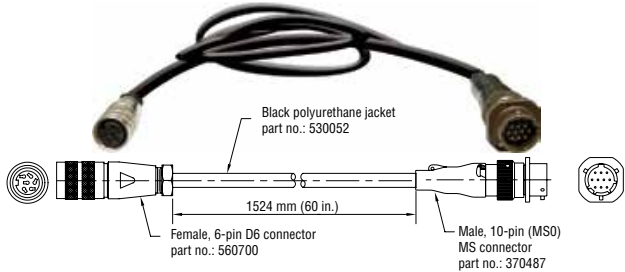
Adapter Cable Description and Specifications	Sensor Replacement	Cable Length		Part number
		1 ft.	5 ft.	
Female, straight exit D6 to male MS cable connections  <p>Black polyurethane jacket part no.: 530052 304.8 mm (12 in.) Female, 6-pin D6 connector part no.: 560700 Male, 10-pin (MS0) MS connector part no.: 370487</p>	GH/GP Analog	●		253245-1
	GH/GP Digital-pulse and Neuter	●		253245-2
 <p>Black polyurethane jacket part no.: 530052 1524 mm (60 in.) Female, 6-pin D6 connector part no.: 560700 Male, 10-pin (MS0) MS connector part no.: 370487</p>	GH/GP Analog		●	253246-1
	GH/GP Digital-pulse or Neuter		●	253246-2

CABLE RETROFITS WHEN REPLACING TEMPOSONICS II AND L-SERIES MODEL LH SENSORS WITH IN-LINE 10-PIN MS CONNECTORS WIRED FOR R1, R2 OR R3 CONNECTION TYPES

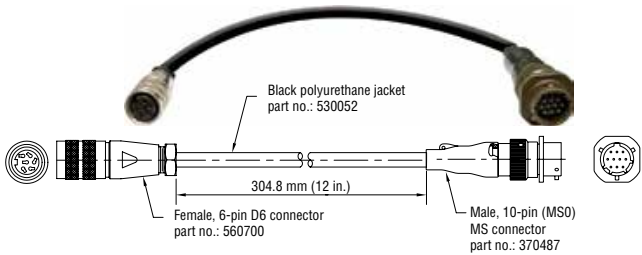
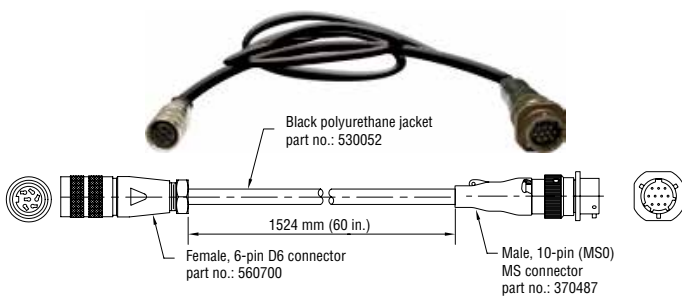
Adapter Cable Description and Specifications	Sensor Replacement	Cable Length		Part number
		1 ft.	5 ft.	
Female, straight exit D6 to MS (R1, R2 or 10-pin male) cable connections  <p>Black polyurethane jacket part no.: 530052 304.8 mm (12 in.) Female, 6-pin D6 connector part no.: 560700 Male, 10-pin (MS0) MS connector part no.: 370487</p>	10-pin R3 Connection using GH/GP Digital-pulse	●		253245-3
 <p>Black polyurethane jacket part no.: 530052 1524 mm (60 in.) Female, 6-pin D6 connector part no.: 560700 Male, 10-pin (MS0) MS connector part no.: 370487</p>	10-pin R3 Connection using GH/GP Digital-pulse		●	253246-3

Adapter Cable Retrofits

Adapter Cables, Retrofit Options

CABLE RETROFITS WHEN REPLACING TEMPOSONICS II AND L-SERIES MODEL LH SENSORS WITH IN-LINE 10-PIN MS CONNECTORS WIRED FOR R1, R2 OR R3 CONNECTION TYPES

Adapter Cable Description and Specifications	Sensor Replacement	Cable Length		Part number
		1 ft.	5 ft.	
<p>Black polyurethane jacket part no.: 530052</p> <p>1524 mm (60 in.)</p> <p>Female, 6-pin D6 connector part no.: 560700</p> <p>Female, 6-pin (R1/R2/R3) MS connector part no.: 370015</p>	R1 Connection using GH/GP with Positive interrogation		●	253302-1
	R2 Connection for GH/GP with negative interrogation		●	253302-2

CABLE RETROFITS WHEN REPLACING R-SERIES AND L-SERIES SENSOR MODELS LH AND LP WITH INTEGRAL RG CONNECTORS

Adapter Cable Description and Specifications	Sensor Replacement	Cable Length		Part number
		1 ft.	5 ft.	
Female, straight exit D6 to male RG cable connections <p>304.8 mm (12 in.) / 1524 mm (60 in.)</p> <p>Standard cable with PVC jacket, part no.: 530026</p> <p>Female, D6 connector part no.: 560700</p> <p>Male, 7-pin RG Integral connector part no.: 402616</p>	RH/RP Analog GH/GP Analog and Digital-pulse	●		253248-1
	RH/RP Analog GH/GP Analog and Digital-pulse			●
Female, straight exit D7 to male RG cable connections <p>304.8 mm (12 in.) / 1524 mm (60 in.)</p> <p>Standard cable with PVC jacket, part no.: 530026</p> <p>D7 connector, female</p> <p>RG Integral connector, male</p>	RH/RP SSI	●		253315-1
	RH/RP SSI			●

CABLE RETROFITS WHEN REPLACING MODEL LP SENSORS WITH INTEGRAL C-STYLE OR IN-LINE H OR J STYLE CONNECTORS

Adapter Cable Description and Specifications	Sensor Replacement	Cable Length		Part Number	
		1 ft.	7 ft.		
Female, straight exit D6 to male AMP cable connections <p>Standard cable with PVC jacket, part no.: 530026</p> <p>304.8 mm (12 in.) / 2133.6 mm (84 in.)</p> <p>Female, 6-pin D6 connector part no.: 560700</p> <p>Male, 8-pin AMP connector</p>	GH/GP Analog	●		253247-1	
	GH/GP Digital-pulse	●		253247-2	
	GH/GP Analog			●	253247-3
	GH/GP Digital-pulse			●	253247-4
	GH/GP Reverse-acting Analog	●			253710-1

Adapter Cable Retrofits

CABLE RETROFITS WHEN REPLACING MODEL LP SENSORS WITH INTEGRAL C-STYLE OR IN-LINE H OR J STYLE CONNECTORS

Adapter Cable Description and Specifications	Sensor Replacement	Cable Length		Part Number
		1 ft.	7 ft.	
<p>5-pin Female (M12) to 8-pin male AMP cable connections</p>	EP/ER Analog		●	254259
<p>8-pin Female (M12) to 8-pin male AMP cable connections</p>	EP/ER Start/Stop		●	254261

CABLE RETROFITS WHEN REPLACING E-SERIES WITH INTEGRAL 6-PIN (D60) CONNECTORS

Adapter Cable Description and Specifications	Sensor Replacement	Cable Length 300 mm	Part number
<p>5-pin female (M12) to 6-pin male D60 cable connections</p>	E-Series 2011	●	254257
<p>8-pin female (M12) to 6-pin male D60 cable connections</p>	E-Series 2011	●	254258



CABLE RETROFIT WHEN REPLACING L-SERIES SENSORS WITH REVERSE-ACTING OUTPUT

Adapter Cable Description and Specifications	Sensor Replacement	Cable Length	Part number
<p>Female, straight exit D6 to male D6 cable connections</p>	GH/GP Reverse-acting Analog	1 ft.	253411

**Adapter Cable
Retrofits**

R-Series Sensor Connectors, Industrial Ethernet and E-Series Cable Connector Options

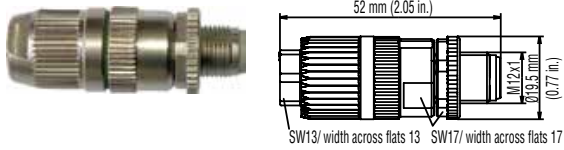
4-PIN STYLE CABLE CONNECTOR FOR R-SERIES INDUSTRIAL ETHERNET SENSOR CONNECTIONS

Cable Connector and Dimensions	Description / Specifications	Sensor Model Reference	Part number
<p>Male, straight exit cable connections</p> 	<p>Bus Cable Connector, Male Style: 4-pin (M12) Housing: Zinc nickel plated Termination: D-coded with insulation displacement technology Installation: Field installable</p>	<p>RP/RH EtherCAT EtherNet/IP</p>	<p>370523</p>
	<p>Connector end cap (Unused connectors should be covered by this protective cap)</p>	<p>RP/RH EtherCAT EtherNet/IP</p>	<p>370537</p>

MATING CABLE CONNECTOR OPTIONS FOR (D34) CONNECTOR TYPES (Photo and drawing dimensions are for reference only)

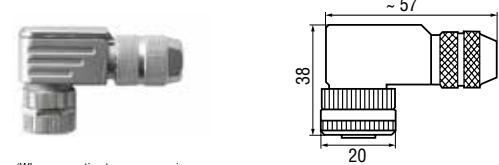
Connector and dimensions	Description	Sensor Model Reference	Part number
 <p>(When connecting to sensor, maximum torque for coupling nut is 0.6 N-m (5 in.-lbs.))</p>	<p>Female cable connector, straight exit (Field installable) 5-Pin (D34) Mates with standard male (M12) integral connector Termination: Screw terminals</p>	<p>EP/ER/EH/EL Analog CANopen</p>	<p>370677</p>
 <p>(When connecting to sensor, maximum torque for coupling nut is 0.6 N-m (5 in.-lbs.))</p>	<p>Female cable connector, 90° exit (Field installable) 5-Pin (D34) Mates with standard male (M12) integral connector Termination: Screw terminals</p>	<p>EP/ER/EH/EL Analog CANopen</p>	<p>370678</p>

MATING CABLE CONNECTOR OPTIONS FOR (D84) CONNECTOR TYPES (Photo and drawing dimensions are for reference only)

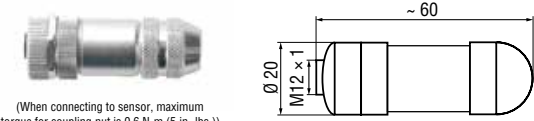
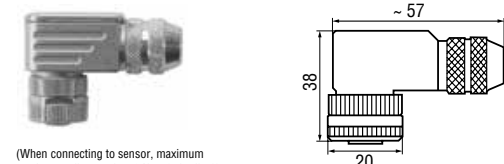
Connector and dimensions	Description	Sensor Model Reference	Part number
 <p>(When connecting to sensor, maximum torque for coupling nut is 0.6 N-m (5 in.-lbs.))</p>	<p>Female cable connector, straight exit (Field installable) 8-Pin (D84) Mates with standard male (M12) integral connector Termination: Screw terminals</p>	<p>EP/ER/EH/EL Start/Stop SSI</p>	<p>370694</p>
 <p>(When connecting to sensor, maximum torque for coupling nut is 0.6 N-m (5 in.-lbs.))</p>	<p>Female cable connector, 90° exit (Field installable) 8-Pin (D84) Mates with standard male (M12) integral connector Termination: Screw terminals</p>	<p>EP/ER/EH/EL: Start/Stop SSI</p>	<p>370699</p>

Connectors

**R-Series Sensor Connectors For DeviceNet (D51)
and Profibus (D53) Connection Types**

5-PIN STYLE CONNECTOR OPTIONS FOR R-SERIES DEVICENET SENSORS WITH (D51) CONNECTION TYPES

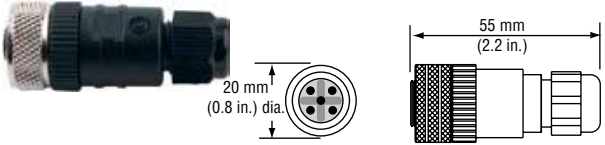
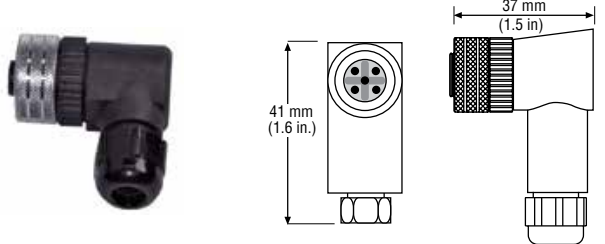
Connector and Dimensions <i>(Drawing dimensions are for reference only)</i>	Description and Specifications	Sensor Model Reference	Part Number
 <p>20 mm (0.8 in.) dia.</p> <p>55 mm (2.2 in.)</p>	<p>Cable connector, female, straight exit Style: 5-pin (D51)</p> <p>Installation: Field installable</p>	<p>RP/RH DeviceNet</p>	<p>370375</p>
 <p>41 mm (1.6 in.)</p> <p>37 mm (1.5 in.)</p>	<p>Cable connector, female, 90° exit Style: 5-pin (D51)</p> <p>Field installable</p>	<p>RP/RH DeviceNet</p>	<p>370376</p>

4-PIN AND CABLE CONNECTOR OPTIONS FOR R-SERIES SENSORS WITH (D53), (D56), AND (D58) CONNECTION TYPES

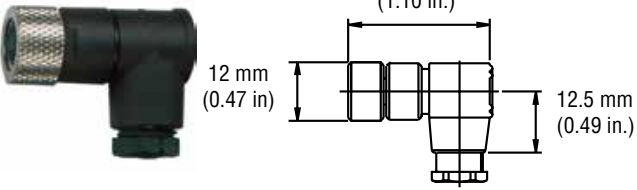
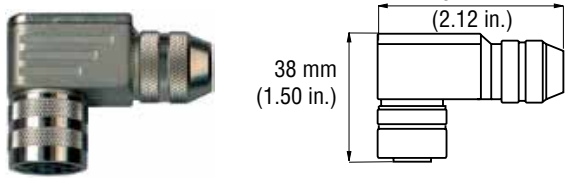
Connector and Dimensions <i>(Drawing dimensions are for reference only)</i>	Description and Specifications	Sensor Model Reference	Part Number
 <p>12 mm (0.58 in.) dia.</p> <p>40 mm (1.58 in.)</p>	<p>Cable connector, female, straight exit Style: 4-pin (M8)</p> <p>Housing: Zinc nickel plated Termination: Solder Contact insert: Silver plated Input Power: 24 Vdc</p> <p>Installation: Field installable, (D53) (D54) (D56) connection types</p>	<p>RP/RH Profibus EtherCAT Ethernet/IP Profinet</p>	<p>370504</p>
 <p>12 mm (0.47 in.)</p> <p>28 mm (1.10 in.)</p> <p>12.5 mm (0.49 in.)</p>	<p>Cable connector, female, 90° exit Style: 4-pin (M8)</p> <p>Housing: Zinc nickel plated Termination: Solder Contact insert: Silver plated Input voltage: 24 Vdc</p> <p>Installation: Field installable, (D53) connection types</p>	<p>RP/RH Profibus EtherCAT Ethernet/IP Profinet</p>	<p>560886</p>
 <p>38 mm (1.50 in.)</p> <p>54 mm (2.12 in.)</p>	<p>Cable connector, female, 90° exit Style: 5-pin (M12)</p> <p>Housing: Zinc nickel plated Termination: Screw Contact insert: Silver plated</p> <p>Installation: Field installable, (D53) connection types</p>	<p>RP/RH Profibus EtherCAT Ethernet/IP Profinet</p>	<p>370514</p>

Connectors

**R-Series Sensor Connectors
For Profibus (D53) Connection Types**

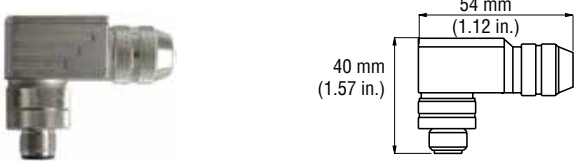
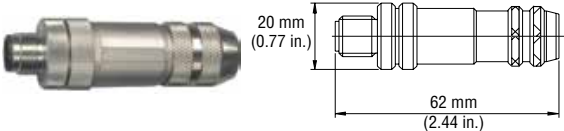
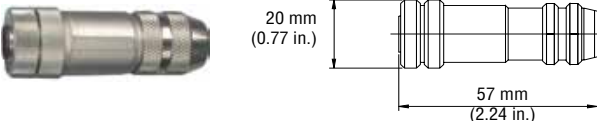

5-PIN CABLE CONNECTOR OPTIONS FOR R-SERIES PROFIBUS SENSORS WITH (D53) CONNECTION TYPES

Connector and Dimensions <i>(Drawing dimensions are for reference only)</i>	Description and Specifications	Sensor Model Reference	Part number
	<p>Cable connector, male, 90° exit Style: 5-pin (M12) Housing: Zinc nickel plated Termination: Screw Contact insert: Silver plated Installation: Field installable, (D53) connection types</p>	<p>RP/RH Profibus</p>	<p>370515</p>
	<p>Cable connector, male, straight exit Style: 5-pin (M12) (3-pins populated) Housing: Zinc nickel plated Termination: IDC Contact insert: Silver plated Installation: Field installable, (D53) connection types</p>	<p>RP/RH Profibus</p>	<p>560884</p>
	<p>Cable connector, female, straight exit Style: 5-pin (M12) (3-pins populated) Housing: Zinc nickel plated Termination: IDC Contact insert: Silver plated Installation: Field installable, (D53) connection types</p>	<p>RP/RH Profibus</p>	<p>560885</p>

Connectors

**R-Series Sensor Connectors
For Profibus (D53) Connection Types**

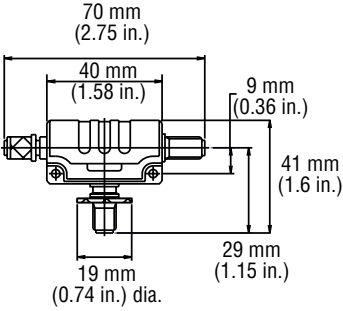
5-PIN CABLE CONNECTOR OPTIONS FOR R-SERIES PROFIBUS SENSORS WITH (D53) CONNECTION TYPES

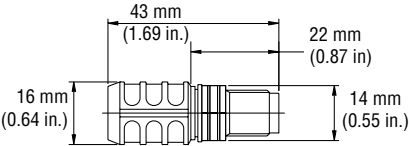
Connector and Dimensions <i>(Drawing dimensions are for reference only)</i>	Description and Specifications	Sensor Model Reference	Part Number
 	<p>5-pin Profibus (M12) T connector Style: 5-pin (M12) Housing: Zinc nickel plated Termination: Solder Contact insert: Silver plated Installation: Field installable, (D53) connection types</p>	<p>RP/RH Profibus</p>	<p>560887</p>
 	<p>Profibus Bus Terminator, male, straight exit Style: 5-pin (M12) Housing: Zinc nickel plated Termination: Solder Contact insert: Silver plated Installation: Field installable, (D53) connection types</p>	<p>RP/RH Profibus</p>	<p>560888</p>

6-PIN DIN (D60) STYLE CABLE CONNECTOR OPTIONS

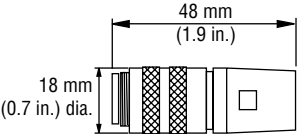
Connector and Dimensions <i>(Drawing dimensions are for reference only)</i>	Description / Specifications	Sensor Model Reference	Part number
 	<p>Profibus bus terminator for male cable connector type Style: (STA09131H06) Housing: Zinc nickel plated Termination: Solder Contact insert: Silver plated Installation: Field installable, Mates with standard Female connector</p>	<p>RP/RH Profibus</p>	<p>252347</p>

**Connectors for Sensors
with (D63/D60) Connection Types**

6-PIN DIN (D60) STYLE CABLE CONNECTOR OPTIONS

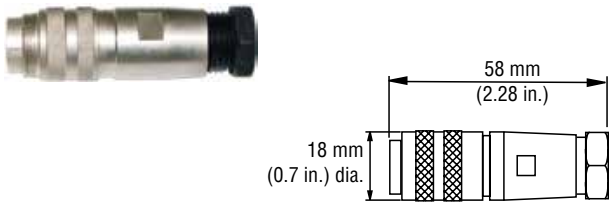
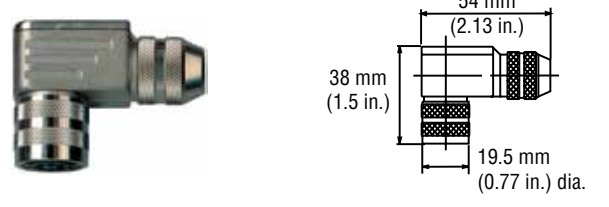
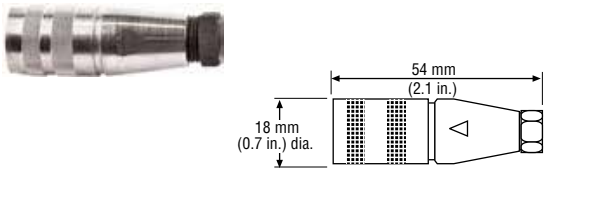
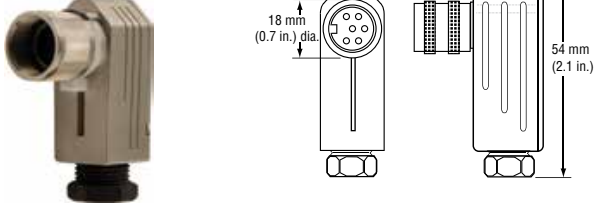
Connector and Dimensions <i>(Drawing dimensions are for reference only)</i>	Description and Specifications	Sensor Model Reference	Part number
	<p>Cable connector, female, straight exit Style: 6-pin DIN (D6) Housing: Zinc nickel plated Termination: Solder Contact insert: Silver plated Cable clamp: PG9 Installation: Field installable (D63) connection types. Cable dia. 8 mm max.</p>	<p>RP/RH Profibus</p>	<p>370423</p>
	<p>Cable connector, male, straight exit Style: 6-pin DIN (D6) Housing: Zinc nickel plated Termination: Solder Contact insert: Silver plated Cable clamp: PG9 Installation: Field installable (D63) connection type. Cable dia. 8 mm max.</p>	<p>RP/RH Profibus</p>	<p>370427</p>
	<p>Cable connector, male, 90° exit Style: 6-pin DIN (D6) Housing: Zinc nickel plated Termination: Solder Contact insert: Silver plated Cable clamp: PG9 Installation: Field installable (D63) connection types. Cable dia. 8 mm max.</p>	<p>RP/RH</p>	<p>370621</p>
	<p>Cable connector, female, straight exit Style: 6-pin DIN (D6) Housing: Zinc nickel plated Termination: Solder Contact insert: Silver plated Cable clamp: PG7 Installation: Field installable, Mates with standard male (D60) integral connector</p>	<p>RP/RH GP/GH</p>	<p>560700</p>
	<p>Cable connector, female, 90° exit Style: 6-pin DIN (D6) Housing: Zinc nickel plated Termination: Solder Contact insert: Silver plated Cable clamp: PG7 Installation: Field installable, Mates with standard male (D60) integral connector</p>	<p>RP/RH GP/GH</p>	<p>560778</p>

Connectors

**Connectors For Sensors
with (D70) Connection Types**

	<p>Cable connector, male, straight exit Style: 6-pin DIN (D6) Housing: Zinc nickel plated Termination: Solder Contact insert: Silver plated Cable clamp: PG7 Installation: Field installable</p>	<p align="center">RP/RH GP/GH</p>	<p align="center">370372</p>
---	---	--	------------------------------

7-PIN STYLE CABLE CONNECTOR OPTIONS FOR R-SERIES SENSORS WITH (D70) CONNECTION TYPES

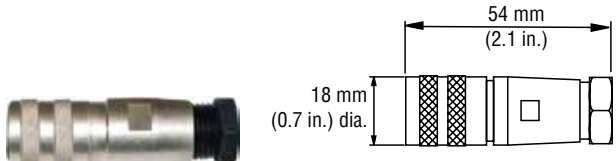
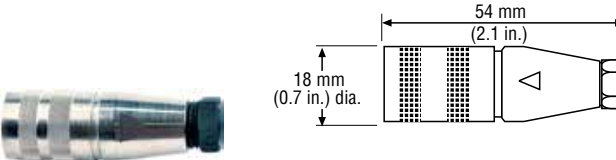
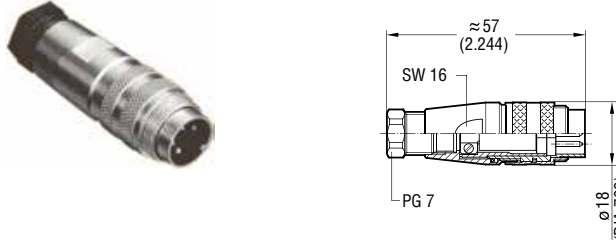
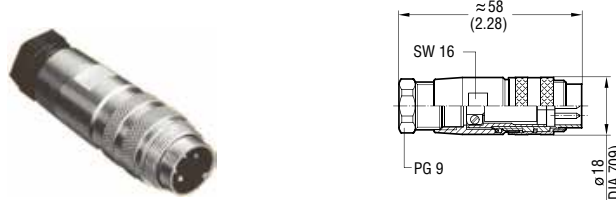
Cable Connector and Dimensions	Description and Specifications	Sensor Model Reference	Part number
	<p>Cable connector, female, straight exit Style: 7-pin (D7) Housing: Zinc nickel plated Termination: Solder Contact insert: Silver plated Cable clamp: PG9 Installation: Field installable for (D70) connection types. Cable dia. 8 mm max.</p>	<p align="center">RP/RH SSI</p>	<p align="center">370624 (previously 370516)</p>
	<p>Cable connector, female, straight exit Style: 7-pin (D7) Housing: Zinc nickel plated Termination: Solder Contact insert: Silver plated Cable clamp: PG7 Installation: Field installable (D70) connection types. Cable dia. 6 mm max.</p>	<p align="center">RP/RH SSI</p>	<p align="center">560701</p>
	<p>Cable connector, male, straight exit Style: 7-pin (D7) Housing: Zinc nickel plated Termination: Solder Contact insert: Silver plated Cable clamp: PG7 Installation: Field installable for (D70) connection types. Cable dia. 6 mm max.</p>	<p align="center">RP/RH SSI</p>	<p align="center">370565</p>
	<p>Cable connector, male, straight exit Style: 7-pin (D7) Housing: Zinc nickel plated Termination: Solder Contact insert: Silver plated Cable clamp: PG9 Installation: Field installable (D70) connection types. Cable dia. 8 mm max.</p>	<p align="center">RP/RH SSI</p>	<p align="center">370625 (previously 370566)</p>

Connectors

Connector Retrofit Options
R-Series, G-Series and L-Series Sensors

CABLE CONNECTOR OPTIONS FOR R-SERIES G-SERIES AND L-SERIES LEGACY SENSOR MODELS

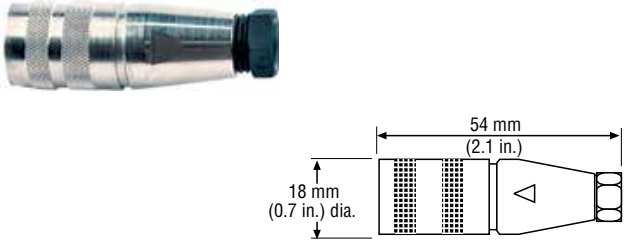
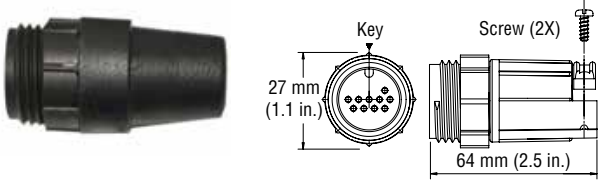
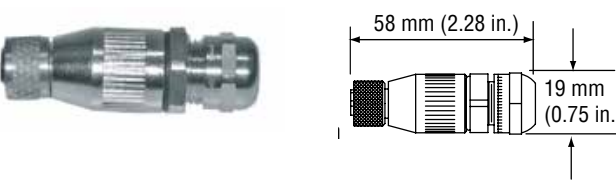
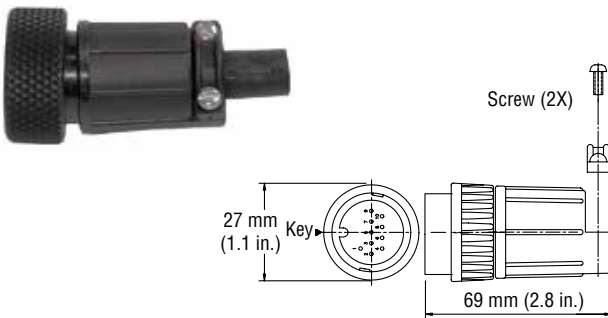
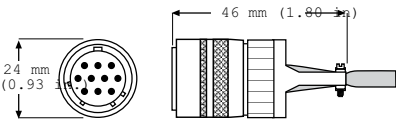
Cable Connector and Dimensions	Description and Specifications	Sensor Model Reference	Part number
	<p>Cable connector, female, straight exit Style: (D8) Housing: Zinc nickel plated Termination: Solder Contact insert: Silver plated Cable clamp: PG7 Installation: Field installable for (D80) connection types.</p>	<p>L-SERIES</p>	<p>370391</p>
	<p>Cable connector, male, RB straight exit Style: 10-pin Housing: Zinc nickel plated Termination: Solder Contact insert: Silver plated Cable clamp: PG7 Installation: Field installable</p>	<p>GP/GH</p>	<p>370486</p>
	<p>Cable connector, female, RG straight exit Style: RG Housing: Zinc nickel plated Termination: Solder Contact insert: Silver plated Cable clamp: PG7 Installation: Field installable</p>	<p>RP/RH L-SERIES</p>	<p>401366</p>
	<p>Cable connector, female, RB/RC straight exit Style: RB/RC retrofit Housing: Zinc nickel plated Termination: Solder Contact insert: Silver plated Cable clamp: PG7 Installation: Field installable</p>	<p>GP/GH</p>	<p>400755-3</p>
	<p>Cable connector, female, MSO straight exit Style: MSO Housing: Cadmium plated aluminum Termination: Solder Contact insert: Gold plated Installation: Field installable</p>	<p>RP/RH GP/GH</p>	<p>370013</p>

Connectors

**Ordering Information
Pressure Pipe**

H	H
---	---

--	--	--	--	--	--

1 2

3 4 5 6 7 8

SENSOR MODELS RH AND GH _____ =

H	H
---	---

 1-2

PRESSURE PIPE AND FLANGE STYLES _____ =

--

 3

- T** = US customary threads, raised-faced flange and pressure pipe, standard
- S** = US customary threads, flat-faced flange and pressure pipe, standard
- M** = Metric threads, flat-faced flange and pressure pipe, standard

STROKE LENGTH _____ =

--	--	--	--	--	--

 4-8

----- **M** = Millimeters
(Encode in 5 mm increments)

----- . -- **U** = Inches and tenths
(Encode in 0.1 in. increments)









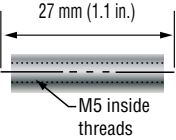

Stroke Length Notes:

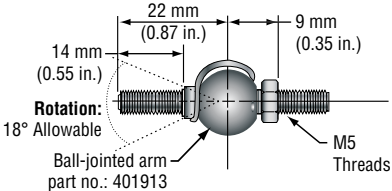
1. R-Series RH stroke length = 25 mm (1 in.) to 7620 mm (300 in.)
2. G-Series GH stroke length = 50 mm (2 in.) to 7620 mm (300 in.)

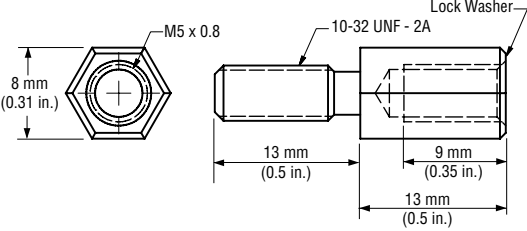
**Pressure Pipe
RH and GH Sensors**

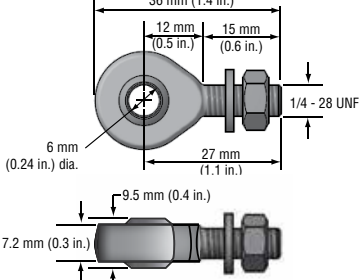
**Installation Hardware
Ordering Information**

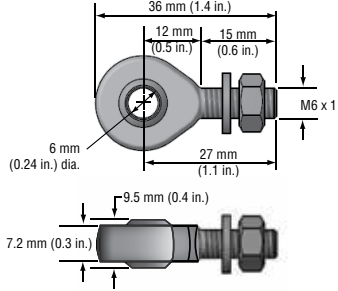
MECHANICAL-END CONNECTOR SELECTIONS

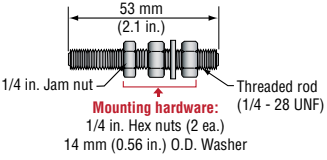
Cable Connector and Dimensions	Description and Specifications	Sensor Model Reference	Part number
 	Joint-rod sleeve	RP/GP EP/EL	401603
 	Ball-jointed arm	RP/GP EP/EL	401913
 	Threaded adapter Female M5 to male 10 - 32	RP/GP EP/EL	402849
 	Rod end US customary measurement Optional, male 1/4 - 28 threads	ER	254235
 	Rod end Metric measurement Optional, male M6 threads	ER	254210
 	Stud end Optional mounting hardware kit Hex nuts (2 pcs.), jam nut and washer	ER	251975

Installation Hardware

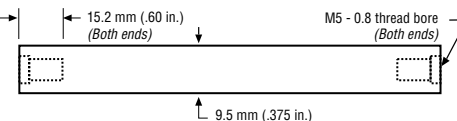
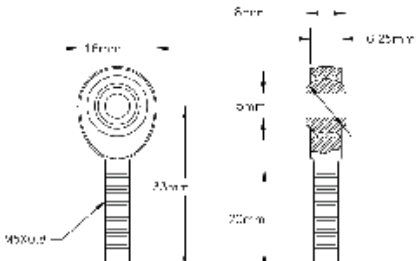

Optional extension rod quick reference chart

Sensor models with captive-sliding magnet					Optional extension rod example	
RP	GP	EP	Extension rod length	Part number		
●	●	●	60.3 mm (2.375 in.)	401768-2	 	
●	●	●	85.7 mm (3.375 in.)	401768-3		
●	●	●	111.1 mm (4.375 in.)	401768-4		
●	●	●	161.9 mm (6.375 in.)	401768-6		
●	●	●	187.3 mm (7.375 in.)	401768-7		
●	●	●	212.7 mm (8.375 in.)	401768-8		
●	●	●	238.1 mm (9.375 in.)	401768-9		
●	●	●	263.5 mm (10.375 in.)	401768-10		
●	●	●	314.3 mm (12.375 in.)	401768-12		
●	●	●	365.1 mm (14.375 in.)	401768-14		
●	●	●	390.5 mm (15.375 in.)	401768-15		
●	●	●	466.7 mm (18.375 in.)	401768-18		
●	●	●	517.5 mm (20.375 in.)	401768-20		
●	●	●	542.9 mm (21.375 in.)	401768-21		
●	●	●	619.1 mm (24.375 in.)	401768-24		
●	●	●	771.5 mm (30.375 in.)	401768-30		
●	●	●	923.9 mm (36.375 in.)	401768-36		
●	●	●	1076.3 mm (42.375 in.)	401768-42		
●	●	●	1228.7 mm (48.375 in.)	401768-48		
●	●	●	1533.5 mm (60.375 in.)	401768-60		
				<p>Rod end M5 threads *(For use with 401768-x optional extension rod shown above)</p>	<p>RP GP EP/EL</p>	401872

Installation Hardware

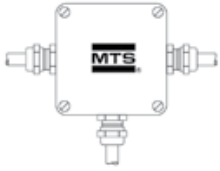
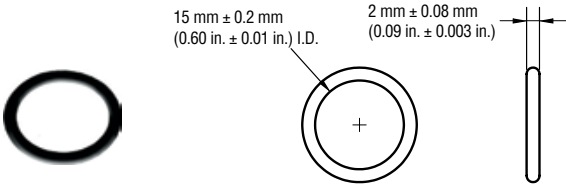
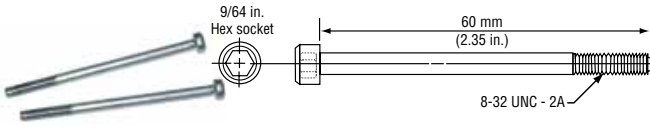

Installation Hardware
Ordering Information

OPTIONAL INSTALLATION HARDWARE

Hardware and Dimensions	Description and Specifications	Sensor Model Reference	Part number
	<p>Profibus filter box Dimensions: 80 mm (3.5 in.) X 75 mm (2.95 in.) 58 mm (2.28 in.) Application: EMC conformal feeding of 24 Vdc supply voltage into the Profibus-DP hybrid cable</p>	<p>RP/RH Profibus</p>	<p>252916</p>
	<p>O-Ring Material: Fluoroelastomer 75 ± 5 durometer Dimensions: Metric flange with M18 X 1.5 threads Application: Use with style M housings</p>	<p>GH/RH/EH</p>	<p>401133</p>
	<p>Electronics housing screw Type: 8-32 UNC - 2A Application: -Used to install sensor cartridge (RHB or GHB) into old LH or old RH pressure pipe/flange (Typical torque 0.9 N-m (8 in.-lbs.))</p>	<p>GHB/RHB</p>	<p>402617</p>
	<p>Hex-jam nut Type: 3/4-16 UNF Material: Stainless steel with nylon insert Application: T and S style housings</p>	<p>GH/RH/EH</p>	<p>500015</p>
	<p>Hex-jam nut Type: M18 X 1.5 threads Material: Stainless steel Application: Use for M style housing</p>	<p>GH/RH/EH</p>	<p>500018</p>

Installation Hardware

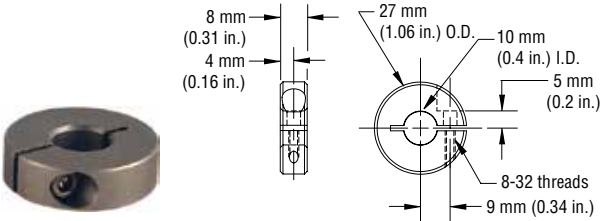
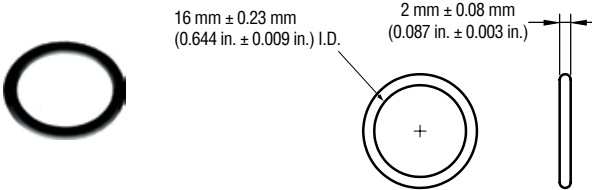
OPTIONAL INSTALLATION HARDWARE

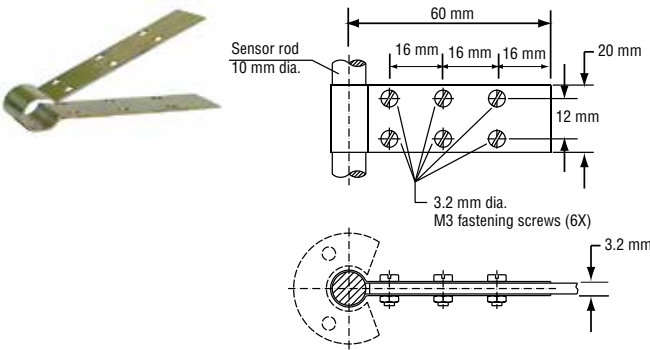
Hardware and Dimensions	Description and Specifications	Sensor Model Reference	Part number
 <p>8 mm (0.31 in.) 4 mm (0.16 in.) 27 mm (1.06 in.) O.D. 10 mm (0.4 in.) I.D. 5 mm (0.2 in.) 8-32 threads 9 mm (0.34 in.)</p>	<p>Collar Material: 304 Stainless steel Application: Pressure housing and float 251447</p>	<p>GH/RH /EH</p>	<p>560777</p>
 <p>16 mm ± 0.23 mm (0.644 in. ± 0.009 in.) I.D. 2 mm ± 0.08 mm (0.087 in. ± 0.003 in.)</p>	<p>O-Ring Material: Fluoroelastomer 75 ± 5 durometer Dimensions: Std. flange with 3/4-16 UNF threads Application: T and S style housings</p>	<p>GH/RH/EH</p>	<p>560315</p>
 <p>6-32 X 7/8 Stainless steel</p>	<p>Magnet mounting screws Type: 6-32 X 7/8 Material: Stainless steel Application: Standard ring magnet mounting (part no.: 201542-2) 4 required or open-ring magnet mounting (part no.: 251416-2) 2 required</p>	<p>RH/RP GH/GP EH/EP/EL</p>	<p>560357</p>
 <p>60 mm 16 mm 16 mm 16 mm 20 mm 12 mm Sensor rod 10 mm dia. 3.2 mm dia. M3 fastening screws (6X) 3.2 mm</p>	<p>Fixing clip Material: Brass, non magnetic Application: Used to secure sensor rod when using open-ring magnet</p>	<p>RH/GH/EH</p>	<p>561481</p>

Installation Hardware



Field Programming Accessories

PROGRAMMING TOOLS

Programming selections	Description and Specifications	Sensor Model Reference	Part number
	<p>R-Series Analog hand-held Programmer Application: Adjusting setpoints 1 and 2 for R-Series Analog output sensor models with single magnets</p>	<p>RP/RH Analog</p>	<p>253124</p>
	<p>R-Series Analog Cabinet Programmer Application: Adjusting setpoints 1 and 2 for R-Series Analog output sensor models with single magnets and features snap-in mounting on standard 35 mm DIN rail. This programmer can be permanently mounted in a control cabinet and includes a program/run switch.</p>	<p>RP/RH Analog</p>	<p>253408</p>
	<p>R-Series Analog Programming Kit Kit includes: Interface converter box, power supply, and cabling. Download setup software from www.mtssensors.com. Application: Programming software for R-Series Analog output sensor models</p>	<p>RP/RH Analog</p>	<p>253309-1</p>
	<p>R-Series SSI Programming Kit Kit includes: Interface converter box, power supply, and cabling. Download setup software from www.mtssensors.com. Application: Programming software for R-Series SSI output sensor models</p>	<p>RP/RH SSI</p>	<p>253310-1</p>
	<p>R-Series Profibus Node Address Programmer kit Application: Node address Programming for R-Series Profibus output sensor models</p>	<p>RP/RH Profibus</p>	<p>280640</p>

Field Programming

PROGRAMMING TOOLS

Programming selections	Description and Specifications	Sensor Model Reference	Part number
	<p>R-Series CANbus Field Address Programmer Application: Field address Programming for R-Series CANopen output sensor models</p>	<p>RP/RH CANopen</p>	<p>252382-D62</p>
	<p>G-Series Analog Hand-held Programmer Application: Programming for G-Series Analog output sensor models</p>	<p>GP/GH Analog</p>	<p>253853</p>
	<p>G-Series Analog PC Programming Kit Kit includes: Interface converter box, power supply and cabling. Download setup software from www.mtssensors.com Application: Programming software for G-Series Analog output sensor models</p>	<p>GP/GH Analog</p>	<p>253311-1</p>
	<p>G-Series Digital-pulse PC Programming Kit Kit includes: Interface converter box, power supply and cabling. Download setup software from www.mtssensors.com Application: Programming software for G-Series Digital-pulse output sensor models</p>	<p>GP/GH Digital-Pulse (PWM) (Start/Stop)</p>	<p>253312-1</p>
	<p>Profibus master simulator. Application: Function and diagnostic data verification and to perform slave address adjustments for R-Series Profibus output sensor models</p>	<p>RP/RH Profibus</p>	<p>401727</p>

Field Programming

Field Programming Accessories

PROGRAMMING TOOLS

Programming selections	Description and Specifications	Sensor Model Reference	Part number
	Profibus cable for master simulator (401727)	RP/RH Profibus	401726



Temposonics®

Magnetostrictive, Absolute, Non-contact
Linear-Position Sensors



High Pressure Housing - Explosion Proof R-Series (RH) and G-Series (GH) Sensors

Document Part Number
550960 Revision C

Outputs - Reference G and R-Series Data Sheets

PRECISION POSITION MEASUREMENT HIGH PRESSURE HOUSING (HPH)

- This High Pressure Housing is ATEX EEx approved and UL and cUL approved for use in hazardous locations with Temposonics position sensors.
- ATEX, UL and cUL approvals cover flammable gases, vapors and liquids. The ATEX approval also covers dust
- Several design combinations are available to fit your application:
 - M18 or 3/4 in. UNF mounting flange thread
 - M20 or 1/2 in. NPT cable gland thread
 - long or short tops
 - top-mounted
 - side-mounted
 - dual side-mounted cable glands*(See combination chart for more information)*
- All parts are made of 316L stainless steel. The HPH housing is also available in non-approved versions ensuring an outstanding protection to the sensor when used in rugged applications with high humidity and aggressive gases.



High Pressure
Housing

The High Pressure Housing (HPH) is ATEX EEx approved or UL and cUL approved for use in hazardous locations with a range of Temposonics linear-position sensors



Sold & Serviced By:
 ELECTROMATE

Toll Free Phone (877) SERV098
Toll Free Fax (877) SERV099
www.electromate.com
sales@electromate.com

Industrial Product Accessory, High Pressure Housing
Product Overview and Specifications

Product overview

This housing is made to fit Temposonics R-Series and G-Series sensors with analog and digital outputs, both integral cable and connector versions can be used.

The High Pressure Housing provides a cost efficient solution to sensor applications in hazardous locations. When using the HPH with Temposonics linear-position sensors, sensor maintenance and replacement is simplified.

HIGH PRESSURE HOUSING OPTIONS

High Pressure Housing

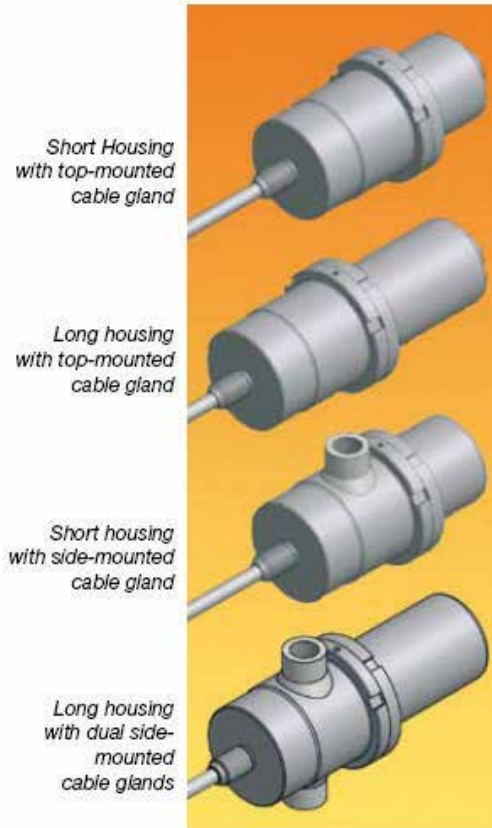

Product specifications

Parameters	Specifications
Protection type:	CE 0044 TÜV 13 ATEX 121172 X
ATEX:	IECEx TUN 13 0011 X
IECEx:	II 1/2 G Ex d IIC T5* Gb Tamb -40° to +70°C II 1/2 D Ex tb IIIC T100C Db
	IEC 60079-0:2011, IEC 60079-1:2007, IEC 60079-26:2006, IEC 60079-31, EN 60079-0:2009, EN 60079-1:2007, EN 60079-26:2007, EN 60079-31:2009
	Only with ATEX or UL approved cable glands
UL/cUL:	Class 1, Division 1, Groups A, B, C and D hazardous locations Temperature code T5 As to fire, electrical shock and explosion hazards only UL certificate no. 2PDO In accordance with UL 1203 standard
	
Material:	Stainless steel AISI 316L (1.4404)
Cable gland threads:	M20 x 1.5
Ingress protection codes:	IP 68 (only with IP 68 approved cable gland)
Approved sensors:	G-Series Analog + Start/Stop R-Series Analog R-Series Profibus R-Series CANbus R-Series SSI R-Series DeviceNet *Consult individual sensor data sheets for more product specifications and sensor ordering information at www.mtssensors.com
Mounting flange:	M18 x 1.5 or 3/4 in. - 16 UNF - 3A
Pressure rating:	350 Bar continuous
Peak pressure:	530 Bar
Magnet type:	Ring magnet (GF plastic with permanent magnet)
Level measurement:	Float on request

High Pressure Housing dimensions

HIGH PRESSURE HOUSING DIMENSION REFERENCES

The Summit High Pressure Housing is available in several design combinations and two cable gland mounting options, top and side. Refer to 'Table 1 Design Combination Chart' on page 3 for a design combination and accessory options for your application

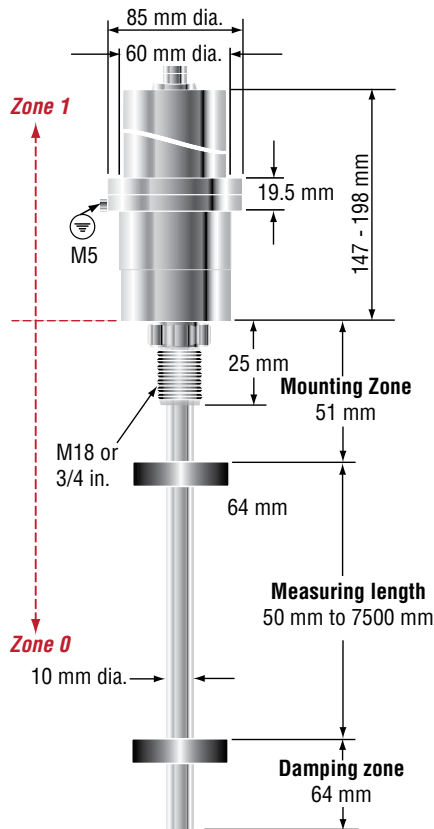

Figure 1. HPH Sensor and housing dimension references

DIMENSIONS, TOP MOUNTED CABLE GLAND

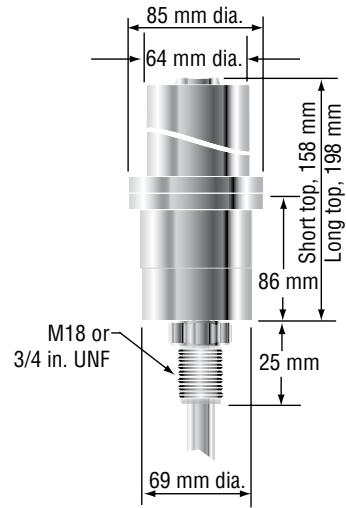

Figure 2. Top mounted cable gland

DIMENSIONS, SIDE MOUNTED CABLE GLAND

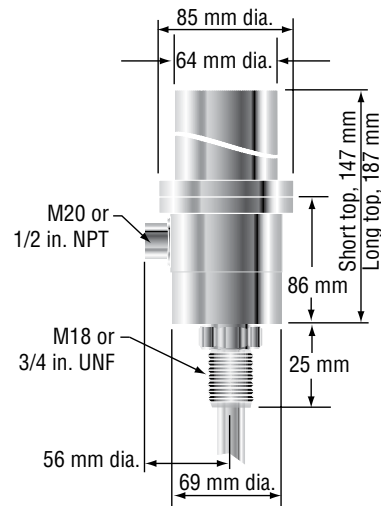

Figure 3. Side mounted cable gland

High Pressure
Housing

**Industrial Product Accessory, High Pressure Housing
Selection Chart, Design Combinations**

Design Combination chart

HIGH PRESSURE HOUSING DESIGN COMBINATION SELECTION CHART

Notes:

1. ATEX approved models are manufactured in Denmark.
2. UL and cUL approved models are assembled in USA.
3. Contact factory for custom combinations.

Choose your high pressure housing from the 'HPH Design Combination Chart' below in 'Table 1'. HPH accessory options are described in 'Table 2'.

High Pressure Housing











TYPE	STANDARD		SPECIAL ORDER IN QUANTITIES	STANDARD	SPECIAL ORDER IN QUANTITIES	
BOTTOM						
TOP	M18	3/4" UNF	M18	3/4" UNF	M18	3/4" UNF
APPROVAL	ATEX ONLY		ATEX ONLY	UL AND cUL	ATEX ONLY	UL AND cUL
	0100	0600				
			0900	1000	1300	1400
	0300	0800				
					2100	2200

Table 1. HPH Design Combination Chart

High Pressure Housing Accessories

HPH ROTATION ADAPTER

The Rotation adapter accessory (see 'Figure 4') allows you to adjust the position of the side opening when the HPH is mounted in a cylinder. Part No. 253961 is for use with the 3/4" UNF housing thread and has a 1 1/16 in. - #12 SAE Boss O-ring mounting thread.



Figure 4. Rotation adapter (Part no. 253961)

Item	Description	Summit item number
M20 x 1.5 Cable gland	ATEX, 4-8.5 mm cable diameter, stainless steel	CG-816679
M20 x 1.5 Cable gland	ATEX, 8.5-16 mm cable diameter, stainless steel	CG-816609
Nut for flange	316 L Stainless steel	M18 x 1.5
Spanner tool	(2 required)	HPHX-Series 100
Connector, straight exit	Female, 6-pin DIN, straight exit with 10 m cable	HPH6DIN/10MKFPUR25
HPH Rotation Adapter	Use with M18, and M30 x 1.5	RTA-M18
HPH Rotation Adapter	Use with the 3/4 in. UNF housing thread and has a 1 1/16 in. - #12 SAE Boss O-ring mounting thread	253961

Table 2. HPH accessory options

Ordering Information

USE THE FORM BELOW TO ORDER A HIGH PRESSURE HOUSING

(Accessories described in 'Table 2' are ordered separately)

Refer to the example below when placing your order. Approved short housing with M18 mounting threads and one side mounted cable gland with M20 threads and a measuring length of 650 mm:

Example:
HPH-0900-0650-A

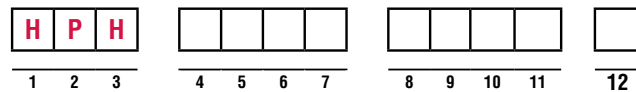

CHOOSE A DESIGN COMBINATION FROM THE DESIGN COMBINATION CHART (4-7) _____ = **4 - 7**

Refer to 'Table 1. HPH Design Combination Chart'.

ENTER MEASURING LENGTH (8-11) _____ = **8 - 11**

Refer to 'Figure 1. HPH Sensor and housing dimension references'.

Order in millimeters using 5 millimeter increments

ENTER VERSION (12) _____ = **12**

- A** = Approved version
- N** = Non approved version

High Pressure Housing