

MicroE Systems

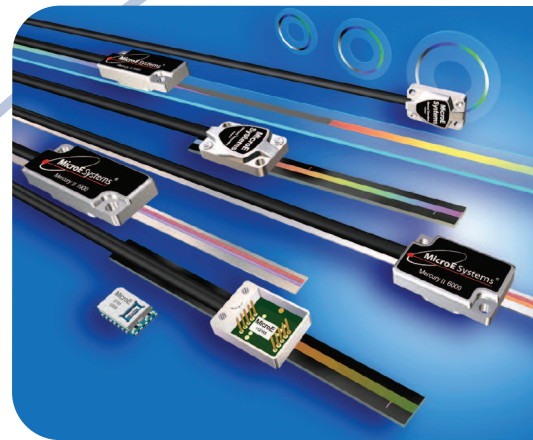

High-Performance Encoders
smaller. faster. smarter.

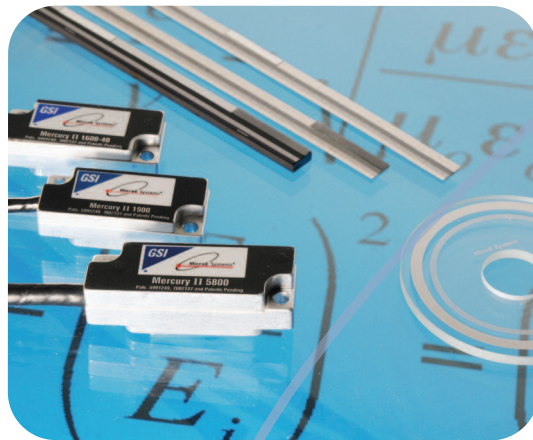

Encoder Innovation Starts Here.

Performance & Value Encoders

OPST™/MTE™Pages 6–7
Industry-leading combination of performance and value; all electronics in the sensor.

High-Performance Encoders

Mercury II™Pages 8–9
High resolution and accuracy with programmable features.

Compact Encoders

Mercury™ and ChipEncoder™.....Pages 10–11
Smallest sensors with high resolution and accuracy.

High Vacuum Encoders

Mercury™ and Mercury II™Page 12
The industry's most compact high vacuum encoders; high resolution and accuracy.

Micro Motion Absolute™Page 13

Absolute after a small initial move; available surface-mount compact sensors.

Advanced Engineered

OEM SolutionsPage 14
Performance and cost optimized solutions for OEM's.

Ultra-Performance Encoders

Ultra™.....Page 15
Ultra-high resolution, accuracy and speed for the most demanding applications.

Packaged Encoders

DRC™Page 15
Sealed rotary encoders with integral bearings; rugged and reliable.

Products for Data StoragePage 15

Ultra-high performance positioners, encoders and servo control for Data Storage applications.



MICROE SYSTEMS **World-Leader in High-Performance Encoder Technology**

MicroE Systems was founded in 1994 to advance encoder technology. Seizing the trend toward smaller motion systems, our patented optical designs have led to over 30 different encoder models today. These innovations make encoders that achieve higher accuracy and speed while also being smaller, easier to install, and use less power. That's why so many OEMs are putting our encoders in their designs. Due to robust sales growth, we have made extensive investments in our manufacturing operations: a new, larger facility in 2008; use of lean manufacturing and six-sigma principles to achieve rapid response to customer orders while achieving superior quality; tight controls on cleanliness and ESD on the shop floor; and the training and quality systems to be ISO 9001:2008 and ISO 13485:2003 certified.

PRODUCTS **The Latest Technologies and State-of-the-Art Products**

MicroE Systems builds encoders and servotrack writing subsystems for one of the world's most leading-edge industries: data storage. In fact, most hard-disk drives manufactured throughout the world today are made using MicroE Systems' technology. Plus, we build the most widely used encoders for sub-micron compact motion systems—Mercury™ encoders. Add to that our growing range of Mercury II™ encoders and tape scale solutions. These successes stem from our ongoing R&D commitment to create more accurate, faster, smaller encoders.

PERFORMANCE **Resolution and Stability at an Incredible Value**

MicroE Systems' encoders are renowned for their small size, ease of setup and features. But more customers are also discovering their world class performance—lower cyclical error for better velocity control, accuracy to $\pm 1 \mu\text{m}$, and resolution that's stable up to 1.2nm. All of this performance comes from a 20 μm -pitch encoder system that's a fraction of the cost of 4 μm and 2 μm pitch encoders—now that's value.

COMMITMENT **Flexible Delivery and a World-Wide Support Network**

Customization and Technical Support At MicroE Systems, we recognize the importance of customization. Many applications require a specific cable length, connector, or pinout. Our manufacturing processes make your "customized" part just like a standard assembly. You get encoders that exactly match your application, with the reliability, quality, and responsive lead times you would expect with standard products.

Motion system customers require fast, effective support and that's where our Odyssey™ program comes in. Engineered to support customers during each of four critical product development phases, we support you from over 30 direct sales and sales partner locations.

Flexible Delivery Modern OEM customers must have their orders filled in 1–2 weeks with little forecast visibility. MicroE Systems has professional supply chain management, world-class quality systems, and a linear manufacturing process specifically designed to fill new OEM orders rapidly. Product designs that are modular and configurable complete the story, making MicroE Systems one of the most responsive suppliers you can specify.

Quality and Reliability Engineered in from the Start Encoder applications require the highest levels of reliability. That's why we perform so many tests during product development—design validation testing, environmental robustness, EMI immunity, mechanical shock, and a host of further tests. We manufacture in the USA to the highest quality standards in compliance with ISO 9001:2008 and ISO 13485:2003, and our encoders are CE and RoHS compliant.

INNOVATIVE ENCODER SYSTEMS

Delivering Performance and Value

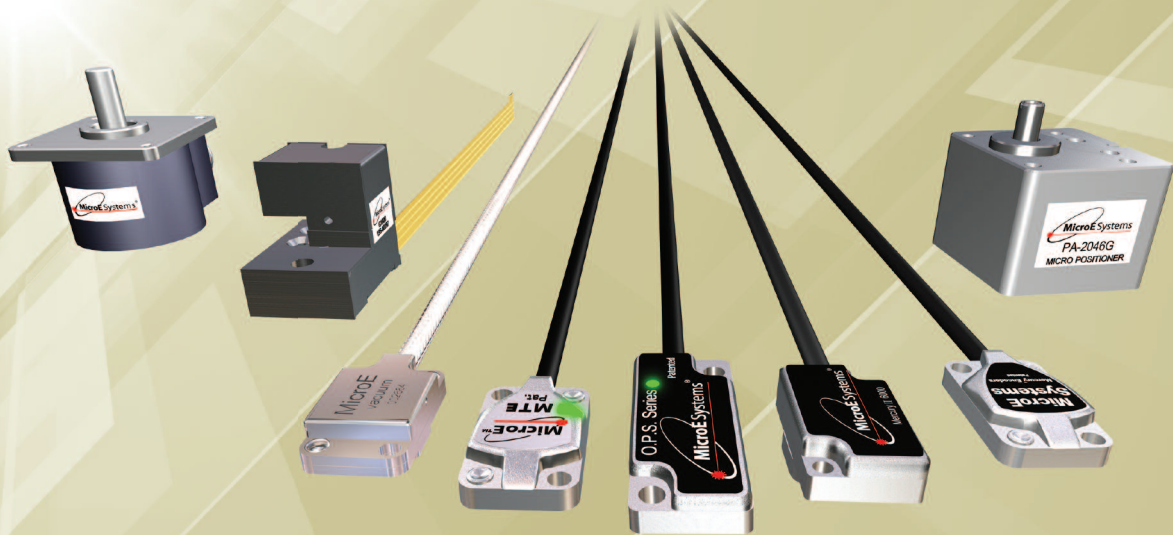

INTRODUCTION

Superior performance. World-class reliability. Responsive support and delivery. Focusing on what customers want most is why MicroE Systems is growing so quickly and introducing new products faster than any other encoder company. With a growing product line of over 30 models to match your specific application requirements, and direct sales and distributor offices in 13 countries, we give you a world of encoder solutions.

MicroE Systems' Technology: Creating the Best Encoders

It takes a powerful combination of an advanced optical system, signal processing technology, and state-of-the-art optoelectronic integration to make industry-leading encoders. And that's just what MicroE Systems has done, achieving many industry firsts:

- First 1.2nm resolution encoder with all electronics in the sensor
- First 20 μ m encoder with cyclical error of only ± 20 nm
- First PC Board-mount encoder with 78nm resolution
- First sub-micron encoder with $\pm 2^\circ$ setup tolerance
- First encoder with one sensor for tape or glass, linear or rotary
- First encoder with user-programmable settings and software
- First stick-on index and limits

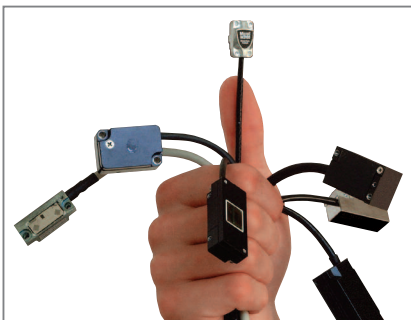

PurePrecision™ Optics Gives Mercury the Sensor Size Advantage

MicroE Systems' patented sensor creates a high-fidelity signal with very compact optics. The result is a miniature, high-performance sensor that's just 8.4mm tall, weighing only 5 grams.



PurePrecision™ Optics – Faster Setup, Better Accuracy

Our PurePrecision optical layout gives our sensors the widest alignment tolerances in the industry: $\pm 150\mu$ m in the Z axis and $\pm 2^\circ$ for theta Z. That's 300% better than competing encoders, and that means faster setup and better long-term motion system reliability. High signal quality means better accuracy – cyclical error as low as ± 20 nm – and interpolation that provides up to 1.2nm of resolution.

Sold & Serviced By:



Toll Free Phone (877) SERV098

Toll Free Fax (877) SERV099

www.electromate.com

sales@electromate.com

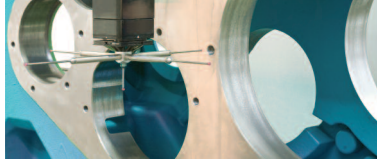

PRODUCT RANGE OVERVIEW

From ultra-performance encoders with world leading accuracy, to linear and rotary encoders for a wide range of motion control, automation and metrology applications, MicroE Systems has always focused on technologies that advance motion control to the next level of performance and value. Here is our product range.

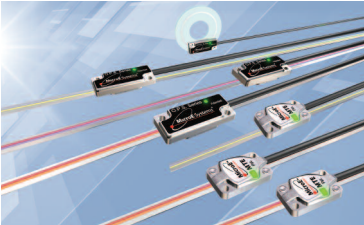

Performance & Value Encoders

Incremental encoders that set a new standard for performance and value. Perfect for a wide range of motion control applications. Linear or rotary. Resolutions from 5µm to 50nm linear, up to 3.3M CPR rotary. Cyclical error only ± 40nm. Measuring lengths up to 30m using tape scales. Digital output. LED in the sensor shows encoder status at all times. All electronics, including interpolation, in the sensor. Optical index and left/right optical limits. Available software.

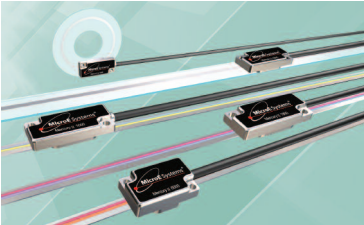

High-Performance Encoders

Incremental encoders with high performance and outstanding value for a wide range of motion control applications. Linear or rotary. Resolutions from 5µm to 1.2nm linear, up to 268M CPR rotary. Cyclical error as low as ± 20nm. Measuring lengths up to 30m using tape scales; accuracy up to ± 1µm using glass scales. Digital, analog, or high-speed serial output. Models with all electronics in the sensor. Models with left/right limits and programmable features. Available software.

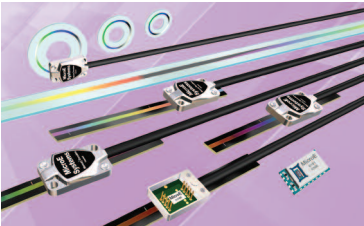

Compact Encoders

Incremental encoders with the smallest sensors for compact motion control applications. Screw-mount with cable or mount directly on your PC board. Linear or rotary. Resolutions from 5µm to 5nm linear, 6k to 67M CPR rotary. Measuring lengths up to 2m using glass scales; accuracy up to ± 1µm. Digital, analog, or high-speed serial output.

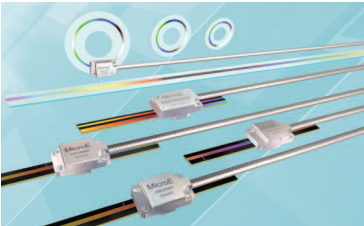

High Vacuum Encoders

Incremental encoders with small vacuum-rated sensors for motion control applications in vacuum. Linear or rotary. Resolutions from 5µm to 1.2nm linear, 6k to 268M CPR rotary. Measuring lengths up to 2m using glass scales; accuracy up to ± 1µm. Digital, analog, or high-speed serial output. Rated up to 10⁻⁸ torr.

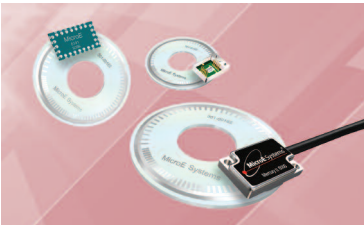

Micro Motion Absolute™

Absolute rotary encoders with compact sensors and optical encoder performance. Absolute position after initial movement of 4° – 7°. Resolutions from 5k to 20M CPR. High speed serial digital output.



Advanced Engineered OEM Solutions

If your system performance requirements demand a customized encoder solution, MicroE has the products and the resources to respond quickly and effectively. Our custom solutions for the OEM extend over a broad range – from modified standard encoders, to solutions that involve applications engineering, custom signal processing electronics, custom scales, and more.



Toll Free Phone (877) SERV098
Toll Free Fax (877) SERV099
www.electromate.com
sales@electromate.com

OPS™ Encoders/MTE™ Encoders

Excellent Performance and Value

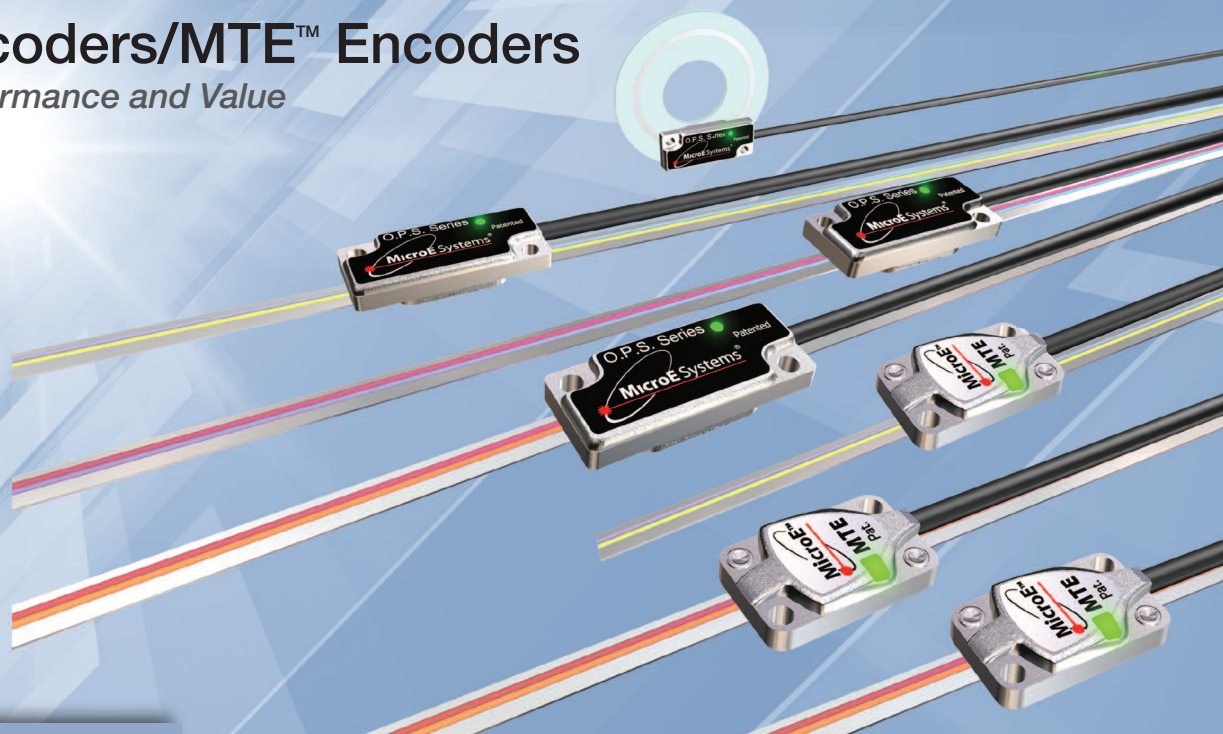

OPS OVERVIEW

OPS Encoders set a new standard for performance and value, enabling OEM's to affordably improve precision, accuracy and quality. Compatible with fast-installing tape scales up to 30m long, as well as rotary glass scales, OPS Encoders offer outstanding performance in a wide range of applications. All electronics are in the sensor, including high-speed interpolation. Factory-set resolutions are 1µm, 0.5µm, 0.1µm or 50nm. Dual optical limits enhance system safety while reducing cabling. The status LED built into the sensor is easy to notice even when installed in complex OEM systems, and indicates encoder status in real time.

OPS PERFORMANCE

OPS's encoder technology achieves the highest resolution and accuracy in its class, with low cyclical error, low jitter and low power consumption.

Model	Resolution	Output	Maximum Speed	Scales
OPS 400	50nm	Digital	1.5m/s	Linear Tape or Rotary Glass
OPS 200	100nm	Digital	3.0m/s	Linear Tape or Rotary Glass
OPS 40	0.5µm	Digital	4.5m/s	Linear Tape or Rotary Glass
OPS 20	1.0µm	Digital	4.5m/s	Linear Tape or Rotary Glass

Accuracy	Cyclical Error*	Linearity
With Tape Scale (Linear)	± 40nm	≤ ± 5µm/m**
With Glass (Rotary)	0.24µrad	± 19µrad†

*OPS Series accuracy over any 20µm movement

**Over any one meter of travel after slope correction in the customer's controller

†Based on ideal mounting concentricity

MTE OVERVIEW

The Micro Tape Encoder is MicroE Systems' latest tape scale product offering. A patented optical detector design allows the MTE series of encoders to offer the small sensor size and industry leading alignment tolerances that are expected from MicroE Systems with the added benefits of a status LED in the sensor and the convenience and ease of installation of a metal tape scale. The tri-color status LED provides installation guidance without the need for external alignment tools or oscilloscopes and an active system health signal that the customer can monitor in operation. The MTE encoder is available in factory set resolutions of 5µm, 2.5µm, or 1µm.

MTE PERFORMANCE

Optical encoder performance – 1.0µm resolution, 7.2m/s maximum speed, and bi-directional index window. Status LED and wide alignment tolerance allow easy installation and setup.

Model	Resolution	Output	Maximum Speed	Scales
MTE 20	1.0µm	Digital	7.2m/s	Linear Tape
MTE 8	2.5µm	Digital	7.2m/s	Linear Tape
MTE 4	5.0µm	Digital	7.2m/s	Linear Tape

Accuracy	Linearity
With Tape Scale (Linear)	≤ ± 8µm/m***

***Over any one meter of travel after slope correction in the customer's controller

Sold & Serviced By:



Toll Free Phone (877) SERV098

Toll Free Fax (877) SERV099

www.electromate.com

sales@electromate.com



Performance & Value Encoders



Performance & Value Encoders • OPS™ Encoders/MTE™ Encoders

FEATURES & TECHNOLOGY



Built-In Status LED

Tri-color LED shows encoder status at a glance. You can confidently know that the encoder is powered and working properly.

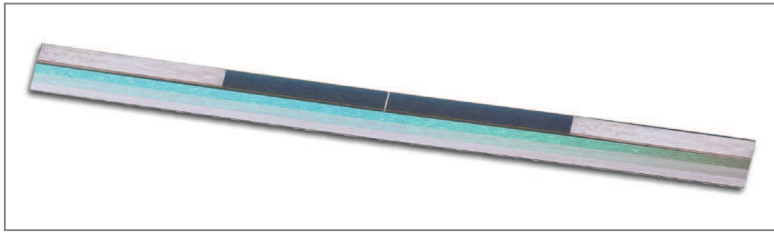

Fast-Installing Tape Scales

Tape scales are available with pre-printed optical index and limits for one-step installation.

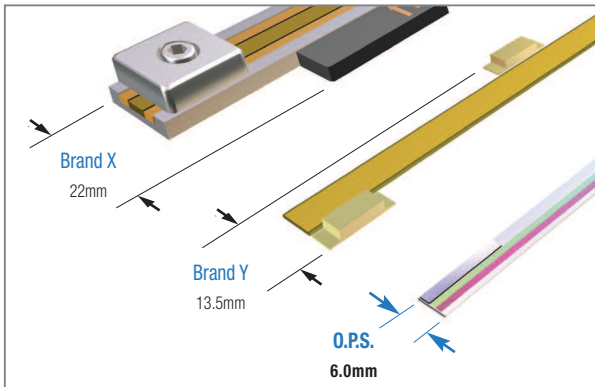

Compact Tape Scale System

The dual optical limits and index fit within the 6mm width of the tape scale – less than half the width of others.

TAPE & GLASS SCALES

PurePrecision™ Scales—Easy Installation, Superior Performance

OPS Series' low cyclical error surpasses every other 20µm encoder. The benefits are smoother velocity control for linear motors, stages and wire bonders; more precise, faster linear positioning; and more.

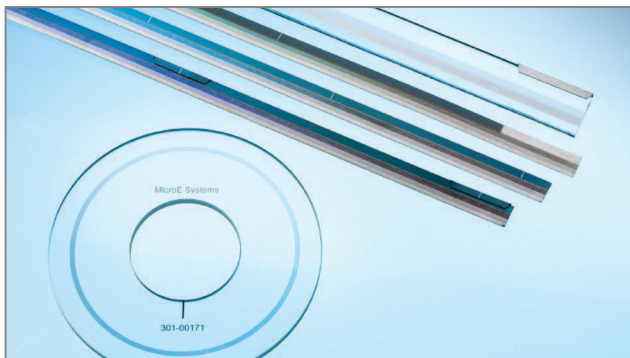

Tape Scales (OPS and MTE Series)

PurePrecision tape scales are easy to install and use. Cut it to any length you need from a coil, or order pre-cut lengths with built-in index and limits to make installation even faster. Its adhesive backing makes application easy and accurate.

- Measuring length up to 30m
- MTE: Choose Compact Encoder Tape (CET™) with built-in optical index for fast, one-step installation
- OPS: Use Marker Tape II with built-in index and limit markers, or cut-to-length Laser Tape II with place-anywhere stick-on optical index and limit markers

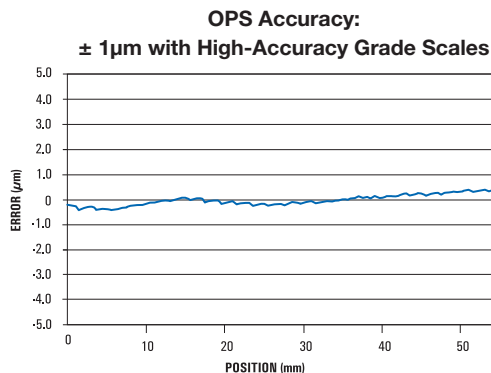

Glass Scales (OPS Series Only)

Use linear glass scales for the highest accuracy and precise thermal management. Rotary glass scales are available with or without hubs, and in arc segments.

- Measure length: up to 1m
- Rotary accuracy: ± 3.9 arc-sec with 64mm OD scale
- Custom options: special widths, thicknesses, near-zero CTE materials, diameters, or rotary arc segments

Mercury II™ Encoders

Superior Performance, World-Class Reliability

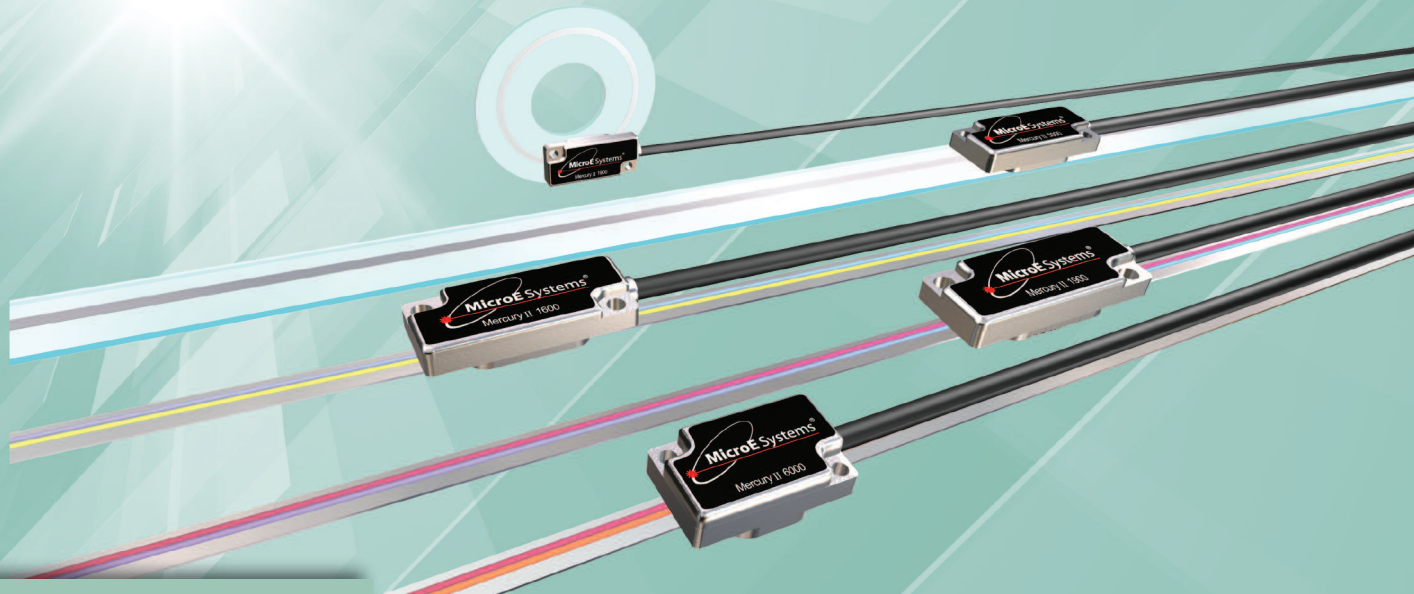

OVERVIEW

MicroE Systems revolutionized encoder technology with the original Mercury™ encoder family. Smaller, faster, and smarter than anything before, it set the standard for innovation. Now, with our expanding line of High Performance Encoders, the Mercury II™ series, we

take another giant step forward by giving you all this, plus more performance, tape scales, dual limits, and more. Comprehensive testing and manufacturing to ISO 9001:2008 quality standards makes for world class robustness and reliability. RoHS and CE compliant.

PERFORMANCE

Mercury II's encoder technology achieves the highest resolution and accuracy in its class, with low cyclical error, low jitter and low power consumption.

Model	Resolution	Output	Maximum Speed	Scales
Mercury II 6000	5µm – 1.2nm	Digital	10m/s	Tape or Glass; Linear & Rotary
Mercury II 5000	5µm – 1.2nm	Digital	10m/s	Tape or Glass; Linear & Rotary
Mercury II 1900	5µm – 1.2nm	Analog	7.2m/s	Tape or Glass; Linear
Mercury II 1600	5µm – 0.5µm	Digital	20m/s	Tape; Linear

Accuracy	Cyclical Error*	Long Travel
With Tape Scale (Linear)	± 30nm Typical	≤ ± 5µm/m**
With Glass Scales (Linear)	± 20nm Typical	High Accuracy Grade: Up to ± 1µm† Standard Accuracy Grade: ± 1.5µm†

*Mercury II 6000/5000 accuracy over any 20µm movement

**Over any one meter of travel after slope correction in the customer's controller

†See data sheets for full specifications

Mercury II Cyclical Error with Glass Scales

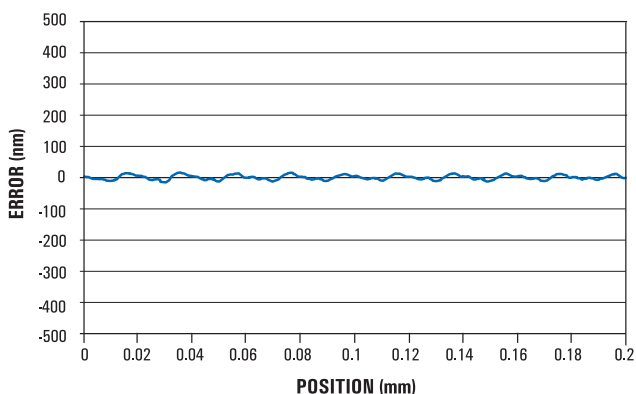

Mercury II Cyclical Error with Glass Scales

Mercury II's low cyclical error surpasses every other 20µm encoder. The result: smoother velocity control for linear motors and wire bonders, better linear positioning, and more.

Sold & Serviced By:



Toll Free Phone (877) SERV098

Toll Free Fax (877) SERV099

www.electromate.com

sales@electromate.com



High Performance Encoders



FEATURES & TECHNOLOGY



The Broadest Alignment Tolerances For Easy Setup

Wider alignment tolerances save installation time and allow proper encoder operation in equipment with high stack up tolerances.

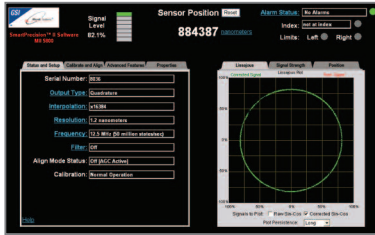

Insensitivity to Scale Contamination

The advanced optical design and Automatic Gain Control work together to achieve insensitivity to dust, fingerprints, etc.



Small Sensor for Faster, More Compact Motion Systems

Smaller sensors allow for reduced motion system size, lower moving masses, and faster, more precise positioning.

Integrated Sensor Design for Less Power Consumption, Smaller Sensors

Mercury II's patented optical system and integrated sensor design dramatically cut power consumption and sensor size.

	Mercury II 6000	Mercury II 5000	Mercury II 1900	Mercury II 1600
Power Consumption	0.90W*	0.90W	0.24W	0.24W
Sensor Height	8.2mm	11.0mm	8.7mm	8.7mm

*0.25 for sensor

TAPE & GLASS SCALES

PurePrecision™ Scales—Easy Installation, Superior Performance

Mercury II's low cyclical error surpasses every other 20µm encoder. The benefits are smoother velocity control for linear motors, stages and wire bonders; more precise, faster linear positioning; and more.



Tape Scales

PurePrecision tape scales are easy to install and use. Cut it to any length you need from a coil, or order pre-cut lengths with built-in index and limits to make installation even faster. Its adhesive backing makes application easy and accurate.

- Measuring length up to 30m
- Choose Marker Tape with built-in optical index and limit markers for fast, one-step installation or use cut-to-length Laser Tape with place-anywhere stick-on optical index and limit markers

Glass Scales

Use linear glass scales for the highest accuracy and precise thermal management. Rotary glass scales are available with or without hubs, and in arc segments.

- Measure length: up to 1m
- High accuracy: up to ± 1µm
- Custom options: special widths, thicknesses, near-zero CTE materials, diameters, or rotary arc segments

Mercury™ and ChipEncoder™

Compact Encoders with Incredible Performance

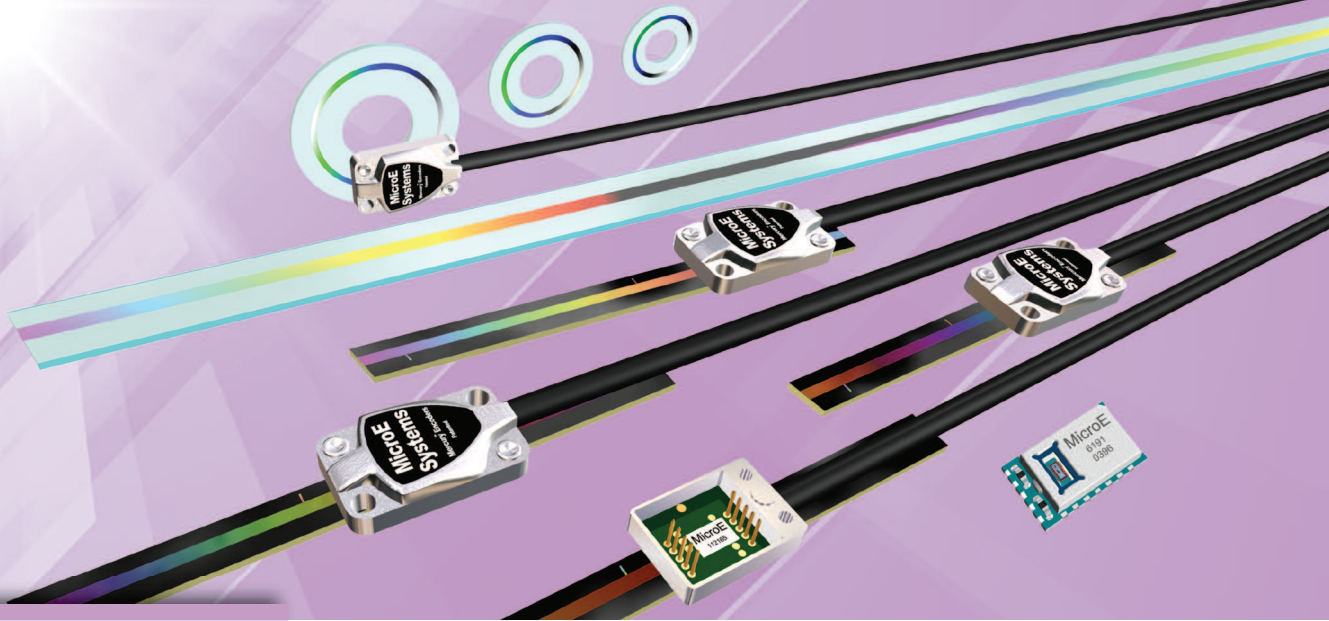

OVERVIEW

MicroE Systems introduced the Mercury series of compact encoders to help equipment designers achieve smaller and faster motion systems. Enabling many new applications, the Compact Encoders series has grown to 12 models due to an expanding range of applications requiring more resolution, speed, and even smaller sensors.

Motion control engineers around the world specify Mercury and ChipEncoder when their linear or rotary motion control applications demand high performance from the smallest possible sensor. Comprehensive testing and manufacturing to ISO 9001:2008 quality standards ensure long-term reliability. RoHS and CE compliant.

PERFORMANCE

Mercury and ChipEncoder technology achieves high resolution and low power consumption with the smallest possible sensors.

Model	Resolution	Output	Features	Scales
Mercury 3500	5µm–5nm	Digital	Programmable	Glass; Linear & Rotary
Mercury 1500	5µm–0.5µm	Digital	Digital from the Sensor	Glass; Linear & Rotary
Mercury 1000	5µm–78nm	Analog	1Vpp Output	Glass; Linear & Rotary
Mercury 1200	5µm–78nm	Analog	PCB Mount	Glass; Linear & Rotary
Mercury 1500P	5µm–0.5µm	Digital	PCB Mount	Glass; Linear & Rotary
ChipEncoder™	10µm–1µm	Digital	PCB Mount	Glass; Linear & Rotary

Accuracy	Long Travel
With Glass Scales (Linear)	High accuracy grade: up to ± 1µm [†] Standard accuracy grade: ± 3µm [†]

† See data sheets for full specifications

Model	Height	Weight	Power Consumption
Mercury 1200	5.6mm	2.6g	0.17W
Mercury 1500P	5.6mm	2.6g	0.17W
ChipEncoder™	3.1mm	0.6g	0.18W

Smaller Sensors for Smaller, Lighter Motion Systems

Mercury's patented optical system results in the most compact sensors in their class. Achieve low mass motion systems with more rapid accelerations and higher system throughputs using Mercury's 6mm wide linear scales, rotary scales as small as 12mm in diameter, low mass rotary arc segments, and sensors as small as 5.6mm high weighing only 2.6 grams. Plus, the same sensor models work in both linear and rotary applications.

Low power consumption—as low as 0.17 Watts—provides further advantages in thermal stability and for portable equipment.



Sold & Serviced By:

ELECTROMATE

Toll Free Phone (877) SERV098

Toll Free Fax (877) SERV099

www.electromate.com

sales@electromate.com



Compact Encoders



FEATURES & TECHNOLOGY

Dual-Axis Models

Mercury 3000 Dual Axis Averager models combine feedback from two sensors and average them in real time. The result is higher accuracy in rotary applications than can be achieved with one sensor – scale eccentricity errors are virtually eliminated. Outputs can be A-quad-B or high speed serial.

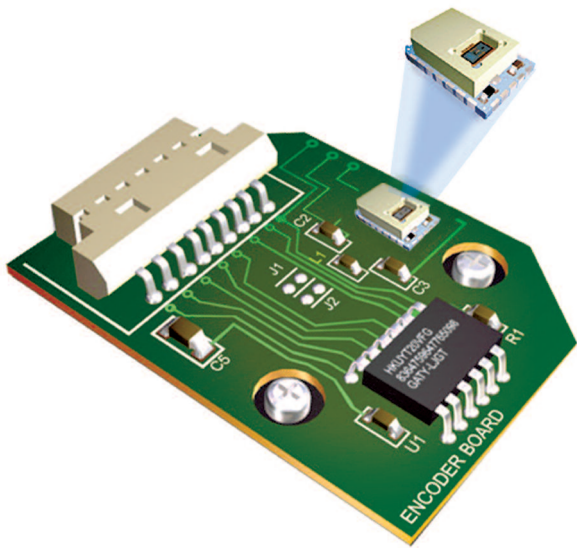
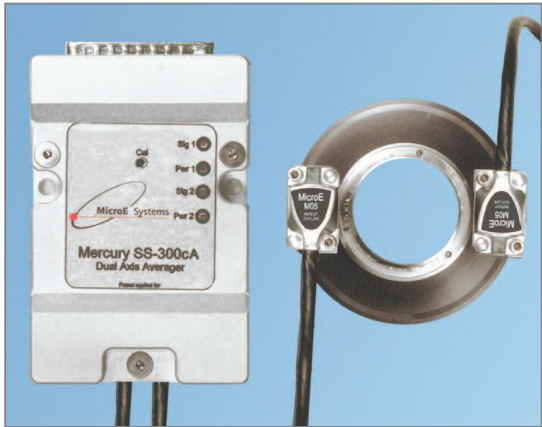

PC Board Mount

Mercury 1200, Mercury 1500P, and ChipEncoder models mount directly on your PC board, providing significant space and cost savings through design integration. Mercury 1200's analog outputs can be interpolated by your electronics, or with a chipset available from MicroE Systems for use on your PC board, for resolution up to 78nm (linear). Mercury 1500P and ChipEncoder have built-in interpolation that produces digital outputs with up to 0.5µm resolution (linear). All models work with rotary scales as small as 12mm diameter. And all this comes in the smallest packages.

SCALES

Wide Range of Scales

Linear and rotary glass scales are available in lengths from 13mm to 2m, and diameters up to 121mm. Rotary glass scales are available with or without hubs, and in arc segments.

- Linear measuring length as small as 13mm
- Accuracy up to $\pm 1\mu\text{m}$
- Compact: Only 6mm wide, including the built-in index (applications $\leq 130\text{mm}$)
- Rotary diameter as small as 12mm
- Custom options: Special widths, thicknesses, near-zero CTE materials, diameters, or rotary arc segments

Linear Standard Lengths

13mm
25mm
50mm
75mm
100mm
125mm
150mm
2020mm

Rotary Standard Outer Diameter

12.00mm	Yes
19.05mm	Yes
31.75mm	Yes
57.15mm	Yes
107.95mm	Yes
139.7mm	Yes

Rotary Hub Available

Rotary Segments

Arc Segment Radius: 6mm or greater

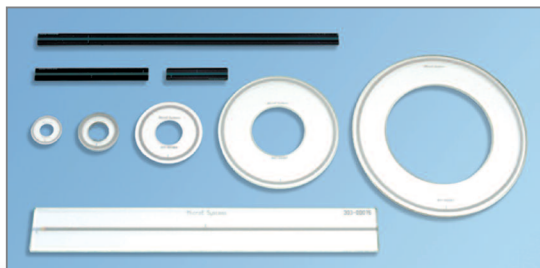

Mercury™ and Mercury II™

High Performance at High Vacuum with the Smallest Encoders

High Vacuum Encoders • Mercury™ and Mercury II™

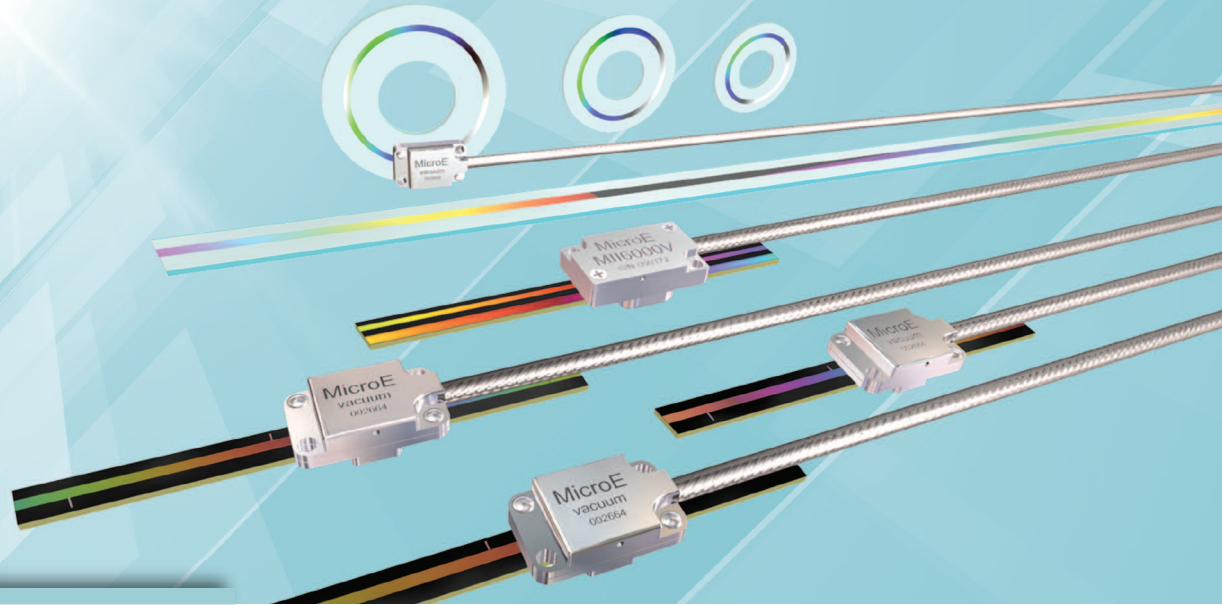

OVERVIEW

Mercury™ and Mercury II™ vacuum encoders are specified in a wide range of applications due to their combination of performance, small size, and high vacuum rating. Choose from models with programmable digital

output, analog output, or digital output right from the sensor, all constructed using vacuum-compatible materials rated up to 10^{-8} torr. All sensors can be used with linear, rotary and arc segment scales.

PERFORMANCE

Model	Resolution	Output	Features	Scales
Mercury II 6000V	5 μ m–1.2nm	Digital	Programmable	Glass; Linear & Rotary
Mercury 3500V	5 μ m–5nm	Digital	Programmable	Glass; Linear & Rotary
Mercury 2000V	5 μ m–78nm	Digital	Programmable	Glass; Linear & Rotary
Mercury 1000V	5 μ m–78nm	Analog	1Vpp Output	Glass; Linear & Rotary
Mercury 1500V	5 μ m–0.5 μ m	Digital	Digital from the Sensor	Glass; Linear & Rotary

Accuracy	Long Travel
With Glass Scales (Linear)	High accuracy grade: up to $\pm 1\mu$ m [†] Standard accuracy grade: $\pm 3\mu$ m [†] for Mercury I, $\pm 1.5\mu$ m [†] for Mercury II

[†] See data sheets for full specifications

High Performance in the Smallest Package

With sensors only 8.2mm tall, capable of resolutions up to 1.2nm and cyclical error of ± 20 nm, unsurpassed motion system performance is achieved in the most compact vacuum applications. Plus, thermal effects are minimized due to the low power consumption of Mercury encoder sensors — only 0.25W for most models. All models perform at 10^{-8} torr with negligible outgassing. Bake out is rated at 150°C for 48 hours. And Mercury and Mercury II vacuum encoders perform in high magnetic field environments.



SCALES

Wide Range of Scales

Vacuum-compatible linear and rotary glass scales are available in lengths from 13mm to 2m, and diameters up to 121mm. Rotary glass scales are available with or without hubs, and in arc segments.

- Linear measuring length as small as 13mm
- Accuracy up to $\pm 1\mu$ m
- Compact: Only 6mm wide, including the built-in index (applications ≤ 130 mm)
- Rotary diameter as small as 12mm
- Custom options: Special widths, thicknesses, near-zero CTE materials, diameters, or rotary arc segments

Micro Motion Absolute™

Absolute Position at Startup After a Small Movement

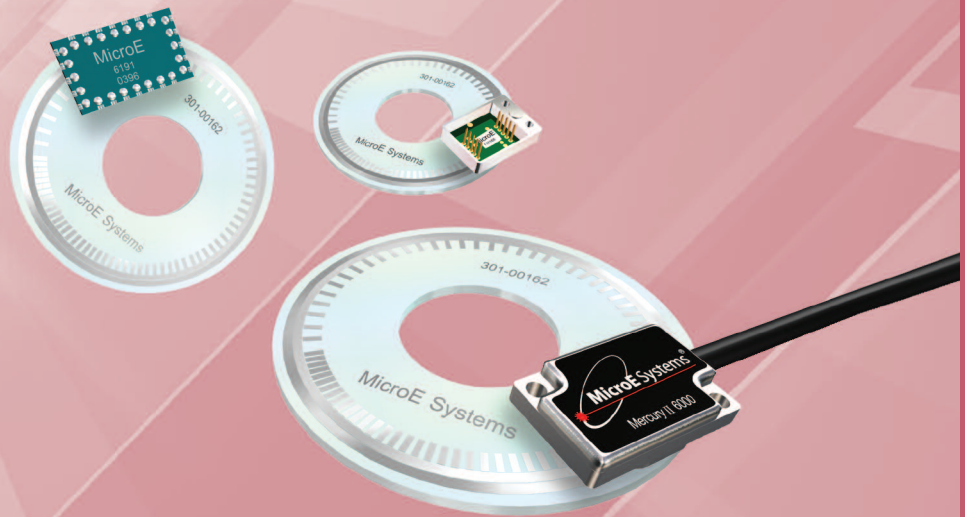

Micro Motion Absolute™

OVERVIEW

Micro Motion Absolute™ Rotary Encoders provide absolute position after powering up your system, even if motion occurred when power was off. Our Micro Motion Absolute™ technology uses a small initial rotary movement on power-up so that your controller will know the absolute position with certainty. You can quickly restart with confidence even when sensitive, valuable work pieces are in the motion system.

Micro Motion Absolute™ Rotary Encoders acquire absolute position from their pre-programmed absolute track. By putting absolute position marks at unique locations, as soon as the motion control system passes through a small rotation, typically 4° – 7°, your controller will have absolute position.

Position feedback is sent to the controller with BiSS or SPI high-speed serial formats using an FPGA in your controller

and software that is developed collaboratively with MicroE Systems. Single and multi-axis versions of the interface are possible.

Since Micro Motion Absolute™ Rotary Encoders are based on MicroE Systems' widely-used and proven optical encoder sensors, they have all of the benefits of our incremental encoders:

- High resolution, accuracy, and repeatability enables high precision motion feedback and servo control
- Small sensors, including models that can fit into the most compact spaces
- PC board mount-sensors, as small as 7mm x 11mm, that can fit onto a small PC board of any shape
- Low power consumption – low as 0.3W
- Reliable long-life operation

FEATURES & TECHNOLOGY

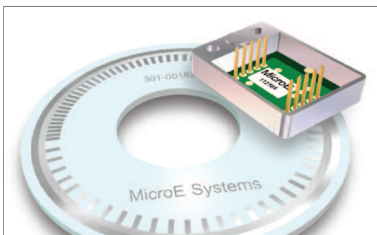

Mercury 1500P-MMA

- Resolution = 10,000 to 100,000 CPR using 18mm OD scale
- PC board mount
- Option for screw-mount sensor with cable

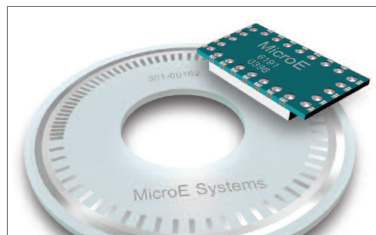

ChipEncoder CE300-MMA

- Resolution = 5,000 to 50,000 CPR using 18mm OD scale
- PC board mount – surface mount device
- Only 7mm x 11mm

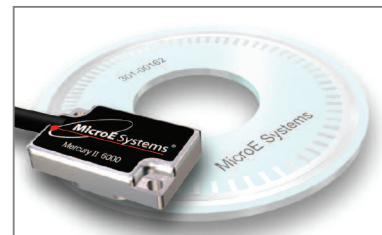

Mercury II 6000-MMA

- Resolution = 5,000 to 20M CPR using 18mm OD scale
- Small, screw-mount sensor with cable
- Highest accuracy and resolution

Sold & Serviced By:

 **ELECTROMATE**

Toll Free Phone (877) SERV098
Toll Free Fax (877) SERV099
www.electromate.com
sales@electromate.com

Advanced Engineered OEM Solutions

OVERVIEW

If your system performance requirements demand a customized encoder solution, MicroE has the products and the resources to respond quickly and effectively. Our custom solutions for the OEM extend over a broad

range – from modified standard encoders, to solutions that involve applications engineering, custom signal processing electronics, custom scales, and more.

ADVANCED RCR TEAM OEM SOLUTIONS

We also offer advanced solutions for higher volume OEM's. These solutions are developed with our Rapid Customer Response (RCR) Team in conjunction with a key group of consulting engineers from our staff. Advanced RCR solutions include the following:

- Custom PCB design for ChipSets, ChipEncoder™, and application specific motion control
- Repackaging of SmartPrecision™ Electronics to support different form factors and multiple axes
- Modification of sensors for high bandwidth applications, different CTE, custom form factor, and finishing options
- Application specific product solutions such as the averaging devices and multi-axis interpolation
- Advanced subassembly integration and qualification
- Custom software based on our SmartPrecision Software platform including counters, drivers, DLL's, etc.
- Virtual absolute encoder solutions

- High bandwidth analog sensors (up to 2Mhz)
- High resolution analog sensors (picometer resolution)
- Custom electrical outputs: Biss, SPI, SSI, 12C, etc.
- Opto-mechanical design
- Analog and digital electronics design and layout
- Firmware development

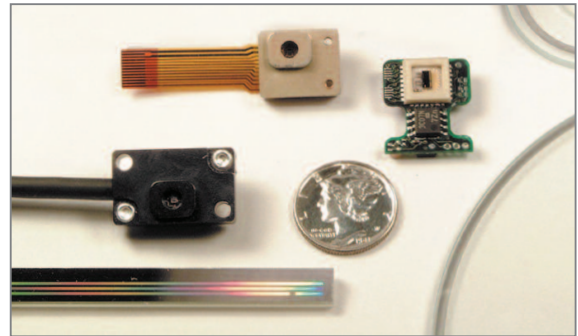

TRADITIONAL RCR TEAM SERVICES

MicroE Systems' Rapid Customer Response Team (RCR) provides custom prototype solutions with the shortest possible lead-times. This may include a standard MicroE product modified for your application, or a full-custom design.

- Optional glass materials for CTE considerations, IE: quartz and Zerodur™
- Custom scales with optimized travel length, modified dimensions, or index locations
- Custom rotary scales with special dimensions, IE: large through holes, large OD's, arc segments, and much more
- Custom cables lengths and connectors for atmospheric, vacuum, and even non-magnetic applications
- Custom grating holders
- Grating mounting/centering and consultative services

- Custom sensor bracket design and manufacture
- Software interfacing, including OEM embedded solutions
- Consultation for connecting a Mercury™ encoder to customer controller and/or quad counter
- Motion control sub assembly design and integration

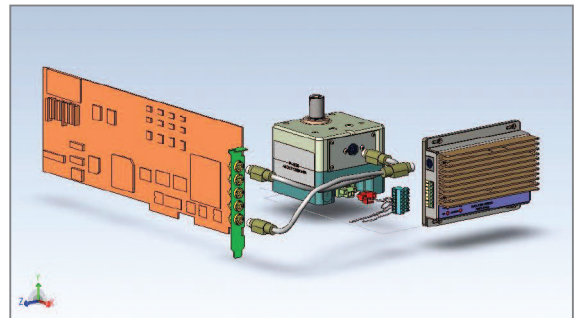

Ultra™ Encoders

Highest Possible Accuracy or Speed

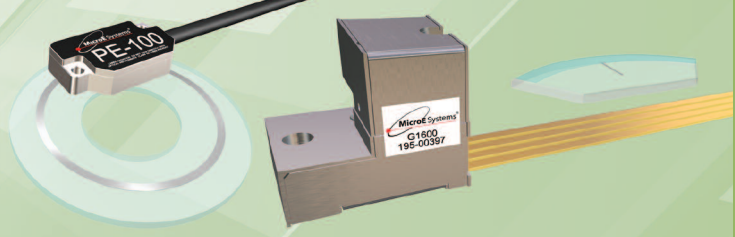

OVERVIEW

Designed for the ultimate in performance, G1600 Series and PE-100 incremental rotary encoders achieve unprecedented levels of useable resolution, minimal cyclical error, and rotational speed.

PERFORMANCE

Model	Resolution	Output	Features	Scales
G1600	0.94nrad	Analog	Accuracy up to ± 20 nrad and 3nrad RMS	Rotary Glass
PE-100	N/A	Analog	Speeds up to 20,000 RPM with high S/N	Rotary Glass

G1600 Series

- Patented optical system achieves superior accuracy: ± 20 nrad and 3nrad RMS
- G1600 resolution: 0.94nrad with 104.3mm scale
- G1650 resolution: 1.5nrad with 65.25mm scale
- Supports perpendicular writing technology
- G1600: Kit encoder for new media writing applications
- G1650: Drop-in replacement for the MP 7000 and PA 2000 Series

PE-100

- Use with air bearing spindles for velocity control up to 20,000 RPM
- Index performs at full speed

DRC™ Encoders



OVERVIEW

Based on decades of field-proven reliability and performance, DRC incremental encoders are well known for fast and easy installation using industry-standard mechanical and electrical interfaces. Choose from sealed or kit-style rotary encoders, kit-style linear encoders, or sealed linear length gages featuring:

- Optical encoder technology with LED light source for long life and highest performance
- Differential digital outputs with available zero reference
- Custom versions available for OEM applications
- Sealed Rotary Shaft and Hollow Shaft Encoders
- Rugged, reliable incremental rotary motor encoders

- Resolutions from 400 to 360,000 Counts per Rev., with a wide range of shaft/coupling sizes, mounting options, connector styles and cable lengths
- High accuracy, high temperature, high shaft load and extra high vibration-resistant models

Products

- 25D, 25B, S15, H15 and F15 Shaft and Hollow-Shaft Sealed Rotary Encoders; resolution up to 200,000 CPR
- HT30, T23B, and TK91 Kit-Style Rotary Encoders for Motors; resolution up to 100,000 CPR
- LDM Kit-Style Linear Encoders; resolution up to 0.5 μ m
- SST Sealed Linear Length Gages; resolutions up to 1 μ m

Data Storage Products

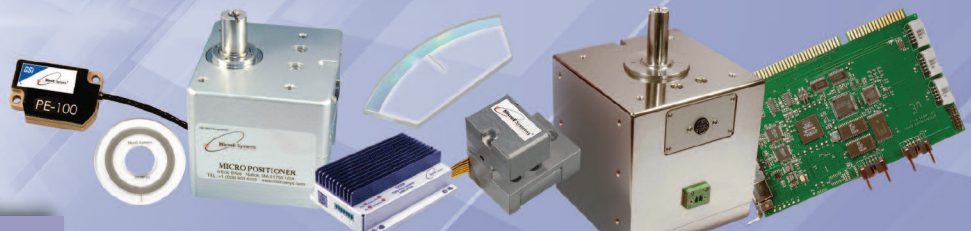

OVERVIEW

MicroE Systems has more than a decade of experience designing and manufacturing critical components and ultra-precision positioning systems for the data storage industry. Today we supply these components to the majority of hard disk drive (HDD) manufacturers around the world, enabling cost-effective manufacturing of HDD's with capacities exceeding 1TB.

Products

- G1400 and G1600 High Accuracy Rotary Encoders
- PE100 High Speed Rotary Encoders
- PA200G and PA2046G Rotary Positioners
- MP7000 Positioner for Media Writers
- MCB2 and SA200a Motion Control Subsystems

ENCODER SELECTION CHART

	Model	Features	Specifications*
 <p>OPS Micro Systems MTE</p>	<p>OPS™/MTE™ Pages 6–7</p>	<p>Performance & Value Encoders Industry-leading combination of performance and value; all electronics in the sensor.</p>	<ul style="list-style-type: none"> • Linear Resolution: 5µm – 50nm • Rotary Resolution: 163k to 3.27M CPR • Output: A-quad-B, Index Pulse, and Dual Limits
 <p>Micro Systems Mercury II 0500</p>	<p>Mercury II™ Pages 8–9</p>	<p>High-Performance Encoders High resolution and accuracy with programmable features.</p>	<ul style="list-style-type: none"> • Linear Resolution: 5µm – 1.2nm • Rotary Resolution: 20k CPR – 268M CPR • Output: A-quad-B, Index, Dual Limits and Alarm; High Speed Serial Interface, Analog Sin/Cos with Index
 <p>MicroE 5340 012</p>	<p>Mercury™ and ChipEncoder™ Pages 10-11</p>	<p>Compact Encoders Smallest sensors with high resolution and accuracy.</p>	<ul style="list-style-type: none"> • Linear Resolution: 10µm – 5nm • Rotary Resolution: 6.6k CPR – 67.1M CPR • Output: A-quad-B, Index, Dual Limits and Alarm; High Speed Serial Interface, Analog Sin/Cos with Index
 <p>MicroE vacuum 5260A</p>	<p>Mercury™ and Mercury II™ Page 12</p>	<p>High Vacuum Encoders The industry's most compact high vacuum encoders; high resolution and accuracy.</p>	<ul style="list-style-type: none"> • Linear Resolution: 5µm – 1.2nm • Rotary Resolution: 20k CPR – 268M CPR • Output: A-quad-B, Index, Dual Limits and Alarm; High Speed Serial Interface, Analog Sin/Cos with Index
 <p>Micro Systems</p>	<p>Micro Motion Absolute™ Page 13</p>	<p>Absolute Rotary Encoders Absolute after a small initial move; available surface-mount compact sensors.</p>	<ul style="list-style-type: none"> • Rotary Resolution: 5k CPR – 20M CPR • Output: A-quad-B, Index, Dual Limits and Alarm
	<p>OEM Page 14</p>	<p>Advanced Engineered OEM Solutions Performance and cost optimized solutions for OEM's.</p>	<ul style="list-style-type: none"> • Linear Resolution: 5µm – 1.2nm • Rotary Resolution: 0.94nrad • Output: A-quad-B, Index, Dual Limits and Alarm; High Speed Serial Interface, Analog Sin/Cos with Index
 <p>Ultra</p>	<p>Ultra™ Page 15</p>	<p>Ultra-Performance Encoders Ultra-high resolution, accuracy and speed for the most demanding applications.</p>	<ul style="list-style-type: none"> • Rotary Resolution: 20k CPR – 268M CPR • Output: A-quad-B, Index, Dual Limits and Alarm; High Speed Serial Interface
	<p>DRC™ Page 15</p>	<p>Packaged Encoders Sealed rotary encoders with integral bearings; rugged and reliable.</p>	<ul style="list-style-type: none"> • Linear Resolution: 10µm – 0.5µm • Rotary Resolution: 200 CPR – 360k CPR • Output: A-quad-B with Index
	<p>Data Storage Page 15</p>	<p>Products for Data Storage Ultra-high performance positioners, encoders and servo control for Data Storage applications.</p>	<ul style="list-style-type: none"> • Rotary Resolution: up to 4.68 nrad • Output: 2 semiarbitrary analog outputs

*Resolution, output and scale options vary by model.