

Sold & Serviced By:



Toll Free Phone (877) SERV098

www.electromate.com

sales@electromate.com

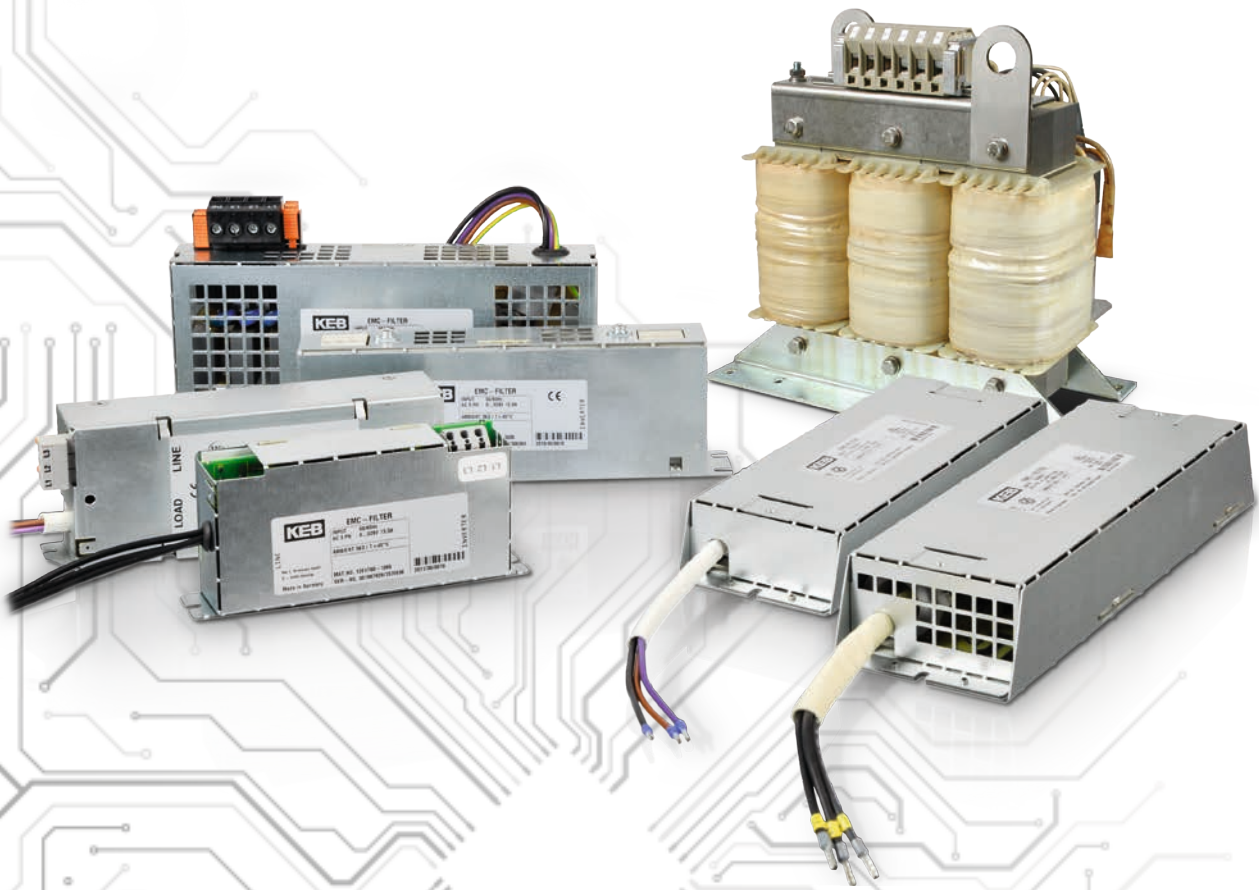

EMC COMBILINE

EMC SOLUTIONS

V - 1.0 EN



CONTENTS

PAGE

Introduction	EMC compatibility	4
Mains	Mains chokes	6
	Harmonic filters	8
	Standard HF filters	10
	Low-leakage current IT-HF filters	12
	Central HF filters, E6 series	15
	Comprehensive EMC services	17
	Motor	Motor chokes
	Sinusoidal filters	21
Combinations	NHF-filters	24
	I/O-filters	25

SYSTEM OVERVIEW

Automation with Drive

stands as a synonym for optimally selected combinations of control and automation solutions with the drive level at the end it is the key to successful machine concepts.

Let the following pages inspire you with regards to the diversity and performance of the EMC COMBILINE, and help you to find a solution that reliably meets your requirements.

SOFTWARE

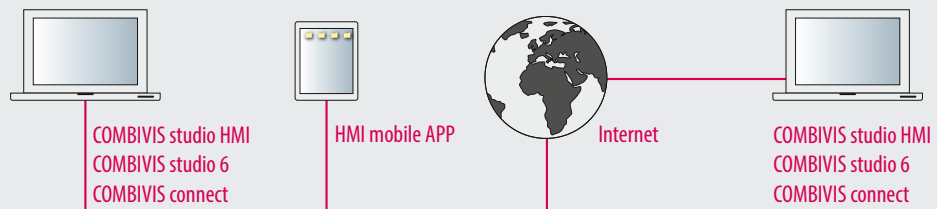

HMI

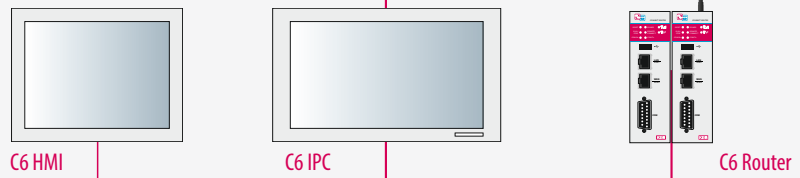

CONTROL

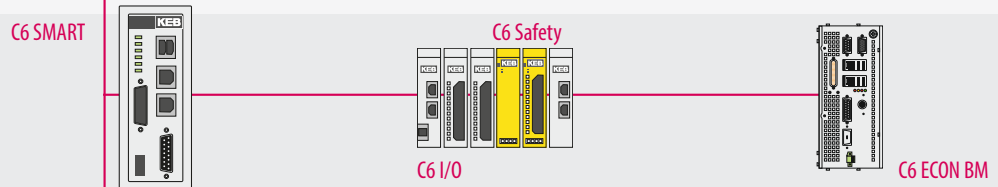

DRIVES

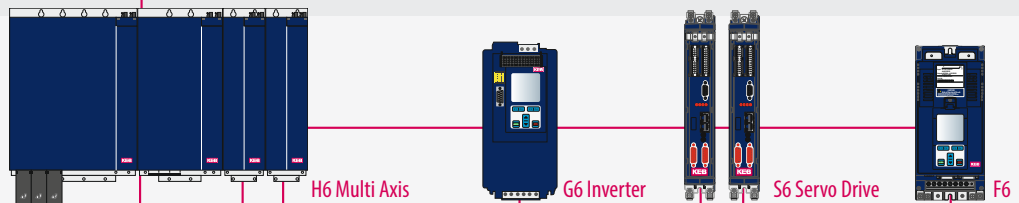

MOTORS

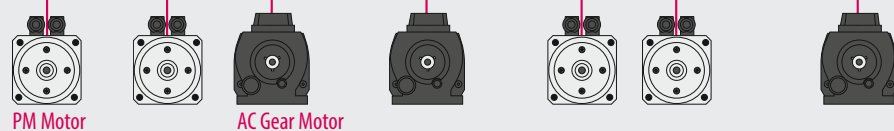

COMBILINE

EMC COMPATIBILITY

plays an important role in the operating safety of machines and equipment. Manufacturers and operators are required to implement the installed systems so as to achieve electrical compliance with the limits (for emissions) and requirements (for fault-free operations) set out in the standards and regulations!

To this end, the following standards must be applied as per the order below:

Product standard: This standard applies to an exactly defined application area that generally meets the special requirements of a product family.

Example: The so-called „power drives systems“ (PDS) (inverter and motor viewed in terms of a drive) belong to the product family standards EN 61800-x (-x). EN 61800-3 is the EMC standard.

Basic technical standard: This standard sets out the requirements for a specific environment.

Example: The EN 61000-6-x series applies to machine builders; it sets out the general EMC requirements for use either in a public low-voltage grid or an industrial grid.

EN 61000-6, -3 and -4 Emissions

EN 61000-6, -1 and -2 Emissions

Basic standard: This standard describes the measurement methods and instruments for the testing process itself, provides information on limits or minimum requirements without relating the same to a subsequent place of use. That is done by the basic technical standard. Basis for the EN 61000-4-x standards series.

KEB develops, produces and supplies a comprehensive range of interference suppression components for the mains- and motor-related optimisation of operating conditions. With the help of a mobile EMC on-site service, our measurements and advisory services can assist you in selecting the proper components and their application. Calibrated measurement instruments and the relevant software can be used to prepare documents that verify compliance with EMC requirements.

NOMENCLATURE

Electrical		Mechanical	
I_N	Nominal current	\emptyset	Wire size
P_V	Power loss, „calculated“	B	Total length from base
f_{Netz}	Mains frequency	H	Width from base
I_{ab}	Leakage current	H_1	Width from base - coil design or cable
P_{FU}	Nominal capacity drive controller [kW] or [HP]	T	Height from base - clamps
L	Inductance	$a_1 a_2 a_3 a_4$	Distance fastening holes
f_s	Switching frequency inverter	$d_1 d_2$	Diameter fastening holes
f_{max}	Maximum motor frequency	Cu	Copper portion
U_{max}	Maximum operating voltage	m	Total weight

Sold & Serviced By:



Toll Free Phone (877) SERV098

www.electromate.com

sales@electromate.com

The operation of variable-speed drives with intermediate voltage circuits puts stress on the mains and motor, which can be optimised with the following additional measures (depending on the place of use and type of application):

MAINS

Mains chokes reduce harmonics and in-rush current to the mains and increase the service life of components in the devices.

Harmonics filters reduce the harmonics resulting in sinusoidal current consumption without the voltage losses that occur with mains chokes.

- **HF filters** for high-frequency interference suppression of single and multi-axis systems
 - ✓ Standard
 - ✓ reduced leakage current
 - ✓ IT mains

MOTOR

- **Output chokes** for application areas up to 100 Hz (customer-specific solutions up to 1600 Hz)
- **Sinusoidal filters** create sinusoidal motor voltages and reduce motor losses. Available for output frequencies up to 100 Hz, 200 Hz, 800 Hz and 1600 Hz
- **Sinusoidal EMC filters** as a combination of sinusoidal filters with EMC level reduce symmetrical and asymmetrical interference and support compliance with statutory limits for installations without shielded motor cables (on request).

Combine as special all-in-one solution

- **NHF filters** combine the effects of EMC filters and mains chokes
- **I/O filters** combine the mains-side HF filter and motor-side du/dt filter in a functional assembly with reduced and space-saving installation requirements.

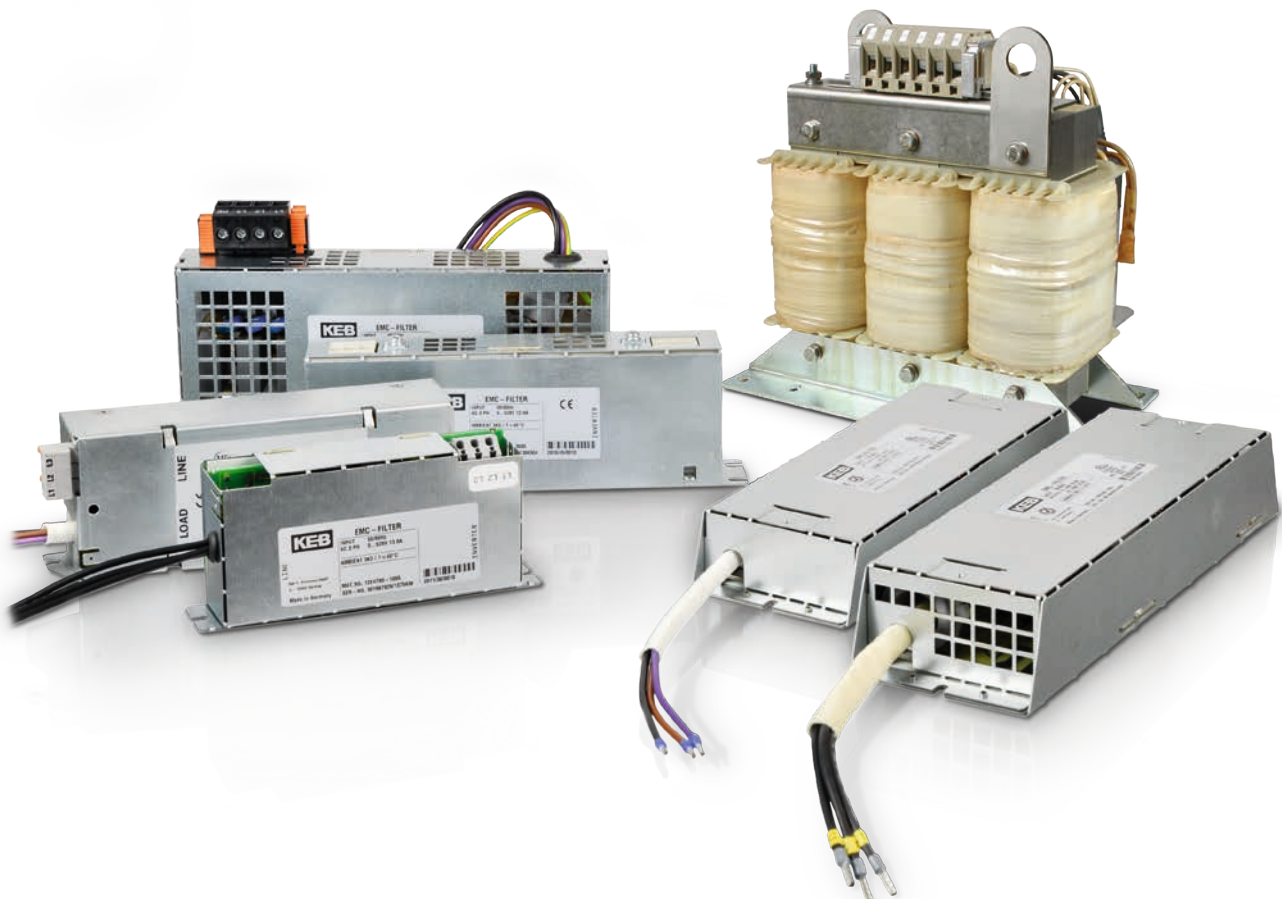

COMBILINE MAINS-SIDE

MAINS CHOKES

optimise the harmonics to the mains power supply which result from the pulse-shaped charging of uncontrolled rectifiers and reduce the effective input current.

This decrease in stress has the direct effect of significantly increasing the service life of the link voltage capacitors in inverters and servo drives and reducing the stress on the input rectifier.

Chokes for 1-phase or 3-phase units are universally designed for a frequency range of 45 - 65 Hz. Nominal inductance is determined by the 4 % short circuit voltage at nominal current and frequency.

With respect to the chokes, please ensure sufficient installation space to take into account higher heat emissions and a strong magnetic leakage field.

MAINS CHOKE 1-PHASE 230 V AC ($U_{max} = 264 V$), 50/60 Hz

Part-No.	I_N [A]	P_V [W]	f_{Netz} [Hz]	\emptyset [mm ²]	B [mm]	H [mm]	H_1 [mm]	T [mm]	a_1 [mm]	a_3 [mm]	d_1 [mm]	d_2 [mm]	Weight	
													Cu [kg]	m [kg]
05Z1B02-1000	6	9	45-65	4	60	47	53	80	44	36	3.6	7	0.1	0.5
07Z1B02-1000	10	9	45-65	4	85	59.5	65	89	64	46.5	4.8	9	0.3	1.4
09Z1B02-1000	16	15	45-65	4	85	60	65	89	64	50	4.8	9	0.3	1.5
10Z1B02-1000	20	15	45-65	16	85	60	65	89	64	50	4.8	9	0.3	1.5
12Z1B02-1000	25	18	45-65	16	85	60	65	89	64	50	4.8	9	0.4	2.6

MAINS CHOKE 3-PHASES 230 V AC ($U_{max} = 264 V$), 50/60 Hz

Part-No.	I_N [A]	P_V [W]	f_{Netz} [Hz]	\emptyset [mm ²]	B [mm]	H [mm]	H_1 [mm]	T [mm]	a_1 [mm]	a_2 [mm]	a_3 [mm]	d_1 [mm]	d_2 [mm]	Weight	
														Cu [kg]	m [kg]
05Z1B03-1000	2.4	15	45-65	4	100	54	54	120	80	-	39	4.8	8	0.1	0.8
07Z1B03-1000	4.2	20	45-65	4	100	54	54	120	80	-	39	4.8	8	0.2	0.9
09Z1B03-1000	7.4	26	45-65	4	100	54	54	122	80	-	39	4.8	8	0.4	1.1
10Z1B03-1000	10.5	28	45-65	4	100	63	63	122	80	-	47	4.8	8	0.5	1.5
12Z1B03-1000	17.3	52	45-65	4	148	67	67	145	136	-	47	4.8	8	0.7	2.0
13Z1B03-1000	25.2	55	45-65	16	148	77	77	145	136	90	58	4.8	8	0.8	3.7
14Z1B03-1000	34.7	59	45-65	16	148	77	77	145	136	90	58	4.8	8	1.1	5
15Z1B03-1000	50.4	88	45-65	16	178	90	90	175	166	113	69	4.8	8	1.8	5.8
16Z1B03-1000	69.5	110	45-65	M8	219	100	130	160	201	136	70	7	12	2.8	7.4
17Z1B03-1000	88.2	125	45-65	M8	219	110	140	170	201	136	80	7	12	3.3	9.6
18Z1B03-1000	105	136	45-65	M8	219	120	150	170	201	136	90	7	12	4.2	12.1
19Z1B03-1000	121	170	45-65	M8	243	115	155	180	225	156	85	7	12	4	12.2
20Z1B03-1000	152.3	185	45-65	M8	243	126	165	180	225	156	96	7	12	4.5	15
21Z1B03-1000	189	200	45-65	M10	267	133	173	202	249	176	82	7	12	7.1	21.6

For nomenclature, see Page 4

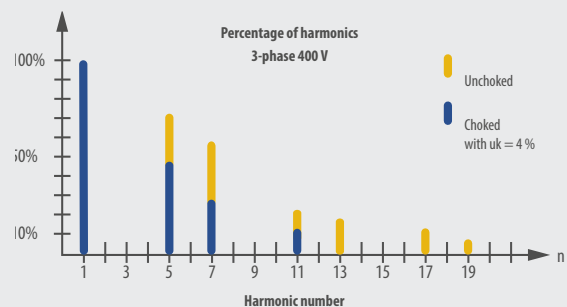
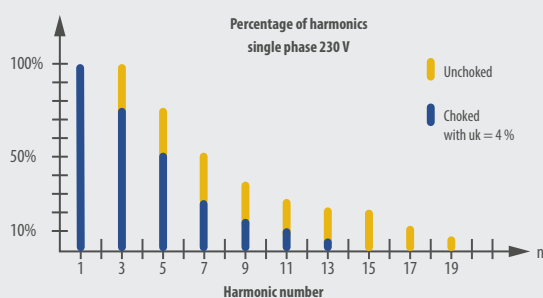

MAINS CHOKE 3-PHASES 400 V AC ($U_{max} = 550 V$), 50/60 Hz

Part-No.	I_N [A]	P_V [W]	f_{Netz} [Hz]	\emptyset [mm ²]	B [mm]	H [mm]	H_1 [mm]	T [mm]	a_1 [mm]	a_2 [mm]	a_3 [mm]	d_1 [mm]	d_2 [mm]	Weight		Fig.
														Cu [kg]	m [kg]	
05Z1B04-1000	1.4	10	45-65	4	100	55	55	121	80	-	40	4.8	8	0.2	0.8	1
07Z1B04-1000	2.7	19	45-65	4	100	55	55	121	80	-	40	4.8	8	0.3	0.9	1
09Z1B04-1000	4.3	23	45-65	4	100	55	55	121	80	-	40	4.8	8	0.4	1.1	1
10Z1B04-1000	6.1	24	45-65	4	100	64	64	121	80	-	47	4.8	8	0.5	1.5	1
12Z1B04-1000	10	37	45-65	4	148	68	68	145	136	90	48	4.8	8	0.8	2.1	1
13Z1B04-1000	12.6	48	45-65	4	148	78	78	145	136	90	59	4.8	8	0.7	2.6	1
14Z1B04-1000	17.3	69	45-65	4	148	77	77	145	136	90	58	4.8	8	0.9	2.8	1
15Z1B04-1000	25.2	86	45-65	16	178	73	87	180	166	113	55	4.8	8	1.8	4.4	1
16Z1B04-1000	34.7	99	45-65	16	178	88	100	178	166	113	68	4.8	8	2	5.9	1
17Z1B04-1000	44.1	123	45-65	16	219	101	115	215	201	136	73	7	12	2.8	8.4	1
18Z1B04-1000	52.5	126	45-65	35	219	111	120	220	201	136	81	7	12	3.2	10	1
19Z1B04-1000	63	142	45-65	35	219	121	135	220	201	136	91	7	12	3.7	12	1
20Z1B04-1000	79	168	45-65	35	219	121	150	220	201	136	91	7	12	3.8	12	1
21Z1B04-1000	95	194	45-65	M8	267	109	155	207	249	176	82	7	12	6.3	15.6	2
22Z1B04-1000	121	210	45-65	M8	291	129	185	215	273	185	97	10	18	6.5	19.3	2
23Z1B04-1000	158	240	45-65	M8	291	129	200	215	273	185	97	10	18	8.5	22	2
24Z1B04-1000	189	310	45-65	M10	316	153	225	235	292	200	113	10	16	8	24.8	2
25Z1B04-1000	221	328	45-65	M10	316	153	222	234	292	200	113	10	16	6.2	25	2
26Z1B04-1000	263	400	45-65	M10	352	145	210	266	328	224	105	10	16	10	31.6	2
27Z1B04-1000	315	440	45-65	M10	352	145	230	265	328	224	106	10	16	9	34	2
28Z1B04-1000	390	559	45-65	M10	388	150	245	295	364	248	112	10	16	11.7	41.5	2
29Z1B04-1000	485	620	45-65	M12	412	155	250	315	388	264	116	10	16	13	49.3	2
30Z1B04-1000	600	650	45-65	M12	412	174	270	315	388	264	132	10	16	13	57.7	2

MAINS CHOKE 3-PHASES 690 V AC ($U_{max} = 760 V$), 50/60 Hz

Part-No.	I_N [A]	P_V [W]	f_{Netz} [Hz]	\emptyset [mm ²]	B [mm]	H [mm]	H_1 [mm]	T [mm]	a_1 [mm]	a_2 [mm]	a_3 [mm]	d_1 [mm]	d_2 [mm]	Weight		Fig.
														Cu [kg]	m [kg]	
28Z1B06-1000	240	480	45-65	M10	412	156	236	312	388	264	116	10	16	13	45	2
29Z1B06-1000	295	520	45-65	M10	412	156	236	312	388	264	116	10	16	20	50	2
30Z1B06-1000	370	570	45-65	M10	412	174	260	322	388	264	123	10	16	18	62	2
31Z1B06-1000	405	550	45-65	M12	480	174	260	370	450	316	123	12	20	24	55	2

For nomenclature, see Page 4

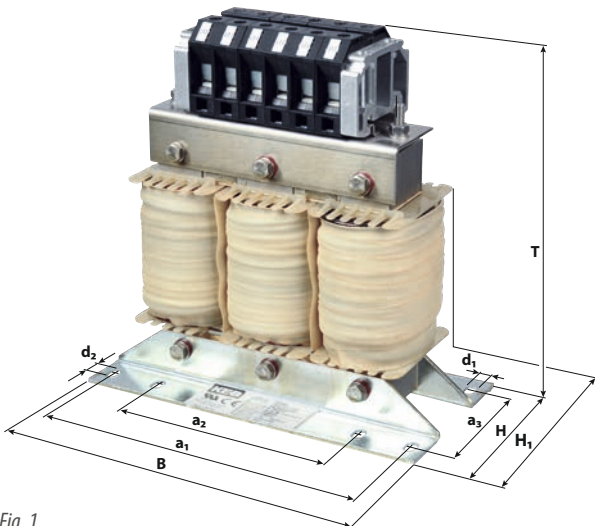

Fig. 1

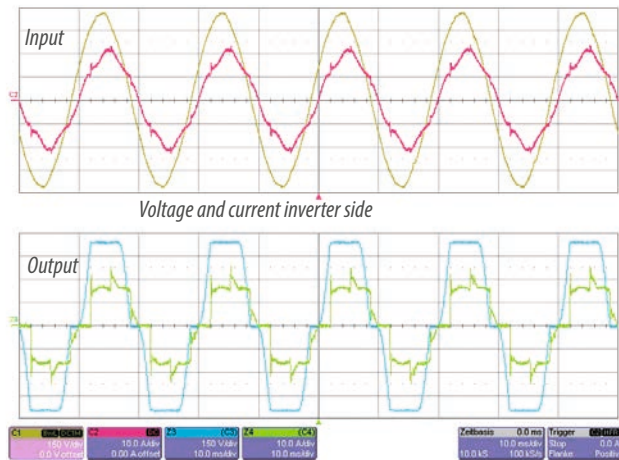

Fig. 2

HARMONIC FILTERS

are the new innovative KEB solution for reducing mains harmonics. Planning is as easy as for a mains choke, which can already be included in the planning phase for the electrical switching system and which enables compliance with many international standards.

- EN 61000-3-2; up to 16 A
- IEEE 519 - 1992 (USA)
- AS 2279 (Australia)
- Quality of Electric Energy Supply, Harmonics in Public Supply Network (China)
- EN 61000-3-4
- G5/4 Engineering Recommendation (GB)
- COP, supply rules (Hong Kong)
- EN 61000-3-12; 16 A up to 75 A
- EN 12015 (Standard for lifts, escalators and passenger conveyors, Europe)



A new innovative internal structure results in mains-friendly energy consumption with excellent application characteristics. In short, the **COMBILINE** harmonic filter is universally suited for all types of consumers with B6 inputs.

It offers the following unique features:

- compact design
- no tendency to oscillate with dynamic load cycles
- lower voltage loss as compared to mains chokes
- allows multiple parallel consumers per unit
- optimised configuration for generators in isolated operations
- protection for drives in „soft“ and „overshooting“ mains
- increased service life for DC-Bus capacitors
- does not require additional compensation facilities when equipment is modernised or expanded

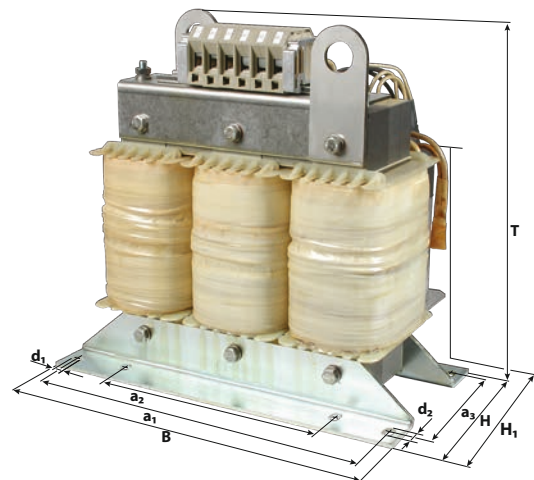

GENERAL TECHNICAL DATA

Protection rating	IP20, open types	Cooling	Convection
max. leakage current	0 mA (with option HF filter ≤ 7 mA)	Efficiency factor	> 98 %
Overload	150 % - 60 sec.	Temperature	Storage -25 ...70 °C Operation -10 ...45 °C
Climate category	3K3 (EN 60721-3-3)	Environment (IEC 664-1)	Pollution level 2
Vibration / Shock	Germanischer Lloyd, EN 50155	Installation position	standing / lying with capacitor positioned below choke
Technical principles	EN 61558-2-20, VDE 0160	in preparation	UL-, cUL- approval

For nomenclature, see Page 4

HARMONIC FILTER 3-PHASES 400 V AC ($U_{max} = 440 \text{ V}$), 50 Hz - THDI < 15 % / PWHD < 39 %

Part-No.	I_N [A]	P_{FU} [kW]	P_V [W]	\emptyset [mm ²]	B [mm]	H [mm]	H_1 [mm]	T [mm]	a_1 [mm]	a_2 [mm]	a_3 [mm]	d_1 [mm]	d_2 [mm]	Weight	
														Cu [kg]	m [kg]
07Z1C04-1001	2.4	0.75	40	4	148	69	134	163	136	90	51	4.8	8	0.7	2.6
10Z1C04-1001	6.1	2.2	65	4	178	75	128	168	166	113	56	4.8	8	1.6	4.8
12Z1C04-1001	10	4	90	4	175	90	145	220	168	113	75	4.8	10	2.2	6.8
13Z1C04-1001	12.6	5.5	105	4	219	102	155	233	202	136	73	7	12	3.5	8.7
14Z1C04-1001	17.3	7.5	135	4	243	105	185	260	225	145	75	7	12	4.2	11.5
15Z1C04-1001	25.2	11	165	16	267	109	174	280	249	176	78	7	12	5.8	16.3
16Z1C04-1001	34.7	15	210	16	291	130	205	275	275	185	97	10	18	7.6	22.6
17Z1C04-1001	44.1	18.5	255	16	291	140	215	280	275	185	110	10	18	9.3	27
18Z1C04-1001	52.5	22	295	35	316	152	256	300	292	200	112	10	16	11.2	33
19Z1C04-1001	63	30	360	35	316	163	260	297	292	200	124	10	16	12.7	38.7

HARMONIC FILTER 3-PHASES 400 V AC ($U_{max} = 440 \text{ V}$), 50 Hz - THDI < 8 % / PWHD < 15 %

Part-No.	I_N [A]	P_{FU} [kW]	P_V [W]	\emptyset [mm ²]	B [mm]	H [mm]	H_1 [mm]	T [mm]	a_1 [mm]	a_2 [mm]	a_3 [mm]	d_1 [mm]	d_2 [mm]	Weight	
														Cu [kg]	m [kg]
09Z1C04-1000	4.3	1.5	60	4	178	90	142	170	166	113	71	4.8	8	1.4	5.8
12Z1C04-1000	10	4	110	4	219	121	170	233	201	136	91	7	12	3.4	11.5
13Z1C04-1000	12.6	5.5	130	16	243	115	195	230	225	144	86	7	12	4.2	13.4
14Z1C04-1000	17.3	7.5	180	16	291	118	192	256	273	185	86	10	18	6.6	18.3
15Z1C04-1000	25.2	11	190	16	291	140	214	257	273	185	106	10	18	9	25.5
16Z1C04-1000	34.7	15	260	16	352	145	240	324	328	224	106	10	16	15	38.5
17Z1C04-1000	44.1	18.5	270	35	352	170	261	324	328	224	131	10	16	15	47.1
18Z1C04-1000	52.5	22	285	35	352	185	260	337	328	224	147	10	16	15	54.6
19Z1C04-1000	63	30	420	35	352	193	355	326	328	224	155	10	16	22	63
20Z1C04-1000	79	37	430	50	388	183	296	360	364	248	144	10	16	23.5	72.6
21Z1C04-1000	95	45	520	50	412	193	320	405	388	264	153	10	16	29.5	96
22Z1C04-1000	121	55	590	50	412	214	378	404	388	264	175	10	16	36	107.7
23Z1C04-1000	158	75	785	95	480	245	416	475	450	316	193	12	20	42.2	162
24Z1C04-1000	189	90	950	95	552	241	515	522	516	356	184	14.5	24	50.8	182.5
25Z1C04-1000	221	110	1145	150	552	275	550	520	525	360	215	14.5	24	60.4	244
26Z1C04-1000	263	132	1360	150	552	294	567	545	516	356	236	14.5	24	63.4	241.5
27Z1C04-1000	315	160	1480	240	552	315	635	550	515	355	255	14.5	24	72.9	294
28Z1C04-1000	390	200	1650	2x150	651	264	530	629	620	460	214	14.5	24	98.2	353
29Z1C04-1000	485	250	1800	2x240	660	350	633	620	620	460	288	14.5	24	126.4	513

HARMONIC FILTER 3-PHASES 480 V-class ($U_{max} = 528 \text{ V}$), 60 Hz - THDI < 8 % / PWHD < 15 %

Part-No.	I_N [A]	P_{FU} [HP]	P_V [W]	\emptyset [mm ²]	B [mm]	H [mm]	H_1 [mm]	T [mm]	a_1 [mm]	a_2 [mm]	a_3 [mm]	d_1 [mm]	d_2 [mm]	Weight	
														Cu [kg]	m [kg]
19Z1C05-1000	46	40	750	M8	352	169	175	325	328	224	128	10	16	16	44.5
20Z1C05-1000	57	50	900	M8	352	185	220	325	328	224	147	10	16	15	55
21Z1C05-1000	69	60	1100	M8	352	193	230	326	328	224	155	10	16	15	64
22Z1C05-1000	90	75	1500	M8	480	200	240	400	468	344	151	10	16	21	93
23Z1C05-1000	115	100	1900	M10	492	202	250	450	468	344	164	10	16	25	106
24Z1C05-1000	150	125	2400	M10	645	248	310	520	626	466	188	14	24	26	165
25Z1C05-1000	190	150	2300	M10	662	248	310	525	626	466	190	14	24	40	180
27Z1C05-1000	220	200	3100	M10	662	278	315	515	626	356	218	14	24	40	230
28Z1C05-1000	300	250	3500	M12	662	298	360	525	626	466	240	14	24	53	258
29Z1C05-1000	360	300	4200	M16	662	318	380	535	626	466	258	14	24	55	280
30Z1C05-1000	410	350	4400	M16	645	330	400	520	626	466	258	14	24	58	285

STANDARD HF-FILTER

are filters which are installed on the mains side for the purpose of complying with statutory limits for mains-bound high-frequency interference. The filters consist of an LC grid which ensures maximum mismatch between the high-frequency interference source and the mains.

Mechanically adapted for the COMBIVERT F5 frequency inverters, these filters have been designed for mains-side interference suppression with especially high attenuation over a wide frequency range. These all-purpose filters can be used with all available switching frequencies. They also offer the advantage of increasing the interference resistance of connected frequency inverters.

In the range up to 75 kW, the filters are mechanically designed as footprint filters for COMBIVERT F5 inverters, and do not utilise additional switch cabinet space. Starting at 90 kW, the filters are installed in space-saving side-mount enclosures with minimal installation volumes.

LOW-LEAKAGE CURRENT IT-HF FILTERS

supplement the E5 series of footprint filters for applications with optimised leakage currents in the drive system and installations in IT networks. The filters in the adapted enclosure design for COMBIVERT F5 are designed with a small capacitive percentage and feature very low leakage currents with reduced motor cable lengths.

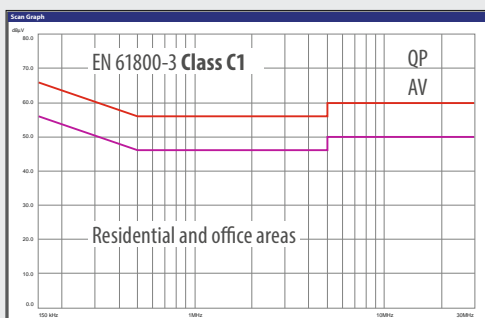
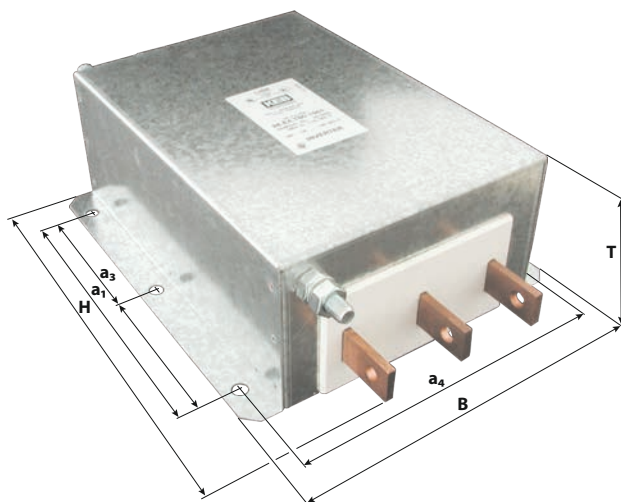

EMC characteristic limit

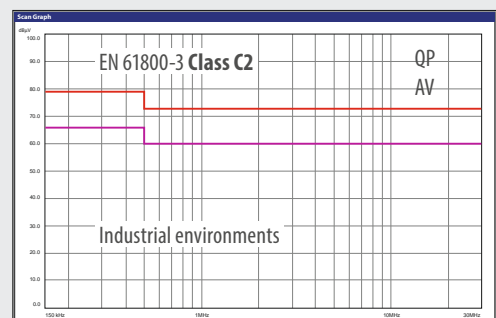

EMC characteristic limit

EMC-FILTER 1-PHASE 230 V AC ($U_{max} = 264 \text{ V}$), 50/60 Hz $\pm 10 \%$

Part-No.	I_N [A]	P_V [W]	I_{ab} [mA]	Suppression degree / Motor cable length	\emptyset [mm ²]	Footprint Housing	B [mm]	H [mm]	T [mm]	a_1 [mm]	a_2 [mm]	a_3 [mm]	a_4 [mm]	Weight m [kg]
07E5T60-0061	12	5	3.4	C1 / 10 m	4	B	88	249	40	240	210	-	-	0.9
10E5T60-0001	22	20	12	C1 / 30 m	4	B	88	249	40	240	210	-	-	0.9
10E5T60-0002	22	22	12	C1 / 30 m	4	D	88	285	40	275	240	-	-	0.9

EMC-FILTER 3-PHASES 400/480 V AC ($U_{max} = 528 \text{ V}$), 50/60 Hz $\pm 10 \%$

Part-No.	I_N [A]	P_V [W]	I_{ab} [mA]	Suppression degree / Motor cable length	\emptyset [mm ²]	Footprint Housing	B [mm]	H [mm]	T [mm]	a_1 [mm]	a_2 [mm]	a_3 [mm]	a_4 [mm]	Weight m [kg]
09E5T60-1001	5.3	15	15	C1 / 30 m	1.5	A	75	191	40	-	175	-	-	1
10E5T60-1001	8	7	15	C1 / 30 m	4	B	88	249	40	240	210	-	-	1.3
10E5T60-1002	8	7	15	C1 / 30 m	4	D	88	285	40	275	240	-	-	1.3
12E5T60-1001	16	12	20	C1 / 30 m	4	B	88	249	40	240	210	-	-	1.3
13E5T60-1001	16	12	20	C1 / 30 m	4	D	88	285	40	275	240	-	-	1.3
14E5T60-1001	22	16	20	C1 / 30 m	4	D	88	285	50	275	240	-	-	1.5
14E4T60-1001	20	14	17	C1 / 30 m	6	E	132	352	50	335	275	-	100	1.5
15E5T60-1001	30	21	17	C1 / 30 m	10	E	132	352	50	335	275	-	100	1.5
16E5T60-1001	43	30	10	C1 / 30 m	10	E	132	352	50	335	275	-	100	2.5
17E5T60-1001	50	14	11	C1 / 30 m	10	G	181	415	56	400	330	-	150	3.2
18E5T60-1001	65	20	30	C1 / 30 m	25	G	181	415	65	400	330	-	150	5.1
18E5T60-1002	65	20	30	C1 / 30 m	25	H	300	445	66	420	330	-	250	5.1
19E5T60-1001	90	26	16	C1 / 30 m	25	H	300	445	66	420	330	-	250	6
20E5T60-1002	100	30	15	C1 / 30 m	50	H	300	445	75	420	330	-	250	8
20E4T60-1001	110	60	48	C1 / 30 m	50	R	64	419	270	385	-	-	200	8.5
22E4T60-1001	150	60	48	C1 / 30 m	50	R	64	419	270	385	-	-	200	10
23E4T60-1001	180	40	45	C1 / 30 m	50	-	110	474	240	414	-	-	200	15
25E4T60-1001	250	50	55	C1 / 30 m	70	-	240	630	110	574	-	-	200	16
27E4T60-1001	330	75	60	C1 / 30 m	95	-	110	630	240	574	-	-	200	18
26E4T60-1001	300	50	60	C2 / 30 m	M10	-	260	385	115	240	-	120	235	18.5
28E4T60-1001	410	50	60	C2 / 30 m	M10	-	260	385	115	240	-	120	235	18.5
30E4T60-1001	650	50	60	C2 / 30 m	M10	-	260	390	135	240	-	120	255	21.5
32E4T60-1001	1000	90	20	C2 / 30 m	M10	-	280	458	185	290	-	270	130	33.5

For nomenclature, see Page 4

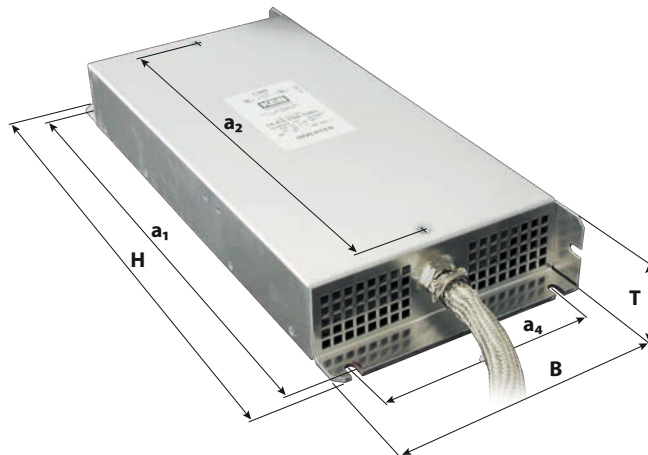

LOW-LEAKAGE CURRENT IT-HF FILTERS

In insulated grids, insulation resistance is continuously monitored against ground. During this monitoring process, the discharge resistors used in the filters falsify this measurement and they must be suppressed during normal operations.

The space-saving IT-HF filters meet this requirement internally and also offer small leakage currents in addition to providing the appropriate damping. The enclosure design has been implemented so as to be compatible with the COMBIVERT F5 inverters, depending on its function as a footprint or book-style side-mount version.

LOW-LEAKAGE CURRENT IT-HF FILTERS 3-PHASES 400/480 V AC ($U_{max} = 528 \text{ V}$), 50/60 Hz $\pm 10\%$

Part-No.	I_N [A]	P_V [W]	I_{ab} [mA]	Suppression degree / Motor cable length	\emptyset [mm ²]	Footprint Housing	B [mm]	H [mm]	T [mm]	a_1 [mm]	a_2 [mm]	Weight m [kg]
10E5T60-10F1	8	7	4.5	C1 / 10 m	4	B	88	249	40	240	210	1.3
10E5T60-10F2	8	7	4.5	C1 / 10 m	4	D	88	285	40	275	240	1.3
12E5T60-10F1	14	12	4.5	C1 / 10 m	4	B	88	249	40	240	210	1.3
13E5T60-10F1	16	12	4.5	C1 / 10 m	4	D	88	285	40	275	240	1.3
14E5T60-10F1	20	14	4	C1 / 10 m	6	D	132	352	50	335	275	1.5
14E5T60-10F2	22	16	5	C1 / 10 m	4	D	88	285	50	275	240	1.5
15E5T60-10F1	30	21	4	C1 / 10 m	6	E	132	352	50	335	275	1.5
15E5T60-10F2	32/50 %ED	16	5	C1 / 10 m	10	D	88	285	50	275	240	1.5
16E5T60-10F1	43	30	8	C1 / 10 m	10	E	132	352	50	335	275	2.5
17E5T60-10F1	50	14	11	C1 / 10 m	10	G	181	415	56	400	330	3.2
17E5T60-10F2	50	14	10	C1 / 10 m	10	G	181	415	56	400	330	3.2
18E5T60-10F1	70	15	12	C1 / 10 m	25	H	300	445	66	420	330	5.1
18E5T60-10F2	65	20	7	C1 / 10 m	25	G	179.5	424	64.5	390	330	5.1
19E5T60-10F2	90	26	7	C1 / 10 m	25	H	300	445	66	420	330	6
20E5T60-10F1	100	30	6	C1 / 10 m	25	R	300	445	75	420	330	8
22E4T60-10S1	150	60	48	C1 / 30 m	50	R	270	419	64	385		10
23E5T60-10S1	165	60	48	C1 / 30 m	50	-	270	419	64	385		16
25E4T60-10S1	250	50	55	C1 / 30 m	70	-	110	630	240	598		16
26E4T60-10S1	300	50	60	C2 / 30 m	M10	-	260	385	115	240		18.5
28E4T60-10S1	410	50	60	C2 / 30 m	M10	-	260	385	115	240		18.5
30E4T60-10S1	650	60	60	C2 / 30 m	M10	-	260	390	135	240		21.5

For nomenclature, see Page 4

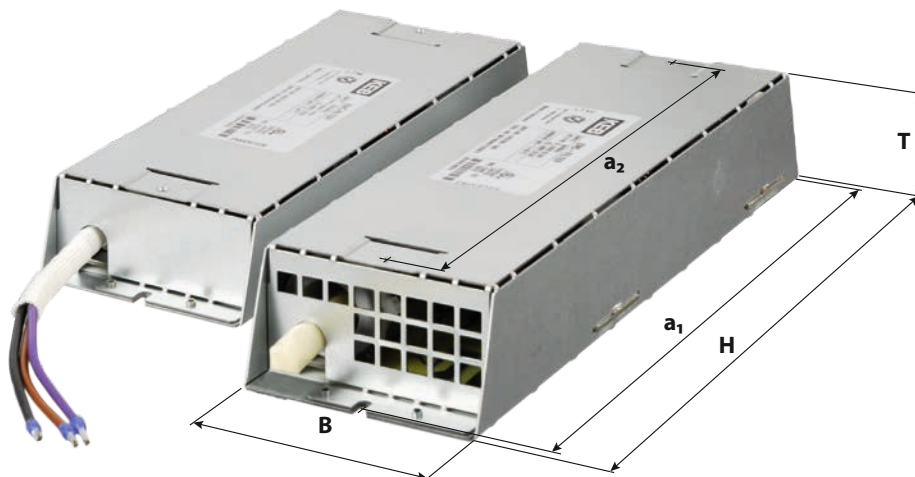

ENCLOSURE SYSTEM FOR COMBIVERT F5

The mechanical configuration of the HF filters has been designed for minimal space requirements in the switch cabinet and directly optimised for the enclosure design of the COMBIVERT F5 inverter and servo drive series.

Mechanical designs configured as footprint versions also offer directly mountable enclosures for powers up to 75 kW, which require no or only minimally larger areas on the mounting plate and provide extensive ground connections with the accessory kit for the shield clamps. More extensive enclosure requirements can be implemented with customer-specific versions.

Passend für die Unterbauversionen bis Gehäusegröße H sind mit den Bausätzen zur Schirmanbindung mechanisch und elektrisch optimale Erdbindungen der Steuer- und Leistungsleitungen für COMBIVERT F5 gestaltet:



SHIELD CONNECTION KITS

Housing	Part-No.	
	Power circuit	Control circuit
B	B0F5T88-0001	integrated
D	B0F5T88-0001	integrated
E	E0F5T88-0001	integrated
G	G0F5T88-0001/2	G0F5T88-0005
H	H0F5T88-0001/2	H0F5T88-0005

Adjusted for the higher weights and dimensions of the drive controllers, the mechanical HF filter is designed as a book-style side-mount version starting at powers of 90 kW.

The filters reach their optimum effect if mounted with shielded connection wires directly beside the devices on EMC-appropriate and conductive surfaces.



CENTRAL HF FILTERS, E6 SERIES

The E6 high-frequency (HF) filter can be used as central switch cabinet filters, collection filters and for the suppression of individual devices.

- Large rated voltage range 0 - 550 V.
- Rated currents from 12 - 330 A, in eight sizes.
- Compact design in book form with small footprint.
- High saturation resistance. Shielded motor cable lengths up to 100 m and 500 m.
- An especially wide damping area due to newly developed filter components.
- With respect to operations with frequency inverters, the filters have been designed for a low leakage current. With the same applications, the leakage current will be reduced to as low as 1/10 as compared to standard filters.
- Operation at AC/DC sensitive RCD's with small triggering level 30/300 mA for people and fire protection.
- High short overload capacity.

THREE-WIRE INPUT HF FILTERS

for connecting 3-phase consumers

FOUR-WIRE HF FILTERS

for connecting single and 3-phase consumers
(3-phase plus neutral wire)



Sold & Serviced By:

 **ELECTROMATE**

Toll Free Phone (877) SERV098

www.electromate.com

sales@electromate.com

THREE-WIRE HF-FILTER 3-PHASES 400/480 V AC ($U_{max} = 550 V$), 50/60 Hz \pm 10 %

Part-No.	I_N [A]	P_V [W]	I_{ab} [mA]	Suppression degree / Motor cable length	\emptyset [mm ²]	B [mm]	H [mm]	T [mm]	a_1 [mm]	a_2 [mm]	Weight m [kg]
12E6T60-3000	12	8	<3	C1/ 50 m, C2/ 100 m	6	45	252	77	237	25	0.9
14E6T60-3000	22	14	<3	C1/ 50 m, C2/ 100 m	6	55	252	92	237	25	1.3
16E6T60-3000	43	18	<3	C1/ 50 m, C2/ 100 m	16	65	252	106	237	30	1.8
18E6T60-3000	65	27	<3	C1/ 50 m, C2/ 100 m	25	130	240	142	220	100	3.9
20E6T60-3000	100	54	<3	C1/ 50 m, C2/ 100 m	50	160	240	142	220	130	5
22E6T60-3000	150	80	<3	C1/ 50 m, C2/ 100 m	95	200	321	190	260	150	9
24E6T60-3000	200	100	<3	C1/ 50 m, C2/ 100 m	95	200	321	190	260	150	9.2
27E6T60-3000	330	160	<3	C2/ 100 m	M10	250	516	194	320	200	22.5

FOUR-WIRE HF-FILTER 3-PHASES 400/480 V AC ($U_{max} = 550 V$), 50/60 Hz \pm 10 %

Part-No.	I_N [A]	P_V [W]	I_{ab} [mA]	Suppression degree / Motor cable length	\emptyset [mm ²]	B [mm]	H [mm]	T [mm]	a_1 [mm]	a_2 [mm]	Weight m [kg]
14E6T60-4100	22	20	<3	C2/ 300 m	6	60	275	150	258	106	2.1
16E6T60-4100	43	22	<3	C2/ 300 m	10	70	330	160	288	106	3.2
18E6T60-4100	65	50	<3	C2/ 300 m	16	80	385	200	335	170	4.7
20E6T60-4100	100	80	<3	C2/ 300 m	25	91	458	240	395	200	6.7
22E6T60-4100	150	100	<3	C2/ 300 m	50	120	466	240	395	200	9.7

For nomenclature, see Page 4

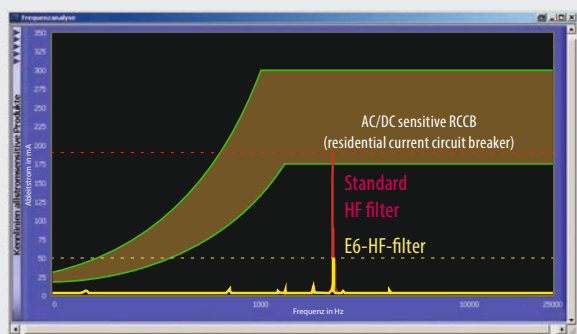
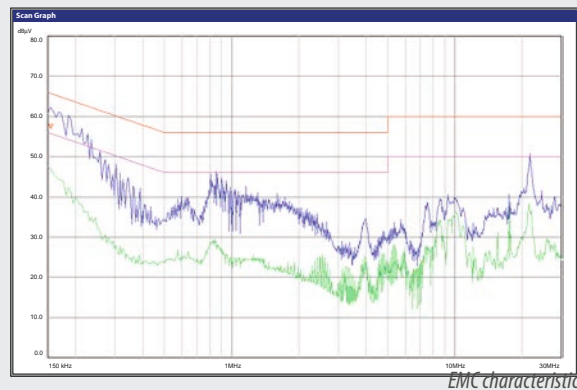
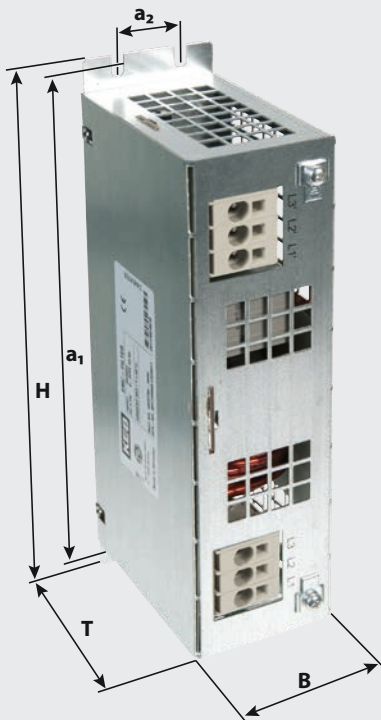

COMBILINE ADVISORY AND TESTING

KEB PROVIDES SECURITY! DRIVES, EMC ADVISORY AND EMC FILTERS WITH DELIVERIES FROM ONE SOURCE.

EC DIRECTIVE 2004/108/EC

requires all equipment manufacturers to design the installation of electrical systems in compliance with EMC legislation. In many cases, this means that individual CE-labelled components must be inspected for their interaction in the equipment or machine.

For this purpose, KEB offers a service that includes advisory services and the testing of electrical equipment.

Our extensive experience in the development and application of drive controllers in a variety of different industrial areas, combined with modern mobile measurement devices, are the ideal prerequisites for rapid on-site assistance.

THE ADVANTAGES ARE EASY TO SEE:

- No expensive investments into measurement devices, buildings, installations and staff
- No training for complex standards
- Standards-appropriate on-site measurements
- Extensive measurement protocol
- Support already provided during development phase
- Advisory services for practical wiring
- Benefit from long-standing KEB experience
- Cost-effective



Sold & Serviced By:

 **ELECTROMATE**

Toll Free Phone (877) SERV098

www.electromate.com

sales@electromate.com

1. IN-HOUSE ABSORBER BUILDING

Transient emissions / interference pursuant to EN 61800-3

- Physical dimensions 3 m test section 2000 x 2000 mm quiet zone
- Test object weight up to 1 tonne
- For connected loads to 60 kVA 230/400/480/690 V

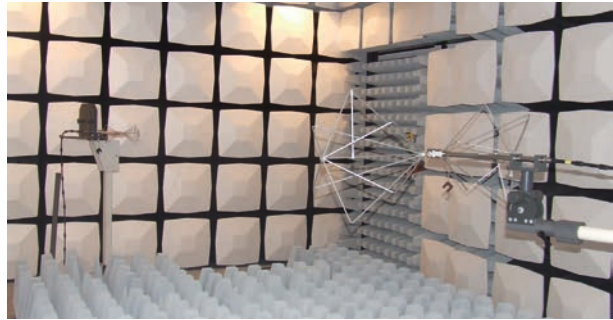

2. INSTALLATION ADVISORY SERVICES

for optimising electrical switching systems



3. EMC MEASUREMENTS

on location: conducted measurement and determination of transient emissions



COMBILINE MOTOR-SIDE

MOTOR CHOKES

present a cost-effective option for reducing the voltage rise rate du/dt in order to avoid the premature ageing of the coil insulation in AC motors.

- increase total inductance at output.
- reduce current ripples.
- reduce the rise rate of the edges (dV/dt) of the IGBT
- increase the service life of motor coils.
- reduce the peak value of the current and reduce the stress on IGBTs in inverters.
- and are suitable for applications with long motor cables (> 15 m)

The basic series is designed for applications with output frequencies of up to 100 Hz.

Additional versions are available for frequency ranges 200 Hz to 1600 Hz as customer-specific designs.

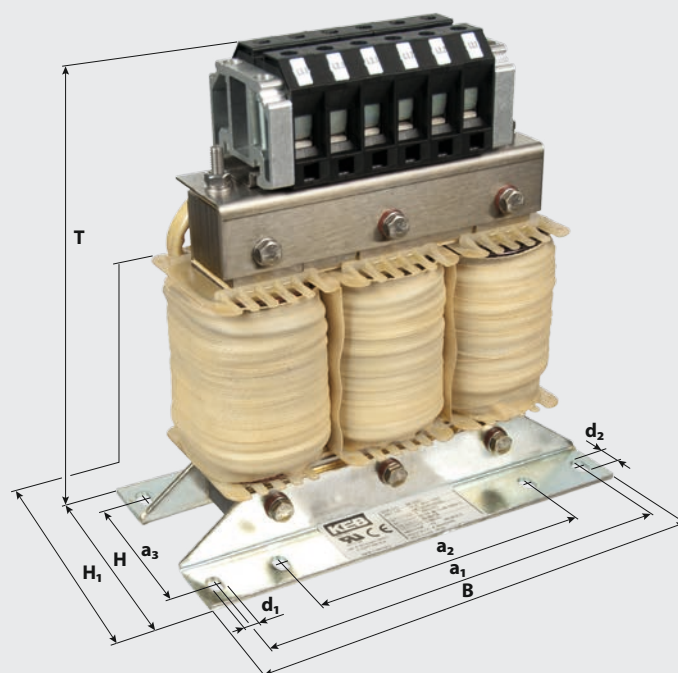

MOTOR CHOKE 3-PHASES 400 V AC ($U_{max} = 550$ V), 100 Hz

Part-No.	I_N [A]	L [mH]	P_V [W]	\emptyset [mm ²]	B [mm]	H [mm]	H_1 [mm]	T [mm]	a_1 [mm]	a_2 [mm]	a_3 [mm]	d_1 [mm]	d_2 [mm]	Weight	
														Cu [kg]	m [kg]
05Z1F04-1010	1.3	11.3	8	4	100	55	H	121	80		40	4.8	8	0.2	0.8
07Z1F04-1010	2.6	5.6	15	4	100	55	H	121	80		40	4.8	8	0.2	1.0
09Z1F04-1010	4.1	3.18	15	4	100	53	H	121	80		37	4.8	8	0.4	1.1
10Z1F04-1010	5.8	2.06	17	4	100	63	H	121	80		47	4.8	8	0.4	1.4
12Z1F04-1010	9.5	1.26	24	4	148	68	H	145	136	90	47	4.8	8	0.5	1.8
13Z1F04-1010	12	1	31	4	148	78	H	145	136	90	59	4.8	8	0.5	2.5
14Z1F04-1010	16.5	0.72	37	4	148	78	H	145	136	90	59	4.8	8	0.6	2.8
15Z1F04-1010	24	0.5	47	10	178	72	H	178	166	113	53	4.8	8	1.3	3.9
16Z1F04-1010	33	0.36	54	10	178	100	H	180	166	113	68	4.8	8	1.5	5.9
17Z1F04-1010	42	0.28	65	16	219	100	105	215	201	136	70	7	12	1.9	6.6
18Z1F04-1010	50	0.24	65	35	219	110	110	220	201	136	81	7	12	2.4	8.5
19Z1F04-1010	60	0.2	67	35	219	121	130	225	201	136	91	7	12	2.6	10.1
20Z1F04-1010	75	0.16	79	35	243	115	130	243	225	156	85	7	12	3.6	12
21Z1F04-1010	90	0.13	105	M8 (35)	267	109	155	207	249	176	78	7	12	3.6	15.6
22Z1F04-1010	115	0.1	137	M8 (50)	291	129	185	215	273	185	97	10	18	3.6	15.5
23Z1F04-1010	150	0.08	170	M8 (70)	291	130	183	216	273	185	97	10	18	5.1	17
24Z1F04-1010	180	0.07	210	M10(70)	316	153	225	233	292	200	113	10	16	5.2	24
25Z1F04-1010	210	0.06	270	M10(70)	316	153	196	234	292	200	113	10	16	5.8	23.4
26Z1F04-1010	250	0.05	380	M10(120)	352	145	230	270	328	224	105	10	16	8.2	29.8
27Z1F04-1010	300	0.04	420	M10(150)	352	147	235	272	328	224	110	10	16	12.0	35.5
28Z1F04-1010	370	0.03	450	M10(150)	388	151	245	300	364	248	112	10	16	10.3	40
29Z1F04-1010	460	0.03	550	M12(185)	412	155	245	325	388	264	116	10	16	11.0	48.2

For nomenclature, see Page 4

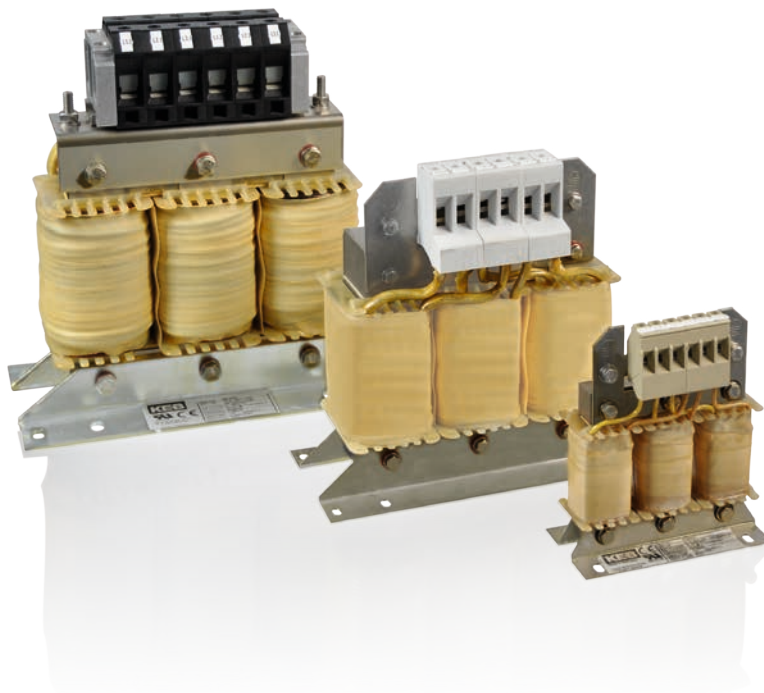

SINUSOIDAL FILTERS

are low-pass filters that filter out the switching frequency from the PWM (pulse width modulation) - output signal of the inverter. Sinusoidal voltage with a small ripple occurs at the output, which results in a sinusoidal motor current. This is why the use of sinusoidal filters at the output is not associated with the supplementary losses in the motor's stator and rotor which otherwise occur with inverter operations.

KEB SINUSOIDAL FILTERS

- reduce supplementary losses in the motor during direct inverter operations. This is a particular requirement for older motors that are not designed for inverter operations, as well as used specialty motors and medium-frequency motors.
- reduce discharge currents driven by pulse frequency in the case of long cable lengths. The sinusoidal output voltages between the phases and the significant du/dt reduction in the voltages phase to ground reduce the capacitive currents. Sinusoidal filters are recommended for up to 500 m motor cable lengths, depending on the type of drive. Lengths exceeding 500 m require an additional EMC level.
- increase the service life of motor insulation. High du/dt at the output of the frequency inverter puts stress on the motor coils. Combined with long cable lengths, it is possible that the high rise of voltage (du/dt) and non-adjusted impedances of inverter, motor cable and motor result in overstressing. Their peaks may increase to double the value of the DC link voltage (approx. 1600 V). The sinusoidal filter reduces the PWM signal of the frequency inverter to sinusoidal sizes, preventing overstressing and a smaller rise of voltage at the motor coil.
- reduce bearing currents in the motor. The filter reduces the high-frequency portions in the output voltage of the inverter, which in turn reduces the high-frequency portions of the voltage at the motor so as to result in a reduction of bearing currents.
- reduce motor noise, which is lessened due to the sinusoidal voltage between the phases.
- reduce high-frequency transient emissions and improve the entire EMC load on the equipment.
- Improve motor efficiency

AVAILABLE SOLUTIONS

- Sinusoidal filter xxZ1G04-1000 to 50/100 Hz output frequency
- Sinusoidal filter xxZ1G04-1001 to 200 Hz output frequency
- Sinusoidal filter xxZ1G04-1003 to 800 Hz output frequency
- Sinusoidal filter xxZ1G04-1004 to 1200/1600 Hz output frequency

SINUSOIDAL FILTER 3-PHASES 400 V AC ($U_{max} = 500 \text{ V}$), $f_{max} = 100 \text{ Hz}$

P_{FU} [kW]	Part-No.	I [A]	$I_{max.}$ [A]	P_v [W]	f_s [kHz]	B [mm]	H [mm]	T [mm]	a_1 [mm]	a_2 [mm]	a_3 [mm]	d_1 [mm]	d_2 [mm]	\emptyset [mm ²]	Weight	
															Cu [kg]	m [kg]
0.37	05Z1G04-1000	1.3	2.3	25.9	4-16	100	110	120	80	-	96	4.8	8	4	0.3	1.1
0.75	07Z1G04-1000	2.6	4.7	27.9	4-16	100	125	135	80	-	110	4.8	8	4	0.4	1.7
1.5	09Z1G04-1000	4.1	7.4	36.7	4-16	148	132	150	136	90	49	4.8	8	4	0.9	2.5
2.2	10Z1G04-1000	5.8	10.4	42.4	4-16	148	143	142	136	90	60	4.8	8	4	1	3.1
4	12Z1G04-1000	9.5	17	48.2	4-16	178	125	167	166	113	56	4.8	8	4	1.8	4.5
5.5	13Z1G04-1000	12	21.6	67.2	4-16	178	145	178	166	113	71	4.8	8	10	2.1	6.4
7.5	14Z1G04-1000	16.5	29.7	86.8	4-16	219	145	207	201	136	74	7	12	10	2.9	8.2
11	15Z1G04-1000	24	36	95	4-16	243	180	225	225	156	79	7	12	10	3.8	11.5
15	16Z1G04-1000	33	49.5	130.2	4-16	267	172	260	249	176	81	7	12	16	5.5	15.6
18.5	17Z1G04-1000	42	63	136.6	4-16	291	197	272	273	185	100	10	18	35	7.4	21.8
22	18Z1G04-1000	50	75	189.1	4-16	291	221	277	273	185	113	10	18	35	8.5	27.7
30	19Z1G04-1000	60	90	190.3	4-16	316	230	305	292	200	116	10	16	35	10.7	32.5
37	20Z1G04-1000	75	112	201.6	4-16	352	265	332	328	224	135	10	16	35	11	41.5
45	21Z1G04-1000	90	135	205.2	4-16	352	282	358	328	224	148	10	16	50	13.8	48.6
55	22Z1G04-1000	115	172	230	4-16	388	288	395	364	248	148	10	16	95	20	67.2
75	23Z1G04-1000	150	225	265	4-16	412	317	416	388	264	138	10	16	M10 (120)	26	72.5
90	24Z1G04-1000	180	270	270	4-16	412	358	412	388	264	184	10	16	M10 (120)	34	99.6
110	25Z1G04-1000	210	263	335	4-16	480	340	467	450	316	157	12	20	M12 (185)	36	120.5
132	26Z1G04-1000	250	313	480	4-16	480	365	464	450	316	170	12	20	M12 (185)	42	129
160	27Z1G04-1000	300	375	503	4-16	480	390	470	450	316	195	12	20	M12 (185)	47	156
200	28Z1G04-1000	370	463	600	2-16	552	575	526	516	356	244	14.5	24	M16 (300)	83	272
250	29Z1G04-1000	460	575	630	2-16	555	600	545	516	356	262	14.5	24	M16 (300)	80	275
315	30Z1G04-1000	570	712	950	2-16	660	501	645	620	460	214	14.5	24	2xM16 (300)	115	355
355	31Z1G04-1000	630	787	1550	2-16	660	560	645	620	460	250	14.5	24	2xM16 (300)	126	400
400	32Z1G04-1000	710	887	1750	2-16	660	618	645	620	460	270	14.5	24	2xM16 (300)	130	420

For nomenclature, see Page 4

Please note:

The sinusoidal filters have been designed for permissible switching and output frequency areas - values that deviate from this range will cause damage to the filters.

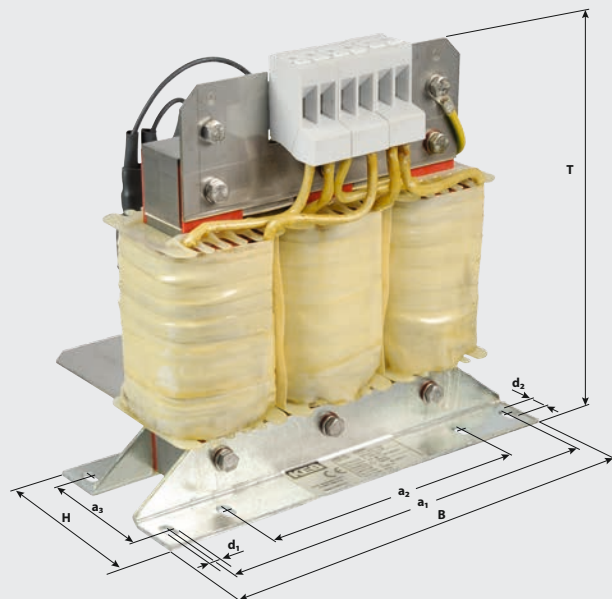

SINUSOIDAL FILTER 3-PHASES 400 V AC ($U_{max} = 500 \text{ V}$), $f_{max} = 200 \text{ Hz}$

P_{FU} [kW]	Part-No.	I [A]	$I_{max.}$ [A]	P_v [W]	f_s [kHz]	B [mm]	H [mm]	T [mm]	a_1 [mm]	a_2 [mm]	a_3 [mm]	d_1 [mm]	d_2 [mm]	\emptyset [mm ²]	Weight	
															Cu [kg]	m [kg]
0.37	05Z1G04-1001	1.3	2.3	7.5	4-16	100	110	120	80	-	95	4.8	8	4	0.2	0.75
0.75	07Z1G04-1001	2.6	4.7	10	4-16	100	125	135	80	-	110	4.8	8	4	0.5	1.6
1.5	09Z1G04-1001	4.1	7.4	20	4-16	148	130	160	136	90	49	4.8	8	4	0.8	2.2
2.2	10Z1G04-1001	5.8	10.4	35	4-16	148	141	142	136	90	59	4.8	8	4	1	3.2
4	12Z1G04-1001	9.5	17	42	4-16	178	140	195	166	113	55	4.8	8	4	1.8	4.3
5.5	13Z1G04-1001	12	21.6	48	4-16	178	153	191	166	113	70	4.8	8	4	2.1	6.5
7.5	14Z1G04-1001	16.5	29.7	60	4-16	219	148	205	201	136	73	7	12	16	2.7	7.6
11	15Z1G04-1001	24	36	80	4-16	243	188	245	225	156	75	7	12	16	3.8	11.5
15	16Z1G04-1001	33	49.5	120	4-16	291	190	260	273	185	91	10	18	16	4.2	15
18.5	17Z1G04-1001	42	63	150	4-16	291	198	275	273	185	99	10	18	35	6.3	20.2
22	18Z1G04-1001	50	75	160	4-16	291	225	280	273	185	115	10	18	35	6.7	25
30	19Z1G04-1001	60	90	165	4-16	316	235	300	292	200	128	10	16	35	10	34.3
37	20Z1G04-1001	75	112	170	4-16	325	224	320	328	224	135	10	16	35	11	37
45	21Z1G04-1001	90	135	180	4-16	325	250	380	328	224	135	10	16	50	12	43
55	22Z1G04-1001	115	172	186	4-16	388	268	425	364	248	149	10	16	95	20	66.5
75	23Z1G04-1001	150	225	190	4-16	388	300	440	364	248	155	10	16	95	22.1	87
90	24Z1G04-1001	180	270	193	4-16	412	342	450	388	264	160	10	16	M12 (185)	33	92.3
110	25Z1G04-1001	210	263	201	4-16	412	362	465	388	264	165	10	16	M12 (185)	35	120.3
132	26Z1G04-1001	250	313	218	4-16	480	348	470	450	316	168	12	20	M12 (185)	44	123.8
160	27Z1G04-1001	300	375	280	4-16	480	449	505	450	316	198	12	20	M12 (185)	47	147
200	28Z1G04-1001	370	463	290	4-16	552	506	515	516	356	205	14.5	24	M16 (300)	50	200
250	29Z1G04-1001	460	575	320	4-16	552	580	515	516	356	240	14.5	24	2xM12 (185)	63	230

SINUSOIDAL FILTER 3-PHASES 400 V AC ($U_{max} = 530 \text{ V}$), $f_{max} = 800 \text{ Hz}$

P_{FU} [kW]	Part-No.	I [A]	$I_{max.}$ [A]	P_v [W]	f_s [kHz]	B [mm]	H [mm]	T [mm]	a_1 [mm]	a_2 [mm]	a_3 [mm]	d_1 [mm]	d_2 [mm]	\emptyset [mm ²]	Weight	
															Cu [kg]	[kg]
0.75	07Z1G04-1003	2.6	4.7	10	8-16	160	171	245	120	-	140	7	12	4	0.8	3.4
1.5	09Z1G04-1003	4.1	7.4	19	8-16	160	171	250	120	-	140	7	12	4	0.8	3.5
2.2	10Z1G04-1003	5.8	10.4	22	8-16	160	171	250	120	-	140	7	12	4	0.9	4
4	12Z1G04-1003	9.5	17	25	8-16	160	171	250	120	-	140	7	12	4	1.3	4.4
5.5	13Z1G04-1003	12	21.6	30	8-16	160	171	250	120	-	140	7	12	4	1.6	5.3
7.5	14Z1G04-1003	16.5	29.7	40	8-16	330	200	250	280	-	170	7	12	16	2.2	10.3
11	15Z1G04-1003	24	36	55	8-16	330	215	255	280	-	174	7	12	16	2.5	10.6
15	16Z1G04-1003	33	49.5	60	8-16	330	215	260	280	-	170	7	12	16	2.6	11
18.5	17Z1G04-1003	42	63	70	8-16	330	215	330	280	-	170	7	12	35	3.4	16.2
22	18Z1G04-1003	50	75	95	8-16	330	205	330	280	-	170	7	12	35	3.7	16.5
30	19Z1G04-1003	60	90	150	8-16	330	225	330	280	-	170	7	12	35	3.9	15.1
37	20Z1G04-1003	75	112	220	8-16	560	235	345	520	260	175	8.5	13.5	M8 (70)	5.5	22
45	21Z1G04-1003	90	135	240	8-16	560	235	345	520	260	175	8.5	13.5	M8 (70)	5.5	21.4
55	22Z1G04-1003	115	172	300	8-16	560	280	345	520	260	175	8.5	13.5	M8 (70)	6	21.7
75	23Z1G04-1003	150	225	390	8-16	560	305	395	520	260	175	8.5	13.5	M10 (120)	8	31.9
90	24Z1G04-1003	180	270	450	8-16	560	305	410	520	260	175	8.5	13.5	M10 (120)	8	33.4
110	25Z1G04-1003	210	263	520	8-16	625	330	410	584	292	220	9.5	24.5	M10 (120)	14	52
132	26Z1G04-1003	250	313	580	8-16	625	330	415	584	292	220	9.5	24.5	M10 (120)	15	53.8
160	27Z1G04-1003	300	375	680	8-16	416	535	460	359	179.5	480	9.5	24.5	M12 (185)	18	66.8
200	28Z1G04-1003	370	463	840	8-16	416	535	470	359	179.5	480	9.5	24.5	M16 (300)	26	75.6
250	29Z1G04-1003	460	575	1025	8-16	676	455	667	584	292	410	11	24.5	2x M12 (185)	35	126.5
315	30Z1G04-1003	570	713	1100	8-16	676	455	667	584	292	410	11	24.5	2x M12 (185)	40	145
355	31Z1G04-1003	630	787	1200	8-16	676	490	667	584	292	410	11	24.5	2x M16 (300)	45	155

SINUSOIDAL FILTER 3-PHASES 400 V AC ($U_{\max} = 530 \text{ V}$), $f_{\max} 1200/1600 \text{ Hz}$

P_{FU} [kW]	Part-No.	I [A]	$I_{\max.}$ [A]	P_v [W]	f_s [kHz]	B [mm]	H [mm]	T [mm]	a_1 [mm]	a_2 [mm]	a_3 [mm]	d_1 [mm]	d_2 [mm]	\emptyset [mm ²]	Weight	
															Cu [kg]	m [kg]
0.75	07Z1G04-1004	2.6	4.7	14	16	160	170	260	120	-	140	7	12	4	0.6	4
1.5	09Z1G04-1004	4.1	7.4	20	16	160	170	245	120	-	140	7	12	4	0.6	4.2
2.2	10Z1G04-1004	5.8	10.4	25	16	160	170	260	120	-	140	7	12	4	0.6	4.5
4	12Z1G04-1004	9.5	17	28	16	160	170	245	120	-	140	7	12	4	0.7	4.6
5.5	13Z1G04-1004	12	21.6	35	16	160	170	243	120	-	140	7	12	4	0.8	4.6
7.5	14Z1G04-1004	16.5	29.7	45	16	160	170	250	120	-	140	7	12	16	1.3	6
11	15Z1G04-1004	24	36	60	16	290	170	255	250	-	140	7	12	16	1.4	6.1
15	16Z1G04-1004	33	49.5	65	16	330	220	255	280	-	170	7	12	35	2.7	10.9
18.5	17Z1G04-1004	42	63	75	16	330	220	260	280	-	170	7	12	35	3	11.3
22	18Z1G04-1004	50	75	100	16	330	220	260	280	-	170	7	12	35	4.2	12.5
30	19Z1G04-1004	60	90	155	16	330	220	335	280	-	170	7	12	35	3.7	13.9
37	20Z1G04-1004	75	112	230	16	330	260	335	280	-	170	7	12	50	4.2	17
45	21Z1G04-1004	90	135	250	16	330	260	335	280	-	170	7	12	50	3.4	18
55	22Z1G04-1004	115	172	310	16	560	280	350	520	260	175	8.5	13.5	M8 (70)	6.7	21.5
75	23Z1G04-1004	150	225	400	16	560	280	360	520	260	175	8.5	13.5	M10 (120)	8.5	26.5
90	24Z1G04-1004	180	270	460	16	560	280	365	520	260	175	8.5	13.5	M10 (120)	9	27
110	25Z1G04-1004	210	263	540	16	560	285	376	520	260	175	8.5	13.5	M10 (120)	11	32.5
132	26Z1G04-1004	250	313	600	12	560	285	385	520	260	175	8.5	13.5	M12 (185)	12.2	43
160	27Z1G04-1004	300	375	700	12	625	340	410	584	292	220	9.5	24.5	M12 (185)	15	48
200	28Z1G04-1004	370	463	860	12	416	515	520	359	179.5	480	9.5	24.5	M16 (300)	18	62
250	29Z1G04-1004	460	575	1050	12	416	515	520	359	179.5	480	9.5	24.5	M16 (300)	20	68
315	30Z1G04-1004	570	713	1200	12	676	455	665	584	292	410	11	24.5	2xM12 (185)	29	108
355	31Z1G04-1004	630	787	1300	12	676	455	665	584	292	410	11	24.5	2xM16 (300)	28	114

For nomenclature, see Page 4

Part-no. 07 - 25 maximum motor frequency 1600 Hz
 Part-no. 26 - 31 maximum motor frequency 1200 Hz

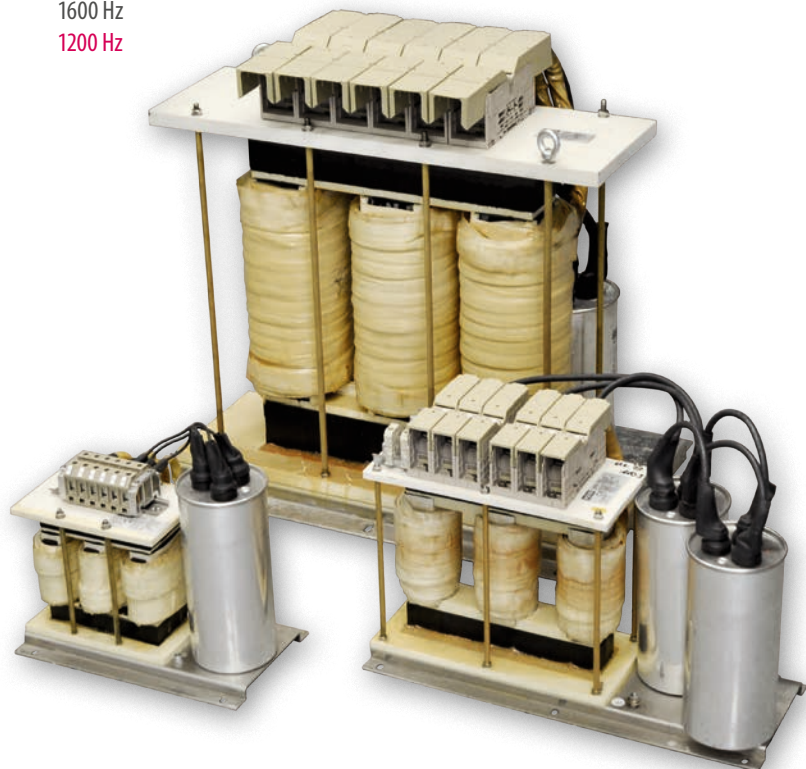

COMBILINE COMBINATIONS

NHF-FILTERS

NHF filters combine a mains choke and HF filter in one enclosure. This means that the filter combines the advantages of the mains choke with those of the HF filter in one particularly compact assembly. This filter features high saturation resistance and small leakage currents, mechanically designed as ancillary filters.

NHF-FILTER 3-PHASES 480 V AC ($U_{max} = 504 \text{ V}$), 50/60 Hz $\pm 10 \%$

Part-No.	I [A]	P _v [W]	I _{ab} [mA]	Suppression degree / Motor cable length	∅ [mm ²]	B [mm]	H [mm]	T [mm]	a ₁ [mm]	d ₁ [mm]	d ₂ [mm]	Weight m [kg]
13EST60-1011	14	56	15	C1 / 30 m	6	82	290	200	275	-	7	4
14EST60-1011	19	55	23	C1 / 30 m	10	100	340	210	330	50	7	6.5
15EST60-1011	27	82	20	C1 / 30 m	10	100	340	210	330	50	7	8
16EST60-1011	37	86	21	C1 / 30 m	16	100	340	210	330	50	7	9
17EST60-1011	47	110	25	C1 / 30 m	16	110	340	250	330	80	M6	12
18EST60-1011	55	120	27	C1 / 30 m	35	110	340	250	330	80	M6	13
19EST60-1011	66	120	25	C1 / 30 m	35	110	340	250	330	80	M6	16

For nomenclature, see Page 4

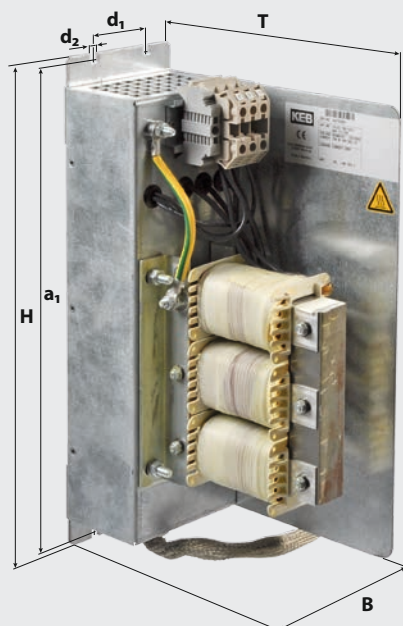

I/O-FILTER

integrate the functionality of the mains-side HF filter and the motor-side dV/dt filter in one compact enclosure.

A portion of the input filter that is configured with high damping at minimal leakage current, reduces conducted interference to limit value C1 pursuant to EN 61800-3.

On the output side, configured for:

- Output frequency 0 ... 300 Hz

passive output dV/dt filter with choke for limiting dV/dt stress

The compact mechanical design enables space-saving installations with COMBIVERT F5 and F6 series inverters as footprint versions and generally also as book-style side-mount versions. Brake resistors for emergency brakes can be mounted between the enclosure and the frequency inverter.

E/A filters are designed for operations with cable lengths exceeding 30 m to approx. 200 m and protect connected motors against non-permissible high increases in voltage and non-permissible high peak voltages - both factors that negatively impact the service life of the coil insulation.

I/O-FILTER 3-PHASES 480 V AC ($U_{max} = 530 V$), 50/60 Hz $\pm 10\%$, Motor frequency 0 ... 300 Hz

P_{FU} [kW]	Part-No.	I [A]	I_{ab} [mA]	P_v [W]	Suppression degree / Motor cable length	f_{Smax} [kHz]	B [mm]	H [mm]	T [mm]	a_1 [mm]	a_2 [mm]	Footprint Housing	f_{max} [Hz]	\emptyset [mm ²]	Weight m [kg]
2.2	10EST60-10G1	8	10	29.5	C1 / 2x50 m	4	90	360	126	330	60	B/D	300	4	4.3
5.5	13EST60-10G1	16.5	10	54.5	C1 / 2x50 m	4	90	360	126	330	60	B/D	300	4	4.3
7.5	14EST60-10G1	22	10	65	C1 / 2x50 m	4	90	360	126	330	60	D	300	4	5.3
11	15EST60-10G1	32	13	97	C1 / 2x50 m	4	130	360	85	330	100	E	300	10	6.5
15	16EST60-10G1	42	13	106	C1 / 2x50 m	4	130	360	85	330	100	E	200	10	6.5
15	16EST60-10G2	42	13	106	C1 / 2x50 m	4	170	412	131	400	140	G	200	16	7.3
22	18EST60-10G1	50	20	117	C1 / 2x50 m	2	170	412	131	400	140	G	100	16	9.5

For nomenclature, see Page 4

Active output dV/dt filters with choke for limiting dV/dt loads and an intermediate circuit feedback for reducing overstressing at the intermediate circuit level are available as customer-specific solutions for **output frequency 0 ... 1600 Hz**.

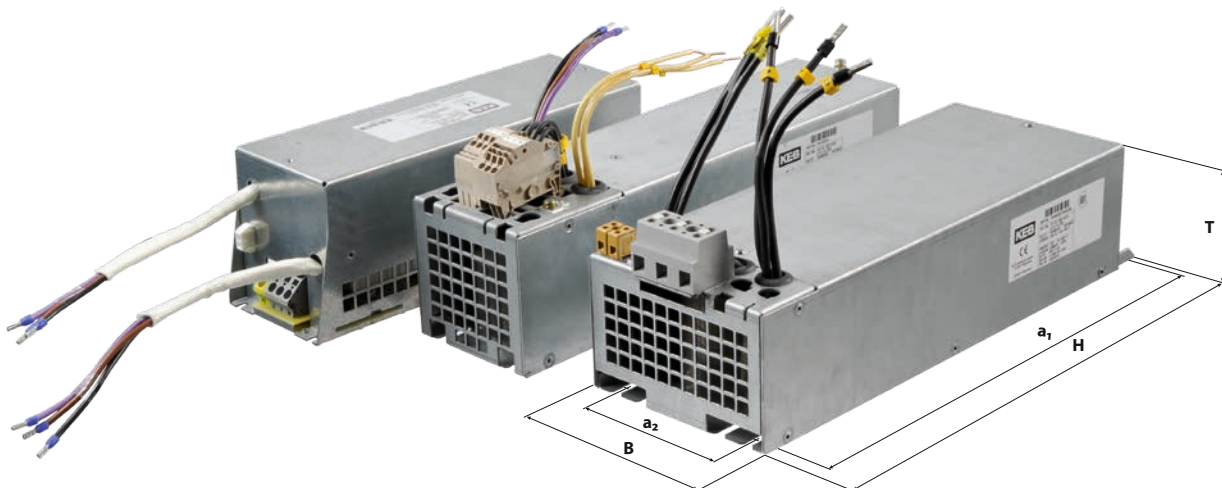

KEB SERVICE

PERFORMANCE AND COMPETENCE

AFTER-SALES CUSTOMER SUPPORT

- start-up support
- EMC service
- mains analysis
- Insulation, heat or vibration measurements
- conversion of old product series

MAINTENANCE AND REPAIRS

- rush or standard service

COMPONENT AND SPACE PART SUPPLY

- used and new parts for the exchange

PREVENTIVE MAINTENANCE

- forming and cleaning, inspection, functional analysis

CUSTOMER SPECIFIC SERVICE

- individual service support
- system optimisation



KEB WORLDWIDE

Sold & Serviced By:



ELECTROMATE

Toll Free Phone (877) SERV098

www.electromate.com

sales@electromate.com



KEB PARTNERS WORLDWIDE

... www.keb.de/contact/contact-worldwide

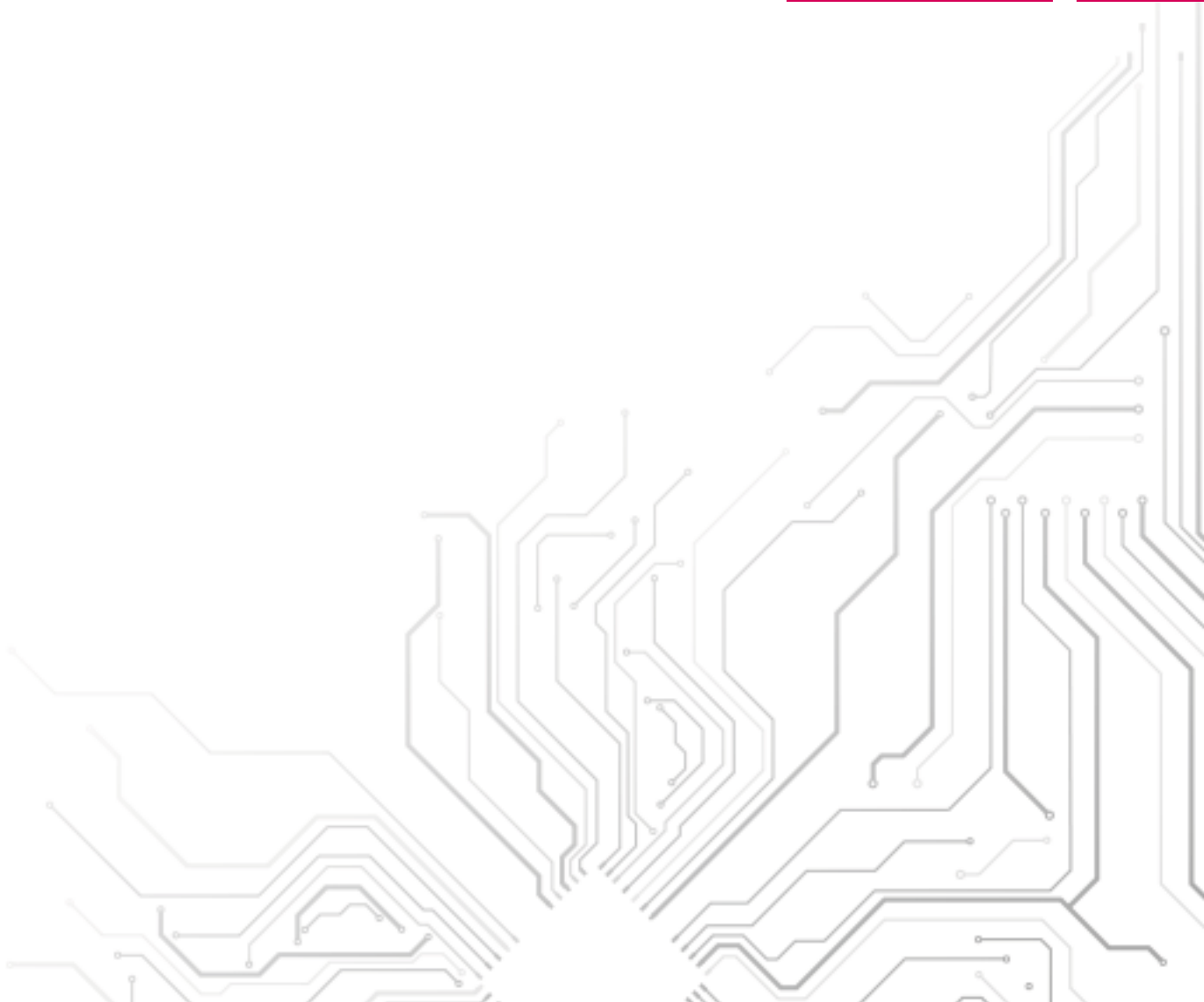

Automation with Drive

www.keb.de

KEB Automation KG Suedstrasse 38 32683 Barntrup Germany Tel. +49 5263 401-0 E-Mail: info@keb.de

© KEB 000000-5LIN 09.2017 Subject to technical alterations!