

Simultaneous Control of SCARA Robots and Single-Axis/Cartesian Robots with One Controller

A large-capacity SCARA controller capable of controlling up to six axes



Features

1

Controlling SCARA robots (4 axes) plus 2 additional axes

The X-SEL PX/QX can control SCARA robots plus up to two axes in a combination of single-axis and/or cartesian robots (total wattage: 2400 W) (*1). If the SCARA robot has an arm length of 500/600, two 750-W axes can be operated together.

(*1) Single-axis robots may not be connectable depending on the type of SCARA robot. For details, refer to the notes under "Models."

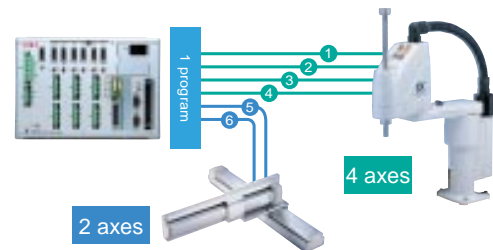

2

"Global type" for applications that require conformance to safety category 4

The "global type" does not have a built-in drive-source cutoff circuit. Instead, it cuts off the drive source using an external safety circuit. This design conforms to safety category 4 under ISO 13849-1. Both the large-capacity type (PX) and large-capacity global type (QX) conform to the CE Mark standard.

3

Conveyor tracking function (Optional)

The PX/QX can be configured to detect works on the conveyor using a vision system and handle them synchronously with the conveyor movement. The conveyor tracking function will surely improve the work efficiency of your equipment.

(Note) The conveyor tracking function is effective only if the actuator has an arm length of 500/600. Also, this function may not be supported under certain operating conditions. If you are considering adding the conveyor tracking option, consult IAI's Sales Department.

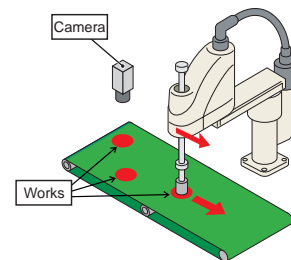

4

Compact, high performance and CE-compliant

- Approx. 40% slimmer than IAI's conventional controllers (X-SEL general -purpose controllers).
- Significantly faster than IAI's conventional controllers (the command processing time is around half).
- Connectable to DeviceNet, CC-Link, Ethernet and other networks.
- Conforming to the CE Mark standard.

Conventional product

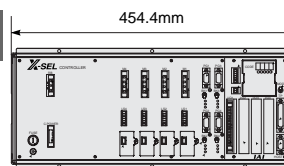

XSEL-KX (general-purpose type), 4-axis, 1.6 Kw

New product

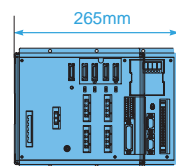

XSEL-PX 4-axis, 2.4Kw

XSEL - PX6 - NNN5020 - 750AL - 750ABL - DV - N1 - EEE - 2 - 3

① ② ③ ④ ⑤ ⑥ ⑦ ⑧ ⑨ ⑩

① Series	② Controller type	③ IX robot model	④ Motor output of axis 5	⑤ Motor output of axis 6	⑥ Dedicated network slot	⑦ Standard I/O				⑧ Expansion I/O				⑨ I/O flat cable length	⑩ Power-supply voltage
						Slot 1	Slot 2	Slot 3	Slot 4	Slot 1	Slot 2	Slot 3	Slot 4		
XSEL	PX4 (Large-capacity, 4-axis type) PX5 (Large-capacity, 5-axis type) PX6 (Large-capacity, 6-axis type) QX4 (Large-capacity, global 4-axis type) QX5 (Large-capacity, global 5-axis type) QX6 (Large-capacity, global 6-axis type)	NNN1205-8040 (Standard type)	Blank (No single axis)	Blank (No single axis)	Blank (No network) DV (DeviceNet) CC (CC-Link) PR (Profibus) ET (Ethernet)	E (Not used)	E (Not used)	E (Not used)	E (Not used)	2 (Standard specification) 2m 3 (3m) 5 (5m) 0 (None)	3 (Three-phase) 200V				
		NSN5016-6016 (High-speed type)	20□ (20W)	20□ (20W)		N1 (I/O board NPN32/16)	N1 (I/O board NPN32/16)	N1 (I/O board NPN32/16)	N1 (I/O board NPN32/16)						
		NNW2515-8040 (Dustproof/splash-proof type)	30□ (30W)	30□ (30W)		N2 (I/O board NPN16/32)	N2 (I/O board NPN16/32)	N2 (I/O board NPN16/32)	N2 (I/O board NPN16/32)						
		TNN3015-3515 (Wall mount type)	60□ (60W)	60□ (60W)		N3 (I/O board NPN48/48)	N3 (I/O board NPN48/48)	N3 (I/O board NPN48/48)	N3 (I/O board NPN48/48)						
		UNN3015-3515 (Wall mount, inverse type)	100□ (100W)	100□ (100W)		P1 (I/O board PNP32/16)	P1 (I/O board PNP32/16)	P1 (I/O board PNP32/16)	P1 (I/O board PNP32/16)						
		HNN5020-8040 (Ceiling mount type)	200□ (200W)	200□ (200W)		P2 (I/O board PNP16/32)	P2 (I/O board PNP16/32)	P2 (I/O board PNP16/32)	P2 (I/O board PNP16/32)						
		INN5020-8040 (Inverse type)	400□ (400W)	400□ (400W)		P3 (I/O board PNP48/48)	P3 (I/O board PNP48/48)	P3 (I/O board PNP48/48)	P3 (I/O board PNP48/48)						
		INN5020-8040 (Inverse type)	600□L (600W)	600□L (600W)											
		NNC1205-8040 (Cleanroom type)	750□L (750W)	750□L (750W)											

① Series

Indicate the series name.

② Controller type

Indicate the controller type.

- PX4 Large-capacity, dedicated SCARA specification
- PX5 Large-capacity, 5-axis (SCARA + 1 axis) specification
- PX6 Large-capacity, 6-axis (SCARA + 2 axes) specification
- QX4 Large-capacity, dedicated SCARA specification conforming to safety category 4
- QX5 Large-capacity, 5-axis (SCARA + 1 axis) specification conforming to safety category 4
- QX6 Large-capacity, 6-axis (SCARA + 2 axes) specification conforming to safety category 4

③ IX robot model

Indicate the type of the SCARA robot to be operated.

Notes

- * If the SCARA robot has an arm length of 700/800, the PX/QX connects up to 5 axes (SCARA + 1 axis).
- * The high-speed type connects up to 4 axes (SCARA only).

④ Motor output of axis 5 (single-axis robot)

Indicate the motor output of the single-axis robot connected as axis 5 of the PX5/PX6/QX5/QX6. In □, enter codes corresponding to the encoder type and desired option(s).
* If you are selecting multiple options, enter the corresponding codes in alphabetical order after the encoder type code. If you are ordering your controller without options, enter only the encoder type code.

- (Encoder type A: Absolute / I: Incremental)
 - (Options B: Brake / C: Creep sensor)
 - L: Limit switch
 - M: Master-axis designation in synchronized operation
 - S: Slave-axis designation in synchronized operation
- Leave the space blank for the PX4/QX4.

⑤ Motor output of axis 6 (single-axis robot)

Indicate the motor wattage of the single-axis robot connected as axis 6 of the PX6/QX6. The content of □ conforms to the same explanation for axis 5. Leave the space blank for the PX4/QX4.

⑥ Dedicated network slot

Indicate an applicable network if you want to connect the PX/QX to DeviceNet, CC-Link, Profibus or Ethernet.

⑦ Standard I/O (Slot 1)

Indicate the specification of the standard slot (slot 1).

⑧ Expansion I/O (Slots 2 to 4)

Indicate the specification of the expansion slots (slots 2 to 4). Take note that use of expansion slots will change the external dimensions.

⑨ I/O flat cable length

Indicate the length of the signal wire connecting each I/O board and the PLC.
* If you have selected "E (Not used)" for the standard and expansion I/Os, "0 (None)" will be selected automatically.

⑩ Power-supply voltage

Indicate the voltage of the main controller power supply.

Specifications

	Large-capacity type		Large-capacity global type	
	PX4	PX5/PX6	QX4	QX5/QX6
Total output when maximum number of axes are connected	2400W			
Control power input	Single-phase 200/230VAC -15%, +10%			
Motor power input	Three-phase 200/230VAC -10%, +10%			
Power-supply capacity	3625VA max. (*1)	5005VA max. (*2)	3625 max. (*1)	5005 max. (*2)
Safety circuit configuration	Redundant configuration not supported		Redundant configuration supported	
Drive-power cutoff method	Internal cutoff relay		External safety circuit	
Enable input	Contact-B input (internal power supply type)		(external power supply type, redundant)	
Position detection method	Incremental encoder / absolute encoder			
Speed setting (*3)	1mm/sec-2000mm/sec			
Acceleration/deceleration setting (*3)	0.01G-1G			
Programming language	Super SEL Language			
Number of program steps	6000 steps (total)			
Number of positions	4000 positions (total)			
Number of programs (multitasking)	64 programs (16 programs)			
Operating temperature/humidity	0-40°C, 10-95% (non-condensing)			
Weight (*4)	5.2kg	5.7kg	4.5kg	5kg

*1 When a SCARA robot of 700/800 arm length is operated.
*3 The maximum limit varies depending on the actuator type.

*2 When a SCARA robot of 500/600 arm length and two 750-W axes are operated.
*4 The controller weight includes the absolute battery, brake mechanism and expansion I/O box.



X-SEL PX/QX

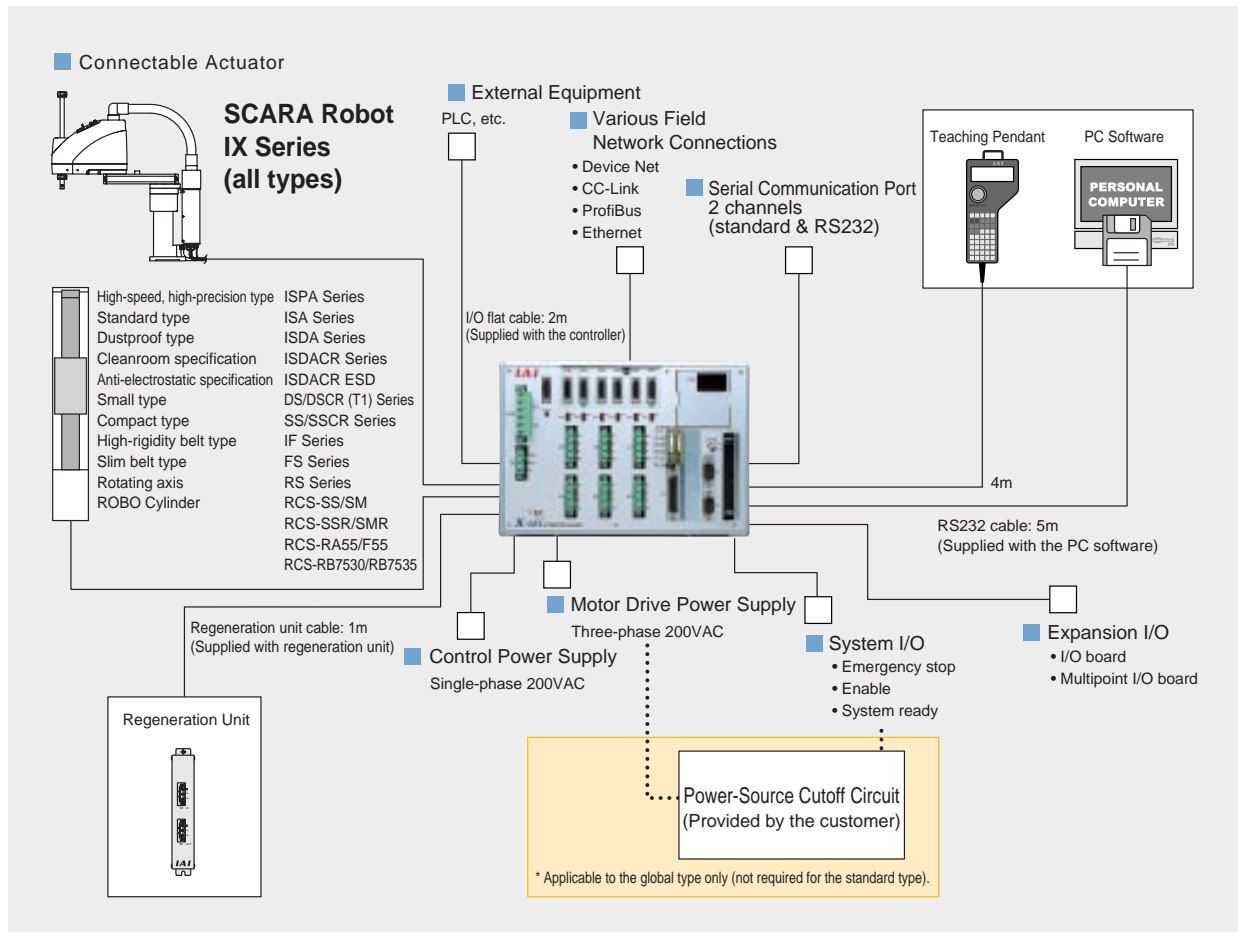

Options

Teaching Pendant

- Model : IA-T-X (Standard)
- IA-T-XD (With deadman switch)
- IA-T-XA (ANSI/CE Mark compliant type)

This teaching device supports program/position input, test operation, monitoring, etc.
 * IA-T-X/D of version 1.20 or older and IA-T-XA of version 1.10 or older cannot be used with the PX/QX controllers.



PC Software

- Model : IA-101-X-MW
- With a PC link cable (equipped with a D-sub, 9-pin connector on the PC end)
- For Windows 95, 98, NT, 2000 and ME

This software is a startup support tool offering the functions needed to input programs/positions and perform debugging.
 * Version 5.0.1.0 or older programs cannot be used with the PX/QX controllers.



Regeneration Unit

- Model : REU-1

This unit converts to heat the regenerative current produced when the motor decelerates.
 The regeneration unit may be required depending on the total motor output of single-axis robots connected to the controller (SCARA robots do not require this unit).
 Refer to the table shown to the right for a guideline on whether or not the regeneration unit is required and if so, how many.

Motor output	Horizontal application	Vertical application
0 ~ 100W	Not required	Not required
~ 200W	Not required	1 unit
~ 400W	1 unit	1 unit
~ 600W	1 unit	1 unit
~ 800W	1 unit	1 unit
~ 1000W	1 unit	2 units
~ 1200W	2 units	2 units
~ 1500W	2 units	3 units

External Dimensions

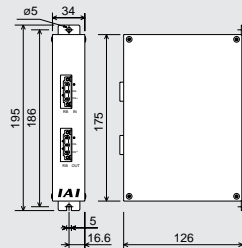

X-SEL PX/QX

External Dimensions

The external dimensions of X-SEL PX/QX controllers vary depending on the type (arm length) of connected SCARA robot, number of connected axes, use/non-use of expansion I/O, and types of direct-coupled axes. In the table below, select the controller specification meeting your specific requirements and refer to the drawing of the corresponding number.

SCARA		Controller							
Type	Arm length	Large-capacity type (PX)				Large-capacity global type (QX)			
		SCARA only (PX4)		SCARA + direct-coupled axis(es)(PX5/PX6)		SCARA only (QX4)		SCARA + direct-coupled axis(es)(QX5/QX6)	
		Without expansion I/O	With expansion I/O	Without expansion I/O	With expansion I/O	Without expansion I/O	With expansion I/O	Without expansion I/O	With expansion I/O
Standard type Cleanroom type Wall mount type Ceiling mount type	120	External dimensions ①	External dimensions ③	External dimensions ⑤ ^{(*)1}	External dimensions ⑦ ^{(*)2}	External dimensions ⑨	External dimensions ⑪	External dimensions ⑬ ^{(*)3}	External dimensions ⑮ ^{(*)4}
	150								
	250								
	350	External dimensions ②	External dimensions ④	External dimensions ⑥	External dimensions ⑧	External dimensions ⑩	External dimensions ⑫	External dimensions ⑭	External dimensions ⑯
	500								
	600								
High-speed type	700					External dimensions ⑭ ^{(*)5}	External dimensions ⑯ ^{(*)5}		
	800	External dimensions ⑥ ^{(*)5}	External dimensions ⑧ ^{(*)5}	-	-				
	500								
	600								

(*)1 If the direct-coupled axis has a brake or is of absolute encoder specification, refer to external dimensions ⑤.
 (*)2 If the direct-coupled axis has a brake or is of absolute encoder specification, refer to external dimensions ⑧.
 (*)3 If the direct-coupled axis has a brake or is of absolute encoder specification, refer to external dimensions ⑭.
 (*)4 If the direct-coupled axis has a brake or is of absolute encoder specification, refer to external dimensions ⑮.
 (*)5 Due to the large motor wattage of the SCARA robot, the external dimensions of a 6-axis configuration apply even when only four axes are connected.

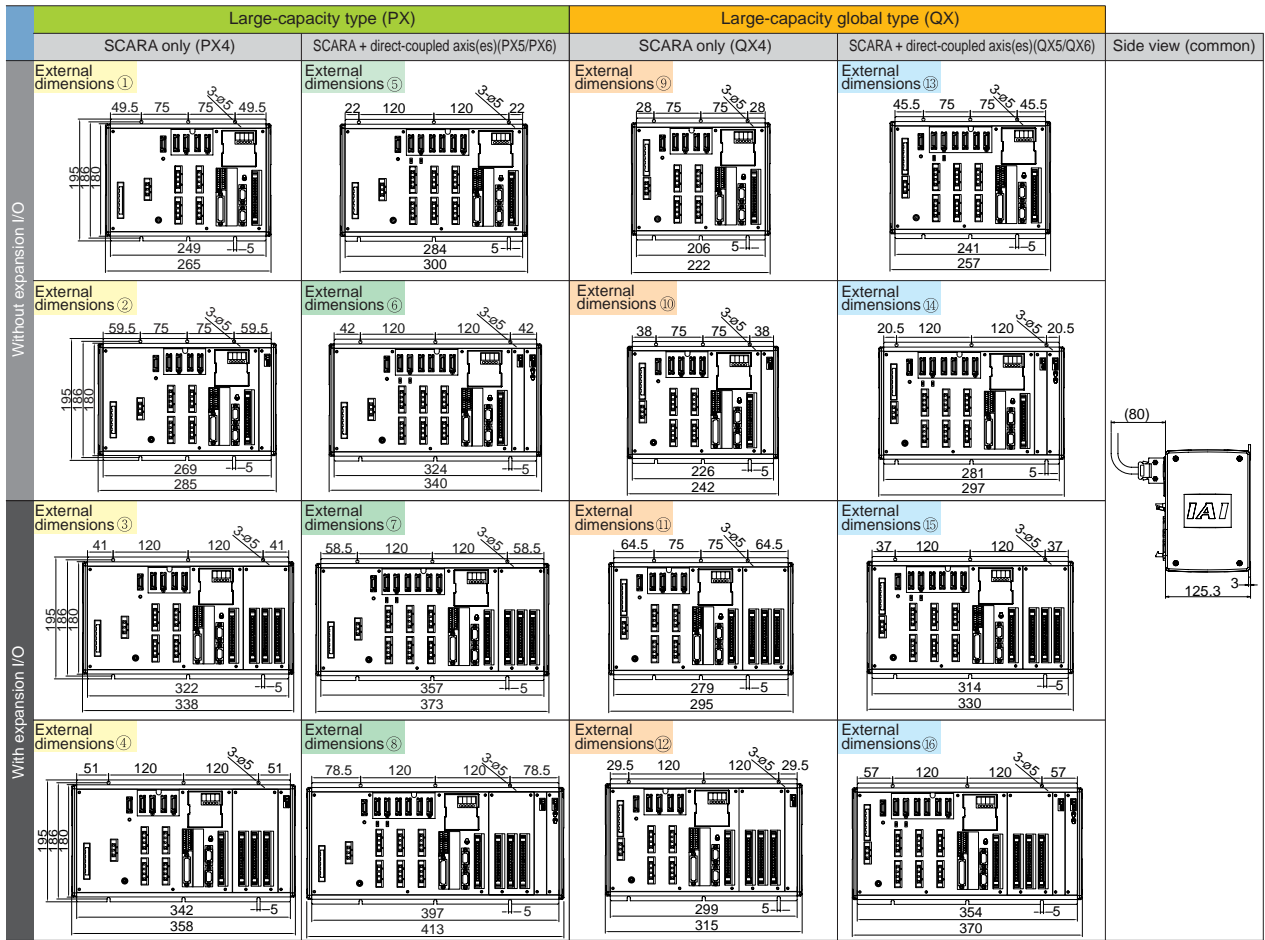

* All controller types have the same height.