

IAI

Quality and Innovation

Network Controller

ROBO NET



Greatly reduces time and effort of wiring and installation

RoboNet is a new type of controller unit that can freely operate robot cylinders via a field network. This makes it possible to greatly reduce the time and effort of wiring installation compared to conventional controllers by reducing wiring, making the controller smaller, and using DIN rail installation.

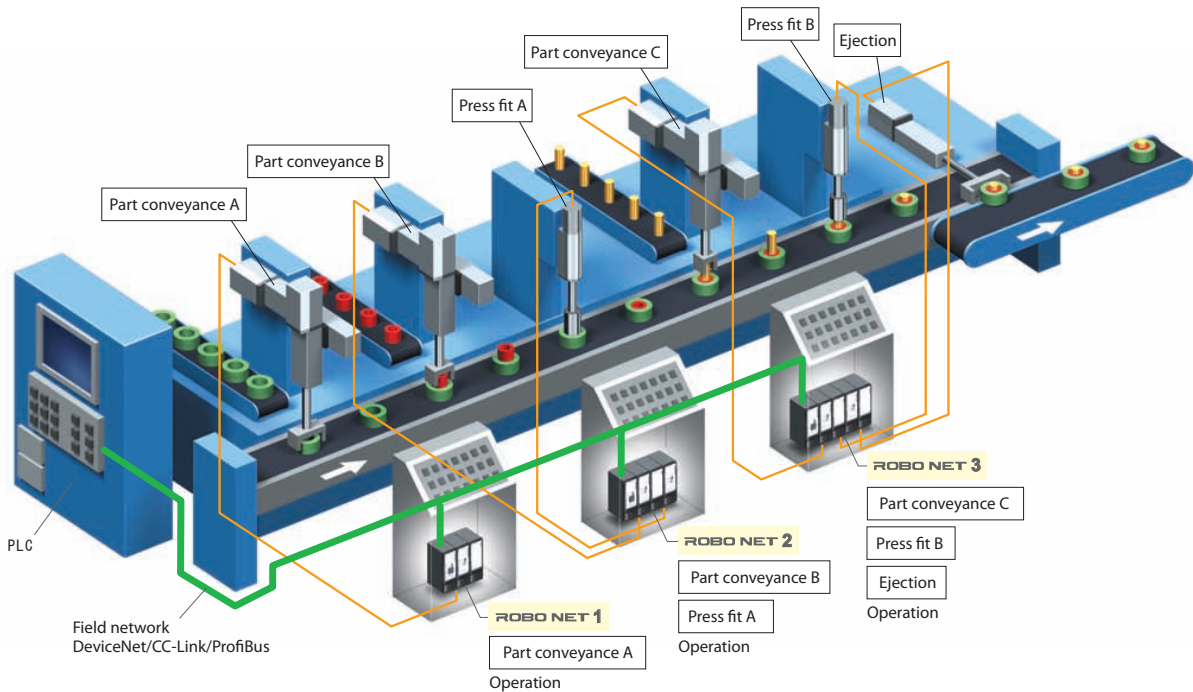

1 Reduced wiring

By connecting each line of the I/O cable to lines wired to the PLC terminals with the field network, wiring processing is completed with one dedicated cable.

Also, since the unit can be coupled by just connecting with the unit connection board, the controller wiring work is greatly simplified.

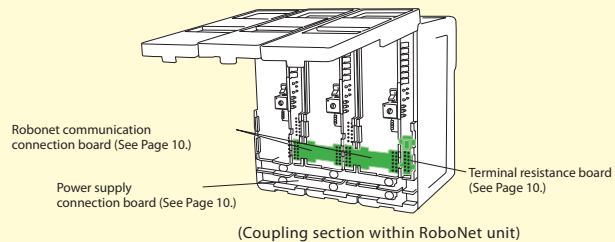
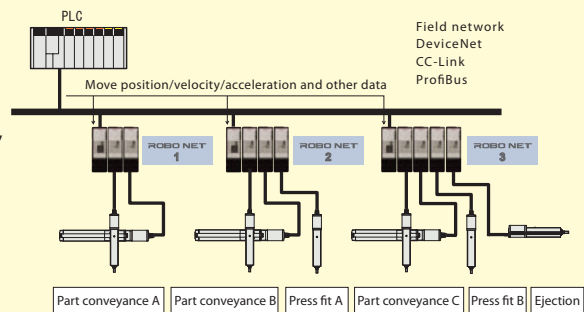

1 ROBO NET

Sold & Serviced By:
 ELECTROMATE

Toll Free Phone (877) SERV098
 Toll Free Fax (877) SERV099
www.electromate.com
sales@electromate.com

Newly Developed Network Controller

ROBO NET Arrives!

2 The robot can be moved by directly specifying numeric values for the move position/velocity/acceleration and other data.

Besides the conventional method of moving the robot to pre-taught positions it is also possible to operate the robot by sending information as a string of numeric data that contains position, velocity, acceleration, etc. values. This is effective for cases such as when the move position changes with each piece or when one wants to move the robot to an arbitrary position.

	ROBONET controller	Standard controller (ACON/PCON)
Position specification movement	○	○
Direct numeric value specification movement	○	△
Velocity/acceleration specification	○	(Not possible with PIO) (Possible with serial communications)
Current value output	○	

* RoboNet operates via the field network; the standard controller operates with PIO.

3 Ultra-compact

Each unit is an ultra-compact size of 34mm wide by 100mm high x 73 mm deep. Also, since there is no base unit and the main unit is coupled with connectors, the controller takes up little space for installation even if there are many units.



4 Can operate up to 16 axes

Up to 16 controller units can be connected to one communications unit (GatewayR unit). One can also freely mix and connect RACON units (RCA controllers) and RPCON units (RCP2 controllers).

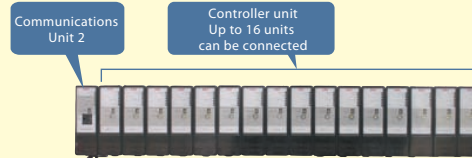

5 Simple absolute specifications that do not require a return to home position

The simple absolute R unit makes it possible to operate incremental specification axes without returning to the home position. By mounting a simple absolute R unit on a RACON unit (RCA controller)/RPCON unit (RCP2 controller), the actuator encoder data is backed up even if the power is cut off.



6 DIN rail installation

The controller is installed with DIN rails, so it can be fastened and removed with one touch.

System configuration

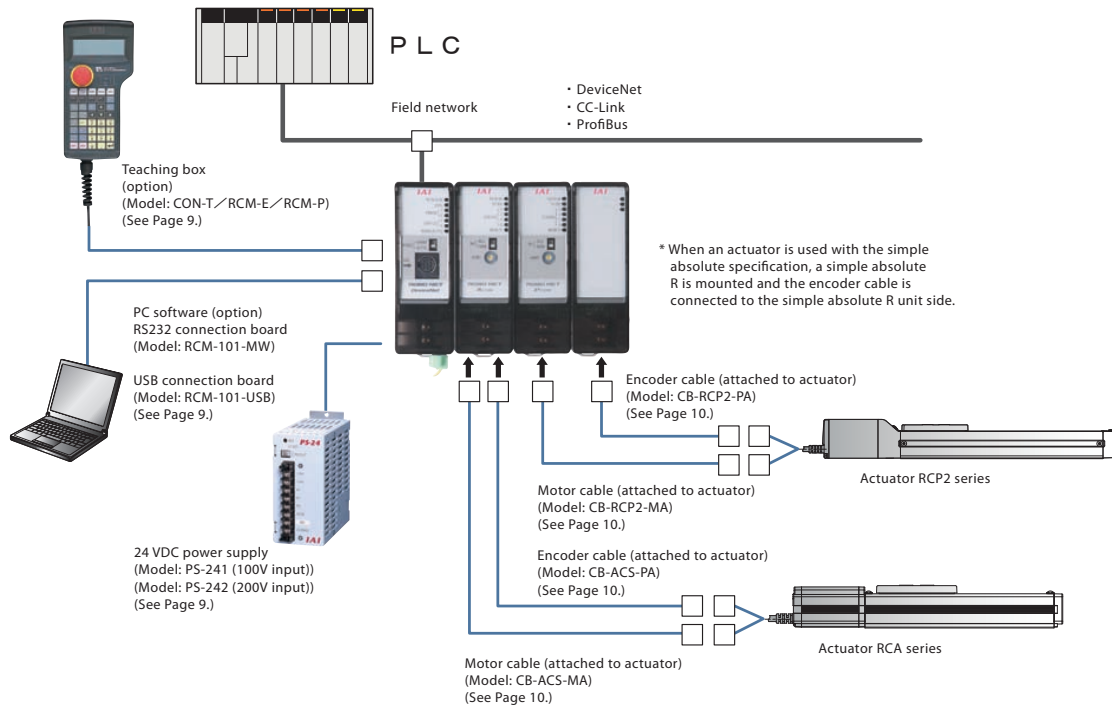

Component unit/ordering method explanation

For RoboNet, you order the required units individually and use them together freely. Even if you want to add actuators later, you can do so simply by ordering additional RACON/RPCON units.



Gateway R unit RACON unit RPCON unit Simple absolute R unit

User's manual

The RoboNet user's manual comes with the RoboNet not as a printed document, but as a CD-ROM. You can also download the user's manual from our homepage.

Unit name	Contents	See Page _
Gateway R unit	This unit is for connection to the field network. There are four types to select from: DeviceNet/CC-Link/Profibus/SIO. * This unit is a required unit for using RoboNet.	P5 P6
RACON unit	This is the controller unit for operating an RCA actuator. (Each actuator axis requires one unit.) The standard specifications are the incremental specifications, but this unit can be used with the simple absolute specifications by just combining with a simple absolute R unit.	P7
RPCON unit	This is the controller unit for operating an RCP2 actuator. (Each actuator axis requires one unit.) The standard specifications are the incremental specifications, but this unit can be used with the simple absolute specifications by just combining with a simple absolute R unit.	P7
Simple absolute R unit	This is the backup battery unit for holding the actuator encoder data when the power is switched Off.	P8

■ **Order method** RoboNet is used by ordering the necessary units one by one and using them together. This means you can add or change units afterwards.

(Order example) Operating the two actuator axes below via CC-Link. The models for operating with absolute specifications are as follows.

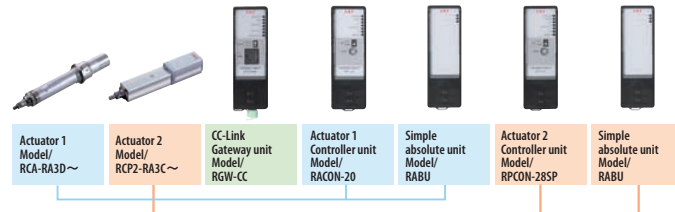

Operating mode explanation

RoboNet operates under instructions received from the PLC via the field network.

It can be used switching among the following three operating modes.

Use the operating mode that best suits the device operation details and control method.

	Name	Contents
1	Positioner mode	This mode operates by specifying the position number. The position data, velocity, acceleration, etc. are input for each position ahead of time. Up to 768 positions can be registered.
2	Simple direct value mode	This mode operates by directly specifying only the position data and specifying other data – velocity, acceleration, position width, electrical current limit for pressing – with the position number. Up to 768 positions can be registered.
3	Direct numeric value specification	This mode operates by directly specifying the numeric values for the position data, velocity, acceleration, position width, and electrical current limit for pressing. There is no limit on the number of position points that can be specified numerically.

List of Functions by Operating Mode

	Positioner mode	Simple direct value mode	Direct numeric value specification
Number of positions registered	768 points	768 points	—
Movement by specifying position number	○	○	×
Direct specification of position data	×	○	○
Direct specification of velocity and acceleration	×	×	○
Direct specification of positioning width	×	×	○
Pressing operation	○ (Specified with position table)	○ (Specified with position table)	○
Completion position number monitor	○	○	×
Zone output monitor	○	○	○
Position zone output monitor	○	○	×
Teaching functions	○	×	×
Jog operations	○	○	○
Incremental moves	○	○	○
Status signal monitor (*)	○	○	○
Current position monitor (*)	○	○	○
Alarm code monitor (*)	○	○	○
Velocity and electric current monitor (*)	×	×	○
Maximum value for specification of position data	9999.99mm	9999.99mm	9999.99mm
Number of axes that can be connected	16	16	8

* The status signal monitor, current position monitor, alarm code monitor, and velocity and electric current monitor can monitor by accessing each address of the GatewayR unit from the PLC.

Component unit explanation

GatewayR unit (DeviceNet specifications)



This is the communications unit for operating RoboNet via DeviceNet.
Model RGW-DV
Specifications

Item	Specifications	Item	Specifications
Power supply	DC24V ±10%	DeviceNet specifications	Communications speed
Current consumption	600 mA max.		Maximum network length
Communications standard	Uses DeviceNet 2.0 certified interface module		Maximum branch line length
	Group 2 only server		Total branch line length
Communications specifications	Insulated node operating with network power supply	Cable length (※1)	500kbps
	Bit strobe		100m
	Master-satellite Connection		250kbps
Communications speed	500k/250k/125kbps (switched with dedicated software)	Number of nodes occupied	250m
			6m
		Usage ambient temperature	500m
			1 node
		Usage ambient humidity	78m
			0 ~ 40°C
		Usage atmosphere	156m
			95% RH max. (no condensation allowed)
		Protection rank	Note: When thick DeviceNet cable is used
			IP20
		Weight	
			140g
		Accessories	
			Terminal resistance board (Model TN-1) Network connector/emergency stop connector

*1 For T branch communications, refer to the user's manuals for the master unit and for the PLC used.

Network connector

Gateway side connector
MSTBA2.5/5-G-5.08 ABGY AU
(Made by Phoenix Contact)

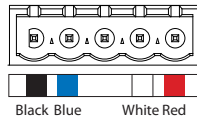

Cable side connector
MSTB2.5/5-ST-5.08 ABGY AU
(Made by Phoenix Contact)
= Standard accessory

Pin colors	Explanation
Black	Power cable - side
Blue	Communications data Low side
—	Shield
White	Communications data High side
Red	Power cable + side

Compatible wire for cable side connector

Item	Contents
Compatible wire diameter	Braided wire AWG24-12 (0.2~2.5 mm ²)
Peeled wire length	7mm

GatewayR unit CC-Link specifications



This is the communications unit for operating RoboNet via CC-Link.
Model RGW-CC
Specifications

Item	Specifications	Item	Specifications				
Power supply	DC24V ±10%	Error control technique	CRS (X ¹⁶ + X ¹² + X ³ + 1)				
Current consumption	600 mA max.	Number of stations occupied	Remote device stations 1x 4 stations, 4x 2 stations, 8x 2 stations				
CC-Link specifications	Communications standard	CC-Link specifications	Communications speed (bps)				
	Communications speed		10M	5M	2.5M	625k	156k
	Communications technique		Total cable length (m)	100	160	400	900
	Synchronization technique	Frame synchronization technique	Environmental conditions	Usage ambient temperature			
	Encoding technique	NRZ 1		Usage ambient humidity			
	Transmission path format	Bus format (complies with EIA RS485)		Usage atmosphere			
	Transmission format	Complies with HDLC		Protection rank			
		IP20					
		Weight					
		140g					
		Accessories	Terminal resistance board (Model TN-1) Network connector/emergency stop connector Terminal resistance cable (110Ω/130Ω)				

*1 Certification acquired

*2 For T branch communications, refer to the user's manuals for the master unit and for the PLC used.

Network connector

Gateway side connector
MSTBA2.5/5-G-5.08AU
(Made by Phoenix Contact)

Cable side connector
MSTB2.5/5-ST-5.08 ABGY AU
(Made by Phoenix Contact)
= Standard accessory

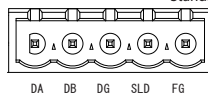

Signal name	Explanation
DA	Communications line A
DB	Communications line B
DG	Ground
SLD	Connect the shield and cable shield to the frame ground and chassis.
FG	Connect the frame ground to the shield and the chassis

Compatible wire for cable side connector

Item	Contents
Compatible wire diameter	Braided wire AWG24-12 (0.2~2.5 mm ²)
Peeled wire length	7mm

GatewayR unit (Profibus specifications)



This is the communications unit for operating RoboNet via Profibus.
Model RGW-PR
Specifications

Item	Specifications	Item	Specifications	
Power supply	DC24V ±10%	Environmental conditions	Usage ambient temperature 0~40°C	
Current consumption	600 mA max.		Usage ambient humidity 95% RH max. (no condensation allowed)	
Profibus specifications	Communications standard	Usage atmosphere	There must be no corrosive gas, combustible gas, oil mist, or dust.	
	Communications speed		DP satellite	Protection rank IP20
	Communications cable length	9.6kbps ~ 12Mbps	Weight	140g
		9.6kbps	1500m	Accessories
		500kbps	400m	
1.5Mbps		200m		
3Mbps	200m			
	12Mbps	100m	Terminal resistance board (Model TN-1) Emergency stop connector	

Network connector

Gateway side connector: 5 1
 D-Sub 9-pin connector
 Socket side

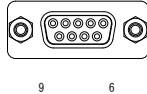

Pin No.	Signal name	Explanation	Pin No.	Signal name	Explanation
3	B - L i n e	Communications line B (RS485)	6	+5V	+5V output (insulated)
4	RTS	Request to send	8	A - L i n e	Communications line A (RS485)
5	GND	Signal ground (insulated)	Housing	S h i e l d	The cable shield is connected with the chassis.

* The partner side connector (D-sub 9-pin connector) does not come as an accessory.

* Pins 1, 2, 7, and 9 are not connected.

GatewayR unit SIO specifications



This is the communications unit for operating RoboNet with serial communications from an XSEL controller (*1) or Modbus communications unit.
***1 A unit with XSEL Gateway functions is scheduled for release soon.**

Model RGW-SIO
Specifications

Item	Specifications	Item	Specifications	
Power supply	DC24V ±10%	Environmental conditions	Usage ambient temperature 0~40°C	
Current consumption	600 mA max.		Usage ambient humidity 95% RH max. (no condensation allowed)	
SIO specifications	Communications format	Usage atmosphere	There must be no corrosive gas, combustible gas, oil mist, or dust.	
	Communications technique		Stop-start system Half duplex	Protection rank IP20
	Communications speed	230.4 kbps max.	Weight	140g
	Cable length	100 m max.	Accessories	Terminal resistance board (Model TN-1) Network connector/emergency stop connector
	Recommended cable	2-pair twisted pair cable (with shield)		

Network connector

Gateway side connector
 MC1.5/4-G-3.5
 (Made by Phoenix Contact)

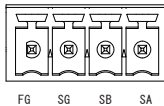

Cable side connector:
 MC1.5/4-ST-3.5
 (Made by Phoenix Contact)
 = Standard accessory

Signal name	Explanation
SA	Communications line A (+ side) RS485 compliant Terminal resistance board (220 Ω) built in
SB	Communications line B (- side)
SG	Signal ground
FG	The frame ground is connected with the chassis.

Compatible wire for cable side connector

Item	Contents
Compatible wire diameter	Braided wire AWG28-16 (0.14~1.5 mm ²)
Peeled wire length	7mm

■ Component unit explanation

RACON unit RCA series controller



This is the controller unit for operating an RCA actuator with RoboNet.

Controller model	Supported actuators
RACON-20	RCA-SA4□ / SS4□ / SA5□ / SS5□ / RA4□-20 / RG□4□-20 / A4R / A5R RCACR-SA4C / SA5□ RCAW-RA4□-20
RACON-20S	RCA-RA3□ / RG□3□ RCAW-RA3□
RACON-30	RCA-SA6□ / SS6□ / RA4□-30 / RG□4□-30 / A6R RCACR-SA6□ RCAW-RA4□-30

Specifications

Item	Specifications	Item	Specifications		
General specifications	Power supply	DC24V ±10%	Environmental conditions	Usage ambient temperature	0~50°C
	Power supply capacity	5.1 A max. (depends on actuator)		Usage ambient humidity	95% RH max. (no condensation allowed)
	Operating actuator	RCA series		Usage atmosphere	There must be no corrosive gas, combustible gas, oil mist, or dust.
	Number of positioning points	768 points		Protection rank	IP20
	Backup memory	EEPROM	Weight	200g	
	Position detection technique	Incremental encoder	Accessories	RoboNet communication connection board (JB-1 model)	
	Electromagnetic brake forced release	Brake release switch		Power supply connection board (PP-1 model)	
	Motor cable	Model CB-ACS-MA			
	Encoder cable	Model CB-ACS-PA			

RPCON unit RCP2 series controller



This is the controller unit for operating an RCP2 actuator with RoboNet.

Controller model	Supported actuators
RPCON-20P	RCP2-RA2C / GRS
RPCON-28P	RCP2-GRM / GR3LS / GR3SS / RTB / RTC
RPCON-28SP	RCP2-RA3C / RGD3C
RPCON-42P	RCP2-SA5□ / SA6□ / SS7□ / BA6□ / BA7□ / RA4C / RG□4C / GR3LM / GR3SM RCP2CR-SA5C / SA6C / SS7C RCP2W-RA4C
RPCON-56P	RCP2-SA7□ / SS8□ / RA6C / RG□6C / RCP2CR-SA7C / SS8C RCP2W-RA6C

* This controller can also operate an old-type RCP2 actuator. (Please inquire for details.)

Specifications

Item	Specifications	Item	Specifications		
General specifications	Power supply	DC24V ±10%	Environmental conditions	Usage ambient temperature	0~50°C
	Power supply capacity	2 A max.		Usage ambient humidity	95% RH max. (no condensation allowed)
	Operating actuator	RCP2 series		Usage atmosphere	There must be no corrosive gas, combustible gas, oil mist, or dust.
	Number of positioning points	768 points		Protection rank	IP20
	Backup memory	EEPROM	Weight	200g	
	Position detection technique	Incremental encoder	Accessories	RoboNet communication connection board (JB-1 model)	
	Electromagnetic brake forced release	Brake release switch		Power supply connection board (PP-1 model)	
	Motor cable	Model CB-RCP2-MA			
	Encoder cable	Model CB-RCP2-PA			

Simple absolute R unit



This is a data backup battery unit that is connected to a RACON/RPCON unit to allow incremental specifications actuators to be used as absolute specifications actuators.

*1 One simple absolute R unit is required for each RACON/RPCON unit.

Model **RABU** (Common to RACON/RPCON)

Specifications

Item	Specifications				Item	Specifications		
General specifications	Power supply	DC24V ±10%				Environmental conditions	Usage ambient temperature	0~40°C
	Current consumption	300 mA max.					Usage ambient humidity	95% RH max. (no condensation allowed)
	Battery used	Nickel metal hydride battery (Ni-MH)					Usage atmosphere	There must be no corrosive gas, combustible gas, oil mist, or dust.
	Charge time	About 78 hours					Protection rank	IP20
	Battery life	3 years					Weight	330g
General specifications	Can store absolute data Maximum rotation rate (rpm)	800	400	200	100	Accessories	RoboNet communication connection board (JB-1 model)	
	Absolute data storage time (h)	120	240	360	480		Simple absolute specifications connection board (JB-1 model)	
							Power supply connection board (PP-1 model)	

External dimensions diagram

GatewayR unit/RACON unit/RPCON unit/simple absolute R unit all share the same external dimensions.

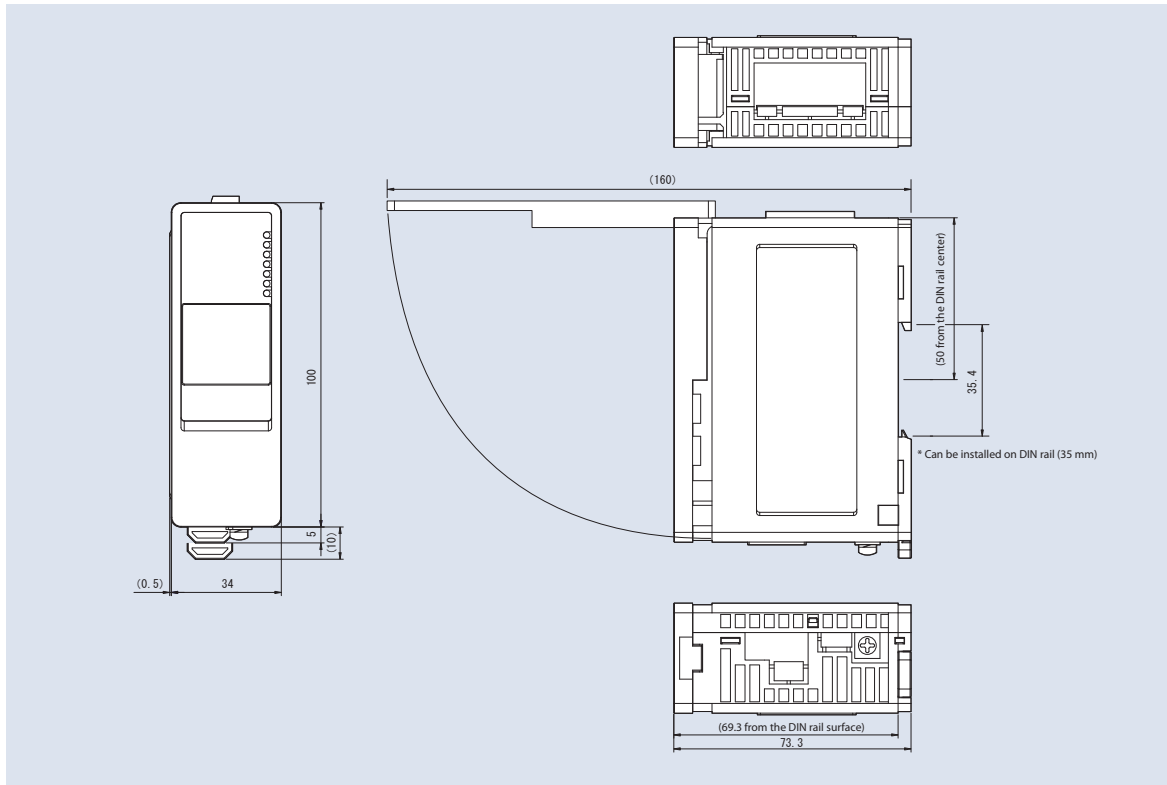

Options

Teaching box

- Features This is a teaching device equipped with position input, test run, monitor, and other functions.
- Model **CON-T** (standard type)
RCM-E (simple teaching box)
RCM-P (data setting unit)
- Configuration

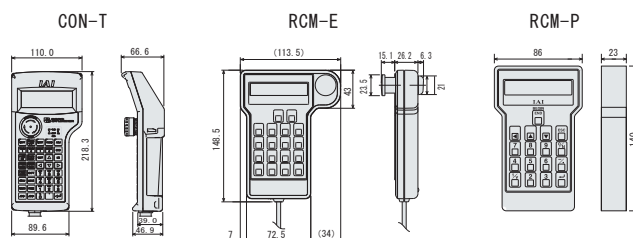
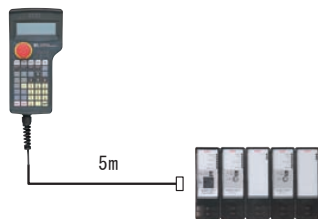

Specifications

Item	CON-T	RCM-E	RCM-P
Data input	○	○	○
Actuator operation	○	○	×
Usage ambient temperature and humidity	Temperature 0 to 40°C Relative humidity 85% max.		
Usage atmosphere	No corrosive gas allowed Dust must not be particularly bad.		
Protection rank	IP54	—	—
Weight	About 400g	About 400g	About 360g
Cable length	5m		
Display	20-character by 4-line LCD display	16-character by 2-line LCD display	16-character by 2-line LCD display

PC software (for Windows only)

- Features This is startup support software equipped with program/position input, test run, monitor, and other functions. It increases functions required for debugging operations and contributes to shortening the start-up time.
- Model **RCM-101-MW** (with external device communications cable + RS232 converter unit)

Configuration

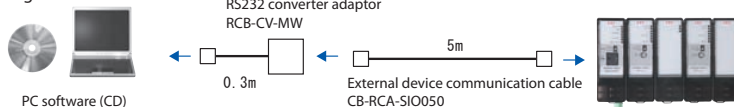

- Model **RCM-101-USB** (with external device communications cable + USB cable)

Configuration

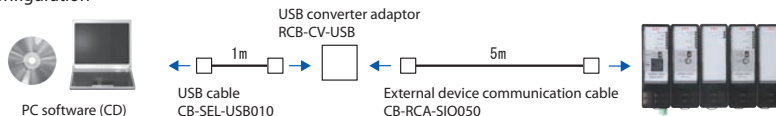

24 VDC power supply

Features

This is a 24V power supply for a robocylinder that output an instantaneous maximum of 17 A. Since power supply parallel operation is possible, if one power supply unit has insufficient capacity, up to five units can be added.

Model

PS-241
(100V input specifications)
PS-242
(200V input specifications)

Relationship between actuator and power supply current

Control type	Actuator type	Power supply current [A]		PS-24 Number of units that can be connected per unit	
		Rated (=maximum)	2	When the servos come On for all axes at the same time*	When the servos does not come On for all axes at the same time*
RPCON PDCON PSEL	RCP2 all models (*)	Rated	2	8	8
		Maximum	4.4		
RACON ACON ASEL	SA4, SA5 (20W)	Rated	1.3	3	6
		Maximum	4		
	SA6 (30W)	Rated	1.3	4	6
		Maximum	4		
	RA3 (20W)	Rated	1.7	3	5
		Maximum	5.1		
RA4 (20W)	Rated	1.3	3	6	
	Maximum	4.4			
RA4 (30W)	Rated	1.3	4	6	
	Maximum	4			

* This indicates the first servo to come On after the power is switched on.
Note: Except HS8C, HS8R, or RAI0C.



Maintenance parts

When it is necessary to make arrangements for a replacement cable or the like after product purchase, find the model below.

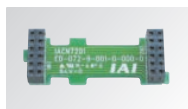

RoboNet communication connection board (simple absolute connection board) Model JB-1



Terminal resistance board Model TN-1



Power supply connection board Model PP-1

RACON motor cable

Motor cable

Model CB-ACS-MA□□□

* For __, enter the cable length (L), up to 20 meters. Example: 080=8 meters

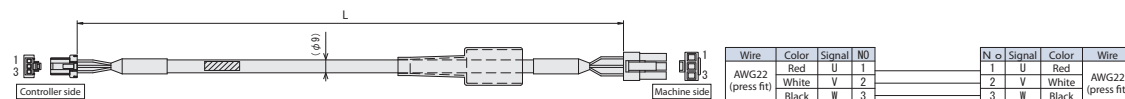

RACON encoder cable

Encoder cable/encoder robot cable

Model CB-ACS-PA□□□□/CB-ACS-PA□□□□-RB

* The standard encoder cable is the normal cable. A robot cable is available as an option.
* For __, enter the cable length (L), up to 20 meters. Example: 080=8 meters

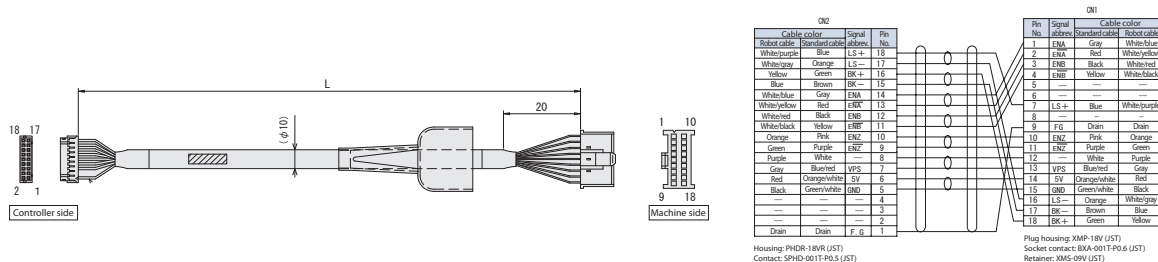

RPCON motor cable

Motor cable

Model CB-RCP2-MA□□□

* The standard motor cable is a robot cable. Can be selected
* For __, enter the cable length (L), up to 20 meters. Example: 080=8 meters

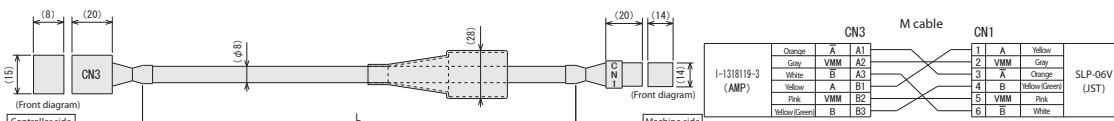

RPCON encoder cable

Encoder cable/encoder robot cable

Model CB-RCP2-PA□□□□/CB-RCP2-PA□□□□-RB

* The standard encoder cable is the normal cable. A robot cable is available as an option.
* For __, enter the cable length (L), up to 20 meters. Example: 080=8 meters

