

ROBO Cylinder®

Power CON

RCP4 Series PCON-CA

**ROBO
CYLINDER**

Newest additions to the series!

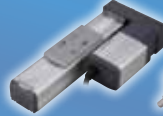

Side-Mounted Motor Type



Cleanroom Type

High Speed
High power
RCP4



Sold & Serviced By:

ELECTROMATE

Toll Free Phone (877) SERV098

Toll Free Fax (877) SERV099

www.electromate.com

sales@electromate.com

Power CON Realizing

1.5 Times the Speed and Double the Payload

The Power CON 150 series boosts the performance of ROBO Cylinder
 The **side-mounted motor specification** and **cleanroom specification**

- ▶ Improved dynamic performance (the speed is up to 1.5 times and payload is up to twice *Specific values vary depending on the model.
- ▶ New functions designed to enhance maintainability enable preventative maintenance,
- ▶ The smart tuning function lets you set up the operation of your equipment optimally with



RCP4 Series Variations

Model type	Series	Shape	Type	External view	Actuator size (width)	Stroke	Ball screw lead (mm)	Maximum Speed (mm/s)	Maximum payload (kg)		Page
									Horizontal	Vertical	
Straight motor specification	RCP4	Slider type	SA5C		52mm	50~800	20	1440	6.5	1	p.9
							12	900	9	2.5	
							6	450	18	6	
			3	225	20		12				
			20	1440	10		1				
			12	900	15		2.5				
	SA6C		58mm	6	450	25	6				
				3	225	25	12				
				24	1200	20	3				
	SA7C		73mm	16	980	40	8				
				8	490	45	16				
				4	245	45	25				
RCP4	Rod type	RA5C		52mm	50~400	20	800	6	1.5	p.21	
						12	700	25	4		
						6	450	40	10		
		3	225	60		20					
		24	800	20		3					
		16	700	50		8					
RA6C		61mm	8	420	60	18					
			4	210	80	28					

*The maximum horizontal payload for the rod type is for when an external guide is used in combination.

Controller

Series	Type	Page
PCON	CA	p.40

1

150% the Output, Achievable with Standard Controllers

standard motorized cylinders to amazing new heights.
(class 10) have been added to the power controller RCP4 series.

IAI's conventional models*) significantly boosts the productivity of your system.

so less time is needed for maintenance.
ease.

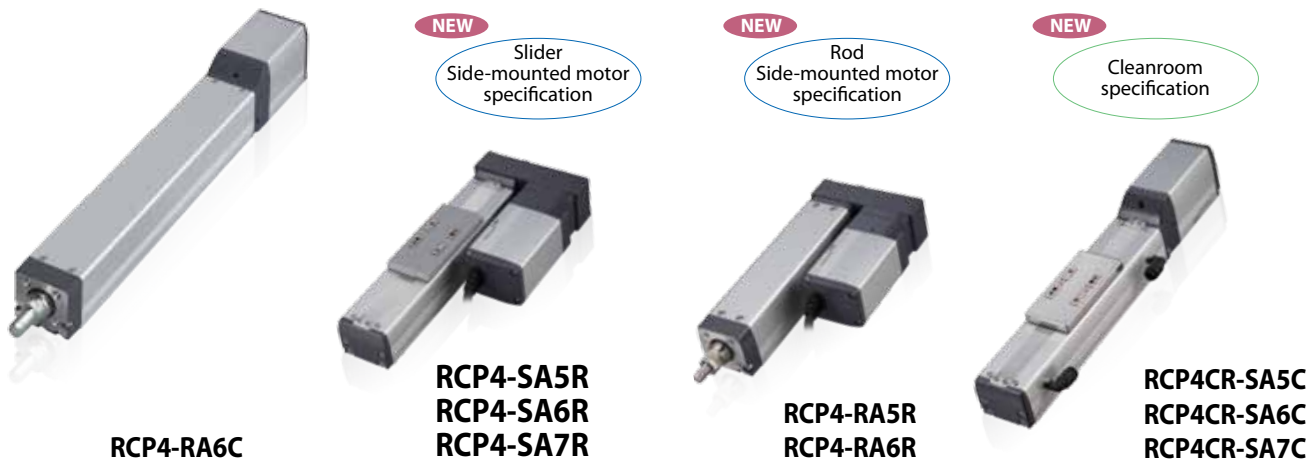

Model type	Series	Shape	Type	External view	Actuator size (width)	Stroke	Ball screw lead (mm)	Maximum Speed (mm/s)	Maximum payload (kg)		Page	
									Horizontal	Vertical		
NEW Side-mounted motor specification	RCP4	Slider type	SA5R		52mm	50~800	20	1440	6.5	1	P.15	
							12	900	9	2.5		
							6	450	18	6		
			SA6R		58mm		3	225	20	12	P.17	
							20	1280	10	1		
							12	900	15	2.5		
	SA7R		73mm	6	450	25	6	P.19				
				3	225	25	12					
				24	1000	20	3					
	NEW Rod type	RCP4	Rod type	RA5R		52mm	50~400	16	840	40	8	P.25
								8	490	45	16	
								4	210	45	25	
RA6R					61mm	20		800	6	1.5	P.27	
						12		700	25	4		
						6		450	40	10		
NEW Cleanroom specification	RCP4CR	Slider type	SA5C		52mm	50~800	3	225	20	12	P.29	
							20	1440	10	1		
							12	900	15	2.5		
			SA6C		58mm		6	450	25	6	P.31	
							3	225	25	12		
							24	1200	20	3		
	SA7C		73mm	16	980	40	8	P.33				
				8	490	45	16					
				4	245	45	25					

Features

Shorter Takt Time Significantly Boosts

New Functions of RCP4 Actuator

1 1.5 times higher maximum speed and double the payload when combined with a Power CON 150

When the new controller (Power CON 150) equipped with our newly developed high-output driver (patent pending) is used, the maximum speed increases significantly by up to 1.5 times the levels achievable with IAI's conventional models, while the payload is greater by up to twice (*). In addition to these amazing improvements in specifications, the maximum speed does not drop as much even when the payload increases due to increased torque with the high speed motor, meaning that dynamic performance equivalent to that of a higher-class model can be achieved at lower cost.

(* The specific rates of improvement vary depending on the model.



Power CON 150 PCON-CA

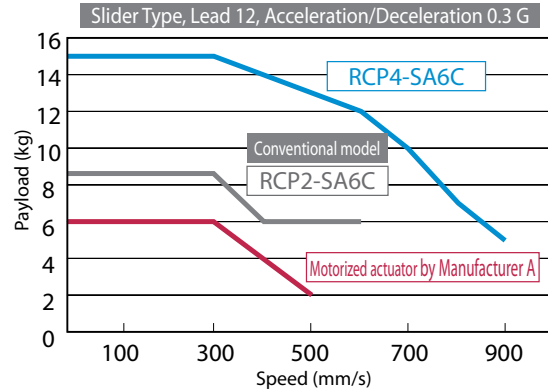

Correlation Diagram of Speed and Payload

2 Extended lineup with the latest additions: the side-mounted motor specification and the cleanroom specification

Three slider types (SA5/SA6/SA7) and two rod types (RA5/RA6) are now available in the side-mounted motor specification characterized by a significantly shorter overall length for space-saving design. Three slider types are also available in the cleanroom specification conforming to cleanliness class 10.

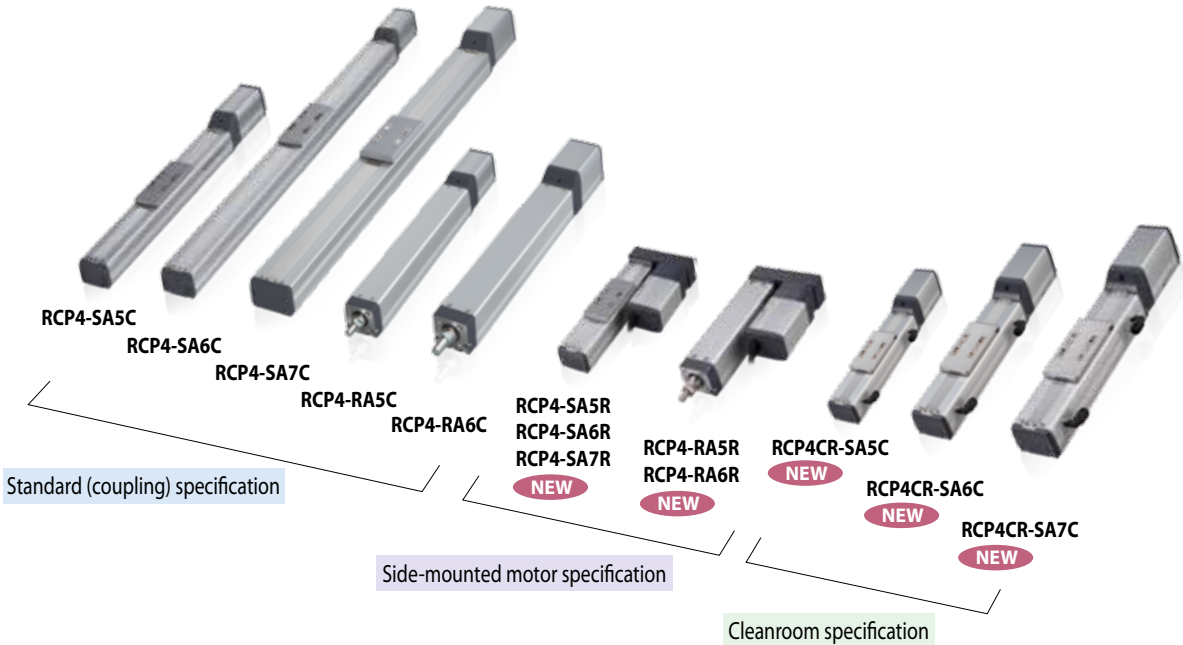

3

the Productivity of Your System

3 The rod type <Radial Cylinder> with a built-in guide mechanism can carry radial loads over a long stroke (500mm).

The rod type <Radial Cylinder> has a built-in guide mechanism in the actuator to carry radial loads on the rod over a long stroke of up to 500 mm. The actuator can also support a radial load at a position offset from the center of the rod.

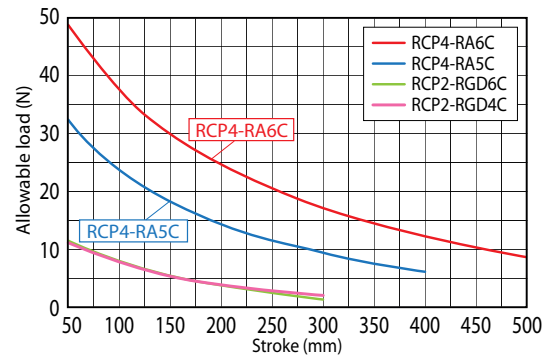
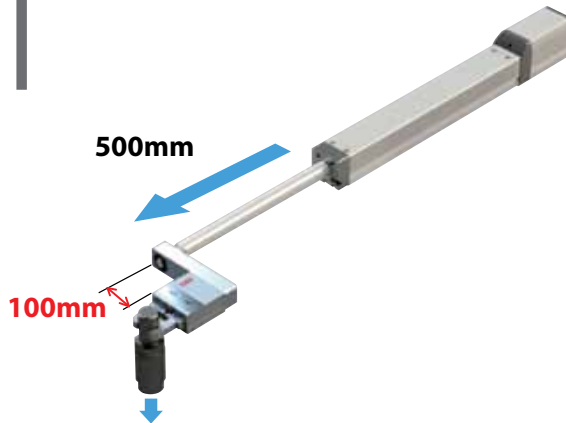

4 Easy replacement of the motor with removal of only one setscrew

The motor has been unitized for easy replacement. The actuator and motor unit can be separated and replaced by removing only one setscrew, so the time required for maintenance becomes significantly shorter.

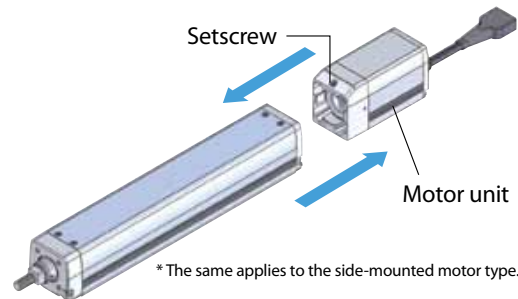

5 Slider types have mounting holes compatible with the RCP2

Slider types have mounting holes that are compatible with RCP2 actuators, meaning that you can replace your current RCP2 actuator with a RCP4 with ease. Also, the mounting holes provided on rod types are the same as those found on the RCP2, and reamed holes are also provided to significantly improve installation repeatability.

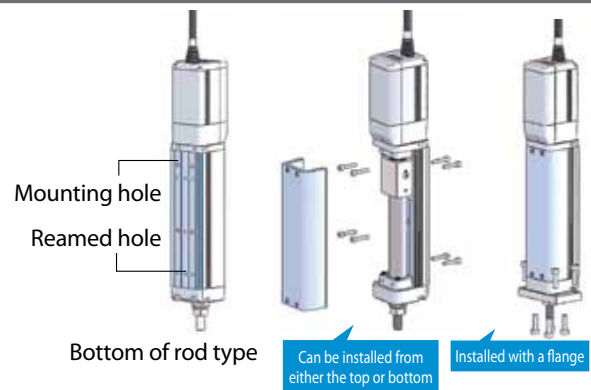

Features

New Functions to Enhance Maintainability

New Functions of Power CON 150 PCON-CA

6 Keep track of the production volume and utilization ratio with the total movement counter function

The total number of times the actuator has moved is counted and recorded in the controller, and a signal is output to an external device once the pre-defined count is exceeded. This function can be used to keep track of the production volume, utilization ratio, etc.

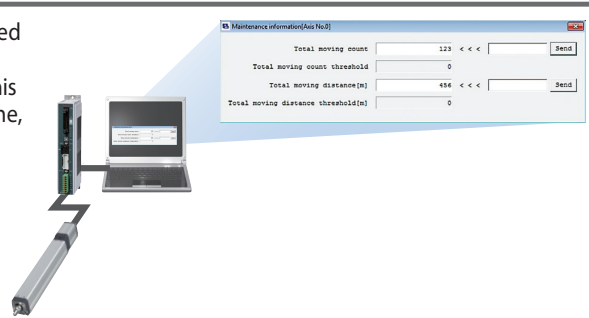

7 Know when to perform maintenance with the total travel counter function

The total distance travelled by the actuator is counted and recorded in the controller, and a signal is output to an external device once the pre-defined count is exceeded. By using this function, you know when to add grease or perform periodic maintenance.

8 Retain alarm generation times with the calendar function

The calendar function (clock function) lets you add timestamps to the history of alarms, etc. This information is useful in troubleshooting, etc.

Data type	Code	Message	Date	Time
Detected Alarm	FFF	PowerSTP No. Error	11/11/16	11:07:58
History 1	OCE	Control power voltage reduction	11/11/05	04:54:48
History 2	FFF	PowerSTP No. Error	11/11/05	04:54:48
History 3	OCE	Control power voltage reduction	11/11/05	05:14:37
History 4	FFF	PowerSTP No. Error	11/11/05	05:14:37
History 5	OCE	Control power voltage reduction	11/11/02	10:17:38
History 6	OCE	Control power voltage reduction	11/11/02	10:17:38
History 7	FFF	PowerSTP No. Error	11/11/02	10:05:48
History 8				
History 9				
History 10				
History 11				
History 12				
History 13				
History 14				
History 15				

9 The smart tuning function lets you set up the operation conditions of your equipment optimally with ease

The smart tuning function is a new feature introduced to the ROBO Cylinder PC software (version 8.03.00.00 or later) and touch panel teaching pendant (model number: CON-PTA). When the actuator is connected to a controller supporting the smart tuning function, all the user needs is to enter the actuator type, transfer load, etc., and the optimal acceleration/ deceleration and speed will be set automatically according to the load.

- Setting the acceleration/deceleration from the speed**
Enter a desired speed in the position data table, and the maximum settable acceleration/deceleration will be set automatically according to the pre-defined load-speed combinations.
- Setting the acceleration/deceleration and speed from the travel**
Specify the position data number associated with desired start/end positions of movement and set a desired travel distance, and the combination of acceleration/deceleration and speed that gives the shortest travel time will be set automatically.

10 Three controller operation types to choose from

- Positioner type** that operates the actuator via ON/OFF of PIOs
- Pulse-train type** that operates the actuator by sending pulses from the positioning unit
- Field network type** that operates the actuator by sending position data via the network

5

System Configuration

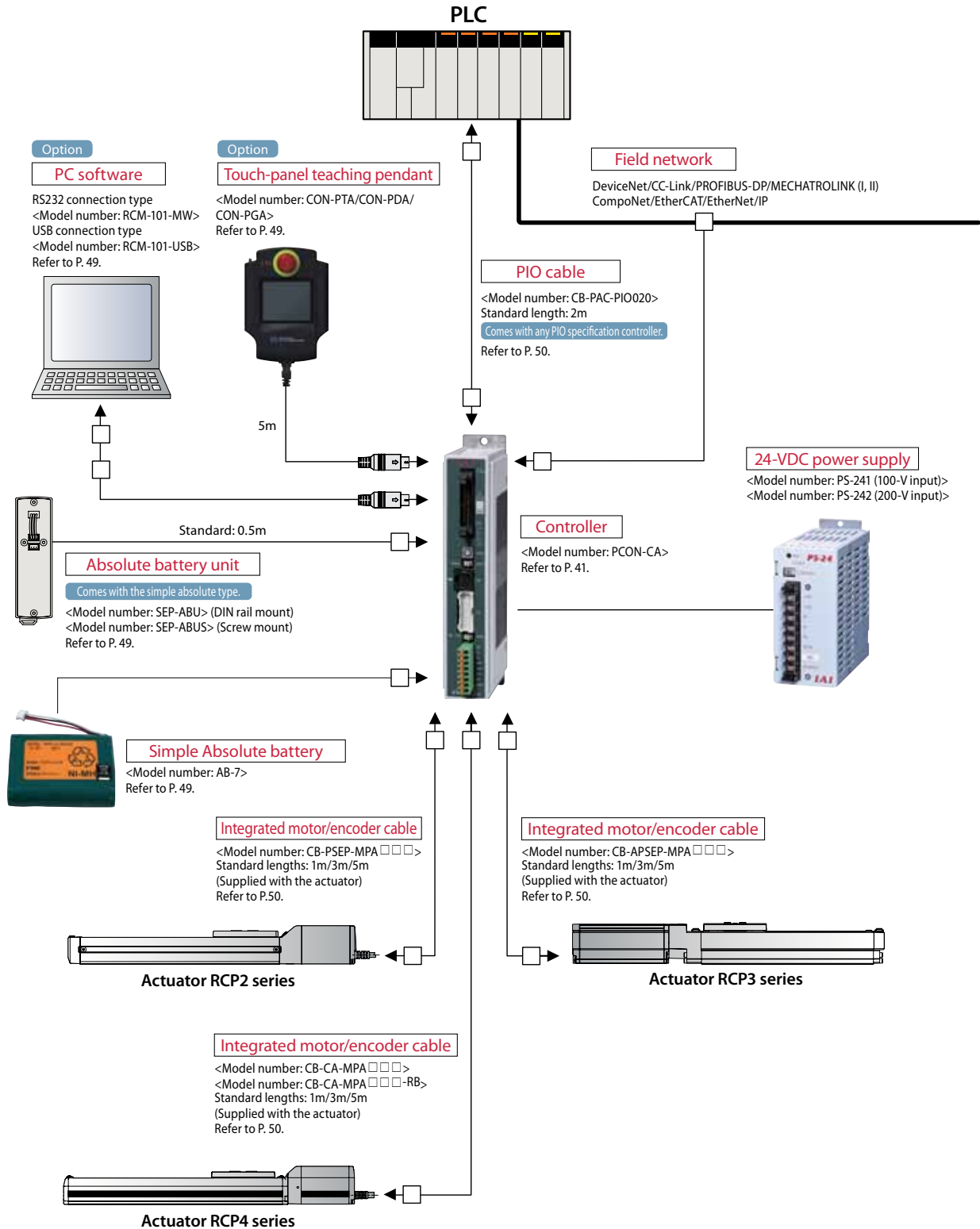

Model Specification Items

<Slider type>

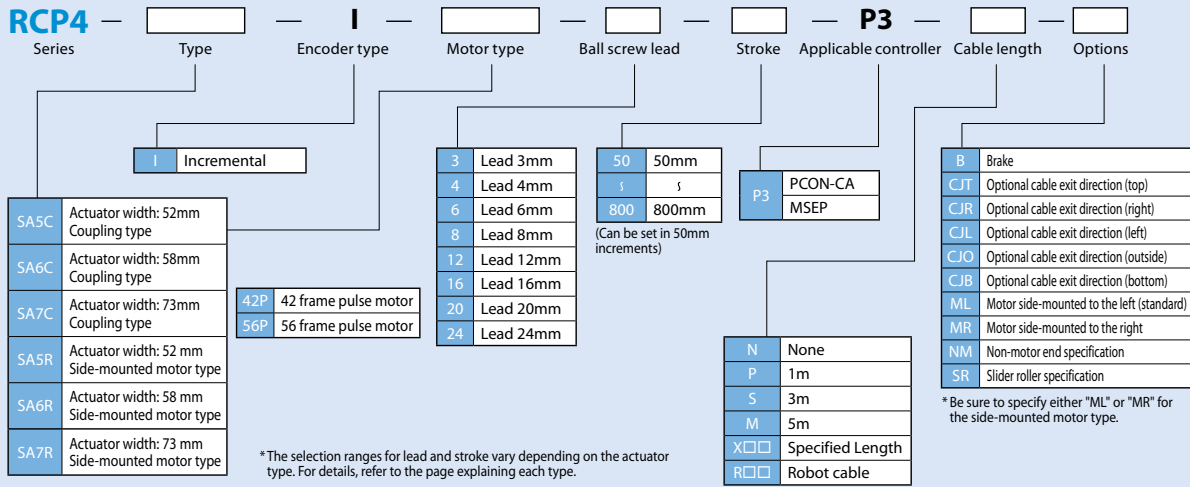

<Rod type>

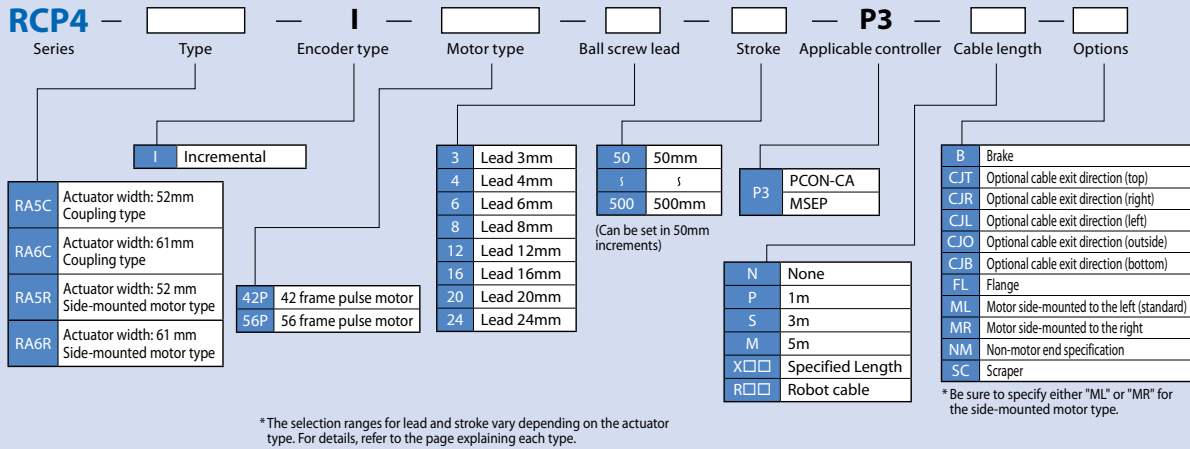

<Cleanroom type>

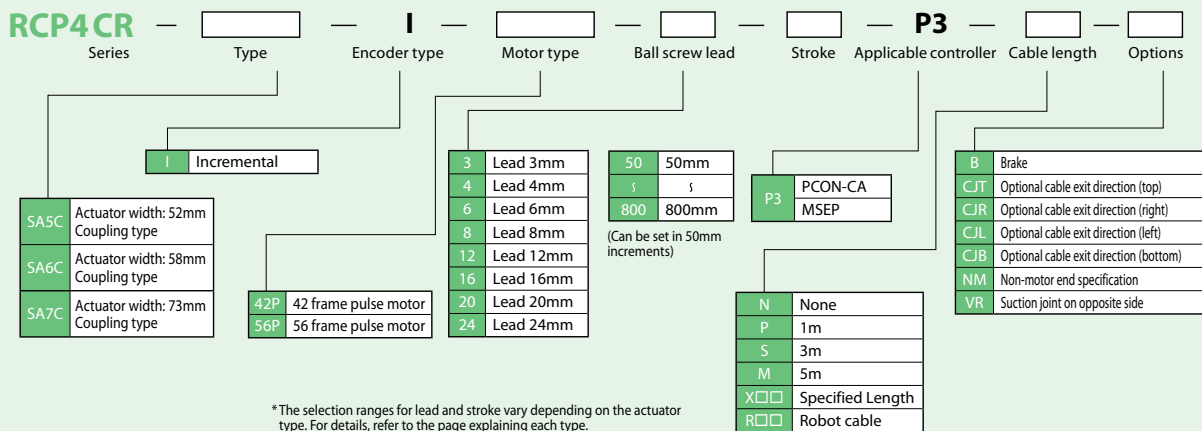

Actuator Options

Brake
Option code: B

All models

Description

A mechanism to hold the slider in place when the actuator is used vertically, so that it will not drop and damage the work part, etc., when the power or servo is turned off.

Optional cable exit direction
Option code: CJT
CJR
CJL
CJB
CJO

Applicable models

All models

Description

The actuator cable exit direction from the motor cover of the actuator is changed.

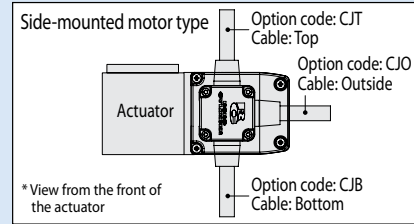
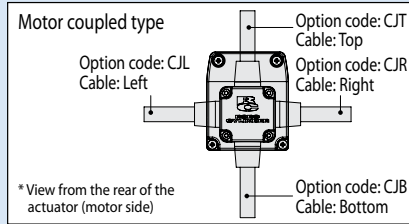

Motor side-mounted direction
Option code: ML/MR

* Be sure to specify either "ML" or "MR" for the side-mounted motor type.

Applicable models

RCP4-SA5R/SA6R/SA7R/RA5R/RA6R

Description

The motor side-mounted direction can be specified. ML and MR represent the left and right, respectively, as viewed from the motor side of the actuator.

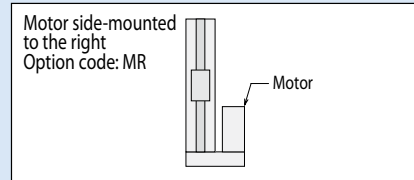
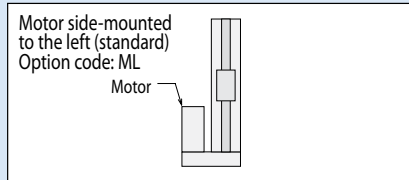

Non-motor end specification
Option code: NM

Applicable models

All models

Description

Select this option if you want to change the home position of the actuator slider or rod from the normal position (motor end) to the front end.

Flange
Option code: FL

Applicable models

RCP4-RA5C/RA6C/RA5R/RA6R

Description

A bracket used to secure a rod actuator from the actuator side. The flange can be purchased separately later on.

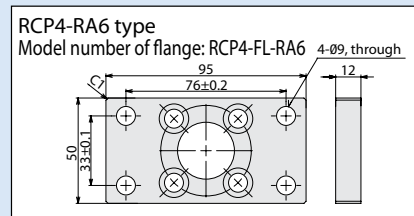
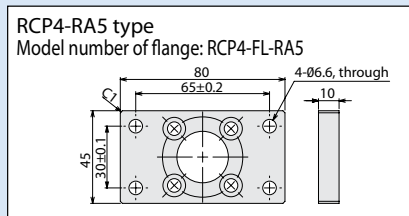

Scraper
Option code: SC

Applicable models

RCP4-RA5C/RA6C/RA5R/RA6R

Description

When a rod actuator is used, select this option if you want to prevent dust attached to the rod from entering the actuator.

Slider roller specification
Option code: SR

Applicable models

RCP4-SA5C/SA6C/SA7C/SA5R/SA6R/SA7R

Description

The slider of the standard slider type specification is changed to the same roller structure of the cleanroom specification. When the slider roller specification is selected, the appearance and dimensions of the slider cover become the same as those of the cleanroom specification.

Vacuum joint on opposite side
Option code: VR

Applicable models

RCP4CR-SA5C/SA6C/SA7C

Description

The standard specification is that the vacuum joint is installed on the left side of the actuator as viewed from the motor side. This option changes the vacuum joint position to the right side (opposite side).

RCP4-SA5C

ROBO Cylinder, Slider Type, Motor Unit Coupled, Actuator Width 52mm, 24-V Pulse Motor

Model Specification Items	RCP4	SA5C	I	42P	<input type="checkbox"/>	<input type="checkbox"/>	P3	<input type="checkbox"/>	<input type="checkbox"/>
	Series	Type	Encoder type	Motor type	Lead	Stroke	Applicable controller	Cable length	Options
			I: Incremental specification	42P: Pulse motor, size 42□	20: 20mm 12: 12mm 6: 6mm 3: 3mm	50: 50mm 800: 800mm (every 50mm)	P3: PCON-CA MSEP-C	N: None P: 1m S: 3m M: 5m X□: Specified length R□: Robot cable	Refer to the options table below.



- (1) The maximum payload is the value when operated at 0.3G (0.2G with some models) acceleration. The upper limit of acceleration is 1 G (*). Note that raising the acceleration causes the payload to drop.
(*): The specific value varies depending on the connected controller and actuator lead. For details, refer to "Selection References" on P. 37 to 40.
- (2) Take note that the maximum payload and maximum speed vary depending on the controller connected to the RCP4. (Refer to the actuator specifications below.)

Correlation Diagrams of Speed and Payload

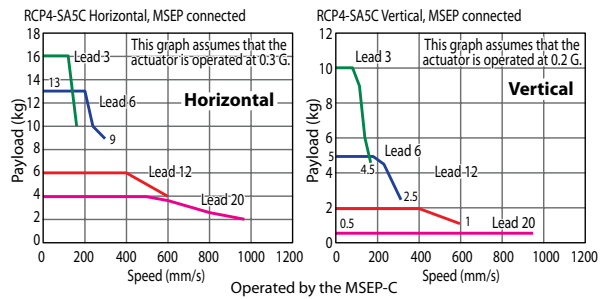
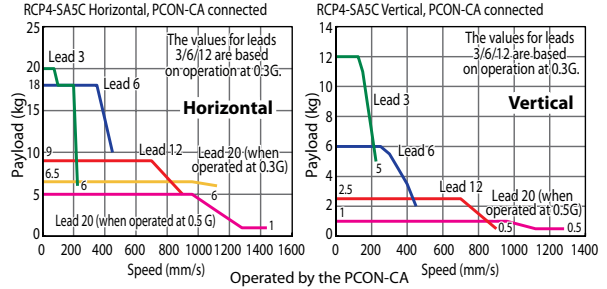

Actuator Specifications

Leads and Payloads

Model number	Lead (mm)	Connected controller	Maximum payload		Stroke (mm)
			Horizontal (kg)	Vertical (kg)	
RCP4-SA5C-I-42P-20-①-P3-②-③	20	PCON-CA	6.5	1	50~800 (every 50mm)
		MSEP-C	4	0.5 (*)	
RCP4-SA5C-I-42P-12-①-P3-②-③	12	PCON-CA	9	2.5	
		MSEP-C	6	2	
RCP4-SA5C-I-42P-6-①-P3-②-③	6	PCON-CA	18	6	
		MSEP-C	13	5	
RCP4-SA5C-I-42P-3-①-P3-②-③	3	PCON-CA	20	12	
		MSEP-C	16	10	

Code explanation ① Stroke ② Cable length ③ Options (*) When operated at 0.2 G

Stroke and Maximum Speed

Lead (mm)	Connected controller	Stroke (mm)							
		50~450 (every 50mm)	500	550	600	650	700	750	800
20	PCON-CA	1440 <1280>	1225	1045	900	785	690	610	
	MSEP-C	960			900	785	690	610	
12	PCON-CA	900	795	665	570	490	425	375	330
	MSEP-C	600		570	490	425	375	330	
6	PCON-CA	450	395	335	285	245	215	185	165
	MSEP-C	300		285	245	215	185	165	
3	PCON-CA	225	195	165	140	120	105	90	80
	MSEP-C	150		140	120	105	90	80	

The values in <> apply when the actuator is used vertically. (unit: mm/s)

① Stroke

Stroke (mm)	Standard price	Stroke (mm)	Standard price
50	—	450	—
100	—	500	—
150	—	550	—
200	—	600	—
250	—	650	—
300	—	700	—
350	—	750	—
400	—	800	—

② Cable Length

Type	Cable symbol	Standard price
Standard type	P (1m)	—
	S (3m)	—
	M (5m)	—
Special length	X06 (6m) ~X10 (10m)	—
	X11 (11m) ~X15 (15m)	—
	X16 (16m) ~X20 (20m)	—
Robot cable	R01 (1m) ~R03 (3m)	—
	R04 (4m) ~R05 (5m)	—
	R06 (6m) ~R10 (10m)	—
	R11 (11m) ~R15 (15m)	—
	R16 (16m) ~R20 (20m)	—

③ Options

Name	Option code	See page	Standard price
Brake	B	P8	—
Optional cable exit direction (top)	CJT	P8	—
Optional cable exit direction (right)	CJR	P8	—
Optional cable exit direction (left)	CJL	P8	—
Optional cable exit direction (bottom)	CJB	P8	—
Non-motor end specification	NM	P8	—
Slider roller specification	SR	P8	—

Actuator Specifications

Item	Description
Drive system	Ball screw ϕ 10mm, rolled C10
Positioning repeatability (*1)	± 0.02 mm [± 0.03 mm]
Lost motion	0.1mm or less
Base	Material: Aluminum with white alumite treatment
Guide	Linear guide
Dynamic allowable moment (*2)	Ma: 4.9 N·m, Mb: 6.8 N·m, Mc: 11.7 N·m
Allowable overhang	150mm or less in Ma, Mb and Mc directions
Ambient operating temperature, humidity	0 to 40°C, 85% RH or less (Non-condensing)

(*1) The value at lead 20 is shown in []. (*2) Based on 5,000km of traveling life

- *1 Connect the motor and encoder cables.
- *2 During home return, be careful to avoid interference from peripheral objects because the slider travels until the mechanical end.

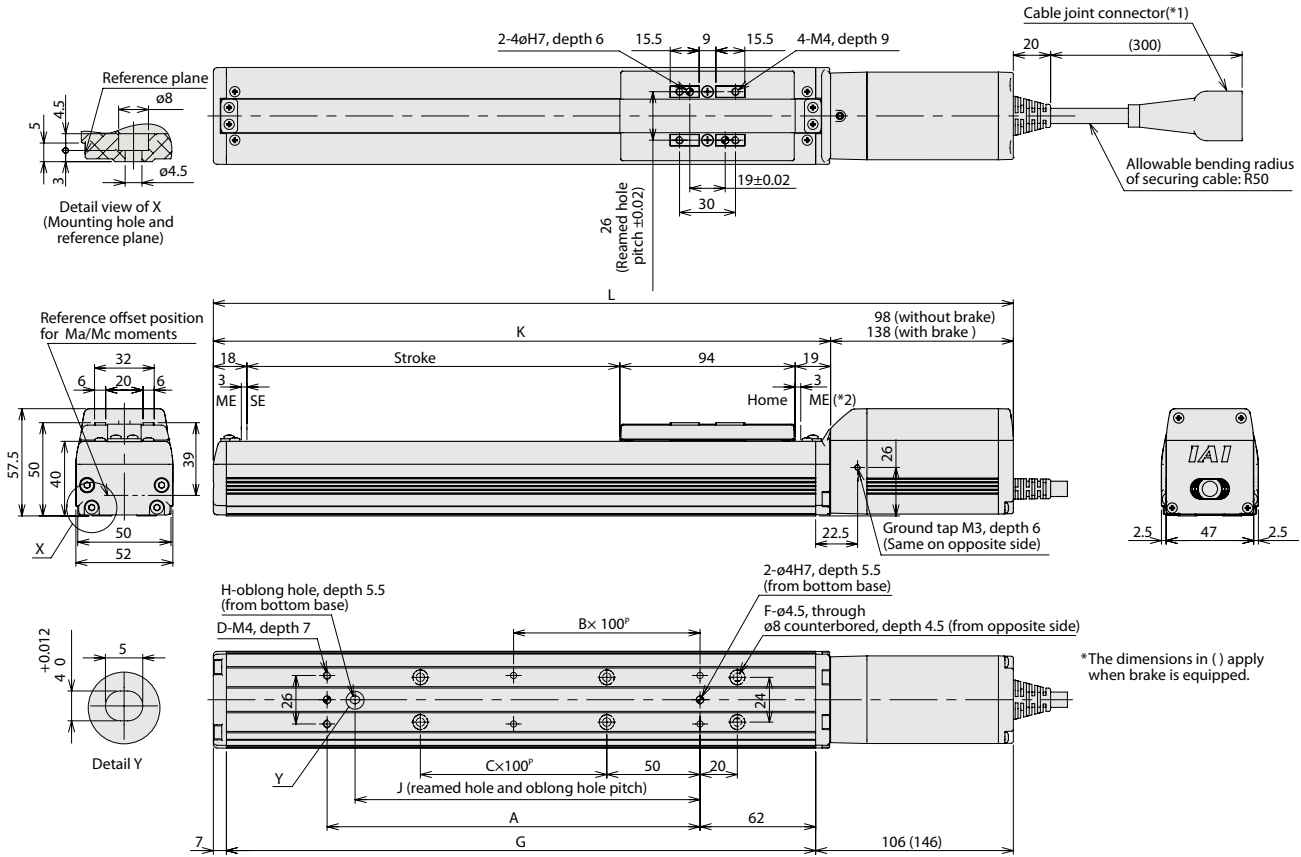

■ Dimensions and Mass by Stroke

Stroke	50	100	150	200	250	300	350	400	450	500	550	600	650	700	750	800	
L	Without brake	279	329	379	429	479	529	579	629	679	729	779	829	879	929	979	1029
	With brake	319	369	419	469	519	569	619	669	719	769	819	869	919	969	1019	1069
A	73	100	100	200	200	300	300	400	400	500	500	600	600	700	700	800	
B	0	0	0	1	1	2	2	3	3	4	4	5	5	6	6	7	
C	0	0	1	1	2	2	3	3	4	4	5	5	6	6	7	7	
D	4	4	4	6	6	8	8	10	10	12	12	14	14	16	16	18	
F	4	4	6	6	8	8	10	10	12	12	14	14	16	16	18	18	
G	166	216	266	316	366	416	466	516	566	616	666	716	766	816	866	916	
H	0	1	1	1	1	1	1	1	1	1	1	1	1	1	1	1	
J	0	85	85	185	185	285	285	385	385	485	485	585	585	685	685	785	
K	181	231	281	331	381	431	481	531	581	631	681	731	781	831	881	931	
Mass (kg)	Without brake	1.5	1.6	1.8	1.9	2.1	2.2	2.4	2.5	2.6	2.8	2.9	3.1	3.2	3.4	3.5	3.7
	With brake	1.7	1.9	2.0	2.1	2.3	2.4	2.6	2.7	2.9	3.0	3.2	3.3	3.5	3.6	3.7	3.9

Applicable Controller

RCP4 series actuators can be operated with the controller indicated below. Select the type according to your intended application.

Name	External view	Model number	Features	Maximum number of positioning points	Input power	Power supply capacity	Standard price	Reference page
Positioner type		PCON-CA-42PI-NP-□-0-□ PCON-CA-42PI-PN-□-0-□	Equipped with a high-output driver Positioner type based on PIO control	512 points	DC24V	Refer to P. 48	—	Refer to P. 41
Pulse-train type		PCON-CA-42PI-PLN-□-0-□ PCON-CA-42PI-PLP-□-0-□	Equipped with a high-output driver Pulse-train input type	—				
Field network type		PCON-CA-42PI-△-0-0-□	Equipped with a high-output driver Supporting 7 major field networks	768 points				
Positioner multi-axis specification PIO type		MSEP-C-□-~-NP-□-0-□ MSEP-C-□-~-PN-□-0-□	Positioner type based on PIO control, allowing up to 8 axes to be connected (high-output driver not supported)	3 points				
Positioner multi-axis specification Network type		MSEP-C-□-~-△-0-0-□	Field network-ready positioner type, allowing up to 8 axes to be connected (high-output driver not supported)	256 points				

*In the model numbers shown above, △ indicates the field network specification (DV, CC, PR, CN, ML, EC or EP).

RCP4-SA6C

ROBO Cylinder, Slider Type, Motor Unit Coupled, Actuator Width 58 mm, 24-V Pulse Motor

Model Specification Items	RCP4 — SA6C — I — 42P — <input type="checkbox"/> — <input type="checkbox"/> — P3 — <input type="checkbox"/> — <input type="checkbox"/>	Series	Type	Encoder type	Motor type	Lead	Stroke	Applicable controller	Cable length	Options
	I: Incremental specification	42P: Pulse motor, size 42□	20: 20mm 12: 12mm 6: 6mm 3: 3mm	50: 50mm 800: 800mm (every 50mm)	P3: PCON-CA MSEP-C	N: None P: 1 m S: 3 m M: 5 m X□: Specified length R□: Robot cable	Refer to the options table below.			



POINT
Notes on selection

(1) The maximum payload is the value when operated at 0.3G (0.2G with some models) acceleration. The upper limit of acceleration is 1 G (*). Note that raising the acceleration causes the payload to drop.
 (*) The specific value varies depending on the connected controller and actuator lead. For details, refer to "Selection References" on P. 37 to 40.
 (2) Take note that the maximum payload and maximum speed vary depending on the controller connected to the RCP4. (Refer to the actuator specifications below.)

Correlation Diagrams of Speed and Payload

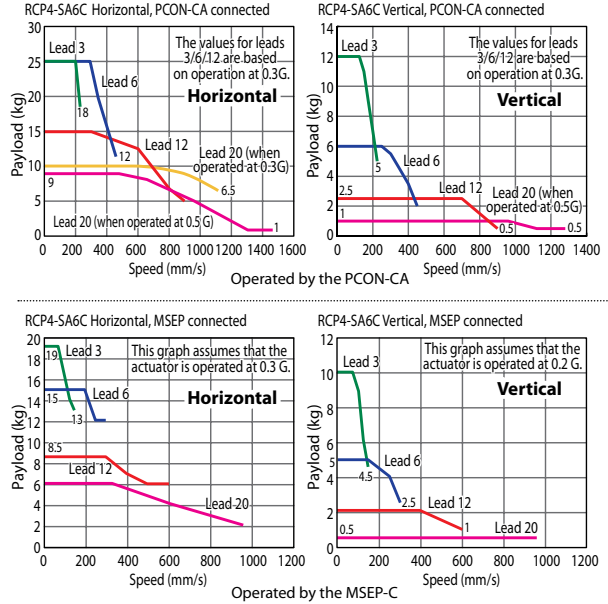

Actuator Specifications

Leads and Payloads

Model number	Lead (mm)	Connected controller	Maximum payload		Stroke (mm)
			Horizontal (kg)	Vertical (kg)	
RCP4-SA6C-I-42P-20-①-P3-②-③	20	PCON-CA	10	1	50~800 (every 50mm)
		MSEP-C	6	0.5 (*)	
RCP4-SA6C-I-42P-12-①-P3-②-③	12	PCON-CA	15	2.5	
		MSEP-C	8.5	2	
RCP4-SA6C-I-42P-6-①-P3-②-③	6	PCON-CA	25	6	
		MSEP-C	15	5	
RCP4-SA6C-I-42P-3-①-P3-②-③	3	PCON-CA	25	12	
		MSEP-C	19	10	

Code explanation ① Stroke ② Cable length ③ Options (*) When operated at 0.2 G

Stroke and Maximum Speed

Lead (mm)	Connected controller	50~450 (every 50mm)	500 (mm)	550 (mm)	600 (mm)	650 (mm)	700 (mm)	750 (mm)	800 (mm)
		20	PCON-CA	1440 < 1280 >	1230	1045	905	785	690
	MSEP-C	960		905	785	690	615		
12	PCON-CA	900	795	670	570	490	430	375	
	MSEP-C	600		570	490	430	375		
6	PCON-CA	450	395	335	285	245	215	185	
	MSEP-C	300		285	245	215	185		
3	PCON-CA	225	195	165	140	120	105	90	
	MSEP-C	150		140	120	105	90		

The values in < > apply when the actuator is used vertically. (unit: mm/s)

① Stroke

Stroke (mm)	Standard price	Stroke (mm)	Standard price
50	—	450	—
100	—	500	—
150	—	550	—
200	—	600	—
250	—	650	—
300	—	700	—
350	—	750	—
400	—	800	—

② Cable Length

Type	Cable symbol	Standard price
Standard type	P (1m)	—
	S (3m)	—
	M (5m)	—
Special length	X06 (6m) ~X10 (10m)	—
	X11 (11m) ~X15 (15m)	—
	X16 (16m) ~X20 (20m)	—
	R01 (1m) ~R03 (3m)	—
Robot cable	R04 (4m) ~R05 (5m)	—
	R06 (6m) ~R10 (10m)	—
	R11 (11m) ~R15 (15m)	—
	R16 (16m) ~R20 (20m)	—

③ Options

Name	Option code	See page	Standard price
Brake	B	P8	—
Optional cable exit direction (top)	CJT	P8	—
Optional cable exit direction (right)	CJR	P8	—
Optional cable exit direction (left)	CJL	P8	—
Optional cable exit direction (bottom)	CJB	P8	—
Non-motor end specification	NM	P8	—
Slider roller specification	SR	P8	—

Actuator Specifications

Item	Description
Drive system	Ball screw Ø10mm, rolled C10
Positioning repeatability (*1)	±0.02mm [±0.03mm]
Lost motion	0.1mm or less
Base	Material: Aluminum with white alumite treatment
Guide	Linear guide
Dynamic allowable moment (*2)	Ma: 8.9 N·m, Mb: 12.7 N·m, Mc: 18.6 N·m
Allowable overhang	220mm or less in Ma, Mb and Mc directions
Ambient operating temperature, humidity	0 to 40°C, 85% RH or less (Non-condensing)

(*1) The value at lead 20 is shown in []. (*2) Based on 5,000km of traveling life

11

- *1 Connect the motor and encoder cables.
- *2 During home return, be careful to avoid interference from peripheral objects because the slider travels until the mechanical end.

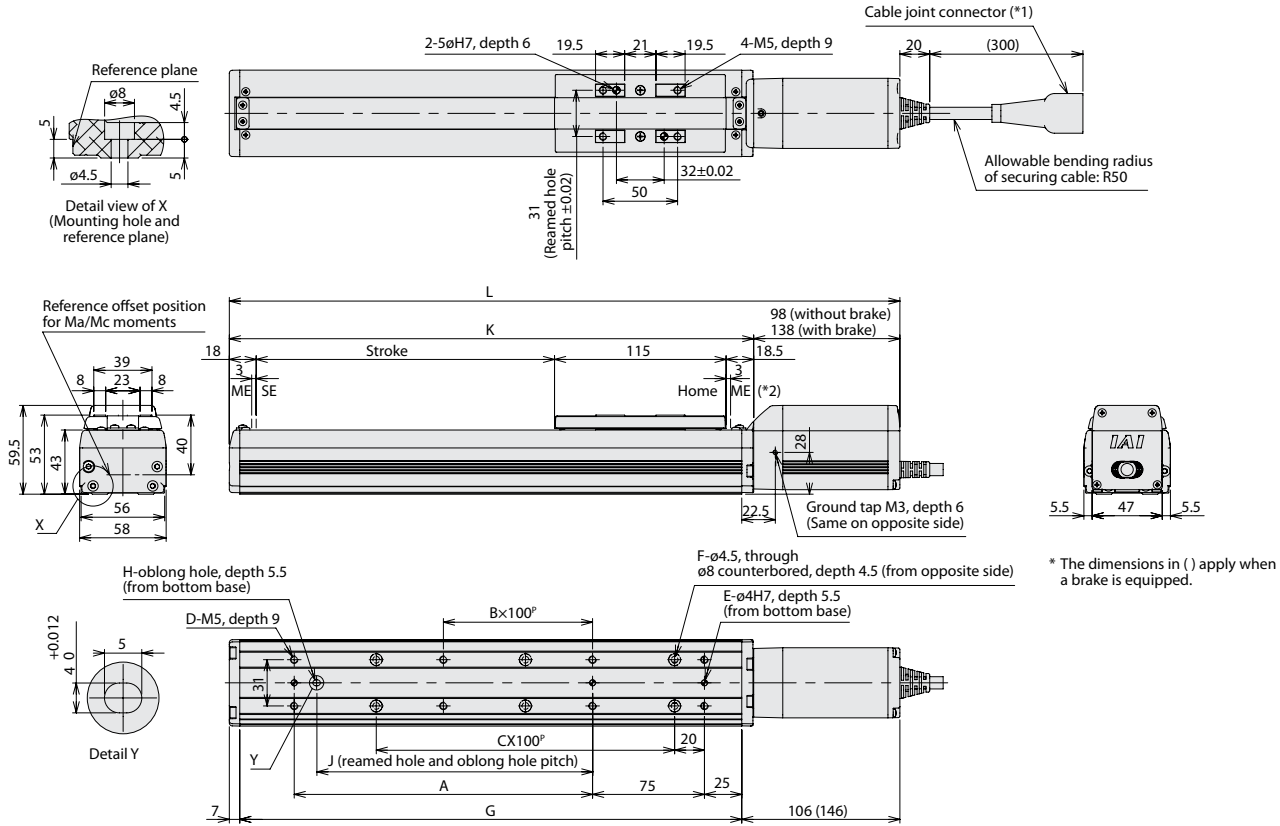

■ Dimensions and Mass by Stroke

Stroke	50	100	150	200	250	300	350	400	450	500	550	600	650	700	750	800	
L	Without brake	299.5	349.5	399.5	449.5	499.5	549.5	599.5	649.5	699.5	749.5	799.5	849.5	899.5	949.5	999.5	1049.5
	With brake	339.5	389.5	439.5	489.5	539.5	589.5	639.5	689.5	739.5	789.5	839.5	889.5	939.5	989.5	1039.5	1089.5
A	0	100	100	200	200	300	300	400	400	500	500	600	600	700	700	800	
B	0	0	0	1	1	2	2	3	3	4	4	5	5	6	6	7	
C	1	1	2	2	3	3	4	4	5	5	6	6	7	7	8	8	
D	4	6	6	8	8	10	10	12	12	14	14	16	16	18	18	20	
E	2	3	3	3	3	3	3	3	3	3	3	3	3	3	3	3	
F	4	4	6	6	8	8	10	10	12	12	14	14	16	16	18	18	
G	186.5	236.5	286.5	336.5	386.5	436.5	486.5	536.5	586.5	636.5	686.5	736.5	786.5	836.5	886.5	936.5	
H	0	1	1	1	1	1	1	1	1	1	1	1	1	1	1	1	
J	0	85	85	185	185	285	285	385	385	485	485	585	585	685	685	785	
K	201.5	251.5	301.5	351.5	401.5	451.5	501.5	551.5	601.5	651.5	701.5	751.5	801.5	851.5	901.5	951.5	
Mass (kg)	Without brake	2.0	2.1	2.3	2.4	2.6	2.7	2.9	3.0	3.2	3.4	3.5	3.7	3.8	4.0	4.1	4.3
	With brake	2.2	2.3	2.5	2.6	2.8	3.0	3.1	3.3	3.4	3.6	3.7	3.9	4.1	4.2	4.4	4.5

Applicable Controller

RCP4 series actuators can be operated with the controller indicated below. Select the type according to your intended application.

Name	External view	Model number	Features	Maximum number of positioning points	Input power	Power supply capacity	Standard price	Reference page
Positioner type		PCON-CA-42PI-NP-□-0-□ PCON-CA-42PI-PN-□-0-□	Equipped with a high-output driver Positioner type based on PIO control	512 points	DC24V	Refer to P. 48	—	Refer to P. 41
Pulse-train type		PCON-CA-42PI-PLN-□-0-□ PCON-CA-42PI-PLP-□-0-□	Equipped with a high-output driver Pulse-train input type	—				
Field network type		PCON-CA-42PI-△-0-0-□	Equipped with a high-output driver Supporting 7 major field networks	768 points				
Positioner multi-axis specification PIO type		MSEP-C-□-~-NP-□-0-□ MSEP-C-□-~-PN-□-0-□	Positioner type based on PIO control, allowing up to 8 axes to be connected (high-output driver not supported)	3 points	Refer to the MSEP catalog.	Refer to the MSEP catalog.	Refer to the MSEP catalog.	
Positioner multi-axis specification Network type		MSEP-C-□-~-△-0-0-□	Field network-ready positioner type, allowing up to 8 axes to be connected (high-output driver not supported)	256 points				

* In the model numbers shown above, △ indicates the field network specification (DV, CC, PR, CN, ML, EC or EP).

RCP4-SA7C

ROBO Cylinder, Slider Type, Motor Unit Coupled, Actuator Width 73mm, 24-V Pulse Motor

Model Specification Items	RCP4 — SA7C — I — 56P — <input type="checkbox"/> — <input type="checkbox"/> — P3 — <input type="checkbox"/> — <input type="checkbox"/>	Series	Type	Encoder type	Motor type	Lead	Stroke	Applicable controller	Cable length	Options
	I: Incremental specification	56P: Pulse motor, size 56□	24: 24mm 16: 16mm 8: 8mm 4: 4mm	50: 50mm 800: 800mm (every 50mm)	P3: PCON-CA MSEP-C	N: None P: 1m S: 3m M: 5m X□: Specified length R□: Robot cable	Refer to the options table below.			



- The maximum payload is the value when operated at 0.3G (0.2G with some models) acceleration. The upper limit of acceleration is 1 G (*). Note that raising the acceleration causes the payload to drop. (*): The specific value varies depending on the connected controller and actuator lead. For details, refer to "Selection References" on P. 37 to 40.
- Take note that the maximum payload and maximum speed vary depending on the controller connected to the RCP4. (Refer to the actuator specifications below.)

Correlation Diagrams of Speed and Payload

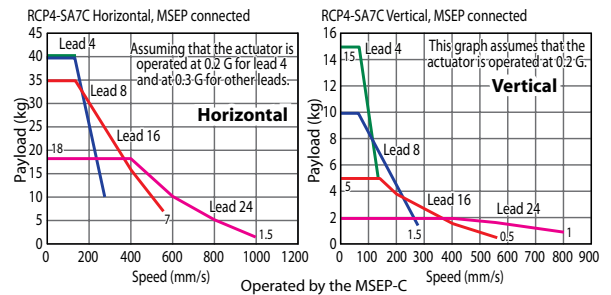
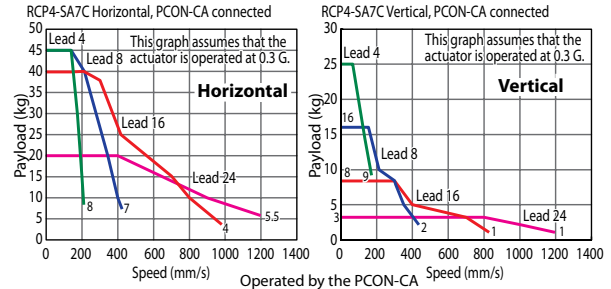

Actuator Specifications

Leads and Payloads

Model number	Lead (mm)	Connected controller	Maximum payload		Stroke (mm)
			Horizontal (kg)	Vertical (kg)	
RCP4-SA7C-I-56P-24-①-P3-②-③	24	PCON-CA	20	3	50~800 (every 50mm)
		MSEP-C	18	2 (*)	
RCP4-SA7C-I-56P-16-①-P3-②-③	16	PCON-CA	40	8	
		MSEP-C	35	5 (*)	
RCP4-SA7C-I-56P-8-①-P3-②-③	8	PCON-CA	45	16	
		MSEP-C	40	10 (*)	
RCP4-SA7C-I-56P-4-①-P3-②-③	4	PCON-CA	45	25	
		MSEP-C	40 (*)	15 (*)	

Code explanation ① Stroke ② Cable length ③ Options (*) When operated at 0.2 G

Stroke and Maximum Speed

Lead (mm)	Connected controller	50~450 (every 50mm)	500 (mm)	500 (mm)	600 (mm)	650 (mm)	700 (mm)	750 (mm)	800 (mm)
		24	PCON-CA	1200		1155		1010	890
	MSEP-C	1000<800>		890<800>		790			
16	PCON-CA	980<840>		865<840>		750	655	580	515
	MSEP-C	560		515					
8	PCON-CA	490		430	375	325	290	255	
	MSEP-C	280		255					
4	PCON-CA	245<210>		215<210>		185	160	145	125
	MSEP-C	140		125					

The values in <> apply when the actuator is used vertically. (unit: mm/s)

① Stroke

Stroke (mm)	Standard price	Stroke (mm)	Standard price
50	—	450	—
100	—	500	—
150	—	550	—
200	—	600	—
250	—	650	—
300	—	700	—
350	—	750	—
400	—	800	—

② Cable Length

Type	Cable symbol	Standard price
Standard type	P (1m)	—
	S (3m)	—
	M (5m)	—
Special length	X06 (6m) ~X10 (10m)	—
	X11 (11m) ~X15 (15m)	—
	X16 (16m) ~X20 (20m)	—
	R01 (1m) ~R03 (3m)	—
Robot cable	R04 (4m) ~R05 (5m)	—
	R06 (6m) ~R10 (10m)	—
	R11 (11m) ~R15 (15m)	—
	R16 (16m) ~R20 (20m)	—

③ Options

Name	Option code	See page	Standard price
Brake	B	P8	—
Optional cable exit direction (top)	CJT	P8	—
Optional cable exit direction (right)	CJR	P8	—
Optional cable exit direction (left)	CJL	P8	—
Optional cable exit direction (bottom)	CJB	P8	—
Non-motor end specification	NM	P8	—
Slider roller specification	SR	P8	—

Actuator Specifications

Item	Description
Drive system	Ball screw ϕ 12mm, rolled C10
Positioning repeatability (*1)	± 0.02 mm [± 0.03 mm]
Lost motion	0.1mm or less
Base	Material: Aluminum with white alumite treatment
Guide	Linear guide
Dynamic allowable moment (*2)	Ma: 13.9 N·m, Mb: 19.9 N·m, Mc: 38.3 N·m
Allowable overhang	230mm or less in Ma, Mb and Mc directions
Ambient operating temperature, humidity	0 to 40°C, 85% RH or less (Non-condensing)

(*1) The value at lead 24 is shown in []. (*2) Based on 5,000km of traveling life

13

- *1 Connect the motor and encoder cables.
- *2 During home return, be careful to avoid interference from peripheral objects because the slider travels until the mechanical end.

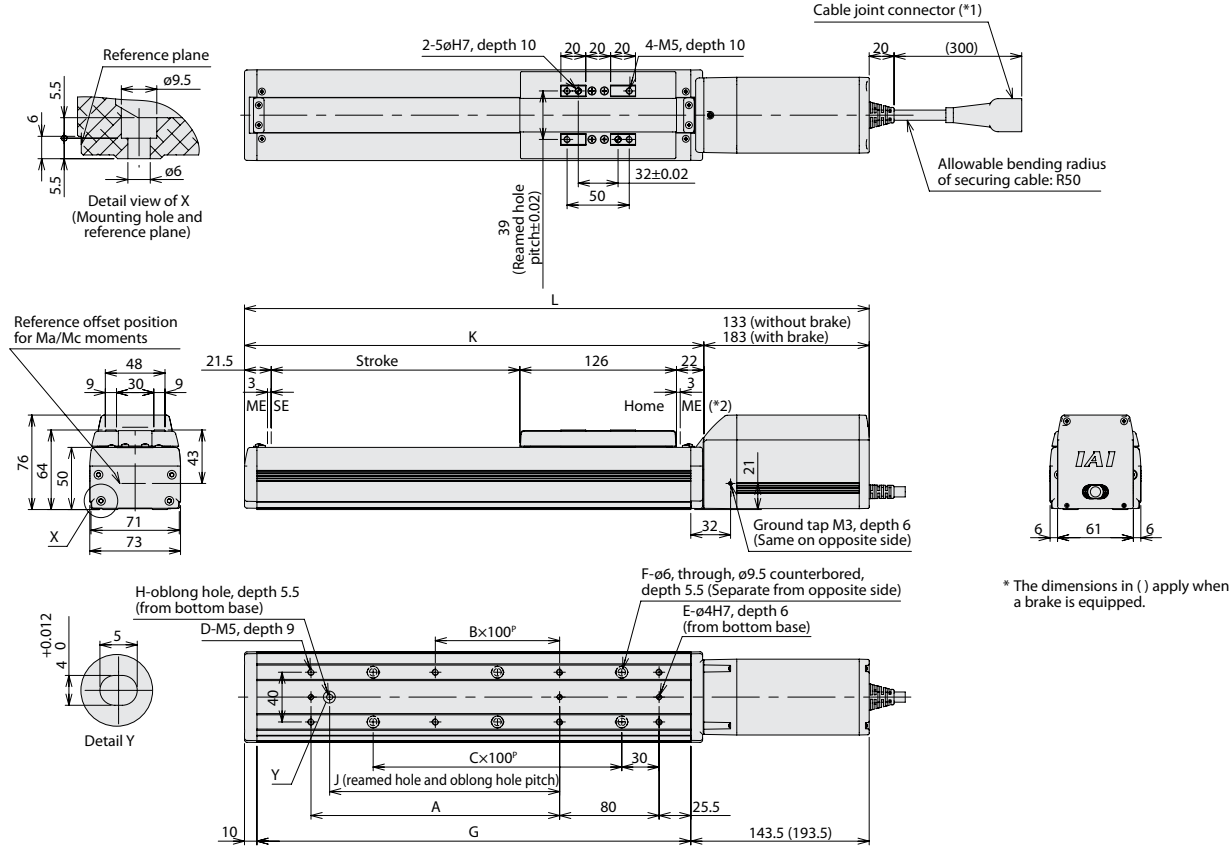

* The dimensions in () apply when a brake is equipped.

■ Dimensions and Mass by Stroke

Stroke	50	100	150	200	250	300	350	400	450	500	550	600	650	700	750	800	
L	Without brake	352.5	402.5	452.5	502.5	552.5	602.5	652.5	702.5	752.5	802.5	852.5	902.5	952.5	1002.5	1052.5	1102.5
	With brake	402.5	452.5	502.5	552.5	602.5	652.5	702.5	752.5	802.5	852.5	902.5	952.5	1002.5	1052.5	1102.5	1152.5
A	0	100	100	200	200	300	300	400	400	500	500	600	600	700	700	800	
B	0	0	0	1	1	2	2	3	3	4	4	5	5	6	6	7	
C	1	1	2	2	3	3	4	4	5	5	6	6	7	7	8	8	
D	4	6	6	8	8	10	10	12	12	14	14	16	16	18	18	20	
E	2	3	3	3	3	3	3	3	3	3	3	3	3	3	3	3	
F	4	4	6	6	8	8	10	10	12	12	14	14	16	16	18	18	
G	199	249	299	349	399	449	499	549	599	649	699	749	799	849	899	949	
H	0	1	1	1	1	1	1	1	1	1	1	1	1	1	1	1	
J	0	85	85	185	185	285	285	385	385	485	485	585	585	685	685	785	
K	219.5	269.5	319.5	369.5	419.5	469.5	519.5	569.5	619.5	669.5	719.5	769.5	819.5	869.5	919.5	969.5	
Mass (kg)	Without brake	3.4	3.6	3.8	4.1	4.3	4.6	4.8	5.1	5.3	5.6	5.8	6.0	6.3	6.5	6.8	7.0
	With brake	3.9	4.1	4.3	4.6	4.8	5.1	5.3	5.6	5.8	6.1	6.3	6.5	6.8	7.0	7.3	7.5

Applicable Controller

RCP4 series actuators can be operated with the controller indicated below. Select the type according to your intended application.

Name	External view	Model number	Features	Maximum number of positioning points	Input power	Power supply capacity	Standard price	Reference page
Positioner type		PCON-CA-56PI-NP-□-0-□ PCON-CA-56PI-PN-□-0-□	Equipped with a high-output driver Positioner type based on PIO control	512 points	DC24V	Refer to P. 48	—	Refer to P. 41
Pulse-train type		PCON-CA-56PI-PLN-□-0-□ PCON-CA-56PI-PLP-□-0-□	Equipped with a high-output driver Pulse-train input type	—				
Field network type	PCON-CA-56PI-△-0-0-□	Equipped with a high-output driver Supporting 7 major field networks	768 points					
Positioner multi-axis specification PIO type	MSEP-C-□-□-~NP-□-0-□ MSEP-C-□-□-~PN-□-0-□	Positioner type based on PIO control, allowing up to 8 axes to be connected (high-output driver not supported)	3 points					
Positioner multi-axis specification Network type	MSEP-C-□-□-~△-0-0-□	Field network-ready positioner type, allowing up to 8 axes to be connected (high-output driver not supported)	256 points					

* In the model numbers shown above, △ indicates the field network specification (DV, CC, PR, CN, ML, EC or EP).

RCP4-SA5R

ROBO Cylinder, Slider Type, Side-mounted Motor Type, Actuator Width 52mm, 24-V Pulse Motor

Model Specification Items	RCP4 — SA5R — I — 42P — <input type="checkbox"/> — <input type="checkbox"/> — <input type="checkbox"/> — <input type="checkbox"/> — <input type="checkbox"/> — <input type="checkbox"/> — <input type="checkbox"/> — <input type="checkbox"/> — <input type="checkbox"/>	P3	<input type="checkbox"/> — <input type="checkbox"/>	<input type="checkbox"/>		
	Series — Type — Encoder type — Motor type — Lead — Stroke — Applicable controller — Cable length — Options	I: Incremental specification 42P: Pulse motor, size 42□	20: 20mm 12: 12mm 6: 6mm 3: 3mm	50: 50mm ? : 800: 800mm (every 50mm)	P3: PCON-CA MSEP-C	N: None P: 1m S: 3m M: 5m X□: Specified length R□: Robot cable



The "Motor side-mounted to the left (ML)" option is selected for the actuator shown above.



- The maximum payload is the value when operated at 0.3G (0.2G with some models) acceleration. The upper limit of acceleration is 1 G (*). Note that raising the acceleration causes the payload to drop.
(*): The specific value varies depending on the connected controller and actuator lead. For details, refer to "Selection References" on P. 37 to 40.
- Take note that the maximum payload and maximum speed vary depending on the controller connected to the RCP4. (Refer to the actuator specifications below.)

Correlation Diagrams of Speed and Payload

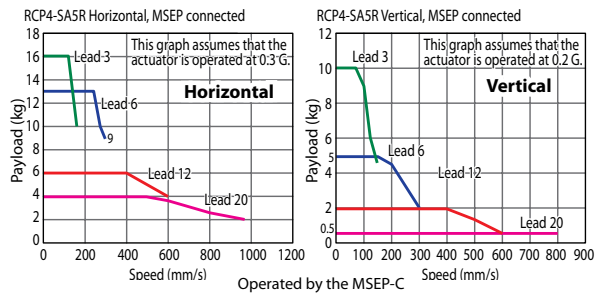
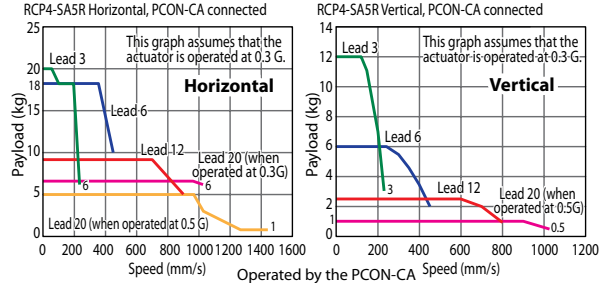

Actuator Specifications

Leads and Payloads

Model number	Lead (mm)	Connected controller	Maximum payload		Stroke (mm)
			Horizontal (kg)	Vertical (kg)	
RCP4-SA5R-I-42P-20-①-P3-②-③	20	PCON-CA	6.5	1	50~800 (every 50mm)
		MSEP-C	4	0.5 (*)	
RCP4-SA5R-I-42P-12-①-P3-②-③	12	PCON-CA	9	2.5	
		MSEP-C	6	2	
RCP4-SA5R-I-42P-6-①-P3-②-③	6	PCON-CA	18	6	
		MSEP-C	13	5	
RCP4-SA5R-I-42P-3-①-P3-②-③	3	PCON-CA	20	12	
		MSEP-C	16	10	

Code explanation ① Stroke ② Cable length ③ Options (*) When operated at 0.2 G

Stroke and Maximum Speed

Lead (mm)	Connected controller	Stroke (mm)							
		50~450 (every 50mm)	500	550	600	650	700	750	800
20	PCON-CA	1440 <1120>	1225 <1120>	1045	900	785	690	610	
	MSEP-C	960 <800>			900 <800>	785	690	610	
12	PCON-CA	900 <800>	795	665	570	490	425	375	330
	MSEP-C	600		570	490	425	375	330	
6	PCON-CA	450	395	335	285	245	215	185	165
	MSEP-C	300		285	245	215	185	165	
3	PCON-CA	225	195	165	140	120	105	90	80
	MSEP-C	150		140	120	105	90	80	

The values in < > apply when the actuator is used vertically. (unit: mm/s)

① Stroke

Stroke (mm)	Standard price	Stroke (mm)	Standard price
50	—	450	—
100	—	500	—
150	—	550	—
200	—	600	—
250	—	650	—
300	—	700	—
350	—	750	—
400	—	800	—

② Cable Length

Type	Cable symbol	Standard price
Standard type	P (1m)	—
	S (3m)	—
	M (5m)	—
Special length	X06 (6m) ~X10 (10m)	—
	X11 (11m) ~X15 (15m)	—
	X16 (16m) ~X20 (20m)	—
		—
Robot cable	R01 (1m) ~R03 (3m)	—
	R04 (4m) ~R05 (5m)	—
	R06 (6m) ~R10 (10m)	—
	R11 (11m) ~R15 (15m)	—
	R16 (16m) ~R20 (20m)	—
		—

③ Options

Name	Option code	See page	Standard price
Brake	B	P8	—
Optional cable exit direction (top)	CJT	P8	—
Optional cable exit direction (outside)	CJO	P8	—
Optional cable exit direction (bottom)	CJB	P8	—
Motor side-mounted to the left (standard)	ML	P8	—
Motor side-mounted to the right	MR	P8	—
Non-motor end specification	NM	P8	—
Slider roller specification	SR	P8	—

Actuator Specifications

Item	Description
Drive system	Ball screw ϕ 10mm, rolled C10
Positioning repeatability (*1)	\pm 0.02mm [\pm 0.03mm]
Lost motion	0.1mm or less
Base	Material: Aluminum with white alumite treatment
Guide	Linear guide
Dynamic allowable moment (*2)	Ma: 4.9 N·m, Mb: 6.8 N·m, Mc: 11.7 N·m
Allowable overhang	150mm or less in Ma, Mb and Mc directions
Ambient operating temperature, humidity	0 to 40°C, 85% RH or less (Non-condensing)

(*1) The value at lead 20 is shown in []. (*2) Based on 5,000km of traveling life.

15

- 1 Connect the motor and encoder cables.
- 2 During home return, be careful to avoid interference from peripheral objects because the slider travels until the mechanical end.

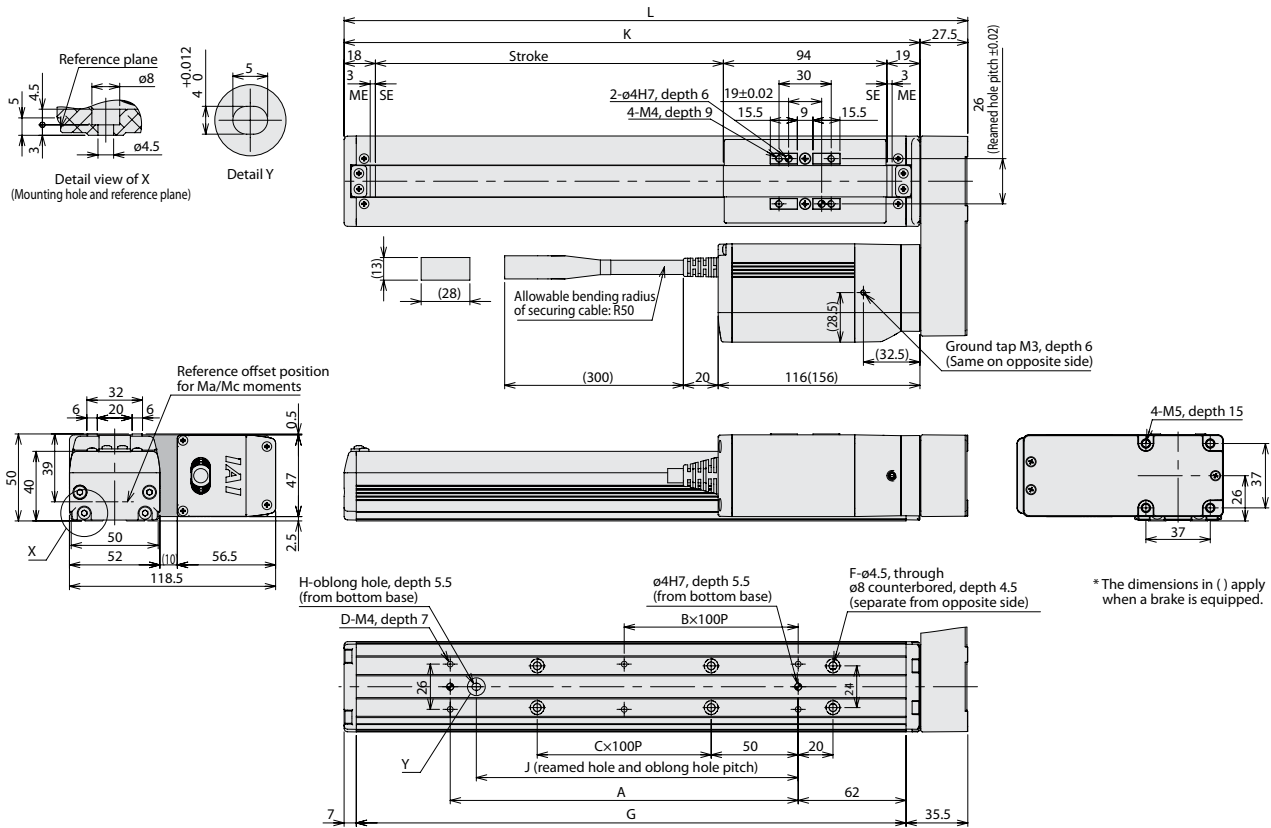

* The dimensions in () apply when a brake is equipped.

■ Dimensions and Mass by Stroke

Stroke	50	100	150	200	250	300	350	400	450	500	550	600	650	700	750	800	
L	208.5	258.5	308.5	358.5	408.5	458.5	508.5	558.5	608.5	658.5	708.5	758.5	808.5	858.5	908.5	958.5	
A	73	100	100	200	200	300	300	400	400	500	500	600	600	700	700	800	
B	0	0	0	1	1	2	2	3	3	4	4	5	5	6	6	7	
C	0	0	1	1	2	2	3	3	4	4	5	5	6	6	7	8	
D	4	4	4	6	6	8	8	10	10	12	12	14	14	16	16	18	
F	4	4	6	6	8	8	10	10	12	12	14	14	16	16	18	18	
G	166	216	266	316	366	416	466	516	566	616	666	716	766	816	866	916	
H	0	1	1	1	1	1	1	1	1	1	1	1	1	1	1	1	
J	0	85	85	185	185	285	285	385	385	485	485	585	585	685	685	785	
K	181	231	281	331	381	431	481	531	581	631	681	731	781	831	881	931	
Mass (kg)	Without brake	1.7	1.9	2.0	2.2	2.3	2.5	2.6	2.8	2.9	3.0	3.2	3.3	3.5	3.6	3.8	3.9
	With brake	2.0	2.1	2.3	2.4	2.5	2.7	2.8	3.0	3.1	3.3	3.4	3.6	3.7	3.9	4.0	4.1

Applicable Controller

RCP4 series actuators can be operated with the controller indicated below. Select the type according to your intended application.

Name	External view	Model number	Features	Maximum number of positioning points	Input power	Power supply capacity	Standard price	Reference page
Positioner type		PCON-CA-42PI-NP-□-0-□ PCON-CA-42PI-PN-□-0-□	Equipped with a high-output driver Positioner type based on PIO control	512 points	DC24V	Refer to P. 48	—	Refer to P. 41
Pulse-train type		PCON-CA-42PI-PLN-□-0-□ PCON-CA-42PI-PLP-□-0-□	Equipped with a high-output driver Pulse-train input type	—				
Field network type	PCON-CA-42PI-△-0-0-□	Equipped with a high-output driver Supporting 7 major field networks	768 points					
Positioner multi-axis specification PIO type	MSEP-C-□-□-~NP-□-0-□ MSEP-C-□-□-~PN-□-0-□	Positioner type based on PIO control, allowing up to 8 axes to be connected (high-output driver not supported)	3 points					
Positioner multi-axis specification Network type	MSEP-C-□-□-~△-0-0-□	Field network-ready positioner type, allowing up to 8 axes to be connected (high-output driver not supported)	256 points					

* In the model numbers shown above, △ indicates the field network specification (DV, CC, PR, CN, ML, EC or EP).

RCP4-SA6R

ROBO Cylinder, Slider Type, Side-mounted Motor Type, Actuator Width 58mm, 24-V Pulse Motor

Model Specification Items	RCP4 — SA6R — I — 42P — <input type="checkbox"/> — <input type="checkbox"/> — P3 — <input type="checkbox"/> — <input type="checkbox"/>	Series	Type	Encoder type	Motor type	Lead	Stroke	Applicable controller	Cable length	Options
	I: Incremental specification	42P: Pulse motor, size 42□	20: 20mm 12: 12mm 6: 6mm 3: 3mm	50: 50mm 800: 800mm (every 50mm)	P3: PCON-CA MSEP-C	N: None P: 1m S: 3m M: 5m X□□: Specified length R□□: Robot cable	Refer to the options table below. * Be sure to specify either "ML" or "MR" as the motor side-mounted direction.			



The "Motor side-mounted to the left (ML)" option is selected for the actuator shown above.



- The maximum payload is the value when operated at 0.3G (0.2G with some models) acceleration. The upper limit of acceleration is 1 G (*). Note that raising the acceleration causes the payload to drop. (*The specific value varies depending on the connected controller and actuator lead. For details, refer to "Selection References" on P. 37 to 40.
- Take note that the maximum payload and maximum speed vary depending on the controller connected to the RCP4. (Refer to the actuator specifications below.)

Correlation Diagrams of Speed and Payload

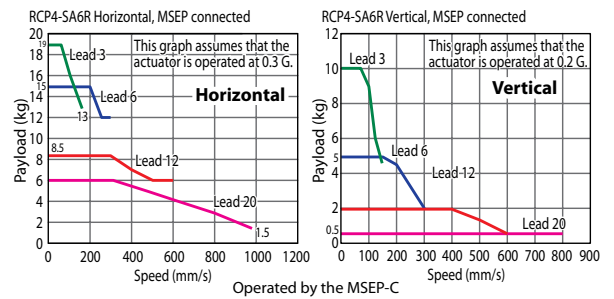
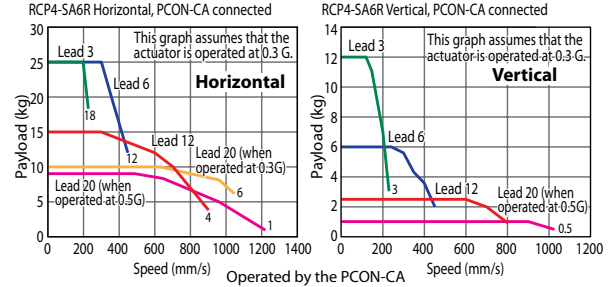

Actuator Specifications

Leads and Payloads

Model number	Lead (mm)	Connected controller	Maximum payload		Stroke (mm)
			Horizontal (kg)	Vertical (kg)	
RCP4-SA6R-I-42P-20-①-P3-②-③	20	PCON-CA	10	1	50~800 (every 50mm)
		MSEP-C	6	0.5 (*)	
RCP4-SA6R-I-42P-12-①-P3-②-③	12	PCON-CA	15	2.5	
		MSEP-C	8.5	2	
RCP4-SA6R-I-42P-6-①-P3-②-③	6	PCON-CA	25	6	
		MSEP-C	15	5	
RCP4-SA6R-I-42P-3-①-P3-②-③	3	PCON-CA	25	12	
		MSEP-C	19	10	

Code explanation ① Stroke ② Cable length ③ Options (*) When operated at 0.2 G

Stroke and Maximum Speed

Lead (mm)	Connected controller	50~450 (every 50mm)	500 (mm)	550 (mm)	600 (mm)	650 (mm)	700 (mm)	750 (mm)	800 (mm)
		20	PCON-CA	1280	1230	1045	905	785	690
	MSEP-C	960			905	785	690	615	
12	PCON-CA	900	795	670	570	490	430	375	335
	MSEP-C	600			570	490	430	375	335
6	PCON-CA	450	395	335	285	245	215	185	165
	MSEP-C	300			285	245	215	185	165
3	PCON-CA	225	195	165	140	120	105	90	80
	MSEP-C	150			140	120	105	90	80

The values in < > apply when the actuator is used vertically. (unit: mm/s)

① Stroke

Stroke (mm)	Standard price	Stroke (mm)	Standard price
50	—	450	—
100	—	500	—
150	—	550	—
200	—	600	—
250	—	650	—
300	—	700	—
350	—	750	—
400	—	800	—

② Cable Length

Type	Cable symbol	Standard price
Standard type	P (1m)	—
	S (3m)	—
	M (5m)	—
Special length	X06 (6m) ~X10 (10m)	—
	X11 (11m) ~X15 (15m)	—
	X16 (16m) ~X20 (20m)	—
	R01 (1m) ~R03 (3m)	—
Robot cable	R04 (4m) ~R05 (5m)	—
	R06 (6m) ~R10 (10m)	—
	R11 (11m) ~R15 (15m)	—
	R16 (16m) ~R20 (20m)	—
	R16 (16m) ~R20 (20m)	—

③ Options

Name	Option code	See page	Standard price
Brake	B	P8	—
Optional cable exit direction (top)	CJT	P8	—
Optional cable exit direction (outside)	CJO	P8	—
Optional cable exit direction (bottom)	CJB	P8	—
Motor side-mounted to the left (standard)	ML	P8	—
Motor side-mounted to the right	MR	P8	—
Non-motor end specification	NM	P8	—
Slider roller specification	SR	P8	—

Actuator Specifications

Item	Description
Drive system	Ball screw ϕ 10mm, rolled C10
Positioning repeatability (*1)	\pm 0.02mm [\pm 0.03mm]
Lost motion	0.1mm or less
Base	Material: Aluminum with white alumite treatment
Guide	Linear guide
Dynamic allowable moment (*2)	Ma: 8.9 N·m, Mb: 12.7 N·m, Mc: 18.6 N·m
Allowable overhang	220mm or less in Ma, Mb and Mc directions
Ambient operating temperature, humidity	0 to 40°C, 85% RH or less (Non-condensing)

(*1) The value at lead 20 is shown in []. (*2) Based on 5,000km of traveling life

RCP4-SA7R

ROBO Cylinder, Slider Type, Side-mounted Motor Type, Actuator Width 73mm, 24-V Pulse Motor

Model Specification Items

RCP4 — **SA7R** — **I** — **56P** — — — **P3** — —

Series — Type — Encoder type — Motor type — Lead — Stroke — Applicable controller — Cable length — Options

I: Incremental specification 56P: Pulse motor, size 56□ 24: 24mm 50: 50mm P3: PCON-CA N: None Refer to the options table below.
 8: 8mm 16: 16mm MSEP-C S: 3m * Be sure to specify either "ML" or "MR" as the motor side-mounted direction.
 4: 4mm 800: 800mm (every 50mm) X□: Specified length R□: Robot cable



The "Motor side-mounted to the left (ML)" option is selected for the actuator shown above.



- The maximum payload is the value when operated at 0.3G (0.2G with some models) acceleration. The upper limit of acceleration is 1 G (*). Note that raising the acceleration causes the payload to drop. (*The specific value varies depending on the connected controller and actuator lead. For details, refer to "Selection References" on P. 37 to 40.
- Take note that the maximum payload and maximum speed vary depending on the controller connected to the RCP4. (Refer to the actuator specifications below.)

Correlation Diagrams of Speed and Payload

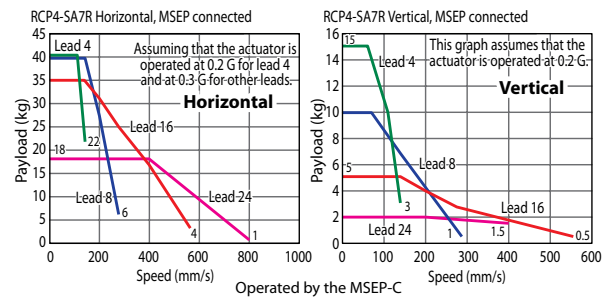
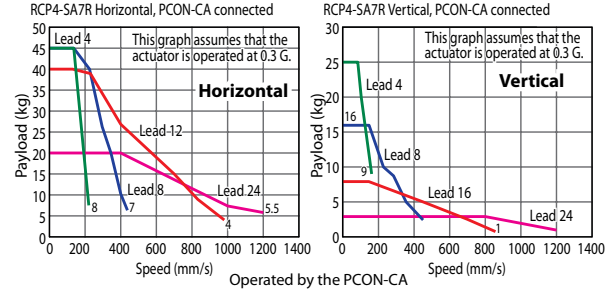

Actuator Specifications

Leads and Payloads

Model number	Lead (mm)	Connected controller	Maximum payload		Stroke (mm)
			Horizontal (kg)	Vertical (kg)	
RCP4-SA7R-I-56P-24-①-P3-②-③	24	PCON-CA	20	3	50~800 (every 50mm)
		MSEP-C	18	2 (*)	
RCP4-SA7R-I-56P-16-①-P3-②-③	16	PCON-CA	40	8	
		MSEP-C	35	5 (*)	
RCP4-SA7R-I-56P-8-①-P3-②-③	8	PCON-CA	45	16	
		MSEP-C	40	10 (*)	
RCP4-SA7R-I-56P-4-①-P3-②-③	4	PCON-CA	45	25	
		MSEP-C	40 (*)	15 (*)	

Code explanation ① Stroke ② Cable length ③ Options (*) When operated at 0.2 G

Stroke and Maximum Speed

Lead (mm)	Connected controller	Maximum Speed (mm/s)						
		50~450 (every 50mm)	500 (mm)	550 (mm)	600 (mm)	650 (mm)	700 (mm)	750 (mm)
24	PCON-CA	1000						
	MSEP-C	800<600>					890	790
16	PCON-CA	840<700>		750<700>		655	580	515
	MSEP-C	560						
8	PCON-CA	490		430	375	325	290	255
	MSEP-C	280						
4	PCON-CA	210		185		160	145	125
	MSEP-C	140						

The values in <> apply when the actuator is used vertically. (unit: mm/s)

① Stroke

Stroke (mm)	Standard price	Stroke (mm)	Standard price
50	—	450	—
100	—	500	—
150	—	550	—
200	—	600	—
250	—	650	—
300	—	700	—
350	—	750	—
400	—	800	—

② Cable Length

Type	Cable symbol	Standard price
Standard type	P (1m)	—
	S (3m)	—
	M (5m)	—
Special length	X06 (6m) ~X10 (10m)	—
	X11 (11m) ~X15 (15m)	—
	X16 (16m) ~X20 (20m)	—
	R01 (1m) ~R03 (3m)	—
Robot cable	R04 (4m) ~R05 (5m)	—
	R06 (6m) ~R10 (10m)	—
	R11 (11m) ~R15 (15m)	—
	R16 (16m) ~R20 (20m)	—

③ Options

Name	Option code	See page	Standard price
Brake	B	P8	—
Optional cable exit direction (top)	CJT	P8	—
Optional cable exit direction (outside)	CJO	P8	—
Optional cable exit direction (bottom)	CJB	P8	—
Motor side-mounted to the left (standard)	ML	P8	—
Motor side-mounted to the right	MR	P8	—
Non-motor end specification	NM	P8	—
Slider roller specification	SR	P8	—

Actuator Specifications

Item	Description
Drive system	Ball screw ϕ 12mm, rolled C10
Positioning repeatability (*1)	\pm 0.02mm [\pm 0.03mm]
Lost motion	0.1mm or less
Base	Material: Aluminum with white alumite treatment
Guide	Linear guide
Dynamic allowable moment (*2)	Ma: 13.9 N·m, Mb: 19.9 N·m, Mc: 38.3 N·m
Allowable overhang	230mm or less in Ma, Mb and Mc directions
Ambient operating temperature, humidity	0 to 40°C, 85% RH or less (Non-condensing)

(*1) The value at lead 24 is shown in []. (*2) Based on 5,000km of traveling life

RCP4-RA5C

ROBO Cylinder, Rod Type, Motor Unit Coupled, Actuator Width 52mm, 24-V Pulse Motor

Model Specification Items	RCP4 — RA5C — I — 42P — [] — [] — P3 — [] — []
	Series — Type — Encoder type — Motor type — Lead — Stroke — Applicable controller — Cable length — Options
	I: Incremental specification 42P: Pulse motor, size 42□ 20: 20 mm 50: 50 mm P3: PCON-CA MSEP-C N: None Refer to the options table below.
	6: 6 mm 12: 12 mm ? 400: 400 mm (every 50mm) S: 3 m M: 5 m X□: Specified length R□: Robot cable

Built-in guide mechanism



- The maximum payload is the value when operated at 0.3G (0.2G with some models) acceleration. The upper limit of acceleration is 1 G (*). Note that raising the acceleration causes the payload to drop. (*). The specific value varies depending on the connected controller and actuator lead. For details, refer to "Selection References" on P. 37 to 40.
- Take note that the maximum payload and maximum speed vary depending on the controller connected to the RCP4. (Refer to the actuator specifications below.)
- All horizontal payloads are values when an external guide is used.

Correlation Diagrams of Speed and Payload

*The values of the horizontal specification assume that an external guide is used.

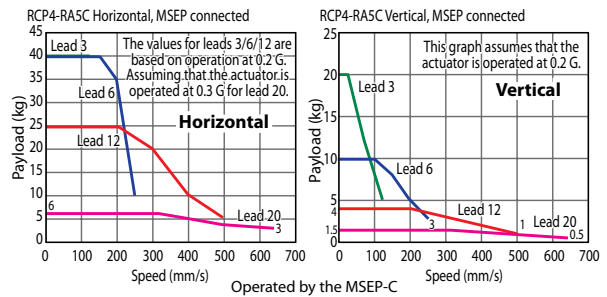
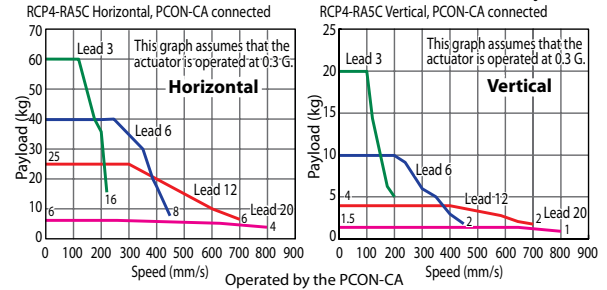

Actuator Specifications

Leads and Payloads

Model number	Lead (mm)	Connected controller	Maximum payload		Max. push force (N)	Stroke (mm)
			Horizontal (kg)	Vertical (kg)		
RCP4-RA5C-I-42P-20-①-P3-②-③	20	PCON-CA	6	1.5	56	50~400 (every 50mm)
		MSEP-C	6	1.5 (*)		
RCP4-RA5C-I-42P-12-①-P3-②-③	12	PCON-CA	25	4	93	
		MSEP-C	25 (*)	4 (*)		
RCP4-RA5C-I-42P-6-①-P3-②-③	6	PCON-CA	40	10	185	
		MSEP-C	40 (*)	10 (*)		
RCP4-RA5C-I-42P-3-①-P3-②-③	3	PCON-CA	60	20	370	
		MSEP-C	40 (*)	20 (*)		

Code explanation ① Stroke ② Cable length ③ Options (*) When operated at 0.2 G

Stroke and Maximum Speed

Lead (mm)	Connected controller	50~400 (every 50mm)
20	PCON-CA	800
	MSEP-C	640
12	PCON-CA	700
	MSEP-C	500
6	PCON-CA	450
	MSEP-C	250
3	PCON-CA	225
	MSEP-C	125

(unit: mm/s)

① Stroke

Stroke (mm)	Standard price
50	—
100	—
150	—
200	—
250	—
300	—
350	—
400	—

② Cable Length

Type	Cable symbol	Standard price
Standard type	P (1m)	—
	S (3m)	—
	M (5m)	—
Special length	X06 (6m) ~X10 (10m)	—
	X11 (11m) ~X15 (15m)	—
	X16 (16m) ~X20 (20m)	—
	R01 (1m) ~R03 (3m)	—
Robot cable	R04 (4m) ~R05 (5m)	—
	R06 (6m) ~R10 (10m)	—
	R11 (11m) ~R15 (15m)	—
	R16 (16m) ~R20 (20m)	—

③ Options

Name	Option code	See page	Standard price
Brake	B	P8	—
Optional cable exit direction (top)	CJT	P8	—
Optional cable exit direction (right)	CJR	P8	—
Optional cable exit direction (left)	CJL	P8	—
Optional cable exit direction (bottom)	CJB	P8	—
Flange bracket	FL	P8	—
Non-motor end specification	NM	P8	—
Scraper	SC	P8	—

Actuator Specifications

Item	Description
Drive system	Ball screw \varnothing 10 mm, rolled C10
Positioning repeatability (*1)	\pm 0.02mm [\pm 0.03mm]
Lost motion	0.1mm or less
Rod	\varnothing 22mm stainless steel pipe
Rod non-rotation precision	\pm 0 deg
Allowable rod load mass	Refer to P. 22 and P. 36
Rod tip overhang distance	100mm or less
Ambient operating temperature, humidity	0 to 40°C, 85% RH or less (Non-condensing)

(*1) The value at lead 20 is shown in [].

21

- *1 Connect the motor and encoder cables.
- *2 During home return, be careful to avoid interference from peripheral objects because the slider travels until the mechanical end.
- *3 The direction of width across flats varies depending on the product.
- *4 If the actuator is installed using the front housing and flange, make sure the actuator will not receive any external force.
(For details, refer to "Notes on Installing Rod Actuators" on P.35.)

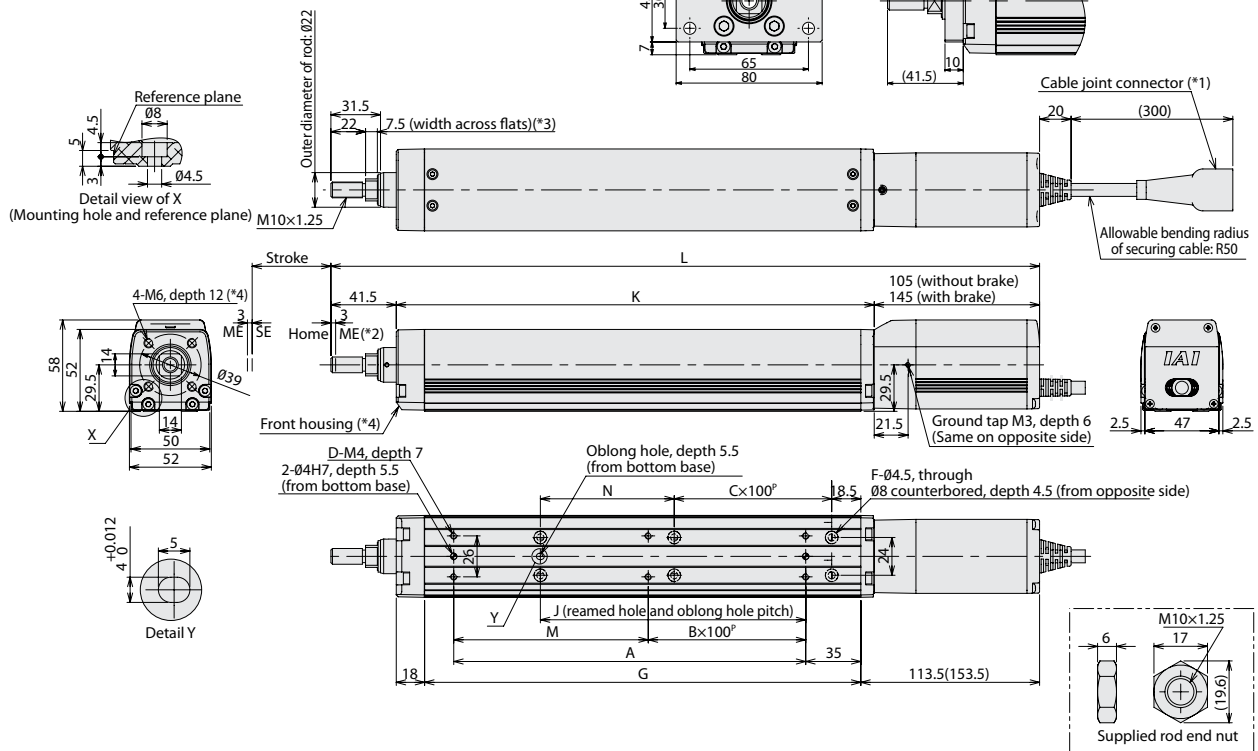

■ Rod Deflection of RCP4-RA5C (Reference Values)

(The graph below plots deflection as measured by installing the actuator vertically and applying a force to the rod from one side.)

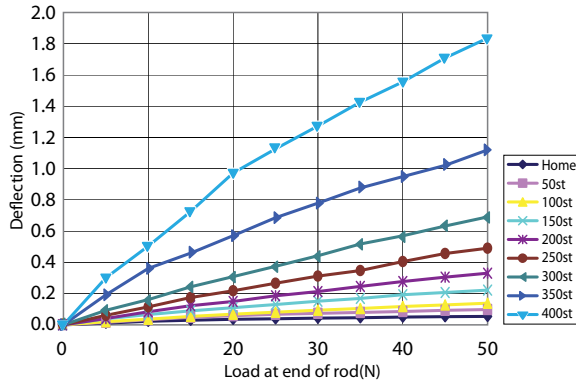

■ Dimensions and Mass by Stroke

Stroke	Stroke								
	50	100	150	200	250	300	350	400	
L	Without brake	300	350	400	450	500	550	600	650
	With brake	340	390	440	490	540	590	640	690
A	73.5	123.5	173.5	223.5	273.5	323.5	373.5	423.5	
B	0	0	1	1	2	2	3	3	
C	0	0	0	1	1	2	2	3	
D	4	4	6	6	8	8	10	10	
F	4	4	4	6	6	8	8	10	
G	127	177	227	277	327	377	427	477	
J	18.5	68.5	118.5	168.5	218.5	268.5	318.5	368.5	
K	153.5	203.5	253.5	303.5	353.5	403.5	453.5	503.5	
M	73.5	123.5	73.5	123.5	73.5	123.5	73.5	123.5	
N	35	85	135	85	135	85	135	85	
Allowable static load at end of rod (N)	65.6	51.2	41.7	34.9	29.8	25.7	22.4	19.7	
	Allowable dynamic load at end of rod (N)	32.4	23.6	18.1	14.4	11.6	9.5	7.7	6.2
load at end of rod (N)	Load offset 0mm	25.6	19.7	15.7	12.7	10.4	8.6	7.1	5.7
	Load offset 100mm	6.6	5.2	4.3	3.7	3.2	2.8	2.6	2.3
Allowable static torque at end of rod (N·m)	2.6	2.0	1.6	1.3	1.0	0.9	0.7	0.6	
	Allowable dynamic torque at end of rod (N·m)	2.6	2.0	1.6	1.3	1.0	0.9	0.7	0.6
Mass (kg)	Without brake	1.9	2.1	2.4	2.7	2.9	3.2	3.4	3.7
	With brake	2.1	2.4	2.6	2.9	3.1	3.4	3.7	3.9

Applicable Controller

RCP4 series actuators can be operated with the controller indicated below. Select the type according to your intended application.

Name	External view	Model number	Features	Maximum number of positioning points	Input power	Power supply capacity	Standard price	Reference page
Positioner type		PCON-CA-42PI-NP-□-0-□ PCON-CA-42PI-PN-□-0-□	Equipped with a high-output driver Positioner type based on PIO control	512 points	DC24V	Refer to P.48	—	Refer to P.41
Pulse-train type		PCON-CA-42PI-PLN-□-0-□ PCON-CA-42PI-PLP-□-0-□	Equipped with a high-output driver Pulse-train input type	—				
Field network type		PCON-CA-42PI-△-0-0-□	Equipped with a high-output driver Supporting 7 major field networks	768 points				
Positioner multi-axis specification PIO type	MSEP-C-□-~-NP-□-0-□ MSEP-C-□-~-PN-□-0-□	Positioner type based on PIO control, allowing up to 8 axes to be connected (high-output driver not supported)	3 points					
Positioner multi-axis specification Network type	MSEP-C-□-~-△-0-0-□	Field network-ready positioner type, allowing up to 8 axes to be connected (high-output driver not supported)	256 points					

* In the model numbers shown above, △ indicates the field network specification (DV, CC, PR, CN, ML, EC or EP).

RCP4-RA6C

ROBO Cylinder, Rod Type, Motor Unit Coupled, Actuator Width 61mm, 24-V Pulse Motor

Model Specification Items	RCP4 — RA6C — I — 56P — <input type="checkbox"/> — <input type="checkbox"/> — P3 — <input type="checkbox"/> — <input type="checkbox"/>	Series	Type	Encoder type	Motor type	Lead	Stroke	Applicable controller	Cable length	Options
	I: Incremental specification	56P: Pulse motor, size 56□	24: 24mm 16: 16mm 8: 8mm 4: 4mm	50: 50mm / 500: 500mm (every 50mm)	P3: PCON-CA MSEP-C	N: None P: 1m S: 3m M: 5m X□□: Specified length R□□: Robot cable	Refer to the options table below.			

Built-in guide mechanism



- POINT**
Notes on selection
- The maximum payload is the value when operated at 0.3G (0.2G with some models) acceleration. The upper limit of acceleration is 1 G (*). Note that raising the acceleration causes the payload to drop.
(* The specific value varies depending on the connected controller and actuator lead. For details, refer to "Selection References" on P. 37 to 40.)
 - Take note that the maximum payload and maximum speed vary depending on the controller connected to the RCP4. (Refer to the actuator specifications below.)
 - All horizontal payloads are values when an external guide is used.

Correlation Diagrams of Speed and Payload

* The values of the horizontal specification assume that an external guide is used.

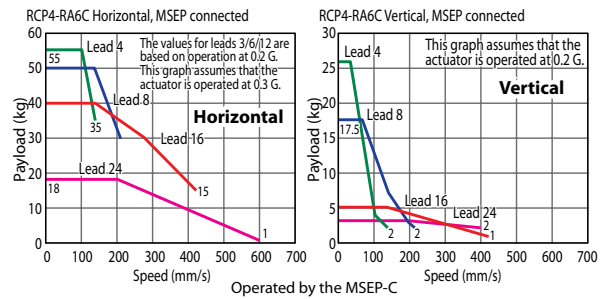
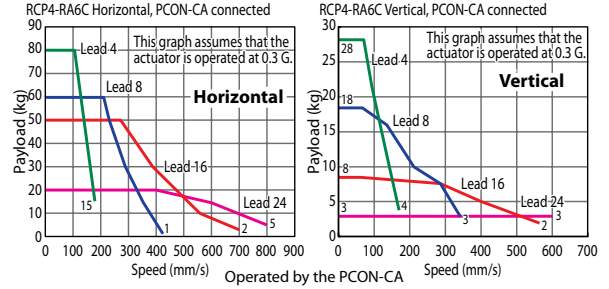

Actuator Specifications

Leads and Payloads

Model number	Lead (mm)	Connected controller	Maximum payload		Max. push force (N)	Stroke (mm)
			Horizontal (kg)	Vertical (kg)		
RCP4-RA6C-I-56P-24-①-P3-②-③	24	PCON-CA	20	3	182	50~500 (every 50mm)
		MSEP-C	18	3 (*)		
RCP4-RA6C-I-56P-16-①-P3-②-③	16	PCON-CA	50	8	273	
		MSEP-C	40 (*)	5 (*)		
RCP4-RA6C-I-56P-8-①-P3-②-③	8	PCON-CA	60	18	547	
		MSEP-C	50 (*)	17.5 (*)		
RCP4-RA6C-I-56P-4-①-P3-②-③	4	PCON-CA	80	28	1094	
		MSEP-C	55 (*)	26 (*)		

Code explanation ① Stroke ② Cable length ③ Options (*) When operated at 0.2 G

Stroke and Maximum Speed

Lead (mm)	Connected controller	50~500 (every 50mm)
24	PCON-CA	800<600>
	MSEP-C	600<400>
16	PCON-CA	700<560>
	MSEP-C	420
8	PCON-CA	420
	MSEP-C	210
4	PCON-CA	210
	MSEP-C	140

The values in <> apply when the actuator is used vertically. (unit: mm/s)

① Stroke

Stroke (mm)	Standard price
50	—
100	—
150	—
200	—
250	—
300	—
350	—
400	—
450	—
500	—

② Cable Length

Type	Cable symbol	Standard price
Standard type	P (1m)	—
	S (3m)	—
	M (5m)	—
Special length	X06 (6m) ~X10 (10m)	—
	X11 (11m) ~X15 (15m)	—
	X16 (16m) ~X20 (20m)	—
	—	—
Robot cable	R01 (1m) ~R03 (3m)	—
	R04 (4m) ~R05 (5m)	—
	R06 (6m) ~R10 (10m)	—
	R11 (11m) ~R15 (15m)	—
	R16 (16m) ~R20 (20m)	—
	—	—

③ Options

Name	Option code	See page	Standard price
Brake	B	P8	—
Optional cable exit direction (top)	CJT	P8	—
Optional cable exit direction (right)	CJR	P8	—
Optional cable exit direction (left)	CJL	P8	—
Optional cable exit direction (bottom)	CJB	P8	—
Flange bracket	FL	P8	—
Non-motor end specification	NM	P8	—
Scraper	SC	P8	—

Actuator Specifications

Item	Description
Drive system	Ball screw ϕ 12 mm, rolled C10
Positioning repeatability (*1)	\pm 0.02mm [\pm 0.03mm]
Lost motion	0.1mm or less
Rod	ϕ 25mm stainless steel pipe
Rod non-rotation precision	\pm 0 deg
Allowable rod load mass	Refer to P. 24 and P. 36
Rod tip overhang distance	100mm or less
Ambient operating temperature, humidity	0 to 40°C, 85% RH or less (Non-condensing)

(*1) The value at lead 20 is shown in [].

23

- *1 Connect the motor and encoder cables.
- *2 During home return, be careful to avoid interference from peripheral objects because the slider travels until the mechanical end.
- *3 The direction of width across flats varies depending on the product.
- *4 If the actuator is installed using the front housing and flange, make sure the actuator will not receive any external force.
(For details, refer to "Notes on Installing Rod Actuators" on P. 35.)

Dimensions with Flange (Optional) (*4)

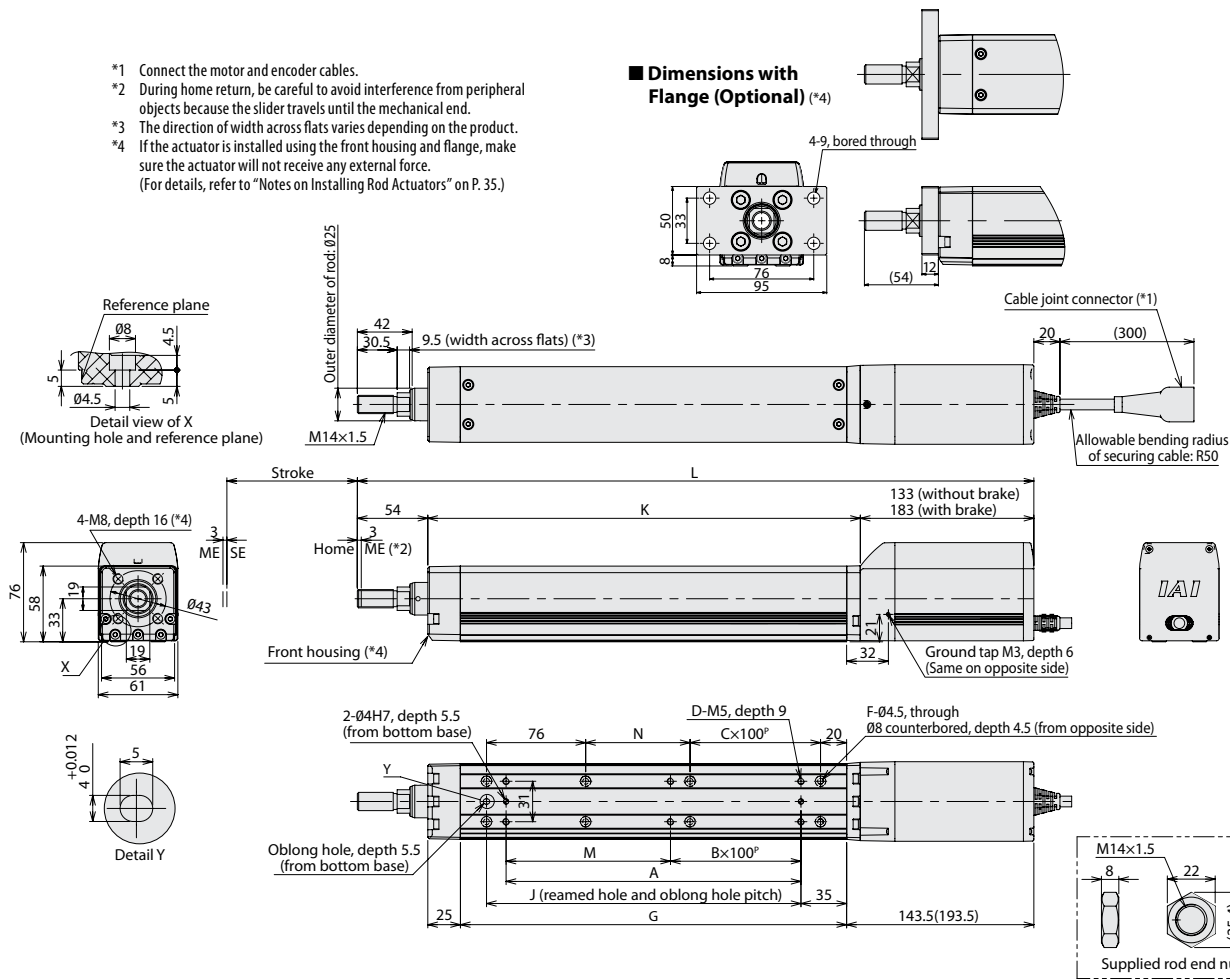

Rod Deflection of RCP4-RA6C (Reference Values)

(The graph below plots deflection as measured by installing the actuator vertically and applying a radial force to the rod from one side.)

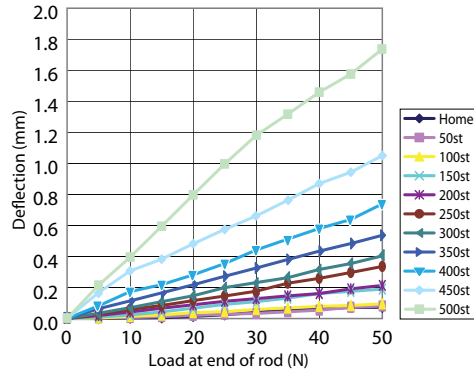

Dimensions and Mass by Stroke

Stroke	Stroke										
	50	100	150	200	250	300	350	400	450	500	
L	Without brake	368.5	418.5	468.5	518.5	568.5	618.5	668.5	718.5	768.5	818.5
	With brake	418.5	468.5	518.5	568.5	618.5	668.5	718.5	768.5	818.5	868.5
A	76	126	176	226	276	326	376	426	476	526	
B	0	0	1	1	2	2	3	3	4	4	
C	0	0	0	1	1	2	2	3	3	4	
D	4	4	6	6	8	8	10	10	12	12	
F	6	6	6	8	8	10	10	12	12	14	
G	146	196	246	296	346	396	446	496	546	596	
J	91	141	191	241	291	341	391	441	491	541	
K	181.5	231.5	281.5	331.5	381.5	431.5	481.5	531.5	581.5	631.5	
M	76	126	176	226	276	326	376	426	476	526	
N	30	80	130	180	230	280	330	380	430	480	
Allowable static load at end of rod (N)		112.7	91.5	76.7	65.7	57.2	50.4	44.8	40.2	36.2	32.7
	Allowable dynamic load at end of rod (N)	49.0	37.4	29.9	24.5	20.4	17.1	14.5	12.3	10.3	8.6
	Load offset 100mm	38.7	31.0	25.5	21.4	18.1	15.4	13.2	11.2	9.5	8.0
Allowable static torque at end of rod (N·m)		11.4	9.3	7.9	6.8	6.0	5.4	4.9	4.5	4.1	3.8
	Allowable dynamic torque at end of rod (N·m)	3.9	3.1	2.5	2.1	1.8	1.5	1.3	1.1	1.0	0.8
Mass (kg)	Without brake	3.4	3.7	4.1	4.4	4.7	5.0	5.4	5.7	6.0	6.3
	With brake	3.9	4.2	4.6	4.9	5.2	5.5	5.9	6.2	6.5	6.8

Applicable Controller

RCP4 series actuators can be operated with the controller indicated below. Select the type according to your intended application.

Name	External view	Model number	Features	Maximum number of positioning points	Input power	Power supply capacity	Standard price	Reference page
Positioner type		PCON-CA-56PI-NP-□-0-□ PCON-CA-56PI-PN-□-0-□	Equipped with a high-output driver Positioner type based on PIO control	512 points	DC24V	Refer to P.48	—	Refer to P.41
Pulse-train type		PCON-CA-56PI-PLN-□-0-□ PCON-CA-56PI-PLP-□-0-□	Equipped with a high-output driver Pulse-train input type	—				
Field network type	PCON-CA-56PI-△-0-0-□	Equipped with a high-output driver Supporting 7 major field networks	768 points					
Positioner multi-axis specification PIO type	MSEP-C-□-~-NP-□-0-□ MSEP-C-□-~-PN-□-0-□	Positioner type based on PIO control, allowing up to 8 axes to be connected (high-output driver not supported)	3 points					
Positioner multi-axis specification Network type	MSEP-C-□-~-△-0-0-□	Field network-ready positioner type, allowing up to 8 axes to be connected (high-output driver not supported)	256 points					

*In the model numbers shown above, △ indicates the field network specification (DV, CC, PR, CN, ML, EC or EP).

RCP4-RA5R

ROBO Cylinder, Rod Type, Side-mounted Motor Type, Actuator Width 52mm, 24-V Pulse Motor

Model Specification Items	RCP4	RA5R	I	42P			P3		
	Series	Type	Encoder type	Motor type	Lead	Stroke	Applicable controller	Cable length	Options
			I: Incremental specification	42P: Pulse motor, size 42□	20: 20mm 12: 12mm 6: 6mm 3: 3mm	50: 50mm / 400: 400mm (every 50mm)	P3: PCON-CA MSEP-C	N: None P: 1 m S: 3 m M: 5 m X□□: Specified length R□□: Robot cable	Refer to the options table below. * Be sure to specify either "ML" or "MR" as the motor side-mounted direction.

Built-in guide mechanism



The "Motor side-mounted to the left (ML)" option is selected for the actuator shown above.

- POINT**
Notes on selection
- The maximum payload is the value when operated at 0.3G (0.2G with some models) acceleration. The upper limit of acceleration is 1 G (*). Note that raising the acceleration causes the payload to drop. (*): The specific value varies depending on the connected controller and actuator lead. For details, refer to "Selection References" on P. 37 to 40.
 - Take note that the maximum payload and maximum speed vary depending on the controller connected to the RCP4. (Refer to the actuator specifications below.)
 - All horizontal payloads are values when an external guide is used.

Correlation Diagrams of Speed and Payload

* The values of the horizontal specification assume that an external guide is used.

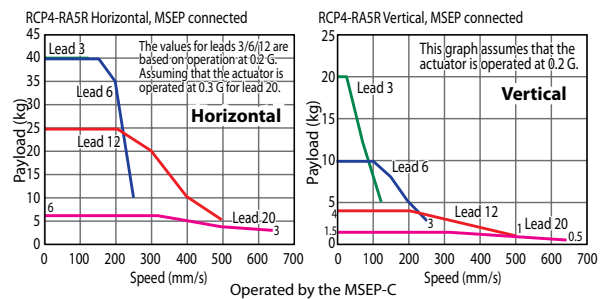
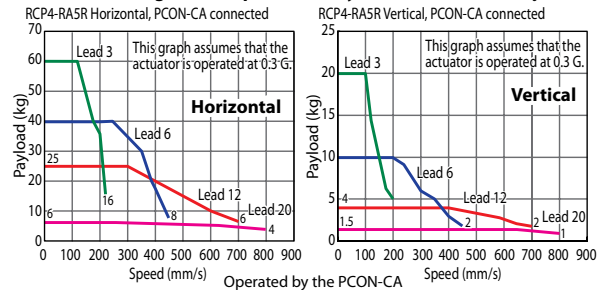

Actuator Specifications

Leads and Payloads

Model number	Lead (mm)	Connected controller	Maximum payload		Max. push force (N)	Stroke (mm)
			Horizontal (kg)	Vertical (kg)		
RCP4-RA5R-I-42P-20-①-P3-②-③	20	PCON-CA	6	1.5	56	50~400 (every 50mm)
		MSEP-C	6	1.5 (*)		
RCP4-RA5R-I-42P-12-①-P3-②-③	12	PCON-CA	25	4	93	
		MSEP-C	25 (*)	4 (*)		
RCP4-RA5R-I-42P-6-①-P3-②-③	6	PCON-CA	40	10	185	
		MSEP-C	40 (*)	10 (*)		
RCP4-RA5R-I-42P-3-①-P3-②-③	3	PCON-CA	60	20	370	
		MSEP-C	40 (*)	20 (*)		

Code explanation ① Stroke ② Cable length ③ Options (*) When operated at 0.2 G

Stroke and Maximum Speed

Lead (mm)	Connected controller	50~400 (every 50mm)
20	PCON-CA	800
	MSEP-C	640
12	PCON-CA	700
	MSEP-C	500
6	PCON-CA	450
	MSEP-C	250
3	PCON-CA	225
	MSEP-C	125

(unit: mm/s)

① Stroke

Stroke (mm)	Standard price
50	—
100	—
150	—
200	—
250	—
300	—
350	—
400	—

② Cable Length

Type	Cable symbol	Standard price
Standard type	P (1m)	—
	S (3m)	—
	M (5m)	—
Special length	X06 (6m) ~X10 (10m)	—
	X11 (11m) ~X15 (15m)	—
	X16 (16m) ~X20 (20m)	—
		—
Robot cable	R01 (1m) ~R03 (3m)	—
	R04 (4m) ~R05 (5m)	—
	R06 (6m) ~R10 (10m)	—
	R11 (11m) ~R15 (15m)	—
	R16 (16m) ~R20 (20m)	—
		—

③ Options

Name	Option code	See page	Standard price
Brake	B	P8	—
Optional cable exit direction (top)	CJT	P8	—
Optional cable exit direction (outside)	CJO	P8	—
Optional cable exit direction (bottom)	CJB	P8	—
Flange bracket (*)	FL	P8	—
Motor side-mounted to the left (standard)	ML	P8	—
Motor side-mounted to the right	MR	P8	—
Non-motor end specification	NM	P8	—
Scraper	SC	P8	—

(*) The flange bracket cannot be used on the 50mm and less stroke with brake specification.

Actuator Specifications

Item	Description
Drive system	Ball screw ϕ 10 mm, rolled C10
Positioning repeatability (*1)	\pm 0.02mm [\pm 0.03mm]
Lost motion	0.1mm or less
Rod	ϕ 22mm stainless steel pipe
Rod non-rotation precision	\pm 0 deg
Allowable rod load mass	Refer to P. 26 and P. 36
Rod tip overhang distance	100mm or less
Ambient operating temperature, humidity	0 to 40°C, 85% RH or less (Non-condensing)

(*1) The value at lead 20 is shown in [].

25

RCP4-RA6R

ROBO Cylinder, Rod Type, Side-mounted Motor Type, Actuator Width 61 mm, 24-V Pulse Motor

Model Specification Items	RCP4 — RA6R — I — 56P — [] — [] — []	P3 — [] — []
	Series — Type — Encoder type — Motor type — Lead — Stroke — Applicable controller — Cable length — Options	
	I: Incremental specification 56P: Pulse motor, size 56□	24: 24mm 16: 16mm 8: 8mm 4: 4mm
		50: 50mm ? : 500: 500mm (every 50mm)
		P3: PCON-CA MSEP-C
		N: None P: 1 m S: 3 m M: 5 m X□□: Specified length R□□: Robot cable
		Refer to the options table below. * Be sure to specify either "ML" or "MR" as the motor side-mounted direction.

Built-in guide mechanism



The "Motor side-mounted to the left (ML)" option is selected for the actuator shown above.

POINT
Notes on selection

- The maximum payload is the value when operated at 0.3G (0.2G with some models) acceleration. The upper limit of acceleration is 1 G (*). Note that raising the acceleration causes the payload to drop.
(*) The specific value varies depending on the connected controller and actuator lead. For details, refer to "Selection References" on P. 37 to 40.
- Take note that the maximum payload and maximum speed vary depending on the controller connected to the RCP4. (Refer to the actuator specifications below.)
- All horizontal payloads are values when an external guide is used.

Correlation Diagrams of Speed and Payload

* The values of the horizontal specification assume that an external guide is used.

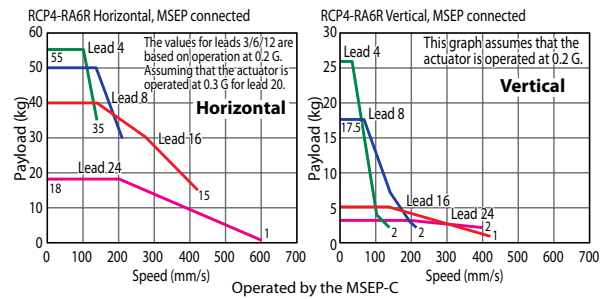
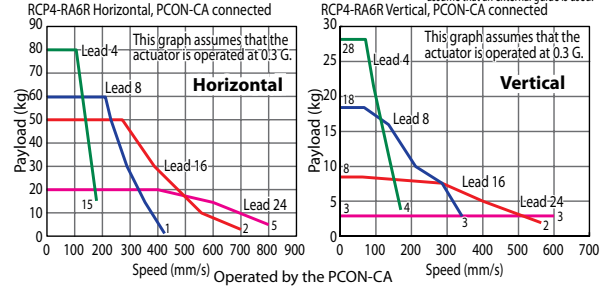

Actuator Specifications

Leads and Payloads

Model number	Lead (mm)	Connected controller	Maximum payload		Max. push force (N)	Stroke (mm)
			Horizontal (kg)	Vertical (kg)		
RCP4-RA6R-I-56P-24-①-P3-②-③	24	PCON-CA	20	3	182	50~500 (every 50mm)
		MSEP-C	18	3 (*)		
RCP4-RA6R-I-56P-16-①-P3-②-③	16	PCON-CA	50	8	273	
		MSEP-C	40 (*)	5 (*)		
RCP4-RA6R-I-56P-8-①-P3-②-③	8	PCON-CA	60	18	547	
		MSEP-C	50 (*)	17.5 (*)		
RCP4-RA6R-I-56P-4-①-P3-②-③	4	PCON-CA	80	28	1094	
		MSEP-C	55 (*)	26 (*)		

Code explanation ① Stroke ② Cable length ③ Options (*) When operated at 0.2 G

Stroke and Maximum Speed

Lead (mm)	Connected controller	50~500 (every 50mm)
24	PCON-CA	800<600>
	MSEP-C	600<400>
16	PCON-CA	560
	MSEP-C	420
8	PCON-CA	420<350>
	MSEP-C	210
4	PCON-CA	175
	MSEP-C	140

The values in <> apply when the actuator is used vertically. (unit: mm/s)

① Stroke

Stroke (mm)	Standard price
50	—
100	—
150	—
200	—
250	—
300	—
350	—
400	—
450	—
500	—

③ Options

Name	Option code	See page	Standard price
Brake	B	P8	—
Optional cable exit direction (top)	CJT	P8	—
Optional cable exit direction (outside)	CJO	P8	—
Optional cable exit direction (bottom)	CJB	P8	—
Flange bracket (*)	FL	P8	—
Motor side-mounted to the left (standard)	ML	P8	—
Motor side-mounted to the right	MR	P8	—
Non-motor end specification	NM	P8	—
Scraper	SC	P8	—

(*) The flange bracket cannot be used on the 50mm and less stroke with brake specification.

② Cable Length

Type	Cable symbol	Standard price
Standard type	P (1m)	—
	S (3m)	—
	M (5m)	—
Special length	X06 (6m) ~X10 (10m)	—
	X11 (11m) ~X15 (15m)	—
	X16 (16m) ~X20 (20m)	—
	R01 (1m) ~R03 (3m)	—
Robot cable	R04 (4m) ~R05 (5m)	—
	R06 (6m) ~R10 (10m)	—
	R11 (11m) ~R15 (15m)	—
	R16 (16m) ~R20 (20m)	—

Actuator Specifications

Item	Description
Drive system	Ball screw Ø12 mm, rolled C10
Positioning repeatability (*)	±0.02mm [±0.03mm]
Lost motion	0.1mm or less
Rod	Ø25mm stainless steel pipe
Rod non-rotation precision	±0 deg
Allowable rod load mass	Refer to P. 28 and P. 36
Rod tip overhang distance	100mm or less
Ambient operating temperature, humidity	0 to 40°C, 85% RH or less (Non-condensing)

(*) The value at lead 20 is shown in [].

RCP4CR-SA5C

Cleanroom ROBO Cylinder, Slider Type, Motor Unit Coupled, Actuator Width 52mm, 24-V Pulse Motor

Model Specification Items	RCP4CR	SA5C	I	42P	<input type="checkbox"/>	<input type="checkbox"/>	P3	<input type="checkbox"/>	<input type="checkbox"/>
	Series	Type	Encoder type	Motor type	Lead	Stroke	Applicable controller	Cable length	Options
	I: Incremental specification	42P: Pulse motor, size 42□	20: 20mm 12: 12mm 6: 6mm 3: 3mm	50: 50mm ↓ 800: 800mm (every 50mm)	P3: PCON-CA MSEP-C	N: None P: 1 m S: 3 m M: 5 m X□: Specified length R□: Robot cable	Refer to the options table below.		



- The maximum payload is the value when operated at 0.3G (0.2G with some models) acceleration. The upper limit of acceleration is 1 G (*). Note that raising the acceleration causes the payload to drop. (*The specific value varies depending on the connected controller and actuator lead. For details, refer to "Selection References" on P. 37 to 40.
- Take note that the maximum payload and maximum speed vary depending on the controller connected to the RCP4. (Refer to the actuator specifications below.)

Correlation Diagrams of Speed and Payload

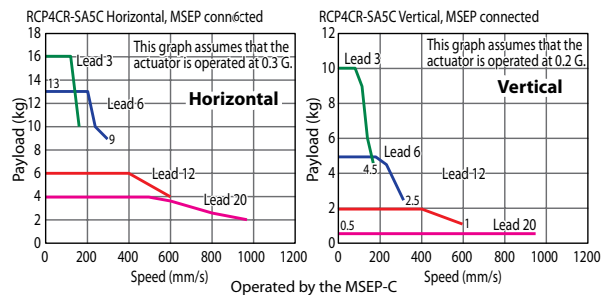
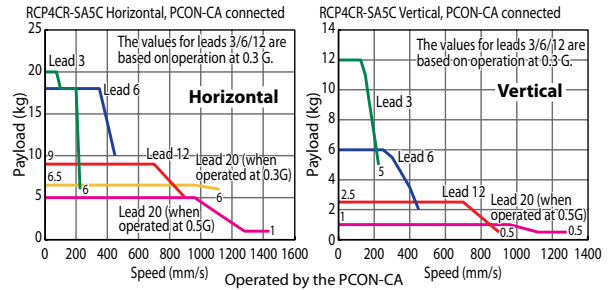

Actuator Specifications

Leads and Payloads

Model number	Lead (mm)	Connected controller	Maximum payload		Stroke (mm)
			Horizontal (kg)	Vertical (kg)	
RCP4CR-SA5C-I-42P-20-①-P3-②-③	20	PCON-CA	6.5	1	50~800 (every 50mm)
		MSEP-C	4	0.5 (*)	
RCP4CR-SA5C-I-42P-12-①-P3-②-③	12	PCON-CA	9	2.5	
		MSEP-C	6	2	
RCP4CR-SA5C-I-42P-6-①-P3-②-③	6	PCON-CA	18	6	
		MSEP-C	13	5	
RCP4CR-SA5C-I-42P-3-①-P3-②-③	3	PCON-CA	20	12	
		MSEP-C	16	10	

Code explanation ① Stroke ② Cable length ③ Options (*) When operated at 0.2 G

Stroke and Maximum Speed

Lead (mm)	Connected controller	Maximum speed (mm/s)								Suction amount (N/min)
		50~450 (every 50mm)	500 (mm)	550 (mm)	600 (mm)	650 (mm)	700 (mm)	750 (mm)	800 (mm)	
20	PCON-CA	1440 <1280>								80
	MSEP-C	960								
12	PCON-CA	900	795	665	570	490	425	375	330	50
	MSEP-C	600								
6	PCON-CA	450	395	335	285	245	215	185	165	30
	MSEP-C	300								
3	PCON-CA	225	195	165	140	120	105	90	80	15
	MSEP-C	150								

The values in < > apply when the actuator is used vertically. (unit: mm/s)

① Stroke

Stroke (mm)	Standard price	Stroke (mm)	Standard price
50	—	450	—
100	—	500	—
150	—	550	—
200	—	600	—
250	—	650	—
300	—	700	—
350	—	750	—
400	—	800	—

② Cable Length

Type	Cable symbol	Standard price
Standard type	P (1m)	—
	S (3m)	—
	M (5m)	—
Special length	X06 (6m) ~X10 (10m)	—
	X11 (11m) ~X15 (15m)	—
	X16 (16m) ~X20 (20m)	—
Robot cable	R01 (1m) ~R03 (3m)	—
	R04 (4m) ~R05 (5m)	—
	R06 (6m) ~R10 (10m)	—
	R11 (11m) ~R15 (15m)	—
	R16 (16m) ~R20 (20m)	—

③ Options

Name	Option code	See page	Standard price
Brake	B	P8	—
Optional cable exit direction (top)	CJT	P8	—
Optional cable exit direction (right)	CJR	P8	—
Optional cable exit direction (left)	CJL	P8	—
Optional cable exit direction (bottom)	CJB	P8	—
Non-motor end specification	NM	P8	—
Vacuum joint on opposite side	VR	P8	—

Actuator Specifications

Item	Description
Drive system	Ball screw Ø10 mm, rolled C10
Positioning repeatability (*1)	±0.02mm [±0.03mm]
Lost motion	0.1mm or less
Base	Material: Aluminum with white alumite treatment
Dynamic allowable moment (*2)	Ma: 4.9 N·m, Mb: 6.8 N·m, Mc: 11.7 N·m
Allowable overhang	150 mm or less in Ma, Mb and Mc directions
Grease	Low dust generation grease (urea grease) is used for both ball screws and guides.
Cleanness	Class 10 (0.1 μm)
Ambient operating temperature, humidity	0 to 40°C, 85% RH or less (Non-condensing)

(*1) The value at lead 20 is shown in [. (*2) Based on 5,000 km of traveling life.

29

- *1 Connect the motor and encoder cables.
- *2 During home return, be careful to avoid interference from peripheral objects because the slider travels until the mechanical end.

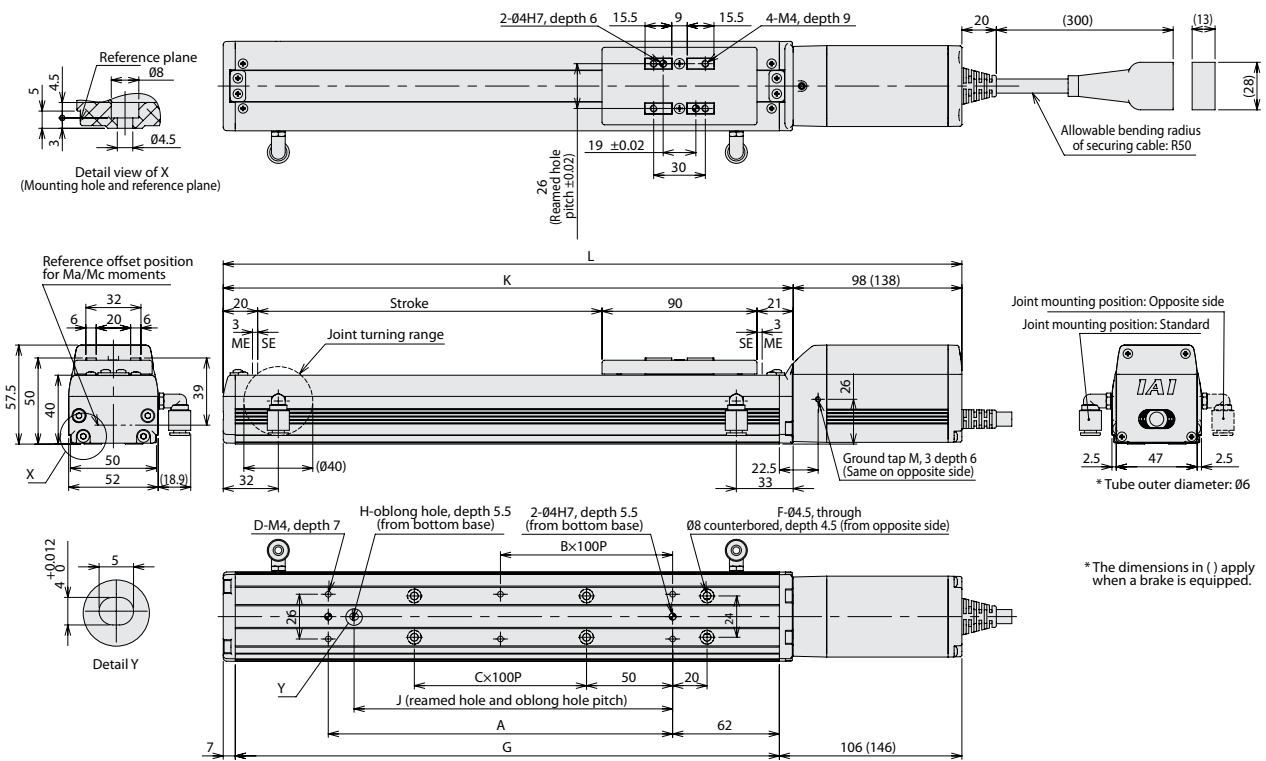

■ Dimensions and Mass by Stroke

Stroke	50	100	150	200	250	300	350	400	450	500	550	600	650	700	750	800	
L	Without brake	279	329	379	429	479	529	579	629	679	729	779	829	879	929	979	1029
	With brake	319	369	419	469	519	569	619	669	719	769	819	869	919	969	1019	1069
A	73	100	100	200	200	300	300	400	400	500	500	600	600	700	700	800	
B	0	0	0	1	1	2	2	3	3	4	4	5	5	6	6	7	
C	0	0	1	1	2	2	3	3	4	4	5	5	6	6	7	7	
D	4	4	4	6	6	8	8	10	10	12	12	14	14	16	16	18	
F	4	4	6	6	8	8	10	10	12	12	14	14	16	16	18	18	
G	166	216	266	316	366	416	466	516	566	616	666	716	766	816	866	916	
H	0	1	1	1	1	1	1	1	1	1	1	1	1	1	1	1	
J	0	85	85	185	185	285	285	385	385	485	485	585	585	685	685	785	
K	181	231	281	331	381	431	481	531	581	631	681	731	781	831	881	931	
Mass (kg)	Without brake	1.5	1.6	1.8	1.9	2.1	2.2	2.4	2.5	2.6	2.8	2.9	3.1	3.2	3.4	3.5	3.7
	With brake	1.7	1.9	2.0	2.1	2.3	2.4	2.6	2.7	2.9	3.0	3.2	3.3	3.5	3.6	3.7	3.9

Applicable Controller

RCP4 series actuators can be operated with the controller indicated below. Select the type according to your intended application.

Name	External view	Model number	Features	Maximum number of positioning points	Input power	Power supply capacity	Standard price	Reference page		
Positioner type		PCON-CA-42PI-NP-□-0-□ PCON-CA-42PI-PN-□-0-□	Equipped with a high-output driver Positioner type based on PIO control	512 points	DC24V	Refer to P. 48	—	Refer to P. 41		
Pulse-train type		PCON-CA-42PI-PLN-□-0-□ PCON-CA-42PI-PLP-□-0-□	Equipped with a high-output driver Pulse-train input type	—						
Field network type	PCON-CA-42PI-△-0-0-□	Equipped with a high-output driver Supporting 7 major field networks	768 points							
Positioner multi-axis specification PIO type	MSEP-C-□-~-NP-□-0-□ MSEP-C-□-~-PN-□-0-□	Positioner type based on PIO control, allowing up to 8 axes to be connected (high-output driver not supported)	3 points	Refer to the MSEP catalog.					Refer to the MSEP catalog.	Refer to the MSEP catalog.
Positioner multi-axis specification Network type	MSEP-C-□-~-△-0-0-□	Field network-ready positioner type, allowing up to 8 axes to be connected (high-output driver not supported)	256 points							

* In the model numbers shown above, △ indicates the field network specification (DV, CC, PR, CN, ML, EC or EP).

RCP4CR-SA6C

Cleanroom ROBO Cylinder, Slider Type, Motor Unit Coupled, Actuator Width 58mm, 24-V Pulse Motor

Model Specification Items

RCP4CR — SA6C — I — 42P — — — **P3** — —

Series — Type — Encoder type — Motor type — Lead — Stroke — Applicable controller — Cable length — Options

I: Incremental specification
42P: Pulse motor, size 42□
20: 20mm
12: 12mm
6: 6mm
3: 3mm
50: 50mm
800: 800mm (every 50mm)
P3: PCON-CA
MSEP-C
N: None
P: 1 m
S: 3 m
M: 5 m
X□: Specified length
R□: Robot cable
Refer to the options table below.



- The maximum payload is the value when operated at 0.3G (0.2G with some models) acceleration. The upper limit of acceleration is 1 G (*). Note that raising the acceleration causes the payload to drop. (*The specific value varies depending on the connected controller and actuator lead. For details, refer to "Selection References" on P. 37 to 40.
- Take note that the maximum payload and maximum speed vary depending on the controller connected to the RCP4. (Refer to the actuator specifications below.)

Correlation Diagrams of Speed and Payload

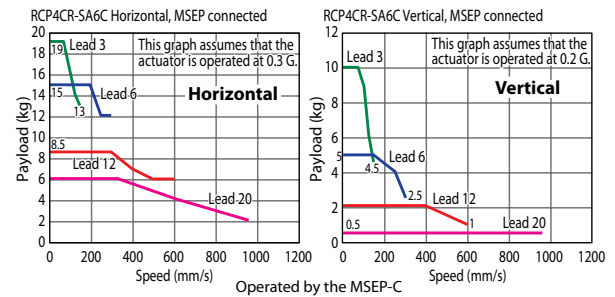
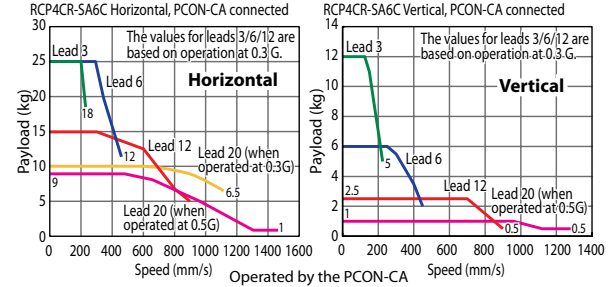

Actuator Specifications

Leads and Payloads

Model number	Lead (mm)	Connected controller	Maximum payload		Stroke (mm)
			Horizontal (kg)	Vertical (kg)	
RCP4CR-SA6C-I-42P-20-①-P3-②-③	20	PCON-CA	10	1	50~800 (every 50mm)
		MSEP-C	6	0.5 (*)	
RCP4CR-SA6C-I-42P-12-①-P3-②-③	12	PCON-CA	15	2.5	
		MSEP-C	8.5	2	
RCP4CR-SA6C-I-42P-6-①-P3-②-③	6	PCON-CA	25	6	
		MSEP-C	15	5	
RCP4CR-SA6C-I-42P-3-①-P3-②-③	3	PCON-CA	25	12	
		MSEP-C	19	10	

Code explanation ① Stroke ② Cable length ③ Options (*) When operated at 0.2 G

Stroke and Maximum Speed

Lead (mm)	Connected controller	Stroke (mm)								Suction amount (Nl/min)
		50~450 (every 50mm)	500	550	600	650	700	750	800	
20	PCON-CA	1440<1280>								80
	MSEP-C	960								
12	PCON-CA	900	795	670	570	490	430	375	335	50
	MSEP-C	600								
6	PCON-CA	450	395	335	285	245	215	185	165	30
	MSEP-C	300								
3	PCON-CA	225	195	165	140	120	105	90	80	15
	MSEP-C	150								

The values in <> apply when the actuator is used vertically. (unit: mm/s)

① Stroke

Stroke (mm)	Standard price	Stroke (mm)	Standard price
50	—	450	—
100	—	500	—
150	—	550	—
200	—	600	—
250	—	650	—
300	—	700	—
350	—	750	—
400	—	800	—

② Cable Length

Type	Cable symbol	Standard price
Standard type	P (1m)	—
	S (3m)	—
	M (5m)	—
Special length	X06 (6m) ~X10 (10m)	—
	X11 (11m) ~X15 (15m)	—
	X16 (16m) ~X20 (20m)	—
Robot cable	R01 (1m) ~R03 (3m)	—
	R04 (4m) ~R05 (5m)	—
	R06 (6m) ~R10 (10m)	—
	R11 (11m) ~R15 (15m)	—
	R16 (16m) ~R20 (20m)	—

③ Options

Name	Option code	See page	Standard price
Brake	B	P8	—
Optional cable exit direction (top)	CJT	P8	—
Optional cable exit direction (right)	CJR	P8	—
Optional cable exit direction (left)	CJL	P8	—
Optional cable exit direction (bottom)	CJB	P8	—
Non-motor end specification	NM	P8	—
Vacuum joint on opposite side	VR	P8	—

Actuator Specifications

Item	Description
Drive system	Ball screw #10 mm, rolled C10
Positioning repeatability (*1)	±0.02mm [±0.03mm]
Lost motion	0.1mm or less
Base	Material: Aluminum with white alumite treatment
Dynamic allowable moment (*2)	Ma: 8.9 N·m, Mb: 12.7 N·m, Mc: 18.6 N·m
Allowable overhang	220 mm or less in Ma, Mb and Mc directions
Grease	Low dust generation grease (urea grease) is used for both ball screws and guides.
Cleanness	Class 10 (0.1 μm)
Ambient operating temperature, humidity	0 to 40°C, 85% RH or less (Non-condensing)

(*1) The value at lead 20 is shown in [. (*2) Based on 5,000 km of traveling life.

31

RCP4CR-SA7C

Cleanroom ROBO Cylinder, Slider Type, Motor Unit Coupled, Actuator Width 73mm, 24-V Pulse Motor

Model Specification Items	RCP4CR	SA7C	I	56P	<input type="checkbox"/>	<input type="checkbox"/>	P3	<input type="checkbox"/>	<input type="checkbox"/>
	Series	Type	Encoder type	Motor type	Lead	Stroke	Applicable controller	Cable length	Options
			I: Incremental specification	56P: Pulse motor, size 56□	24: 24mm 16: 16mm 8: 8mm 4: 4mm	50: 50mm ?: 800: 800mm (every 50mm)	P3: PCON-CA MSEP-C	N: None P: 1 m S: 3 m M: 5 m X□: Specified length R□: Robot cable	Refer to the options table below.



- The maximum payload is the value when operated at 0.3G (0.2G with some models) acceleration. The upper limit of acceleration is 1 G (*). Note that raising the acceleration causes the payload to drop. (*): The specific value varies depending on the connected controller and actuator lead. For details, refer to "Selection References" on P. 37 to 40.
- Take note that the maximum payload and maximum speed vary depending on the controller connected to the RCP4. (Refer to the actuator specifications below.)

Correlation Diagrams of Speed and Payload

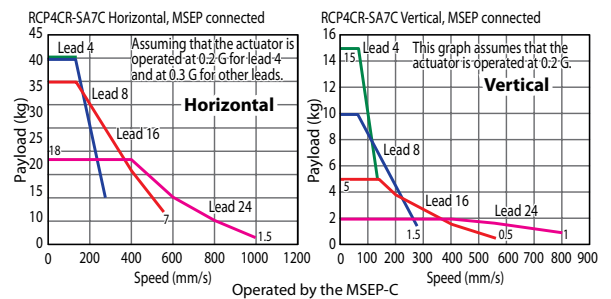
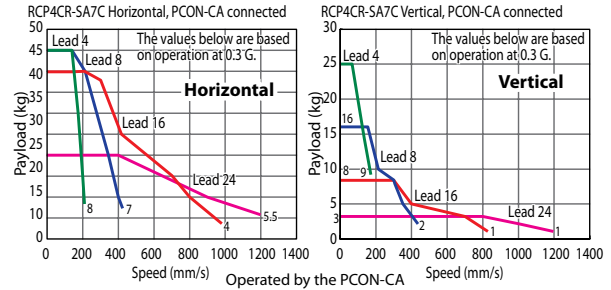

Actuator Specifications

Leads and Payloads

Model number	Lead (mm)	Connected controller	Maximum payload		Stroke (mm)
			Horizontal (kg)	Vertical (kg)	
RCP4CR-SA7C-I-56P-24-①-P3-②-③	24	PCON-CA	20	3	50~800 (every 50mm)
		MSEP-C	18	2 (*)	
RCP4CR-SA7C-I-56P-16-①-P3-②-③	16	PCON-CA	40	8	
		MSEP-C	35	5 (*)	
RCP4CR-SA7C-I-56P-8-①-P3-②-③	8	PCON-CA	45	16	
		MSEP-C	40	10 (*)	
RCP4CR-SA7C-I-56P-4-①-P3-②-③	4	PCON-CA	45	25	
		MSEP-C	40 (*)	15 (*)	

Code explanation ① Stroke ② Cable length ③ Options (*) When operated at 0.2 G

Stroke and Maximum Speed

Lead (mm)	Connected controller	Maximum speed (mm/s)								Suction amount (Nl/min)
		50~450 (every 50mm)	500 (mm)	550 (mm)	600 (mm)	650 (mm)	700 (mm)	750 (mm)	800 (mm)	
24	PCON-CA	1200								90
	MSEP-C	1000<800>								
16	PCON-CA	980<840>	865<840>			750	655	580	515	70
	MSEP-C	560								
8	PCON-CA	490	430	375	325	290	255		40	
	MSEP-C	280								
4	PCON-CA	245<210>	215<210>		185	160	145	125	30	
	MSEP-C	140								

The values in <> apply when the actuator is used vertically. (unit: mm/s)

① Stroke

Stroke (mm)	Standard price	Stroke (mm)	Standard price
50	—	450	—
100	—	500	—
150	—	550	—
200	—	600	—
250	—	650	—
300	—	700	—
350	—	750	—
400	—	800	—

② Cable Length

Type	Cable symbol	Standard price
Standard type	P (1m)	—
	S (3m)	—
	M (5m)	—
Special length	X06 (6m) ~X10 (10m)	—
	X11 (11m) ~X15 (15m)	—
	X16 (16m) ~X20 (20m)	—
Robot cable	R01 (1m) ~R03 (3m)	—
	R04 (4m) ~R05 (5m)	—
	R06 (6m) ~R10 (10m)	—
	R11 (11m) ~R15 (15m)	—
	R16 (16m) ~R20 (20m)	—

③ Options

Name	Option code	See page	Standard price
Brake	B	P8	—
Optional cable exit direction (top)	CJT	P8	—
Optional cable exit direction (right)	CJR	P8	—
Optional cable exit direction (left)	CJL	P8	—
Optional cable exit direction (bottom)	CJB	P8	—
Non-motor end specification	NM	P8	—
Vacuum joint on opposite side	VR	P8	—

Actuator Specifications

Item	Description
Drive system	Ball screw ϕ 10 mm, rolled C10
Positioning repeatability (*1)	± 0.02 mm [± 0.03 mm]
Lost motion	0.1mm or less
Base	Material: Aluminum with white alumite treatment
Dynamic allowable moment (*2)	Ma: 13.9 N·m, Mb: 19.9 N·m, Mc: 38.3 N·m
Allowable overhang	230 mm or less in Ma, Mb and Mc directions
Grease	Low dust generation grease (urea grease) is used for both ball screws and guides.
Cleanness	Class 10 (0.1 μ m)
Ambient operating temperature, humidity	0 to 40°C, 85% RH or less (Non-condensing)

(*1) The value at lead 20 is shown in []. (*2) Based on 5,000 km of traveling life.

33

- *1 Connect the motor and encoder cables.
- *2 During home return, be careful to avoid interference from peripheral objects because the slider travels until the mechanical end.

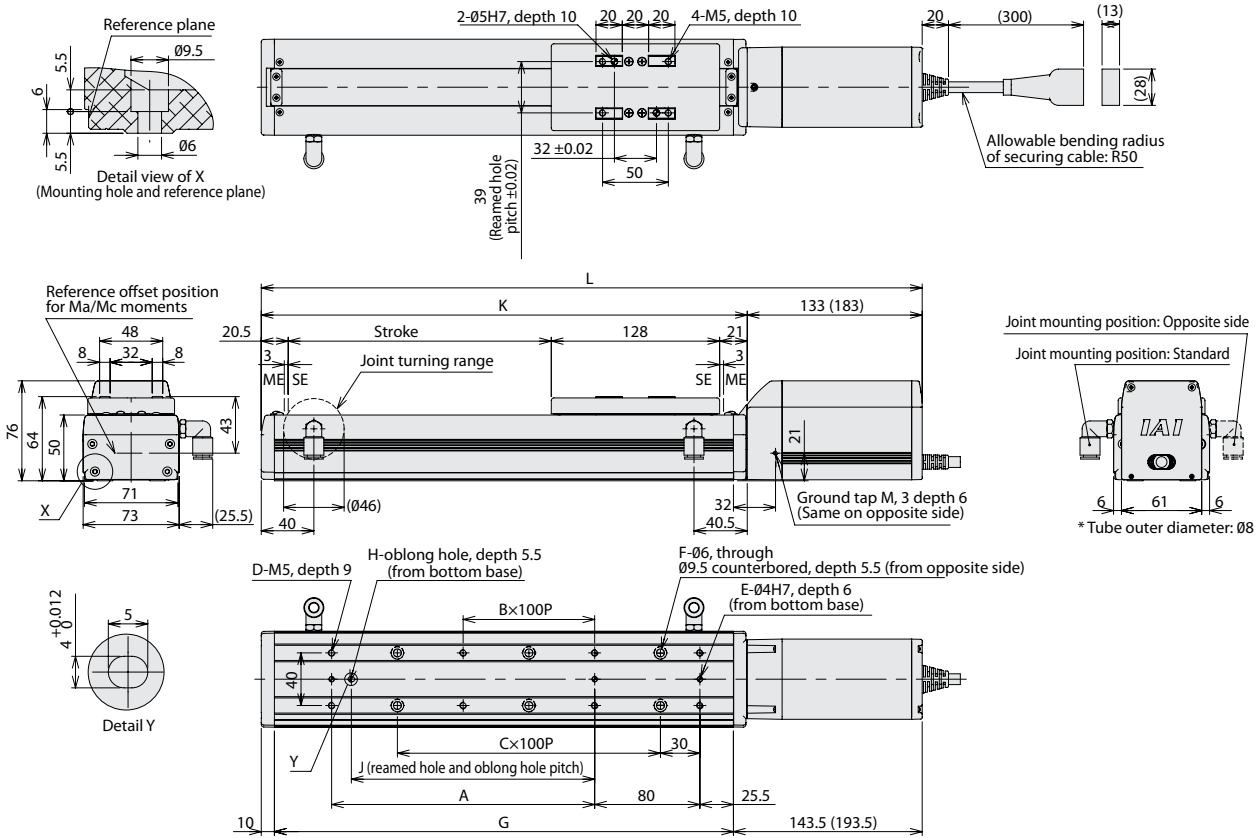

■ Dimensions and Mass by Stroke

Stroke	50	100	150	200	250	300	350	400	450	500	550	600	650	700	750	800	
L	Without brake	352.5	402.5	452.5	502.5	552.5	602.5	652.5	702.5	752.5	802.5	852.5	902.5	952.5	1002.5	1052.5	1102.5
	With brake	402.5	452.5	502.5	552.5	602.5	652.5	702.5	752.5	802.5	852.5	902.5	952.5	1002.5	1052.5	1102.5	1152.5
A	0	100	100	200	200	300	300	400	400	500	500	600	600	700	700	800	
B	0	0	0	1	1	2	2	3	3	4	4	5	5	6	6	7	
C	1	1	2	2	3	3	4	4	5	5	6	6	7	7	8	8	
D	4	6	6	8	8	10	10	12	12	14	14	16	16	18	18	20	
E	2	3	3	3	3	3	3	3	3	3	3	3	3	3	3	3	
F	4	4	6	6	8	8	10	10	12	12	14	14	16	16	18	18	
G	199	249	299	349	399	449	499	549	599	649	699	749	799	849	899	949	
H	0	1	1	1	1	1	1	1	1	1	1	1	1	1	1	1	
J	0	85	85	185	185	285	285	385	385	485	485	585	585	685	685	785	
K	219.5	269.5	319.5	369.5	419.5	469.5	519.5	569.5	619.5	669.5	719.5	769.5	819.5	869.5	919.5	969.5	
Mass (kg)	Without brake	3.4	3.6	3.8	4.1	4.3	4.6	4.8	5.1	5.3	5.6	5.8	6.0	6.3	6.5	6.8	7.0
	With brake	3.9	4.1	4.3	4.6	4.8	5.1	5.3	5.6	5.8	6.1	6.3	6.5	6.8	7.0	7.3	7.5

Applicable Controller

RCP4 series actuators can be operated with the controller indicated below. Select the type according to your intended application.

Name	External view	Model number	Features	Maximum number of positioning points	Input power	Power supply capacity	Standard price	Reference page
Positioner type		PCON-CA-56PI-NP-□-0-□ PCON-CA-56PI-PN-□-0-□	Equipped with a high-output driver Positioner type based on PIO control	512 points	DC24V	Refer to P. 48	—	Refer to P. 41
Pulse-train type		PCON-CA-56PI-PLN-□-0-□ PCON-CA-56PI-PLP-□-0-□	Equipped with a high-output driver Pulse-train input type	—				
Field network type		PCON-CA-56PI-△-0-0-□	Equipped with a high-output driver Supporting 7 major field networks	768 points				
Positioner multi-axis specification PIO type		MSEP-C-□-~-NP-□-0-□ MSEP-C-□-~-PN-□-0-□	Positioner type based on PIO control, allowing up to 8 axes to be connected (high-output driver not supported)	3 points				
Positioner multi-axis specification Network type		MSEP-C-□-~-△-0-0-□	Field network-ready positioner type, allowing up to 8 axes to be connected (high-output driver not supported)	256 points				

* In the model numbers shown above, △ indicates the field network specification (DV, CC, PR, CN, ML, EC or EP).

Notes on Installing Rod Actuators

When installing the actuator using the front housing or with a flange (optional), make sure the actuator will not receive external forces. (External forces may cause malfunction or damaged parts.) If the actuator will receive external forces or when the actuator is combined with a Cartesian robot, etc., use the mounting holes on the actuator base to secure the actuator.

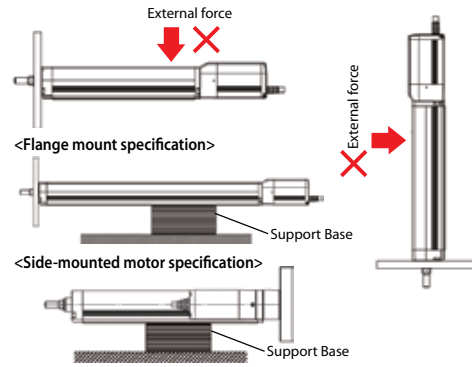

Even when the actuator does not receive any external force, provide a support base to support the actuator, as shown in the figure on the right, if the actuator is installed horizontally and secured using a flange or through the bracket mounting holes of the side-mounted motor specification.

Selection Guideline (Correlation Diagram of Push Force and Current-limiting Value)

In push-motion operation, the push force can be used by changing the current-limiting value of the controller over a range of 20% to 70%. The maximum push-force varies depending on the model, so check the required push force from the table below and select an appropriate type meeting the purpose of use.

When performing push-motion operation using a slider actuator, limit the push current so that the reactive force moment generated by the push force will not exceed 80% of the rated moment (M_a , M_b) specified in the catalog. To help with the moment calculations, the application position of the guide moment is shown in the figure below. Calculate the necessary moment by considering the offset of the push force application position.

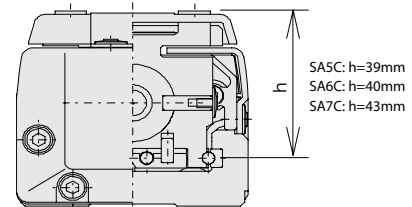

Note that if an excessive force exceeding the rated moment is applied, the guide may be damaged and the life may become shorter. Accordingly, include a sufficient safety factor when deciding on the push force.

Calculation example:

If push-motion operation is performed with a RCP4-SA7C by applying 100 N at the position shown to the right, the moment received by the guide, or M_a , is calculated as $(43 + 50) \times 100 = 9300 \text{ (N}\cdot\text{mm)} = 9.3 \text{ (N}\cdot\text{m)}$.

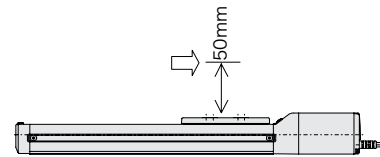

Since the rated moment M_a of the SA7C is 13.9 (N·m), $13.9 \times 0.8 = 11.12 > 9.3$, suggesting that this selection is acceptable. If a M_b moment generates due to push-motion operation, calculate the moment from the overhang and confirm, in the same way, that the calculated moment is within 80% of the rated moment.

Correlation Diagrams of Push Force and Current-limiting value

The table below is only a reference, and the graphs may vary slightly from the actual values.

SA5C/SA6C/RA5C type

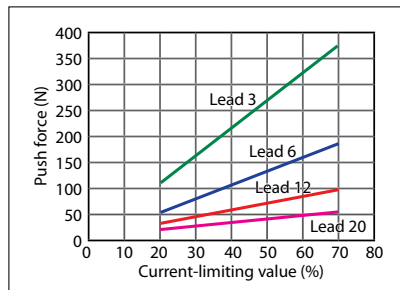

SA7C type

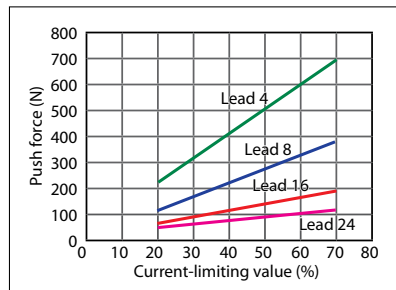

RA6C type

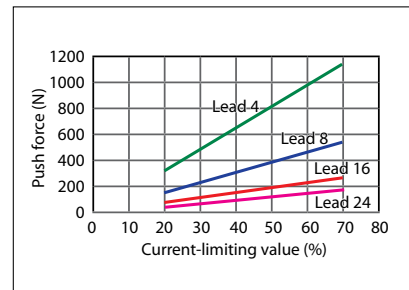

Notes on Use

- The relationship of push force and current-limiting value is only a reference, and the graphs may vary slightly from the actual values.
- If the current-limiting value is less than 20%, the push force may vary. Make sure the current-limiting value remains 20% or more.
- The graphs assume a traveling speed of 20 mm/s during push-motion operation.

Selection References (Guide for Selecting Allowable Load for Radial Cylinder)

The radial cylinder has a built-in guide, so loads up to a certain level can be applied to the rod without using an external guide. Refer to the graphs below for the allowable load mass. If the allowable load will be exceeded under the required operating conditions, add an external guide.

■ Allowable load mass for RCP4-RA5□/6□, horizontally mounted

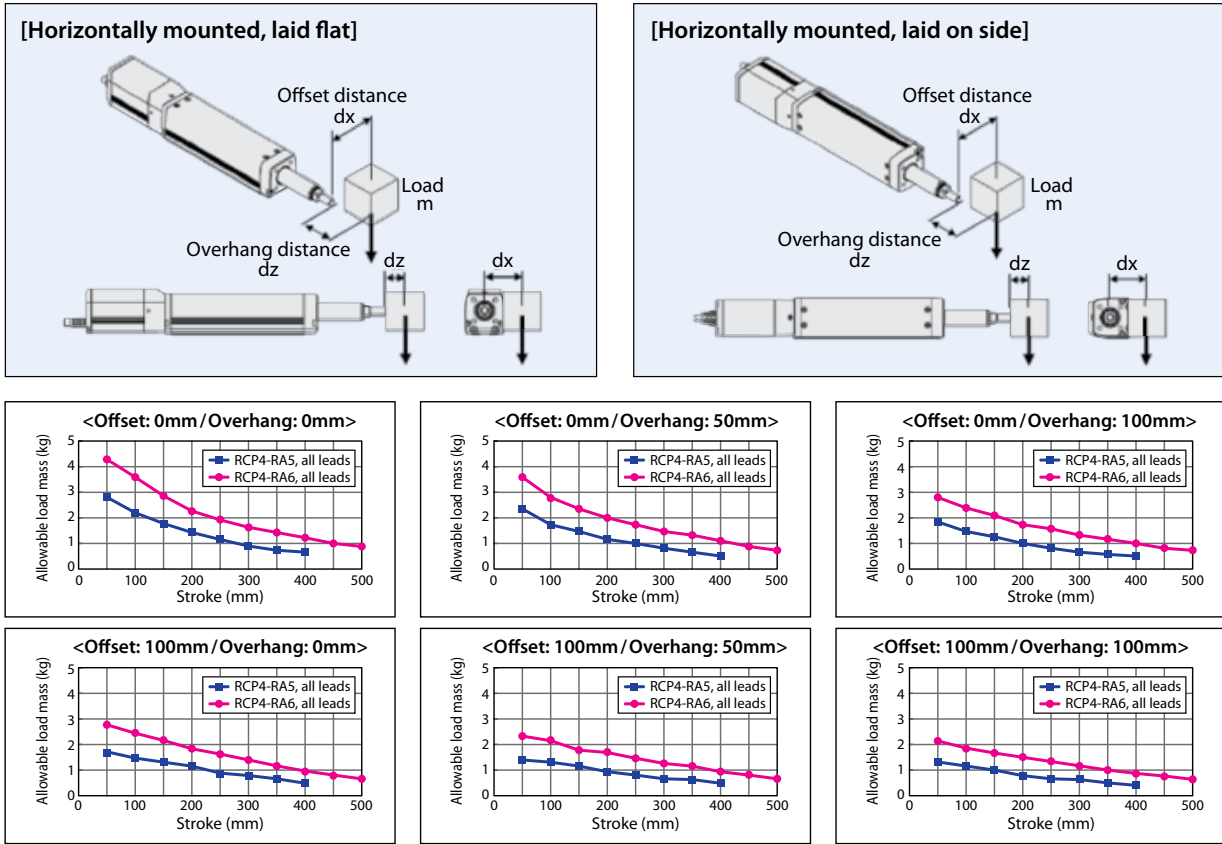

Allowable load calculation conditions
Load mass corresponding to a guide traveling life of 5,000 km, considering moments generated by acceleration/deceleration. (Acceleration: 1 G / Speed: 500 mm/s)

■ Allowable load mass for RCP4-RA5□/6□, vertically mounted

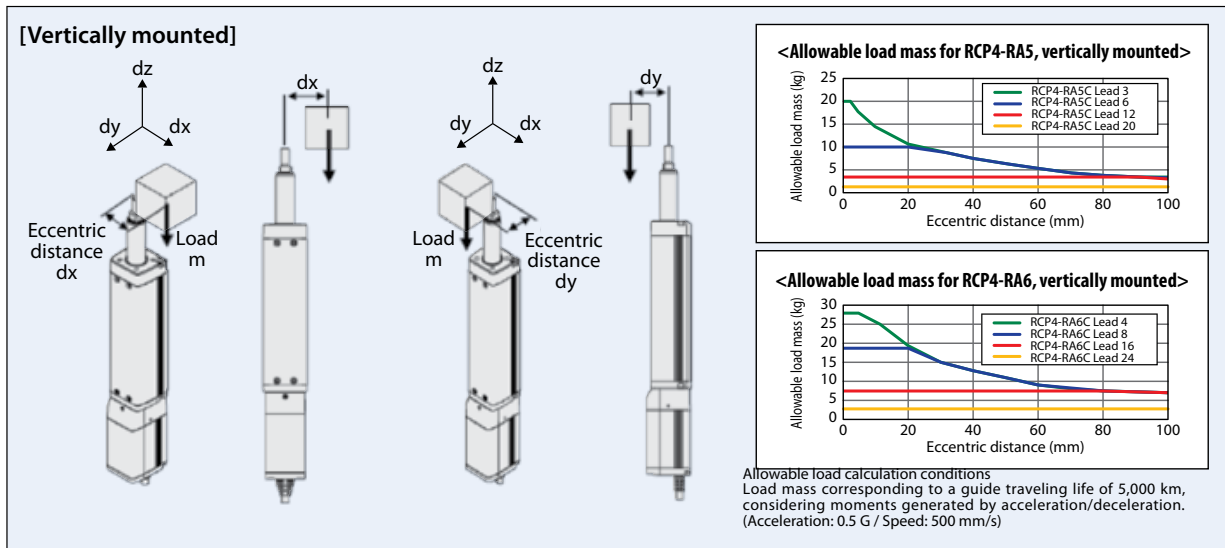

Selection Guideline (Table of RCP4 Payload by Speed/Acceleration)

The tables on P. 37 to P. 40 show payloads by acceleration and speed. Since the payload drops as the acceleration and speed increase, select from the tables and use a model that meets the required conditions. The applicable payload table varies depending on the actuator model and connected controller, so select and check the table for the model you will be using.



1 RCP4 motor coupling specification + PCON-CA *The same tables apply when the RCP4CR is used.

RCP4-SA5C, Lead 20

Orientation	Horizontal		Vertical					
	Acceleration (G)							
Speed (mm/s)	0.1	0.3	0.5	0.7	1	0.1	0.3	0.5
0	6.5	6.5	5	5	4	1	1	1
160	6.5	6.5	5	5	4	1	1	1
320	6.5	6.5	5	5	4	1	1	1
480	6.5	6.5	5	5	4	1	1	1
640	6.5	6.5	5	5	4	1	1	1
800	6.5	6.5	5	4	3	1	1	1
960	6.5	6.5	5	3	2	1	1	1
1120	6	3	2	1.5		0.5	0.5	
1280	1	1	1					0.5
1440								

(Unit: kg)

RCP4-SA5C, Lead 12

Orientation	Horizontal		Vertical					
	Acceleration (G)							
Speed (mm/s)	0.1	0.3	0.5	0.7	1	0.1	0.3	0.5
0	9	9	9	9	8	2.5	2.5	2.5
100	9	9	9	9	8	2.5	2.5	2.5
200	9	9	9	9	8	2.5	2.5	2.5
300	9	9	9	9	8	2.5	2.5	2.5
400	9	9	9	9	8	2.5	2.5	2.5
500	9	9	9	8	6.5	2.5	2.5	2.5
600	9	9	9	6	4	2.5	2.5	2.5
700	9	9	8	4	2.5	2.5	2.5	2
800	7	5	2	1		1.5	1	
900	5	3	1	1		0.5	0.5	

(Unit: kg)

RCP4-SA5C, Lead 6

Orientation	Horizontal		Vertical					
	Acceleration (G)							
Speed (mm/s)	0.1	0.3	0.5	0.7	1	0.1	0.3	0.5
0	18	18	14	14	12	6	6	6
50	18	18	14	14	12	6	6	6
100	18	18	14	14	12	6	6	6
150	18	18	14	14	12	6	6	6
200	18	18	14	14	12	6	6	6
250	18	18	14	14	12	6	6	5.5
300	18	18	14	14	10	6	5.5	5
350	18	18	12	11	8	6	4.5	4
400	18	14	10	7	6	4.5	3.5	3
450	16	10	6	4	2	3.5	2	2

(Unit: kg)

RCP4-SA5C, Lead 3

Orientation	Horizontal		Vertical					
	Acceleration (G)							
Speed (mm/s)	0.1	0.3	0.5	0.7	1	0.1	0.3	0.5
0	20	20	18	18	14	12	12	12
25	20	20	18	18	14	12	12	12
50	20	20	18	18	14	12	12	12
75	20	20	18	18	14	12	12	12
100	20	18	18	16	12	12	12	12
125	20	18	18	16	12	12	12	12
150	20	18	18	16	12	12	12	11
175	20	18	14	10	6	11	9	8
200	20	18	8			9	7	6
225	20	6				6	5	

(Unit: kg)

RCP4-SA6C, Lead 20

Orientation	Horizontal		Vertical					
	Acceleration (G)							
Speed (mm/s)	0.1	0.3	0.5	0.7	1	0.1	0.3	0.5
0	10	10	9	7	6	1	1	1
160	10	10	9	7	6	1	1	1
320	10	10	9	7	6	1	1	1
480	10	10	9	7	6	1	1	1
640	10	10	8	6	5	1	1	1
800	10	9	6.5	4.5	3	1	1	1
960	8	5	3.5	2		1	1	
1120	6.5	3	2	1.5		0.5	0.5	
1280	1	1	1					0.5
1440			1	0.5				

(Unit: kg)

RCP4-SA6C, Lead 12

Orientation	Horizontal		Vertical					
	Acceleration (G)							
Speed (mm/s)	0.1	0.3	0.5	0.7	1	0.1	0.3	0.5
0	15	15	12.5	11	10	2.5	2.5	2.5
100	15	15	12.5	11	10	2.5	2.5	2.5
200	15	15	12.5	11	10	2.5	2.5	2.5
300	15	15	12.5	11	10	2.5	2.5	2.5
400	15	14	11	10	8.5	2.5	2.5	2.5
500	15	13	10	8	6.5	2.5	2.5	2.5
600	15	12	9	6	4	2.5	2.5	2.5
700	12	10	8	4	2.5	2.5	2.5	2
800	10	7	5	2	1	2	1.5	1
900	5	3	1	1		0.5	0.5	

(Unit: kg)

RCP4-SA6C, Lead 6

Orientation	Horizontal		Vertical					
	Acceleration (G)							
Speed (mm/s)	0.1	0.3	0.5	0.7	1	0.1	0.3	0.5
0	25	25	20	16	14	6	6	6
50	25	25	20	16	14	6	6	6
100	25	25	20	16	14	6	6	6
150	25	25	20	16	14	6	6	6
200	25	25	20	16	14	6	6	6
250	25	25	20	16	14	6	6	5.5
300	25	25	20	15	11	6	5.5	5
350	25	20	14	12	9	6	4.5	4
400	25	16	10	8	6.5	4.5	3.5	3
450	18	12	6	5	2.5	3.5	2	2

(Unit: kg)

RCP4-SA6C, Lead 3

Orientation	Horizontal		Vertical					
	Acceleration (G)							
Speed (mm/s)	0.1	0.3	0.5	0.7	1	0.1	0.3	0.5
0	25	25	25	25	25	12	12	12
25	25	25	25	25	25	12	12	12
50	25	25	25	25	25	12	12	12
75	25	25	25	25	25	12	12	12
100	25	25	25	25	25	12	12	12
125	25	25	25	25	25	12	12	12
150	25	25	25	25	22.5	12	11	10
175	25	25	25	20	19	11	9	8
200	25	25	20	18	16	9	7	6
225	25	18	16	15	12	6	5	

(Unit: kg)

RCP4-SA7C, Lead 24

Orientation	Horizontal		Vertical					
	Acceleration (G)							
Speed (mm/s)	0.1	0.3	0.5	0.7	1	0.1	0.3	0.5
0	20	20	18	16	14	3	3	3
200	20	20	18	16	14	3	3	3
400	20	20	18	16	14	3	3	3
600	20	16	15	10	9	3	3	3
800	16	12	10	7	4	3	2.5	
1000	8	4.5	4	2		2	1.5	
1200	5.5	2	2	1		1	1	

(Unit: kg)

RCP4-SA7C, Lead 16

Orientation	Horizontal		Vertical					
	Acceleration (G)							
Speed (mm/s)	0.1	0.3	0.5	0.7	1	0.1	0.3	0.5
0	40	40	35	28	27	8	8	8
140	40	40	35	28	27	8	8	8
280	40	38	35	25	24	8	8	8
420	35	25	20	15	10	6	5	4.5
560	25	20	15	10	6	5	4	3
700	20	15	10	5	3	4	3	2
840	9	4	2	2		1		
980	4							

(Unit: kg)

RCP4-SA7C, Lead 8

Orientation	Horizontal		Vertical					
	Acceleration (G)							
Speed (mm/s)	0.1	0.3	0.5	0.7	1	0.1	0.3	0.5
0	45	45	45	40	40	16	16	16
70	45	45	45	40	40	16	16	16
140	45	45	40	38	35	16	16	16
210	45	40	35	30	24	11	10	9.5
280	40	30	25	20	15	9	8	7
350	35	20	9	4		7	5	4
420	25	7				5	2	
490	15					2		

(Unit: kg)

RCP4-SA7C, Lead 4

Orientation	Horizontal		Vertical					
	Acceleration (G)							
Speed (mm/s)	0.1	0.3	0.5	0.7	1	0.1	0.3	0.5
0	45	45	45	40	40	25	25	25
35	45	45	45	40	40	25	25	25
70	45	45	45	40	40	25	25	25
105	45	45	45	40	35	22	20	19
140	45	45	35	30	25	16	14	12
175	45	30	18			11	9	7.5
210	40	8				8		
245	35							

(Unit: kg)

RCP4-RA5C, Lead 20

Orientation	Horizontal		Vertical					
	Acceleration (G)							
Speed (mm/s)	0.1	0.3	0.5	0.7	1	0.1	0.3	0.5
0	6	6	6	5	5	1.5	1.5	1.5
160	6	6	6	5	5	1.5	1.5	1.5
320	6	6	6	5	3	1.5	1.5	1.5
480	6	6	6	5	3	1.5	1.5	1.5
640	6	4	3	2		1.5	1.5	
800	4	3				1	1	

(Unit: kg)

RCP4-RA5C, Lead 12

Orientation	Horizontal		Vertical					
	Acceleration (G)							
Speed (mm/s)	0.1	0.3	0.5	0.7	1	0.1	0.3	0.5
0	25	25	18	16	12	4	4	4
100	25	25	18	16	12	4	4	4
200	25	25	18	16	10	4	4	4
300	25	25	18	12	8	4	4	4
400	20	20	14	10	6	4	4	4
500	15	15	8	6	4	4	3.5	3
600	10	10	6	3	2	4	3	2
700	6	2		</				

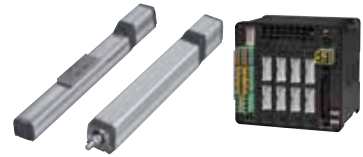

2 RCP4 motor coupled specification + MSEP-C *The same tables apply when the RCP4CR is used.

RCP4-SA5C, Lead 20

Orientation	Horizontal		Vertical			
	Acceleration (G)					
Speed (mm/s)	0.2	0.3	0.5	0.7	0.1	0.2
0	5	4	3	3	0.5	0.5
160	5	4	3	3	0.5	0.5
320	5	4	3	3	0.5	0.5
480	4.5	4	3	3	0.5	0.5
640	4	3.5	2	2	0.5	0.5
800	3	2.5	1	1	0.5	0.5
960	2	2	1	0.5		0.5

(Unit: kg)

RCP4-SA5C, Lead 12

Orientation	Horizontal		Vertical				
	Acceleration (G)						
Speed (mm/s)	0.2	0.3	0.5	0.7	0.1	0.2	0.3
0	8	6	5.5	5	2	2	2
100	8	6	5.5	5	2	2	2
200	8	6	5.5	5	2	2	2
300	8	6	5.5	5	2	2	2
400	8	6	4	3.5	2	2	1.5
500	7	5	2	1.5	1.5	1.5	1
600	5	4	2	1.5	1	1	0.5

(Unit: kg)

RCP4-SA5C, Lead 6

Orientation	Horizontal		Vertical				
	Acceleration (G)						
Speed (mm/s)	0.2	0.3	0.5	0.7	0.1	0.2	0.3
0	13	13	13	12	5	5	5
50	13	13	13	12	5	5	5
100	13	13	13	12	5	5	5
150	13	13	13	12	5	5	5
200	13	13	13	12	5	4.5	4
250	13	10	8	7	4	4	3
300	13	9	5	4	3	2.5	2

(Unit: kg)

RCP4-SA5C, Lead 3

Orientation	Horizontal		Vertical				
	Acceleration (G)						
Speed (mm/s)	0.2	0.3	0.5	0.7	0.1	0.2	0.3
0	16	16	16	16	10	10	10
25	16	16	16	16	10	10	10
50	16	16	16	16	10	10	10
75	16	16	16	14	10	10	10
100	16	16	14	12	10	9	8
125	16	13	11	10	7	6	6
150	16	10	9	8	5	4.5	3

(Unit: kg)

RCP4-SA6C, Lead 20

Orientation	Horizontal		Vertical			
	Acceleration (G)					
Speed (mm/s)	0.2	0.3	0.5	0.7	0.1	0.2
0	6	6	4	4	0.5	0.5
160	6	6	4	4	0.5	0.5
320	6	6	4	4	0.5	0.5
480	5	5	3	3	0.5	0.5
640	4	4	2	2	0.5	0.5
800	3	3	1	1	0.5	0.5
960	2	2	1	0.5		0.5

(Unit: kg)

RCP4-SA6C, Lead 12

Orientation	Horizontal		Vertical				
	Acceleration (G)						
Speed (mm/s)	0.2	0.3	0.5	0.7	0.1	0.2	0.3
0	8.5	8.5	7	6	2	2	2
100	8.5	8.5	7	6	2	2	2
200	8.5	8.5	7	6	2	2	2
300	8.5	8.5	7	6	2	2	2
400	8	7	4	3.5	2	2	1.5
500	7	6	3	2	1.5	1.5	1
600	6	6	2	1.5	1	1	0.5

(Unit: kg)

RCP4-SA6C, Lead 6

Orientation	Horizontal		Vertical				
	Acceleration (G)						
Speed (mm/s)	0.2	0.3	0.5	0.7	0.1	0.2	0.3
0	16	15	13	12	5	5	5
50	16	15	13	12	5	5	5
100	16	15	13	12	5	5	5
150	16	15	13	12	5	5	5
200	16	15	13	12	5	4.5	4
250	15	12	10	7	4	4	3
300	13	12	6	4	3	2.5	2

(Unit: kg)

RCP4-SA6C, Lead 3

Orientation	Horizontal		Vertical				
	Acceleration (G)						
Speed (mm/s)	0.2	0.3	0.5	0.7	0.1	0.2	0.3
0	19	19	19	19	10	10	10
25	19	19	19	19	10	10	10
50	19	19	19	19	10	10	10
75	19	19	19	19	10	10	10
100	19	16	14	12	10	9	8
125	18	14	11	10	7	6	6
150	16	13	10	9	5	4.5	3

(Unit: kg)

RCP4-SA7C, Lead 24

Orientation	Horizontal		Vertical			
	Acceleration (G)					
Speed (mm/s)	0.2	0.3	0.5	0.7	0.1	0.2
0	18					2
200	18					2
400	18					2
600	10					1.5
800	5					1
1000	1.5					

(Unit: kg)

RCP4-SA7C, Lead 16

Orientation	Horizontal		Vertical				
	Acceleration (G)						
Speed (mm/s)	0.2	0.3	0.5	0.7	0.1	0.2	0.3
0	35					5	
140	35					5	
280	25					3	
420	15					1.5	
560	7					0.5	

(Unit: kg)

RCP4-SA7C, Lead 8

Orientation	Horizontal		Vertical				
	Acceleration (G)						
Speed (mm/s)	0.2	0.3	0.5	0.7	0.1	0.2	0.3
0	40					10	
70	40					10	
140	40					7	
210	25					4	
280	10					1.5	

(Unit: kg)

RCP4-SA7C, Lead 4

Orientation	Horizontal		Vertical				
	Acceleration (G)						
Speed (mm/s)	0.2	0.3	0.5	0.7	0.1	0.2	0.3
0	40					15	
35	40					15	
70	40					15	
105	40					10	
140	40					5	

(Unit: kg)

RCP4-RA5C, Lead 20

Orientation	Horizontal		Vertical			
	Acceleration (G)					
Speed (mm/s)	0.2	0.3	0.5	0.7	0.1	0.2
0	6					1.5
160	6					1.5
320	6					1.5
480	4					1
640	3					0.5

(Unit: kg)

RCP4-RA5C, Lead 12

Orientation	Horizontal		Vertical				
	Acceleration (G)						
Speed (mm/s)	0.2	0.3	0.5	0.7	0.1	0.2	0.3
0	25					4	
100	25					4	
200	25					4	
300	20					3	
400	10					2	
500	5					1	

(Unit: kg)

RCP4-RA5C, Lead 6

Orientation	Horizontal		Vertical				
	Acceleration (G)						
Speed (mm/s)	0.2	0.3	0.5	0.7	0.1	0.2	0.3
0	40					10	
50	40					10	
100	40					10	
150	40					8	
200	35					5	
250	10					3	

(Unit: kg)

RCP4-RA5C, Lead 3

Orientation	Horizontal		Vertical				
	Acceleration (G)						
Speed (mm/s)	0.2	0.3	0.5	0.7	0.1	0.2	0.3
0	40					20	
25	40					20	
50	40					16	
75	40					12	
100	40					9	
125	40					5	

(Unit: kg)

RCP4-RA6C, Lead 24

Orientation	Horizontal		Vertical			
	Acceleration (G)					
Speed (mm/s)	0.2	0.3	0.5	0.7	0.1	0.2
0	18					3
200	18					3
400	10					2
600	1					

(Unit: kg)

RCP4-RA6C, Lead 16

Orientation	Horizontal		Vertical				
	Acceleration (G)						
Speed (mm/s)	0.2	0.3	0.5	0.7	0.1	0.2	0.3
0	40					5	
140	40					5	
280	30					3	
420	15					1	

(Unit: kg)

RCP4-RA6C, Lead 8

Orientation	Horizontal		Vertical				
	Acceleration (G)						
Speed (mm/s)	0.2	0.3	0.5	0.7	0.1	0.2	0.3
0	50					17.5	
70	50					17.5	
140	50					7	
210	30					2	

(Unit: kg)

RCP4-RA6C, Lead 4

Orientation	Horizontal		Vertical	
-------------	------------	--	----------	--

Selection Guideline (Table of RCP4 Payload by Speed/Acceleration)

3 RCP4 side-mounted motor specification + PCON-CA



RCP4-SA5R, Lead 20

Orientation	Horizontal			Vertical				
	Acceleration (G)							
Speed (mm/s)	0.1	0.3	0.5	0.7	1	0.1	0.3	0.5
0	6.5	6.5	5	5	4	1	1	1
160	6.5	6.5	5	5	4	1	1	1
320	6.5	6.5	5	5	4	1	1	1
480	6.5	6.5	5	5	4	1	1	1
640	6.5	6.5	5	5	4	1	1	1
800	6.5	6.5	5	4	3	1	1	1
960		6.5	5	3	2			1
1120		6	3	2	1.5			0.5
1280			1	1	1			
1440				1	0.5			

(Unit: kg)

RCP4-SA5R, Lead 12

Orientation	Horizontal			Vertical				
	Acceleration (G)							
Speed (mm/s)	0.1	0.3	0.5	0.7	1	0.1	0.3	0.5
0	9	9	9	9	8	2.5	2.5	2.5
100	9	9	9	9	8	2.5	2.5	2.5
200	9	9	9	9	8	2.5	2.5	2.5
300	9	9	9	9	8	2.5	2.5	2.5
400	9	9	9	9	8	2.5	2.5	2.5
500	9	9	9	8	6.5	2.5	2.5	2.5
600	9	9	9	6	4	2.5	2.5	2.5
700	9	9	8	4	2.5	2.5	2	1.5
800		7	5	2	1			1
900		5	3	1	1			

(Unit: kg)

RCP4-SA5R, Lead 6

Orientation	Horizontal			Vertical				
	Acceleration (G)							
Speed (mm/s)	0.1	0.3	0.5	0.7	1	0.1	0.3	0.5
0	18	18	14	14	12	6	6	6
50	18	18	14	14	12	6	6	6
100	18	18	14	14	12	6	6	6
150	18	18	14	14	12	6	6	6
200	18	18	14	14	12	6	6	6
250	18	18	14	14	12	6	6	5.5
300	18	18	14	14	10	6	5.5	5
350	18	18	12	11	8	5.5	4.5	4
400	18	14	10	7	6	4.5	3.5	3
450	16	10	6	4	2	2.5	2	1.5

(Unit: kg)

RCP4-SA5R, Lead 3

Orientation	Horizontal			Vertical				
	Acceleration (G)							
Speed (mm/s)	0.1	0.3	0.5	0.7	1	0.1	0.3	0.5
0	20	20	18	18	14	12	12	12
25	20	20	18	18	14	12	12	12
50	20	20	18	18	14	12	12	12
75	20	20	18	18	14	12	12	12
100	20	18	18	16	12	12	12	12
125	20	18	18	16	12	12	12	12
150	20	18	18	12	10	12	11	10
175	20	18	14	10	6	11	9	8
200	20	18	8			9	7	6
225	20	6				5	3	

(Unit: kg)

RCP4-SA6R, Lead 20

Orientation	Horizontal			Vertical				
	Acceleration (G)							
Speed (mm/s)	0.1	0.3	0.5	0.7	1	0.1	0.3	0.5
0	10	10	9	7	6	1	1	1
160	10	10	9	7	6	1	1	1
320	10	10	9	7	6	1	1	1
480	10	10	9	7	6	1	1	1
640	10	10	8	6	5	1	1	1
800	10	9	6.5	4.5	3	1	1	1
960		8	5	3.5	2			1
1120		6	3	2	1.5			0.5
1280			1	0.5	0.5			

(Unit: kg)

RCP4-SA6R, Lead 12

Orientation	Horizontal			Vertical				
	Acceleration (G)							
Speed (mm/s)	0.1	0.3	0.5	0.7	1	0.1	0.3	0.5
0	15	15	12.5	11	10	2.5	2.5	2.5
100	15	15	12.5	11	10	2.5	2.5	2.5
200	15	15	12.5	11	10	2.5	2.5	2.5
300	15	15	12.5	11	10	2.5	2.5	2.5
400	15	14	11	10	8.5	2.5	2.5	2.5
500	15	13	10	8	6.5	2.5	2.5	2.5
600	15	12	9	6	4	2.5	2.5	2.5
700	12	10	8	4	2.5	2	1.5	
800	10	7	5	2	1	2	1	0.5
900		4	2	1				

(Unit: kg)

RCP4-SA6R, Lead 6

Orientation	Horizontal			Vertical				
	Acceleration (G)							
Speed (mm/s)	0.1	0.3	0.5	0.7	1	0.1	0.3	0.5
0	25	25	20	16	14	6	6	6
50	25	25	20	16	14	6	6	6
100	25	25	20	16	14	6	6	6
150	25	25	20	16	14	6	6	6
200	25	25	20	16	14	6	6	6
250	25	25	20	16	14	6	6	5.5
300	25	25	20	15	11	6	5.5	5
350	25	20	14	12	9	5.5	4.5	4
400	25	16	10	8	6.5	4.5	3.5	3
450	18	12	6	5	2.5	2.5	2	1.5

(Unit: kg)

RCP4-SA6R, Lead 3

Orientation	Horizontal			Vertical				
	Acceleration (G)							
Speed (mm/s)	0.1	0.3	0.5	0.7	1	0.1	0.3	0.5
0	25	25	25	25	25	12	12	12
25	25	25	25	25	25	12	12	12
50	25	25	25	25	25	12	12	12
75	25	25	25	25	25	12	12	12
100	25	25	25	25	25	12	12	12
125	25	25	25	25	25	12	12	12
150	25	25	25	25	22.5	12	11	10
175	25	25	25	20	19	11	9	8
200	25	25	20	18	12	9	7	6
225	25	18	12	6	4	5	3	

(Unit: kg)

RCP4-SA7R, Lead 24

Orientation	Horizontal			Vertical				
	Acceleration (G)							
Speed (mm/s)	0.1	0.3	0.5	0.7	1	0.1	0.3	0.5
0	20	20	18	16	14	3	3	3
200	20	20	18	16	14	3	3	3
400	20	20	18	16	14	3	3	3
600	20	16	15	10	9	3	3	3
800	16	12	10	6	4			3
1000		8	4.5	2	1			1

(Unit: kg)

RCP4-SA7R, Lead 16

Orientation	Horizontal			Vertical				
	Acceleration (G)							
Speed (mm/s)	0.1	0.3	0.5	0.7	1	0.1	0.3	0.5
0	40	40	35	28	27	8	8	8
140	40	40	35	28	27	8	8	8
280	40	38	35	25	24	8	8	8
420	35	25	20	15	10	6	5	4.5
560	25	20	15	10	6	5	4	3
700	20	15	8	5	3	3	2	1.5
840		6	2					

(Unit: kg)

RCP4-SA7R, Lead 8

Orientation	Horizontal			Vertical				
	Acceleration (G)							
Speed (mm/s)	0.1	0.3	0.5	0.7	1	0.1	0.3	0.5
0	45	45	45	40	40	16	16	16
70	45	45	45	40	40	16	16	16
140	45	45	40	38	35	16	16	16
210	45	40	35	30	24	11	10	9.5
280	40	30	25	20	15	9	8	7
350	35	20	9	4		7	5	4
420	25	7				5	1	
490	13					1		

(Unit: kg)

RCP4-SA7R, Lead 4

Orientation	Horizontal			Vertical				
	Acceleration (G)							
Speed (mm/s)	0.1	0.3	0.5	0.7	1	0.1	0.3	0.5
0	45	45	45	40	40	25	25	25
35	45	45	45	40	40	25	25	25
70	45	45	45	40	40	25	25	25
105	45	45	45	40	35	22	20	19
140	45	45	35	30	25	16	14	12
175	45	30	16			11	7	5
210	40					4		

(Unit: kg)

RCP4-RA5R, Lead 20

Orientation	Horizontal			Vertical				
	Acceleration (G)							
Speed (mm/s)	0.1	0.3	0.5	0.7	1	0.1	0.3	0.5
0	6	6	6	5	5	1.5	1.5	1.5
160	6	6	6	5	5	1.5	1.5	1.5
320	6	6	6	5	3	1.5	1.5	1.5
480	6	6	6	5	3	1.5	1.5	1.5
640		6	4	3	2			1.5
800		4	3					1

(Unit: kg)

RCP4-RA5R, Lead 12

Orientation	Horizontal			Vertical				
	Acceleration (G)							
Speed (mm/s)	0.1	0.3	0.5	0.7	1	0.1	0.3	0.5
0	25							

4 RCP4 side-mounted motor specification + MSEP-C



RCP4-SA5R, Lead 20

Orientation	Horizontal		Vertical			
	Acceleration (G)					
Speed (mm/s)	0.2	0.3	0.5	0.7	0.1	0.2
0	5	4	3	3	0.5	0.5
160	5	4	3	3	0.5	0.5
320	5	4	3	3	0.5	0.5
480	4.5	4	3	3	0.5	0.5
640	4	3.5	2	2	0.5	0.5
800	3	2.5	1	1	0.5	0.5
960	2	2	1	0.5		

(Unit: kg)

RCP4-SA5R, Lead 12

Orientation	Horizontal		Vertical				
	Acceleration (G)						
Speed (mm/s)	0.2	0.3	0.5	0.7	0.1	0.2	0.3
0	8	6	5.5	5	2	2	2
100	8	6	5.5	5	2	2	2
200	8	6	5.5	5	2	2	2
300	8	6	5.5	5	2	2	2
400	8	6	4	3.5	2	2	1.5
500	7	5	2	1.5	1.5	1	
600	5	4	2	1.5	1	0.5	0.5

(Unit: kg)

RCP4-SA5R, Lead 6

Orientation	Horizontal		Vertical				
	Acceleration (G)						
Speed (mm/s)	0.2	0.3	0.5	0.7	0.1	0.2	0.3
0	13	13	13	12	5	5	5
50	13	13	13	12	5	5	5
100	13	13	13	12	5	5	5
150	13	13	13	12	5	5	5
200	13	13	13	12	5	4.5	4
250	13	10	8	7	4	4	3
300	13	9	5	4	2.5	2	1.5

(Unit: kg)

RCP4-SA5R, Lead 3

Orientation	Horizontal		Vertical				
	Acceleration (G)						
Speed (mm/s)	0.2	0.3	0.5	0.7	0.1	0.2	0.3
0	16	16	16	16	10	10	10
25	16	16	16	16	10	10	10
50	16	16	16	16	10	10	10
75	16	16	16	14	10	10	10
100	16	16	14	12	10	9	8
125	16	13	11	10	7	6	6
150	16	10	9	8	5	4.5	3

(Unit: kg)

RCP4-SA6R, Lead 20

Orientation	Horizontal		Vertical			
	Acceleration (G)					
Speed (mm/s)	0.2	0.3	0.5	0.7	0.1	0.2
0	6	6	4	4	0.5	0.5
160	6	6	4	4	0.5	0.5
320	6	6	4	4	0.5	0.5
480	5	5	3	3	0.5	0.5
640	4	4	2	2	0.5	0.5
800	3	3	1	1	0.5	0.5
960	2	1.5	0.5			

(Unit: kg)

RCP4-SA6R, Lead 12

Orientation	Horizontal		Vertical				
	Acceleration (G)						
Speed (mm/s)	0.2	0.3	0.5	0.7	0.1	0.2	0.3
0	8.5	8.5	7	6	2	2	2
100	8.5	8.5	7	6	2	2	2
200	8.5	8.5	7	6	2	2	2
300	8.5	8.5	7	6	2	2	2
400	8	7	4	3.5	2	2	1.5
500	7	6	3	2	1.5	1.5	1
600	6	6	2	1.5	1	0.5	0.5

(Unit: kg)

RCP4-SA6R, Lead 6

Orientation	Horizontal		Vertical				
	Acceleration (G)						
Speed (mm/s)	0.2	0.3	0.5	0.7	0.1	0.2	0.3
0	16	15	13	12	5	5	5
50	16	15	13	12	5	5	5
100	16	15	13	12	5	5	5
150	16	15	13	12	5	5	5
200	16	15	13	12	5	4.5	4
250	15	12	10	7	4	4	3
300	13	12	6	4	2.5	2	1.5

(Unit: kg)

RCP4-SA6R, Lead 3

Orientation	Horizontal		Vertical				
	Acceleration (G)						
Speed (mm/s)	0.2	0.3	0.5	0.7	0.1	0.2	0.3
0	19	19	19	19	10	10	10
25	19	19	19	19	10	10	10
50	19	19	19	19	10	10	10
75	19	19	19	19	10	10	10
100	19	16	14	12	10	9	8
125	18	14	11	10	7	6	6
150	16	13	10	9	5	4.5	3

(Unit: kg)

RCP4-SA7R, Lead 24

Orientation	Horizontal		Vertical			
	Acceleration (G)					
Speed (mm/s)	0.2	0.3	0.5	0.7	0.1	0.2
0	18					2
200	18					2
400	18					2
600	9					1.5
800	1					

(Unit: kg)

RCP4-SA7R, Lead 16

Orientation	Horizontal		Vertical				
	Acceleration (G)						
Speed (mm/s)	0.2	0.3	0.5	0.7	0.1	0.2	0.3
0	35					5	
140	35					5	
280	25					3	
420	15					1.5	
560	4					0.5	

(Unit: kg)

RCP4-SA7R, Lead 8

Orientation	Horizontal		Vertical				
	Acceleration (G)						
Speed (mm/s)	0.2	0.3	0.5	0.7	0.1	0.2	0.3
0	40					10	
70	40					10	
140	40					7	
210	25					4	
280	6					1	

(Unit: kg)

RCP4-SA7R, Lead 4

Orientation	Horizontal		Vertical				
	Acceleration (G)						
Speed (mm/s)	0.2	0.3	0.5	0.7	0.1	0.2	0.3
0	40					15	
35	40					15	
70	40					15	
105	40					10	
140	22					3	

(Unit: kg)

RCP4-RA5R, Lead 20

Orientation	Horizontal		Vertical			
	Acceleration (G)					
Speed (mm/s)	0.2	0.3	0.5	0.7	0.1	0.2
0	6					1.5
160	6					1.5
320	6					1.5
480	4					1
640	3					0.5

(Unit: kg)

RCP4-RA5R, Lead 12

Orientation	Horizontal		Vertical				
	Acceleration (G)						
Speed (mm/s)	0.2	0.3	0.5	0.7	0.1	0.2	0.3
0	25					4	
100	25					4	
200	25					4	
300	20					3	
400	10					2	
500	5					1	

(Unit: kg)

RCP4-RA5R, Lead 6

Orientation	Horizontal		Vertical				
	Acceleration (G)						
Speed (mm/s)	0.2	0.3	0.5	0.7	0.1	0.2	0.3
0	40					10	
50	40					10	
100	40					10	
150	40					8	
200	35					5	
250	10					3	

(Unit: kg)

RCP4-RA5R, Lead 3

Orientation	Horizontal		Vertical				
	Acceleration (G)						
Speed (mm/s)	0.2	0.3	0.5	0.7	0.1	0.2	0.3
0	40					20	
25	40					20	
50	40					16	
75	40					12	
100	40					9	
125	40					5	

(Unit: kg)

RCP4-RA6R, Lead 24

Orientation	Horizontal		Vertical			
	Acceleration (G)					
Speed (mm/s)	0.2	0.3	0.5	0.7	0.1	0.2
0	18					3
200	18					3
400	10					2
600	1					

(Unit: kg)

RCP4-RA6R, Lead 16

Orientation	Horizontal		Vertical				
	Acceleration (G)						
Speed (mm/s)	0.2	0.3	0.5	0.7	0.1	0.2	0.3
0	40					5	
140	40					5	
280	30					3	
420	6					0.5	

(Unit: kg)

RCP4-RA6R, Lead 8

Orientation	Horizontal		Vertical				
	Acceleration (G)						
Speed (mm/s)	0.2	0.3	0.5	0.7	0.1	0.2	0.3
0	50					17.5	
70	50					17.5	
140	50					7	
210	30					2	

(Unit: kg)

RCP4-RA6R, Lead 4

Orientation	Horizontal		Vertical			
	Acceleration (G)					
Speed (mm/s)	0.2	0.3	0.5	0.7	0.1	0



1 Built-in high-output driver designed exclusively for RCP4 generates greater torque at high speed

The newly developed high-output driver (patent pending) achieves significantly improved specifications compared to conventional models (RCP2 series), with the acceleration/deceleration higher by 1.4 times, maximum speed by 1.5 times, and payload twice as large.
 (*) The rates of improvement vary depending on the type.

Acceleration/deceleration	RCP2 0.7G	RCP4 1.0G	1.4 times
Maximum speed	RCP2 1000mm/s	RCP4 1440mm/s	1.5 times
Payload	RCP2 6kg	RCP4 12kg	2 times

2 DeviceNet, CC-Link, PROFIBUS-DP, CompoNet, MECHATROLINK (I, II), EtherCAT, EtherNet/IP are supported

Features include wire-saving design, as well as the abilities to support direct numerical specification, position number specification, current position read, etc.

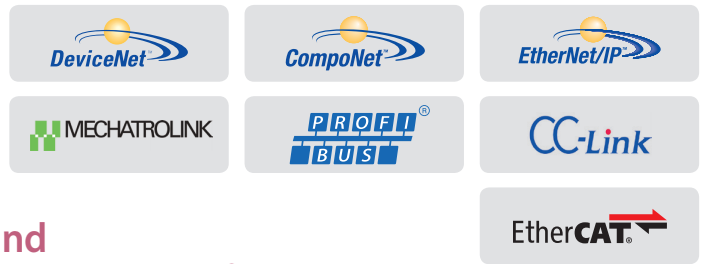

3 Incremental specification and simple absolute specification to choose from

You can choose one of the two types: the incremental specification and the simple absolute specification. The simple absolute specification is available in three types, including the specification having only the absolute battery attached on the side face of the actuator, specification equipped with the absolute battery unit where screw stopper/DIN rail mounting is possible, and controller-only specification without absolute battery.

(Note) All pulse-train Power CON controllers are of the incremental specification.

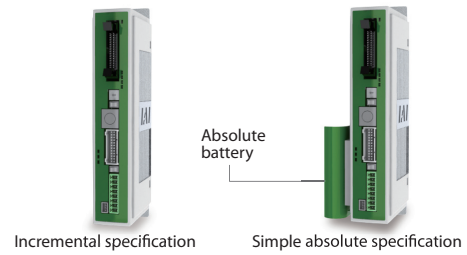

4 Smart tuning function, maintenance information, calendar function

The takt time minimization function sets an optimal acceleration/deceleration rate according to the load that is available (*). You can also record the number of times the actuator has moved and the distance that it has travelled, for use in maintenance.

(*) You need PC software Ver. 8.03.00.00 or later or a CON-PTA (teaching pendant) to use the takt time minimization function.

Maintenance information(Axis No.0)

Total moving count: 123 <<< Send

Total moving count threshold: 0

Cycle time optimization









Model	Lead (mm)	Stroke (mm)	Direction	Load (kg)	Load Setting
RCP4-SAGC	0	250	None	Setting	Anticutter
Position	[mm/s]	[mm/s]	[mm/s]	[mm/s]	[mm/s]
1	0.00	420.00	0.30	0.00	0.10
2	250.00	420.00	0.30	0.00	0.10

Message Log

Message	Time
FFB PowerOff No Stop	11/11/18 18:18:16
HiZ Contact power voltage reduction	11/11/18 18:18:16
HiZ PowerOff No Stop	11/11/18 18:18:16
HiZ Contact power voltage reduction	11/11/18 18:18:16
HiZ PowerOff No Stop	11/11/18 18:18:16
HiZ Contact power voltage reduction	11/11/18 18:18:16
HiZ PowerOff No Stop	11/11/18 18:18:16

List of Models

ROBO Cylinder Position Controller PowerCON 150 <PCON-CA>

External view										
I/O type		Positioner type	Pulse-train type	Field network type						
										
I/O type model number		NP/PN	PLN/PLP	DV	CC	PR	CN	ML	EC	EP
Standard price	Incremental specification	-	-	-	-	-	-	-	-	-
	simple absolute specification	with absolute battery	-	-	-	-	-	-	-	-
		with absolute battery unit	-	-	-	-	-	-	-	-
	No absolute battery	-	-	-	-	-	-	-	-	

Model Number

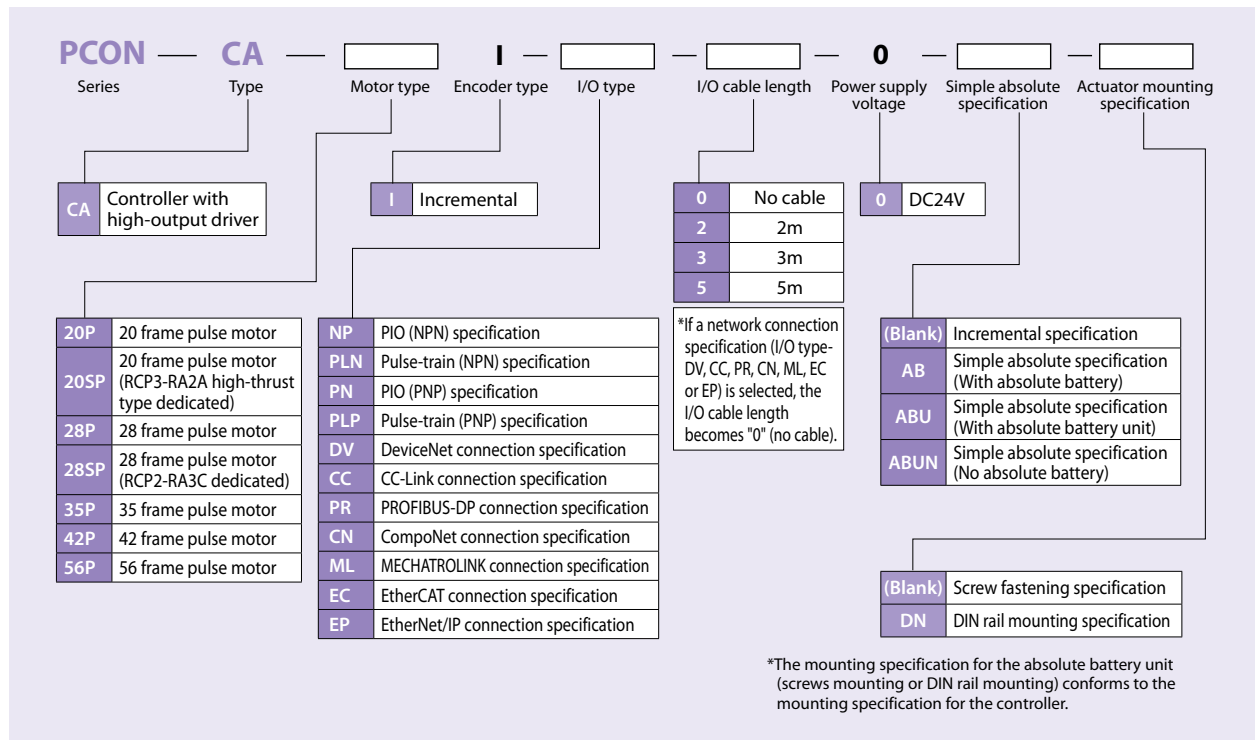

Note: The PCON-CA controller can achieve high-speed, high-payload operations only when combined with RCP4 actuators. RCP2/RCP3 actuators also work with the PCON-CA controller, but only according to their original actuator specifications.

PIO I/O Interface

Input Part External Input Specifications

Item	Specification
Input voltage	24 VDC \pm 10%
Input current	5mA, 1 circuit
ON/OFF voltage	ON voltage: 18 VDC min. OFF voltage: 6 VDC max.

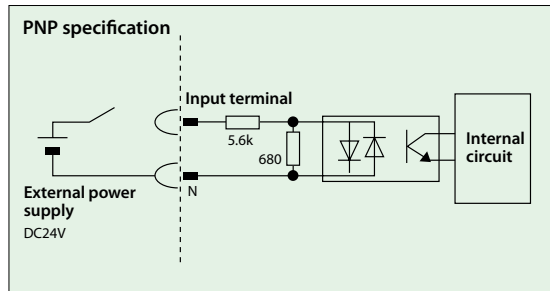
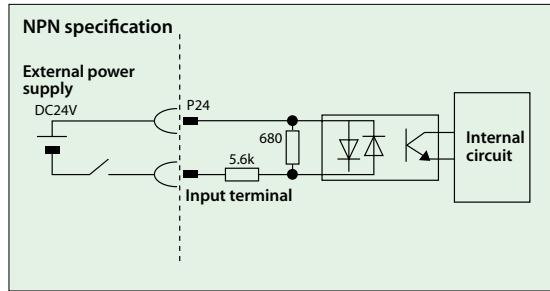

Output Part External Output Specifications

Item	Specification
Load voltage	24 VDC
Maximum load current	50mA, 1 circuit
Leak current	2mA max. per point

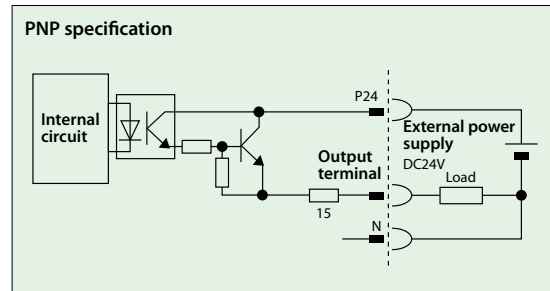
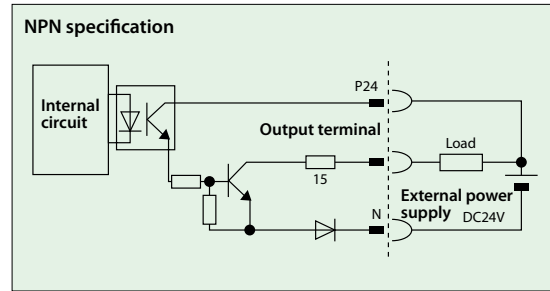

Types of PIO Patterns (Control Patterns)

This controller supports seven types of control methods. Select in Parameter No. 25, "PIO pattern selection" the PIO pattern that best suits your purpose of use.

Type	Set value of Parameter No. 25	Mode	Overview
PIO pattern 0	0 (factory setting)	Positioning mode (standard type)	<ul style="list-style-type: none"> Number of positioning points: 64 points Position number command: Binary Coded Decimal (BCD) Zone signal output^{*1}: 1 point Position zone signal output^{*2}: 1 point
PIO pattern 1	1	Teaching mode (teaching type)	<ul style="list-style-type: none"> Number of positioning points: 64 points Position number command: Binary Coded Decimal (BCD) Position zone signal output^{*2}: 1 point Jog (inching) operation using PIO signals is supported. Current position data can be written to the position table using PIO signals.
PIO pattern 2	2	256-point mode (256 positioning points)	<ul style="list-style-type: none"> Number of positioning points: 256 points Position number command: Binary Coded Decimal (BCD) Position zone signal output^{*2}: 1 point
PIO pattern 3	3	512-point mode (512 positioning points)	<ul style="list-style-type: none"> Number of positioning points: 512 points Position number command: Binary Coded Decimal (BCD) No zone signal output
PIO pattern 4	4	Solenoid valve mode 1 (7-point type)	<ul style="list-style-type: none"> Number of positioning points: 7 points Position number command: Individual number signal ON Zone signal output^{*1}: 1 point Position zone signal output^{*2}: 1 point
PIO pattern 5	5	Solenoid valve mode 2 (3-point type)	<ul style="list-style-type: none"> Number of positioning points: 3 points Position number command: Individual number signal ON Completion signal: A signal equivalent to a LS (limit switch) signal can be output. Zone signal output^{*1}: 1 point Position zone signal output^{*2}: 1 point
PIO pattern 6 (Note)	6	Pulse-train control mode	<ul style="list-style-type: none"> Differential pulse input (200 kpps max.) Home return function Zone signal output^{*1}: 2 points No feedback pulse output

*1 Zone signal output: A desired zone is set by Parameter Nos. 1 and 2 or 23 and 24, and the set zone always remains effective once home return has completed.

*2 Position zone signal output: This function is available as part of a position number. A desired zone is set in the position table and becomes effective only when the corresponding position is specified, but not with commands specifying other positions.

(Note) Pulse Train Control Model is available only if the pulse train control type is indicated (from PCON-CA⁻-PLN and PLP) at the time of purchase.

43

Sold & Serviced By:

ELECTROMATE

Toll Free Phone (877) SERV098

Toll Free Fax (877) SERV099

www.electromate.com

sales@electromate.com

PIO Patterns and Signal Assignments

The table below lists the signal assignments for the I/O flat cable under different PIO patterns. Connect an external device (such as a PLC) according to this table.

Pin number	Category	PIO function	Parameter No. 25, "PIO pattern selection"					
			0	1	2	3	4	5
			Positioning mode	Teaching mode	256-point mode	512-point mode	Solenoid valve mode 1	Solenoid valve mode 2
	Input	Number of positioning points	64 points	64 points	256 points	512 points	7 points	3 points
		Home return signal	○	○	○	○	○	×
		Jog signal	×	○	×	×	×	×
		Teaching signal (writing of current position)	×	○	×	×	×	×
	Output	Brake release	○	×	○	○	○	○
		Moving signal	○	○	×	×	×	×
		Zone signal	○	△ (Note 1)	△ (Note 1)	×	○	○
		Position zone signal	○	○	○	×	○	
1A	24V	P24						
2A	24V	P24						
3A	Pulse input	—						
4A		—						
5A	Input	IN0	PC1	PC1	PC1	PC1	ST0	ST0
6A		IN1	PC2	PC2	PC2	PC2	ST1	ST1(JOG+)
7A		IN2	PC4	PC4	PC4	PC4	ST2	ST2(-)
8A		IN3	PC8	PC8	PC8	PC8	ST3	—
9A		IN4	PC16	PC16	PC16	PC16	ST4	—
10A		IN5	PC32	PC32	PC32	PC32	ST5	—
11A		IN6	—	MODE	PC64	PC64	ST6	—
12A		IN7	—	JISL	PC128	PC128	—	—
13A		IN8	—	JOG+	—	PC256	—	—
14A		IN9	BKRL	JOG-	BKRL	BKRL	BKRL	BKRL
15A		IN10	RMOD	RMOD	RMOD	RMOD	RMOD	RMOD
16A		IN11	HOME	HOME	HOME	HOME	HOME	—
17A		IN12	*STP	*STP	*STP	*STP	*STP	—
18A		IN13	CSTR	CSTR/PWRT	CSTR	CSTR	—	—
19A		IN14	RES	RES	RES	RES	RES	RES
20A	IN15	SON	SON	SON	SON	SON	SON	
1B	Output	OUT0	PM1(ALM1)	PM1(ALM1)	PM1(ALM1)	PM1(ALM1)	PE0	LSO
2B		OUT1	PM2(ALM2)	PM2(ALM2)	PM2(ALM2)	PM2(ALM2)	PE1	LS1(TRQS)
3B		OUT2	PM4(ALM4)	PM4(ALM4)	PM4(ALM4)	PM4(ALM4)	PE2	LS2 (Note 2)
4B		OUT3	PM8(ALM8)	PM8(ALM8)	PM8(ALM8)	PM8(ALM8)	PE3	—
5B		OUT4	PM16	PM16	PM16	PM16	PE4	—
6B		OUT5	PM32	PM32	PM32	PM32	PE5	—
7B		OUT6	MOVE	MOVE	PM64	PM64	PE6	—
8B		OUT7	ZONE1	MODES	PM128	PM128	ZONE1	ZONE1
9B		OUT8	PZONE/ZONE2	PZONE/ZONE1	PZONE/ZONE1	PM256	PZONE/ZONE2	PZONE/ZONE2
10B		OUT9	RMDS	RMDS	RMDS	RMDS	RMDS	RMDS
11B		OUT10	HEND	HEND	HEND	HEND	HEND	HEND
12B		OUT11	PEND	PEND/WEND	PEND	PEND	PEND	—
13B		OUT12	SV	SV	SV	SV	SV	SV
14B		OUT13	*EMGS	*EMGS	*EMGS	*EMGS	*EMGS	*EMGS
15B		OUT14	*ALM	*ALM	*ALM	*ALM	*ALM	*ALM
16B	OUT15	LOAD/TRQS *ALML	*ALML	LOAD/TRQS *ALML	LOAD/TRQS *ALML	LOAD/TRQS *ALML	*ALML	
17B	Pulse input	—						
18B		—						
19B	0V	N						
20B	0V	N						

(Note) In the table above, asterisk * symbol accompanying each code indicates a negative logic signal. PM1 to PM8 are alarm binary code output signals that are used when an alarm generates.
 (Note 1) In all PIO patterns other than 3, this signal can be switched with PZONE by setting Parameter No. 149 accordingly.
 (Note 2) The setting will not become effective until the origin return is completed.

Reference) Negative logic signal

Signals denoted by * are negative logic signals. Negative logic input signals are processed when turned OFF. Negative logic output signals normally remain ON while the power is supplied, and turn OFF when the signal is output.

Note: The names of the signals above inside () are functions before the unit returns home.

Pulse-train Control Circuit

■ **Host Unit = Differential Type**

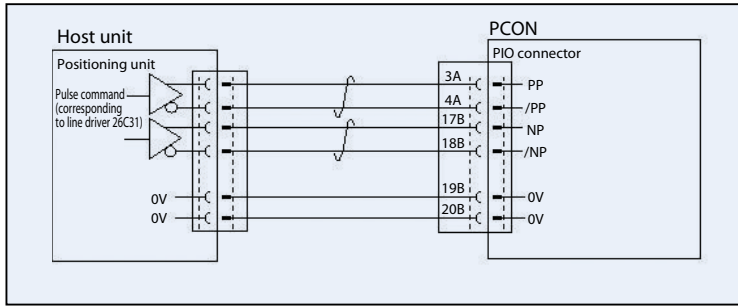

■ **Host Unit = Open Collector Type**

The AK-04 (optional) is needed to input pulses.

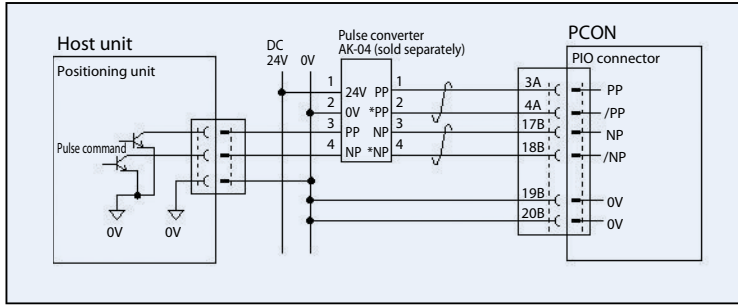

Caution: Use the same power supply for open collector input/output to/from the host and for the AK-04.

Command Pulse Input Patterns

	Command pulse-train pattern	Input terminal	Forward	Reverse	
Negative logic	Forward pulse-train	PP-/PP			
	Reverse pulse-train	NP-/NP			
	A forward pulse-train indicates the amount of motor rotation in the forward direction, while a reverse pulse-train indicates the amount of motor rotation in the reverse direction.				
	Pulse-train	PP-/PP			
	Sign	NP-/NP	Low	High	
	The command pulses indicate the amount of motor rotation, while the sign indicates the rotating direction.				
Positive logic	Forward pulse train	PP-/PP			
	Reverse pulse-train	NP-/NP			
	Pulse-train	PP-/PP			
	Sign	NP-/NP	High	Low	
	Phase A/B pulse-train	PP-/PP			
		NP-/NP			
Command phases A and B having a 90° phase difference (multiplier is 4) indicate the amount of rotation and the rotating direction.					

I/O Signals in Pulse-train Control Mode

The table below lists the signal assignments for the flat cable in the pulse-train control mode. Connect an external device (such as PLC) according to this table.

Pin number	Category	I/O number	Signal abbreviation	Signal name	Parameter No. 25, "PIO pattern 6"
1A	24V		P24	Power supply	I/O power supply +24 V
2A	24V		P24	Power supply	I/O power supply +24 V
3A	Pulse input		PP	Differential pulse-train input (+)	Differential pulses are input from the host. Up to 200 kpps can be input.
4A			/PP	Differential pulse-train input (-)	
5A	Input	IN0	SON	Servo ON	The servo is ON while this signal is ON, and OFF while the signal is OFF.
6A		IN1	RES	Reset	Present alarms are reset when this signal is turned ON.
7A		IN2	HOME	Home return	Home return operation is performed when this signal is turned ON.
8A		IN3	TL	Torque limit selection	When this signal is turned ON, the motor torque is limited to the value set by the parameter.
9A		IN4	CSTP	Forced stop	The actuator is forcibly stopped when this signal has remained ON for 16 ms or more. The actuator decelerates to a stop at the torque set in the controller and the servo turns OFF.
10A		IN5	DCLR	Deviation counter clear	This signal clears the deviation counter.
11A		IN6	BKRL	Forced brake release	The brake is forcibly released.
12A		IN7	RMOD	Operation mode switching	The operation mode can be switched when the MODE switch on the controller is set to AUTO. (AUTO when this signal is OFF, and to MANU when the signal is ON.)
13A		IN8	NC	—	Not used
14A		IN9	NC	—	Not used
15A		IN10	NC	—	Not used
16A		IN11	NC	—	Not used
17A		IN12	NC	—	Not used
18A		IN13	NC	—	Not used
19A		IN14	NC	—	Not used
20A	IN15	NC	—	Not used	
1B	Output	OUT0	PWR	System ready	This signal turns ON when the controller is ready after the main power has been turned on.
2B		OUT1	SV	Servo ON status	This signal turns ON when the servo is ON.
3B		OUT2	INP	Positioning complete	This signal turns ON when the amount of remaining travel pulses in the deviation counter falls within the in-position band.
4B		OUT3	HEND	Home return complete	This signal turns ON upon completion of home return.
5B		OUT4	TLR	Torque limited	This signal turns ON upon reaching the torque limit while the torque is limited.
6B		OUT5	*ALM	Controller alarm status	This signal turns ON when the controller is normal, and turns OFF when an alarm generates.
7B		OUT6	*EMGS	Emergency stop status	This signal turns ON when the emergency stop of the controller is cancelled, and turns OFF when an emergency stop is actuated.
8B		OUT7	RMDS	Operation mode status	The operation mode status is output. This signal turns ON when the controller is in the manual mode.
9B		OUT8	ALM1	Alarm code output signal	An alarm code is output when an alarm generates. For details, refer to the operation manual.
10B		OUT9	ALM2		
11B		OUT10	ALM4		
12B		OUT11	ALM8		
13B		OUT12	*ALML	Minor failure alarm	This signal is output when a message-level alarm generates.
14B		OUT13	NC	—	Not used
15B		OUT14	ZONE1	Zone signal 1	This signal turns ON when the current position of the actuator falls within the parameter-set range.
16B	OUT15	ZONE2	Zone signal 2		
17B	Pulse input		NP	Differential pulse-train input (+)	Differential pulses are input from the host. Up to 200 kpps can be input.
18B			/NP	Differential pulse-train input (-)	
19B	0V		N	Power supply	I/O power supply 0 V
20B	0V		N	Power supply	I/O power supply 0 V

Note) * indicates a negative logic signal. Negative logic signals are normally ON while the power is supplied, and turn OFF when the signal is output.

(Note) The number of encoder pulses is 800 with all RCP4 series models. For details, refer to the operation manual.

Field Network Specification: Explanation of Operation Modes

If the PCON-CA is controlled via a field network, you can select one of the following five modes to operate the actuator. Take note that the required data areas on the PLC side vary depending on the mode.

■ Explanation of Modes

	Mode	Description
0	Remote I/O mode	In this mode, the actuator is operated by controlling the ON/OFF of bits via the network, just like with the PIO specification. The number of positioning points and functions vary with each of the operation patterns (PIO patterns) that can be set by the controller's parameter.
1	Position/simple direct numerical mode	The target position is specified by directly entering a value, while other operating conditions (speed, acceleration, etc.) are set by specifying the desired position number corresponding to the desired operating conditions already input to the position data table.
2	Half direct numerical mode	The actuator is operated by specifying the speed, acceleration/deceleration and push current, in addition to the target position, by directly entering values.
3	Full direct numerical mode	The actuator is operated by specifying the target position, speed, acceleration/deceleration, push current control value, etc., by directly entering values. The current position, current speed, command current, etc., can also be read.
4	Remote I/O mode 2	Same as the above remote I/O mode, plus the current position read function and command current read function.

■ Required Data Size for Each Network

		DeviceNet	CC-Link	PROFIBUS-DP	CompoNet	MECHATROLINK I, II	EtherCAT	EtherNet/IP
0	Remote I/O mode	1CH	1 station	2 bytes	2 bytes	*	2 bytes	2 bytes
1	Position/simple direct numerical mode	4CH	1 station	8 bytes	8 bytes	*	8 bytes	8 bytes
2	Half direct numerical mode	8CH	2 stations	16 bytes	16 bytes	*	16 bytes	16 bytes
3	Full direct numerical mode	16CH	4 stations	32 bytes	32 bytes	*	32 bytes	32 bytes
4	Remote I/O mode 2	6CH	1 station	12 bytes	12 bytes	*	12 bytes	12 bytes

* No required data size is set for MECHATROLINK I and II.

■ List of Functions by Operation Mode

	Remote I/O mode	Position/simple direct numerical mode	Half direct numerical mode	Full direct numerical mode	Remote I/O mode 2
Number of positioning points	512 points	768 points	Not limited	Not limited	512 points
Operation by direct position data specification	X	○	○	○	X
Direct speed/acceleration specification	X	X	○	○	X
Push-motion operation	○	○	○	○	○
Current position read	X	○	○	○	○
Current speed read	X	X	○	○	X
Operation by position number specification	○	○	X	X	○
Completed position number read	○	○	X	X	○

* ○ indicates that the operation is supported, and X indicates that it is not supported.
(Note 1) Take note that the MECHATROLINK specification does not support the full direct numerical mode.

External Dimensions

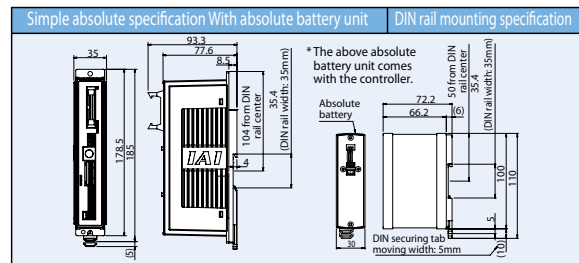
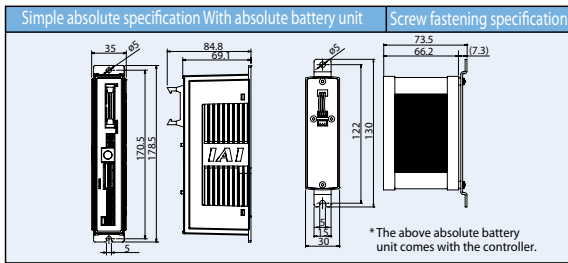
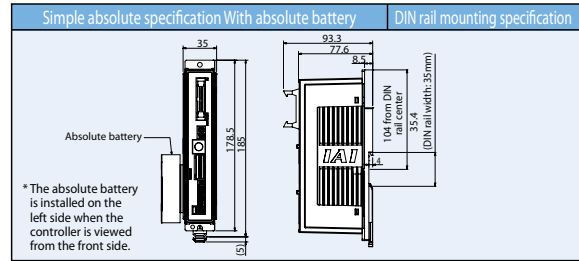
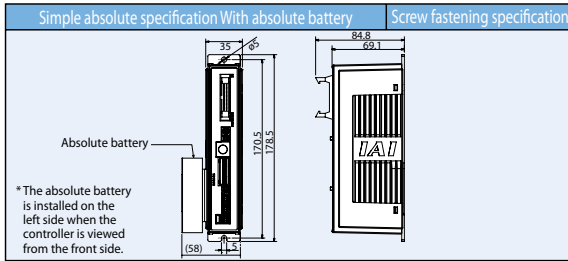
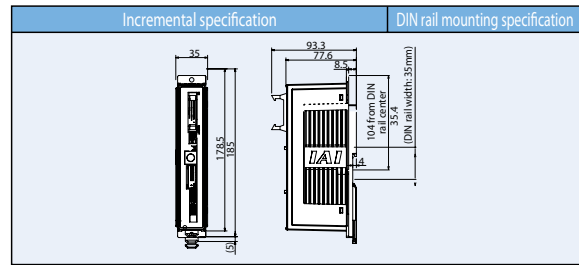
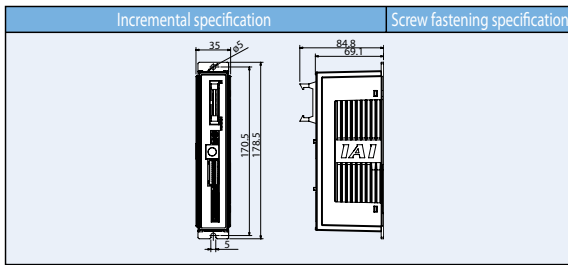

Specification Table

Item		Description
		PCON-CA
Number of controlled axes		1 axis
Power supply voltage		24VDC ± 10%
Load capacity (Current consumption of controlled axes included) (Note 1)	RCP2	20P, 28P, 20SP, 28SP
	RCP3	35P, 42P, 56P
	RCP4	60P, 86P
	Motor type	42P, 56P
Power supply for electromagnetic brake (for actuators with brake)		High-output setting disabled: 2.0A max. High-output setting enabled: 3.5A rated / 4.2 max.
Rush current (Note 1)		24VDC ± 10%, 0.15A (max.)
Momentary power failure resistance		8.3A
Applicable encoder		500µs max.
Actuator cable length		Incremental encoder of 800 pulses/rev in resolution
External interface		20m max.
		Dedicated 24-VDC signal input/output (NPN or PNP selected) --- Up to 16 input points, up to 16 output points / Cable length: 10m max.
Data setting/input method		DeviceNet, CC-Link, PROFIBUS, CompoNET, MECHATROLINK, EtherCAT, EtherNet/IP
Data retention memory		PC software, touch-panel teaching pendant
Operation modes		Positioner mode / Pulse-train control mode (Selectable by parameter setting)
Number of positions in positioner mode		Up to 512 points for the positioner type, up to 768 points for the network type (Note) The number of positioning points varies depending on the PIO pattern selected.
Pulse-train interface		Differential method (line driver method): 200kpps max. / Cable length: 10m max.
		Open collector method: Not supported * If the host uses open-collector output, convert the open-collector pulses to differential pulses using the AK-04 (available as an option).
		Command pulse magnification (electronic gear ratio: A/B) Setting range of A and B (set by parameters): 1 to 4096
		None
Isolation resistance		500-VDC 10 MΩ or more
Electric shock protection mechanism		Class I basic isolation
Mass (Note 3)	Incremental specification	Screw fastening type: 250g or less DIN rail securing type: 285g or less
	Simple absolute specification (190g of battery weight included)	Screw fastening type: 450g or less DIN rail securing type: 485g or less
Cooling method		Natural air cooling
Environment	Ambient operating temperature	0 to 40°C
	Ambient operating humidity	85%RH or less (non-condensing)
	Operating ambience	Not exposed to corrosive gases
	Protection degree	IP20

(Note 1) The value increases by 0.3 A for the field network specification.

(Note 2) After the power is turned on, rush current will flow for approx. 5msec at 40°C. Take note that the rush current varies depending on the impedance of the power-supply line.

(Note 3) The value increases by 30g for the field network specification.

Option

Teaching pendant

■ **Summary** Teaching device for positioning input, test operation, and monitoring.

■ **Model** **CON-PTA-C** (Touch panel teaching pendant)

■ **Setting**

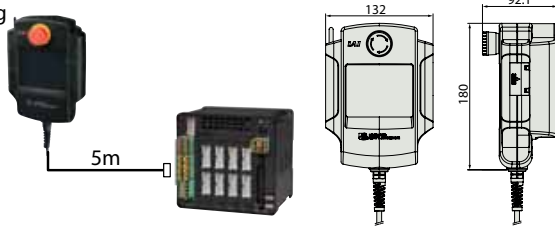

■ **Specification**

Item	CON-PTA-C
Data input	○
Actuator motion	○
Operating ambient temperature/humidity	Temperature 0 to 40°C, humidity 85% RH or less
Operating environment	Free from corrosive gas and especially, considerably dusty condition
Protection degree	IP40
Weight	Approximately 570g
Cable length	5m
Display	65536 color White LED back light
Standard price	-

PC software (Windows only)

* For the MSEP field network specification, the PC software is required.

■ **Summary** A startup support software for inputting positions, performing test runs, and monitoring. With enhancements for adjustment functions, the startup time is shortened.

■ **Model** **RCM-101-MW** (External device communication cable + RS232 conversion unit)

■ **Setting**

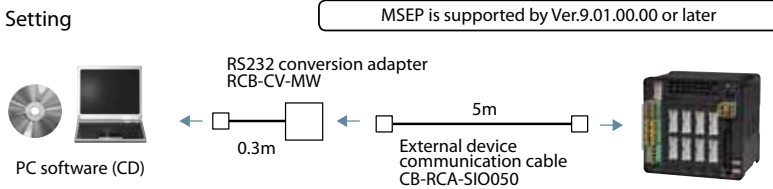

■ **Model** **RCM-101-USB** (External device communication cable + USB converter adaptor + USB cable)

■ **Setting**

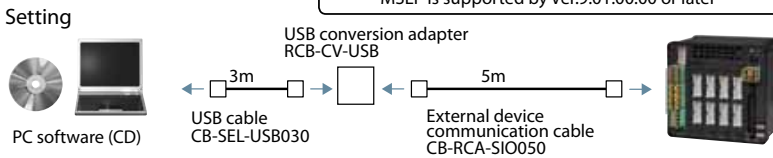

Absolute Battery Unit

■ **Summary** Battery unit that comes with a simple absolute controller, used to back up the current controller position.

■ **Model** **SEP-ABU** (DIN rail mount specification)

SEP-ABUS (screw fixing specification)

■ **Specifications**

Item	Specification
Ambient operating temperature, humidity	0 to 40°C (desirably around 20°C), 95% RH or below (non-condensing)
Operating ambience	Free from corrosive gases
Absolute battery	Model number: AB-7 (Ni-MH battery / Life: Approx. 3 years)
Controller/absolute battery unit link cable	Model number: CB-APSEP-AB005 (Length: 0.5m)
Mass	Standard type: Approx. 230g / Dust-proof type: Approx. 260g

Replacement battery

■ **Summary** The replacement battery for the absolute data backup battery box.

■ **Model** **AB-7**



DIN rail mount specification

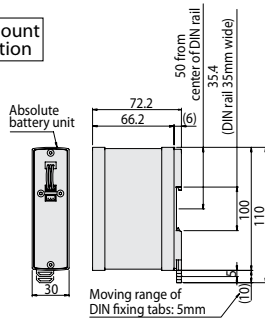

Screw fixing specification

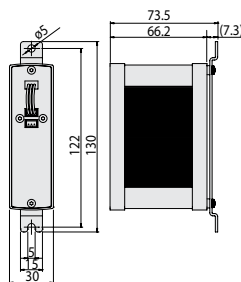

Service parts

Integrated Motor-Encoder Cable/ Motor-Encoder Robot Cable for RCP4

Model number **CB-CA-MPA**□□□□/ **CB-CA-MPA**□□□□-**RB**

* Please indicate cable length (L) in □□□, maximum 20m. e.g.) 080=8m

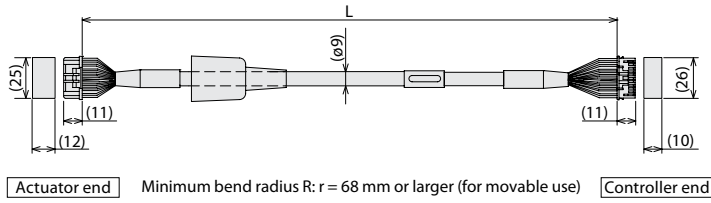

Actuator end Minimum bend radius R: r = 68 mm or larger (for movable use) Controller end

* Robot cables are cables resistant to flexing forces. If the cable must be guided in a cable track, use a robot cable.

Actuator end 1-1827863-1 (AMP)			Controller end PADP-24V-1-5 (JST)		
Pin No.	Signal name	Color	Pin No.	Signal name	Color
A1	0A/U	Blue(Black)	1	0A/U	Blue (Black)
B1	VMM/V	Orange (White)	2	VMM/V	Orange (White)
A2	0 A/W	Green (Brown)	3	0 A/W	Green (Brown)
B2	0B/-	Brown (Green)	4	0B/-	Brown (Green)
A3	VMM/-	Gray (Yellow)	5	VMM/-	Gray (Yellow)
B3	0 B/-	Red (Red)	6	0 B/-	Red (Red)
A4	LS+/BK+	Black (Orange)	7	LS+/BK+	Black (Orange)
B4	LS-/BK-	Yellow (Gray)	8	LS-/BK-	Yellow (Gray)
A6	-/A+	Blue (White)	11	-/A+	Blue (White)
B6	-/A-	Orange (Yellow)	12	-/A-	Orange (Yellow)
A7	A+/B+	Green (Green)	13	A+/B+	Green (Red)
B7	A-/B-	Brown (Green)	14	A-/B-	Brown (Green)
A8	B+/Z+	Gray (Black)	15	B+/Z+	Gray (Black)
B8	B-/Z-	Red (Brown)	16	B-/Z-	Red (Brown)
A5	BK+/LS+	Blue (Black)	9	BK+/LS+	Blue (Black)
B5	BK-/LS-	Orange (Brown)	10	BK-/LS-	Orange (Brown)
A9	LS_GND	Green (Green)	20	LS_GND	Green (Green)
B9	VPS	Brown (Red)	18	VPS	Brown (Red)
A10	VCC	Gray (White)	17	VCC	Gray (White)
B10	GND	Red (Yellow)	19	GND	Red (Yellow)
A11	-	-	21	-	-
B11	FG	Black (-)	22	-	-
			23	-	-
			24	FG	Black (-)

* Colors of robot cables are shown in ().

Integrated Motor-Encoder Cable for RCP2

Model number **CB-PSEP-MPA**□□□□ * The default specification of this cable is robot cable.

* Please indicate cable length (L) in □□□, maximum 20m. e.g.) 080=8m

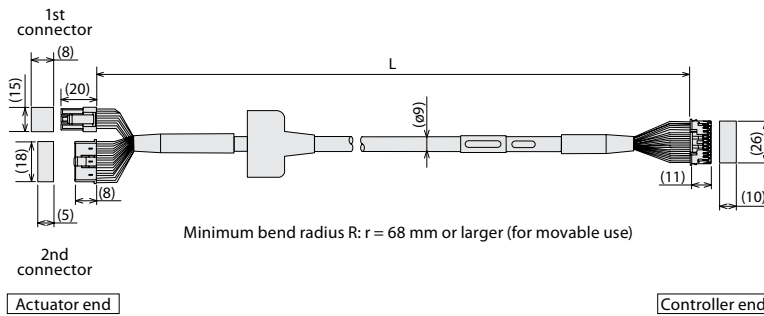

Minimum bend radius R: r = 68 mm or larger (for movable use)

Actuator end

Controller end

Actuator end Pin number			Controller end Pin number	
1		Black (0A)		1
2		White (VMM)		2
3		Red (0B)		3
4		Green (VMM)		4
5		Brown (0A)		5
6		Yellow (0B)		6
16		Orange (BK+)		9
17		Gray (BK-)		10
5		NC		11
6		NC		12
13		Black (LS+)		7
14		Brown (LS-)		8
1		White (A+)		13
2		Yellow (A-)		14
3		Red (B+)		15
4		Green (B-)		16
10		White (identification tape) (VCC)		17
11		Yellow (identification tape) (VPS)		18
9		Red (identification tape) (GND)		19
12		Green (identification tape) (spare)		20
15		NC		21
7		NC		22
8		NC		23
18		Shield (FG)		24

Integrated Motor-Encoder Cable for RCP3

Model number **CB-APSEP-MPA**□□□□ * The default specification of this cable is robot cable.

* Please indicate cable length (L) in □□□, maximum 20m. e.g.) 080=8m

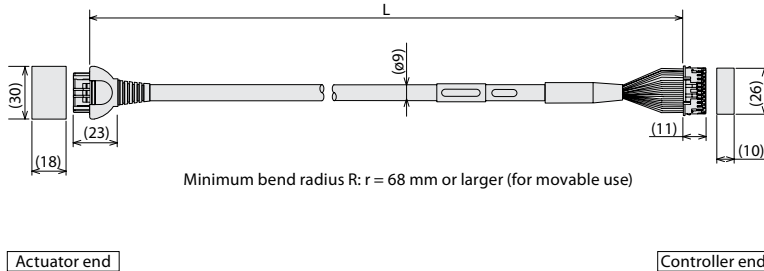

Minimum bend radius R: r = 68 mm or larger (for movable use)

Actuator end

Controller end

Actuator end Pin number			Controller end Pin number	
A1		(PCON) (ACON)		1
B2		Black (0A) (U)		2
A2		White (VMM) (V)		3
B2		Brown (0A) (W)		5
A3		Green (0B) (-)		3
B3		Yellow (VMM) (-)		4
A4		Red (0B) (+)		6
B4		Orange (LS+) (BK+)		7
A6		Gray (LS-) (BK-)		8
B6		White (-) (A+)		11
A6		Yellow (-) (A-)		12
A7		Red (A+) (B+)		13
B7		Green (A-) (B-)		14
A8		Black (B+) (Z+)		15
B8		Brown (B-) (Z-)		16
A5		Black (identification tape) (BK+) (LS+)		9
B5		Brown (identification tape) (BK-) (LS-)		10
A9		Green (identification tape) (GNLS) (GNLS)		20
B9		Red (identification tape) (WPS) (WPS)		19
A10		White (identification tape) (VCC) (VCC)		17
B10		Yellow (identification tape) (GND) (GND)		18
A11		NC		21
B11		Shield (FG) (FG)		24
		NC		22
		NC		23

I/O Flat Cable

Model number **CB-PAC-PIO**□□□□

* Please indicate cable length (L) in □□□, maximum 10m. e.g.) 080=8m

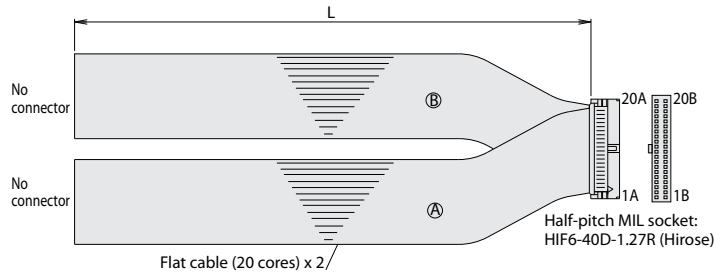

Half-pitch MIL socket: HIF6-40D-1.27R (Hirose)

No.	Signal name	Cable color	Wiring	No.	Signal name	Cable color	Wiring
1A	24V	Brown-1		18	OUT0	Brown-3	
2A	24V	Red-1		28	OUT1	Red-3	
3A	Pulse	Orange-1		38	OUT2	Orange-3	
4A	input	Yellow-1		48	OUT3	Yellow-3	
5A	IN0	Green-1		58	OUT4	Green-3	
6A	IN1	Blue-1		68	OUT5	Blue-3	
7A	IN2	Purple-1		78	OUT6	Purple-3	
8A	IN3	Gray-1		88	OUT7	Gray-3	
9A	IN4	White-1		98	OUT8	White-3	
10A	IN5	Black-1		108	OUT9	Black-3	
11A	IN6	Brown-2		118	OUT10	Brown-4	
12A	IN7	Red-2		128	OUT11	Red-4	
13A	IN8	Orange-2		138	OUT12	Orange-4	
14A	IN9	Yellow-2		148	OUT13	Yellow-4	
15A	IN10	Green-2		158	OUT14	Green-4	
16A	IN11	Blue-2		168	OUT15	Blue-4	
17A	IN12	Purple-2		178	Pulse	Purple-4	
18A	IN13	Gray-2		188	input	Gray-4	
19A	IN14	White-2		198	0V	White-4	
20A	IN15	Black-2		208	0V	Black-4	

Flat cable (2) (crimped)

Flat cable (3) (crimped) AWG 28