

- Slider Type
- Mini
- Standard
- Controllers Integrated
- Rod Type
- Mini
- Standard
- Controllers Integrated
- Table/Arm /Flat Type
- Mini
- Standard
- Gripper/ Rotary Type
- Linear Servo Type
- Cleanroom Type
- Splash-Proof
- Controllers
- PMEC /AMEC
- PSEP /ASEP
- ROBO NET
- ERC2
- PCON
- ACON
- SCON
- PSEL
- ASEL
- SSEL
- XSEL
- Pulse Motor
- Servo Motor (24V)
- Servo Motor (200V)
- Linear Servo Motor

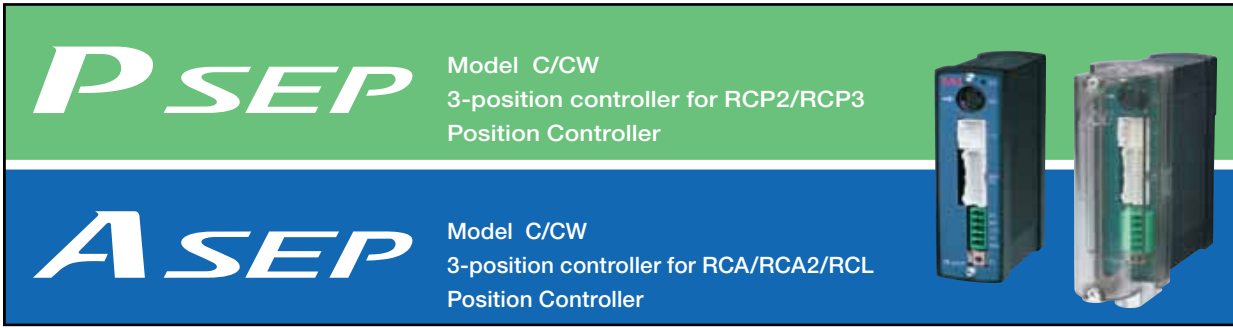

Feature

1 Can operate with same signal as a solenoid valve.

The signal that operates the actuator is the same as the signal that operates the air cylinder. Therefore, the PLC program currently in use can be used without modification even if the air cylinder is replaced by an electric-powered cylinder. Either a single solenoid or a double solenoid may be used.

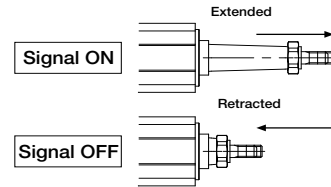

2 Establishes a dustproof type that supports IP53.

We provide dustproof type controllers with an IP53 equivalent (*1) protection structure, so that the controller can be mounted outside the control panel.

(1) Bottom surface excluded.



3 Provides the simple absolute type that can be operated immediately upon power-ON without homing.

Since the simple absolute type can store the current position with the assistance of the absolute battery unit during power-up or after the emergency stop is deactivated; it can start the next operation at that position.

(Note 1) When the actuator is connected to the simple absolute type controller, the model is considered an incremental model.

When mounting the absolute battery unit, mount it below the SEP controller.

(Note 2) It can not be used for the linear servo type.

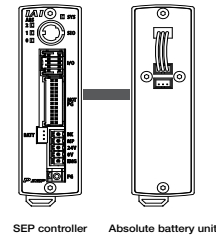

4 Pushing and intermediate stop operation is available.

Like air cylinders, the pushing operation is available. In this operation, you can stop with a rod being pushed to a workpiece.

Since the force for the push operation is adjustable within a range between 20 to 70 % of the maximum pushing force and a signal is generated when it reaches the specified pushing force, it can be used to determine clamping or size of workpieces.

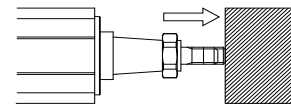

Push force is adjustable within the range of 20 to 70% of the maximum pushing force

5 Easy data entry with the dedicated touch panel teaching unit.





Data, such as setting target positions or pushing force, are easily entered with the optional touch panel teaching model: CON-PT.

Since the touch panel teaching unit provides an interactive menu and can be controlled directly on the screen, you can operate intuitively with no assistance from operation manuals.



487 PSEP / ASEP

Model List

Series name	PSEP				ASEP			
	C		CW		C		CW	
Type	Standard		Dustproof		Standard		Dust proof	
Name	Standard		Dustproof		Standard		Dust proof	
Positioning method	Incremental encoder	Simple absolute type	Incremental encoder	Simple absolute type	Incremental encoder	Simple absolute type	Incremental encoder	Simple absolute type
External View								
Description	Position controller, for pulse motors, specialized to 2 positions / 3 positions positioning and easier control		PSEP-C dustproof type with an IP53 equivalent protection structure		Position controller, for servo motors, specialized to 2 positions / 3 positions positioning and easier control		ASEP-C dustproof type with an IP53 equivalent protection structure	
Number of positions	2 positions / 3 positions							
Standard price	-	-	-	-	-	-	-	-

Model

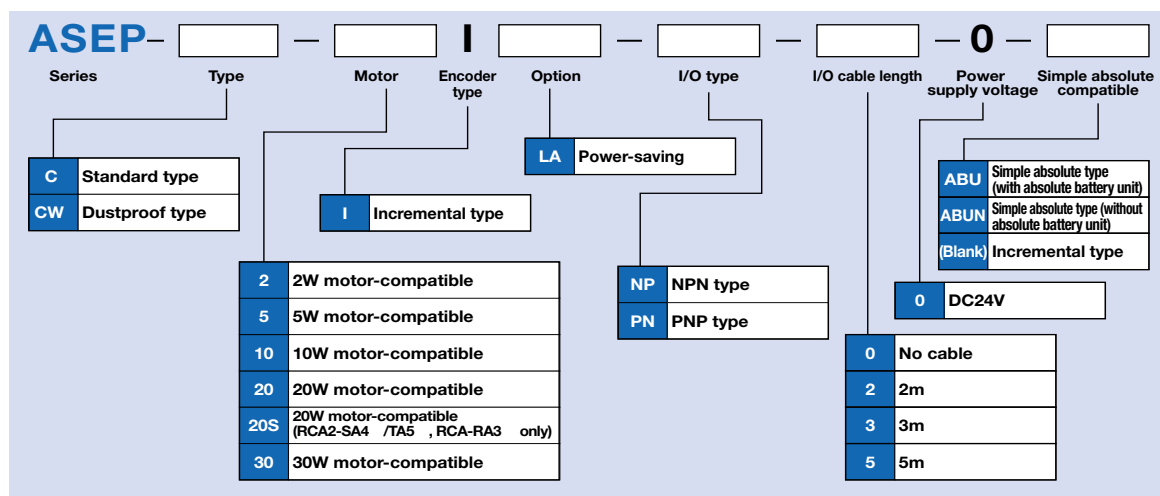
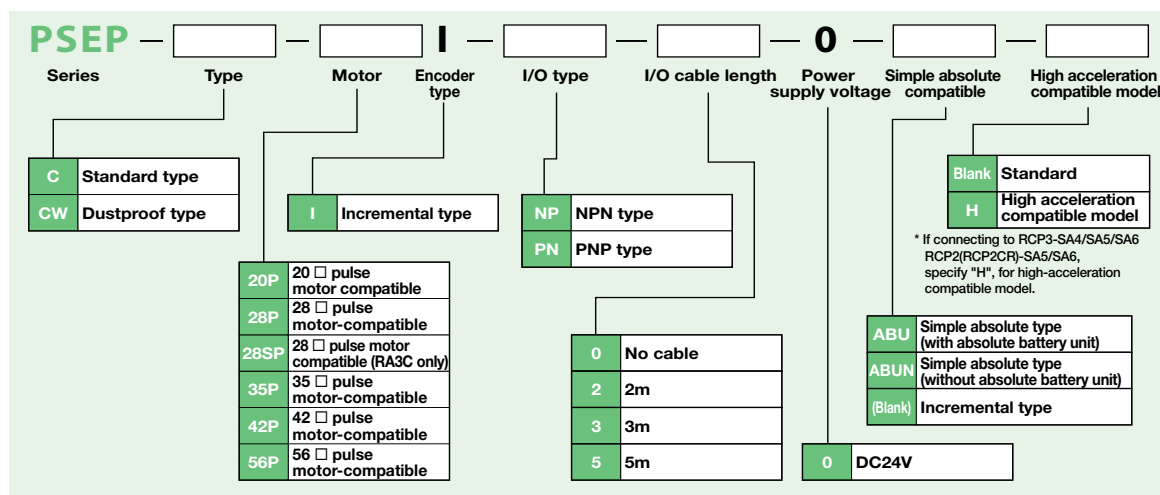

- Slider Type
- Mini
- Standard
- Controllers Integrated
- Rod Type
- Mini
- Standard
- Controllers Integrated
- Table/Arm /Flat Type
- Mini
- Standard
- Gripper/ Rotary Type
- Linear Servo Type
- Cleanroom Type
- Splash-Proof
- Controllers
- PMEC /AMEC
- PSEP /ASEP
- ROBO NET
- ERC2
- PCON
- ACON
- SCON
- PSEL
- ASEL
- SSEL
- XSEL
- Pulse Motor
- Servo Motor (24V)
- Servo Motor (200V)
- Linear Servo Motor

System structure

[PSEP]

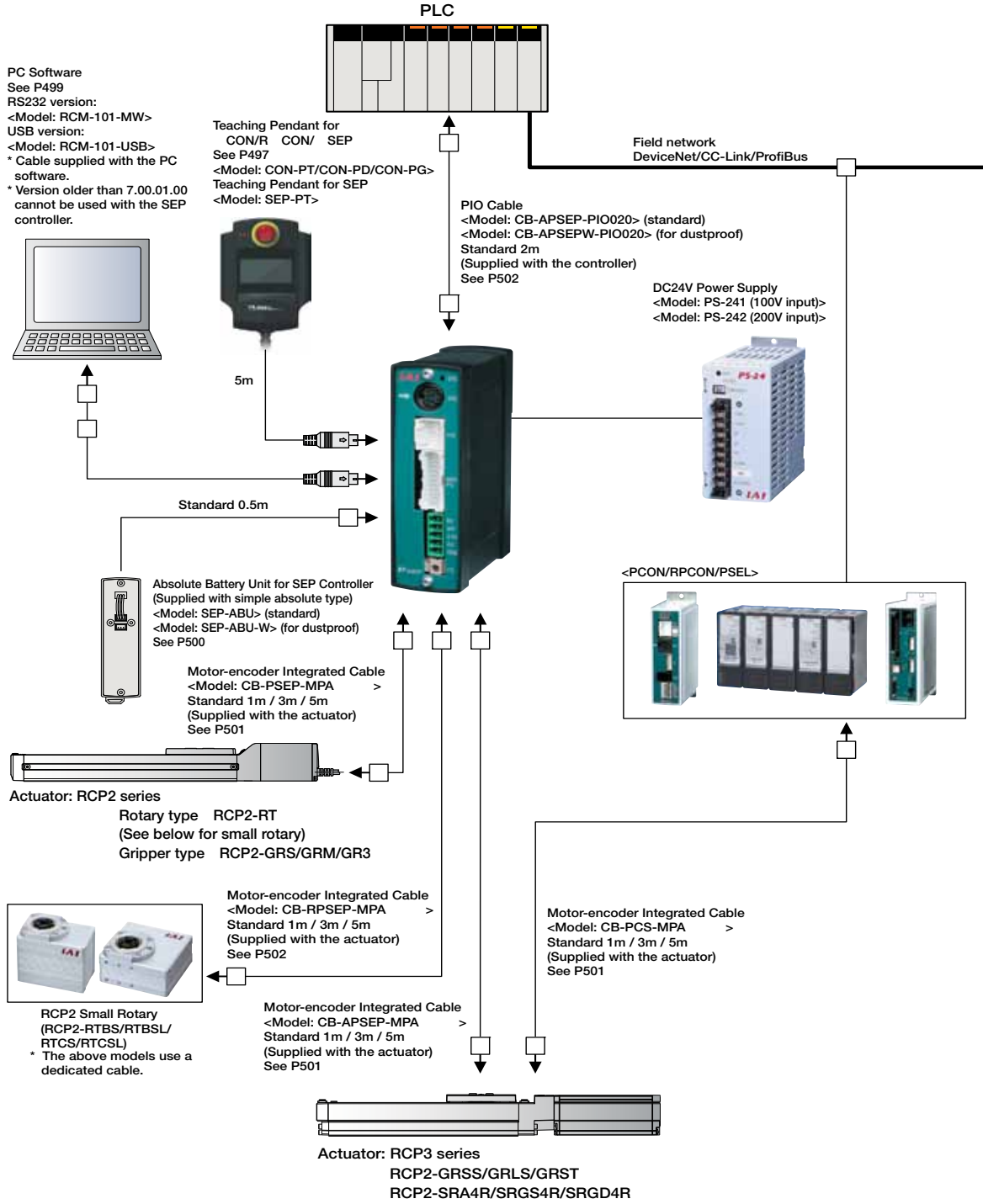

- Slider Type
- Mini
- Standard
- Controllers Integrated
- Rod Type
- Mini
- Standard
- Controllers Integrated
- Table/Arm /Flat Type
- Mini
- Standard
- Gripper/ Rotary Type
- Linear Servo Type
- Cleanroom Type
- Splash-Proof
- Controllers
- PMEC /AMEC
- PSEP /ASEP
- ROBO NET
- ERC2
- PCON
- ACON
- SCON
- PSEL
- ASEL
- SSEL
- XSEL
- Pulse Motor
- Servo Motor (24V)
- Servo Motor (200V)
- Linear Servo Motor

System structure

[ASEP]

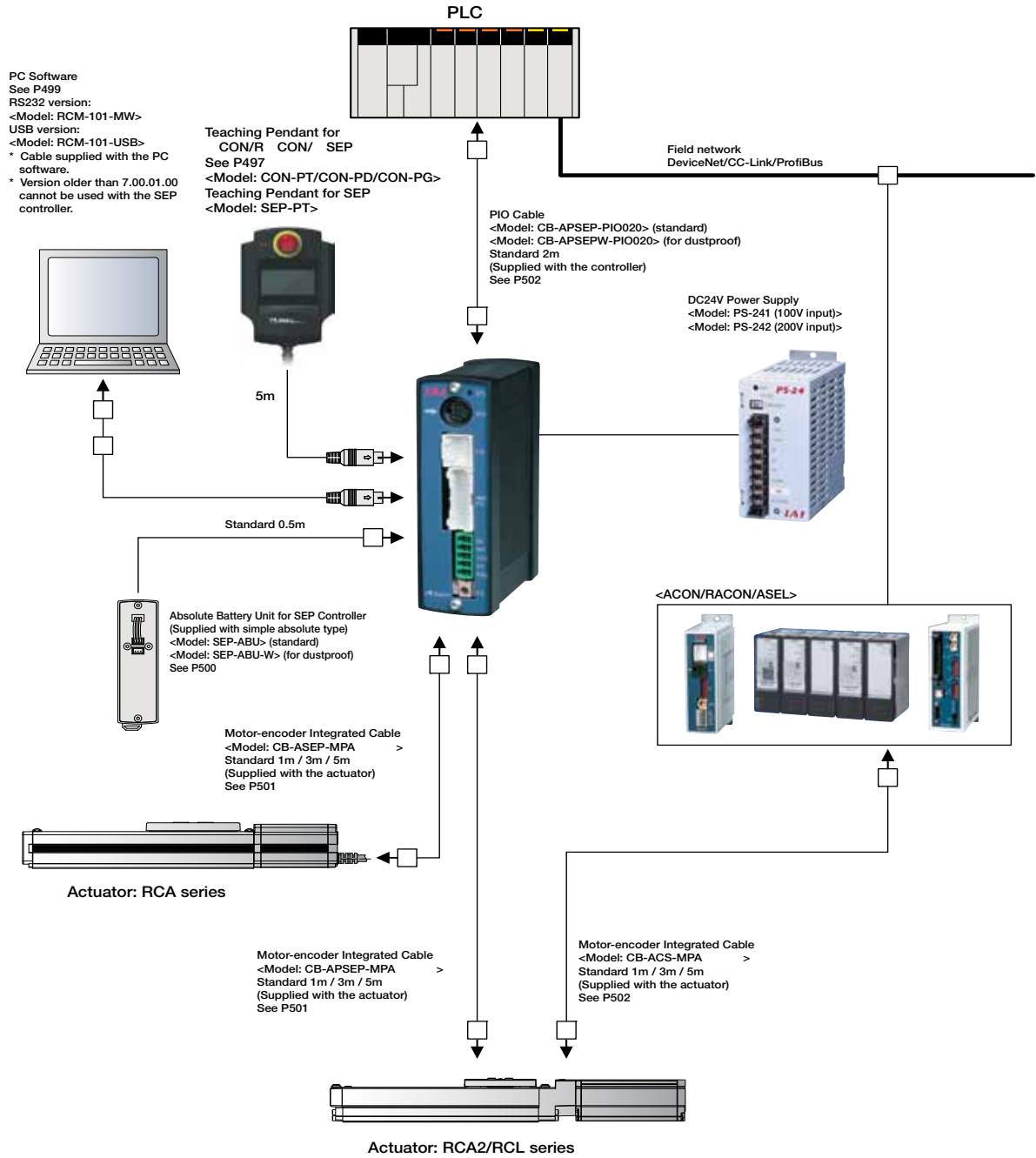

- Slider Type
- Mini
- Standard
- Controllers Integrated
- Rod Type
- Mini
- Standard
- Controllers Integrated
- Table/Arm /Flat Type
- Mini
- Standard
- Gripper/ Rotary Type
- Linear Servo Type
- Cleanroom Type
- Splash-Proof
- Controllers
- PMEC /AMEC
- PSEP /ASEP
- ROBO NET
- ERC2
- PCON
- ACON
- SCON
- PSEL
- ASEL
- SSEL
- XSEL
- Pulse Motor
- Servo Motor (24V)
- Servo Motor (200V)
- Linear Servo Motor



PIO Pattern Description

The SEP controller provides the following six PIO patterns from which you can choose for operation. Also, PIO patterns 0 to 2 support both the single solenoid and double solenoid signal configurations.

PIO Pattern Number		0		1		2		3		4		5	
PIO Pattern Name		Standard 2-position movement		Moving speed change		Position Data Change		2-input 3-position travel		3-input 3-position travel		Continuous cycle operation	
Feature		Continuous cycle operation		2-position motion		2-position motion		3-position motion		3-position motion		Continuous motion between 2 positions	
		Push		Push		Push		Push		Push		Push	
		-		Changing speed during motion		Motion position data change		-		-		-	
Supported solenoid configurations		Single	Double	Single	Double	Single	Double	-		-		-	
Input	0	Motion signal	Motion signal 1	Motion signal	Motion signal 1	Motion signal	Motion signal 1	Motion signal 1	Retract motion signal	Continuous operation signal			
	1	Pause signal	Motion signal 2	Pause signal	Motion signal 2	Pause signal	Motion signal 2	Motion signal 2	Extend motion signal	Pause signal			
	2	- (Reset signal)		Moving speed change signal (reset signal)		Target position change signal (reset signal)		- (Reset signal)		Intermediate motion signal (reset signal)		- (Reset signal)	
	3	-/Servo-ON signal		-/Servo-ON signal		-/Servo-ON signal		-/Servo-ON signal		-/Servo-ON signal		-/Servo-ON signal	
Output	0	Retract motion output signal		Retract motion output signal		Retract motion output signal		Retract motion output signal		Retract motion output signal		Retract motion output signal	
	1	Extend motion output signal		Extend motion output signal		Extend motion output signal		Extend motion output signal		Extend motion output signal		Extend motion output signal	
	2	Homing completion signal / Servo-ON output signal		Homing completion signal / Servo-ON output signal		Homing completion signal / Servo-ON output signal		Midpoint position output signal		Midpoint position output signal		Homing completion signal / Servo-ON output signal	
	3	Alarm output signal / Servo-ON output signal		Alarm output signal / Servo-ON output signal		Alarm output signal / Servo-ON output signal		Alarm output signal / Servo-ON output signal		Alarm output signal / Servo-ON output signal		Alarm output signal / Servo-ON output signal	

* For the signals above, see the controller manuals (downloadable from our website).

PIO Pattern 0 (Standard 2-Position travel)

This PIO pattern involves movements between two positions—the end position and the home position. The positions can be set numerically to any position (by inputting to the controller using the optional touch panel teaching pendant). Two motions are possible: A “positioning motion” moves the rod or the slider to the specified position, and a “pushing motion” pushes the rod against a workpiece.

Positioning Motion (Single Solenoid)

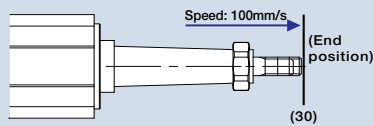

End Position Data	
Position	30
Speed	100
Pushing force	-
Width	-

Input Signals

Input 0	ON
Input 1	-
Input 2	-
Input 3	-

When Input 0 is turned ON, the slider/rod moves to the end position (30mm coordinate) at a speed of 100mm/s.

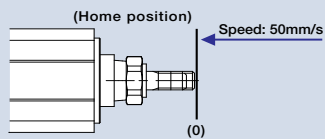

Home Position Data	
Position	0
Speed	50
Pushing force	-
Width	-

Input Signals

Input 0	OFF
Input 1	-
Input 2	-
Input 3	-

When input 0 is turned OFF, the slider/rod returns to the home position (0mm coordinate) at a speed of 50mm/s.

- Slider Type
- Mini
- Standard
- Controllers Integrated
- Rod Type
- Mini
- Standard
- Controllers Integrated
- Table/Arm /Flat Type
- Mini
- Standard
- Gripper/ Rotary Type
- Linear Servo Type
- Cleanroom Type
- Splash-Proof
- Controllers
- PMEC /AMEC
- PSEP /ASEP
- ROBO NET
- ERC2
- PCON
- ACON
- SCON
- PSEL
- ASEL
- SSEL
- XSEL
- Pulse Motor
- Servo Motor (24V)
- Servo Motor (200V)
- Linear Servo Motor

Positioning Motion (Double Solenoid)

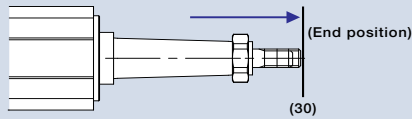

End Position Data	
Position	30
Speed	100
Pushing force	-
Width	-

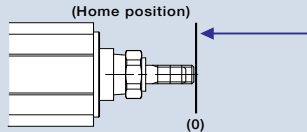

Home Position Data	
Position	0
Speed	50
Pushing force	-
Width	-

Input Signals

Input 0	OFF
Input 1	ON
Input 2	-
Input 3	-

When Input 1 is turned ON and Input 0 is turned OFF, the slider/rod moves to the end position (30mm coordinate) at a speed of 100mm/s.

Input Signals

Input 0	ON
Input 1	OFF
Input 2	-
Input 3	-

When Input 0 is turned ON and Input 1 is turned OFF, the slider/rod returns to the home position (0mm coordinate) at a speed of 50mm/s.

Push motion (single solenoid)

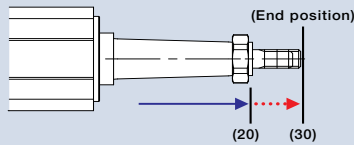

End Position Data	
Position	30
Speed	100
Pushing force	50
Width	10

Input Signals

Input 0	ON
Input 1	-
Input 2	-
Input 3	-

When Input 0 is turned ON, the rod moves to the 20mm position at 100mm/s, and then starts pushing from the 20mm position to the 30mm position at slow speed.

* The pushing motion is performed only if there is a numerical value for the pushing force in the controller's position data. (If there is no numerical value for the pushing force, a positioning motion will be performed instead.)

Push motion (double solenoid)

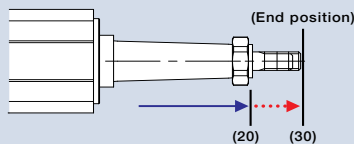

End Position Data	
Position	30
Speed	100
Pushing force	50
Width	10

Input Signals

Input 0	OFF
Input 1	ON
Input 2	-
Input 3	-

When Input 1 is turned ON and Input 0 is turned OFF, the rod moves to the 20mm position at 100mm/s, and then starts pushing from the 20mm position to the 30mm position at slow speed.

* The pushing motion is performed only if there is a numerical value for the pushing force in the controller's position data. (If there is no numerical value for the pushing force, a positioning motion will be performed instead.)

- Slider Type
- Mini
- Standard
- Controllers Integrated
- Rod Type
- Mini
- Standard
- Controllers Integrated
- Table/Arm /Flat Type
- Mini
- Standard
- Gripper/ Rotary Type
- Linear Servo Type
- Cleanroom Type
- Splash-Proof
- Controllers
- PMEC /AMEC
- PSEP /ASEP
- ROBO NET
- ERC2
- PCON
- ACON
- SCON
- PSEL
- ASEL
- SSEL
- XSEL
- Pulse Motor
- Servo Motor (24V)
- Servo Motor (200V)
- Linear Servo Motor

- Slider Type
- Mini
- Standard
- Controllers Integrated
- Rod Type
- Mini
- Standard
- Controllers Integrated
- Table/Arm /Flat Type
- Mini
- Standard
- Gripper/ Rotary Type
- Linear Servo Type
- Cleanroom Type
- Splash-Proof
- Controllers
- PMEC /AMEC
- PSEP /ASEP
- ROBO NET
- ERC2
- PCON
- ACON
- SCON
- PSEL
- ASEL
- SSEL
- XSEL
- Pulse Motor
- Servo Motor (24V)
- Servo Motor (200V)
- Linear Servo Motor

PIO Pattern 1 (Speed Change During Movement)

This PIO pattern involves movements between two positions—the end position and the home position. The speed can be changed in 2 stages. (The speed can be either increased or decreased.) The speed change occurs when the rod/slider passes the speed change position, specified in the position values.

(Single Solenoid)

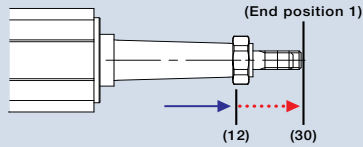
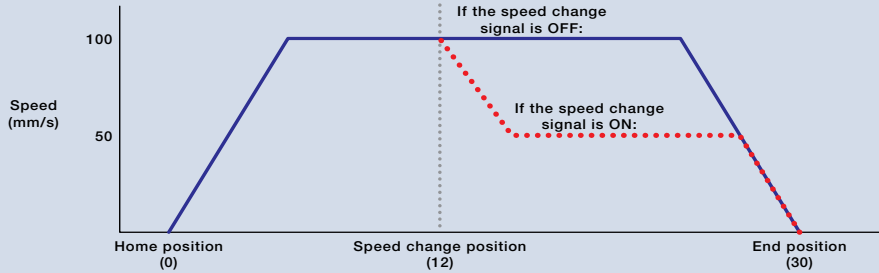

Input Signals

Input 0	ON
Input 1	-
Input 2	ON
Input 3	-

When Input 0 is turned ON while Input 2 is turned ON, the rod moves at the initial speed up to the trigger point. After it passes the trigger point, the speed changes. If Input 2 is not turned ON, the speed will not change.

Home Position Data	
Position	0
Speed	50
Trigger point	12
Trigger speed	100
Pushing force	-
Width	-

End Position Data	
Position	30
Speed	100
Trigger point	12
Trigger speed	50
Pushing force	-
Width	-

PIO Pattern 2 (Position Change)

This PIO pattern involves movements between two positions—the end position and the home position. You can set 2 sets of data for the end / home positions, speed, pushing force, and pushing width. Switching between the 2 sets of data can be done by turning ON/OFF Input 2, which is the signal for switching the target position.

(Single Solenoid)

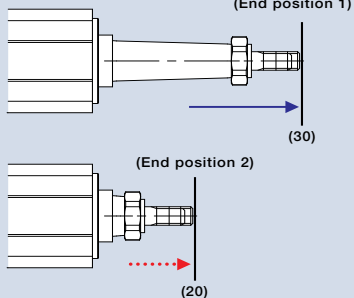
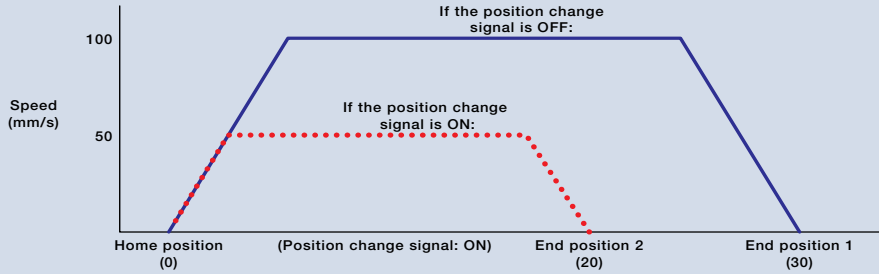

Input Signals

Input 0	ON
Input 1	-
Input 2	ON
Input 3	-

If Input 2 (position change signal) is OFF when Input 0 is turned ON, the rod moves according to the position and speed set in "End Position Data 1" (position: 30 / speed: 100).
 If Input 2 is ON when Input 0 is turned ON, the rod's movement changes to the position and speed set in "End Position Data 2" (position: 20 / speed: 50).
 If Input 2 is OFF when the movement starts, but is turned ON in transit, the target position and speed is changed from that position.

End Position Data 1	
Position	30
Speed	100
Pushing force	-
Width	-

End Position Data 2	
Position	20
Speed	50
Pushing force	-
Width	-

PIO Pattern 3 (2-Input 3-Position Travel)

This PIO pattern involves movements between 3 positions—the end position, the home position, and an intermediate position.

Changing between the positions is done by a combination of 2 signals, Input 0 and Input 1.

Positioning Motion

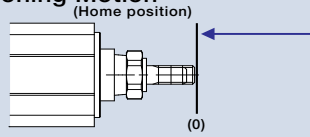

Input Signals

Input 0	ON
Input 1	OFF
Input 2	-
Input 3	-

When only Input 0 is turned ON, the rod moves to the home position at the specified speed.

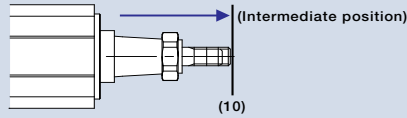

Input Signals

Input 0	ON
Input 1	ON
Input 2	-
Input 3	-

When Input 0 and Input 1 are both turned ON, the rod moves to the intermediate position at the specified speed.

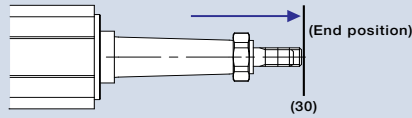

Input Signals

Input 0	OFF
Input 1	ON
Input 2	-
Input 3	-

When only Input 1 is turned ON, the rod moves to the end position at the specified speed.

PIO Pattern 4 (3-Input 3-Position Travel)

This PIO pattern involves movements between 3 positions—the end position, the home position, and an intermediate position.

Changing between positions is done by three signals—Input 0, Input 1 and Input 2, which are commanded to move to the home, end and intermediate positions, respectively.

Positioning Motion

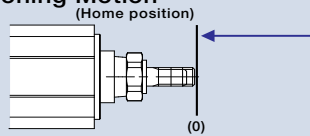

Input Signals

Input 0	ON
Input 1	OFF
Input 2	OFF
Input 3	-

When Input 0 is turned ON, the rod moves to the home position at the specified speed.

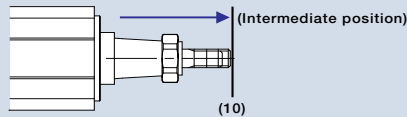

Input Signals

Input 0	OFF
Input 1	OFF
Input 2	ON
Input 3	-

When Input 2 is turned ON, the rod moves to the intermediate position at the specified speed.

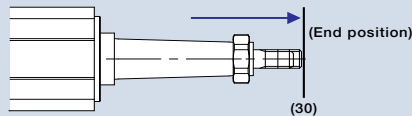

Input Signals

Input 0	OFF
Input 1	ON
Input 2	OFF
Input 3	-

When Input 1 is turned ON, the rod moves to the end position at the specified speed.

PIO Pattern 5 (Continuous Cycle Operation)

This PIO pattern involves continuous cycling between 2 positions—the end and home positions.

When Input 0 (continuous operation signal) is turned ON, the rod continuously moves between the specified 2 positions.

If Input 0 is turned OFF while in motion, it stops after reaching the current destination.

Positioning Motion

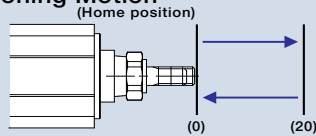

Input Signals

Input 0	ON
Input 1	-
Input 2	-
Input 3	-

When Input 0 is turned ON, the rod moves continuously between the end and home positions at the specified speed.

- Slider Type
- Mini
- Standard
- Controllers Integrated
- Rod Type
- Mini
- Standard
- Controllers Integrated
- Table/Arm /Flat Type
- Mini
- Standard
- Gripper/ Rotary Type
- Linear Servo Type
- Cleanroom Type
- Splash-Proof
- Controllers
- PMEC /AMEC
- PSEP /ASEP
- ROBO NET
- ERC2
- PCON
- ACON
- SCON
- PSEL
- ASEL
- SSEL
- XSEL
- Pulse Motor
- Servo Motor (24V)
- Servo Motor (200V)
- Linear Servo Motor

I/O Signal

Pin No.	Cable color	PIO pattern		0		1		2		3	4	5
		PIO pattern name		Standard 2-position motion		Speed change		Position change		2-input 3-position travel	3-input 3-position travel	Continuous cycle operation
		Solenoid type		Single	Double	Single	Double	Single	Double	-	-	-
1	Brown	COM		24V		24V		24V		24V	24V	24V
2	Red	COM		0V		0V		0V		0V	0V	0V
3	Orange	Input	0	ST0	ST0	ST0	ST0	ST0	ST0	ST0	ST0	ASTR
4	Yellow		1	*STP	ST1(-)	*STP	ST1(-)	*STP	ST1(-)	ST1	ST1(-)	-/*STP
5	Green		2	-(RES)	SPDC(RES)		CN1(RES)		-(RES)	ST2(RES)	-(RES)	-(RES)
6	Blue	Output	3	-/SON		-/SON		-/SON		-/SON	-/SON	-/SON
7	Purple		0	LS0/PE0		LS0/PE0		LS0/PE0		LS0/PE0	LS0/PE0	LS0/PE0
8	Grey		1	LS1/PE1		LS1/PE1		LS1/PE1		LS1/PE1	LS1/PE1	LS1/PE1
9	White		2	HEND/SV		HEND/SV		HEND/SV		LS2/PE2	LS2/PE2	HEND/SV
10	Black	3	*ALM/SV		*ALM/SV		*ALM/SV		*ALM/SV	*ALM/SV	*ALM/SV	

Note: The above signals marked with * are normally ON and turn OFF when active.

Specification Table

Item		Type					
Controller type		PSEP			ASEP		
		C	CW		C	CW	
Connected actuators		RCP2/RCP3 series actuator			RCA/RCA2/RCL series actuator		
Number of control axes		1					
Operating method		Positioner Type					
Number of positions		2 positions/3 positions (4 positions*2)					
Backup memory		EEPROM					
I/O connector		10 pin connector					
Number of I/O points		4 input points / 4 output points					
I/O power supply		External power supply DC24V±10%					
Dedicated type for serial communication		RS485 1ch					
Communication cable for peripheral equipment		CB-APSEP-PIO□□□□	CB-APSEP-W-PIO□□□□		CB-APSEP-PIO□□□□	CB-APSEP-W-PIO□□□□	
Position detection method		Incremental encoder (Attaching an absolute battery unit makes the simple absolute specification possible *3)					
Motor-encoder cable	For RCP2 connection	CB-PSEP-MPA□□□□			(Connection not possible)		
	For RCA connection	(Connection not possible)			CB-ASEP-MPA□□□□		
	For RCP3/RCA2 connection	CB-APSEP-MPA□□□□					
	For RCP2 mini rotary connection	CB-RPSEP-MPA□□□□			(Connection not possible)		
Input voltage		DC24V±10%					
Controlled power supply capacity		0.5A (0.8A for the simple absolute specification)					
Motor power capacity	Motor size	Rated value	Max.(*4)	Motor power output	Rated value	Maximum	
	20P	0.4A	2.0A	2W	0.8A	Power-saving (*5)	Standard (*6) high-acceleration / deceleration
	28P	0.4A	2.0A	5W	1.0A	Not specified	4.6A
	35P	1.2A	2.0A	10W (for RCL)	1.3A	Not specified	6.4A
	42P	1.2A	2.0A	10W (for RCA/RCA2)	1.3A	2.5A	4.4A
	56P	1.2A	2.0A	20W	1.3A	2.5A	4.4A
	-	-	-	20W (for 20S motor)	1.7A	3.4A	5.1A
-	-	-	30W	1.3A	2.2A	4.4A	
Inrush current (*1)		Max. 10A					
Amount of heat generated		8.4W			9.6W		
Dielectric strength voltage		DC500V 1MΩ					
Resistance to vibration		XYZ directions 10~57Hz One-side width 0.035mm (continuous), 0.075mm (intermittent) 58~150Hz 4.9m/s ² (continuous), 9.8m/s ² (intermittent)					
Ambient operating temperature		0~40°C					
Ambient operating humidity		10~85%RH (non-condensing)					
Ambient operating environment		No corrosive gases					
Protection level		IP20		IP53 (*7)		IP20	
Weight		About 130g		About 160g		About 130g	

(*1) Upon power-ON, an electrical current of 5 to 12 times as much as the rated current, called "in rush current" flows for 1 to 2 ms. Note that the amount of inrush current varies based on the impedance of power source lines.
 (*2) This applies to the case where two position data points are set at each of the end and home positions during a "position change" motion pattern process.
 (*3) The simple absolute type controllers cannot be used for the linear servo type.
 (*4) The current reaches its maximum level during the servo motor excitation phase detection performed during the initial servo ON process after the power has been turned on. (Usually: Approx. 1 to 2 seconds, max. 10 seconds.)
 (*5) When power to the motor is turned ON after shutting it OFF, current of about 6.0 A flows (for aprox.1~2ms).
 (*6) The max. value of current can be detected in the magnetic pole detection process or during collision or constraint. The condition continues for up to 10 seconds in the magnetic pole detection process. In this process the above current is required.
 (*7) The bottom surface is excluded.

495

PSEP / ASEP

Names

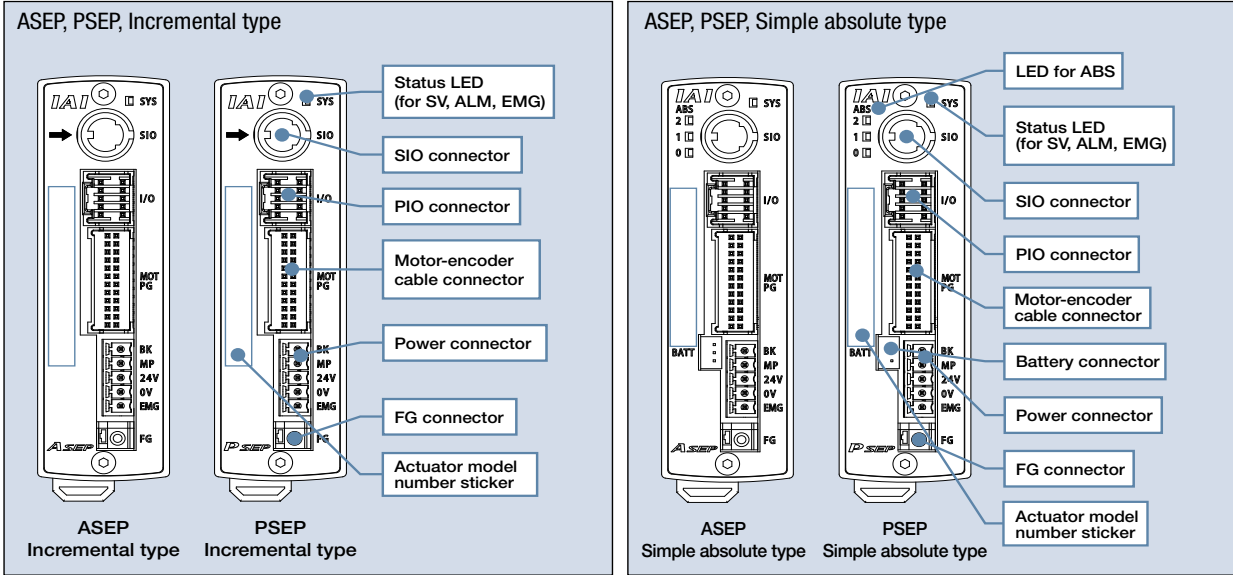

Outer dimensions

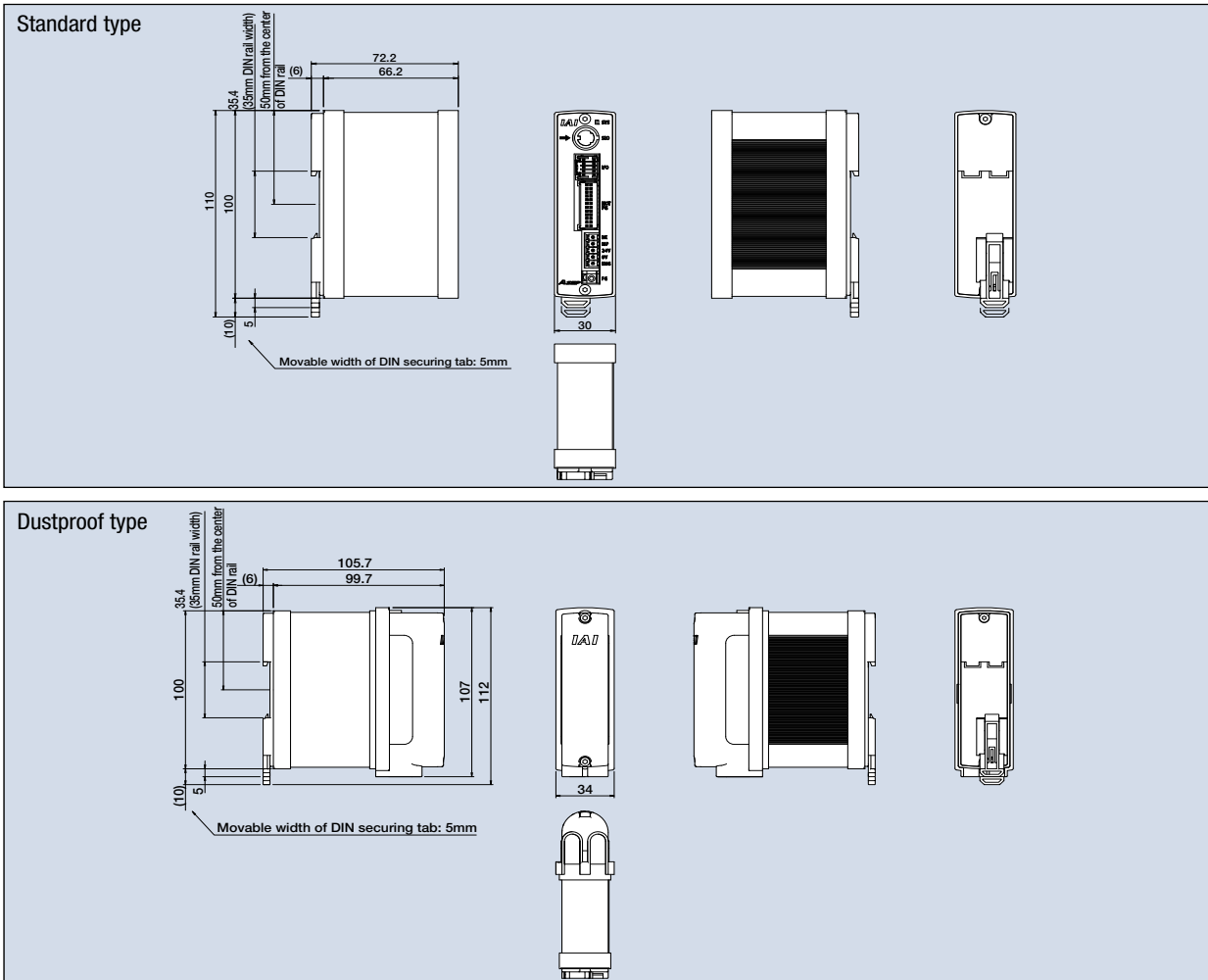

- Slider Type
- Mini
- Standard
- Controllers Integrated
- Rod Type
- Mini
- Standard
- Controllers Integrated
- Table/Arm /Flat Type
- Mini
- Standard
- Gripper/ Rotary Type
- Linear Servo Type
- Cleanroom Type
- Splash-Proof
- Controllers
- PMEC /AMEC
- PSEP /ASEP
- ROBO NET
- ERC2
- PCON
- ACON
- SCON
- PSEL
- ASEL
- SSEL
- XSEL
- Pulse Motor
- Servo Motor (24V)
- Servo Motor (200V)
- Linear Servo Motor



PSEP / ASEP **496**

Option

- Slider Type
- Mini
- Standard
- Controllers Integrated
- Rod Type
- Mini
- Standard
- Controllers Integrated
- Table/Arm/Flat Type
- Mini
- Standard
- Gripper/Rotary Type
- Linear Servo Type
- Cleanroom Type
- Splash-Proof
- Controllers
- PMEC/AMEC
- PSEP/ASEP
- ROBO NET
- ERC2
- PCON
- ACON
- SCON
- PSEL
- ASEL
- SSEL
- XSEL
- Pulse Motor
- Servo Motor (24V)
- Servo Motor (200V)
- Linear Servo Motor

Touch Panel Teaching Pendant for Position Controller

- **Feature 1** A data input device with an intuitive touch panel menu screen that is easy to operate, even for first-time users. You can use it to configure settings such as home / end positions, intermediate position, speed, and pushing force, or to run an adjustment operation such as jogging, inching, and moving to a specified position.
- **Feature 2** Intuitive and interactive touch panel menus allow for easy configuration, even for first-time users.

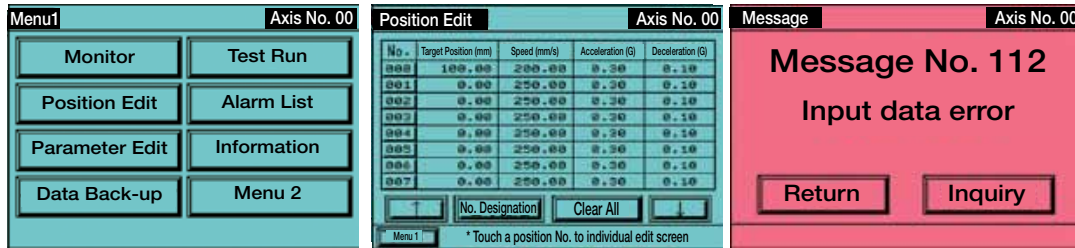

Large, easy to read display

Easy configuration with the touch panel

Backlight color changes when an error occurs

Model & Specifications

Item	Description			
Model	CON-PT-M-ENG	CON-PD-M-ENG	CON-PG-M-S-ENG	SEP-PT-ENG
Type	Standard type	Enable switch type	Safety compliant type	SEP controller dedicated type
Connectible controllers	PSEP/PCON/RPCON ASEP/ACON/RACON SCON/ERC2 (*)			PSEP ASEP
3-position enable switch	x	○	○	x
Functions	Input and edit position data Movement functions (move to specified position, jog, inch) Test input and output signals Edit parameters			
Display	3-color LED with backlight			
Operating ambient temp./Humidity	0~50°C 20~85% RH (non-condensing)			
Environmental resistance	IP40			
Weight (incl. 5m cable)	Approx. 750g	Approx. 780g	Approx. 780g	Approx. 550g
Accessories	• Touch pen	• Touch pen	• TP Adapter (Model: RCB-LB-TG) • Dummy Plug (Model: DP-4) • Controller connection cable (Model: CB-CON-LB005) • Touch pen	• Touch pen
Standard Price	-	-	-	-

(*) If an ERC2 type controller does not have "4904" on the serial number label, it cannot be connected.

Caution: If you have a "CON" type controller (i.e. PCON, RPCON, ACON, RACON, SCON, ERC2) and an "SEP" type controller (PSEP or ASEP) linked together, you cannot connect the teaching pendant to it.

Absolute battery unit for SEP controllers

Names of Parts/
Exterior
Dimensions

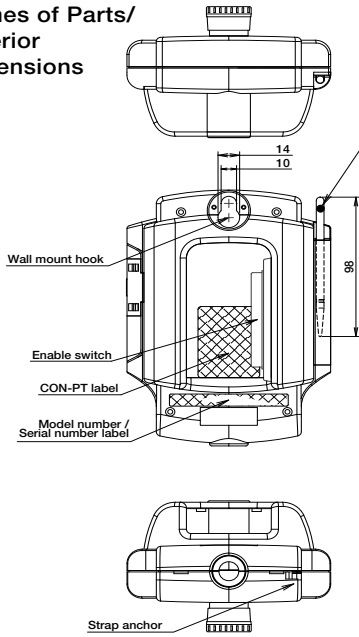

Option

- Strap Model STR-1

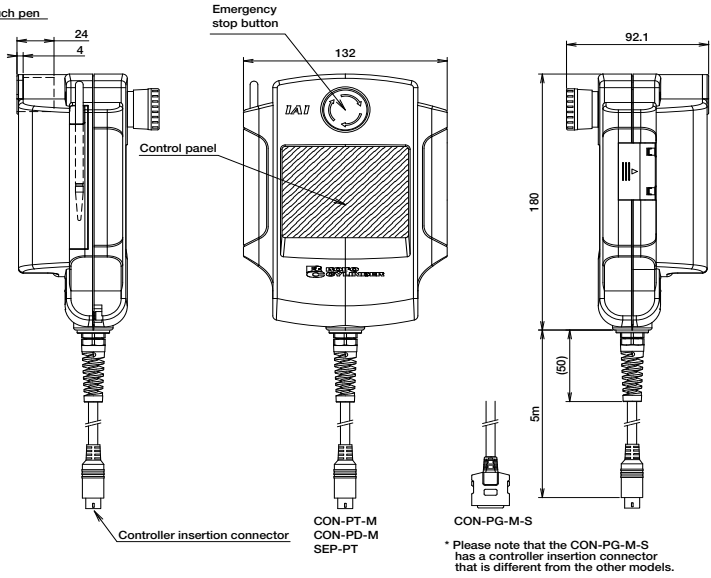

CON-PG-M-S Wiring Drawing

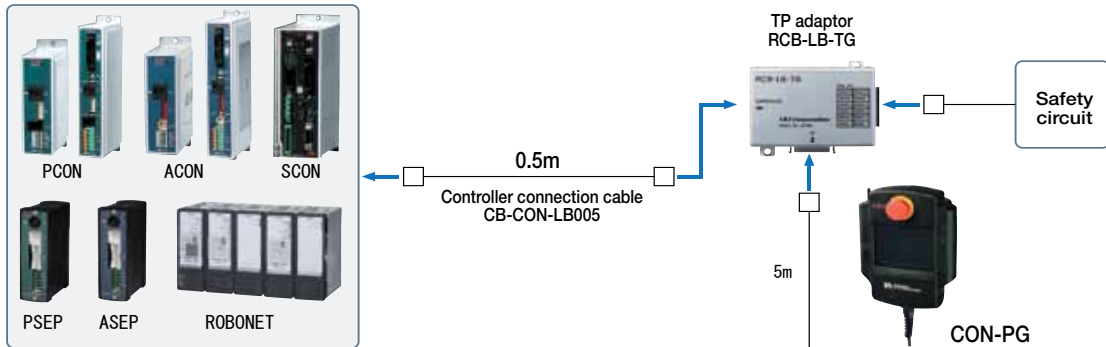

- Slider Type
- Mini
- Standard
- Controllers Integrated
- Rod Type
- Mini
- Standard
- Controllers Integrated
- Table/Arm /Flat Type
- Mini
- Standard
- Gripper/ Rotary Type
- Linear Servo Type
- Cleanroom Type
- Splash-Proof
- Controllers
- PMEC /AMEC
- PSEP /ASEP
- ROBO NET
- ERC2
- PCON
- ACON
- SCON
- PSEL
- ASEL
- SSEL
- XSEL

- Pulse Motor
- Servo Motor (24V)
- Servo Motor (200V)
- Linear Servo Motor

Option

PC Software (Windows Only)

- Features** A startup support software for inputting positions, performing test runs, and monitoring. With enhancements for adjustment functions, the startup time is shortened.

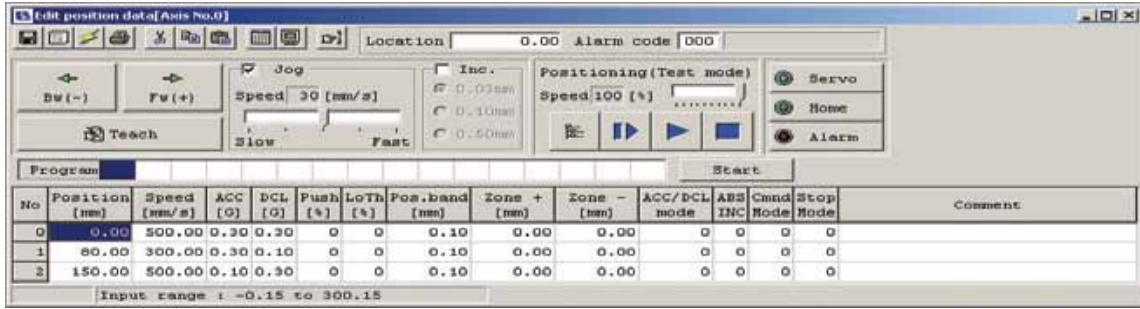

- Model RCM-101-MW**
 (External device communication cable + RS232 conversion unit)

Configuration

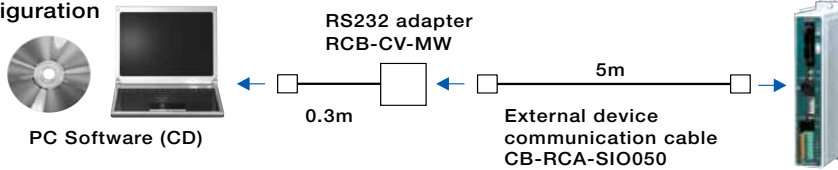

- Model RCM-101-USB**
 (External device communication cable + USB adapter + USB cable)

Configuration

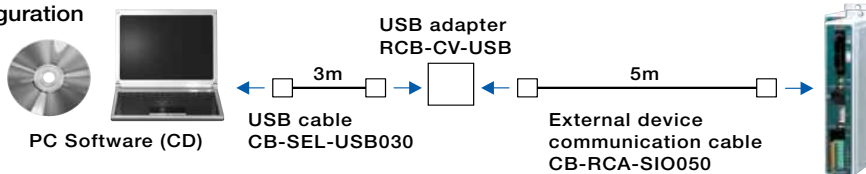

- Slider Type
- Mini
- Standard
- Controllers Integrated
- Rod Type
- Mini
- Standard
- Controllers Integrated
- Table/Arm /Flat Type
- Mini
- Standard
- Gripper/ Rotary Type
- Linear Servo Type
- Cleanroom Type
- Splash-Proof
- Controllers
- PMEC /AMEC
- PSEP /ASEP
- ROBO NET
- ERC2
- PCON
- ACON
- SCON
- PSEL
- ASEL
- SSEL
- XSEL
- Pulse Motor
- Servo Motor (24V)
- Servo Motor (200V)
- Linear Servo Motor

Absolute battery unit for SEP controllers

- Description** Supplied with the PSEP and ASEP simple absolute controllers. This is a battery unit used for backing up the current position data.
- Model** **SEP-ABU (standard type)**
SEP-ABU-W (dustproof type)

Specifications

Item	Specifications			
Ambient operating temp./Humidity	0~40°C (around 20°C preferred), 95% RH or below (non-condensing)			
Ambient operating environment	No corrosive gases			
Absolute battery (*1)	Model: AB-7 (Ni-MH battery/Approx. 3-year life)			
Controller-absolute battery unit cable (*1)	Model: CB-APSEP-AB005 (0.5m long)			
Weight	Standard type: Approx. 230g; Dustproof type: Approx. 260g			
Allowable encoder RPM during data retention (*2)	800rpm	400rpm	200rpm	100rpm
Position data retention duration (*2)	120h	240h	360h	480h

(*1) The absolute battery unit comes with a cable to connect the controller and the absolute battery unit.
 (*2) Position data retention time changes with the allowable encoder RPMs during data retention.
 (800rpm→120h, 400rpm→240h, 200rpm→360h, 100rpm→480h)

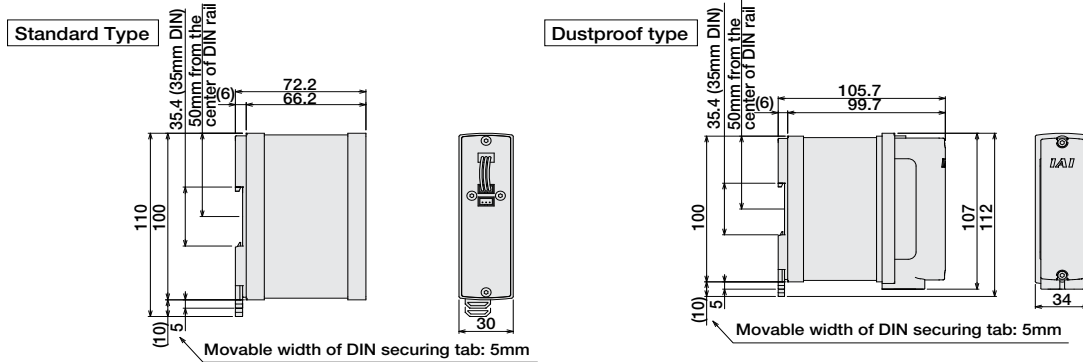

Cautions on Controllers and Options

- When mounting the controller to a DIN rail, use the supplied spacer between the controllers to prevent them from contacting each other, to deal with heat dissipation. (See Fig. 1)
 - When mounting the absolute battery units and controllers, place the absolute battery units below the controllers. (See Fig. 2)
- If there is not enough space below the controllers, mount the absolute battery units in such a way that the temperature around the controllers stays at 40°C or below.

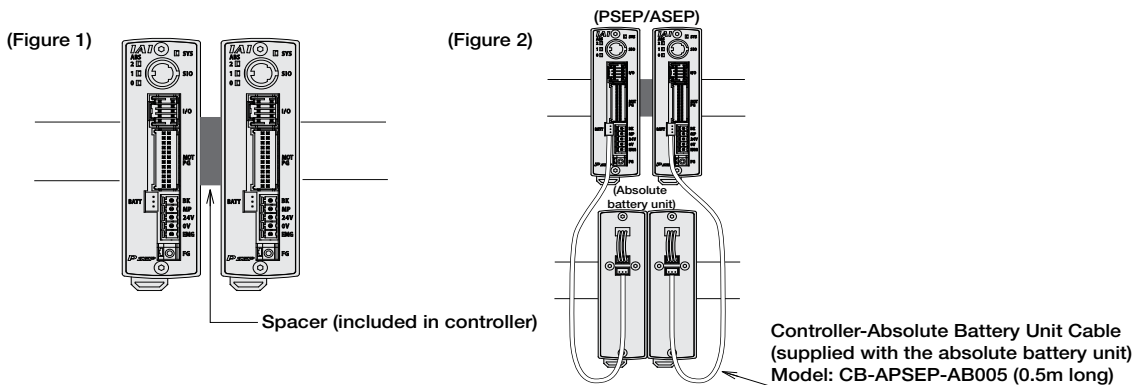

- Teaching pendants for PCON, ACON, and SCON (e.g. CON-T, RCM) cannot be used with PSEP or ASEP. For PSEP and ASEP, use the SEP-PT.
- The SEP-PT cannot communicate to the linked controllers. (Please connect them directly to the controller.)



PSEP / ASEP **500**

- Slider Type
- Mini
- Standard
- Controllers Integrated
- Rod Type
- Mini
- Standard
- Controllers Integrated
- Table/Arm /Flat Type
- Mini
- Standard
- Cripper/ Rotary Type
- Linear Servo Type
- Cleanroom Type
- Splash-Proof
- Controllers
- PMEC /AMEC
- PSEP /ASEP
- ROBO NET
- ERC2
- PCON
- ACON
- SCON
- PSEL
- ASEL
- SSEL
- XSEL
- Pulse Motor
- Servo Motor (24V)
- Servo Motor (200V)
- Linear Servo Motor

Spare parts

When you need spare parts after purchasing the product, such as when replacing a cable, refer to the list of models below.

Motor-encoder integrated cable for connecting [RCP3/RCA2/RCL] and [PSEP/ASEP]

Model **CB-APSEP-MPA**

* Enter the cable length (L) into . Compatible to a maximum of 20 meters.
Ex. 080 = 8m

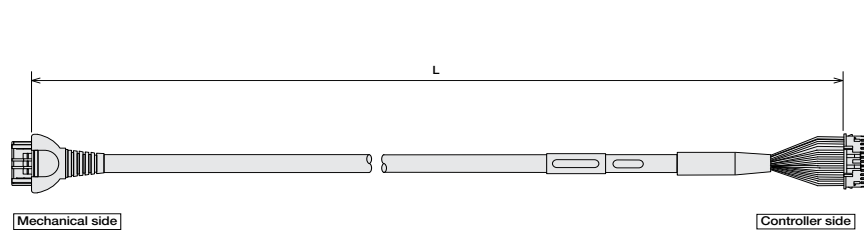

Min. bend radius $r = 68$ mm or larger (when movable type is used)

Mechanical side	(PCON) (ACON)	Controller side
Pin number		Pin number
A1	Black [ΦA](U)	1
B1	White [VM] (V)	2
A2	Brown [ΦA](W)	3
B2	Green [ΦB](-)	4
A3	Yellow [VM] (I)	5
B3	Red [ΦB](+)	6
A4	Orange [LS-] (BK+)	7
B4	Gray [LS-] (BK-)	8
A5	White [A+] (A+)	9
B5	Yellow [A-] (A-)	10
A7	Red [A+] (B+)	11
B7	Green [A-] (B-)	12
A8	Black [B+] (Z+)	13
B8	Brown [B-] (Z-)	14
A5	Black (label) [BK+] (LS+)	15
B5	Brown (label) [BK-] (LS-)	16
A9	Green (label) [GND] (LS)	17
B9	Red (label) [VPS] (VPS)	18
A10	White (label) [VCC] (VCC)	19
B10	Yellow (label) [GND] (GND)	20
A11	NC	21
B11	Shield [FG] (FG)	22
	NC	23
	NC	24

Motor-encoder integrated cable for connecting [RCP2] and [PSEP]

Model **CB-PSEP-MPA**

* Enter the cable length (L) into . Compatible to a maximum of 20 meters.
Ex. 080 = 8m

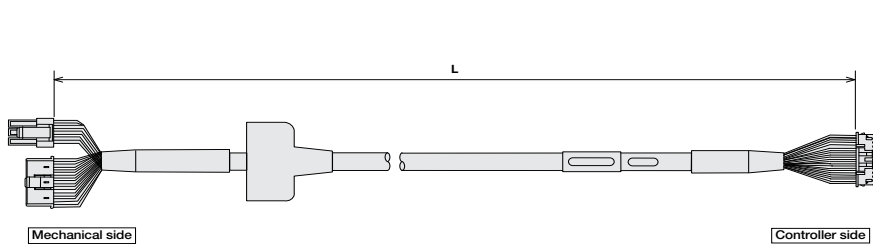

Min. bend radius $r = 68$ mm or larger (when movable type is used)

Mechanical side		Controller side
Pin number		Pin number
1	Black [ΦA]	1
2	White [VM] (V)	2
4	Green [VM] (I)	3
5	Brown [ΦA]	4
3	Brown [ΦA]	5
6	Yellow [ΦB]	6
16	Orange [BK+] (LS+)	7
17	Gray [BK-] (LS-)	8
5	NC	9
8	NC	10
13	Black [LS+] (A+)	11
14	Brown [LS-] (A-)	12
1	White [A+] (B+)	13
2	Yellow [A-] (B-)	14
3	Red [B+] (Z+)	15
4	Green [B-] (Z-)	16
10	White (label) [VCC] (VCC)	17
11	Yellow (label) [VPS] (VPS)	18
9	Red (label) [GND] (GND)	19
12	Green (label) (spare)	20
15	NC	21
7	NC	22
8	NC	23
18	Shield [FG] (FG)	24

Motor-encoder integrated type cable for RCP3/RCP2 (Limited to RCP2-GRSS/GRLS/GRST/SRA4R/SRGS4R/SRGD4R types)

Model **CB-PCS-MPA**

* Enter the cable length (L) into . Compatible to a maximum of 20 meters.
Ex. 080 = 8m

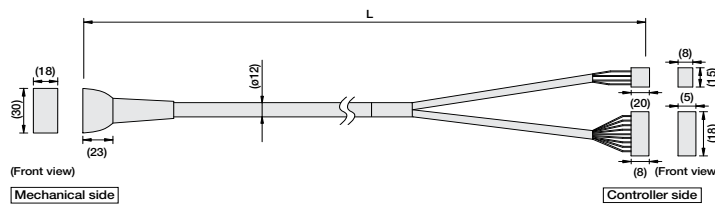

Min. bend radius $r = 84$ mm or larger (when movable type is used)

Pin Number	Signal	(Wire color)	Signal	Pin Number
A1	A	Black	A	B1
B1	VMM	White	VMM	A2
A2	/A	Red	/A	A1
B2	B	Green	B	B3
A3	VMM	Yellow	VMM	B2
B3	/B	Brown	/B	A3
A4	NC			
B4	BK+	Pink (Red ●)	BK+	14
A5	BK-	Pink (Blue ●)	BK-	13
B5	BK-	White (Red ●)	LS+	16
A6	LS+	White (Blue ●)	LS-	15
B6	LS-	Orange (Red ●)	A+	12
A7	A+	Orange (Blue ●)	A-	11
B7	A-	Gray (Red ●)	B+	10
A8	B+	Gray (Blue ●)	B-	9
B8	B-		NC	8
A9	NC		VPS	7
B9	VPS	Orange (Blue ● Consecutive)	VCC	6
A10	VCC	Gray (Red ● Consecutive)	GND	5
B10	GND	Gray (Blue ● Consecutive)	NC	4
A11	NC		FG	1
B11	FG	Shield		

Motor-encoder integrated cable for connecting [RCA] and [ASEP]

Model **CB-ASEP-MPA**

* Enter the cable length (L) into . Compatible to a maximum of 20 meters.
Ex. 080 = 8m

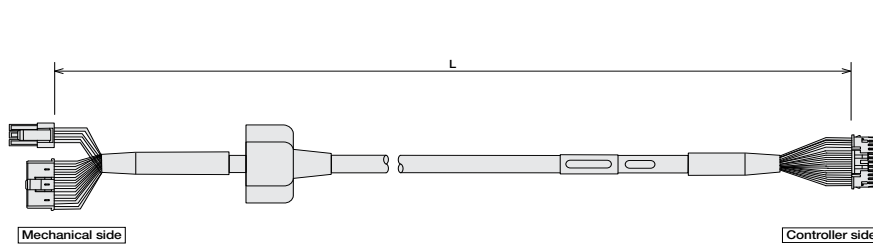

Min. bend radius $r = 68$ mm or larger (when movable type is used)

Mechanical side		Controller side
Pin number		Pin number
1	Red [U]	1
2	Yellow [V]	2
	NC	3
3	NC	4
	Black [W]	5
	NC	6
18	Orange [BK+] (LS+)	7
17	Gray [BK-] (LS-)	8
7	Black [LS+] (A+)	9
16	Brown [LS-] (A-)	10
1	White [A+] (B+)	11
2	Yellow [A-] (B-)	12
3	Red [B+] (Z+)	13
4	Green [B-] (Z-)	14
10	Black (label) [Z+] (Z+)	15
11	Brown (label) [Z-] (Z-)	16
14	White (label) [VCC] (VCC)	17
13	Yellow (label) [VPS] (VPS)	18
15	Red (label) [GND] (GND)	19
6	Green (label) (spare)	20
5	NC	21
8	NC	22
12	NC	23
9	Shield [FG] (FG)	24

501

PSEP / ASEP

Motor-encoder integrated cable for connecting [RCA2/RCL] and [ACON/RACON/ASEL]

Model **CB-ACS-MPA**

* Enter the cable length (L) into . Compatible to a maximum of 20 meters.
Ex. 080 = 8m

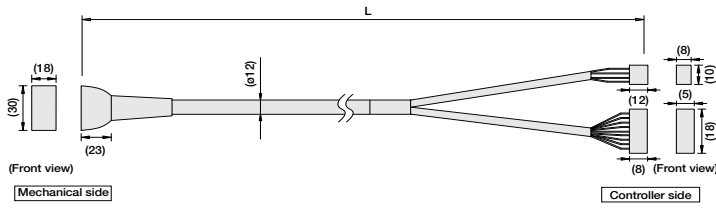

Min. bend radius r = 84 mm or larger (when movable type is used)

Pin Number	Signal	(Wire color)	Signal	Pin Number
A1	U	Red	U	2
B1	V		V	2
A2	W	Black	W	3
B2	NC			
A3	NC			
B3	NC			
A4	BK-	Yellow (Red ●)	BK+	16
B4	BK-	Yellow (Blue ●)	BK-	15
A5	LS+	Pink (Red ●)	LS+	18
B5	LS+	Pink (Blue ●)	LS-	17
A6	A+	White (Red ●)	A+	14
B6	A-	White (Blue ●)	A-	13
A7	B+	Orange (Red ●)	B+	12
B7	B-	Orange (Blue ●)	B-	11
A8	Z+	Gray (Red ●)	Z+	10
B8	Z-	Gray (Blue ●)	Z-	9
A9	-	Orange (Red ● Consecutive)	-	8
B9	/PS	Orange (Blue ● Consecutive)	/PS	7
A10	VCC	Gray (Red ● Consecutive)	VCC	6
B10	GND	Gray (Blue ● Consecutive)	GND	5
A11	NC		NC	
B11	FG		FG	1

Motor-encoder integrated cable for connecting [RCP2 mini rotary] and [PSEP]

Model **CB-RPSEP-MPA**

* Enter the cable length (L) into . Compatible to a maximum of 20 meters.
Ex. 080 = 8m

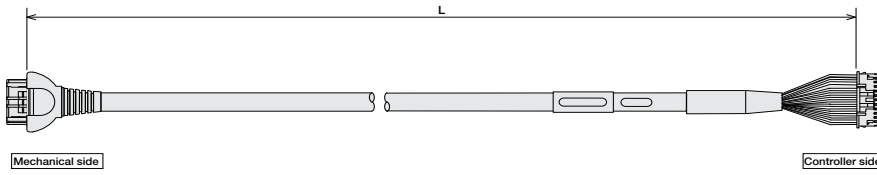

Min. bend radius r = 68 mm or larger (when movable type is used)

Mechanical side	Pin number	Signal	Controller side	Pin number
A1		Black [0A]		1
B1		White [VMM]		2
A2		Brown [0/A]		5
B2		Green [0B]		3
A3		Yellow [VMM]		4
B3		Red [0/B]		6
A6		Orange [LS+]		7
B6		Gray [LS-]		8
A7		Red [A+]		13
B7		Green [A-]		14
A8		Black [B+]		15
B8		Brown [B-]		16
A4		NC		7
B4		NC		8
A5		Black [label] [BK+]		9
B5		Brown [label] [BK-]		10
A9		Green [label] [CHDLS]		20
B9		Red [label] [VPS]		18
A10		White [label] [VCC]		17
B10		Yellow [label] [GND]		19
A11		NC		21
B11		Shield [FG] [FG]		24
		NC		22
		NC		23

I/O cable for PSEP-C/ASEP-C

Model **CB-APSEP-PIO**

* Enter the cable length (L) into . Compatible to a maximum of 10 meters.
Ex. 080 = 8m

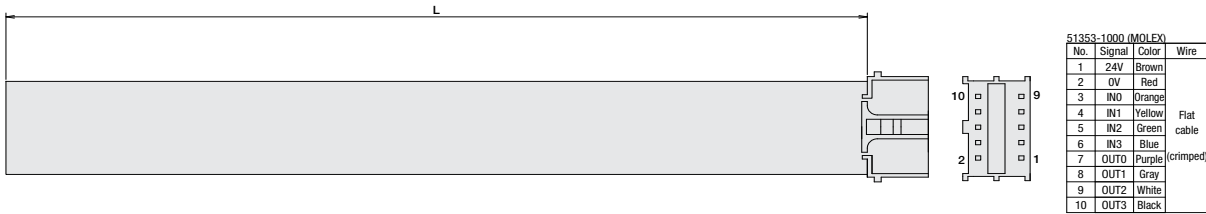

I/O cable for PSEP-CW/ASEP-CW

Model **CB-APSEPW-PIO**

* Enter the cable length (L) into . Compatible to a maximum of 10 meters.
Ex. 080 = 8m

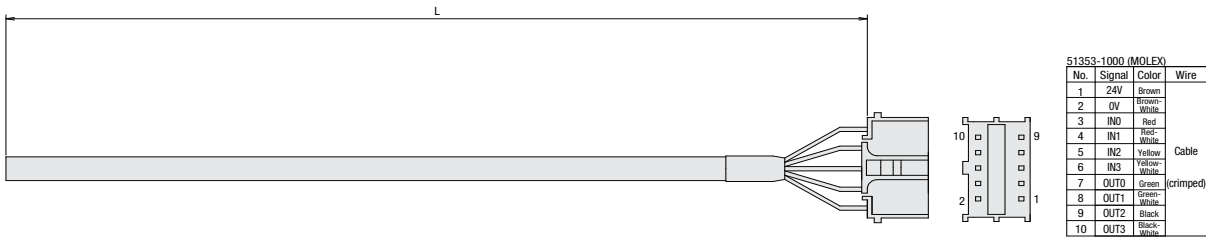

- Slider Type
- Mini
- Standard
- Controllers Integrated
- Rod Type
- Mini
- Standard
- Controllers Integrated
- Table/Arm /Flat Type
- Mini
- Standard
- Controllers Integrated
- Table/Arm /Flat Type
- Mini
- Standard
- Gripper/ Rotary Type
- Linear Servo Type
- Cleanroom Type
- Splash-Proof
- Controllers
- PMEC /AMEC
- PSEP /ASEP
- ROBO NET
- ERC2
- PCON
- ACON
- SCON
- PSEL
- ASEL
- SSEL
- XSEL
- Pulse Motor
- Servo Motor (24V)
- Servo Motor (200V)
- Linear Servo Motor