



Quality and Innovation

Program Controller
for ROBO Cylinder
RCP5/RCP4/RCP3/RCP2

MSEL-PC/PG

Powerful & Multifunctional



Sold & Serviced By:
 ELECTROMATE

Toll Free Phone (877) SERV098
Toll Free Fax (877) SERV099
www.electromate.com
sales@electromate.com

Introducing the ROBO Cylinder 4-axis Program Controller MSEL with High-output Driver (PowerCON)



1 Control Maximum of 4 Axes Available with Pulse Motor Mounted ROBO Cylinder

Actuators with pulse motor in the past were able to control only up to two axes at maximum with one program controller. By using MSEL, four axes will be available for control. It is also available for interpolation operation, which enhances the ways of use.

Example of Combinations

3-axis Cartesian (Pulse Motor)

RCP5

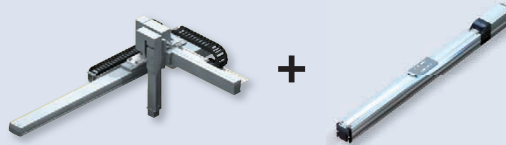

Available to Connect 4 Axes at Maximum

2 Available to Connect ROBO Cylinders RCP5 and RCP4

By applying to PowerCON, it is now possible to perform interpolation operation with ROBO Cylinders RCP5 and RCP4, which are applicable for high-output driver, but were not feasible with the program controller PSEL in the past.



3 Greatly Enhanced Programming Feature

The feature has been greatly upgraded with four times as many programs and twenty times as many positions compared to our products (PSEL) in the past.

	Conventional product PSEL		New product MSEL
Number of programs	64	4 times →	255
Number of program steps	2,000	5 times →	9,999
Number of multi-tasking programs	8	2 times →	16
Number of positions	1,500	20 times →	30,000 (*1)

(*1) Note that the number of points available for backup in system memory is 10,000 points.

4 Equipped with Expansion I/O Slot

In addition to the standard IO (IN 16 points / OUT 16 points), one slot is available as the expansion I/O slot. The expansion I/O is available to select from PIO (IN 16 points / OUT 16 points) and four types of field network.

	Conventional product PSEL	New product MSEL
Max. I/O Input and Output Points	24/8 Not applicable for expansion	32/32 When expansion slot used
Field Network	3 types (CC-Link, DeviceNet, PROFIBUS-DP)	4 types (CC-Link, DeviceNet, PROFIBUS-DP, EtherNet/IP)
Other External Connections	RS232C: 1ch	RS232C: 1ch

5 Cable and Cost Reduction

In 4-Axis Controlling of Actuator

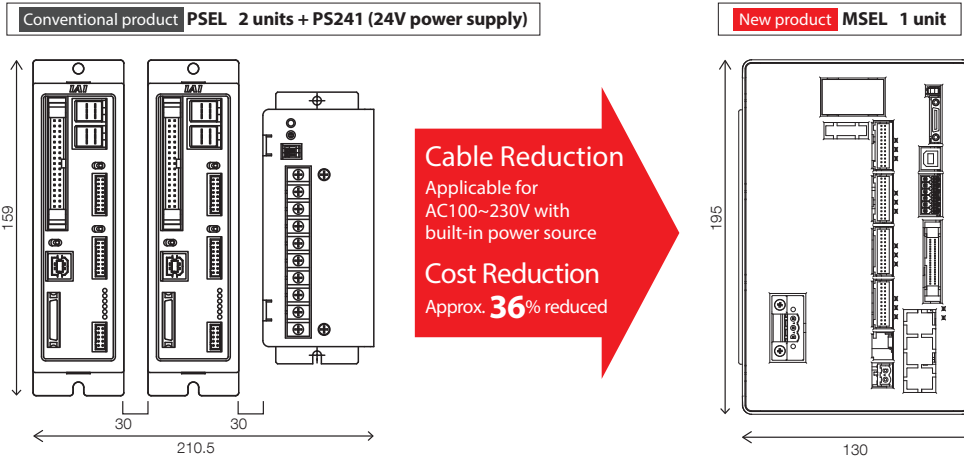

6 Safety Category Applicable Type Introduced in Lineup (Applicable for Category 3)

MSEL-PG is applicable for Safety Category 3.

(To apply with Safety Category, it is necessary that the user establish a safety circuit out of the controller.)

7 Applicable for Various Models

It is now compatible with pulse motor type ROBO Cylinders RCP5 / RCP4 / RCP3 / RCP2.



System Configuration

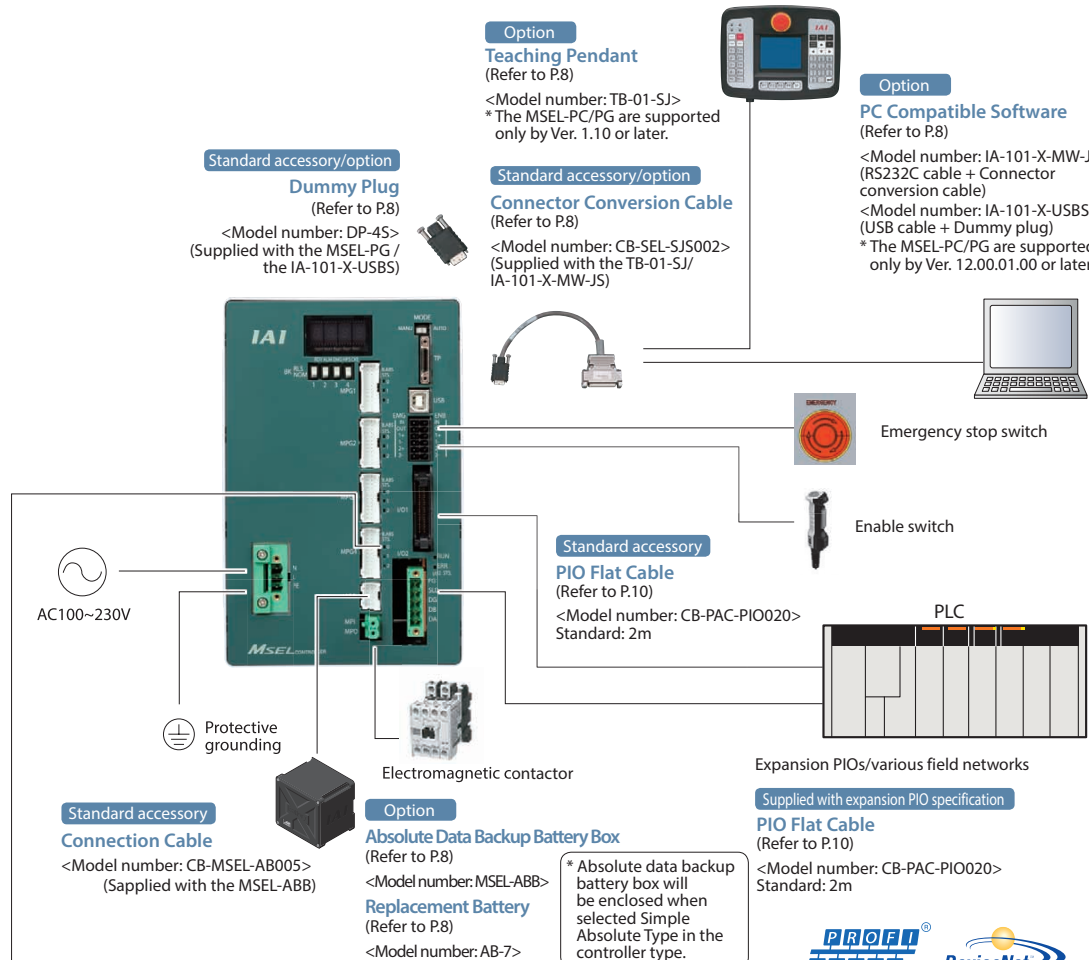

* Wire the emergency stop switch, enable switch, electromagnetic contactor, etc., as necessary. The same applies to the factory settings (shorting).

<Connectable Actuators>

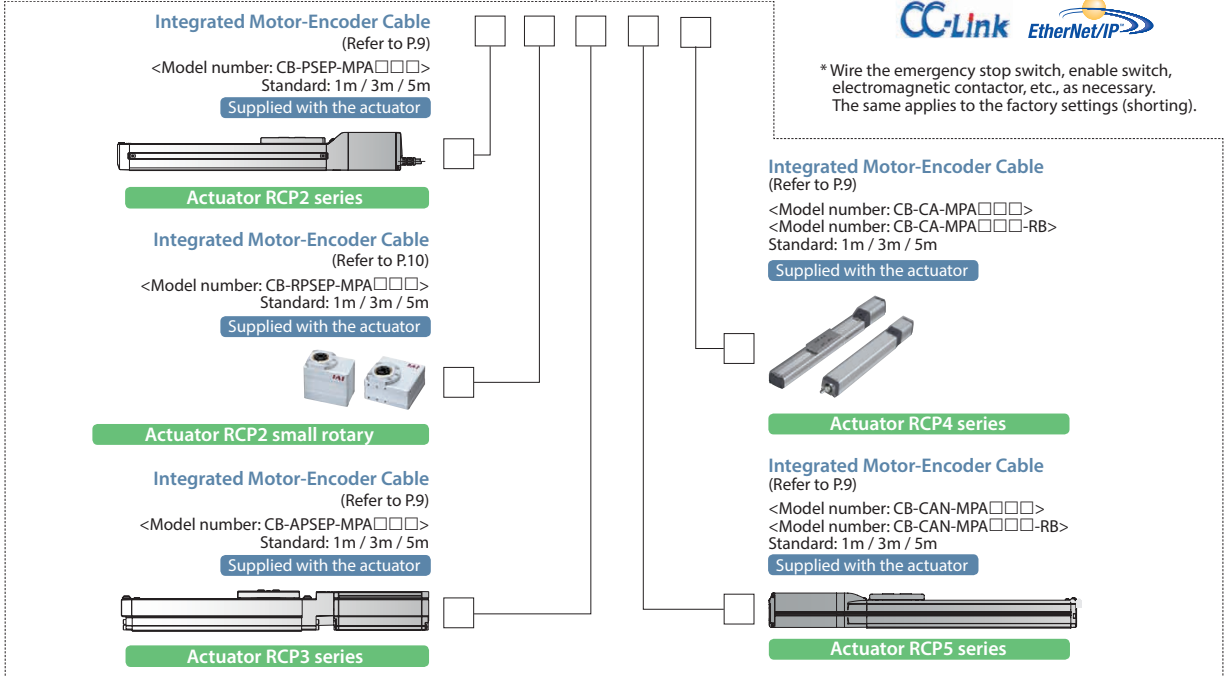

Basic Controller Specifications

Specification item		Contents	
Power-supply input voltage		Single-phase AC100~230V ±10%	
Power-supply current		2.9A typ. (AC100V), 1.4A typ. (AC200V), 1.2A typ. (AC230V)	
Power-supply frequency range		50/60Hz ±5%	
Motor type		Pulse motor (servo control)	
Supported encoder		Incremental encoder / Battery-less absolute encoder	
Data storage device		FlashROM/FRAM	
Number of program steps		9,999	
Number of positions		30,000	
Number of programs		255	
Number of multitasks		16	
Operation mode	Serial communications	<input type="radio"/>	
	Program	<input type="radio"/>	
SIO interface	Communication method	RS232 (asynchronous communications)	
	Baud rate	9.6, 19.2, 38.4, 57.6, 76.8, 115.2kbps	
	Live wire connection	TP port	<input checked="" type="checkbox"/>
		USB	<input type="checkbox"/>
Standard PIO interface	Input specification	Number of input points	16 points
		Input voltage	DC24V ±10%
		Input current	7mA/circuit
		ON voltage	Min.DC16V
		OFF voltage	Max.DC5V
		Leak current	Allowable leak current: 1mA max.
	Output specification	Insulation method	Photocoupler insulation
		Number of output points	16 points
		Load voltage	DC24V ±10%
		Maximum current	100mA/point, 400mA/8 points (Note 1)
		Saturated voltage	Max.3V
		Leak current	Max.0.1mA
Insulation method	Photocoupler insulation		
Compliant expansion I/O interface		Expansion PIO NPN specification (16IN/16OUT)	
		CC-Link (remote device station)	
		DeviceNet	
		PROFIBUS-DP	
		EtherNet/IP	
Calendar/clock function	Retention time	Approx. 10 days	
	Charge time	Approx. 100 hours (fully charged) * Data can be retained even when the batteries are not fully charged.	
Protective functions		Overcurrent, abnormal temperature, fan speed low monitoring, encoder disconnection, etc.	
Operating temperature range		0~40°C	
Operating humidity range		85% RH max. (non-condensing, non-freezing)	
Installation	Installation direction	Installed vertically (exhaust side up)	
	Installation method	Mounted with screws or using a DIN rail	
Rush current		15A typ. (AC100V), 30A typ. (AC200V): 5ms max. (Ambient temperature 25°C/No cycling of the power)	
Air cooling method		Forced air cooling	
External dimensions		Width 130mm x Height 195mm x Depth 125mm	
Mass		Approx. 1,400g	

Note 1: The total load current shall be 400mA for every eight points from standard I/O No. 316. (The maximum current per point shall be 100mA.)

PIO Signal Chart

Pin Layouts for Standard PIO Connector/Expansion PIO Connector

Pin No.	Category	Assignment	Pin No.	Category	Assignment
1A	24V	P24	1B	Output	OUT0
2A	24V	P24	2B		OUT1
3A	—	—	3B		OUT2
4A	—	—	4B		OUT3
5A	Input	IN0	5B		OUT4
6A		IN1	6B		OUT5
7A		IN2	7B		OUT6
8A		IN3	8B		OUT7
9A		IN4	9B		OUT8
10A		IN5	10B		OUT9
11A		IN6	11B		OUT10
12A		IN7	12B		OUT11
13A		IN8	13B		OUT12
14A		IN9	14B		OUT13
15A		IN10	15B		OUT14
16A		IN11	16B	OUT15	
17A		IN12	17B	—	
18A		IN13	18B	—	
19A		IN14	19B	0V	N
20A	IN15	20B	0V	N	

Internal Circuits for Standard I/Os (NPN Specifications)

[Input section] External input specifications (NPN specifications)

Item	Specifications
Input voltage	DC24V ±10%
Input current	7mA/circuit
On/Off voltage	On voltage...Min. DC16.0V, Off voltage...Max. DC5.0V
Insulation method	Photocoupler insulation

* The port numbers in the circuit diagram below represent the factory-set port numbers.
 * When the input is off, the allowable leak current is 1mA max.

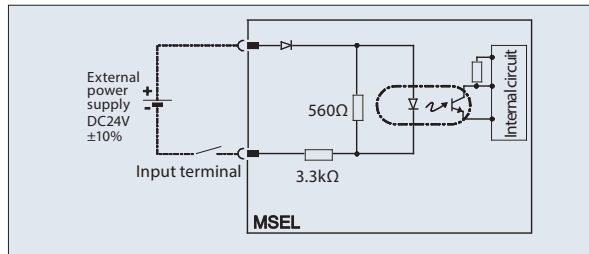

* For the standard IOs (PNP specifications), refer to the operation manual.

[Output section] External output specifications (NPN specifications)

Item	Specifications	Uses
Load voltage	DC24V ±10%	TD62084 (or equivalent).
Maximum load current	100mA/point, 400mA/8 points (Note)	
Leak current	Max. 0.1mA/point	
Insulation method	Photocoupler insulation	

* The port numbers in the circuit diagram below represent the factory-set port numbers.
 Note: The total load current shall be 400 mA for every eight points from standard I/O No. 316. (The maximum current per point shall be 100mA.)

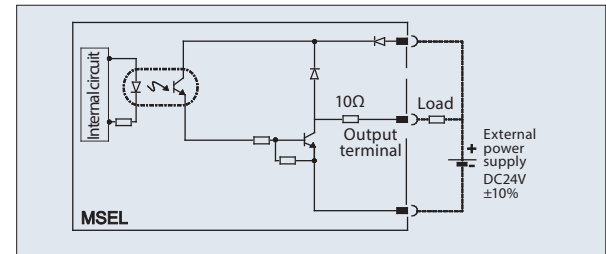

Internal Circuits for Expansion I/Os (NPN Specifications)

[Input section] External input specifications

Item	Specifications
Number of input points	16 points
Input voltage	DC24V ±10%
Input current	4mA/circuit
On/Off voltage	On voltage...Min. DC18V (3.5mA) Off voltage...Max. DC6V (1mA)
Insulation method	Photocoupler insulation

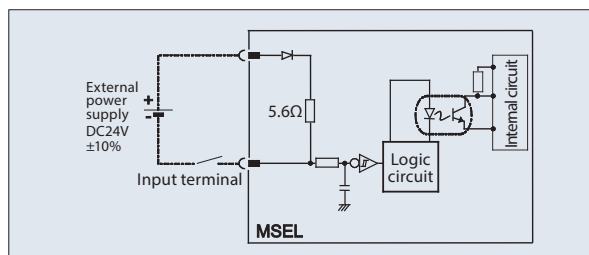

[Output section] External output specifications

Item	Specifications
Number of output points	16 points
Rated load current	DC24V ±10%
Maximum current	50mA/circuit
Insulation method	Photocoupler insulation

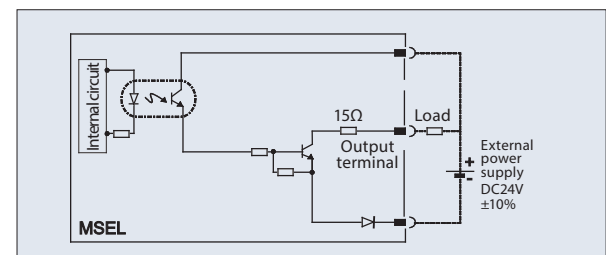

Name of Each Part

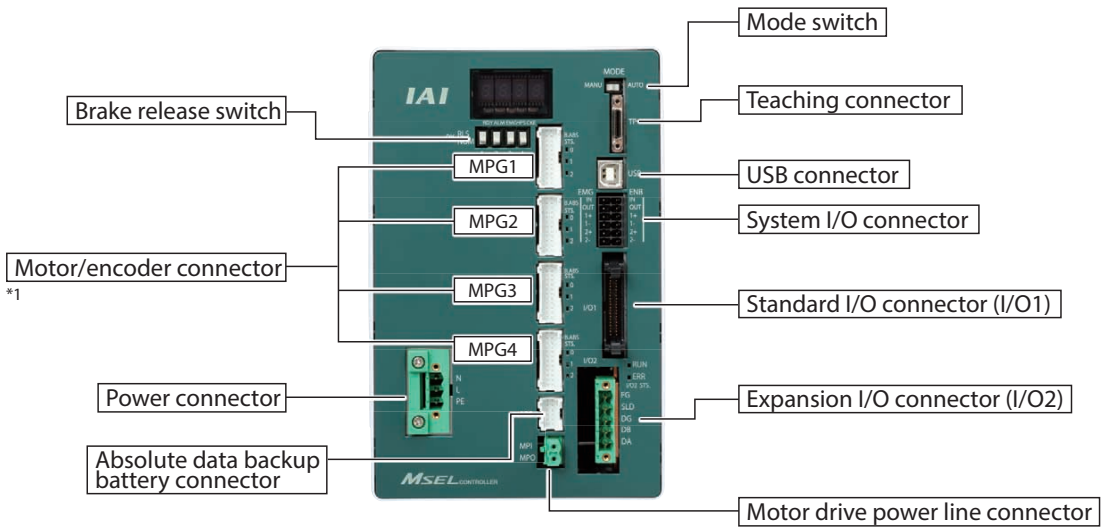

*1: Do not connect a wrong motor to the MPG1, MPG2, MPG3 or MPG4 connector. It may cause malfunction or failure.

External Dimensions

Controller

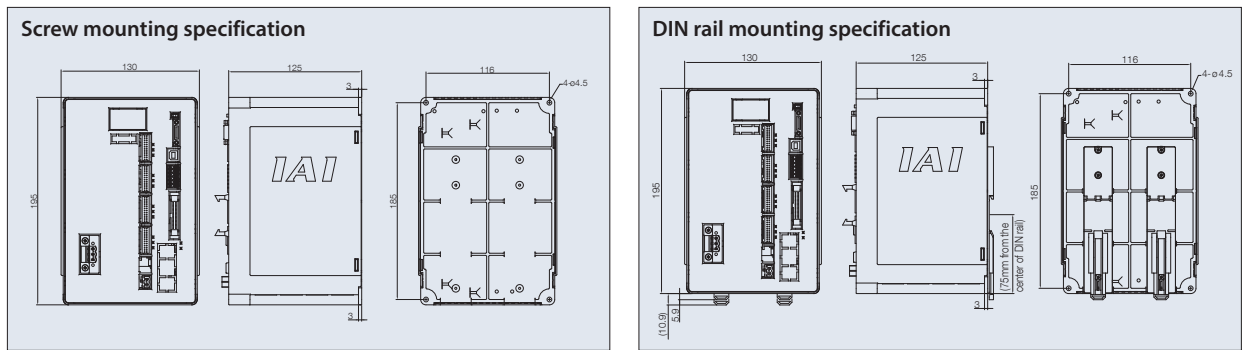

Absolute Data Backup Battery Box

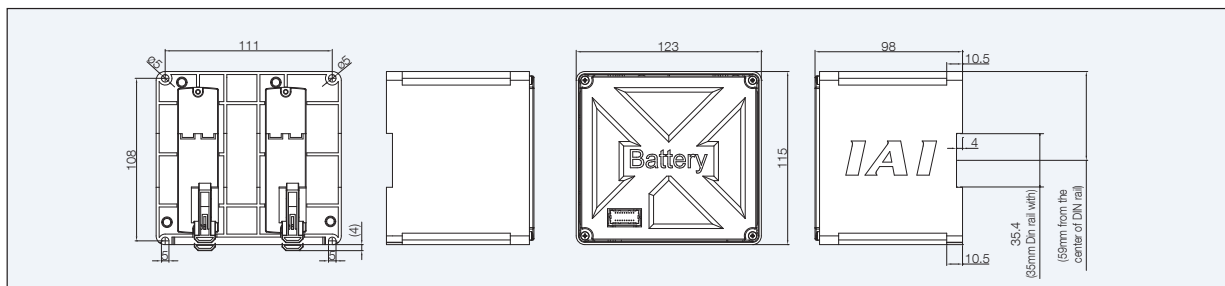

Options

Teaching Pendant

Features

A teaching device offering program/position input, trial operation and monitoring functions.

Model number **TB-01-SJ**

* This model is the standard specification with connector conversion cable. If you are interested in the deadman switch specification, specify the model number of the applicable teaching pendant (TB-01D-N/TB-01DR-N) and that of the cable (CB-TB1-X050-JS).

Configuration

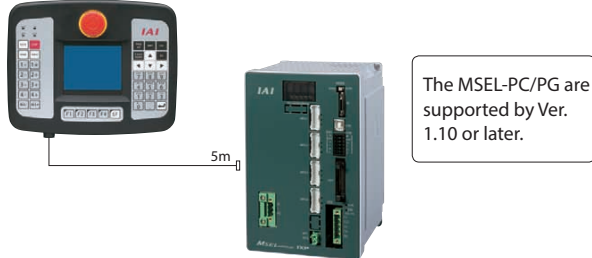

Dummy Plug

Features

This plug is required for the safety category specification (MSEL-PG) and when the MSEL is operated using a USB cable. (The MSEL-PG type and PC compatible software IA-101-X-USBS come with this dummy plug.)



Model number **DP-4S**

Connector Conversion Cable

Features

This cable is used to convert the D-sub 25-pin connector of the teaching pendant or RS232C cable to the MSEL teaching connector. (The TB-01-SJ and IA-101-X-MW-JS come with this connector conversion cable.)

Model number **CB-SEL-SJS002**

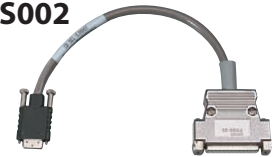

Absolute Data Backup Battery Box

Features

If the absolute position encoder specification is selected with code ABB, the absolute data backup battery box is included with the controller. However, if the battery box is ordered as a separate unit, it does not include the battery but just the box itself. If the battery is needed, please purchase it separately. (Model: AB-7).

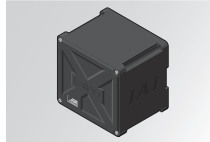

Model number **MSEL-ABB** (Batteries not included)

Exterior dimensions See P.7

* A cable (Model CB-MSEL-AB005) that connects the absolute data backup battery box to the MSEL is included with the box.

Replacement Battery

Features

The replacement battery for the absolute data backup battery box.



Model number **AB-7**

* Same quantity of absolute battery units is required as the number of axes.

PC Compatible Software (Windows Only)

Features

The startup support software provides program/position input, test operation and monitoring functions, among others. With its enhanced functions required for debugging, this software helps shorten the startup time.

Model number **IA-101-X-MW-JS** (RS232C cable + Connector conversion cable)

Configuration

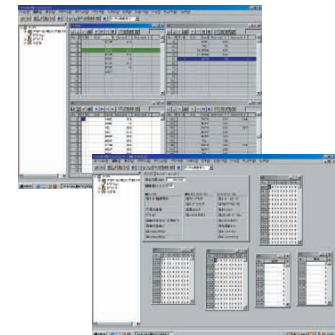
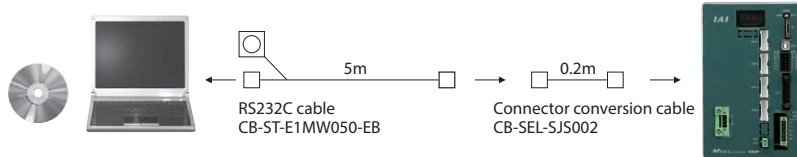

Model number **IA-101-X-USBS** (USB cable + Dummy plug)

Configuration

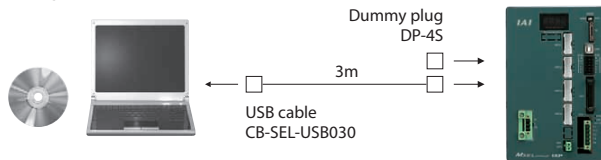

The MSEL-PC/PG are supported by Ver. 12.00.01.00 or later.

The CB-ST-E1MW050-EB cannot be used when "Building an enable system that uses a system I/O connector and external power supply" or "Building a redundant safety circuit." (The CB-ST-A1MW050-EB must be used instead.)

Service Parts

Model number	CB-CAN-MPA □□□	Integrated Motor-Encoder Cable	for RCP4-SA3/RA3/RCP5/RCD
	CB-CAN-MPA □□□-RB	Integrated Motor-Encoder Robot Cable	

* Please indicate cable length (L) in □□□, maximum 20m. e.g.) 080 = 8m

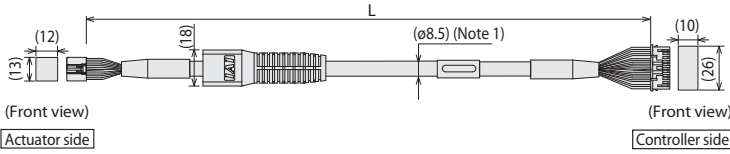

Minimum bending radius 5m or less length R = 68mm or more (Dynamic bending condition)
 Longer than 5m R = 73mm or more (Dynamic bending condition)

* The robot cable is designed for flex-resistance: Please use the robot cable if the cable has to be installed through a cable track.

(Note 1) If the cable is 5m or longer, ø9.1 cable diameter applies for a non-robot cable and ø10 for a robot cable.

Pin No.	Signal name	Pin No.	Signal name
3	øA/U	1	øA/U
5	VMM/V	2	VMM/V
10	ø A/W	3	ø A/W
9	øB/-	4	øB/-
4	VMM/-	5	VMM/-
15	ø B/-	6	ø B/-
8	LS+/BK+	7	LS+/BK+
14	LS-/BK-	5	LS-/BK-
12	-/A+	11	-/A+
17	-/A-	12	-/A-
1	A+/B+	13	A+/B+
6	A-/B-	14	A-/B-
11	B+/Z+	15	B+/Z+
16	B-/Z-	16	B-/Z-
20	BK+/LS+	9	BK+/LS+
2	BK-/LS-	10	BK-/LS-
21	LS GND	17	LS GND
7	VPS	19	VPS
15	VCC	15	VCC
13	GND	19	GND
19	—	22	—
22	BAT+	21	BAT+
23	—	23	—
24	FG	24	FG

Model number	CB-CA-MPA □□□	Integrated Motor-Encoder Cable	for RCP4 (Excluding the RCP4-SA3/RA3)
	CB-CA-MPA □□□-RB	Integrated Motor-Encoder Robot Cable	

* Please indicate cable length (L) in □□□, maximum 20m. e.g.) 080 = 8m

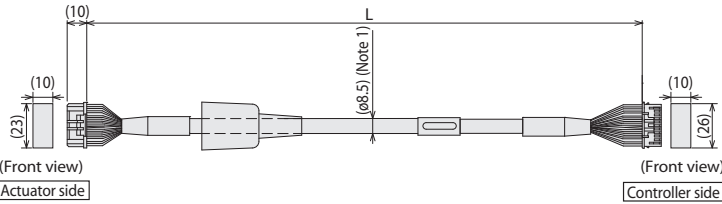

Minimum bending radius 5m or less length R = 68mm or more (Dynamic bending condition)
 Longer than 5m R = 73mm or more (Dynamic bending condition)

* The robot cable is designed for flex-resistance: Please use the robot cable if the cable has to be installed through a cable track.

(Note 1) If the cable is 5m or longer, ø9.1 cable diameter applies for a non-robot cable and ø10 for a robot cable.

Pin No.	Signal name	Pin No.	Signal name
A1	øA/U	1	øA/U
B1	VMM/V	2	VMM/V
A2	ø A/W	5	ø A/W
B2	øB/-	3	øB/-
A3	VMM/-	4	VMM/-
B3	ø B/-	6	ø B/-
A4	LS+/BK+	7	LS+/BK+
B4	LS-/BK-	8	LS-/BK-
A6	-/A+	11	-/A+
B6	-/A-	12	-/A-
A7	A+/B+	13	A+/B+
B7	A-/B-	14	A-/B-
A8	B+/Z+	15	B+/Z+
B8	B-/Z-	16	B-/Z-
A5	BK+/LS+	9	BK+/LS+
B5	BK-/LS-	10	BK-/LS-
A9	LS GND	20	LS GND
B9	VPS	18	VPS
A10	VCC	17	VCC
B10	GND	19	GND
A11	—	21	—
B11	FG	22	—
		23	—
		24	FG

Model number	CB-APSEP-MPA □□□-LC	Integrated Motor-Encoder Cable	for RCP3/RCA2 and others
	CB-APSEP-MPA □□□	Integrated Motor-Encoder Robot Cable	

* Please indicate cable length (L) in □□□, maximum 20m. e.g.) 080 = 8m

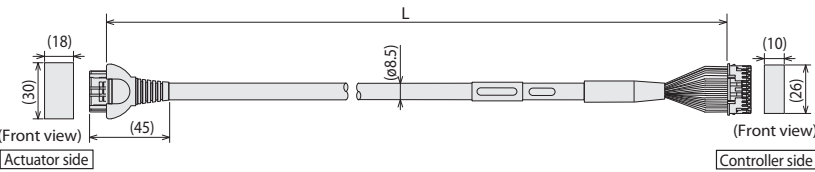

Minimum bending radius R = 68mm or more (Dynamic bending condition)

* The robot cable is designed for flex-resistance: Please use the robot cable if the cable has to be installed through a cable track.

Actuator side Pin No.	Signal name	Controller side Pin No.	Signal name
A1	[øA] (U)	1	[øA] (U)
B1	[VMM] (V)	2	[VMM] (V)
A2	[øA] (W)	5	[øA] (W)
B2	[øB] (-)	3	[øB] (-)
A3	[VMM] (-)	4	[VMM] (-)
B3	[øB] (-)	6	[øB] (-)
A4	[LS+] (BK+)	7	[LS+] (BK+)
B4	[LS-] (BK-)	8	[LS-] (BK-)
A6	[A+] (A+)	11	[A+] (A+)
B6	[A-] (A-)	12	[A-] (A-)
A7	[A+] (B+)	13	[A+] (B+)
B7	[A-] (B-)	14	[A-] (B-)
A8	[B+] (Z+)	15	[B+] (Z+)
B8	[B-] (Z-)	16	[B-] (Z-)
A5	[BK+] (LS+)	9	[BK+] (LS+)
B5	[BK-] (LS-)	10	[BK-] (LS-)
A9	[GNDLS] (GNDLS)	20	[GNDLS] (GNDLS)
B9	[VPS] (VPS)	18	[VPS] (VPS)
A10	[VCC] (VCC)	17	[VCC] (VCC)
B10	[GND] (GND)	19	[GND] (GND)
A11	NC	21	NC
B11	Shield (FG) (FG)	24	Shield (FG) (FG)
		22	NC
		23	NC

Model number CB-PSEP-MPA□□□ **Integrated Motor-Encoder Robot Cable** **for RCP2**

* Only robot cable is available for this model * Please indicate cable length (L) in □□□, maximum 20m. e.g.) 080 = 8m

Minimum bending radius R = 68mm or more (Dynamic bending condition)

1st Connector			2nd Connector	
Actuator side	Pin No.		Controller side	Pin No.
1	1	(oA)	1	1
2	2	(VMM)	2	2
4	3	(oB)	3	3
5	4	(VMM)	4	4
3	5	(oA)	5	5
6	6	(oB)	6	6
16	7	(BK+)	7	7
17	8	(BK-)	8	8
5	9	(LS-)	9	9
6	10	(LS-)	10	10
13	11	(A+)	11	11
14	12	(A-)	12	12
1	13	(B+)	13	13
2	14	(B-)	14	14
3	15	(VCC)	15	15
4	16	(VPS)	16	16
10	17	(GND)	17	17
11	18	(GND)	18	18
9	19	([Spare])	19	19
12	20	(NC)	20	20
15	21	(NC)	21	21
7	22	(NC)	22	22
8	23	(NC)	23	23
18	24	Shield (FG)	24	24

Model number CB-RPSEP-MPA□□□ **Integrated Motor-Encoder Robot Cable** **for RCP2-RTBS/RTBSL/RTCS/RTCSL**

* Only robot cable is available for this model * Please indicate cable length (L) in □□□, maximum 20m. e.g.) 080 = 8m

Minimum bending radius R = 68mm or more (Dynamic bending condition)

Actuator side			Controller side	
Pin No.			Pin No.	
A1	1	(oA)	1	1
B1	2	(VMM)	2	2
A2	3	(oA)	3	3
B2	4	(oB)	4	4
A3	5	(VMM)	5	5
B3	6	(oB)	6	6
A6	7	(LS+)	7	7
B6	8	(LS-)	8	8
A7	9	(A+)	9	9
B7	10	(A-)	10	10
A8	11	(B+)	11	11
B8	12	(B-)	12	12
A4	13	(NC)	13	13
B4	14	(NC)	14	14
A5	15	(BK+)	15	15
B5	16	(BK-)	16	16
A9	17	(GNDLS)	17	17
B9	18	(VPS)	18	18
A10	19	(VCC)	19	19
B10	20	(GND)	20	20
A11	21	(NC)	21	21
B11	22	Shield(FG) (FG)	22	22
	23	(NC)	23	23
	24	(NC)	24	24

Model number CB-PAC-PIO□□□ **PIO Flat Cable** **for MSEL/PCON-CA/MSEP-LC**

* Please indicate cable length (L) in □□□, maximum 10m. e.g.) 080 = 8m

Flat cable (20-core) x 2

Half-pitch MIL socket: HIF6-40D-1.27R (Hirose)

HIF6-40D-1.27R				HIF6-40D-1.27R			
No.	Signal name	Cable color	Wiring	No.	Signal name	Cable color	Wiring
A1	24V	Brown-1	Flat cable (A) (crimped) AWG28	B1	OUT0	Brown-3	Flat cable (B) (crimped) AWG28
A2	24V	Red-1		B2	OUT1	Red-3	
A3	—	Orange-1		B3	OUT2	Orange-3	
A4	—	Yellow-1		B4	OUT3	Yellow-3	
A5	IN0	Green-1		B5	OUT4	Green-3	
A6	IN1	Blue-1		B6	OUT5	Blue-3	
A7	IN2	Purple-1		B7	OUT6	Purple-3	
A8	IN3	Gray-1		B8	OUT7	Gray-3	
A9	IN4	White-1		B9	OUT8	White-3	
A10	IN5	Black-1		B10	OUT9	Black-3	
A11	IN6	Brown-2		B11	OUT10	Brown-4	
A12	IN7	Red-2		B12	OUT11	Red-4	
A13	IN8	Orange-2		B13	OUT12	Orange-4	
A14	IN9	Yellow-2		B14	OUT13	Yellow-4	
A15	IN10	Green-2		B15	OUT14	Green-4	
A16	IN11	Blue-2		B16	OUT15	Blue-4	
A17	IN12	Purple-2		B17	—	Purple-4	
A18	IN13	Gray-2		B18	—	Gray-4	
A19	IN14	White-2		B19	OV	White-4	
A20	IN15	Black-2		B20	OV	Black-4	