

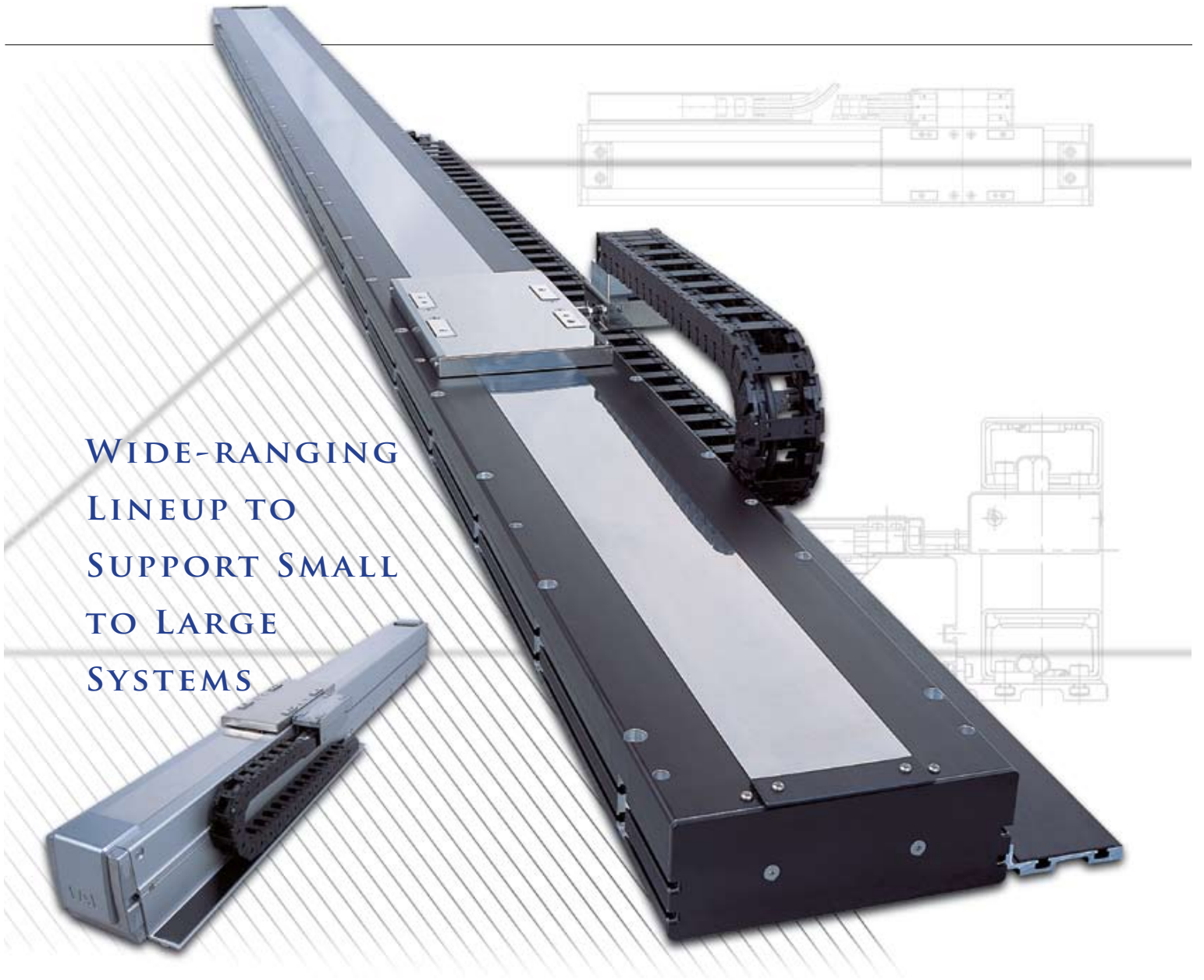

Quality and Innovation

Linear Servo Actuator **LSA**



WIDE-RANGING
LINEUP TO
SUPPORT SMALL
TO LARGE
SYSTEMS

Sold & Serviced By:



Toll Free Phone (877) SERV098

Toll Free Fax (877) SERV099

www.electromate.com

sales@electromate.com

A FULL LINEUP OF MODELS M

Maximum speed of 2,500 mm/sec, maximum acceleration/ deceleration of 3 G, maximum payload of 120 kg, and maximum stroke of 4 m.

- Compact, lightweight shaft type
- Small type with flat motor achieving high thrust with a slim body
- Flat type ideal for vertically confined space
- Medium type boasting high moment rigidity
- Large type capable of transferring a maximum load of 120 kg over 4 m



1

Sold & Serviced By:
ELECTROMATE

Toll Free Phone (877) SERV098
Toll Free Fax (877) SERV099
www.electromate.com
sales@electromate.com

MEETING VARIOUS APPLICATIONS



Select from three types of controllers. Controllers supporting three different control modes—positioner, pulse-train and program—are available. A new multi-slider collision prevention function has been added to the SSEL/XSEL controller series.



1-axis controller capable of operating actuators in the positioner mode and pulse-train mode

SCON

NEW



1-axis/2-axis program controller achieving high cost performance

SSEL

NEW



High-performance program controller capable of controlling up to six axes at the same time

X-SEL

Performance/Functions

Capable of Transferring a Payload of Up to 120 kg over a Length of Up to 4.15 m

Despite its compact body, the large type (W21 type) generates a high rated thrust of 400 N through its unique structure that adopts a high-density coil with core and flat magnet. This high thrust enables the actuator to accommodate a payload of up to 120 kg. The W21 can also be ordered with a long stroke of up to 4.15 m, which is ideal for transferring large LCD boards.

Significant Reduction in Cycle Time with a High Acceleration of Up to 3 G and High Speed of 2.5 m/sec

The high performance backed by the maximum acceleration of 3 G and maximum speed of 2.5 m/sec reduces the cycle time significantly compared to when single-axis robots of ball-screw type are used. Unlike with ball-screw actuators, linear servo actuators will not suffer from a drop in their maximum speed as a result of reaching a dangerous speed, even when operated over a long stroke. This means that loads can be transferred reliably at high speed.

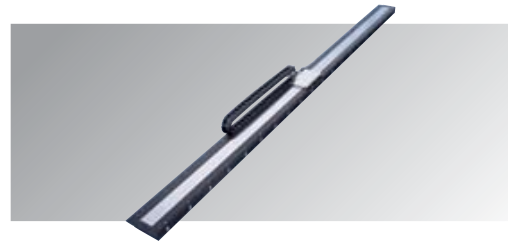

■ Comparison of Traveling Time between Linear Servo Actuator and Single-axis Robot

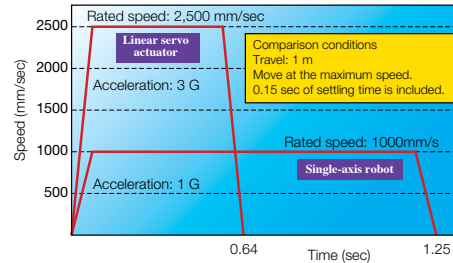

Multi-slider Type and Synchronization Function

We have a line of multi-slider models that allow multiple sliders to be operated on a single actuator. These configurations are very effective in saving space and reducing the cycle time. Also, you can use the synchronization function - a popular function offered by the XSEL controller series - to configure a system for transferring glass boards whose size is increasing, or transferring a load at high speed over a wide range.

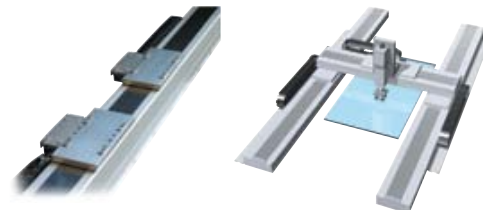

Multi-slider type

Synchronized operation

Variations/Structures

A Wide-ranging Lineup Supporting Small to Large Systems

Our linear servo actuators are classified into the small, lightweight shaft type, small type with a slim body, flat type with low height, intermediate type offering excellent moment rigidity, and large type capable of transferring a maximum load of 120 kg, among others. We provide a wide selection for you to choose from according to your specific application.

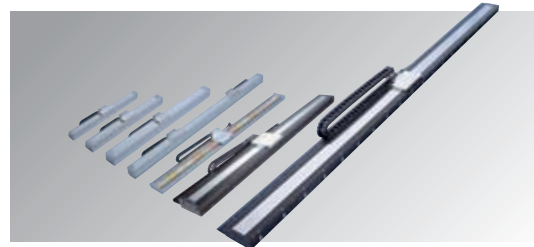

Compact, Low-cost Shaft Type

The shaft has a built-in magnet surrounded by a coil to utilize magnetic flux in all directions. As a result, even the compact actuator can generate high thrust. Since the structure requires fewer magnets, the shaft type also offers a great cost advantage.

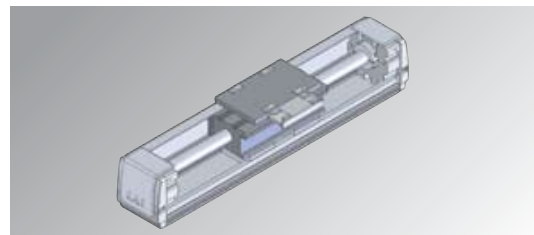

Large, High-thrust Type for High-load Applications

The large, high-thrust type adopts a roller-guide structure to support high loads of up to 120 kg. Since the roller guide is less subject to elastic deformation due to load compared to the ball guide, the operation is quiet and smooth while high moment rigidity is also ensured.

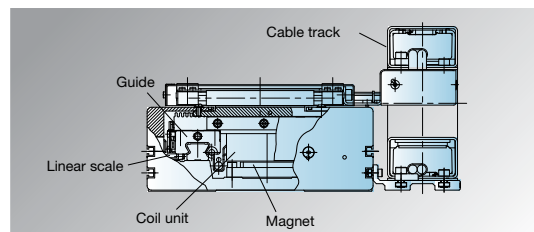

Section View of Large Type

Maintainability/Low Cost

AQ Seals Achieving Maintenance-free Operation for a Long Time

With linear servo motors, the magnet is not contacting the coil, which means these motors do not need maintenance. Also, all shaft models come with AQ seals installed on their guide. AQ seals supply lubricating oil to the guide over a long period, so the guide need not be oiled for years.

Low Cost

A majority of parts and components comprising IAI's linear servo actuators, such as the base, guide, linear motor and linear scale, have been developed internally by IAI. Use of in-house parts and components means that the costs of these actuators are kept to a minimum.

■ Traveling Test Data (with/without AQ Seals)

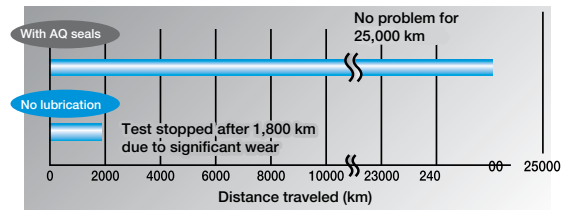

■ Section View of Shaft Type

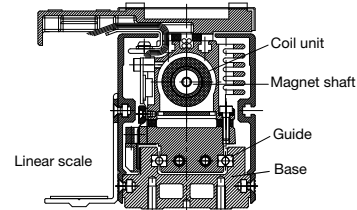

Controller

Easy Control

Just like single-axis robots and motorized cylinders, operation of IAI's linear servo actuators is very easy. All you need is to connect the actuator to a controller using a dedicated cable and supply the power. The actuator is now ready to go without cumbersome settings or adjustments. You can also select a desired controller from three different types according to your specific application.

Multi-slider Collision Prevention Function

A new function has been added to prevent two sliders from colliding with each other when operated independently in the multi-slider operation mode.

SSEL

Program/Positioner Control

A program controller capable of controlling up to two axes using a simple program (SEL language). The SSEL controller can be used standalone without any external device (PLC). You can also switch to the positioner mode to use the SSEL as a positioner controller.

SCON

Positioner/Pulse-train Control

A dedicated single-axis controller offering both the positioner function and pulse-train input function. Low price is also an attractive feature of the SCON controller.

X-SEL



Program Control of Up to 6 Axes

A high-function, multi-axis controller capable of controlling up to six axes simultaneously. You can also control a combination of linear servo actuators and single-axis robots using the X-SEL.

■ List of Actuator Specifications

	Exterior view	Model (type)	Actuator width (mm)	Slider		Stroke (mm)	Thrust (N)	Maximum payload (kg)	Maximum speed (mm/sec)	Pages	
Shaft type		S6SS	60	Standard	Single-slider	48~1248	15	3	2500	P15~16	
		S6SM			Multi-slider	40~1048				P17~18	
		S8SS	80	Standard	Single-slider	60~1620	25	5		P19~20	
		S8SM			Multi-slider	60~1440				P21~22	
		S8HS		High thrust	Single-slider	60~1620	35	7		P23~24	
		S8HM			Multi-slider	60~1380				P25~26	
		S10SS	100	Standard	Single-slider	90~2070	65	15		P27~28	
		S10SM			Multi-slider	60~1860				P29~30	
		S10HS		High thrust	Single-slider	90~2070	80	20		P31~32	
		S10HM			Multi-slider	105~1815				P33~34	
	Small type		H8SS	80	Standard	Single-slider	50~1650	30		5	P35~36
			H8SM			Multi-slider	130~1430				P37~38
H8HS			High thrust		Single-slider	50~1550	60	8	P39~40		
H8HM					Multi-slider	130~1230			P41~42		
Flat type		L15SS	145	Standard	Single-slider	150~1650	30	5	P43		
		L15SM			Multi-slider	50~1450			P44		
Medium type		N19SS	193	Standard	Single-slider	144~2592	100	30	P45		
		N19SM			Multi-slider	72~2232			P46		
Large type		W21SS	210	Standard	Single-slider	1050~4155	200	60	P47		
		W21SM			Multi-slider	730~3835			P48		
		W21HS		High thrust	Single-slider	895~4000	400	120	P49		
		W21HM			Multi-slider	420~3525			P50		

■ List of Controller Specifications

Exterior view	Feature	Number of controlled axes	Number of programs	Number of positions	Input power supply	Model (series – type)	Pages
	Affordable 1-axis positioner capable of both positioner control and pulse-train control Also supporting field network connection	1 axis	–	512	Single-phase AC100V AC200V	SCON-C	P51
	Affordable 2-axis controller that can perform interpolation operation via program control	1 axis 2 axes	128 programs 9999 steps	20,000		SSEL-C	P52
	High-function, multi-axis controller capable of operating up to six axes simultaneously Also supporting field network connection	1 axis 2 axes 3 axes 4 axes 5 axes 6 axes	128 programs 9999 steps	20,000	Single-phase AC200V Three-phase AC200V	XSEL-P XSEL-Q	P53

■ Correspondence Table of Actuator/Controller Operation

		Controllers		
		SCON-C	SSEL-C	XSEL-P/Q
Actuators	Shaft Type	○	○	○
	Small Type	○	○	○
	Flat Type	○	○	○
	Medium Type	○	○	○
	Large Type (Standard)	○	○	○
	Large Type (High thrust)	✕	✕	○
	Single-axis robot	○	○	○

System Configuration

SCON Controller

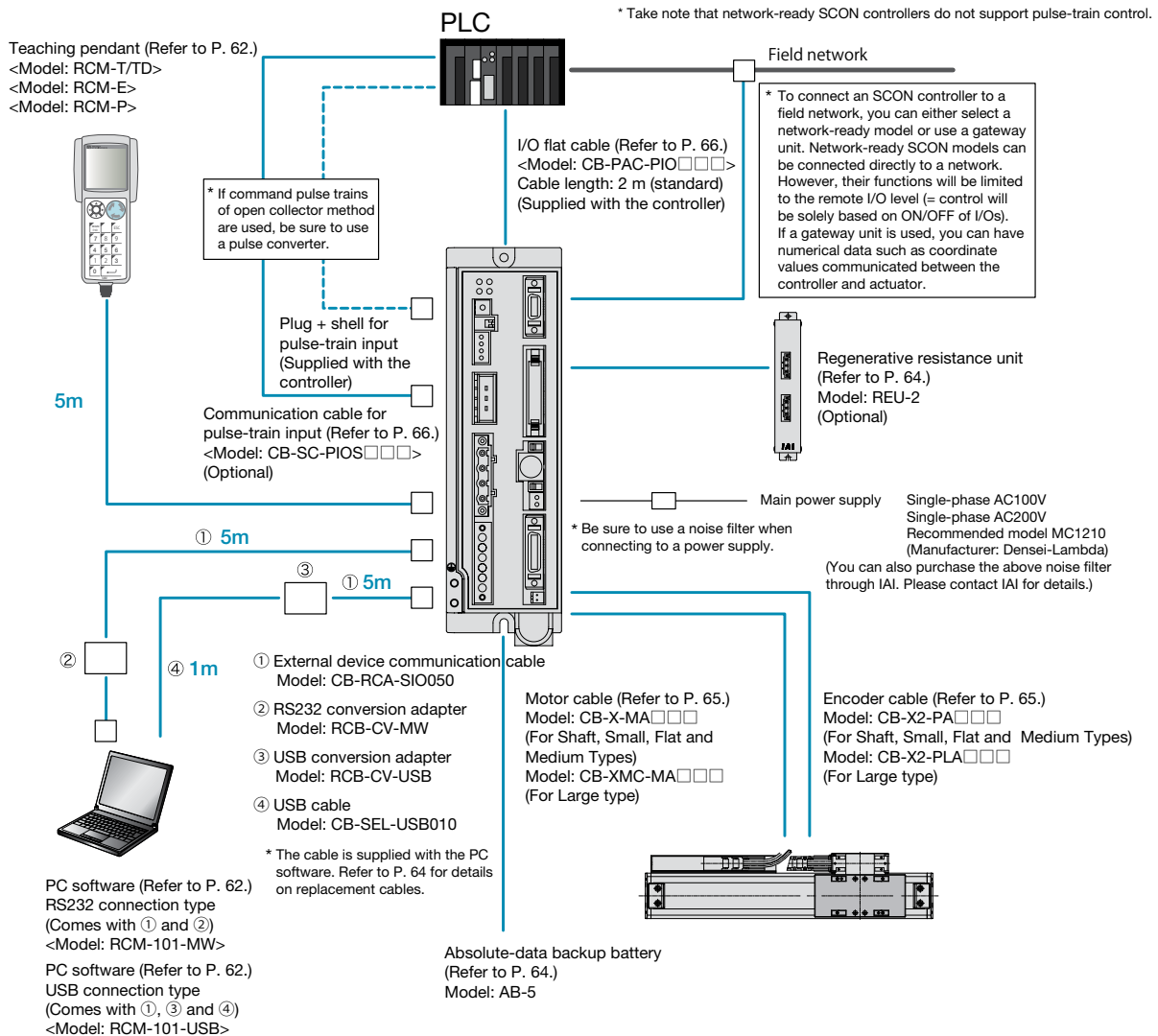

System Configuration

SSEL Controller

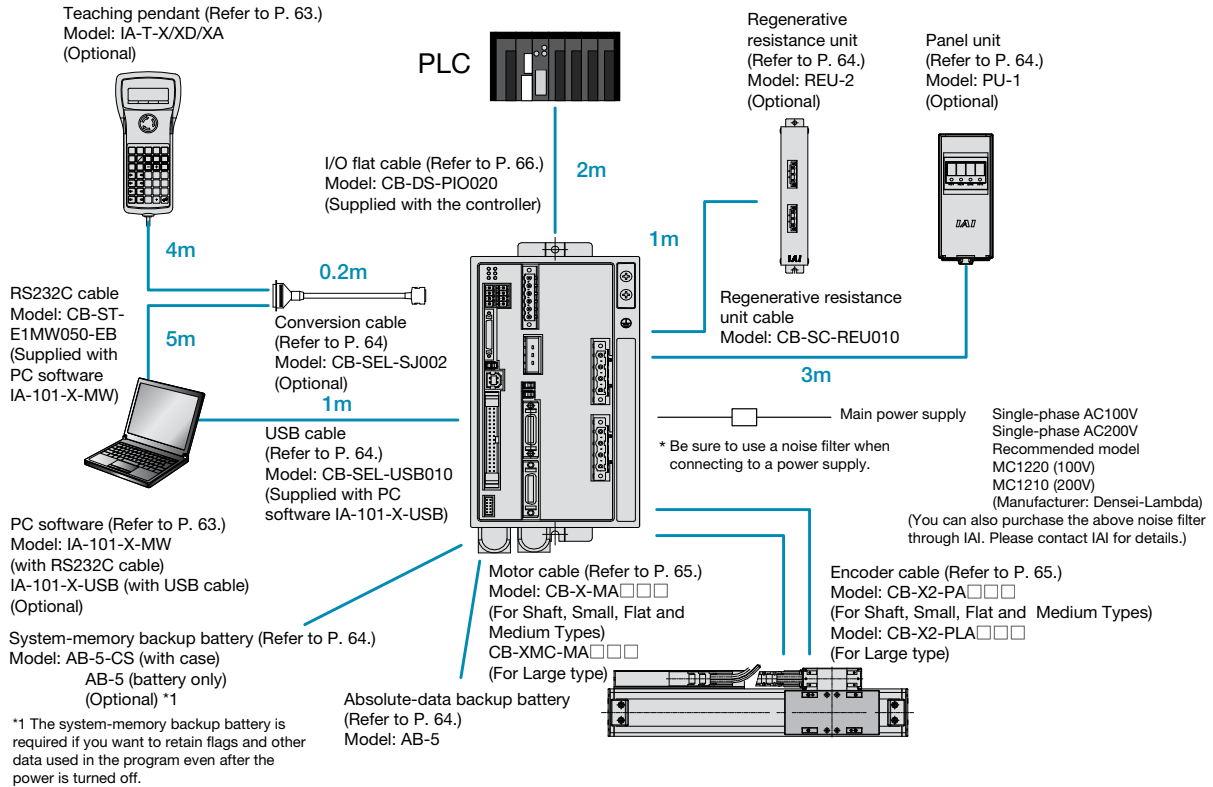

XSEL Controller

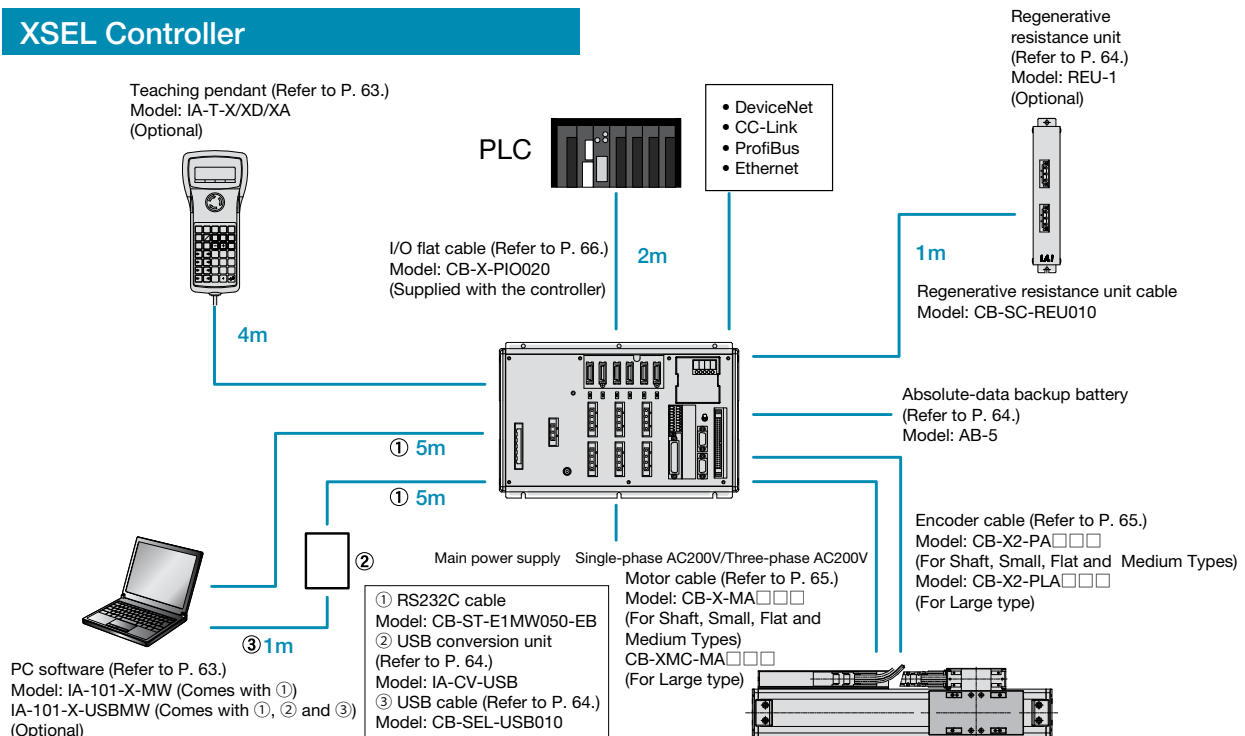

■ Examples of Use

Loader/Unloader

By using a multi-slider type, you can perform with one actuator what normally requires two actuators. This saves both space and cost.

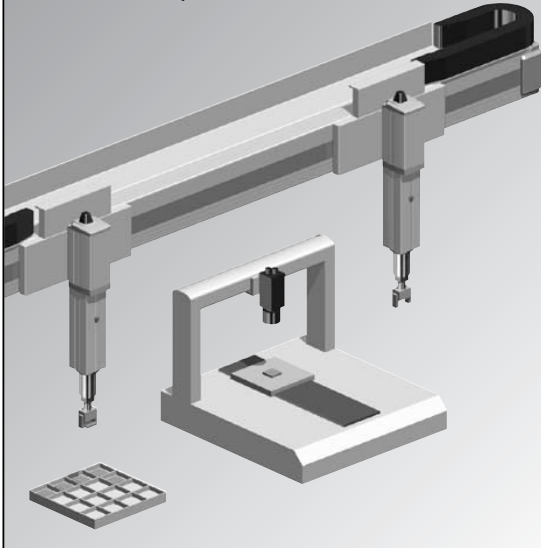

Transfer of Parts between Processes

Boasting the maximum acceleration of 3 G and maximum speed of 2.5 m/sec, linear servo actuators can certainly reduce your cycle time.

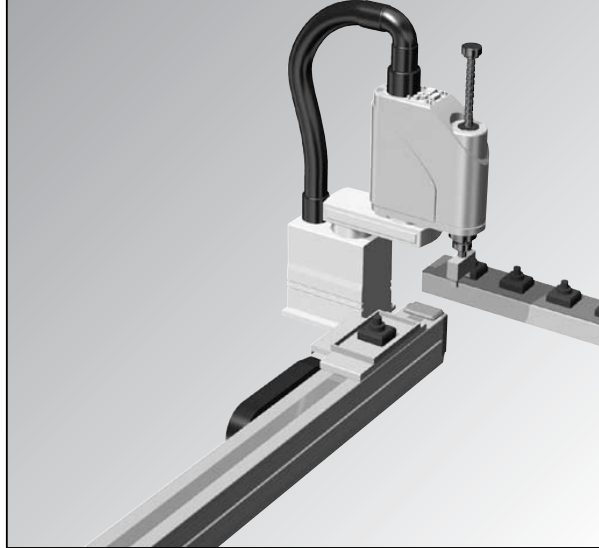

Glass Board Transfer System

By synchronizing two large actuators each capable of transferring a load of up to 120 kg, you can also transfer large glass boards.

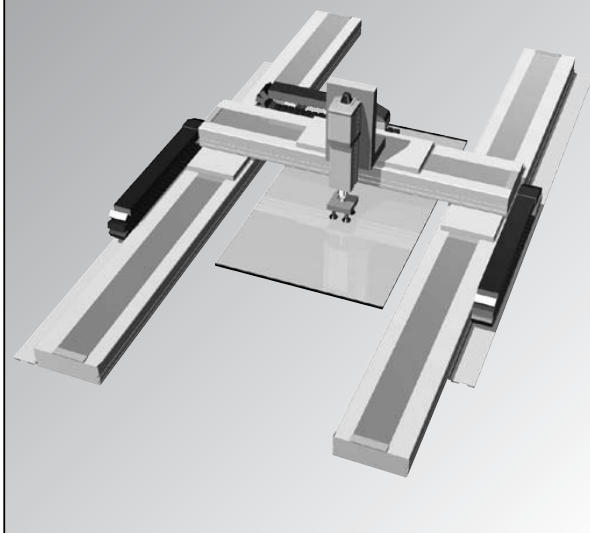

Glass Board Inspection System

A combination of a large linear servo actuator with the maximum stroke of 4,155 mm, with a small linear servo actuator, allows for high-speed inspection over a wide range.

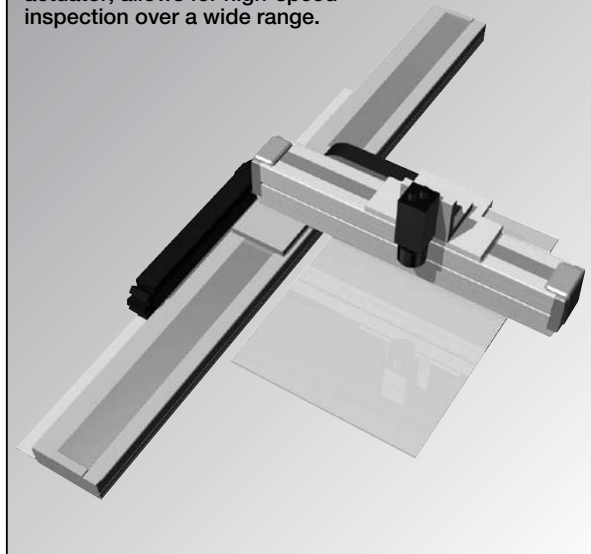

■ Model Selection

When selecting an appropriate linear servo actuator, remember that your actuator must meet the following two conditions.

- The thrust required for acceleration is equal to or less than the maximum thrust of the linear servo actuator.
- The thrust during continuous operation is equal to or less than the rated thrust of the linear servo actuator.

The above conditions are explained using the trapezoid operation pattern as an example.

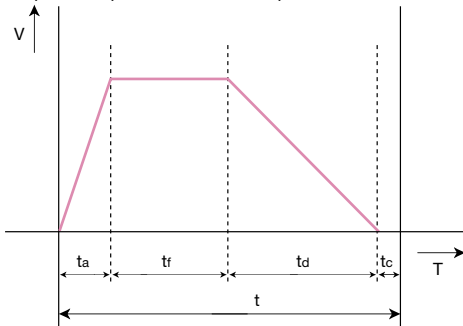

In the above graph:

t : Operation time per cycle (sec) tr : Time traveled at constant speed (sec)
 ta : Acceleration time (sec) td : Deceleration time (sec)
 tc : Settling time (sec)

The operation pattern shown to the left can be converted to the graph below where the vertical axis represents thrust:

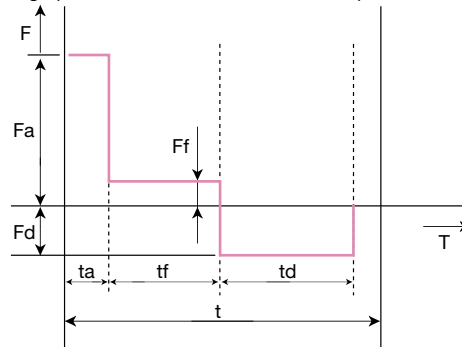

In the above graph:

Fa : Thrust required for acceleration (N) Fd : Thrust required for deceleration (N)
 Ff : Traveling resistance (N)

Selection method

Condition ① Maximum Thrust

For the slider to accelerate according to the command, the thrust required for acceleration, or F_a , must be smaller than the maximum thrust of the linear servo actuator. Calculate the thrust required for acceleration (F_a) using the formula below:

$$F_a = (M+m) \cdot a + F_f$$

M : Weight of slider (kg)

m : Slider load (kg)

a : Command acceleration (m/sec²) F_f : Traveling resistance (N)

	Weight of slider (kg)	Traveling resistance F _f (N)	Maximum thrust (N)
S6SS	1.4	5V + 5	60
S8SS	1.7	9V + 7	100
S8HS	2.0	9V + 7	140
S10SS	3.5	20V + 13.5	260
S10HS	4.0	20V + 13.5	320
H8SS	1.5	2V + 10	90
H8HS	2.0	2V + 10	180
L15SS	1.5	2V + 10	90
N19SS	5.5	16V + 12	Refer to the graph on the right.
W21SS	10.0	20V + 70	600
W21HS	20.0	20V + 70	1200

* V : Slider traveling speed (m/sec)
 (The attained speed is used under the triangle operating condition.)

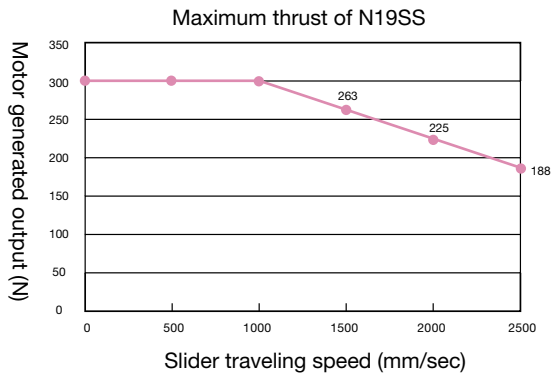

If the obtained value of F_a is smaller than the maximum thrust of the linear servo actuator, condition ① is satisfied.

$$\text{Thrust required for acceleration (} F_a \text{)} \leq \text{Maximum thrust of linear servo actuator}$$

If the thrust required for acceleration (F_a) exceeds the maximum thrust of the linear servo actuator, the slider load or acceleration must be reduced.

Check the maximum payload and maximum acceleration using the following formulas, respectively:

$$\begin{aligned} \text{Maximum payload} & \quad m = (F_a - F_f) / a - M \\ \text{Maximum acceleration} & \quad a = (F_a - F_f) / (M + m) \end{aligned}$$

Condition ② Thrust during Continuous Operation

After considering the load and duty, the thrust during continuous operation, or F_t , must be smaller than the rated thrust of the linear servo actuator. Calculate the thrust during continuous operation using the formula below:

$$F_t = \sqrt{\frac{F_a^2 \cdot t_a + F_f^2 \cdot t_f + F_d^2 \cdot t_d}{t}}$$

F_a : Thrust required for acceleration (N) F_d : Thrust required for deceleration (N)
 t_a : Acceleration time (sec) t_d : Deceleration time (s)
 F_f : Traveling resistance (N) t : Operation time per cycle (sec)
 t_f : Rated traveling time (sec) ($t = t_a + t_f + t_d + \text{settling time} + \text{stationary time}$)

Thrust during continuous operation (F_t) ≤ Rated thrust of linear servo actuator

- t_a represents the acceleration time. Here, how to calculate t_a varies depending on whether the actuator is operated in the ① trapezoid pattern or ② triangle pattern.

Whether a given operation pattern is trapezoid or triangle can be determined by whether the speed attained by the actuator when operated over the specified travel at the specified speed is greater or smaller than the specified speed.

$$\text{Attained speed (Vmax)} = \sqrt{\text{Travel (m)} \times \text{Specified acceleration (m/sec}^2\text{)}}$$

Specified speed < Attained speed → ① Trapezoid pattern
 Specified speed > Attained speed → ② Triangle pattern

① Trapezoid pattern

$$t_a = V_s / a$$

V_s : Specified speed (m/sec) a : Command acceleration (m/sec²)

② Triangle pattern

$$t_a = V_t / a$$

V_t : Specified speed (m/sec) a : Command acceleration (m/sec²)

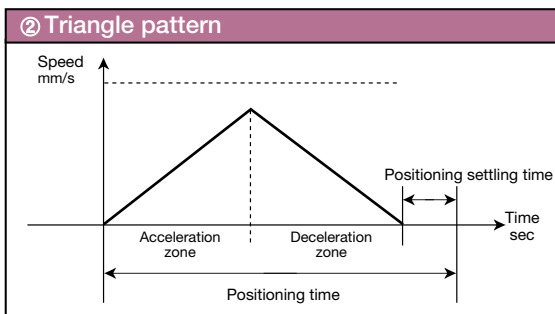
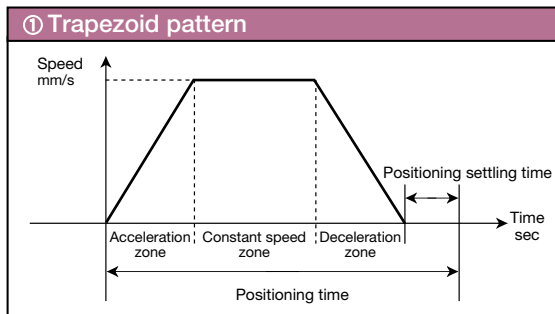

- t_f represents the time traveled at constant speed. Calculate t_f by calculating the distance traveled at constant speed, as follows:

$$t_f = L_c / V$$

L_c : Time traveled at constant speed (m)

V : Command speed (m/sec)

* Distance traveled at constant speed =
 Travel – Acceleration distance – Deceleration distance
 Acceleration distance (deceleration distance) = $V^2 / 2a$

- F_d represents the thrust required for deceleration. Calculate F_d using the formula below:

$$F_d = (M + m) \cdot a - F_f$$

- t_d represents the deceleration time. If the acceleration is the same as the deceleration, t_d should be the same as the acceleration time.
 $t_d = V/a$ V : Speed (m/sec) a : Acceleration (m/sec²)

- t represents the operation time per cycle and is calculated as a total sum of the acceleration time (t_a), constant speed time (t_f), deceleration time (t_d), settling time (refer to the table below), and stationary time.

Models	Settling time
S6SS, S6SM, H8SS, H8SM, H8HS, H8HM, W21SS, W21SM, W21HS, W21HM	0.15s
S8SS, S8SM, S8HS, S8HM, S10SS, S10SM, S10HS, S10HM, N19SS, N19SM	0.2s

If the thrust during continuous operation (F_t) obtained as above is smaller than the rated thrust, condition ② is satisfied.

	Rated thrust (N)		Rated thrust (N)
S6SS	15	H8SS	30
S8SS	25	H8HS	60
S8HS	35	L15SS	30
S10SS	65	N19SS	100
S10HS	80	W21SS	200
		W21HS	400

If you want to use the maximum acceleration obtained in the test of condition ① to calculate the cycle time that allows for continuous operation, check if the calculated result is viable using the formula below:

$$t = \frac{F_a^2 \cdot t_a + F_f^2 \cdot t_f + F_d^2 \cdot t_d}{F_t^2}$$

The actuator can be operated under conditions where both conditions ① and ② above are satisfied.

If either condition is not satisfied, reduce the slider load, acceleration or duty (*) or take other appropriate measures.

* To reduce the duty, the ratio of traveling time (acceleration + constant speed + deceleration) to cycle time must be lowered.

Exercise

Let's select a linear servo actuator using the selection method explained in the preceding section.

★ Operating conditions

- Actuator model LSA-H8SS
- Speed 2.5m/sec
- Acceleration 19.6m/sec² (The deceleration is assumed to be the same.)
- Travel distance 1.5m
- Slider load 3kg
- Settling time 0.15sec
- Stroke 1.5 m The actuator will move back and forth under the above conditions.

$$*1G = 9.8m/s^2$$

The above operation pattern is illustrated by the graph shown to the right. Now, let's start calculation according to the selection method.

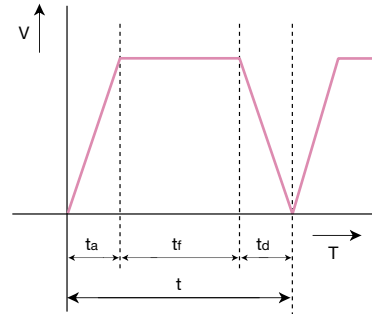

Condition ① Calculate the maximum thrust

Apply the above operation pattern to the formula for maximum thrust explained earlier:

$$F_a = (M + m) \cdot a + F_f$$

Where,

- M : Weight of slider (kg): 1.5 kg for the H8SS
- m : Slider load (kg): 3 kg is used in this exercise.
- a : Command acceleration (m/sec²) : 19.6 m/sec² is used in this exercise.
- F_f : Traveling resistance: 15 N is used in this exercise.

Based on the above conditions, the formula is rephrased as follows:

$$F_a = 4.5 \times 19.6 + 15 \rightarrow 103.2N$$

Since the maximum thrust of the H8SS is 90 N, this actuator cannot be used under these conditions.

Accordingly, either the slider load or acceleration must be changed.

If the slider load is to be changed without changing the acceleration, the maximum load is calculated as follows:
 $m = (90 - 15) \div 19.6 - 1.5 \rightarrow 2.32 \text{ kg}$

If the acceleration is to be changed without changing the slider load (3 kg), the maximum acceleration is calculated as follows:
 $a = (90 - 15) \div (1.5 + 3) \rightarrow \text{Approx. } 16.6m/s^2$

In this exercise, the acceleration is changed to 16.6 m/sec².

$$F_a = 4.5 \times 16.6 + 15 \rightarrow 89.7N < 90N \text{ (maximum thrust)}$$

Condition ② Calculate the thrust during continuous operation

Apply the above operation pattern to the formula for thrust during continuous operation explained earlier. For your reference, the command acceleration is assumed to be 16.6 m/sec² based on the examination result of maximum thrust:

$$F_t = \sqrt{\frac{F_a^2 \cdot t_a + F_f^2 \cdot t_f + F_d^2 \cdot t_d}{t}}$$

Now, when the operation pattern at t_a is checked, the following is revealed:

$$\text{Attained speed (Vmax)} = \sqrt{1.5 \times 16.6} \rightarrow 4.9 \text{ m/sec}$$

Since this value is greater than the specified speed of 2.5 m/sec, the operation pattern is determined to be trapezoid.

$$\text{Accordingly, } t_a = 2.5 \div 1.6 \rightarrow 0.15s$$

Next, t_f is calculated.

$$\text{Distance traveled at constant speed} = 1.5 - \{(2.5 \times 2.5) \div (2 \times 16.6)\} \times 2 \rightarrow 1.12m$$

$$t_f = 1.12 \div 2.5 \rightarrow 0.45s$$

$$\text{Thrust required for deceleration } F_d = (1.5+3) \times 16.6 - 15 \rightarrow 59.7N$$

$$\text{Since } t_d = t_a, t = t_a + t_f + t_d + 0.15 \rightarrow 0.9 \text{ sec.}$$

When the above values are applied, the earlier formula is rephrased as follows:

$$F_t = \sqrt{\{(89.7 \times 89.7) \times 0.15 + (15 \times 15) \times 0.45 + (59.7 \times 59.7) \times 0.15\} \div 0.9} \rightarrow 45.25N$$

Since the result exceeds the rated thrust of the H8SS, or 30 N, this actuator cannot be used in this operation pattern.

Now, let's calculate the cycle time that allows for continuous operation:

$$t = \{(89.7 \times 89.7) \times 0.15 + (15 \times 15) \times 0.45 + (59.7 \times 59.7) \times 0.15\} \div (30 \times 30) \rightarrow 2.05s$$

As evident from the result, continuous operation can be performed if the cycle time is increased from 0.9 sec to 2.05 sec.

So, let's recalculate by assuming $t = 2.05$.

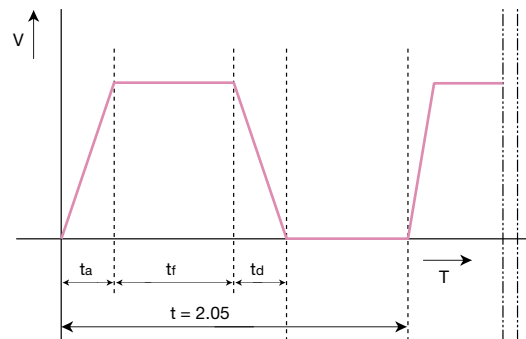

$$F_t = \sqrt{\{(89.7 \times 89.7) \times 0.15 + (15 \times 15) \times 0.45 + (59.7 \times 59.7) \times 0.15\} \div 2.05} \rightarrow 30N$$

Now, the actuator can be operated.

Model

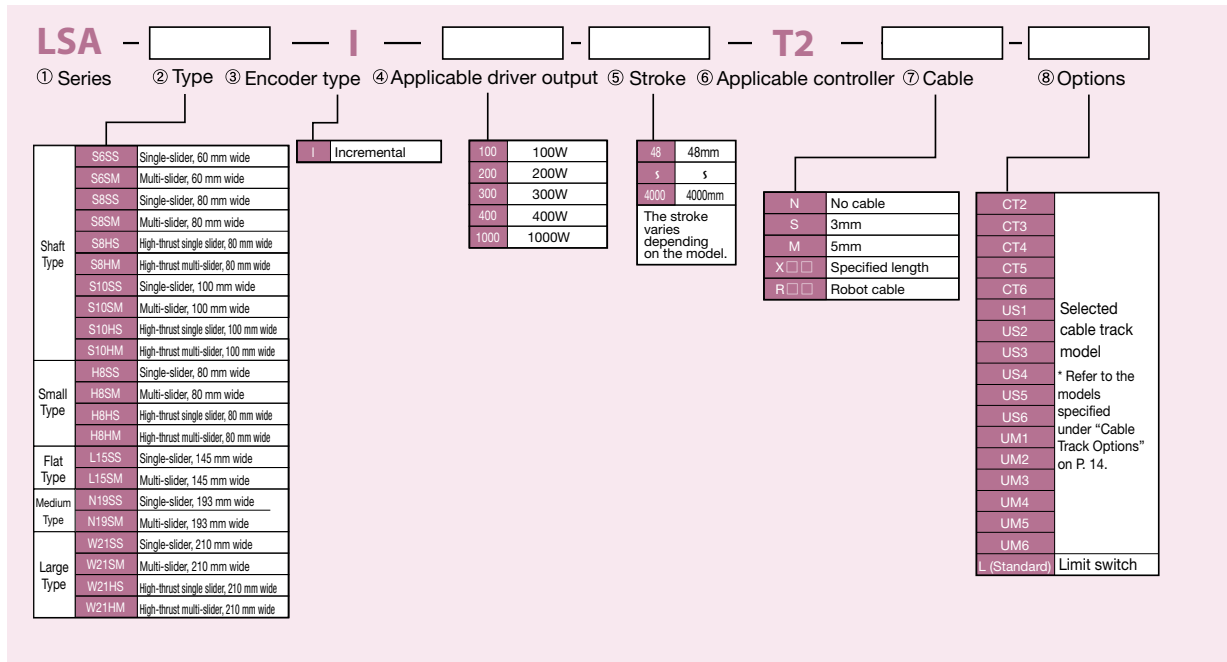

① Series

Indicate the name of each series.

② Type

Indicate the type, actuator width, motor type and slider type.

Example) S 10 S M

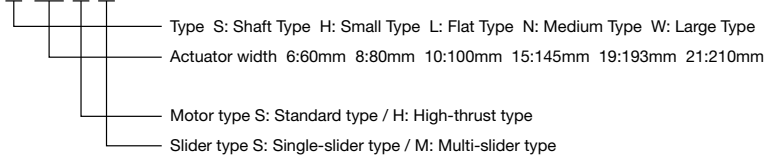

③ Encoder type

Indicate the type of the encoder installed in the actuator.

I: Incremental type

Since the slider position data is lost every time the power is turned off, home return must be performed every time the power is turned on.

④ Applicable driver output

Indicate the driver wattage of the controller to be connected.

⑤ Stroke

Indicate the stroke (range of operation) of the actuator (unit: mm).

⑥ Applicable controller

Indicate the types of controllers with which the actuator can be operated.

T2: SCON/SSEL/XSEL - P/Q

⑦ Cable length

Indicate the length of the motor/encoder cable connecting the actuator and controller.

N: No Cable

S: 3m

M: 5m

X□□: Select this option if you want to specify a length other than 1, 3 and 5 m

(Example: X08 = 8 m) (*) The standard cables are robot cables.

* The maximum cable length is 20 m for the SCON/SSEL and 30 m for the XSEL.

⑧ Options

Indicate the options to be installed on the actuator.

Refer to the facing page for details on CT2 to UM6.

* With the large type, the limit switch is a standard feature (required option). However, you must still specify "L" in the model name.

■ Cable Track Options

The cable track that comes standard with the shaft type and small type is designed exclusively for wiring a linear servo actuator and provides no space for additional cables the customer may require.

If you must wire additional cables, specify a cable track for user wiring by selecting an appropriate model from the right.

Cable tracks are available in two sizes of S and M, and you can select the installation direction from the six types illustrated below.

* Although cable tracks for user wiring are not available for the flat type, medium type and large type, you can still specify a desired installation direction for the standard cable track (excluding the sideways specification.)

【Cable Track for User Wiring】

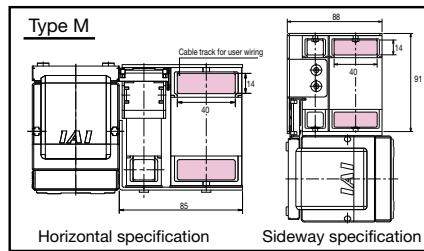
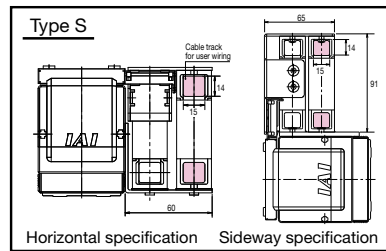

【Model】

Model	Installation direction	Cable track for user wiring
—	1 (Standard)	None
CT2	2	
CT3	3	
CT4	4	
CT5	5	
CT6	6	
US1	1	Type S
US2	2	
US3	3	
US4	4	
US5	5	
US6	6	
UM1	1	Type M
UM2	2	
UM3	3	
UM4	4	
UM5	5	
UM6	6	

【Installation direction】

Cable track direction 1 (standard)

This is the standard installation direction that applies when a cable track direction is not specified. With a single-slider model, the cable track is installed in the direction shown below. With a multi-slider model, one cable track is installed on both ends.

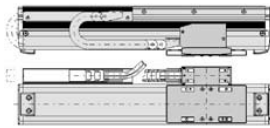

Cable track direction 2 (opposite): CT2

The cable track is installed on the opposite side compared to the standard specification.

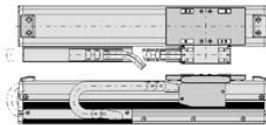

Cable track direction 3 CT3

The home is reversed from the standard specification (cable track direction 1).

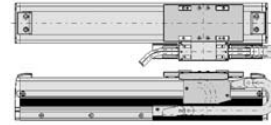

Cable track direction 4 CT4

The home is reversed from the CT2 specification (cable track direction 2).

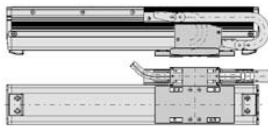

Cable track direction 5 (sideway, standard): CT5

This is the standard installation direction for actuators specified for sideway installation. With a single-slider model, the cable track is installed in the direction shown below. With a multi-slider model, one cable track is installed on both ends.

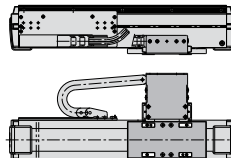

Cable track direction 6 (opposite specification): CT6

The cable track is installed on the opposite side compared to the sideway specification.

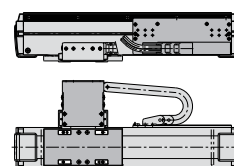

■ Stainless Sheet (Replacement Sheet)

This stainless sheet is a dustproof sheet that prevents foreign objects from entering the actuator.

If the sheet has broken or become damaged, order a replacement sheet by selecting an appropriate model from the right.

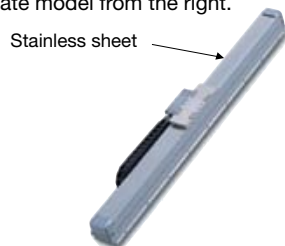

Type	Type code	Stainless sheet model	Type	Type code	Stainless sheet model
Shaft Type	S6SS	ST-S6SS- (stroke)	Small Type	H8SS	ST-H8SS- (stroke)
	S6SM	ST-S6SM- (stroke)		H8SM	ST-H8SM- (stroke)
	S8SS	ST-S8SS- (stroke)		H8HS	ST-H8HS- (stroke)
	S8SM	ST-S8SM- (stroke)	H8HM	ST-H8HM- (stroke)	
	S8HS	ST-S8HS- (stroke)	Medium Type	N19SS	ST-N19SS- (stroke)
	S8HM	ST-S8HM- (stroke)		N19SM	ST-N19SM- (stroke)
	S10SS	ST-S10SS- (stroke)	Large Type	W21SS	ST-W21SS- (stroke)
	S10SM	ST-S10SM- (stroke)		W21SM	ST-W21SM- (stroke)
	S10HS	ST-S10HS- (stroke)		W21HS	ST-W21HS- (stroke)
	S10HM	ST-S10HM- (stroke)		W21HM	ST-W21HM- (stroke)

Dimensions – Sideway Specification

*1 During home return, the slider will move to the ME. Accordingly, pay attention to possible contact between the slider and surrounding structures, etc.
ME: Mechanical end
SE: Stroke end

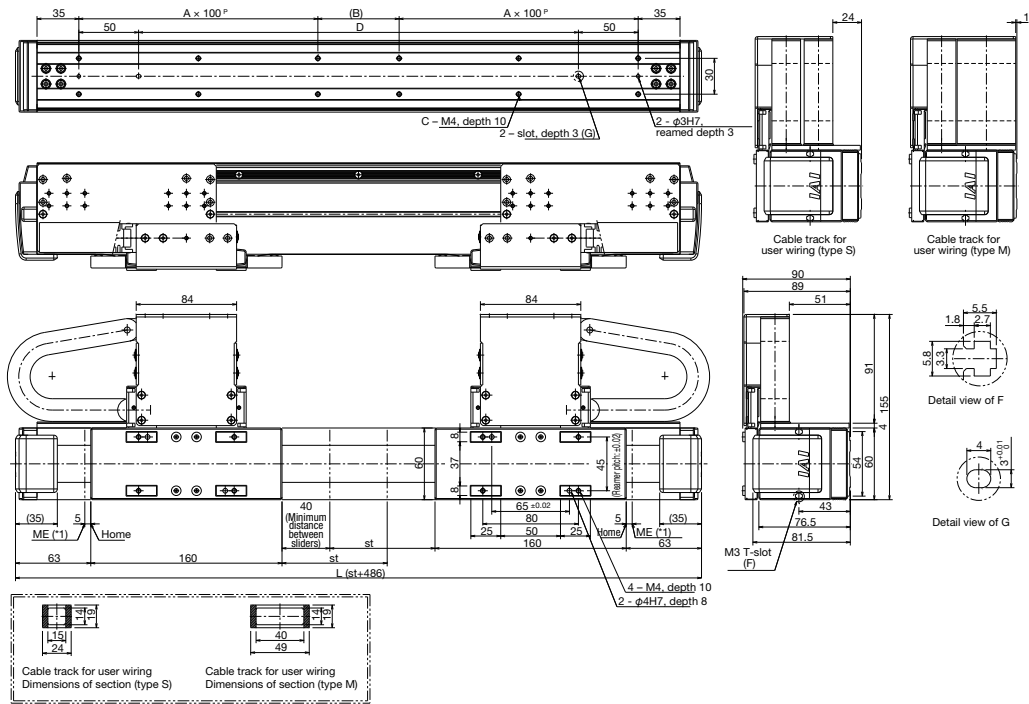

Stroke	40	88	136	184	232	280	328	376	424	472	520	568	616	664	712	760	808	856	904	952	1000	1048
L	526	574	622	670	718	766	814	862	910	958	1006	1054	1102	1150	1198	1246	1294	1342	1390	1438	1486	1534
A	2	2	2	2	3	3	3	3	3	4	4	4	4	5	5	5	5	6	6	6	6	7
B	20	68	116	164	12	60	108	156	204	52	100	148	196	44	92	140	188	36	84	132	180	28
C	12	12	12	12	16	16	16	16	16	20	20	20	20	24	24	24	24	28	28	28	28	32
D	320	368	416	464	512	560	608	656	704	752	800	848	896	944	992	1040	1088	1136	1184	1232	1280	1328
Weight (kg)	6.4	6.6	6.8	7.0	7.2	7.4	7.6	7.8	8.0	8.2	8.5	8.7	8.9	9.1	9.3	9.5	9.7	9.9	10.1	10.3	10.5	10.8

Shaft type
Small type
Flat type
Medium type
Large type

LSA-S8SS

Shaft type, 80 mm
Standard type, single-slider



Model Name **LSA-S8SS** - **I** - **100** - **T2** - **X** - **X**

Series — Type — Encoder type — Applicable drive output — Stroke — Applicable controller — Cable length — Options

I: Incremental specification 100W 100 : 60:60mm } T2 : SCON S: 3m N: None Refer to the options table below.
SSEL M: 5m XSEL-P/-Q X□□:

* Refer to P.13 for details on each item comprising the model name. 1620:1620mm

Model Specifications

Model	Encoder type	Applicable drive output (per slider)	Stroke Specified in 60-mm steps (mm)	Speed (Note 1) (mm/sec)	Payload (Note 2)		Rated thrust (N)	Maximum thrust (N)	Maximum acceleration (G) (Note 2)
					Horizontal (kg)	Vertical (kg)			
LSA-S8SS-I-100-1-1-T2-2-X	I: Incremental	100	60-1620	2500	5	-	25	100	3

* In the above model names, 1 indicates the stroke, 2 indicates the cable length, and X indicates the options.

Options

Name	Model	Reference page	Remarks
Cable track installation direction	CT2-6	→P14	Installation directions 2 to 6
Cable track for user wiring, type S	US1-6	→P14	Installation directions 1 to 6
Cable track for user wiring, type M	UM1-6	→P14	Installation directions 1 to 6

Common Specifications

Drive method	Linear servo motor
Positioning repeatability	±0.005mm
Guide	Built-in linear guide
Permissible load moment	Ma: 42.2N • m Mb: 60.3 • m Mc: 37.6N • m
Overhang load length	300 mm or less in Ma direction / 300 mm or less in Mb/Mc directions
Base	Material: Aluminum with white alumite treatment
Applicable controller	T2: SCON, SSEL, XSEL-P/Q
Cable length (Note 3)	N: No Cable S: 3m M: 5m X□□: Specified length
Ambient operating temperature	0 to 40°C, 85% RH or below (non-condensing)

Dimensions

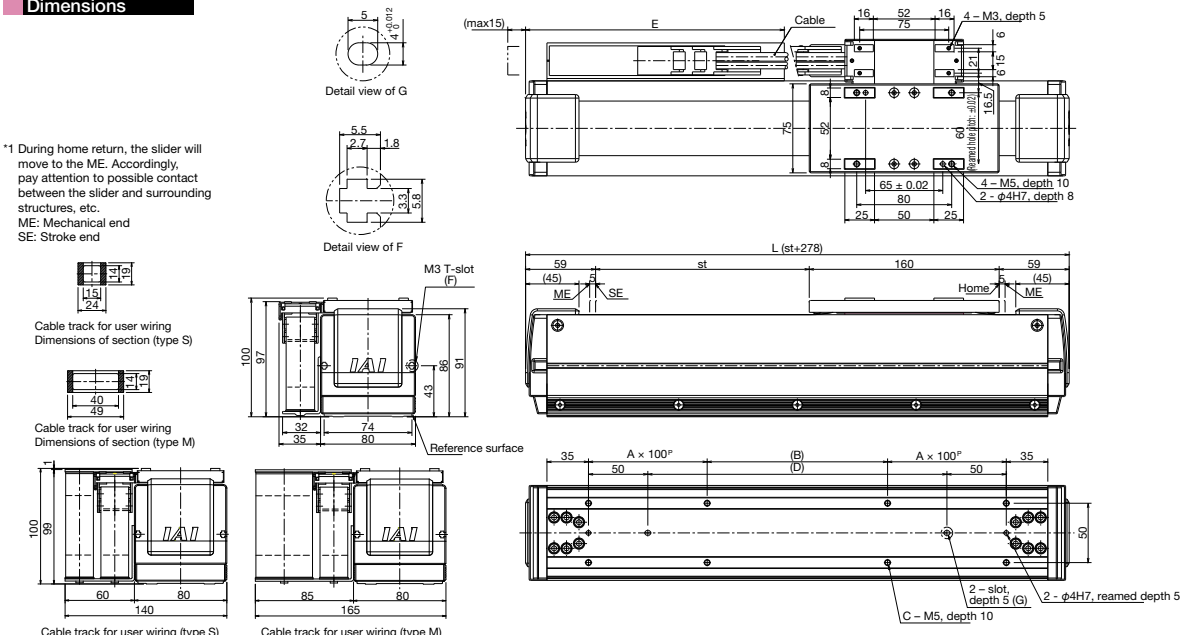

Stroke	60	120	180	240	300	360	420	480	540	600	660	720	780	840	900	960	1020	1080	1140	1200	1260	1320	1380	1440	1500	1560	1620
L	338	398	458	518	578	638	698	758	818	878	938	998	1058	1118	1178	1238	1298	1358	1418	1478	1538	1598	1658	1718	1778	1838	1898
A	1	1	1	2	2	2	2	3	3	3	4	4	4	5	5	5	5	6	6	6	7	7	7	8	8	8	8
B	32	92	152	212	272	332	392	452	512	572	632	692	752	812	872	932	992	1052	1112	1172	1232	1292	1352	1412	1472	1532	1592
C	8	8	8	12	12	12	12	16	16	16	20	20	20	24	24	24	24	28	28	28	32	32	32	36	36	36	36
D	132	192	252	312	372	432	492	552	612	672	732	792	852	912	972	1032	1092	1152	1212	1272	1332	1392	1452	1512	1572	1632	1692
E	168	193	218	243	268	293	318	343	368	393	418	443	468	493	518	543	568	593	618	643	668	693	718	743	768	793	818
Weight (kg)	4.4	4.7	5.1	5.4	5.8	6.1	6.5	6.9	7.2	7.6	7.9	8.3	8.7	9.0	9.4	9.7	10.1	10.4	10.8	11.2	11.5	11.9	12.2	12.6	12.9	13.3	13.7

Applicable Controller Specifications

Applicable controller	Maximum controlled axes	Operating method	Power-supply voltage	Reference page
XSEL	6 axes	Program	Single-phase/ three-phase AC 200 V	→P53
SSEL	2 axes	Program/positioner	Single-phase AC100/200V	→P52
SCON	1 axis	Pulse train/positioner	Single-phase AC100/200V	→P51

Caution

(Note 1) The maximum speed may not be attained if the stroke is short.
(Note 2) The maximum acceleration varies depending on the operating conditions.
(Note 3) The maximum cable length is 20 m for the SCON/SSEL and 30 m for the XSEL. Specify a desired length in units of meters.
(Example: X08 = 8 m)

LSA-S8SM

Shaft type, 80 mm wide
Standard type, multi-slider



■ Model Name **LSA-S8SM - I - 100 - T2**

Series — Type — Encoder type — Applicable drive output — Stroke — Applicable controller — Cable length — Options

I: Incremental specification 100 : 60:60mm 100W } T2 : SCON SSEL XSEL-P/-Q X□□: N: None S: 3m M: 5m Refer to the options table below.

* Refer to P. 13 for details on each item comprising the model name. 1440:1440mm

Model Specifications

Model	Encoder type	Applicable drive output (per slider)	Stroke Specified in 60-mm steps (mm)	Speed (Note 1) (mm/sec)	Payload (Note 2)		Rated thrust (N)	Maximum thrust (N)	Maximum acceleration (G) (Note 2)
					Horizontal (kg)	Vertical (kg)			
LSA-S8SM-I-100-1-T2-2-3	I: Incremental	100	60-1440	2500	5	-	25	100	3

* In the above model names, 1 indicates the stroke, 2 indicates the cable length, and 3 indicates the options.

Options

Name	Model	Reference page	Remarks
Cable track installation direction	CT5	→P14	Sideway specification
Cable track for user wiring, type S	US1/US5	→P14	Standard specification/sideway specification
Cable track for user wiring, type M	UM1/UM5	→P14	Standard specification/sideway specification

Note) To change the cable track position to the opposite side, install the actuator by rotating it 180 degrees horizontally because the actuator is bilaterally symmetrical.

Common Specifications

Drive method	Linear servo motor
Positioning repeatability	±0.005mm
Guide	Built-in linear guide
Permissible load moment	Ma: 42.2N • m Mb: 60.3 • m Mc: 37.6N • m
Overhang load length	300 mm or less in Ma direction / 300 mm or less in Mb/Mc directions
Base	Material: Aluminum with white alumite treatment
Applicable controller	T2: SCON, SSEL, XSEL-P/Q
Cable length (Note 3)	N: No Cable S: 3m M: 5m X□□: Specified length
Ambient operating temperature	0 to 40°C, 85% RH or below (non-condensing)

Dimensions

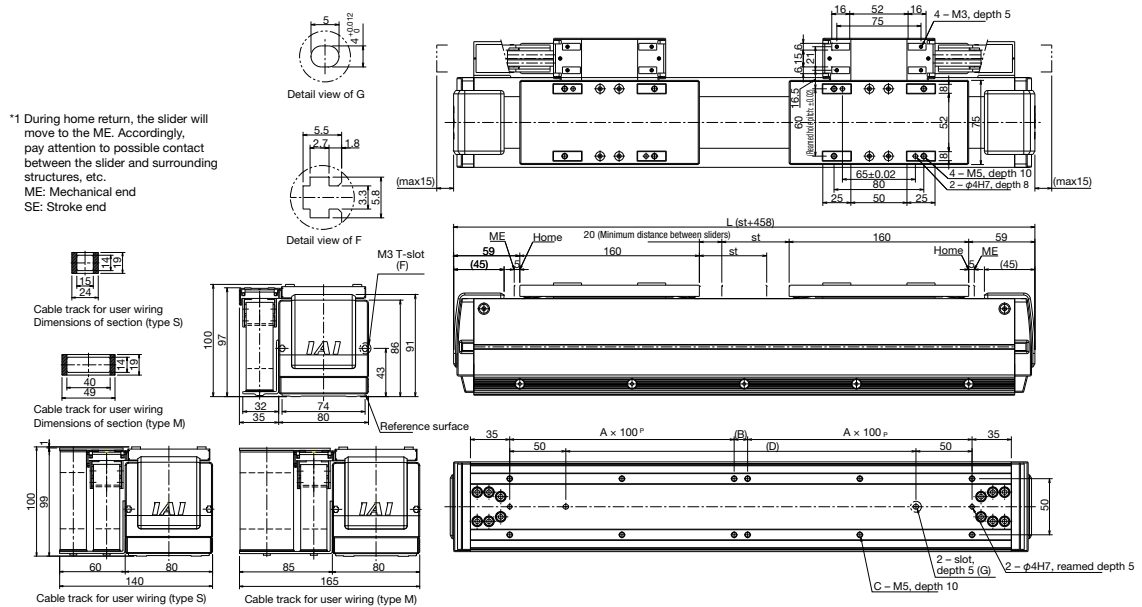

Stroke	60	120	180	240	300	360	420	480	540	600	660	720	780	840	900	960	1020	1080	1140	1200	1260	1320	1380	1440
L	518	578	638	698	758	818	878	938	998	1058	1118	1178	1238	1298	1358	1418	1478	1538	1598	1658	1718	1778	1838	1898
A	2	2	2	2	3	3	3	4	4	4	5	5	5	5	6	6	6	7	7	7	8	8	8	8
B	12	72	132	192	52	112	172	32	92	152	212	272	332	392	452	512	572	632	692	752	812	872	932	992
C	12	12	12	12	16	16	16	20	20	20	24	24	24	24	28	28	28	32	32	32	36	36	36	36
D	312	372	432	492	552	612	672	732	792	852	912	972	1032	1092	1152	1212	1272	1332	1392	1452	1512	1572	1632	1692
Weight(kg)	7.4	7.7	8.1	8.4	8.8	9.1	9.5	9.9	10.2	10.6	10.9	11.3	11.6	12.0	12.4	12.7	13.1	13.4	13.8	14.1	14.5	14.9	15.2	15.6

Applicable Controller Specifications

Applicable controller	Maximum controlled axes	Operating method	Power-supply voltage	Reference page
XSEL	6 axes	Program	Single-phase/ three-phase AC 200 V	→P53
SSEL	2 axes	Program/positioner	Single-phase AC100/200V	→P52
SCON	1 axis	Pulse train/positioner	Single-phase AC100/200V	→P51

Caution

(Note 1) The maximum speed may not be attained if the stroke is short.
(Note 2) The maximum acceleration varies depending on the operating conditions.
(Note 3) The maximum cable length is 20 m for the SCON/SSEL and 30 m for the XSEL. Specify a desired length in units of meters.
(Example: X08 = 8 m)

Shaft type

Small type

Flat type

Medium type

Large type

21

LSA-S8SM

Dimensions – Sideway Specification

*1 During home return, the slider will move to the ME. Accordingly, pay attention to possible contact between the slider and surrounding structures, etc.
 ME: Mechanical end
 SE: Stroke end

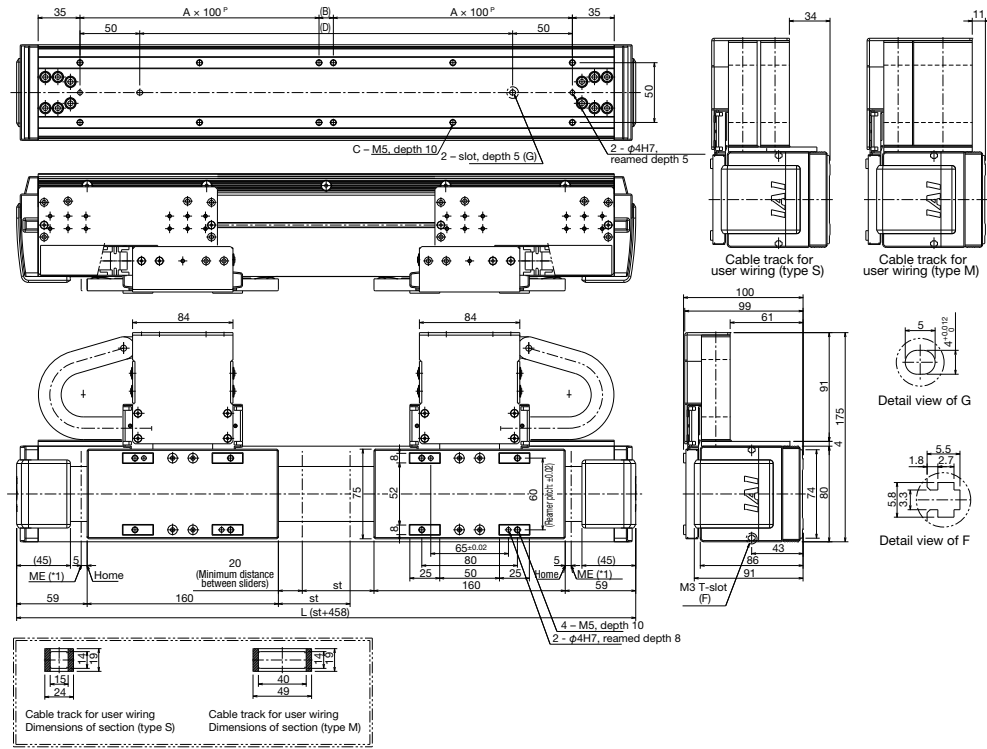

Stroke	60	120	180	240	300	360	420	480	540	600	660	720	780	840	900	960	1020	1080	1140	1200	1260	1320	1380	1440
L	518	578	638	698	758	818	878	938	998	1058	1118	1178	1238	1298	1358	1418	1478	1538	1598	1658	1718	1778	1838	1898
A	2	2	2	2	3	3	3	4	4	4	5	5	5	5	6	6	6	7	7	7	8	8	8	8
B	12	72	132	192	52	112	172	32	92	152	12	72	132	192	52	112	172	32	92	152	12	72	132	192
C	12	12	12	12	16	16	16	20	20	20	24	24	24	24	28	28	28	32	32	32	36	36	36	36
D	312	372	432	492	552	612	672	732	792	852	912	972	1032	1092	1152	1212	1272	1332	1392	1452	1512	1572	1632	1692
Weight(kg)	8.4	8.7	9.1	9.4	9.8	10.1	10.5	10.9	11.2	11.6	11.9	12.3	12.6	13.0	13.4	13.7	14.1	14.4	14.8	15.1	15.5	15.9	16.2	16.6

Shaft type
 Small type
 Flat type
 Medium type
 Large type

LSA-S8HS

Shaft type, 80 mm wide
High-thrust type, single-slider



■ Model Name **LSA-S8HS - I - 100 - [] - T2 - [] - []**

Series — Type — Encoder type — Applicable drive output — Stroke — Applicable controller — Cable length — Options

I : Incremental specification 100 : 60:60mm 100W } T2 : SCON SSEL XSEL-P/-Q N: None S: 3m M: 5m Refer to the options table below. X[]: Specified length

* Refer to P. 13 for details on each item comprising the model name. 1620:1620mm

Model Specifications

Model	Encoder type	Applicable drive output (per slider)	Stroke Specified in 60-mm steps (mm)	Speed (Note 1) (mm/sec)	Payload (Note 2)		Rated thrust (N)	Maximum thrust (N)	Maximum acceleration (G) (Note 2)
					Horizontal (kg)	Vertical (kg)			
LSA-S8HS-I-100-[]-T2-[]-[]	I: Incremental	100	60-1620	2500	7	—	35	140	3

* In the above model names, [] indicates the stroke, [] indicates the cable length, and [] indicates the options.

Options

Name	Model	Reference page	Remarks
Cable track installation direction	CT2-6	→P14	Installation directions 2 to 6
Cable track for user wiring, type S	US1-6	→P14	Installation directions 1 to 6
Cable track for user wiring, type M	UM1-6	→P14	Installation directions 1 to 6

Common Specifications

Drive method	Linear servo motor
Positioning repeatability	±0.005mm
Guide	Built-in linear guide
Permissible load moment	Ma: 42.2N • m Mb: 60.3 • m Mc: 37.6N • m
Overhang load length	300 mm or less in Ma direction / 300 mm or less in Mb/Mc directions
Base	Material: Aluminum with white alumite treatment
Applicable controller	T2: SCON, SSEL, XSEL-P/Q
Cable length (Note 3)	N: No Cable S: 3m M: 5m X[]: Specified length
Ambient operating temperature	0 to 40°C, 85% RH or below (non-condensing)

Dimensions

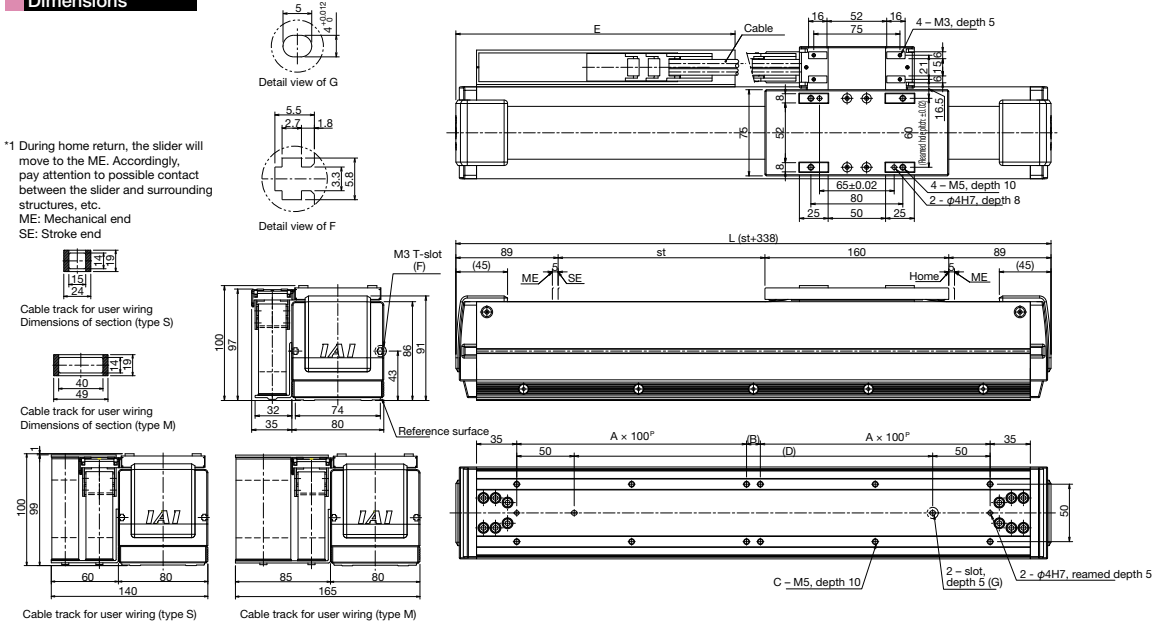

Stroke	60	120	180	240	300	360	420	480	540	600	660	720	780	840	900	960	1020	1080	1140	1200	1260	1320	1380	1440	1500	1560	1620
L	398	458	518	578	638	698	758	818	878	938	998	1058	1118	1178	1238	1298	1358	1418	1478	1538	1598	1658	1718	1778	1838	1898	1958
A	1	1	2	2	2	2	3	3	3	4	4	4	5	5	5	6	6	6	7	7	7	7	8	8	8	8	9
B	92	152	12	72	132	192	52	112	172	32	92	152	12	72	132	192	52	112	172	32	92	152	12	72	132	192	52
C	8	8	12	12	12	12	16	16	16	20	20	20	24	24	24	28	28	28	32	32	32	32	36	36	36	36	40
D	192	252	312	372	432	492	552	612	672	732	792	852	912	972	1032	1092	1152	1212	1272	1332	1392	1452	1512	1572	1632	1692	1752
E	193	218	243	268	293	318	343	368	393	418	443	468	493	518	543	568	593	618	643	668	693	718	743	768	793	818	843
Weight(kg)	5.0	5.4	5.7	6.1	6.4	6.8	7.1	7.5	7.9	8.2	8.6	8.9	9.3	9.6	10.0	10.4	10.7	11.1	11.4	11.8	12.1	12.5	12.9	13.2	13.6	13.9	14.3

Applicable Controller Specifications

Applicable controller	Maximum controlled axes	Operating method	Power-supply voltage	Reference page
XSEL	6 axes	Program	Single-phase/ three-phase AC 200 V	→P53
SSEL	2 axes	Program/positioner	Single-phase AC100/200V	→P52
SCON	1 axis	Pulse train/positioner	Single-phase AC100/200V	→P51



(Note 1) The maximum speed may not be attained if the stroke is short.
(Note 2) The maximum acceleration varies depending on the operating conditions.
(Note 3) The maximum cable length is 20 m for the SCON/SSEL and 30 m for the XSEL. Specify a desired length in units of meters.
(Example: X08 = 8 m)

Shaft type

Small type

Flat type

Medium type

Large type

Dimensions – Sideway Specification (Standard)

*1 During home return, the slider will move to the ME. Accordingly, pay attention to possible contact between the slider and surrounding structures, etc.
ME: Mechanical end
SE: Stroke end

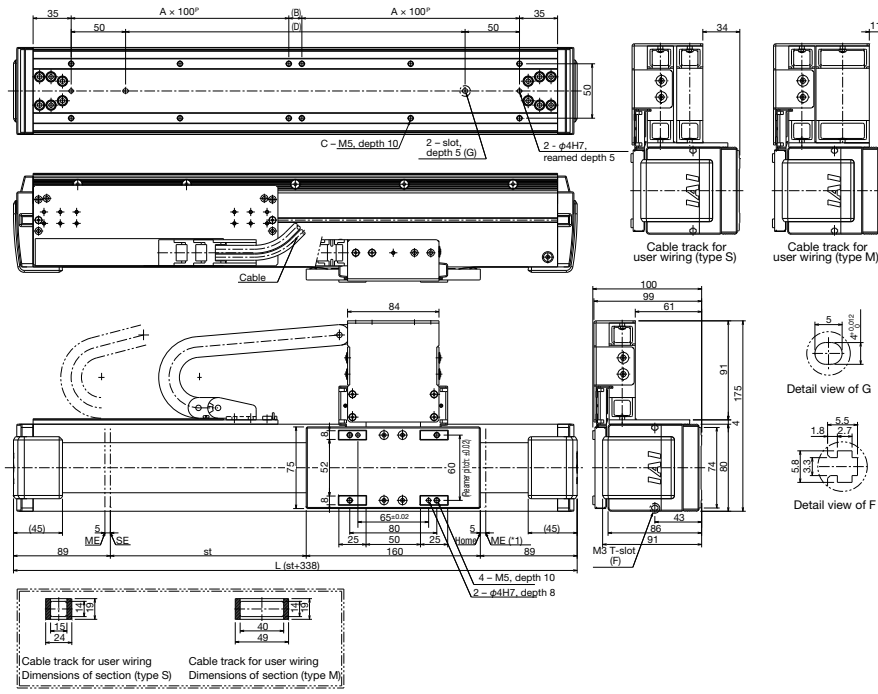

Stroke	60	120	180	240	300	360	420	480	540	600	660	720	780	840	900	960	1020	1080	1140	1200	1260	1320	1380	1440	1500	1560	1620
L	398	458	518	578	638	698	758	818	878	938	998	1058	1118	1178	1238	1298	1358	1418	1478	1538	1598	1658	1718	1778	1838	1898	1958
A	1	1	2	2	2	2	3	3	3	4	4	4	5	5	5	5	6	6	6	7	7	7	8	8	8	8	9
B	92	152	12	72	132	192	52	112	172	32	92	152	12	72	132	192	52	112	172	32	92	152	12	72	132	192	52
C	8	8	12	12	12	12	16	16	16	20	20	20	24	24	24	24	28	28	28	32	32	32	36	36	36	36	40
D	192	252	312	372	432	492	552	612	672	732	792	852	912	972	1032	1092	1152	1212	1272	1332	1392	1452	1512	1572	1632	1692	1752
Weight(kg)	5.5	5.9	6.2	6.6	6.9	7.3	7.6	8.0	8.4	8.7	9.1	9.4	9.8	10.1	10.5	10.9	11.2	11.6	11.9	12.3	12.6	13.1	13.4	13.7	14.1	14.4	14.8

Dimensions – Sideway Specification (Cable Track, Opposite)

*1 During home return, the slider will move to the ME. Accordingly, pay attention to possible contact between the slider and surrounding structures, etc.
ME: Mechanical end
SE: Stroke end

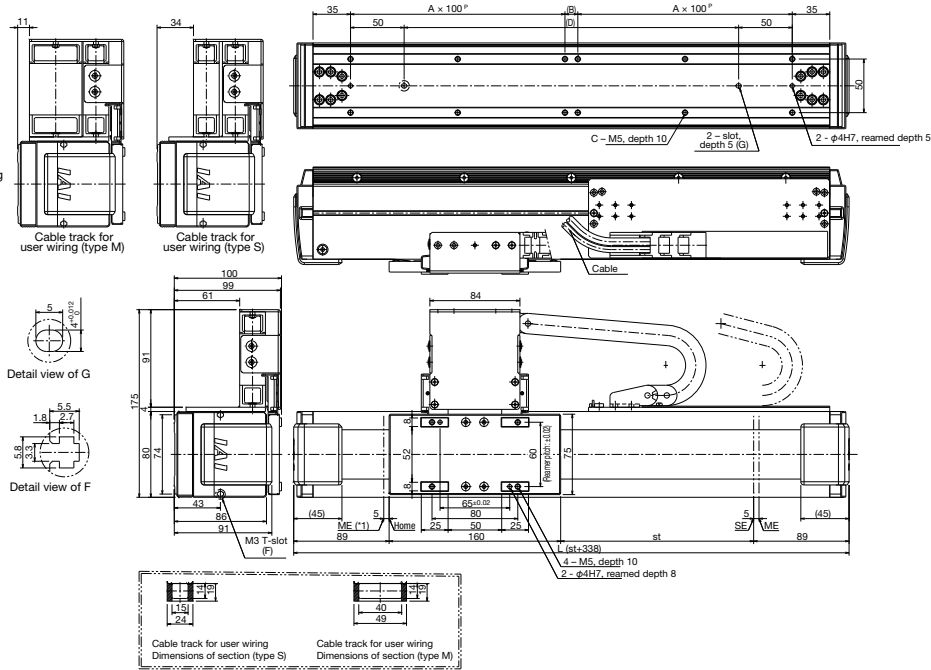

Stroke	60	120	180	240	300	360	420	480	540	600	660	720	780	840	900	960	1020	1080	1140	1200	1260	1320	1380	1440	1500	1560	1620
L	398	458	518	578	638	698	758	818	878	938	998	1058	1118	1178	1238	1298	1358	1418	1478	1538	1598	1658	1718	1778	1838	1898	1958
A	1	1	2	2	2	2	3	3	3	4	4	4	5	5	5	5	6	6	6	7	7	7	8	8	8	8	9
B	92	152	12	72	132	192	52	112	172	32	92	152	12	72	132	192	52	112	172	32	92	152	12	72	132	192	52
C	8	8	12	12	12	12	16	16	16	20	20	20	24	24	24	24	28	28	28	32	32	32	36	36	36	36	40
D	192	252	312	372	432	492	552	612	672	732	792	852	912	972	1032	1092	1152	1212	1272	1332	1392	1452	1512	1572	1632	1692	1752
Weight(kg)	5.5	5.9	6.2	6.6	6.9	7.3	7.6	8.0	8.4	8.7	9.1	9.4	9.8	10.1	10.5	10.9	11.2	11.6	11.9	12.3	12.6	13.1	13.4	13.7	14.1	14.4	14.8

Shaft type

Small type

Flat type

Medium type

Large type

LSA-S8HM

Shaft type, 80 mm wide
High-thrust type, multi-slider



■ Model Name **LSA-S8HM-I-100-T2**

Series — Type — Encoder type — Applicable drive output — Stroke — Applicable controller — Cable length — Options

I: Incremental 100 : 60:60mm 100W } T2 : N: None Refer to the options specification 100W } SCON: S: 3m table below. SSEL: M: 5m XSEL-P/-Q X□□:

* Refer to P. 13 for details on each item comprising the model name. 1380:1380mm

Model Specifications

Model	Encoder type	Applicable drive output (per slider)	Stroke Specified in 60-mm steps (mm)	Speed (Note 1) (mm/sec)	Payload (Note 2)		Rated thrust (N)	Maximum thrust (N)	Maximum acceleration (G) (Note 2)
					Horizontal (kg)	Vertical (kg)			
LSA-S8HM-I-100-□-T2-□-□	I: Incremental	100	60-1380	2500	7	-	35	140	3

* In the above model names, □ indicates the stroke, □ indicates the cable length, and □ indicates the options.

Options

Name	Model	Reference page	Remarks
Cable track installation direction	CT5	→P14	Sideway specification
Cable track for user wiring, type S	US1/US5	→P14	Standard specification/sideway specification
Cable track for user wiring, type M	UM1/UM5	→P14	Standard specification/sideway specification

Note) To change the cable track position to the opposite side, install the actuator by rotating it 180 degrees horizontally because the actuator is bilaterally symmetrical.

Common Specifications

Drive method	Linear servo motor
Positioning repeatability	±0.005mm
Guide	Built-in linear guide
Permissible load moment	Ma: 42.2N • m Mb: 60.3 • m Mc: 37.6N • m
Overhang load length	300 mm or less in Ma direction / 300 mm or less in Mb/Mc directions
Base	Material: Aluminum with white alumite treatment
Applicable controller	T2: SCON, SSEL, XSEL-P/Q
Cable length (Note 3)	N: No Cable S: 3m M: 5m X□□: Specified length
Ambient operating temperature	0 to 40°C, 85% RH or below (non-condensing)

Dimensions

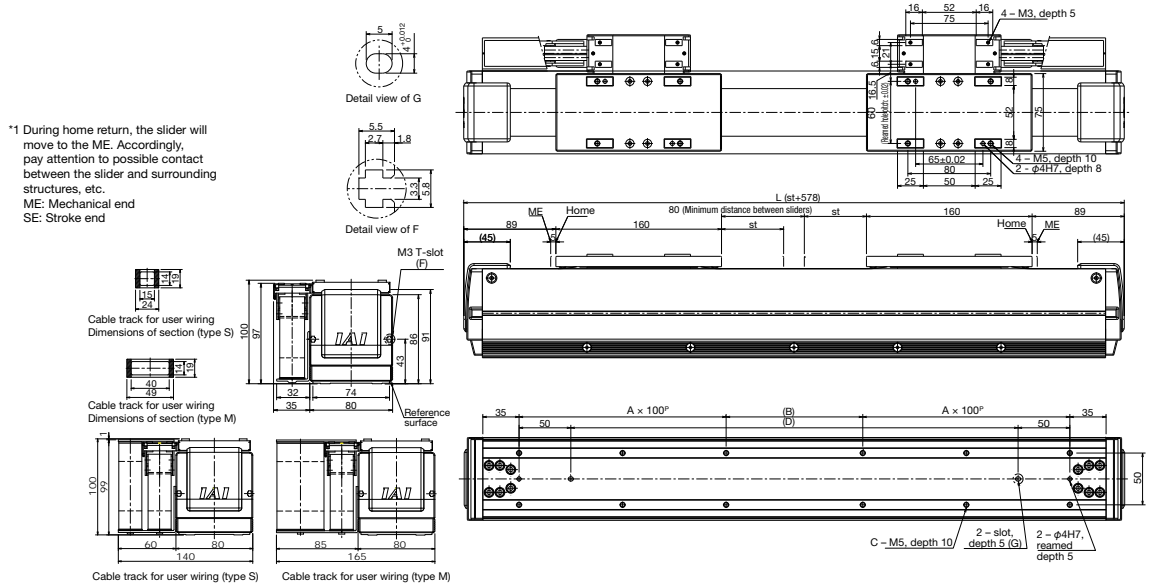

Stroke	60	120	180	240	300	360	420	480	540	600	660	720	780	840	900	960	1020	1080	1140	1200	1260	1320	1380
L	638	698	758	818	878	938	998	1058	1118	1178	1238	1298	1358	1418	1478	1538	1598	1658	1718	1778	1838	1898	1958
A	2	2	3	3	3	4	4	4	5	5	5	5	6	6	6	7	7	7	8	8	8	8	9
B	132	192	52	112	172	32	92	152	12	72	132	192	52	112	172	32	92	152	12	72	132	192	52
C	12	12	16	16	16	20	20	20	24	24	24	24	28	28	28	32	32	32	36	36	36	36	40
D	432	492	552	612	672	732	792	852	912	972	1032	1092	1152	1212	1272	1332	1392	1452	1512	1572	1632	1692	1752
Weight(kg)	8.6	9.0	9.3	9.7	10.1	10.4	10.8	11.1	11.5	11.9	12.2	12.6	12.9	13.3	13.6	14.0	14.4	14.7	15.1	15.4	15.8	16.1	16.5

Applicable Controller Specifications

Applicable controller	Maximum controlled axes	Operating method	Power-supply voltage	Reference page
XSEL	6 axes	Program	Single-phase/ three-phase AC 200 V	→P53
SSEL	2 axes	Program/positioner	Single-phase AC100/200V	→P52
SCON	1 axis	Pulse train/positioner	Single-phase AC100/200V	→P51



Caution

(Note 1) The maximum speed may not be attained if the stroke is short.
(Note 2) The maximum acceleration varies depending on the operating conditions.
(Note 3) The maximum cable length is 20 m for the SCON/SSEL and 30 m for the XSEL. Specify a desired length in units of meters.
(Example: X08 = 8 m)

25 LSA-S8HM

LSA-S10SS Shaft type, 100 mm wide Standard type, single-slider



Model Name LSA-S10SS- I - 200 - - T2 - -
 Series — Type — Encoder type — Applicable drive output — Stroke — Applicable controller — Cable length — Options
 I: Incremental specification 200 : 200W 90:90mm 2 T2 : SCON S: 3m N: None Refer to the options table below. SSEL M: 5m XSEL-P/-Q X :

* Refer to P. 13 for details on each item comprising the model name. 2070:2070mm

Model Specifications

Model	Encoder type	Applicable drive output (per slider)	Stroke Specified in 90-mm steps (mm)	Speed (Note 1) (mm/sec)	Payload (Note 2)		Rated thrust (N)	Maximum thrust (N)	Maximum acceleration (G) (Note 2)
					Horizontal (kg)	Vertical (kg)			
LSA-S10SS-I-200- <input type="checkbox"/> -T2- <input type="checkbox"/> - <input type="checkbox"/>	I: Incremental	200	90-2070	2500	15	-	65	260	3

* In the above model names, indicates the stroke, indicates the cable length, and indicates the options.

Options

Name	Model	Reference page	Remarks
Cable track installation direction	CT2-6	→P14	Installation directions 2 to 6
Cable track for user wiring, type S	US1-6	→P14	Installation directions 1 to 6
Cable track for user wiring, type M	UM1-6	→P14	Installation directions 1 to 6

Common Specifications

Drive method	Linear servo motor
Positioning repeatability	±0.005mm
Guide	Built-in linear guide
Permissible load moment	Ma: 57.4N • m Mb: 81.9 • m Mc: 60.8N • m
Overhang load length	300 mm or less in Ma direction / 300 mm or less in Mb/Mc directions
Base	Material: Aluminum with white alumite treatment
Applicable controller	T2: SCON, SSEL, XSEL-P/Q
Cable length (Note 3)	N: No Cable S: 3m M: 5m X <input type="checkbox"/> : Specified length
Ambient operating temperature	0 to 40°C, 85% RH or below (non-condensing)

Dimensions

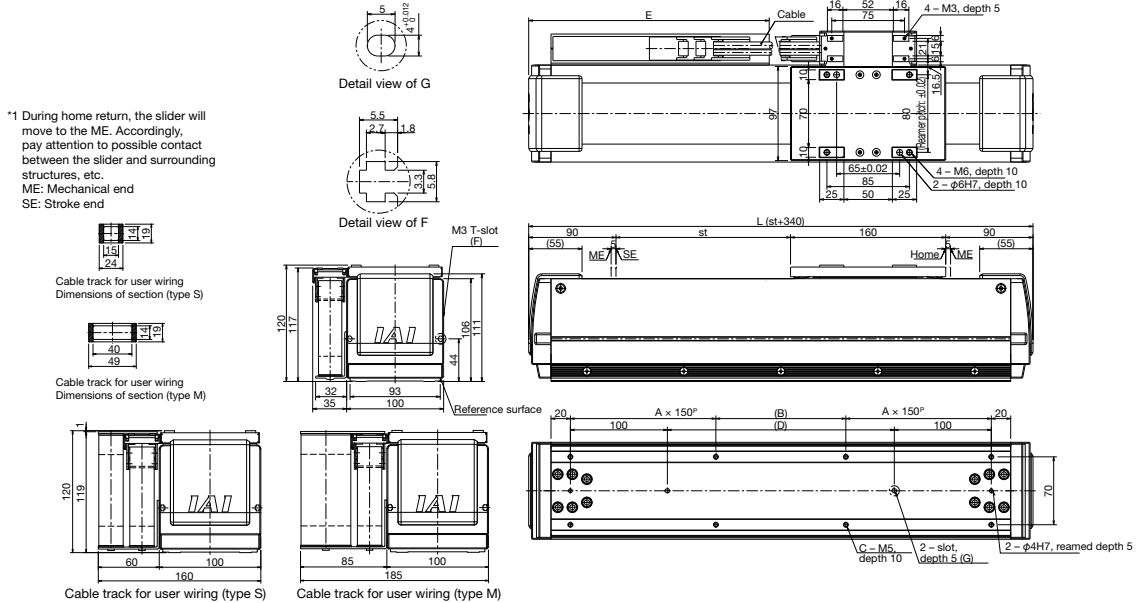

Stroke	90	180	270	360	450	540	630	720	810	900	990	1080	1170	1260	1350	1440	1530	1620	1710	1800	1890	1980	2070
L	430	520	610	700	790	880	970	1060	1150	1240	1330	1420	1510	1600	1690	1780	1870	1960	2050	2140	2230	2320	2410
A	1	1	1	2	2	2	2	3	3	3	4	4	4	5	5	5	5	6	6	6	7	7	7
B	44	134	224	14	104	194	284	74	164	254	44	134	224	14	104	194	284	74	164	254	44	134	224
C	8	8	8	12	12	12	12	16	16	16	20	20	20	24	24	24	24	28	28	28	32	32	32
D	144	234	324	414	504	594	684	774	864	954	1044	1134	1224	1314	1404	1494	1584	1674	1764	1854	1944	2034	2124
E	198	248	273	323	373	423	473	498	548	598	648	698	723	773	823	873	923	948	998	1048	1098	1148	1173
Weight(kg)	8.4	9.2	10.1	10.9	11.7	12.6	13.4	14.2	15.1	15.9	16.7	17.6	18.4	19.2	20.1	20.9	21.7	22.6	23.4	24.2	25.1	25.9	26.7

Applicable Controller Specifications

Applicable controller	Maximum controlled axes	Operating method	Power-supply voltage	Reference page
XSEL	6 axes	Program	Single-phase/ three-phase AC 200 V	→P53
SSEL	2 axes	Program/positioner	Single-phase AC100/200V	→P52
SCON	1 axis	Pulse train/positioner	Single-phase AC100/200V	→P51

Caution

(Note 1) The maximum speed may not be attained if the stroke is short.
 (Note 2) The maximum acceleration varies depending on the operating conditions.
 (Note 3) The maximum cable length is 20 m for the SCON/SSEL and 30 m for the XSEL. Specify a desired length in units of meters. (Example: X08 = 8 m)

Dimensions – Sideway Specification (Standard)

*1 During home return, the slider will move to the ME. Accordingly, pay attention to possible contact between the slider and surrounding structures, etc.
ME: Mechanical end
SE: Stroke end

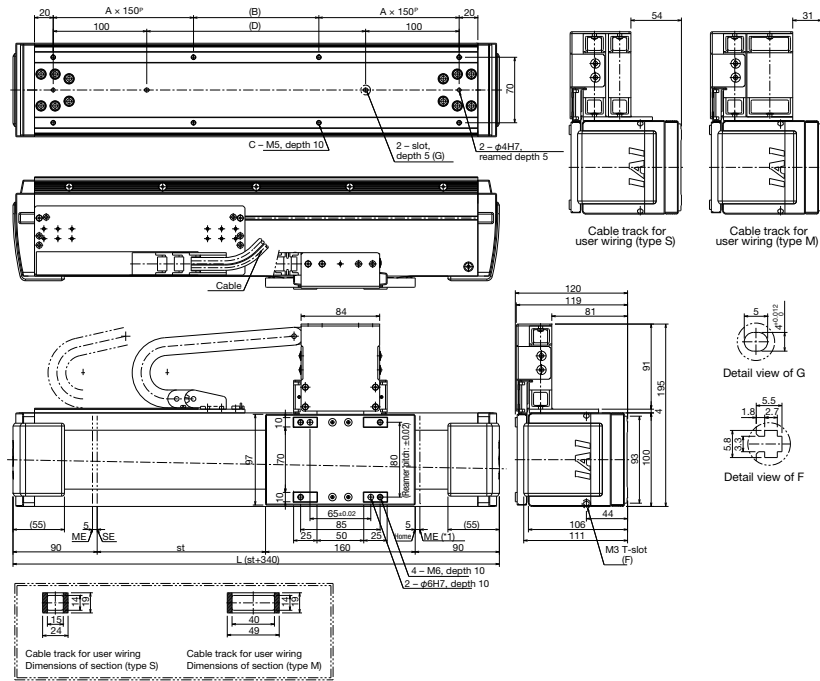

Stroke	90	180	270	360	450	540	630	720	810	900	990	1080	1170	1260	1350	1440	1530	1620	1710	1800	1890	1980	2070
L	430	520	610	700	790	880	970	1060	1150	1240	1330	1420	1510	1600	1690	1780	1870	1960	2050	2140	2230	2320	2410
A	1	1	1	2	2	2	2	3	3	3	4	4	4	5	5	5	5	6	6	6	7	7	7
B	44	134	224	14	104	194	284	74	164	254	44	134	224	14	104	194	284	74	164	254	44	134	224
C	8	8	8	12	12	12	12	16	16	16	20	20	20	24	24	24	24	28	28	28	32	32	32
D	144	234	324	414	504	594	684	774	864	954	1044	1134	1224	1314	1404	1494	1584	1674	1764	1854	1944	2034	2124
Weight(kg)	8.9	9.7	10.6	11.4	12.3	13.1	13.9	14.7	15.6	16.4	17.2	18.1	18.9	19.7	20.6	21.4	22.2	23.1	23.9	24.7	25.6	26.4	27.2

Dimensions – Sideway Specification (Cable Track, Opposite)

*1 During home return, the slider will move to the ME. Accordingly, pay attention to possible contact between the slider and surrounding structures, etc.
ME: Mechanical end
SE: Stroke end

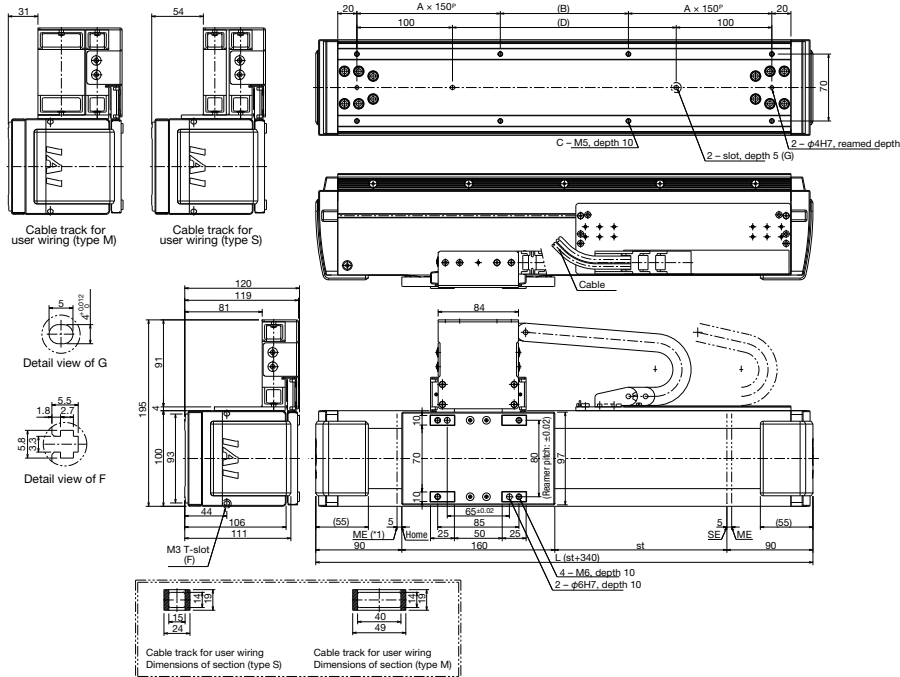

Stroke	90	180	270	360	450	540	630	720	810	900	990	1080	1170	1260	1350	1440	1530	1620	1710	1800	1890	1980	2070
L	430	520	610	700	790	880	970	1060	1150	1240	1330	1420	1510	1600	1690	1780	1870	1960	2050	2140	2230	2320	2410
A	1	1	1	2	2	2	2	3	3	3	4	4	4	5	5	5	5	6	6	6	7	7	7
B	44	134	224	14	104	194	284	74	164	254	44	134	224	14	104	194	284	74	164	254	44	134	224
C	8	8	8	12	12	12	12	16	16	16	20	20	20	24	24	24	24	28	28	28	32	32	32
D	144	234	324	414	504	594	684	774	864	954	1044	1134	1224	1314	1404	1494	1584	1674	1764	1854	1944	2034	2124
Weight(kg)	8.9	9.7	10.6	11.4	12.3	13.1	13.9	14.7	15.6	16.4	17.2	18.1	18.9	19.7	20.6	21.4	22.2	23.1	23.9	24.7	25.6	26.4	27.2

Shaft type

Small type

Flat type

Medium type

Large type

LSA-S10SM

Shaft type, 100 mm wide
Standard type, multi-slider



■ Model Name **LSA-S10SM-I-200** - - **T2** - -

Series — Type — Encoder type — Applicable drive output — Stroke — Applicable controller — Cable length — Options

I: Incremental specification 200 : 200W 60 : 60mm 1860 : 1860mm } T2 : N: None S: 3m M: 5m XSEL-P/-Q X□□: Refer to the options table below.

* Refer to P. 13 for details on each item comprising the model name. 1860:1860mm

Model Specifications

Model	Encoder type	Applicable drive output (per slider)	Stroke Specified in 90-mm steps (mm)	Speed (Note 1) (mm/sec)	Payload (Note 2)		Rated thrust (N)	Maximum thrust (N)	Maximum acceleration (G) (Note 2)
					Horizontal (kg)	Vertical (kg)			
LSA-S10SM-I-200- <input type="checkbox"/> -T2- <input type="checkbox"/> - <input type="checkbox"/>	I: Incremental	200	60-1860	2500	15	-	65	260	3

* In the above model names, indicates the stroke, indicates the cable length, and indicates the options.

Options

Name	Model	Reference page	Remarks
Cable track installation direction	CT5	→P14	Sideway specification
Cable track for user wiring, type S	US1/US5	→P14	Standard specification/sideway specification
Cable track for user wiring, type M	UM1/UM5	→P14	Standard specification/sideway specification

Note) To change the cable track position to the opposite side, install the actuator by rotating it 180 degrees horizontally because the actuator is bilaterally symmetrical.

Common Specifications

Drive method	Linear servo motor
Positioning repeatability	±0.005mm
Guide	Built-in linear guide
Permissible load moment	Ma: 57.4N • m Mb: 81.9 • m Mc: 60.8N • m
Overhang load length	300 mm or less in Ma direction / 300 mm or less in Mb/Mc directions
Base	Material: Aluminum with white alumite treatment
Applicable controller	T2: SCON, SSEL, XSEL-P/Q
Cable length (Note 3)	N: No Cable S: 3m M: 5m X□□: Specified length
Ambient operating temperature	0 to 40°C, 85% RH or below (non-condensing)

Dimensions

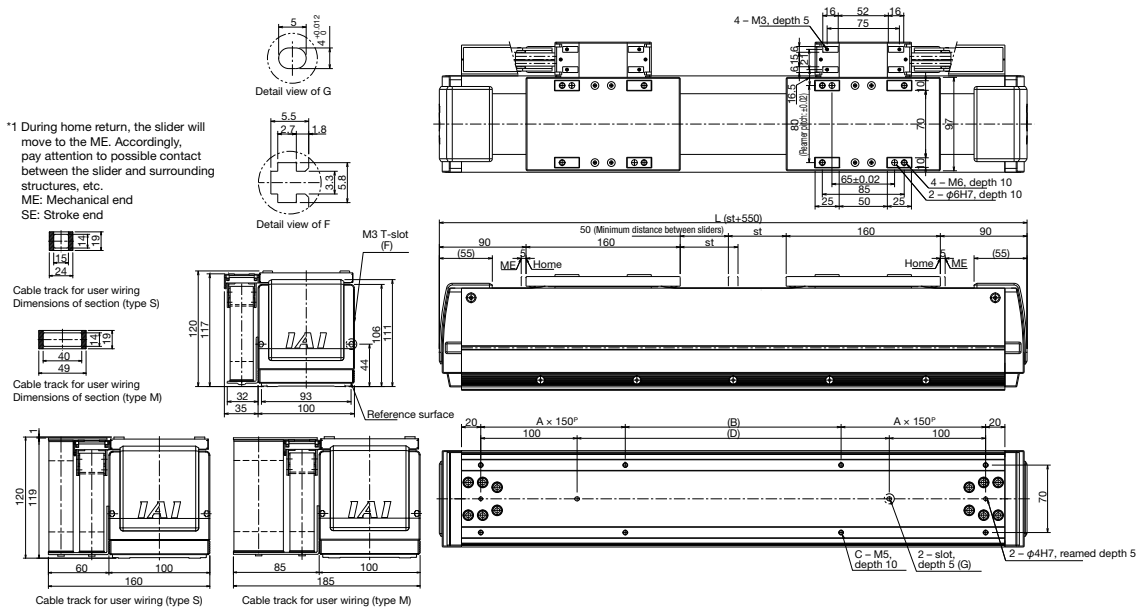

Stroke	60	150	240	330	420	510	600	690	780	870	960	1050	1140	1230	1320	1410	1500	1590	1680	1770	1860
L	610	700	790	880	970	1060	1150	1240	1330	1420	1510	1600	1690	1780	1870	1960	2050	2140	2230	2320	2410
A	1	2	2	2	2	3	3	3	4	4	4	5	5	5	5	6	6	6	7	7	7
B	224	14	104	194	284	74	164	254	44	134	224	14	104	194	284	74	164	254	44	134	224
C	8	12	12	12	12	16	16	16	20	20	20	24	24	24	24	28	28	28	32	32	32
D	324	414	504	594	684	774	864	954	1044	1134	1224	1314	1404	1494	1584	1674	1764	1854	1944	2034	2124
Weight(kg)	13.5	14.4	15.2	16.0	16.9	17.7	18.6	19.4	20.2	21.1	21.9	22.7	23.6	24.4	25.2	26.1	26.9	27.7	28.6	29.4	30.2

Applicable Controller Specifications

Applicable controller	Maximum controlled axes	Operating method	Power-supply voltage	Reference page
XSEL	6 axes	Program	Single-phase/ three-phase AC 200 V	→P53
SSEL	2 axes	Program/positioner	Single-phase AC100/200V	→P52
SCON	1 axis	Pulse train/positioner	Single-phase AC100/200V	→P51



Caution

(Note 1) The maximum speed may not be attained if the stroke is short.
(Note 2) The maximum acceleration varies depending on the operating conditions.
(Note 3) The maximum cable length is 20 m for the SCON/SSEL and 30 m for the XSEL. Specify a desired length in units of meters.
(Example: X08 = 8 m)

Shaft type

Small type

Flat type

Medium type

Large type

Dimensions – Sideway Specification

*1 During home return, the slider will move to the ME. Accordingly, pay attention to possible contact between the slider and surrounding structures, etc.
 ME: Mechanical end
 SE: Stroke end

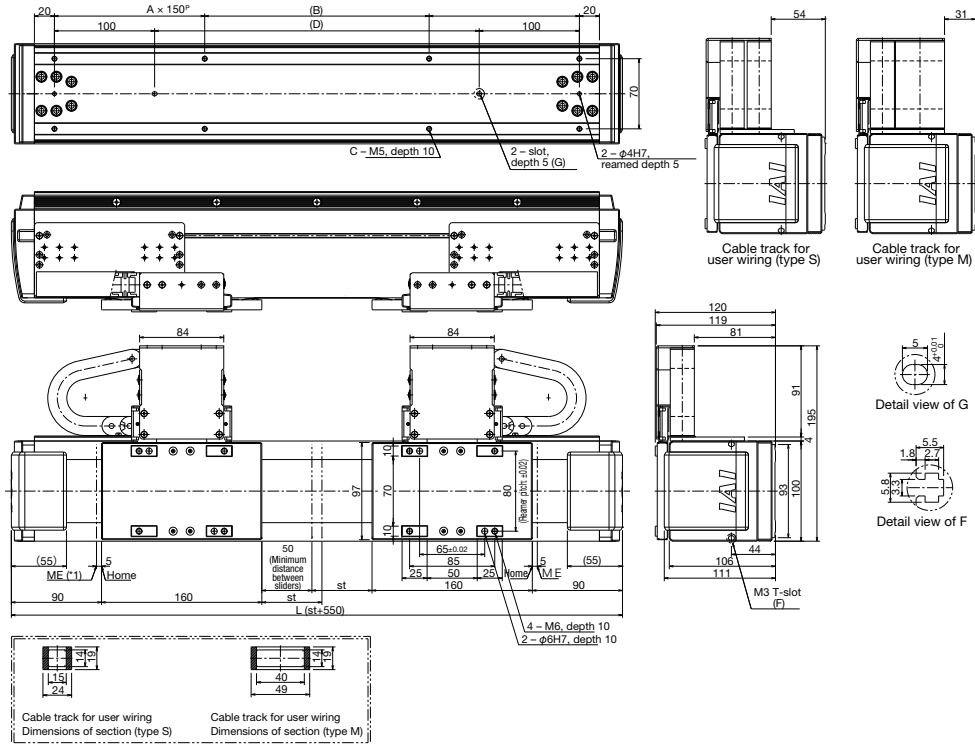

Stroke	60	150	240	330	420	510	600	690	780	870	960	1050	1140	1230	1320	1410	1500	1590	1680	1770	1860
L	610	700	790	880	970	1060	1150	1240	1330	1420	1510	1600	1690	1780	1870	1960	2050	2140	2230	2320	2410
A	1	2	2	2	2	3	3	3	4	4	4	5	5	5	5	6	6	6	7	7	7
B	224	14	104	194	284	74	164	254	44	134	224	14	104	194	284	74	164	254	44	134	224
C	8	12	12	12	12	16	16	16	20	20	20	24	24	24	24	28	28	28	32	32	32
D	324	414	504	594	684	774	864	954	1044	1134	1224	1314	1404	1494	1584	1674	1764	1854	1944	2034	2124
Weight (kg)	14.5	15.4	16.2	17.0	17.9	18.7	19.6	20.4	21.2	22.1	22.9	23.7	24.6	25.4	26.2	27.1	27.9	28.7	29.6	30.4	31.2

Shaft type

Small type

Flat type

Medium type

Large type

LSA-S10HS

Shaft type, 100 mm wide
High-thrust type, single-slider

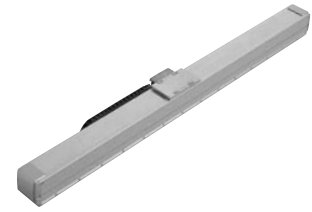

■ Model Name **LSA-S10HS** — **I** — **200** — — **T2** — —

Series — Type — Encoder type — Applicable drive output — Stroke — Applicable controller — Cable length — Options

I : Incremental specification 200 : 200W 90:90mm } T2 : SCON SSEL XSEL-P/-Q N : None S : 3m M : 5m Refer to the options table below.

* Refer to P.13 for details on each item comprising the model name. 2070:2070mm

Model Specifications

Model	Encoder type	Applicable drive output (per slider)	Stroke Specified in 90-mm steps (mm)	Speed (Note 1) (mm/sec)	Payload (Note 2)		Rated thrust (N)	Maximum thrust (N)	Maximum acceleration (G) (Note 2)
					Horizontal (kg)	Vertical (kg)			
LSA-S10HS-I-200- <input type="checkbox"/> -T2- <input type="checkbox"/> - <input type="checkbox"/>	I: Incremental	200	90-2070	2500	20	—	80	320	3

* In the above model names, indicates the stroke, indicates the cable length, and indicates the options.

Options

Name	Model	Reference page	Remarks
Cable track installation direction	CT2-6	→P14	Installation directions 2 to 6
Cable track for user wiring, type S	US1-6	→P14	Installation directions 1 to 6
Cable track for user wiring, type M	UM1-6	→P14	Installation directions 1 to 6

Common Specifications

Drive method	Linear servo motor
Positioning repeatability	±0.005mm
Guide	Built-in linear guide
Permissible load moment	Ma: 57.4N • m Mb: 81.9 • m Mc: 60.8N • m
Overhang load length	300 mm or less in Ma direction / 300 mm or less in Mb/Mc directions
Base	Material: Aluminum with white alumite treatment
Applicable controller	T2: SCON, SSEL, XSEL-P/Q
Cable length (Note 3)	N: No Cable S: 3m M: 5m X <input type="checkbox"/> <input type="checkbox"/> : Specified length
Ambient operating temperature	0 to 40°C, 85% RH or below (non-condensing)

Dimensions

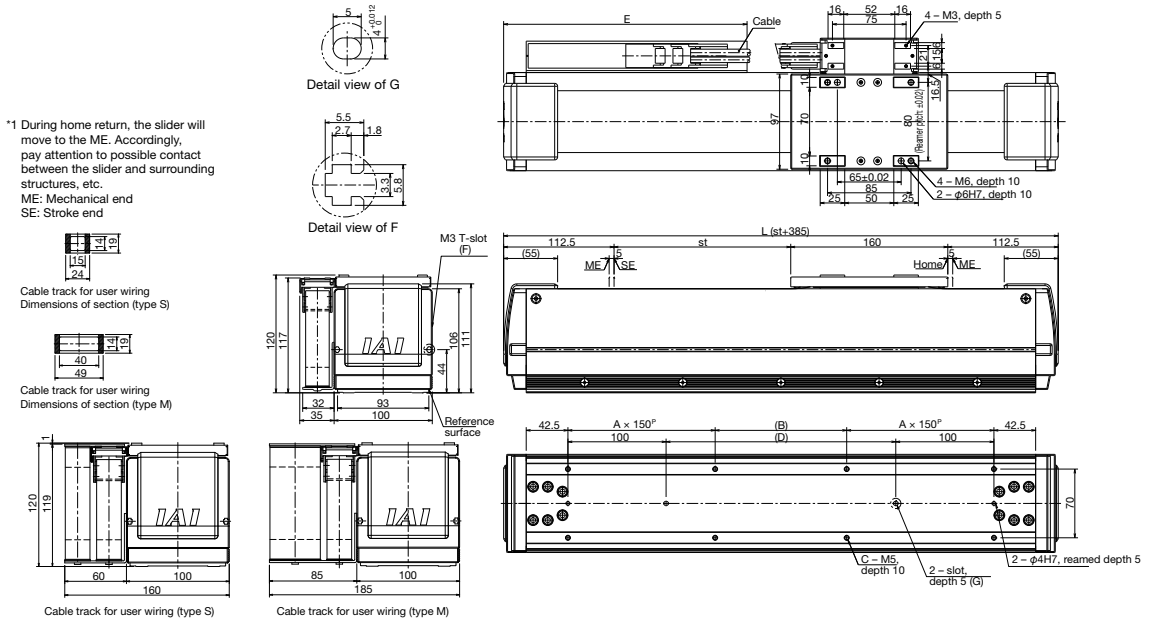

Stroke	90	180	270	360	450	540	630	720	810	900	990	1080	1170	1260	1350	1440	1530	1620	1710	1800	1890	1980	2070
L	475	565	655	745	835	925	1015	1105	1195	1285	1375	1465	1555	1645	1735	1825	1915	2005	2095	2185	2275	2365	2455
A	1	1	1	2	2	2	2	3	3	3	4	4	4	5	5	5	5	6	6	6	7	7	7
B	44	134	224	14	104	194	284	74	164	254	44	134	224	14	104	194	284	74	164	254	44	134	224
C	8	8	8	8	12	12	12	16	16	16	20	20	24	24	24	24	28	28	28	28	32	32	32
D	144	234	324	414	504	594	684	774	864	954	1044	1134	1224	1314	1404	1494	1584	1674	1764	1854	1944	2034	2124
E	198	248	298	348	398	448	473	523	573	623	673	698	748	798	848	898	923	973	1023	1073	1123	1148	1198
Weight(kg)	9.2	10.0	10.9	11.7	12.5	13.4	14.2	15.0	15.9	16.7	17.6	18.4	19.2	20.1	20.9	21.7	22.6	23.4	24.2	25.1	25.9	26.7	27.6

Applicable Controller Specifications

Applicable controller	Maximum controlled axes	Operating method	Power-supply voltage	Reference page
XSEL	6 axes	Program	Single-phase/ three-phase AC 200 V	→P53
SSEL	2 axes	Program/positioner	Single-phase AC100/200V	→P52
SCON	1 axis	Pulse train/positioner	Single-phase AC100/200V	→P51

Caution

(Note 1) The maximum speed may not be attained if the stroke is short.
(Note 2) The maximum acceleration varies depending on the operating conditions.
(Note 3) The maximum cable length is 20 m for the SCON/SSEL and 30 m for the XSEL. Specify a desired length in units of meters.
(Example: X08 = 8 m)

Shaft type

Small type

Flat type

Medium type

Large type

Dimensions – Sideway Specification (Standard)

*1 During home return, the slider will move to the ME. Accordingly, pay attention to possible contact between the slider and surrounding structures, etc.
ME: Mechanical end
SE: Stroke end

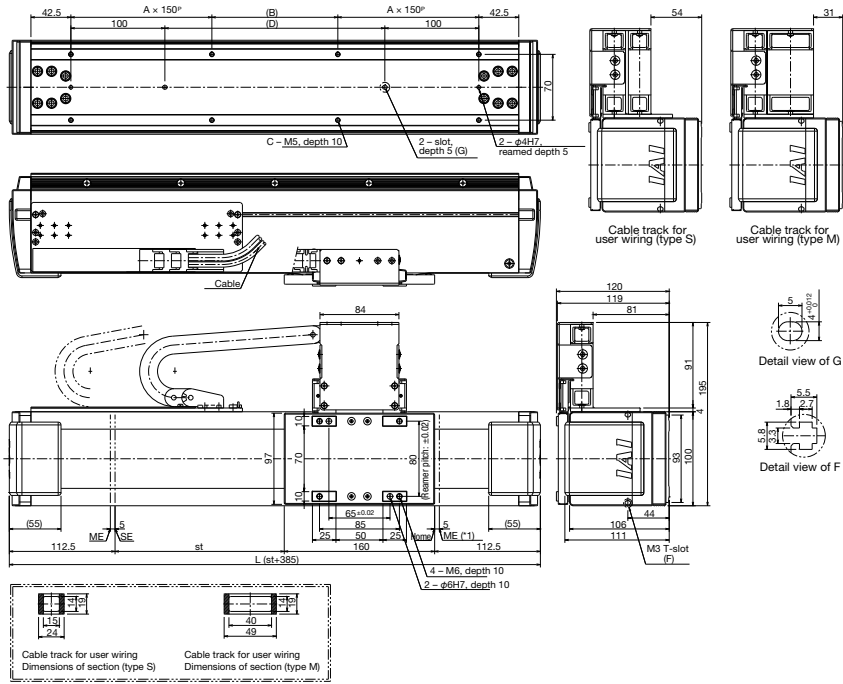

Stroke	90	180	270	360	450	540	630	720	810	900	990	1080	1170	1260	1350	1440	1530	1620	1710	1800	1890	1980	2070
L	475	565	655	745	835	925	1015	1105	1195	1285	1375	1465	1555	1645	1735	1825	1915	2005	2095	2185	2275	2365	2455
A	1	1	1	2	2	2	2	3	3	3	4	4	4	5	5	5	5	6	6	6	7	7	7
B	44	134	224	14	104	194	284	74	164	254	44	134	224	14	104	194	284	74	164	254	44	134	224
C	8	8	8	12	12	12	12	16	16	16	20	20	20	24	24	24	24	28	28	28	32	32	32
D	144	234	324	414	504	594	684	774	864	954	1044	1134	1224	1314	1404	1494	1584	1674	1764	1854	1944	2034	2124
Weight(kg)	9.7	10.5	11.4	12.2	13.0	13.9	14.7	15.5	16.4	17.2	18.1	18.9	19.7	20.6	21.4	22.2	23.1	23.9	24.7	25.6	26.4	27.2	28.1

Dimensions – Sideway Specification (Cable Track, Opposite)

*1 During home return, the slider will move to the ME. Accordingly, pay attention to possible contact between the slider and surrounding structures, etc.
ME: Mechanical end
SE: Stroke end

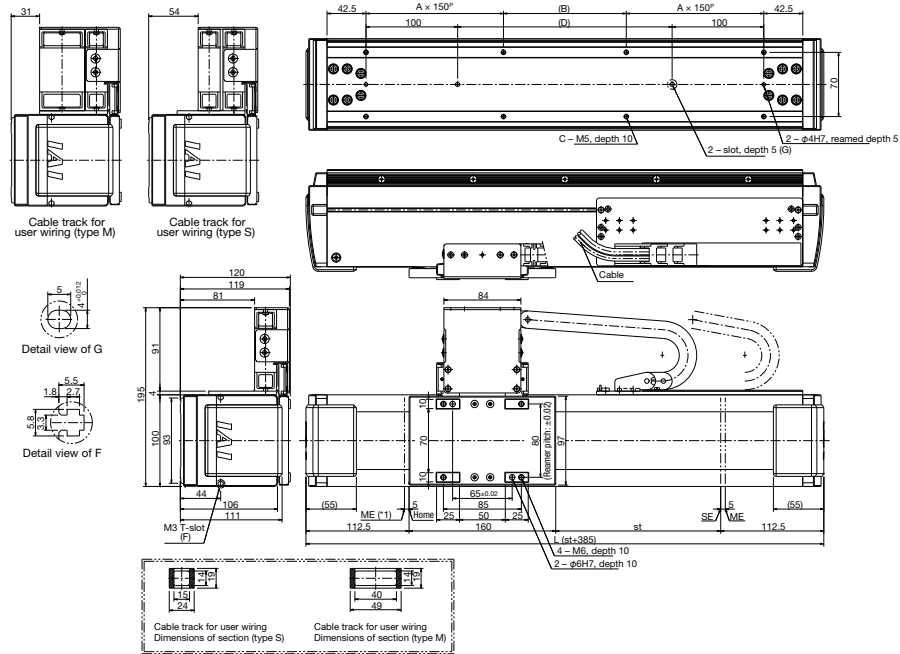

Stroke	90	180	270	360	450	540	630	720	810	900	990	1080	1170	1260	1350	1440	1530	1620	1710	1800	1890	1980	2070
L	475	565	655	745	835	925	1015	1105	1195	1285	1375	1465	1555	1645	1735	1825	1915	2005	2095	2185	2275	2365	2455
A	1	1	1	2	2	2	2	3	3	3	4	4	4	5	5	5	5	6	6	6	7	7	7
B	44	134	224	14	104	194	284	74	164	254	44	134	224	14	104	194	284	74	164	254	44	134	224
C	8	8	8	12	12	12	12	16	16	16	20	20	20	24	24	24	24	28	28	28	32	32	32
D	144	234	324	414	504	594	684	774	864	954	1044	1134	1224	1314	1404	1494	1584	1674	1764	1854	1944	2034	2124
Weight(kg)	9.7	10.5	11.4	12.2	13.0	13.9	14.7	15.5	16.4	17.2	18.1	18.9	19.7	20.6	21.4	22.2	23.1	23.9	24.7	25.6	26.4	27.2	28.1

Shaft type

Small type

Flat type

Medium type

Large type

LSA-S10HM

Shaft type, 100 mm wide
High-thrust type, multi-slider



■ Model Name **LSA-S10HM-I-200** - - **T2** - -
 Series — Type — Encoder type — Applicable drive output — Stroke — Applicable controller — Cable length — Options

I: Incremental specification 200 : 105:105mm 200W } T2 : SCON S: 3m SSEL M: 5m XSEL-P/-Q X□□:
 N: None Refer to the options table below.

* Refer to P. 13 for details on each item comprising the model name. 1815:1815mm

Model Specifications

Model	Encoder type	Applicable drive output (per slider)	Stroke Specified in 90-mm steps (mm)	Speed (Note 1) (mm/sec)	Payload (Note 2)		Rated thrust (N)	Maximum thrust (N)	Maximum acceleration (G) (Note 2)
					Horizontal (kg)	Vertical (kg)			
LSA-S10HM-I-200- <input type="checkbox"/> -T2- <input type="checkbox"/> - <input type="checkbox"/>	I: Incremental	200	105-1815	2500	20	-	80	320	3

* In the above model names, indicates the stroke, indicates the cable length, and indicates the options.

Options

Name	Model	Reference page	Remarks
Cable track installation direction	CT5	→P14	Sideway specification
Cable track for user wiring, type S	US1/US5	→P14	Standard specification/sideway specification
Cable track for user wiring, type M	UM1/UM5	→P14	Standard specification/sideway specification

Note) To change the cable track position to the opposite side, install the actuator by rotating it 180 degrees horizontally because the actuator is bilaterally symmetrical.

Common Specifications

Drive method	Linear servo motor
Positioning repeatability	±0.005mm
Guide	Built-in linear guide
Permissible load moment	Ma: 57.4N • m Mb: 81.9 • m Mc: 60.8N • m
Overhang load length	300 mm or less in Ma direction / 300 mm or less in Mb/Mc directions
Base	Material: Aluminum with white alumite treatment
Applicable controller	T2: SCON, SSEL, XSEL-P/Q
Cable length (Note 3)	N: No Cable S: 3m M: 5m X□□: Specified length
Ambient operating temperature	0 to 40°C, 85% RH or below (non-condensing)

Dimensions

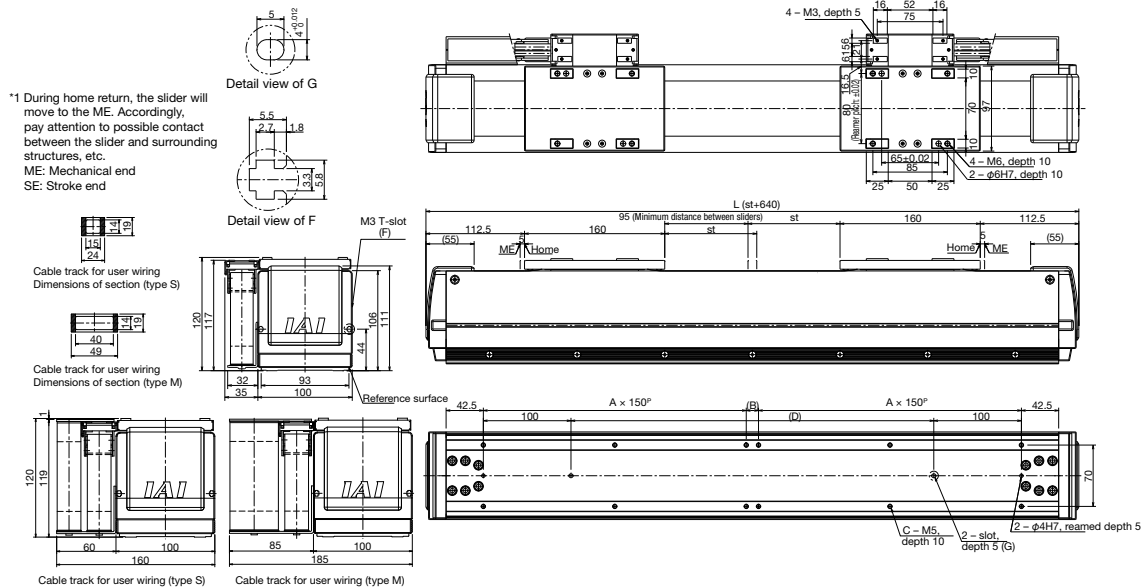

Stroke	105	195	285	375	465	555	645	735	825	915	1005	1095	1185	1275	1365	1455	1545	1635	1725	1815
L	745	835	925	1015	1105	1195	1285	1375	1465	1555	1645	1735	1825	1915	2005	2095	2185	2275	2365	2455
A	2	2	2	2	3	3	3	4	4	4	5	5	5	5	6	6	6	7	7	7
B	14	104	194	284	74	164	254	44	134	224	14	104	194	284	74	164	254	44	134	224
C	12	12	12	12	16	16	16	20	20	20	24	24	24	24	28	28	28	32	32	32
D	414	504	594	684	774	864	954	1044	1134	1224	1314	1404	1494	1584	1674	1764	1854	1944	2034	2124
Weight(kg)	15.6	16.4	17.3	18.1	18.9	19.8	20.6	21.4	22.3	23.1	23.9	24.8	25.6	26.4	27.3	28.1	28.9	29.8	30.6	31.4

Applicable Controller Specifications

Applicable controller	Maximum controlled axes	Operating method	Power-supply voltage	Reference page
XSEL	6 axes	Program	Single-phase/ three-phase AC 200 V	→P53
SSEL	2 axes	Program/positioner	Single-phase AC100/200V	→P52
SCON	1 axis	Pulse train/positioner	Single-phase AC100/200V	→P51



(Note 1) The maximum speed may not be attained if the stroke is short.
 (Note 2) The maximum acceleration varies depending on the operating conditions.
 (Note 3) The maximum cable length is 20 m for the SCON/SSEL and 30 m for the XSEL. Specify a desired length in units of meters.
 (Example: X08 = 8 m)

Shaft type

Small type

Flat type

Medium type

Large type

Dimensions – Sideway Specification

*1 During home return, the slider will move to the ME. Accordingly, pay attention to possible contact between the slider and surrounding structures, etc.
ME: Mechanical end
SE: Stroke end

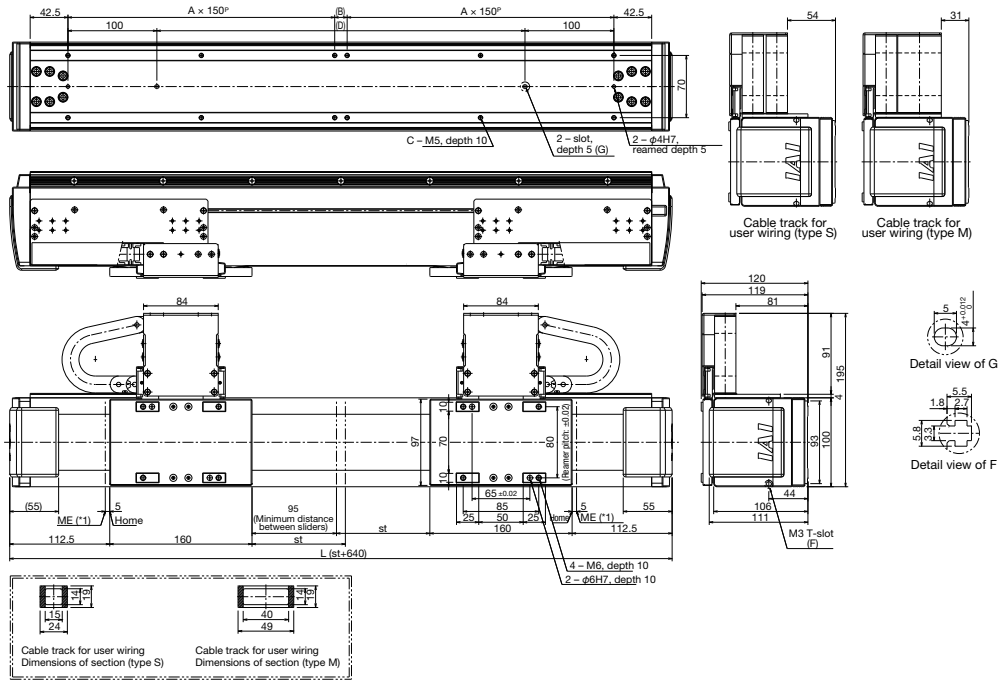

Shaft type

Small type

Flat type

Medium type

Large type

Stroke	105	195	285	375	465	555	645	735	825	915	1005	1095	1185	1275	1365	1455	1545	1635	1725	1815
L	745	835	925	1015	1105	1195	1285	1375	1465	1555	1645	1735	1825	1915	2005	2095	2185	2275	2365	2455
A	2	2	2	2	3	3	3	4	4	4	5	5	5	5	6	6	6	7	7	7
B	14	104	194	284	74	164	254	44	134	224	14	104	194	284	74	164	254	44	134	224
C	12	12	12	12	16	16	16	20	20	20	24	24	24	24	28	28	28	32	32	32
D	414	504	594	684	774	864	954	1044	1134	1224	1314	1404	1494	1584	1674	1764	1854	1944	2034	2124
Weight (kg)	16.6	17.4	18.3	19.1	19.9	20.8	21.6	22.4	23.3	24.1	24.9	25.8	26.6	27.4	28.3	29.1	29.9	30.8	31.6	32.4

LSA-H8SS

Small type, 80 mm wide
Standard type, single-slider



Model Name **LSA-H8SS** — I — 200 — — T2 — —

Series — Type — Encoder type — Applicable drive output — Stroke — Applicable controller — Cable length — Options

I: Incremental specification 200 : 200W 50:50mm ?
T2 : None SCON SSEL XSEL-P/-Q X□□:
N: None S: 3m M: 5m
Refer to the options table below.

* Refer to P. 13 for details on each item comprising the model name. 1650:1650mm

Model Specifications

Model	Encoder type	Applicable drive output (per slider)	Stroke Specified in 100-mm steps (mm)	Speed (Note 1) (mm/sec)	Payload (Note 2)		Rated thrust (N)	Maximum thrust (N)	Maximum acceleration (G) (Note 2)
					Horizontal (kg)	Vertical (kg)			
LSA-H8SS-I-200- <input type="text"/> -T2- <input type="text"/> - <input type="text"/>	I: Incremental	200	50-1650	2500	5	-	30	90	3

* In the above model names, indicates the stroke, indicates the cable length, and indicates the options.

Options

Name	Model	Reference page	Remarks
Cable track installation direction	CT2-6	→P14	Installation directions 2 to 6
Cable track for user wiring, type S	US1-6	→P14	Installation directions 1 to 6
Cable track for user wiring, type M	UM1-6	→P14	Installation directions 1 to 6

Common Specifications

Drive method	Linear servo motor
Positioning repeatability	±0.005mm
Guide	Built-in linear guide
Permissible load moment	Ma: 8.65N • m Mb: 8.65 • m Mc: 8.65N • m
Overhang load length	300 mm or less in Ma direction / 300 mm or less in Mb/Mc directions
Base	Material: Aluminum with white alumite treatment
Applicable controller	T2: SCON, SSEL, XSEL-P/Q
Cable length (Note 3)	N: No Cable S: 3m M: 5m X□□: Specified length
Ambient operating temperature	0 to 40°C, 85% RH or below (non-condensing)

Dimensions

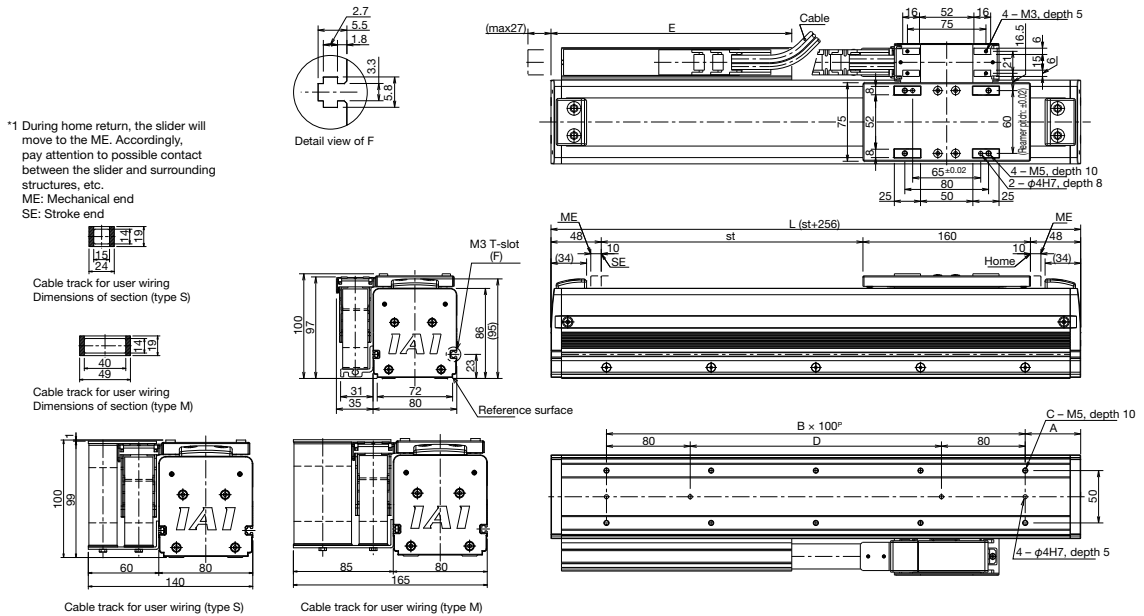

Stroke	50	150	250	350	450	550	650	750	850	950	1050	1150	1250	1350	1450	1550	1650
L	306	406	506	606	706	806	906	1006	1106	1206	1306	1406	1506	1606	1706	1806	1906
A	53	53	53	53	53	53	53	53	53	53	53	53	53	53	53	53	53
B	2	3	4	5	6	7	8	9	10	11	12	13	14	15	16	17	18
C	6	8	10	12	14	16	18	20	22	24	26	28	30	32	34	36	38
D	40	140	240	340	440	540	640	740	840	940	1040	1140	1240	1340	1440	1540	1640
E	130	180	230	280	330	380	430	480	530	580	630	680	730	780	830	880	930
Weight(kg)	5.0	6.2	7.4	8.6	9.8	11.0	12.2	13.4	14.6	15.8	17.0	18.2	19.4	20.6	21.8	23.0	24.2

Applicable Controller Specifications

Applicable controller	Maximum controlled axes	Operating method	Power-supply voltage	Reference page
XSEL	6 axes	Program	Single-phase/ three-phase AC 200 V	→P53
SSEL	2 axes	Program/positioner	Single-phase AC100/200V	→P52
SCON	1 axis	Pulse train/positioner	Single-phase AC100/200V	→P51



(Note 1) The maximum speed may not be attained if the stroke is short.
(Note 2) The maximum acceleration varies depending on the operating conditions.
(Note 3) The maximum cable length is 20 m for the SCON/SSEL and 30 m for the XSEL. Specify a desired length in units of meters.
(Example: X08 = 8 m)

Shaft type

Small type

Flat type

Medium type

Large type

35

LSA-H8SS

LSA-H8SM

Small type, 80 mm wide
Standard type, multi-slider

■ Model Name **LSA-H8SM** — **I** — **200** — — **T2** — —

Series — Type — Encoder type — Applicable drive output — Stroke — Applicable controller — Cable length — Options

I: Incremental specification 200 : 130:130mm 200W } T2 : SCON S: 3m M: 5m N: None Refer to the options table below. SSEL XSEL-P/-Q X□□:

* Refer to P.13 for details on each item comprising the model name. 1430:1430mm



Shaft type
Small type
Flat type
Medium type
Large type

Model Specifications

Model	Encoder type	Applicable drive output (per slider)	Stroke Specified in 100-mm steps (mm)	Speed (Note 1) (mm/sec)	Payload (Note 2)		Rated thrust (N)	Maximum thrust (N)	Maximum acceleration (G) (Note 2)
					Horizontal (kg)	Vertical (kg)			
LSA-H8SM-I-200- <input type="checkbox"/> -T2- <input type="checkbox"/> - <input type="checkbox"/>	I: Incremental	200	130-1430	2500	5	-	30	90	3

* In the above model names, indicates the stroke, indicates the cable length, and indicates the options.

Options

Name	Model	Reference page	Remarks
Cable track installation direction	CT5	→P14	Sideway specification
Cable track for user wiring, type S	US1/US5	→P14	Standard specification/sideway specification
Cable track for user wiring, type M	UM1/UM5	→P14	Standard specification/sideway specification

Note) To change the cable track position to the opposite side, install the actuator by rotating it 180 degrees horizontally because the actuator is bilaterally symmetrical.

Common Specifications

Drive method	Linear servo motor
Positioning repeatability	±0.005mm
Guide	Built-in linear guide
Permissible load moment	Ma: 8.65N • m Mb: 8.65 • m Mc: 8.65N • m
Overhang load length	300 mm or less in Ma direction / 300 mm or less in Mb/Mc directions
Base	Material: Aluminum with white alumite treatment
Applicable controller	T2: SCON, SSEL, XSEL-P/Q
Cable length (Note 3)	N: No Cable S: 3m M: 5m X□□: Specified length
Ambient operating temperature	0 to 40°C, 85% RH or below (non-condensing)

Dimensions

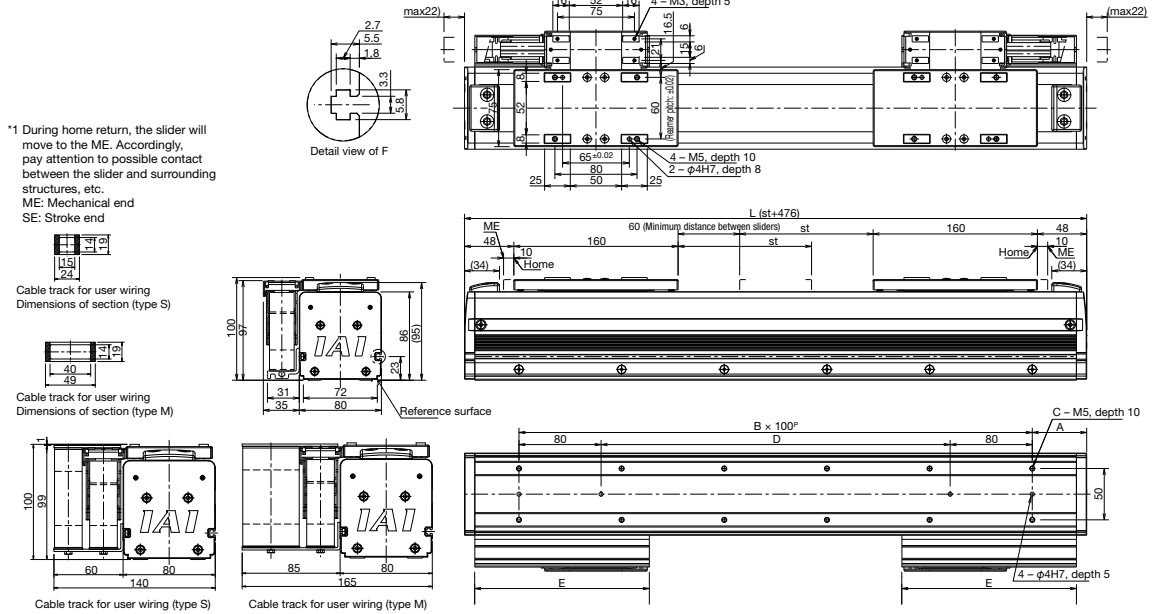

Stroke	130	230	330	430	530	630	730	830	930	1030	1130	1230	1330	1430
L	606	706	806	906	1006	1106	1206	1306	1406	1506	1606	1706	1806	1906
A	53	53	53	53	53	53	53	53	53	53	53	53	53	53
B	5	6	7	8	9	10	11	12	13	14	15	16	17	18
C	12	14	16	18	20	22	24	26	28	30	32	34	36	38
D	340	440	540	640	740	840	940	1040	1140	1240	1340	1440	1540	1640
E	180	230	280	330	380	430	480	530	580	630	680	730	780	830
Weight(kg)	10.7	11.9	13.1	14.3	15.5	16.7	17.9	19.1	20.3	21.5	22.7	23.9	25.1	26.3

Applicable Controller Specifications

Applicable controller	Maximum controlled axes	Operating method	Power-supply voltage	Reference page
XSEL	6 axes	Program	Single-phase/ three-phase AC 200 V	→P53
SSEL	2 axes	Program/positioner	Single-phase AC100/200V	→P52
SCON	1 axis	Pulse train/positioner	Single-phase AC100/200V	→P51

Caution

(Note 1) The maximum speed may not be attained if the stroke is short.
(Note 2) The maximum acceleration varies depending on the operating conditions.
(Note 3) The maximum cable length is 20 m for the SCON/SSEL and 30 m for the XSEL. Specify a desired length in units of meters. (Example: X08 = 8 m)

Dimensions – Sideway Specification

*1 During home return, the slider will move to the ME. Accordingly, pay attention to possible contact between the slider and surrounding structures, etc.
 ME: Mechanical end
 SE: Stroke end

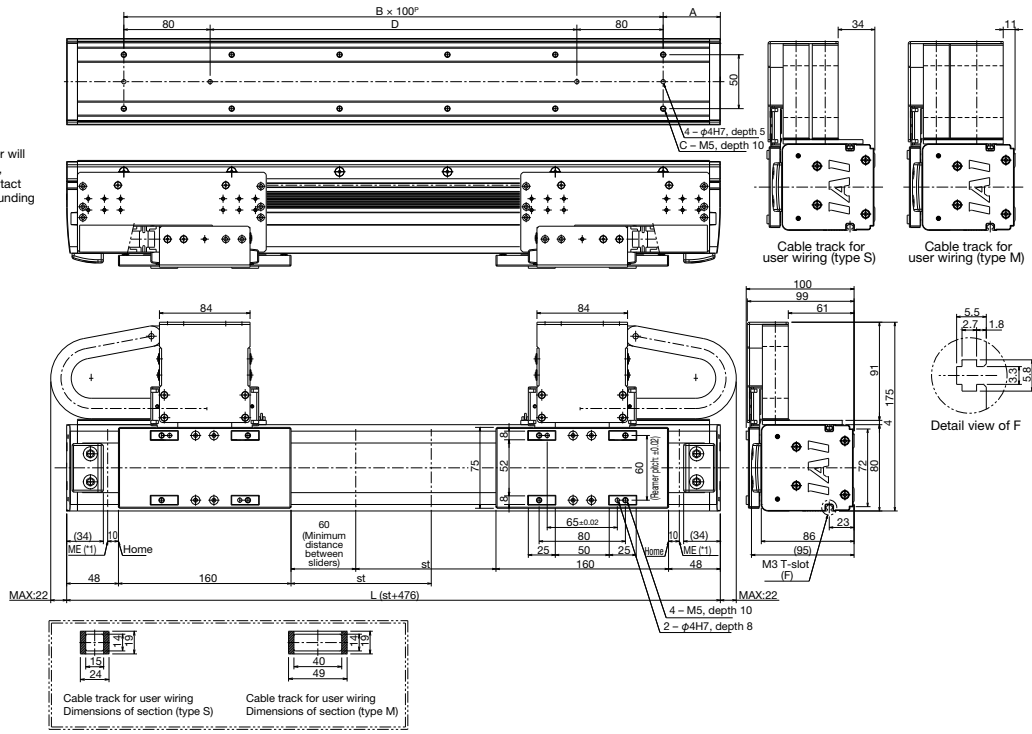

Shaft type

Small type

Flat type

Medium type

Large type

Stroke	130	230	330	430	530	630	730	830	930	1030	1130	1230	1330	1430
L	606	706	806	906	1006	1106	1206	1306	1406	1506	1606	1706	1806	1906
A	53	53	53	53	53	53	53	53	53	53	53	53	53	53
B	5	6	7	8	9	10	11	12	13	14	15	16	17	18
C	12	14	16	18	20	22	24	26	28	30	32	34	36	38
D	340	440	540	640	740	840	940	1040	1140	1240	1340	1440	1540	1640
Weight (kg)	11.7	12.9	14.1	15.3	16.5	17.7	18.9	20.1	21.3	22.5	23.7	24.9	26.1	27.3

LSA-H8HS

Small type, 80 mm wide
High-thrust type, single-slider



Model Name **LSA-H8HS** - I - 200 - [] - T2 - [] - []
 Series — Type — Encoder type — Applicable drive output — Stroke — Applicable controller — Cable length — Options

I: Incremental specification 200 : 200W 50 : 50mm 150 : 150mm
 T2 : SCON SSEL XSEL-P/-Q X□□ :
 N: None S: 3m M: 5m Refer to the options table below.

* Refer to P. 13 for details on each item comprising the model name. 1550:1550mm

Model Specifications

Model	Encoder type	Applicable drive output (per slider)	Stroke Specified in 100-mm steps (mm)	Speed (Note 1) (mm/sec)	Payload (Note 2)		Rated thrust (N)	Maximum thrust (N)	Maximum acceleration (G) (Note 2)
					Horizontal (kg)	Vertical (kg)			
LSA-H8HS-I-200-□-T2-□-□	I: Incremental	200	50-1550	2500	8	-	60	180	3

* In the above model names, □ indicates the stroke, □ indicates the cable length, and □ indicates the options.

Options

Name	Model	Reference page	Remarks
Cable track installation direction	CT2-6	→P14	Installation directions 2 to 6
Cable track for user wiring, type S	US1-6	→P14	Installation directions 1 to 6
Cable track for user wiring, type M	UM1-6	→P14	Installation directions 1 to 6

Common Specifications

Drive method	Linear servo motor
Positioning repeatability	±0.005mm
Guide	Built-in linear guide
Permissible load moment	Ma: 8.65N • m Mb: 8.65 • m Mc: 8.65N • m
Overhang load length	300 mm or less in Ma direction / 300 mm or less in Mb/Mc directions
Base	Material: Aluminum with white alumite treatment
Applicable controller	T2: SCON, SSEL, XSEL-P/Q
Cable length (Note 3)	N: No Cable S: 3m M: 5m X□□: Specified length
Ambient operating temperature	0 to 40°C, 85% RH or below (non-condensing)

Dimensions

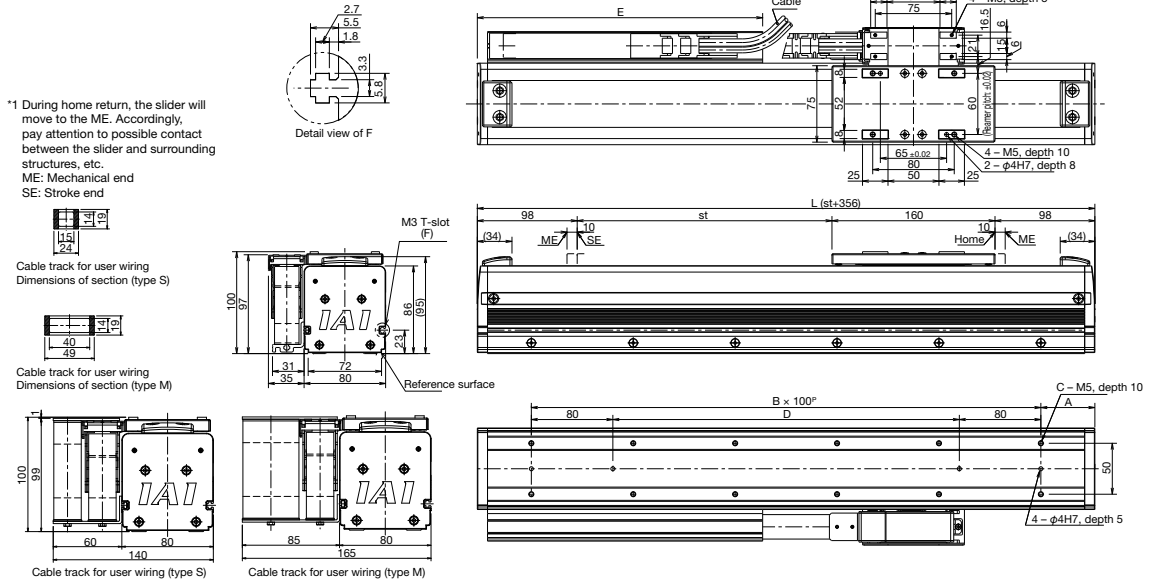

Stroke	50	150	250	350	450	550	650	750	850	950	1050	1150	1250	1350	1450	1550
L	406	506	606	706	806	906	1006	1106	1206	1306	1406	1506	1606	1706	1806	1906
A	53	53	53	53	53	53	53	53	53	53	53	53	53	53	53	53
B	3	4	5	6	7	8	9	10	11	12	13	14	15	16	17	18
C	8	10	12	14	16	18	20	22	24	26	28	30	32	34	36	38
D	140	240	340	440	540	640	740	840	940	1040	1140	1240	1340	1440	1540	1640
E	180	230	280	330	380	430	480	530	580	630	680	730	780	830	880	930
Weight (kg)	6.5	7.7	8.9	10.1	11.3	12.5	13.7	14.9	16.1	17.3	18.5	19.7	20.9	22.1	23.3	24.5

Applicable Controller Specifications

Applicable controller	Maximum controlled axes	Operating method	Power-supply voltage	Reference page
XSEL	6 axes	Program	Single-phase/ three-phase AC 200 V	→P53
SSEL	2 axes	Program/positioner	Single-phase AC100/200V	→P52
SCON	1 axis	Pulse train/positioner	Single-phase AC100/200V	→P51



(Note 1) The maximum speed may not be attained if the stroke is short.
 (Note 2) The maximum acceleration varies depending on the operating conditions.
 (Note 3) The maximum cable length is 20 m for the SCON/SSEL and 30 m for the XSEL. Specify a desired length in units of meters.
 (Example: X08 = 8 m)

Shaft type

Small type

Flat type

Medium type

Large type

Dimensions – Sideway Specification (Standard)

*1 During home return, the slider will move to the ME. Accordingly, pay attention to possible contact between the slider and surrounding structures, etc.
ME: Mechanical end
SE: Stroke end

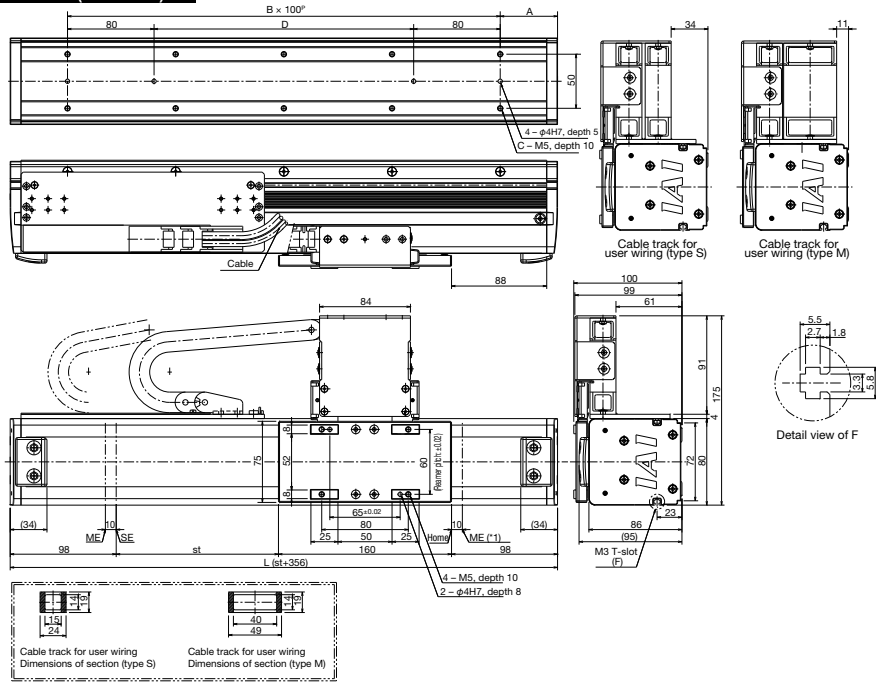

Stroke	50	150	250	350	450	550	650	750	850	950	1050	1150	1250	1350	1450	1550
L	406	506	606	706	806	906	1006	1106	1206	1306	1406	1506	1606	1706	1806	1906
A	53	53	53	53	53	53	53	53	53	53	53	53	53	53	53	53
B	3	4	5	6	7	8	9	10	11	12	13	14	15	16	17	18
C	8	10	12	14	16	18	20	22	24	26	28	30	32	34	36	38
D	140	240	340	440	540	640	740	840	940	1040	1140	1240	1340	1440	1540	1640
Weight(kg)	7.0	8.2	9.4	10.6	11.8	13.0	14.2	15.4	16.6	17.8	19.0	20.2	21.4	22.6	23.8	25.0

Dimensions – Sideway Specification (Cable Track, Opposite)

*1 During home return, the slider will move to the ME. Accordingly, pay attention to possible contact between the slider and surrounding structures, etc.
ME: Mechanical end
SE: Stroke end

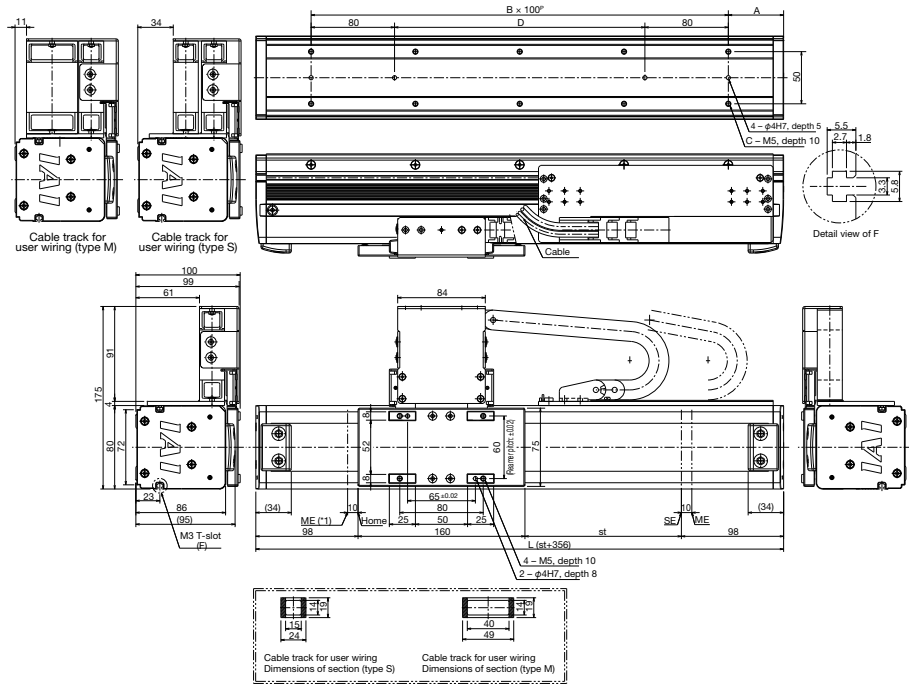

Stroke	50	150	250	350	450	550	650	750	850	950	1050	1150	1250	1350	1450	1550
L	406	506	606	706	806	906	1006	1106	1206	1306	1406	1506	1606	1706	1806	1906
A	53	53	53	53	53	53	53	53	53	53	53	53	53	53	53	53
B	3	4	5	6	7	8	9	10	11	12	13	14	15	16	17	18
C	8	10	12	14	16	18	20	22	24	26	28	30	32	34	36	38
D	140	240	340	440	540	640	740	840	940	1040	1140	1240	1340	1440	1540	1640
Weight(kg)	7.0	8.2	9.4	10.6	11.8	13.0	14.2	15.4	16.6	17.8	19.0	20.2	21.4	22.6	23.8	25.0

Shaft type

Small type

Flat type

Medium type

Large type

LSA-H8HS
AAAA-BBBB **40**

Dimensions – Wall-mounted Specification

*1 During home return, the slider will move to the ME. Accordingly, pay attention to possible contact between the slider and surrounding structures, etc.
 ME: Mechanical end
 SE: Stroke end

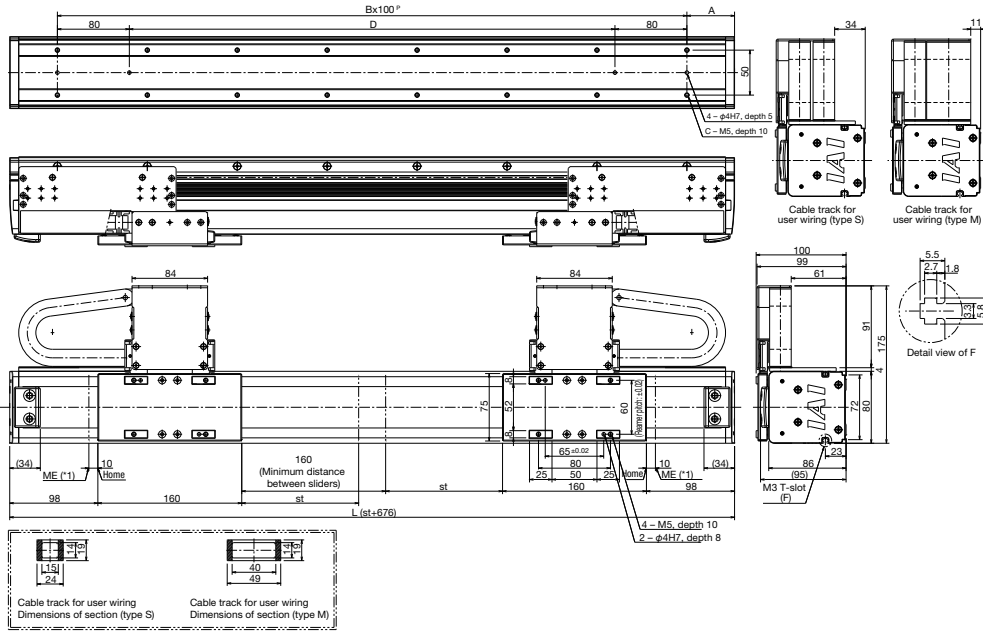

Shaft type

Small type

Flat type

Medium type

Large type

Stroke	130	230	330	430	530	630	730	830	930	1030	1130	1230
L	806	906	1006	1106	1206	1306	1406	1506	1606	1706	1806	1906
A	53	53	53	53	53	53	53	53	53	53	53	53
B	7	8	9	10	11	12	13	14	15	16	17	18
C	16	18	20	22	24	26	28	30	32	34	36	38
D	540	640	740	840	940	1040	1140	1240	1340	1440	1540	1640
Weight (kg)	14.8	16.0	17.2	18.4	19.6	20.8	22.0	23.2	24.4	25.6	26.8	28.0

LSA-H8HM

AAAA-BBBB

42

LSA-L15SM

Flat type, 145 mm wide
Standard type, multi-slider

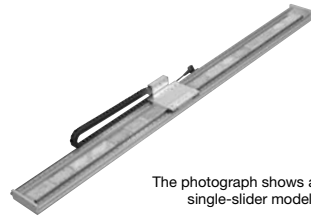

The photograph shows a single-slider model.

■ Model Name **LSA-L15SM-I-200** - [] - **T2** - [] - []
 Series — Type — Encoder type — Applicable drive output — Stroke — Applicable controller — Cable length — Options

I: Incremental 200 : 50:50mm T2 : N: None
 specification 200W } SCON S: 3m
 SSEL M: 5m
 XSEL-P/-Q X□□:

* Refer to P. 13 for details on each item comprising the model name. 1450:1450mm

Model Specifications

Model	Encoder type	Applicable drive output (per slider)	Stroke Specified in 100-mm steps (mm)	Speed (Note 1) (mm/sec)	Payload (Note 2)		Rated thrust (N)	Maximum thrust (N)	Maximum acceleration (G) (Note 2)
					Horizontal (kg)	Vertical (kg)			
LSA-L15SM-I-200-1-T2-2-3	I: Incremental	200	50-1450	2500	5	-	30	90	3

* In the above model names, [1] indicates the stroke, [2] indicates the cable length, and [3] indicates the options.

Options

Name	Model	Reference page	Remarks
No options are available.			

Common Specifications

Drive method	Linear servo motor
Positioning repeatability	±0.005mm
Guide	Built-in linear guide
Permissible load moment	Ma: 24.2N • m Mb: 24.2 • m Mc: 24.2N • m
Overhang load length	525 mm or less in Ma direction / 525 mm or less in Mb/Mc directions
Base	Material: Aluminum with white alumite treatment
Applicable controller	T2: SCON, SSEL, XSEL-P/Q
Cable length (Note 3)	N: No Cable S: 3m M: 5m X□□: Specified length
Ambient operating temperature	0 to 40°C, 85% RH or below (non-condensing)

Dimensions

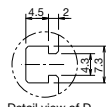

Detail view of D

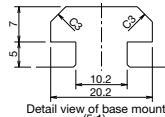

Detail view of base mount (S-1)

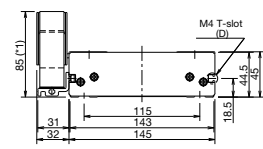

(*) The cable track may expand, in which case the above dimensions may be exceeded slightly.

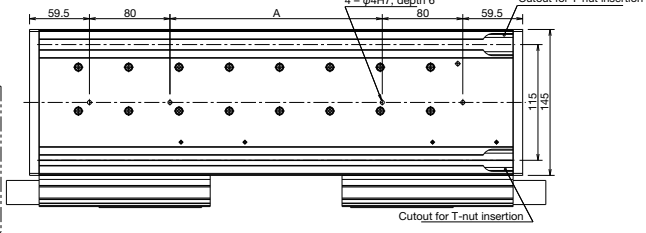
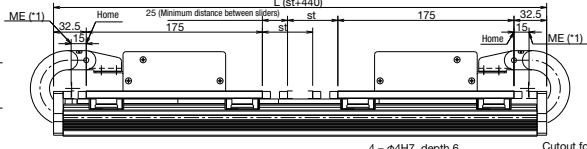
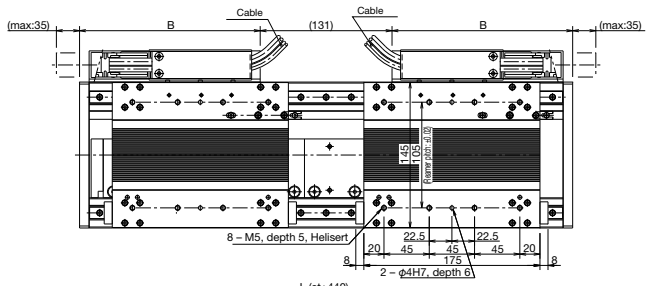
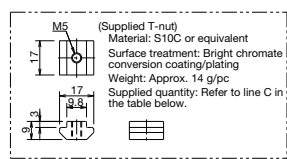

Stroke	50	150	250	350	450	550	650	750	850	950	1050	1150	1250	1350	1450
L	490	590	690	790	890	990	1090	1190	1290	1390	1490	1590	1690	1790	1890
A	211	311	411	511	611	711	811	911	1011	1111	1211	1311	1411	1511	1611
B	179.5	229.5	279.5	329.5	379.5	429.5	479.5	529.5	579.5	629.5	679.5	729.5	779.5	829.5	879.5
C	10	12	14	16	18	20	22	24	26	28	30	32	34	36	38
Weight(kg)	10.0	11.4	12.8	14.2	15.6	17.0	18.4	19.8	21.2	22.6	24.0	25.4	26.8	28.3	29.7

Applicable Controller Specifications

Applicable controller	Maximum controlled axes	Operating method	Power-supply voltage	Reference page
XSEL	6 axes	Program	Single-phase/ three-phase AC 200 V	→P53
SSEL	2 axes	Program/positioner	Single-phase AC100/200V	→P52
SCON	1 axis	Pulse train/positioner	Single-phase AC100/200V	→P51

Caution

(Note 1) The maximum speed may not be attained if the stroke is short.
 (Note 2) The maximum acceleration varies depending on the operating conditions.
 (Note 3) The maximum cable length is 20 m for the SCON/SSEL and 30 m for the XSEL. Specify a desired length in units of meters.
 (Example: X08 = 8 m)

Shaft type

Small type

Flat type

Medium type

Large type

LSA-N19SM

Medium type, 193 mm wide
Standard type, multi-slider

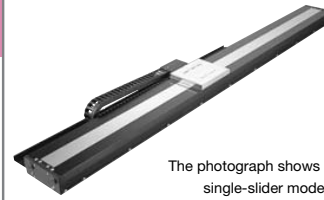

The photograph shows a single-slider model.

Model Name **LSA-N19SM-I-300** - - **T2** - -

Series — Type — Encoder type — Applicable drive output — Stroke — Applicable controller — Cable length — Options

I: Incremental specification 300W } 300 : 72:72mm } T2 : N: None }
 SCON S: 3m } SSEL M: 5m } XSEL=P/-Q X□□:

* Refer to P. 13 for details on each item comprising the model name. 2232:2232mm

Model Specifications

Model	Encoder type	Applicable drive output (per slider)	Stroke Specified in 144-mm steps (mm)	Speed (Note 1) (mm/sec)	Payload (Note 2)		Rated thrust (N)	Maximum thrust (N)	Maximum acceleration (G) (Note 2)
					Horizontal (kg)	Vertical (kg)			
LSA-N19SM-I-300- <input type="checkbox"/> -T2- <input type="checkbox"/> - <input type="checkbox"/>	I: Incremental	300	72-2232	2500	30	-	100	Refer to P. 10	3

* In the above model names, indicates the stroke, indicates the cable length, and indicates the options.

Options

Name	Model	Reference page	Remarks
No options are available.			

Common Specifications

Drive method	Linear servo motor
Positioning repeatability	±0.005mm
Guide	Built-in linear guide
Permissible load moment	Ma: 61.94N • m Mb: 61.94 • m Mc: 61.94N • m
Overhang load length	700 mm or less in Ma direction / 700 mm or less in Mb/Mc directions
Base	Material: Aluminum with black alumite treatment
Applicable controller	T2: SCON, SSEL, XSEL-P/Q
Cable length (Note 3)	N: No Cable S: 3m M: 5m X□□: Specified length
Ambient operating temperature	0 to 40°C, 85% RH or below (non-condensing)

Dimensions

*1 During home return, the slider will move to the ME. Accordingly, pay attention to possible contact between the slider and surrounding structures, etc.
 ME: Mechanical end
 SE: Stroke end

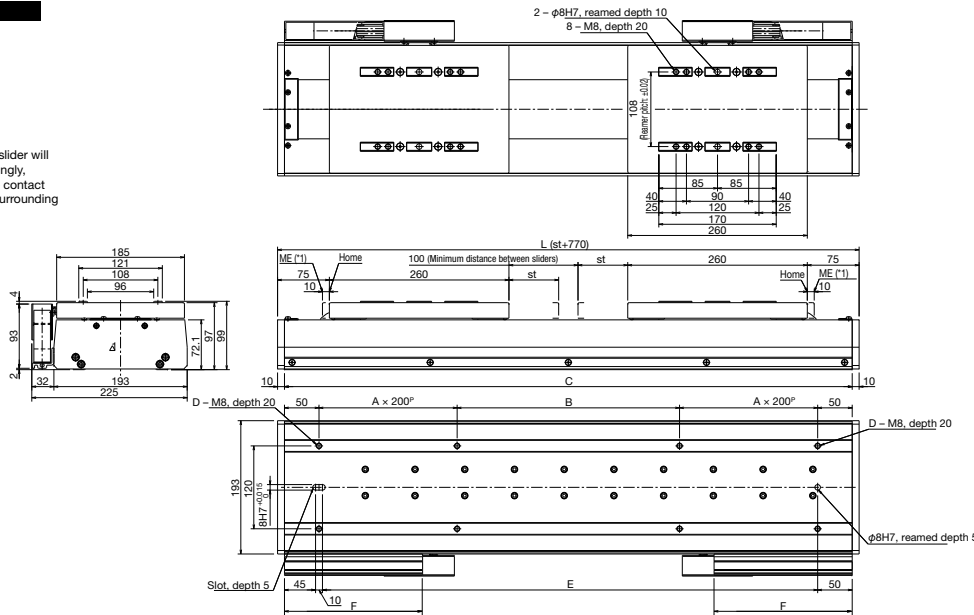

Stroke	72	216	360	504	648	792	936	1080	1224	1368	1512	1656	1800	1944	2088	2232
L	842	986	1130	1274	1418	1562	1706	1850	1994	2138	2282	2426	2570	2714	2858	3002
A	1	2	2	2	3	3	3	4	4	5	5	5	6	6	6	7
B	322	66	210	354	98	242	386	130	274	18	162	306	50	194	338	82
C	822	966	1110	1254	1398	1542	1686	1830	1974	2118	2262	2406	2550	2694	2838	2982
D	4	6	6	6	8	8	8	10	10	12	12	12	14	14	14	16
E	717	861	1005	1149	1293	1437	1581	1725	1869	2013	2157	2301	2445	2589	2733	2877
F	200	275	350	425	500	575	650	725	800	875	950	1025	1100	1175	1250	1325
Weight(kg)	28.7	31.5	34.4	37.2	40.1	42.9	45.8	48.6	51.5	54.3	57.2	60.0	62.8	65.7	68.5	71.4

Applicable Controller Specifications

Applicable controller	Maximum controlled axes	Operating method	Power-supply voltage	Reference page
XSEL	6 axes	Program	Single-phase/ three-phase AC 200 V	→P53
SSEL	2 axes	Program/positioner	Single-phase AC100/200V	→P52
SCON	1 axis	Pulse train/positioner	Single-phase AC100/200V	→P51



Caution

(Note 1) The maximum speed may not be attained if the stroke is short.
 (Note 2) The maximum acceleration varies depending on the operating conditions.
 (Note 3) The maximum cable length is 20 m for the SCON/SSEL and 30 m for the XSEL. Specify a desired length in units of meters.
 (Example: X08 = 8 m)

Shaft type

Small type

Flat type

Medium type

Large type

LSA-W21SM

Large type, 210 mm wide
Standard type, multi-slider

■ Model Name **LSA-W21SM** — **I** — **400** — — **T2** — —

Series — Type — Encoder type — Applicable drive output — Stroke — Applicable controller — Cable length — Options

I : Incremental specification 400 : 730:730mm 400W } T2 : SCON SSEL XSEL N : None S : 3m M : 5m L : Home limit switch (standard) XSEL=P/-Q X□

* Refer to P. 13 for details on each item comprising the model name. 3835:3835mm

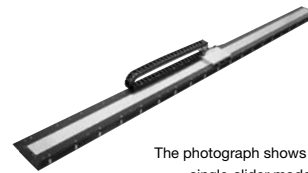

The photograph shows a single-slider model.

Model Specifications

Model	Encoder type	Applicable drive output (per slider)	Stroke Specified in 135-mm steps (mm)	Speed (Note 1) (mm/sec)	Payload (Note 2)		Rated thrust (N)	Maximum thrust (N)	Maximum acceleration (G) (Note 2)
					Horizontal (kg)	Vertical (kg)			
LSA-W21SM-I-400- <input type="checkbox"/> -T2- <input type="checkbox"/> -L	I: Incremental	400	730-3835	2500	60	-	200	600	3

* In the above model names, indicates the stroke, indicates the cable length, and indicates the options.

Options

Name	Model	Reference page	Remarks
Home limit switch	L	-	Standard feature

* To change the cable track position to the opposite side, install the actuator by rotating it 180 degrees horizontally because the actuator is bilaterally symmetrical.

* With the large type, the home limit switch (L) is a standard feature.

Common Specifications

Drive method	Linear servo motor
Positioning repeatability	±0.005mm
Guide	Built-in linear guide
Permissible load moment	Ma: 128.7N • m Mb: 128.7 • m Mc: 128.7N • m
Overhang load length	500 mm or less in Ma direction / 500 mm or less in Mb/Mc directions
Base	Material: Aluminum with black alumite treatment
Applicable controller	T2: SCON, SSEL, XSEL-P/Q
Cable length (Note 3)	N: No Cable S: 3m M: 5m X <input type="checkbox"/> □: Specified length
Ambient operating temperature	0 to 40°C, 85% RH or below (non-condensing)

Dimensions

*1 During home return, the slider will move to the ME. Accordingly, pay attention to possible contact between the slider and surrounding structures, etc.
ME: Mechanical end
SE: Stroke end

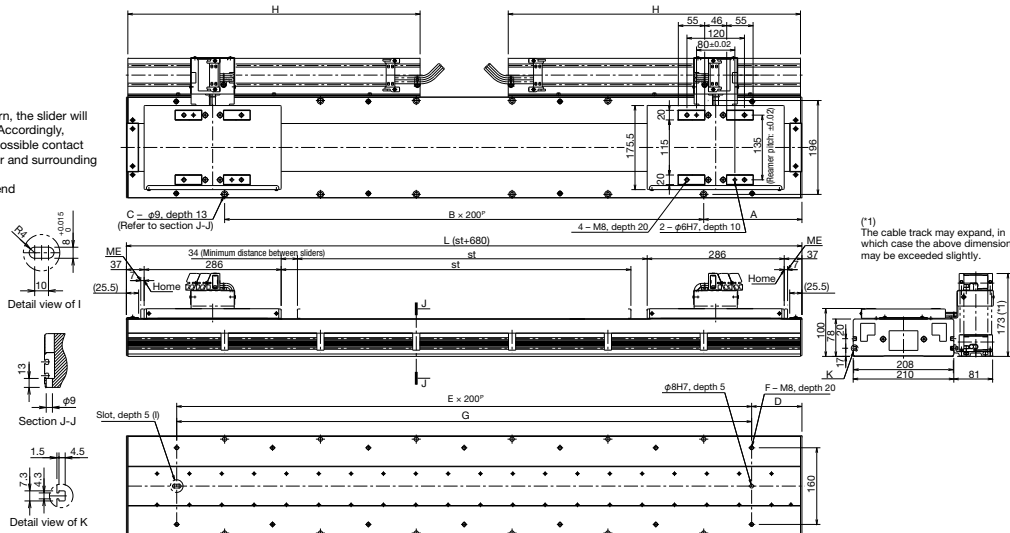

Stroke	730	865	1000	1135	1270	1405	1540	1675	1810	1945	2080	2215	2350	2485	2620	2755	2890	3025	3160	3295	3430	3565	3700	3835
L	1410	1545	1680	1815	1950	2085	2220	2355	2490	2625	2760	2895	3030	3165	3300	3435	3570	3705	3840	3975	4110	4245	4380	4515
A	205	72.5	140	207.5	75	142.5	210	77.5	145	212.5	80	147.5	215	82.5	150	217.5	85	152.5	220	87.5	155	222.5	90	157.5
B	5	7	7	7	9	9	9	11	11	11	13	13	13	15	15	15	17	17	17	19	19	19	21	21
C	12	16	16	16	20	20	20	24	24	24	28	28	28	32	32	32	36	36	36	40	40	40	44	44
D	105	172.5	40	107.5	175	42.5	110	177.5	45	112.5	180	47.5	115	182.5	50	117.5	185	52.5	120	187.5	55	122.5	190	57.5
E	6	6	8	8	8	10	10	10	12	12	12	14	14	14	16	16	16	18	18	18	20	20	20	22
F	14	14	18	18	18	22	22	22	26	26	26	30	30	30	34	34	34	38	38	38	42	42	42	46
G	1200	1200	1600	1600	1600	2000	2000	2000	2400	2400	2400	2800	2800	2800	3200	3200	3200	3600	3600	3600	4000	4000	4000	4400
H	610	680	760	830	900	970	1040	1120	1160	1240	1310	1380	1450	1500	1570	1640	1720	1790	1840	1910	1980	2050	2120	2200
Weight(kg)	57.0	61.0	65.0	69.0	73.0	77.0	81.0	85.0	89.0	93.0	97.0	101.0	105.0	109.0	113.0	117.0	121.0	125.0	129.0	133.0	137.0	141.0	145.0	149.0

Applicable Controller Specifications

Applicable controller	Maximum controlled axes	Operating method	Power-supply voltage	Reference page
XSEL	6 axes	Program	Single-phase/ three-phase AC 200 V	→P53
SSEL	2 axes	Program/positioner	Single-phase AC100/200V	→P52
SCON	1 axis	Pulse train/positioner	Single-phase AC100/200V	→P51

Caution

(Note 1) The maximum speed may not be attained if the stroke is short.
(Note 2) The maximum acceleration varies depending on the operating conditions.
(Note 3) The maximum cable length is 20 m for the SCON/SSEL and 30 m for the XSEL. Specify a desired length in units of meters.
(Example: X08 = 8 m)

Shaft type

Small type

Flat type

Medium type

Large type

LSA-W21HS

Large type, 210 mm wide
High-thrust type, single-slider



■ Model Name **LSA-W21HS** — **I** — **1000** — — **T2** — —

Series — Type — Encoder type — Applicable drive output — Stroke — Applicable controller — Cable length — Options

I : Incremental specification 1000 : 895 : 895mm 1000W } T2 : XSEL-P/-Q S : 3m M : 5m X : Specified length N : None M : 5m X : Specified length CT2 : Cable track installation 2 CT3 : Cable track installation 3

* Refer to P. 13 for details on each item comprising the model name. 4000 : 4000mm

Model Specifications

Model	Encoder type	Applicable drive output (per slider)	Stroke Specified in 135-mm steps (mm)	Speed (Note 1) (mm/sec)	Payload (Note 2)		Rated thrust (N)	Maximum thrust (N)	Maximum acceleration (G) (Note 2)
					Horizontal (kg)	Vertical (kg)			
LSA-W21HS-I-1000- <input type="checkbox"/> -T2- <input type="checkbox"/> - <input type="checkbox"/> -L	I: Incremental	1000	895-4000	2500	120	-	400	1200	3

* In the above model names, indicates the stroke, indicates the cable length, and indicates the options.

Options

Name	Model	Reference page	Remarks
Cable track installation direction	CT2	→P14	Installation directions 2
	CT3	→P14	Installation directions 3
	CT4	→P14	Installation directions 4
Home limit switch	L	-	Standard feature

* With the large type, the home limit switch (L) is a standard feature.

Common Specifications

Drive method	Linear servo motor
Positioning repeatability	±0.005mm
Guide	Built-in linear guide
Permissible load moment	Ma: 275.2N • m Mb: 275.2 • m Mc: 275.2N • m
Overhang load length	750 mm or less in Ma direction / 750 mm or less in Mb/Mc directions
Base	Material: Aluminum with black alumite treatment
Applicable controller	T2: XSEL-P/Q
Cable length (Note 3)	N: No Cable S: 3m M: 5m X: Specified length
Ambient operating temperature	0 to 40°C, 85% RH or below (non-condensing)

Dimensions

*1 During home return, the slider will move to the ME. Accordingly, pay attention to possible contact between the slider and surrounding structures, etc.
ME: Mechanical end
SE: Stroke end

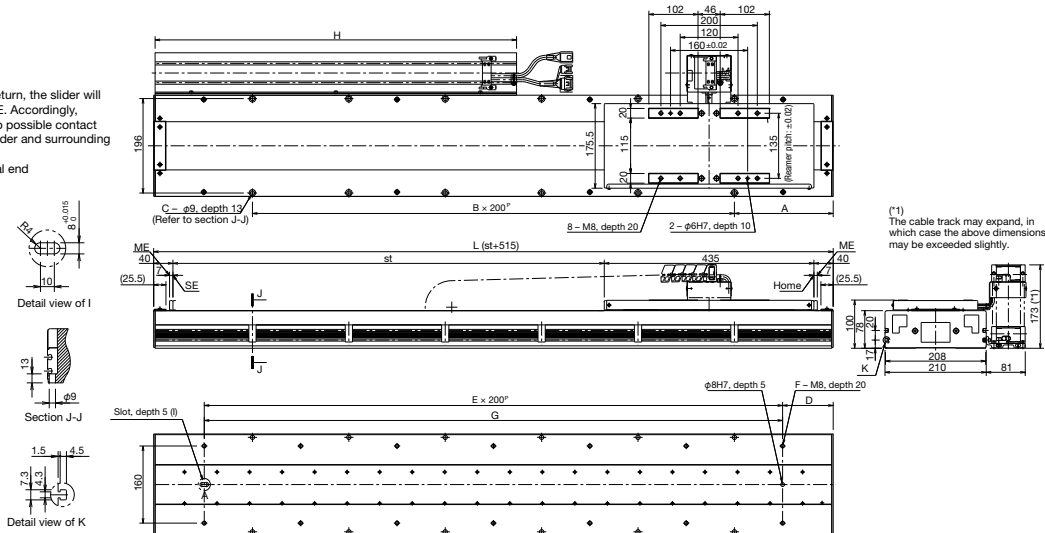

(*1) The cable track may expand, in which case the above dimensions may be exceeded slightly.

Stroke	895	1030	1165	1300	1435	1570	1705	1840	1975	2110	2245	2380	2515	2650	2785	2920	3055	3190	3325	3460	3595	3730	3865	4000
L	1410	1545	1680	1815	1950	2085	2220	2355	2490	2625	2760	2895	3030	3165	3300	3435	3570	3705	3840	3975	4110	4245	4380	4515
A	205	72.5	140	207.5	75	142.5	210	77.5	145	212.5	80	147.5	215	82.5	150	217.5	85	152.5	220	87.5	155	222.5	90	157.5
B	5	7	7	7	9	9	9	11	11	11	13	13	13	15	15	15	17	17	17	19	19	19	21	21
C	12	16	16	16	20	20	20	24	24	24	28	28	28	32	32	32	36	36	36	40	40	40	44	44
D	105	172.5	40	107.5	175	42.5	110	177.5	45	112.5	180	47.5	115	182.5	50	117.5	185	52.5	120	187.5	55	122.5	190	57.5
E	6	6	8	8	8	10	10	10	12	12	12	14	14	14	16	16	16	18	18	18	20	20	20	22
F	14	14	18	18	18	22	22	22	26	26	26	30	30	30	34	34	34	38	38	38	42	42	42	46
G	1200	1200	1600	1600	1600	2000	2000	2000	2400	2400	2400	2800	2800	2800	3200	3200	3200	3600	3600	3600	4000	4000	4000	4400
H	760	830	900	970	1040	1120	1160	1240	1310	1380	1450	1500	1570	1640	1720	1790	1840	1910	1980	2050	2120	2200	2240	2320
Weight(kg)	50.0	54.0	58.0	62.0	66.0	70.0	74.0	78.0	82.0	86.0	90.0	94.0	98.0	102.0	106.0	110.0	114.0	118.0	122.0	126.0	130.0	134.0	138.0	142.0

Applicable Controller Specifications

Applicable controller	Maximum controlled axes	Operating method	Power-supply voltage	Reference page
XSEL	6 axes	Program	Single-phase/ three-phase AC 200 V	→P53



(Note 1) The maximum speed may not be attained if the stroke is short.
(Note 2) The maximum acceleration varies depending on the operating conditions.
(Note 3) The maximum cable length is 30 m. Specify a desired length in units of meters.
(Example: X08 = 8 m)

LSA-W21HM

Large type, 210 mm wide
High-thrust type, multi-slider

■ Model Name **LSA-W21HM** — I — 1000 — — T2 — —

Series — Type — Encoder type — Applicable drive output — Stroke — Applicable controller — Cable length — Options

I: Incremental specification 1000 :420:420mm 1000W } T2 : XSEL=P/Q N: None S: 3m M: 5m L: Home limit switch (standard) X□□:

* Refer to P. 13 for details on each item comprising the model name. 3525:3525mm

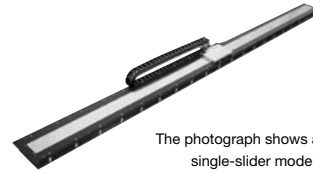

Model Specifications

Model	Encoder type	Applicable drive output (per slider)	Stroke Specified in 135-mm steps (mm)	Speed (Note 1) (mm/sec)	Payload (Note 2)		Rated thrust (N)	Maximum thrust (N)	Maximum acceleration (G) (Note 2)
					Horizontal (kg)	Vertical (kg)			
LSA-W21SM-I-1000-□-T2-□-L	I: Incremental	1000	420-3525	2500	120	-	400	1200	3

* In the above model names, □ indicates the stroke, □ indicates the cable length, and □ indicates the options.

Options

Name	Model	Reference page	Remarks
Home limit switch	L	-	Standard feature

* To change the cable track position to the opposite side, install the actuator by rotating it 180 degrees horizontally because the actuator is bilaterally symmetrical.

* With the large type, the home limit switch (L) is a standard feature.

Common Specifications

Drive method	Linear servo motor
Positioning repeatability	±0.005mm
Guide	Built-in linear guide
Permissible load moment	Ma: 275.2N • m Mb: 275.2 • m Mc: 275.2N • m
Overhang load length	750 mm or less in Ma direction / 750 mm or less in Mb/Mc directions
Base	Material: Aluminum with black alumite treatment
Applicable controller	T2: XSEL-P/Q
Cable length (Note 3)	N: No Cable S: 3m M: 5m X□□: Specified length
Ambient operating temperature	0 to 40°C, 85% RH or below (non-condensing)

Dimensions

*1 During home return, the slider will move to the ME. Accordingly, pay attention to possible contact between the slider and surrounding structures, etc.
ME: Mechanical end
SE: Stroke end

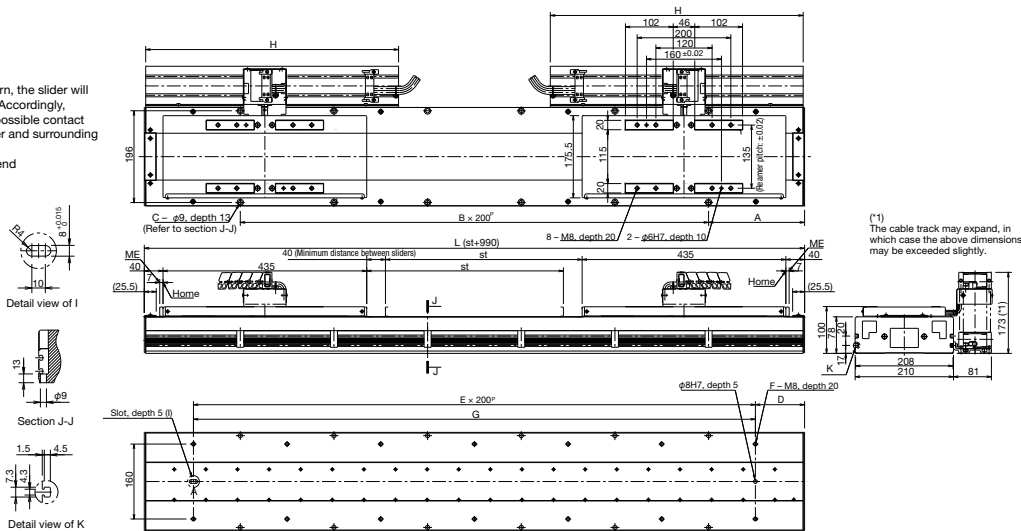

Stroke	420	555	690	825	960	1095	1230	1365	1500	1635	1770	1905	2040	2175	2310	2445	2580	2715	2850	2985	3120	3255	3390	3525
L	1410	1545	1680	1815	1950	2085	2220	2355	2490	2625	2760	2895	3030	3165	3300	3435	3570	3705	3840	3975	4110	4245	4380	4515
A	205	72.5	140	207.5	75	142.5	210	77.5	145	212.5	80	147.5	215	82.5	150	217.5	85	152.5	220	87.5	155	222.5	90	157.5
B	5	7	7	7	9	9	9	11	11	11	13	13	13	15	15	15	17	17	17	19	19	19	21	21
C	12	16	16	16	20	20	20	24	24	24	28	28	28	32	32	32	36	36	36	40	40	40	44	44
D	105	172.5	40	107.5	175	42.5	110	177.5	45	112.5	180	47.5	115	182.5	50	117.5	185	52.5	120	187.5	55	122.5	190	57.5
E	6	6	8	8	8	10	10	10	12	12	12	14	14	14	16	16	16	18	18	18	20	20	20	22
F	14	14	18	18	18	22	22	22	26	26	26	30	30	30	34	34	34	38	38	38	42	42	42	46
G	1200	1200	1600	1600	1600	2000	2000	2000	2400	2400	2400	2800	2800	2800	3200	3200	3200	3600	3600	3600	4000	4000	4000	4400
H	540	610	680	760	830	900	970	1040	1120	1160	1240	1310	1380	1450	1500	1570	1640	1720	1790	1840	1910	1980	2050	2120
Weight(kg)	65.0	69.0	73.0	77.0	81.0	85.0	89.0	93.0	97.0	101.0	105.0	109.0	113.0	117.0	121.0	125.0	129.0	133.0	137.0	141.0	145.0	149.0	153.0	157.0

Applicable Controller Specifications

Applicable controller	Maximum controlled axes	Operating method	Power-supply voltage	Reference page
XSEL	6 axes	Program	Single-phase/ three-phase AC 200 V	→P53



(Note 1) The maximum speed may not be attained if the stroke is short.
(Note 2) The maximum acceleration varies depending on the operating conditions.
(Note 3) The maximum cable length is 30 m. Specify a desired length in units of meters.
(Example: X08 = 8 m)

Shaft type

Small type

Flat type

Medium type

Large type

SCON NEW

- 1-axis position controller that lets you operate linear servo actuators, single-axis robots and ROBO Cylinders with ease
- Pulse-train control is also supported



Easy Operation of Linear Servo Actuators, Single-axis Robots and ROBO Cylinders (RCS2)

In addition to linear servo actuators, the SCON also lets you operate single-axis robots and ROBO Cylinders (RCS2 series) of varying output levels from 20 to 750 W with ease.

Operation is very simple - all you need is to store various stopping positions in the controller, and then specify each desired position using an I/O signal from a host PLC.

Up to 512 points can be stored for stopping positions.

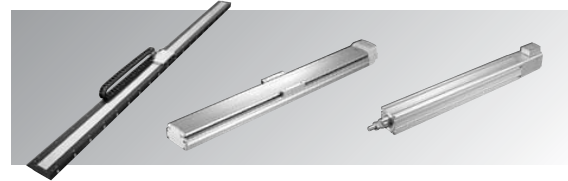

At-will Operation Using Pulse-train Control

In addition to the positioner function where the actuator is operated according to specified positions, the SCON also lets you freely control the stopping position, speed and acceleration using pulses from the host positioning unit.

This feature is ideal in applications where the target position changes every time or if you want to change the speed and acceleration freely.

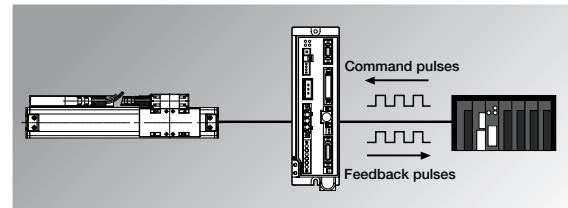

Select from 6 Functions via I/O Pattern Switching

You can select six different functions including the solenoid mode where 3-point or 7-point positioning can be performed using control actions similar to when solenoid signals are used to move an air cylinder, and the teaching mode where the actuator can be jogged to a desired position for registration of the position where the actuator has stopped.

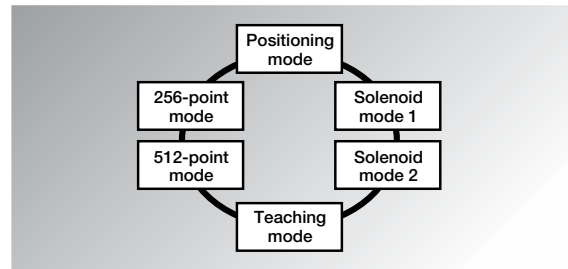

Direct Connection to DeviceNet, CC-Link and ProfiBus

If you select an optional network specification, the SCON can be connected directly to DeviceNet, CC-Link and ProfiBus (*1).

In addition to connecting directly to a field network, you can also connect your SCON to a field network via a gateway unit. This way, the SCON can receive stopping position data via the network or send the current position data to a PLC.

(*1) If the SCON is connected to a field network directly, its functions will be limited to the remote I/O level.

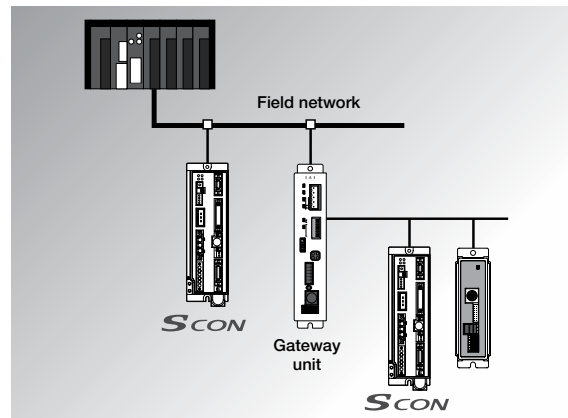

SSEL NEW

- Very affordable 2-axis controller capable of operating in the program mode or positioner mode
- Easy way to operate linear servo actuators



Supporting Single-axis Robots and ROBO Cylinders (RCS2 Series) in Addition to Linear Servo Actuators

In addition to linear servo actuators, the SSEL also lets you operate single-axis robots and ROBO Cylinders (RCS2 series) of varying output levels from 20 to 750 W. Since up to two axes can be controlled simultaneously, you can combine a large linear actuator with a single-axis robot, etc., to configure a system that transfers a load, performs coating or carries out other operations over a wide range.

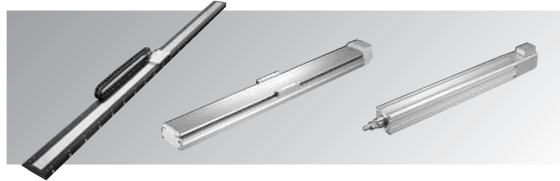

Program Mode (High Function) and Positioner Mode (Easy Operation)

You can select the “Program Mode” where the actuator can be operated with the SSEL controller alone without using a PLC or other host device, or the “Positioner Mode” where the actuator is operated by issuing I/O signals from a PLC to specify desired position numbers pre-input to the SSEL. Use the program mode if your application involves coating, path operation or other interpolation operation, or when the SSEL must exchange I/O data frequently with an external device. For simple positioning operations, use the positioner mode.

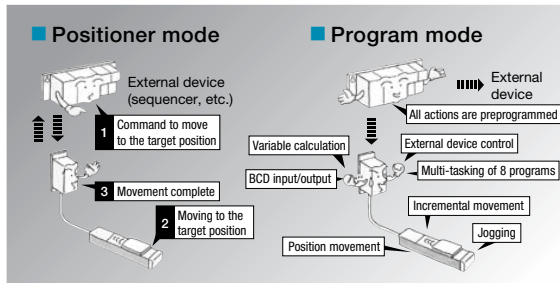

Interpolation and Synchronized Operation of 2 Axes

Operations of two actuator axes can be interpolated, which is ideal for coating and sealing operations, among others. The SSEL also offers excellent locus accuracy and uniformity of speed comparable to the XSEL, a higher version of the SSEL. As for synchronized operation, two axes can be controlled simultaneously without delay, even when the synchronized axes are high-speed actuators such as linear servo actuators.

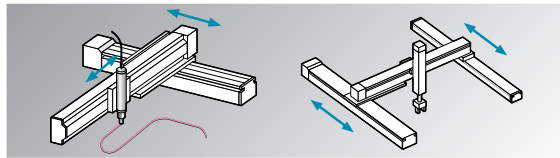

Standard USB Port

USB has become a standard interface between PCs and various peripherals. The SSEL also comes standard with a USB port. Accordingly, you can use a standard USB cable to connect your SSEL to a PC, even when the PC has no RS232C terminal, to perform data communication.



Multi-slider Collision Prevention Function

A new function has been added to prevent two sliders from colliding with each other when operated independently in the multi-slider operation mode. This function is effective not only during automatic operation, but also while the actuators are manually jogged. With the collision prevention function, you can be assured of safety at all time.

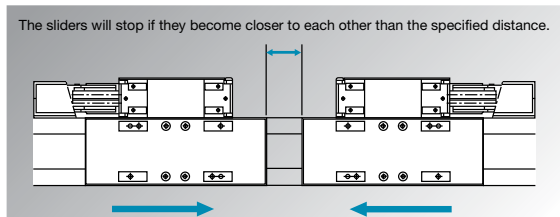

X-SEL

- High-function, multi-axis controller capable of controlling up to six axes simultaneously (*1)
- Directly connectable to DeviceNet, CC-Link and other field networks

*1 If all axes are linear servo actuators, only up to four axes can be connected.



Operating Up to 6 Axes for a Total Power Output of 2,400 W

Up to six axes of linear servo actuators, single-axis robots and ROBO Cylinders (RCS series) can be operated. For example, you can operate with one XSEL controller a combination of two synchronized linear servo actuators for the X-axis, single-axis robot for the Y-axis and ROBO Cylinder for the Z-axis.

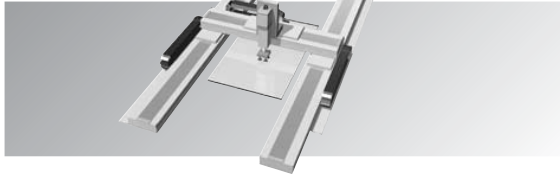

A Lineup of “Global Models” Supporting Safety Category 4

The XSEL series includes “global models” having no built-in drive-source cutoff circuit so that the controller can be used with an external safety circuit. You can configure a safety circuit to meet safety category 4 under ISO 13849-1.

Many Network Options Supporting DeviceNet, CC-Link, ProfiBus and Ethernet

In addition to standard PIO communication, the XSEL also offers optional specifications that support expansion PIO communication (maximum 192 input points and 192 output points) as well as various field networks (DeviceNet, CC-Link, ProfiBus and Ethernet). The XSEL also comes standard with a 2-channel RS232C communication function and also supports various other communication protocols.

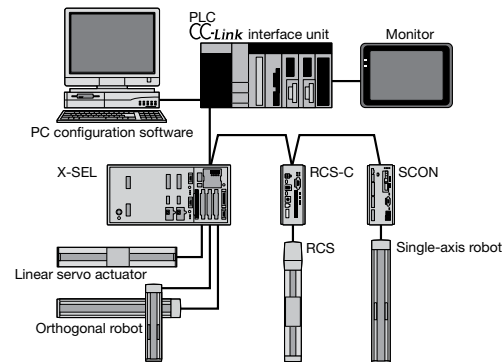
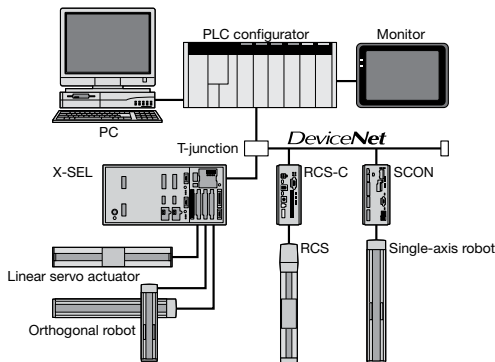

Zone Signal

The zone signal is a function that causes a signal to be output when the slider moves into a specified zone that can be set freely within the stroke range. This function is effective if you want to output signals at desired positions during coating or other operation. (Up to four signal zones can be set for each axis.)

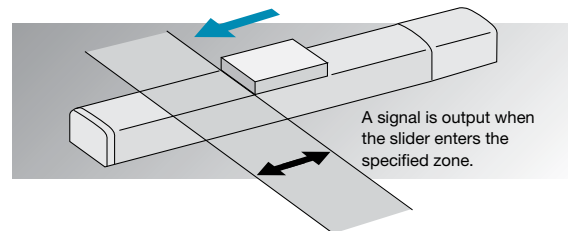

CE Mark Certification

The XSEL conforms to the CE Mark standard as shipped, so you can use within your product bound for overseas countries.

Multi-slider Collision Prevention Function

A function has been added to prevent two sliders from colliding with each other.

Controller Specifications

	Controller series/type	SCON	SSEL	XSEL	
				P (standard) type	Q (global) type
Basic specifications	Connected actuators	Linear servo actuators (excluding W21HS/W21HM) Single-axis robots (20 to 750 W)		Linear servo actuators (all models) Single-axis robots (20 to 750 W)	
	Power-supply capacity	844 VA max.	1652 VA max.	3735 VA max.	
	Insulation resistance	DC 500 V, 100 MΩ or more		DC 500 V, 10 MΩ or more	
	Withstand voltage	AC 1500 V, 1 minute		AC 2500 V, 1 minute	AC 1500 V, 1 minute
	Input power supply	Single-phase AC 100 V Single-phase AC 200 V	Single-phase AC 100 V Single-phase AC 200 V	Single-phase AC 200 V Three-phase AC 200 V	
	Operating power-supply voltage range	±10%			
Control specifications	Total maximum output of connected axes (W)	300W (100 V power-supply specification) 750W (200 V power-supply specification)	400W (100 V power-supply specification) 800W (200 V power-supply specification)	2400	
	Maximum number of controlled axes	1 axis	2 axes	6 axes (or up to 4 axes of linear servo actuators)	
	Position detection method	Incremental encoder/absolute encoder			
	Safety circuit configuration	Redundancy not supported		Redundancy not supported	Redundancy supported
	Cutoff of drive source	Cut off by an internal relay		Cut off by an internal relay	External safety circuit
	Enable input	Contact B input (Internal power feed)		Contact B input (Internal power feed)	Contact B input (External power feed, redundant)
	Speed setting	1 mm/sec ~ (The maximum limit varies depending on the actuator.)			
	Acceleration setting	0.01G ~ (The maximum limit varies depending on the actuator.)			
	Operation method	Positioner operation Pulse-train control	Program operation Positioner operation (Switchable)	Program operation only	
	Program	Program language	-		Super SEL language
Number of programs		-		128	
Number of program steps		-		9999	9999
Number of multi-tasking programs		-		8	16
Number of positions		512 max.	20000	20000	
Data storage device		EEPROM	FLASHROM (+ SRAM battery backup option)	FLASHROM + SRAM battery backup	
Data input method		Teaching pendant or PC software			
I/O & communication	Standard I/Os	16 input points/16 output points (NPN/PNP selectable)	24 input points/8 output points (NPN/PNP selectable)	32 input points/16 output points (NPN/PNP selectable)	
	Expansion I/Os	Not supported		Up to 192 input points/192 output points	
	Serial communication function	Teaching port (RS485)	Teaching port (RS232C) USB connector	Teaching port (RS232C) 2-channel RS232C port	
	Other I/Os	System I/Os (Emergency stop input, brake power)	System I/Os (Emergency stop input, enable input, brake power)	System I/Os (Emergency stop input, enable input, ready output)	
	Field networks	DeviceNet, CC-Link, ProfiBus	(Will be supported in future versions)	DeviceNet, CC-Link, ProfiBus, Ethernet	
General specifications	Protective functions	Motor overcurrent, motor driver temperature check, overload check, encoder open check, soft limit overtravel, system error, battery error, etc.			
	Surrounding air temperature/humidity	0 to 40°C, 10 to 95% (non-condensing)			
	Surrounding ambient	Free from corrosive gases. Not subject to significant powder dust.			
	External dimensions	58(W)×200.5(H)×121(D) (Less than 400 W) 72(W)×200.5(H)×121(D) (400 W or more)	100(W)×202.6(H)×126(D) (When the absolute battery is installed)	340(W)×195(H)×125.3(D) (6-axis absolute specification)	
	Weight	0.8kg 1.1kg	1.4kg	5.7kg (6-axis absolute specification)	
	Accessory	I/O flat cable (40 cores)		I/O flat cable (34 cores)	I/O flat cable (50 cores)

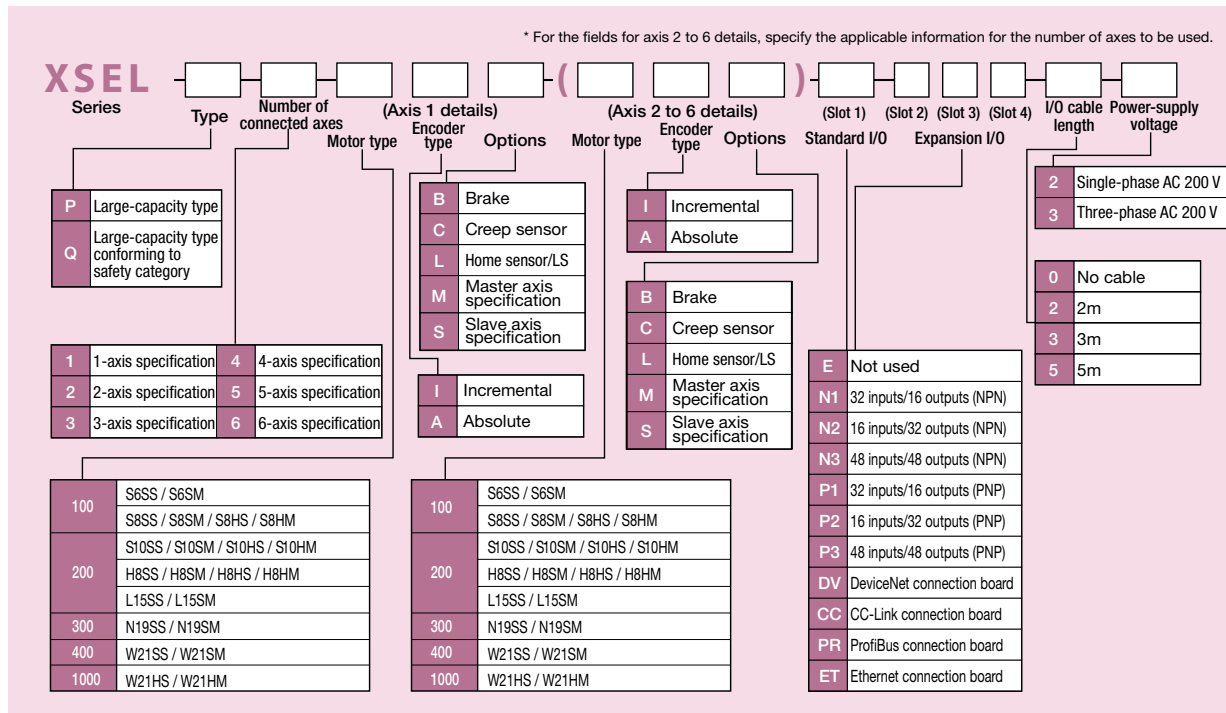

- (Note)**
- Although the XSEL controller can control up to six axes, take note that only up to four axes are accepted if all axes are linear servo actuators. In other words, axes 5 and 6 should always be single-axis robots.
 - If large high-thrust actuators (W21H□) are to be operated, take note that one large axis occupies the space for two axes (axes 1 and 2, or axes 3 and 4).
 - If large high-thrust actuators (W21□□) are to be operated, specify "L" in the options field.
 - All linear servo actuator models are of incremental specification. Accordingly, absolute controllers cannot be used with linear servo actuators.

I/O Signal Table

I/O Signal Table [SCON Controller] * Take note that network-ready controllers do not support pulse-train control.

The SCON controller basically operates actuators using I/O signals from a PLC. However, you can change the functions pre-assigned to respective I/Os. Select a desired I/O signal assignment pattern according to the specific conditions of use, from a total of seven modes including six positioner modes and one pulse-train mode.

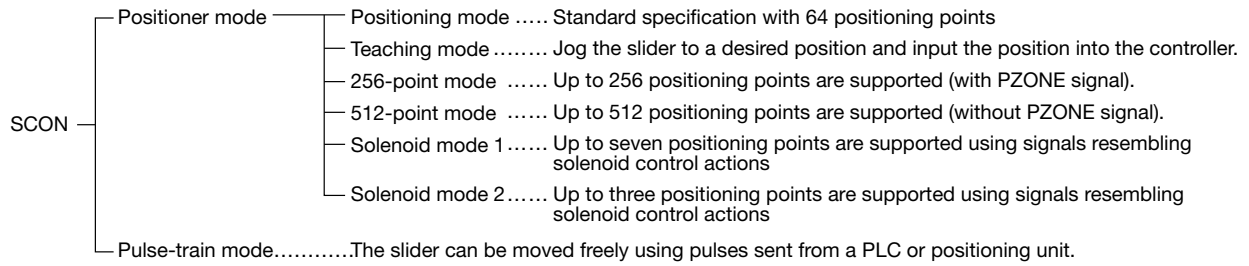

Pin No.	Category	Number of positioning points Zone signal P zone signal	Parameter (PIO pattern) selection						Pulse-train mode
			0	1	2	3	4	5	0
			Positioning mode	Teaching mode	256-point mode	512-point mode	Solenoid mode 1	Solenoid mode 2	Pulse-train mode
		64 points	64 points	256 points	512 points	7 points	3 points	-	
		o	x	x	x	o	o	x	
		o	o	o	x	o	o	x	
1A	24V				P24			P24	
2A	24V				P24			P24	
3A	-				NC			NC	
4A	-				NC			NC	
5A		IN0	PC1	PC1	PC1	PC1	ST0	ST0	SON
6A		IN1	PC2	PC2	PC2	PC2	ST1	ST1 (JOG+)	RES
7A		IN2	PC4	PC4	PC4	PC4	ST2	ST2	HOME
8A		IN3	PC8	PC8	PC8	PC8	ST3	-	TL
9A		IN4	PC16	PC16	PC16	PC16	ST4	-	CSTP
10A		IN5	PC32	PC32	PC32	PC32	ST5	-	DCLR
11A	Input	IN6	-	MODE	PC64	PC64	ST6	-	BKRL
12A		IN7	-	JISL	PC128	PC128	-	-	RMOD
13A		IN8	-	JOG+	-	PC256	-	-	-
14A		IN9	BKRL	JOG-	BKRL	BKRL	BKRL	BKRL	-
15A		IN10	RMOD	RMOD	RMOD	RMOD	RMOD	RMOD	-
16A		IN11	HOME	HOME	HOME	HOME	HOME	-	-
17A		IN12	*STP	*STP	*STP	*STP	*STP	-	-
18A		IN13	CSTR	CSTR/PWRT	CSTR	CSTR	-	-	-
19A		IN14	RES	RES	RES	RES	RES	RES	-
20A		IN15	SON	SON	SON	SON	SON	SON	-
1B		OUT0	PM1	PM1	PM1	PM1	PE0	LS0	PWR
2B		OUT1	PM2	PM2	PM2	PM2	PE1	LS1 (TRQS)	SV
3B		OUT2	PM4	PM4	PM4	PM4	PE2	LS2	INP
4B		OUT3	PM8	PM8	PM8	PM8	PE3	-	HEND
5B		OUT4	PM16	PM16	PM16	PM16	PE4	-	TLR
6B		OUT5	PM32	PM32	PM32	PM32	PE5	-	*ALM
7B		OUT6	MOVE	MOVE	PM64	PM64	PE6	-	*EMGS
8B	Output	OUT7	ZONE1	MODES	PM128	PM128	ZONE1	ZONE1	RMDS
9B		OUT8	PZONE	PZONE	PZONE	PN256	PZONE	PZONE	ALM1
10B		OUT9	RMDS	RMDS	RMDS	RMDS	RMDS	RMDS	ALM2
11B		OUT10	HEND	HEND	HEND	HEND	HEND	HEND	ALM4
12B		OUT11	PEND	PEND/WEND	PEND	PEND	PEND	-	ALM8
13B		OUT12	SV	SV	SV	SV	SV	SV	-
14B		OUT13	*EMGS	*EMGS	*EMGS	*EMGS	*EMGS	*EMGS	-
15B		OUT14	*ALM	*ALM	*ALM	*ALM	*ALM	*ALM	-
16B		OUT15	*BALM	*BALM	*BALM	*BALM	*BALM	*BALM	-
17B									-
18B									-
19B	0V				N				N
20B	0V				N				N

* Signals with an asterisk (*) are negative-logic signals.

I/O Signal Table [SSEL Controller]

With the SSEL controller, you can select the “Program Mode” where a program is input to operate the actuator, or the “Positioner Mode” where the actuator moves to the position specified by a signal received from a host PLC. The positioner mode includes five input patterns suitable for different applications, so you can select a desired pattern to match the specific operation of your equipment. (Please contact IAI for details.)

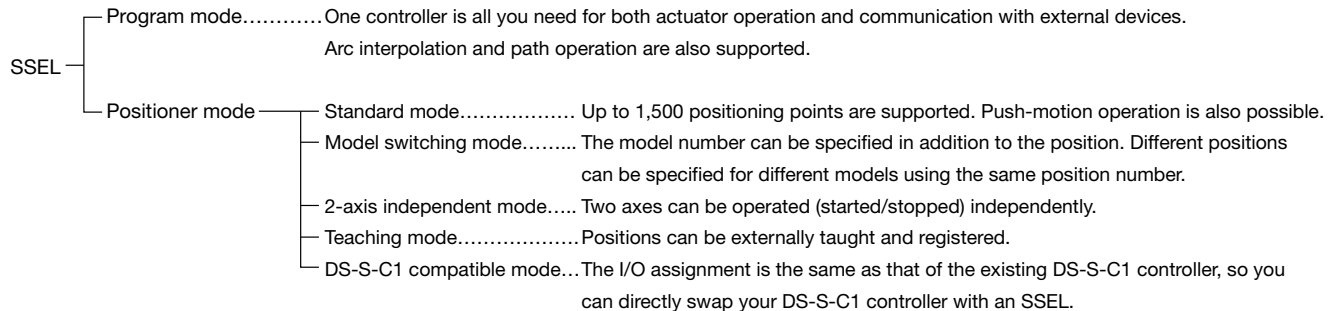

Pin No.	Category	Board No.	Program mode	Positioner mode					
				Standard mode	Model switching mode	2-axis independent mode	Teaching mode	DS-S-C1 compatible mode	
1A	P24		24 V input						
1B	Input	016	Program No. 1 selection	Position input 10	Input 10	Position input 7	Axis 1 jog -	Position No. 1000	
2A		017	Program No. 2 selection	Position input 11	Input 11	Position input 8	Axis 2 jog +	-	
2B		018	Program No. 4 selection	Position input 12	Input 12	Position input 9	Axis 2 jog -	-	
3A		019	Program No. 8 selection	Position input 13	Input 13	Position input 10	Inching specification (0.01 mm)	-	
3B		020	Program No. 10 selection	-	Input 14	Position input 11	Inching specification (0.1 mm)	-	
4A		021	Program No. 20 selection	-	Input 15	Position input 12	Inching specification (0.5 mm)	-	
4B		022	Program No. 40 selection	-	Input 16	Position input 13	Inching specification (1 mm)	-	
5A		023	CPU reset	Error reset	Error reset	Error reset	Error reset	CPU reset	
5B		000	Start	Start	Start	Axis 1 start	Start	Start	
6A		001	General-purpose input	Home return	Home return	Axis 1 home return	Servo ON	Hold (pause)	
6B		002	General-purpose input	Servo ON	Servo ON	Axis 1 servo ON	Pause	Cancellation	
7A		003	General-purpose input	Push	Push	Axis 1 pause	Position input 1	Interpolation setting	
7B		004	General-purpose input	Pause	Pause	Axis 1 cancellation	Position input 2	Position No. 1	
8A		005	General-purpose input	Cancel	Cancel	Axis 2 start	Position input 3	Position No. 2	
8B		006	General-purpose input	Interpolation setting	Interpolation setting	Axis 2 home return	Position input 4	Position No. 4	
9A		007	General-purpose input	Position input 1	Input 1	Axis 2 servo ON	Position input 5	Position No. 8	
9B		008	General-purpose input	Position input 2	Input 2	Axis 2 pause	Position input 6	Position No. 10	
10A		009	General-purpose input	Position input 3	Input 3	Axis 2 cancellation	Position input 7	Position No. 20	
10B		010	General-purpose input	Position input 4	Input 4	Position input 1	Position input 8	Position No. 40	
11A		011	General-purpose input	Position input 5	Input 5	Position input 2	Position input 9	Position No. 80	
11B		012	General-purpose input	Position input 6	Input 6	Position input 3	Position input 10	Position No. 100	
12A		013	General-purpose input	Position input 7	Input 7	Position input 4	Position input 11	Position No. 200	
12B		014	General-purpose input	Position input 8	Input 8	Position input 5	Teaching mode specification	Position No. 400	
13A		015	General-purpose input	Position input 9	Input 9	Position input 6	Axis 1 jog +	Position No. 800	
13B		300	Alarm	Alarm	Alarm	Alarm	Alarm	Alarm	
14A		301	Ready	Ready	Ready	Ready	Ready	Ready	
14B		302	General-purpose input	Positioning complete	Positioning complete	Axis 1 positioning complete	Positioning complete	Positioning complete	
15A		303	General-purpose input	Home return complete	Home return complete	Axis 1 home return complete	Home return complete	-	
15B		304	General-purpose input	Servo ON output	Servo ON output	Axis 1 servo ON output	Servo ON output	-	
16A		305	General-purpose input	Push complete	Push complete	Axis 2 positioning complete	-	-	
16B		306	General-purpose input	System battery error	System battery error	Axis 2 home return complete	System battery error	System battery error	
17A		307	General-purpose input	Absolute battery error	Absolute battery error	Axis 2 servo ON output	Absolute battery error	Absolute battery error	
17B		N		0V input					

* Positions can be input as either binary data or BCD data by switching the applicable setting.

I/O Signal Table [XSEL Controller]

With the XSEL controller, the number of I/O points can be increased by installing up to three expansion I/O boards in addition to the standard I/O board.

You can select a desired type of expansion I/O board offering ① 32 input points/16 output points (model N1/P1), ② 16 input points/32 output points (model N2/P2), or ③ 48 input points/48 output points (model N3/P3).

■ Standard I/O Assignment Table (Model N1/P1)

Pin No.	Category	Board No.	Standard setting
1	Input	P24	24 V input
2		Program start	
3		General-purpose input	
4		General-purpose input	
5		General-purpose input	
6		General-purpose input	
7		General-purpose input	
8		General-purpose input	
9		Program setting (No. 1)	
10		Program setting (No. 2)	
11		Program setting (No. 4)	
12		Program setting (No. 8)	
13		Program setting (No. 10)	
14		Program setting (No. 20)	
15		Program setting (No. 40)	
16		General-purpose input	
17	General-purpose input		
18	General-purpose input		
19	General-purpose input		
20	General-purpose input		
21	General-purpose input		
22	General-purpose input		
23	General-purpose input		
24	General-purpose input		
25	General-purpose input		
26	General-purpose input		
27	General-purpose input		
28	General-purpose input		
29	General-purpose input		
30	General-purpose input		
31	General-purpose input		
32	General-purpose input		
33	General-purpose input		
34	Alarm output		
35	Ready output		
36	Emergency stop output		
37	General-purpose output		
38	General-purpose output		
39	General-purpose output		
40	General-purpose output		
41	General-purpose output		
42	General-purpose output		
43	General-purpose output		
44	General-purpose output		
45	General-purpose output		
46	General-purpose output		
47	General-purpose output		
48	General-purpose output		
49	General-purpose output		
50	N		0 V input

■ Expansion I/O Assignment Table (Model N1/P1)

Pin No.	Category	Board No.	Standard setting
1	Input	P24	24 V input
2		General-purpose input	
3		General-purpose input	
4		General-purpose input	
5		General-purpose input	
6		General-purpose input	
7		General-purpose input	
8		General-purpose input	
9		General-purpose input	
10		General-purpose input	
11		General-purpose input	
12		General-purpose input	
13		General-purpose input	
14		General-purpose input	
15		General-purpose input	
16		General-purpose input	
17	General-purpose input		
18	General-purpose input		
19	General-purpose input		
20	General-purpose input		
21	General-purpose input		
22	General-purpose input		
23	General-purpose input		
24	General-purpose input		
25	General-purpose input		
26	General-purpose input		
27	General-purpose input		
28	General-purpose input		
29	General-purpose input		
30	General-purpose input		
31	General-purpose input		
32	General-purpose input		
33	General-purpose input		
34	General-purpose output		
35	General-purpose output		
36	General-purpose output		
37	General-purpose output		
38	General-purpose output		
39	General-purpose output		
40	General-purpose output		
41	General-purpose output		
42	General-purpose output		
43	General-purpose output		
44	General-purpose output		
45	General-purpose output		
46	General-purpose output		
47	General-purpose output		
48	General-purpose output		
49	General-purpose output		
50	N		0 V input

■ Expansion I/O Assignment Table (Model N2/P2)

Pin No.	Category	Board No.	Standard setting
1	Input	P24	24 V input
2		General-purpose input	
3		General-purpose input	
4		General-purpose input	
5		General-purpose input	
6		General-purpose input	
7		General-purpose input	
8		General-purpose input	
9		General-purpose input	
10		General-purpose input	
11		General-purpose input	
12		General-purpose input	
13		General-purpose input	
14		General-purpose input	
15		General-purpose input	
16		General-purpose input	
17	General-purpose input		
18	General-purpose output		
19	General-purpose output		
20	General-purpose output		
21	General-purpose output		
22	General-purpose output		
23	General-purpose output		
24	General-purpose output		
25	General-purpose output		
26	General-purpose output		
27	General-purpose output		
28	General-purpose output		
29	General-purpose output		
30	General-purpose output		
31	General-purpose output		
32	General-purpose output		
33	General-purpose output		
34	General-purpose output		
35	General-purpose output		
36	General-purpose output		
37	General-purpose output		
38	General-purpose output		
39	General-purpose output		
40	General-purpose output		
41	General-purpose output		
42	General-purpose output		
43	General-purpose output		
44	General-purpose output		
45	General-purpose output		
46	General-purpose output		
47	General-purpose output		
48	General-purpose output		
49	General-purpose output		
50	N		0 V input

■ Expansion I/O Assignment Table (Model N3/P3)

Pin No.	Category	Board No.	Standard setting	Pin No.	Category	Board No.	Standard setting
1	Input	P24	24 V input (pin Nos. 2 to 25/51 to 74)	51	Output		General-purpose output
2		General-purpose input	52	General-purpose output			
3		General-purpose input	53	General-purpose output			
4		General-purpose input	54	General-purpose output			
5		General-purpose input	55	General-purpose output			
6		General-purpose input	56	General-purpose output			
7		General-purpose input	57	General-purpose output			
8		General-purpose input	58	General-purpose output			
9		General-purpose input	59	General-purpose output			
10		General-purpose input	60	General-purpose output			
11		General-purpose input	61	General-purpose output			
12		General-purpose input	62	General-purpose output			
13		General-purpose input	63	General-purpose output			
14		General-purpose input	64	General-purpose output			
15		General-purpose input	65	General-purpose output			
16		General-purpose input	66	General-purpose output			
17	General-purpose input	67	General-purpose output				
18	General-purpose input	68	General-purpose output				
19	General-purpose input	69	General-purpose output				
20	General-purpose input	70	General-purpose output				
21	General-purpose input	71	General-purpose output				
22	General-purpose input	72	General-purpose output				
23	General-purpose input	73	General-purpose output				
24	General-purpose input	74	General-purpose output				
25	General-purpose input	75	N	0 V input (pin Nos. 2 to 25/51 to 74)			
26	P24	24 V input (pin Nos. 27 to 50/76 to 99)	76	General-purpose output			
27	General-purpose input	77	General-purpose output				
28	General-purpose input	78	General-purpose output				
29	General-purpose input	79	General-purpose output				
30	General-purpose input	80	General-purpose output				
31	General-purpose input	81	General-purpose output				
32	General-purpose input	82	General-purpose output				
33	General-purpose input	83	General-purpose output				
34	General-purpose input	84	General-purpose output				
35	General-purpose input	85	General-purpose output				
36	General-purpose input	86	General-purpose output				
37	General-purpose input	87	General-purpose output				
38	General-purpose input	88	General-purpose output				
39	General-purpose input	89	General-purpose output				
40	General-purpose input	90	General-purpose output				
41	General-purpose input	91	General-purpose output				
42	General-purpose input	92	General-purpose output				
43	General-purpose input	93	General-purpose output				
44	General-purpose input	94	General-purpose output				
45	General-purpose input	95	General-purpose output				
46	General-purpose input	96	General-purpose output				
47	General-purpose input	97	General-purpose output				
48	General-purpose input	98	General-purpose output				
49	General-purpose input	99	General-purpose output				
50	General-purpose input	100	N	0 V input (pin Nos. 27 to 50/76 to 99)			

External Dimensions/Options

External Dimensions

[SCON]

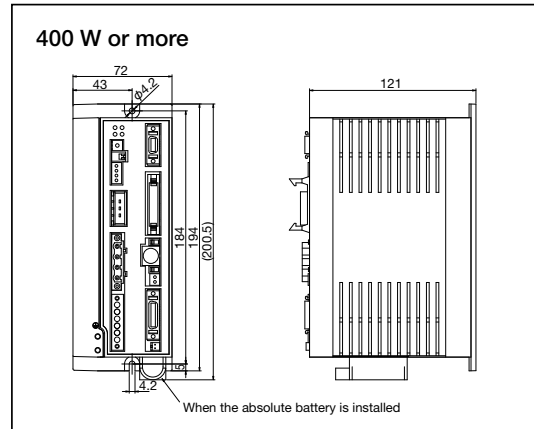
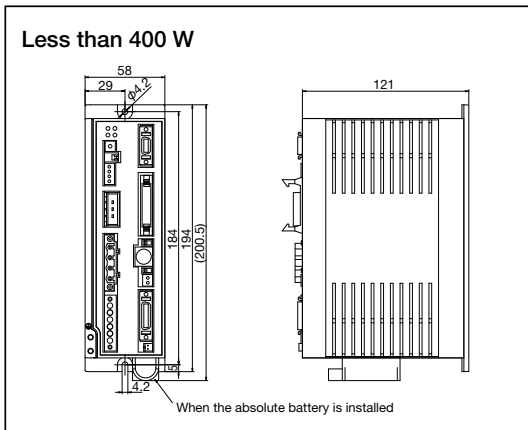

[SSEL] (Common to 1-axis and 2-axis Specifications)

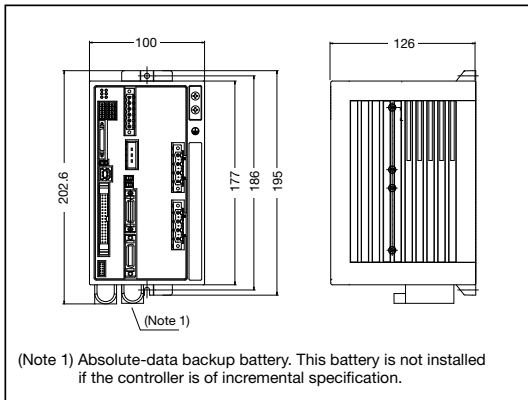

[XSEL]

	Axes 1 to 4	Axes 5, 6	Side view (common)
Type P [Standard specification]			
Type Q [Global specification] * The single-phase 200V AC specification conforms to the dimensions of type P.			

List of Options/Replacement Parts

Item	Model	Remarks	SCON	SSEL	XSEL
Teaching pendant (standard)	RCM-T		○	—	—
	RCM-E		○	—	—
	IA-T-X-J	With connector conversion cable	—	○	○
	IA-T-X		—	—	○
Teaching pendant (with deadman switch)	RCM-TD		○	—	—
	IA-T-XD-J	With connector conversion cable	—	○	○
	IA-T-XD		—	—	○
Teaching pendant (ANSI type)	IA-T-XA-J	With connector conversion cable	—	○	○
	IA-T-XA		—	—	○
Data setting unit	RCM-P		○	—	—
PC software (with RS232 cable)	RCM-101-MW		○	—	—
	IA-101-X-MW-J	With connector conversion cable	—	○	○
	IA-101-X-MW	D-sub, 9-pin connector on PC end	—	—	○
PC software (safety category 4)	IA-101-XA-MW	D-sub, 9-pin connector on PC end	—	—	○
PC software (with USB cable)	IA-101-X-USB	USB connector on PC end	—	○	—
PC software (USB conversion specification)	IA-101-X-USBMW	USB connector on PC end	—	—	○
	RCM-101-USB		○	—	—
Regenerative resistance unit	REU-1	For XSEL controller	—	—	○
	REU-2	For SSEL controller or SCON controller	○	○	—
Panel unit	PU-1	Cable length: 3 m	—	○	—
Expansion I/O board	IA-103-X-32	32 input points/16 output points, NPN specification	—	—	○
Expansion I/O board	IA-103-X-32-P	32 input points/16 output points, PNP specification	—	—	○
Expansion I/O board	IA-103-X-16	16 input points/32 output points, NPN specification	—	—	○
Expansion I/O board	IA-103-X-16-P	16 input points/32 output points, PNP specification	—	—	○
Expansion I/O board	IA-IO-3204-NP	48 input points/48 output points, NPN specification	—	—	○
Expansion I/O board	IA-IO-3204-PN	48 input points/48 output points, PNP specification	—	—	○
Absolute-data backup battery	AB-5		○	○	○
Dummy plug	DP-3		—	○	—
USB conversion adapter	IA-CV-USB		—	—	○
	RCB-CV-USB		○	—	—
USB cable	CB-SEL-USB010	Cable length: 1 m	—	○	○
Connector conversion cable	CB-SEL-SJ002	Cable length: 0.2 m	—	○	—

Options

Teaching Pendant

Feature Teaching device offering functions for position input, test operation, monitoring, and more.

Model **RCM-T** (standard type)
RCM-TD (deadman switch type)
RCM-E (simplified teaching pendant)
RCM-P (data setting unit)

Configuration

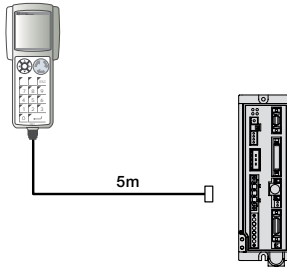

RCM-T/TD

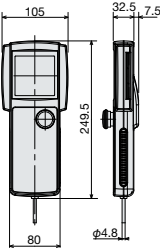

RCM-E

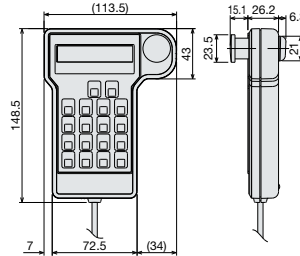

RCM-P

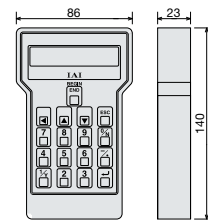

Specifications

Item	RCM-T-TD	RCM-E	RCM-P
Surrounding air temperature/humidity	Temperature 0 to 40°C / Humidity 85% RH or below		
Surrounding ambience	Free from corrosive gases. Not subject to significant powder dust.		
Weight	Approx. 650g	Approx. 400g	Approx. 360g
Cable length	5m		
Display	LCD display with 21 characters x 16 lines	LCD display with 16 characters x 2 lines	LCD display with 16 characters x 2 lines

PC Software (Windows Only)

Feature Startup support software equipped with functions for program/position input, test operation, monitoring, and more. Improved debugging functions help you reduce the time required for initial startup.

Model **RCM-101-MW**
 (with external device communication cable + RS232 conversion unit)

Configuration

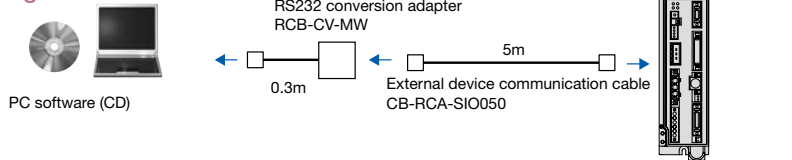

Model **RCM-101-USB**
 (with external device communication cable + USB conversion unit + USB cable)

Configuration

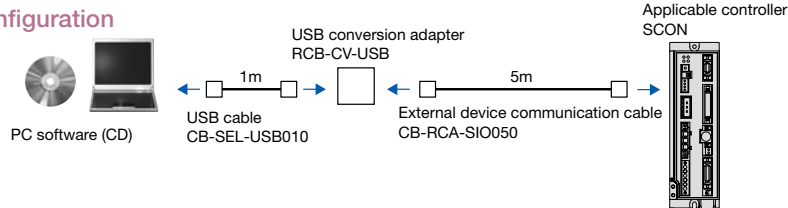

Options

Teaching Pendant

Feature Teaching device offering functions for program/position input, test operation, monitoring, and more.

- Model** **IA-T-X-J** (standard type with connector conversion cable)
IA-T-X (standard type)
IA-T-XD-J (deadman switch type with connector conversion cable)
IA-T-XD (deadman switch type)
IA-T-XA-J (ANSI type with connector conversion cable)
IA-T-XA (ANSI type)

IA-T-X/XD

IA-T-XA

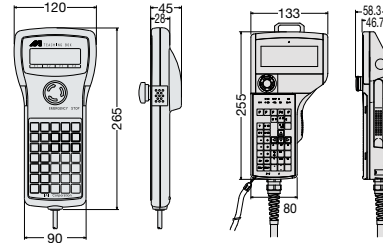

Configuration

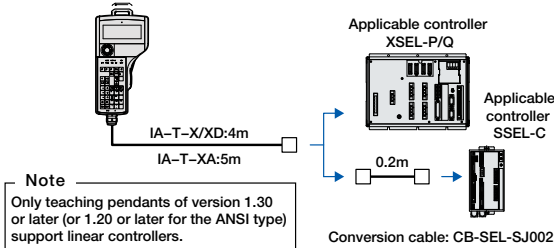

Note
 Only teaching pendants of version 1.30 or later (or 1.20 or later for the ANSI type) support linear controllers.

Specification

Item	IA-T-X/XD	IA-T-XA
Surrounding air temperature/humidity	Temperature 0 to 40°C / Humidity 85% RH or below	
Surrounding ambience	Free from corrosive gases. Not subject to significant powder dust.	Protected structure conforming to IP54
Weight	Approx. 650 g	Approx. 600 g (excluding cable)
Cable length	4m	5m
Display	LCD display with 20 characters x 4 lines	LCD display with 32 characters x 8 lines

PC Software (Windows Only)

Feature Startup support software equipped with functions for program/position input, test operation, monitoring, and more. Improved debugging functions help you reduce the time required for initial startup.

- Model** **IA-101-X-MW-J** (with RS232C cable + connector conversion cable)
IA-101-X-MW (with RS232C cable)

Configuration

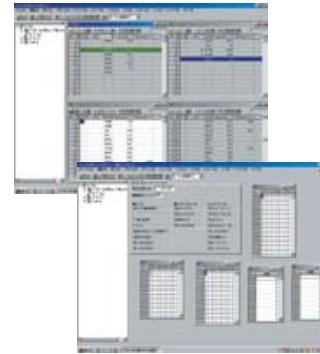
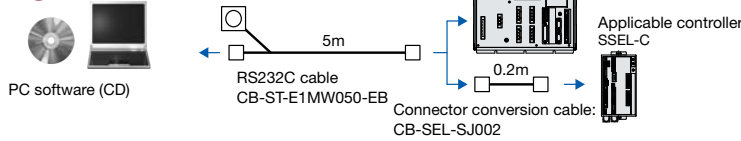

- Model** **IA-101-XA-MW** (with cable conforming to safety category 4)

Configuration



Note
 Only PC software of version 6.0.0.0 or later supports linear controllers.

- Model** **IA-101-X-USB** (with USB cable)

Configuration

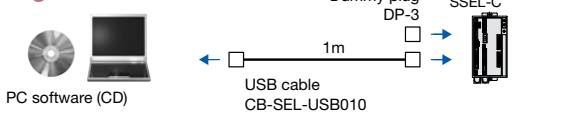

- Model** **IA-101-X-USBMW** (with USB conversion adapter + cable)

Configuration

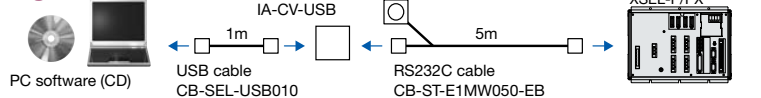

Regenerative Resistance Unit

Feature This unit returns to heat the regenerative current produced by the motor during deceleration. Use the table on the right to check the total wattage of the actuators you want to operate, and provide one or more regenerative resistance units as required.

Model REU-1 (XSEL)

REU-2 (SCON/SSEL)

Specifications

Weight	0.9kg
Built-in regenerative resistor	220Ω 80W
Unit-controller connection cable (supplied)	CB-ST-REU010 (XSEL) CB-SC-REU010 (SSEL)

Reference for Determining the Necessary Number of Regenerative Resistance Units

	Horizontal			Vertical		
	XSEL	SSEL	SCON	XSEL	SSEL	SCON
0	~200W	~800W	~200W	~100W	~200W	~100W
1	~1000W		~750W	~800W	~600W	~400W
2	~1500W			~1200W	~800W	~750W
3	~2000W			~1600W		
4				~2000W		
5				~2400W		

* Depending on the operating conditions, more regenerative resistance may be required than what is specified above.

* If you are using an SCON/SSEL and the total wattage suggests that you need two regenerative resistance units, use an REU-1 for the second unit.

External Dimensions

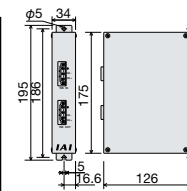

Panel Unit

Feature Display unit for checking controller error codes and the program number of the current program.

Model PU-1 (Cable length: 3 m)

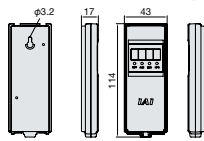

System-memory Backup Battery

Feature Use this battery if you are using global flags, etc., in your programs and thus want to retain the data even after the power is turned off. (This battery is used with the SSEL.)

Model AB-5-CS (with case)
AB-5 (battery only)



Absolute-data Backup Battery

Feature This battery backs up absolute data when an actuator of absolute specification is operated. The absolute-data backup battery is not required for linear servo actuators because all linear servo actuator models are of incremental specification.

Model AB-5



Dummy Plug

Feature This plug is connected to the teaching port on an SSEL controller to short the enable circuit, so that the controller can be connected to a PC via a USB cable. (The dummy plug is supplied with PC software IA-101-X-USB.)

Model DP-3



USB conversion adapter

Feature This adapter is used to convert signals received through the RS232 cable or external device communication cable to the format supported by the USB cable.

Model IA-CV-USB (supplied with IA-101-X-USB)
RCB-CV-USB (supplied with RCM-101-USB)

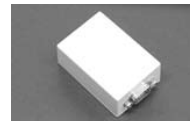

RS232 conversion adapter

Feature This adapter is used to convert signals received through the external device communication cable (RS485 communication) to the format supported by the RS232 terminal.

Model RCB-CV-MW (supplied with RCM-101-MW)



USB Cable

Feature This cable is used to connect a controller with USB port (SSEL) to a PC. To connect a controller without USB port (XSEL) to a PC, use the USB conversion adapter to connect the RS232C cable to the USB cable, and connect the USB cable to the USB port on the PC. (Refer to the explanation of PC software IA-101-X-USBMW.)

Model CB-SEL-USB010 (Cable length: 1 m)



External Device Communication Cable

Feature This cable is used to connect an SCON controller to a PC. (The RS232 conversion adapter is needed to connect to the PC.)

Model CB-RCA-SIO050 (5m) (supplied with RCM-101-MW)



Connector Conversion Cable

Feature This conversion cable is used to connect the D-sub, 25-pin connector for teaching pendant or PC software to the teaching connector (half-pitch) on an SSEL controller.

Model CB-SEL-SJ002 (Cable length: 0.2 m)



External Dimensions/Options

Cable

Motor Cable

Model **CB-X-MA**□□□ (for shaft type, small type, flat type, medium type)
CB-XMC-MA□□□ (for large type)

* Specify the cable length (L) in □□□. Example 080 = 8 m
 The maximum length is 20 m for the SCON/SSEL and 30 m for the XSEL.

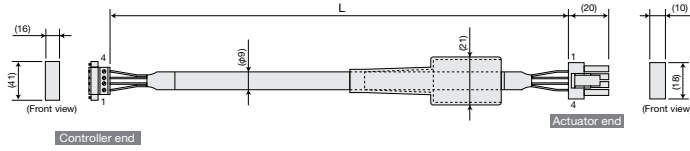

Wire	Color	Signal	No.	No.	Signal	Color	Wire
0.75sq	Green	PE	1	1	U	Red	0.75sq (crimped)
	Red	U	2	2	V	White	
	White	V	3	3	W	Black	
	Black	W	4	4	PE	Green	

Encoder Cable (for Large Type)

Model **CB-X2-PLA**□□□

* Specify the cable length (L) in □□□. Example 080 = 8 m
 The maximum length is 20 m for the SCON/SSEL and 30 m for the XSEL.

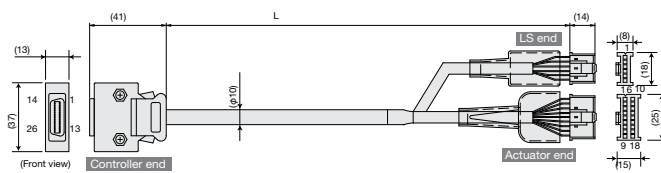

Wire	Color	Signal	No.	No.	Signal	Color	Wire
-	-	-	10	1	E24V	White/blue	AWG26 (soldered)
-	-	-	11	2	OV	White/yellow	
White/orange	E24V	12	3	LS	White/red		
White/green	OV	13	4	CLEEP	White/black		
Brown/blue	LS	26	5	OT	White/purple		
Brown/yellow	CLEEP	25	6	RSV	White/gray		
Brown/red	OT	24	7	-	-		
Brown/black	RSV	23	8	-	-		
-	-	-	9	9	FG	Drain	AWG26 (soldered)
-	-	-	18	10	SD	Orange	
-	-	-	19	11	SD	Green	
White/blue	A+	1	12	BAT+	Purple		
White/yellow	A-	2	13	BAT-	Gray		
White/red	B+	3	14	VCC	Red		
White/black	B-	4	15	GND	Black		
White/purple	Z+	5	16	-	-		
White/gray	Z-	6	17	BK-	Blue		
Orange	SRD+	7	18	BK+	Yellow		
Green	SRD-	8	-	-	-		
Purple	BAT+	14	-	-	-		
Gray	BAT-	15	-	-	-		
Red	VCC	16	-	-	-		
Black	GND	17	-	-	-		
Blue	BKR-	20	-	-	-		
Yellow	BKR+	21	-	-	-		
-	-	-	22	-	-	-	

Connect the shielded cable to the hood via a clamp.
 Drain wire and braided shielded cable
 ("White/blue" in the wire color field indicates the band color/insulator color.)

Encoder Cable (for Shaft Type, Small Type, Flat Type, Medium Type)

Model **CB-X2-PA**□□□

* Specify the cable length (L) in □□□. Example 080 = 8 m
 The maximum length is 20 m for the SCON/SSEL and 30 m for the XSEL.

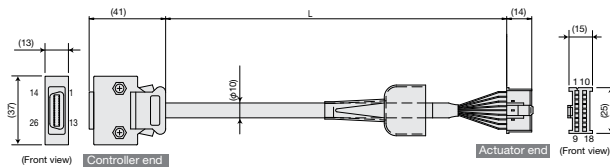

Wire	Color	Signal	No.	No.	Signal	Color	Wire	
-	-	-	10	1	A	White/blue	AWG26 (soldered)	
-	-	-	11	2	A	White/yellow		
-	E24V	12	3	B	White/red			
-	OV	13	4	B	White/black			
-	LS	26	5	Z	White/purple			
-	CLEEP	25	6	Z	White/gray			
-	OT	24	7	-	-			
-	RSV	23	8	-	-			
-	-	-	9	9	FG	Drain		AWG26 (soldered)
-	-	-	18	10	SD	Orange		
-	-	-	19	11	SD	Green		
White/blue	A+	1	12	BAT+	Purple			
White/yellow	A-	2	13	BAT-	Gray			
White/red	B+	3	14	VCC	Red			
White/black	B-	4	15	GND	Black			
White/purple	Z+	5	16	-	-			
White/gray	Z-	6	17	BK-	Blue			
Orange	SRD+	7	18	BK+	Yellow			
Green	SRD-	8	-	-	-			
Purple	BAT+	14	-	-	-			
Gray	BAT-	15	-	-	-			
Red	VCC	16	-	-	-			
Black	GND	17	-	-	-			
Blue	BKR-	20	-	-	-			
Yellow	BKR+	21	-	-	-			
-	-	-	22	-	-	-		

Connect the shielded cable to the hood via a clamp.
 Drain wire and braided shielded cable
 ("White/blue" in the wire color field indicates the band color/insulator color.)

I/O Flat Cable (for SSEL)

Model **CB-DS-PIO** □ □ □

*Specify the cable length (L) in □□□. A desired length up to 10 m can be specified. Example) 080 = 8 m

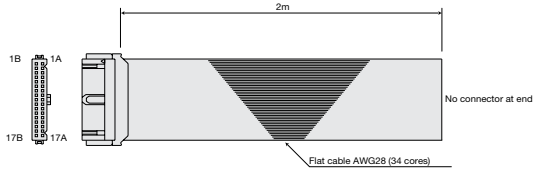

No.	Color	Wire	No.	Color	Wire
1A	Brown 1		9B	Gray 2	
1B	Red 1		10A	White 2	
2A	Orange 1		10B	Black 2	
2B	Yellow 1		11A	Brown -3	
3A	Green 1		11B	Red 3	
3B	Blue 1		12A	Orange 3	
4A	Purple 1		12B	Yellow 3	
4B	Gray 1		13A	Green 3	
5A	White 1		13B	Blue 3	
5B	Black 1		14A	Purple 3	
6A	Brown -2		14B	Gray 3	
6B	Red 2		15A	White 3	
7A	Orange 2		15B	Black 3	
7B	Yellow 2		16A	Brown -4	
8A	Green 2		16B	Red 4	
8B	Blue 2		17A	Orange 4	
9A	Purple 2		17B	Yellow 4	

I/O Flat Cable (for XSEL)

Model **CB-X-PIO** □ □ □

*Specify the cable length (L) in □□□. A desired length up to 10 m can be specified. Example) 080 = 8 m

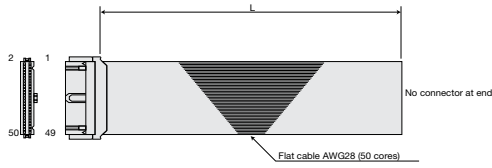

No.	Color	Wire	No.	Color	Wire	No.	Color	Wire
1	Brown 1		18	Gray 2		35	Green 4	
2	Red 1		19	White 2		36	Blue 4	
3	Orange 1		20	Black 2		37	Purple 4	
4	Yellow 1		21	Brown -3		38	Gray 4	
5	Green 1		22	Red 3		39	White 4	
6	Blue 1		23	Orange 3		40	Black 4	
7	Purple 1		24	Yellow 3		41	Brown -5	
8	Gray 1		25	Green 3		42	Red 5	
9	White 1		26	Blue 3		43	Orange 5	
10	Black 1		27	Purple 3		44	Yellow 5	
11	Brown -2		28	Gray 3		45	Green 5	
12	Red 2		29	White 3		46	Blue 5	
13	Orange 2		30	Black 3		47	Purple 5	
14	Yellow 2		31	Brown -4		48	Gray 5	
15	Green 2		32	Red 4		49	White 5	
16	Blue 2		33	Orange 4		50	Black 5	
17	Purple 2		34	Yellow 4				

I/O Flat Cable (for SCON)

Model **CB-PAC-PIO** □ □ □

*Specify the cable length (L) in □□□. A desired length up to 10 m can be specified. Example) 080 = 8 m

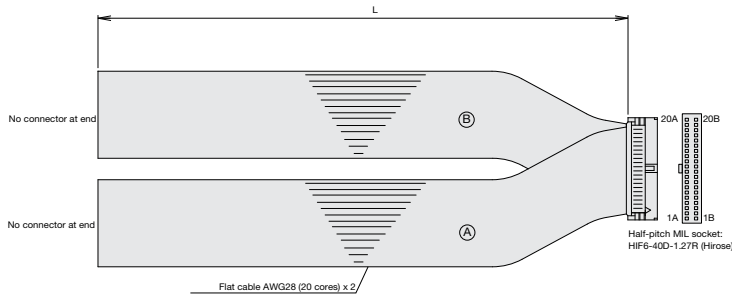

No.	Signal name	Cable color	Wire	No.	Signal name	Cable color	Wire
1A	24V	Brown -1		1B	OUT0	Brown -3	
2A	24V	Red -1		2B	OUT1	Red -3	
3A	-	Orange -1		3B	OUT2	Orange -3	
4A	-	Yellow -1		4B	OUT3	Yellow -3	
5A	IN0	Green -1		5B	OUT4	Green -3	
6A	IN1	Blue -1		6B	OUT5	Blue -3	
7A	IN2	Purple -1		7B	OUT6	Purple -3	
8A	IN3	Gray -1		8B	OUT7	Gray -3	
9A	IN4	White -1		9B	OUT8	White -3	
10A	IN5	Black -1		10B	OUT9	Black -3	
11A	IN6	Brown -2		11B	OUT10	Brown -4	
12A	IN7	Red -2		12B	OUT11	Red -4	
13A	IN8	Orange -2		13B	OUT12	Orange -4	
14A	IN9	Yellow -2		14B	OUT13	Yellow -4	
15A	IN10	Green -2		15B	OUT14	Green -4	
16A	IN11	Blue -2		16B	OUT15	Blue -4	
17A	IN12	Purple -2		17B	-	Purple -4	
18A	IN13	Gray -2		18B	-	Gray -4	
19A	IN14	White -2		19B	0V	White -4	
20A	IN15	Black -2		20B	0V	Black -4	

SCON Pulse-train Control Cable

Model **CB-SC-PIOS** □ □ □

*Specify the cable length (L) in □□□. A desired length up to 10 m can be specified. Example) 080 = 8 m

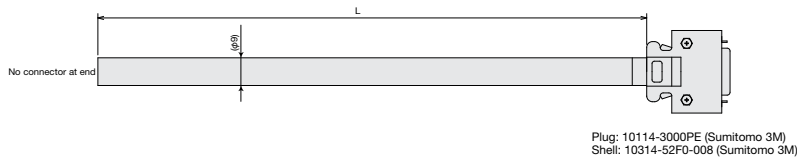

Wire	Color	Signal	No.
Black	Not used		1
White/black	Not used		2
Red	Red	PP	3
White/red	White/red	7PP	4
Green	Green	NP	5
White/green	White/green	7NP	6
Yellow	Yellow	AFB	7
White/yellow	White/yellow	7AFB	8
Brown	Brown	BFB	9
White/brown	White/brown	7BFB	10
Blue	Blue	ZFB	11
White/blue	White/blue	ZFB	12
Gray	Gray	GND	13
White/gray	White/gray	GND	14