

Equipped with 3x lead ball screws **ISB/ISDB**

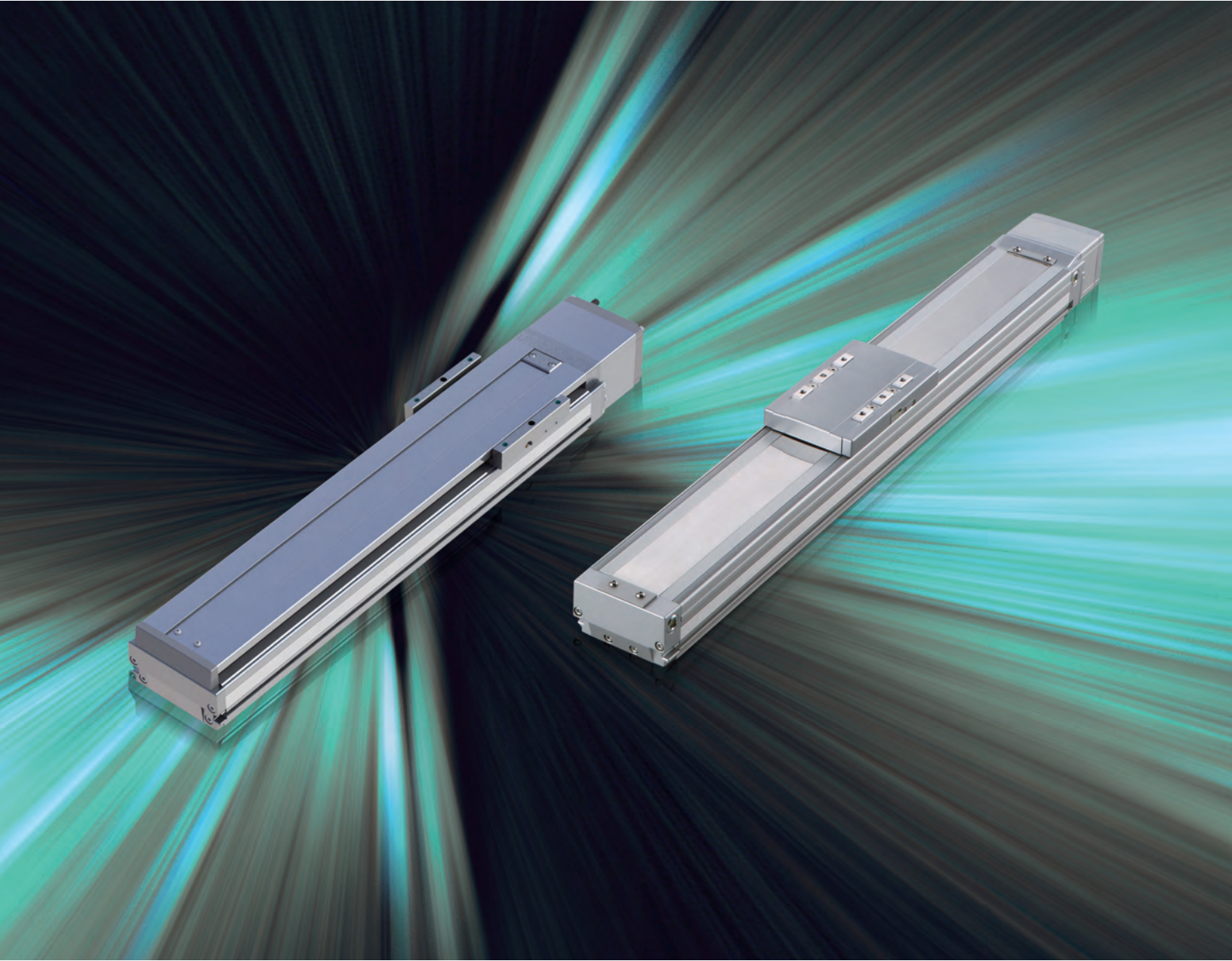

Introducing a high-speed actuator that reduces production costs by reducing cycle time.

Features 1

Max. Speed 2,500mm/s,
Max. Acceleration/Deceleration 3.0G

The lineup of ISB/ISDB actuators now have up to 3 times the screw lead which is "the first in the industry" for rolled ball screws. These are low-cost yet high-speed actuators with rolled ball screws that have three times the lead. The maximum speed is up to 2.3 times higher and acceleration/deceleration up to 1.5 times higher as compared with the conventional product.

	ISB-SXM		ISB-MXM	
	Conventional models	3x lead ball screws	Conventional models	3x lead ball screws
Ball screw lead (mm)	16	36	30	48
Max. speed (mm/s)	960	2,160 (2.3x)	1,800	2,500 (1.4x)
Acceleration/deceleration (G) *	2.0	3.0 (1.5x)	2.0	3.0 (1.5x)
Max. Stroke (mm)	900	1,100 (+200)	1,100	1,300 (+200)

* Values for off-board tuning.

Features 2

Reduced Cycle Time

Positioning time can be greatly shortened by increasing acceleration, deceleration and maximum velocity.

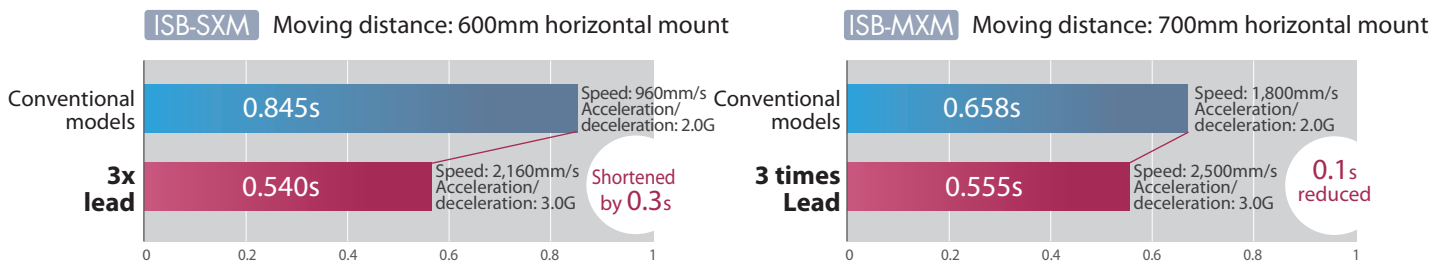

Application Examples

A laser trimming apparatus with thin-film solar cells that combines a high-speed actuator (with 3x lead ball screws). It shortens the cycle time and improves productivity by speeding up trimming.

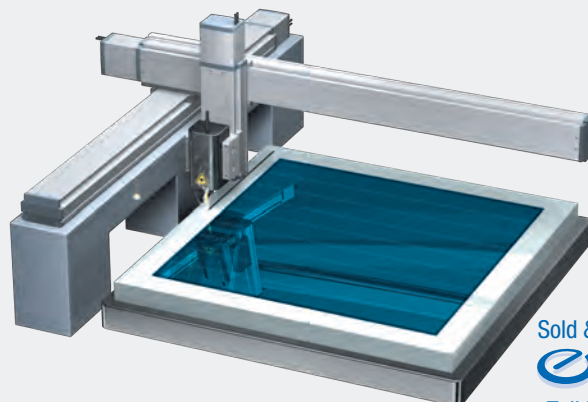

Sold & Serviced By:

ELECTROMATE

Toll Free Phone (877) SERV098

Toll Free Fax (877) SERV099

www.electromate.com

sales@electromate.com

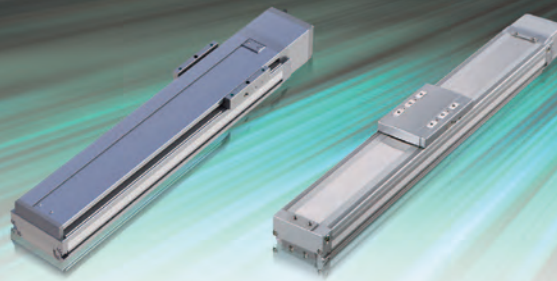

Product Lineup

Series	External View	Body width (mm)	Type		Motor wattage (W)	Ball screw lead (mm)	Stroke (mm)	Max. Speed (mm/s)	Max. Payload (kg)		Ref. page
									Horizontal	Vertical	
ISB	Compact	90	Standard Slider	SXM	100	36	100~1,100 (Every 50mm)	2,160	10	2	P.3
			Long Slider	SXL			130~1,080 (Every 50mm)				P.5
	Medium	120	Standard Slider	MXM	400	48	100~1,300 (Every 50mm)	2,500	20	6	P.7
			Long Slider	MXL			120~1,270 (Every 50mm)				P.9
			Intermediate Support	MXMX			800~2,000 (Every 50mm)	2,200	20	—	P.11
ISDB Simple dust-proof type	Compact	90	Standard Slider	S	100	36	100~800 (Every 50mm)	2,000	10	2	P.13
	Medium	120	Standard Slider	M	400	48	100~1,100 (Every 50mm)				20
			Intermediate Support	MX			800~1,600 (Every 50mm)	20	—	P.17	

* The maximum speed may not be reached if the stroke is short. Longer strokes may cause the maximum speed to decrease due to resonance. Please refer to the reference page of each model for details.

3x lead ball screw model part number breakdown

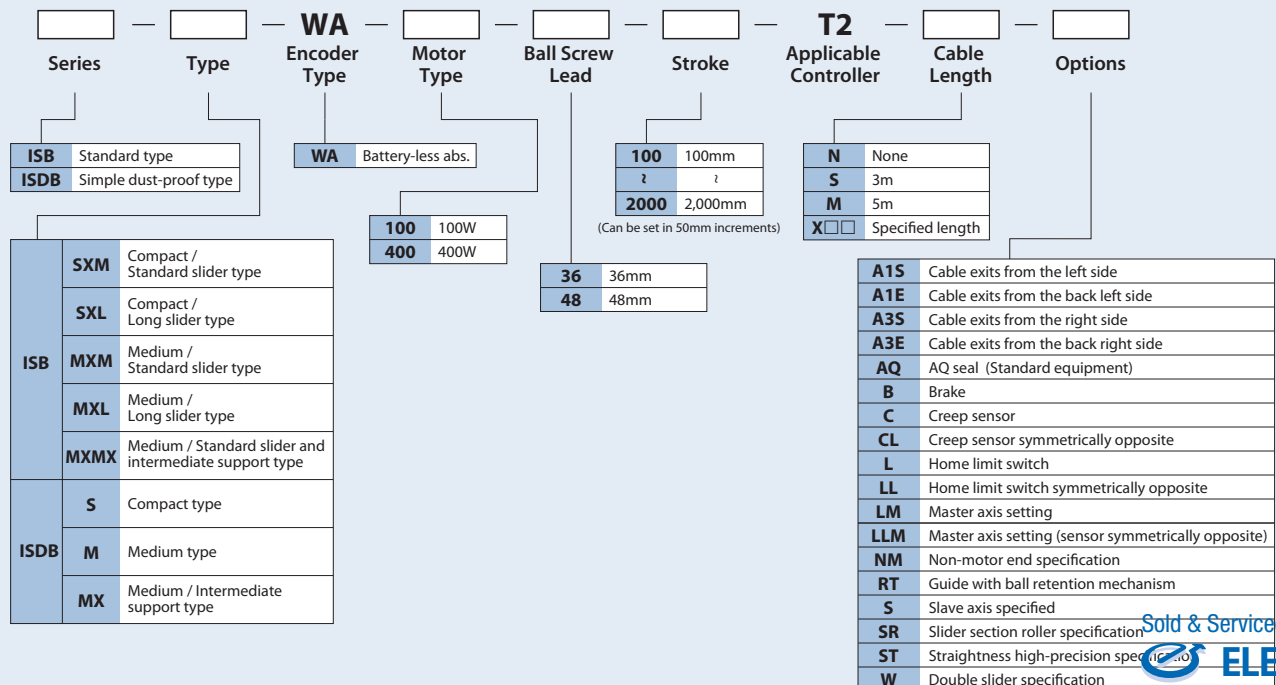

*The type of motor, ball screw lead, stroke, and options vary depending on the actuator type. Please refer to the reference page of each type for details.

Sold & Serviced By:

ELECTROMATE

Toll Free Phone (877) SERVO98

Toll Free Fax (877) SERV099

www.electromate.com

sales@electromate.com

ISB-SXM-100

±10μm Battery-less Absolute Compact X-axis Type Standard Slider Body Width 90mm 100W

Model Specification Items **ISB** — **SXM** — **WA** — **100** — **36** — — **T2** — —
 Series — Type — Encoder Type — Motor Type — Lead — Stroke — Applicable Controllers — Cable Length — Options

WA: Battery-less absolute 100: 100W 36: 36mm 100: 100mm 1100: 1,100mm (50mm increments) T2: SCON, MSCON, SSEL, XSEL-P/Q, XSEL-R/S/RA/SA N: None, S: 3m, M: 3m X□□: Specified Length Please refer to the option table below

* Does not include a controller. * Please contact IAI for more information about the model specification items. * Be sure to specify the AQ seal (AQ) option. Be sure to select a symbol for the cable outlet direction.

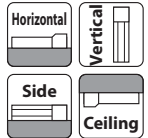

* Depending on the model, there may be some limitations to using the vertical, side, and ceiling mount positions. Please contact IAI for more information regarding mounting positions. Please contact IAI for more details.



POINT Selection Notes
 (Note 1) The value of payload is when operating at an acceleration of 0.4G. When the acceleration is increased, the payload will be reduced. Please refer to P.21 for more information.
 (Note 2) The straightness of straight line motion is the value when the straightness high precision specifications (optional) are specified.

Model/Specifications

Lead and Payload

* When using the guide with ball retention mechanism (RT), the vertical payload will be -0.5kg.

Model	Motor wattage (W)	Lead (mm)	Max. payload (Note 1)		Rated thrust (N)	Stroke (mm)
			Horizontal (kg)	Vertical (kg)		
ISB-SXM-WA-100-36-①-T2-②-③	100	36	10	2	47.2	100~1,100 (Every 50mm)

Legend: ① Stroke ② Cable length ③ Option

Stroke and Max. Speed

Stroke	100	150	200	250	300	350	400
Max. Speed	1,100	1,425	1,700	1,925	2,075	2,125	2,160
Stroke	450	500	550	600	650	700	750
Max. Speed	2,160	2,000	1,740	1,520	1,340		
Stroke	800	850	900	950	1,000	1,050	1,100
Max. Speed	1,190	1,065	960	865	790	721	660

(Unit: mm/s)

① Stroke

① Stroke (mm)	Standard
100	○
150/200	○
250/300	○
350/400	○
450/500	○
550/600	○
650/700	○
750/800	○
850/900	○
950/1,000	○
1,050/1,100	○

② Cable Length

Type	Cable code	Standard	With LS
Standard type	S (3m)		○
	M (5m)		○
Specified length	X06 (6m) ~X10 (10m)	○	○
	X11 (11m) ~X20 (20m)	○	○

* Only the robot cable is available for this model.
 * Please contact IAI for more information regarding the maintenance cables.
 * When using a cable of 21 to 30m, specify "N" for the cable length of the actuator model, and separately purchase the motor cable (CB-X-MA□□□□), encoder cable (CB-X1-PA□□□□-AWG24) or encoder cable with LS (CB-X1-PLA□□□□-AWG24). (Please contact IAI for more details on the cable.)

③ Options

Type	Model	Ref. Page	Type	Model	Ref. Page
Cable exits from the left side	A1S	See P.19	Home limit switch symmetrically opposite	LL	See P.19
Cable exits from the back left side	A1E	See P.19	Master axis specified	LM	See P.19
Cable exits from the right side	A3S	See P.19	Master axis spec. (sensor symmetrically opposite)	LLM	See P.19
Cable exits from the back right side	A3E	See P.19	Non-motor end spec.	NM	See P.19
AQ seal (Standard equipment)	AQ	See P.19	Guide with ball retention mechanism	RT	See P.20
Brake	B	See P.19	Slave axis specified	S	See P.19
Creep sensor	C	See P.19	Straightness high precision spec. (stroke: 100~600)	ST	See P.20
Creep sensor symmetrically opposite	CL	See P.19	Straightness high precision spec. (stroke: 650~1,100)	ST	See P.20
Home limit switch	L	See P.19	Double slider spec.	W	See P.20

Actuator Specifications

Item	Description
Positioning repeatability	±0.01mm
Drive system	Ball screw φ12mm, rolled C10
Lost motion	0.05mm or less
Static allowable moment	Ma: 143.8N·m Mb: 205.4N·m Mc: 336.0N·m
Dynamic allowable moment (*)	Ma: 32.9N·m Mb: 47.0N·m Mc: 76.8N·m
Straightness of straight line motion (Note 2)	0.02mm/m or less
Base	Material: Aluminum with white alumite treatment
Ambient operating temp. & humidity	0~40°C, 85% RH or less (Not Condensed)

Reference for overhang load length: Ma: 450mm or less, Mb: 300mm or less, Mc: 150mm or less.
 (*) Assumes a standard rated life of 10,000km. The service life will vary depending on operation and installation conditions. Please contact IAI for the running life.
 (**) Please refer to P.22 for more information regarding the directions of the load, the motor, and overhang load length when using the double slider.

ELECTROMATE
 Toll Free Phone (877) SERV098
 Toll Free Fax (877) SERV099
 www.electromate.com
 sales@electromate.com

Dimensions

CAD drawings can be downloaded from our website.
www.intelligentactuator.com



- *1 When the slider is returning to its home position, please be careful of interference from surrounding objects, as it will travel until it reaches the M.E.
M.E: Mechanical end
S.E: Stroke end
- *2 If the home direction needs to be changed after purchase, the actuator must be returned to IAI for adjustment.

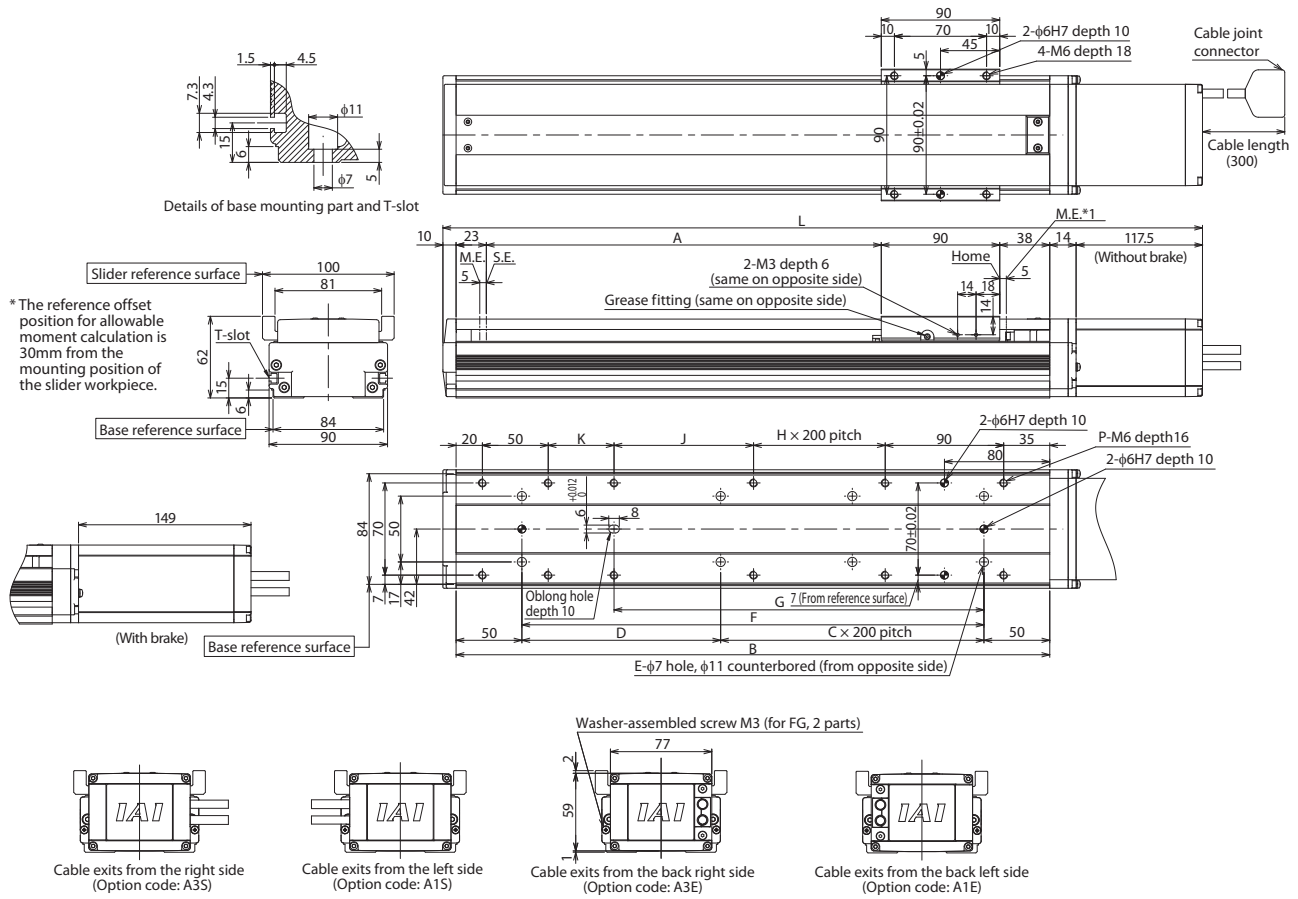

Dimensions and Mass by Stroke

Stroke	Stroke (mm)																					
	100	150	200	250	300	350	400	450	500	550	600	650	700	750	800	850	900	950	1,000	1,050	1,100	
L	w/o brake	392.5	442.5	492.5	542.5	592.5	642.5	692.5	742.5	792.5	842.5	892.5	942.5	992.5	1,042.5	1,092.5	1,142.5	1,192.5	1,242.5	1,292.5	1,342.5	1,392.5
	w/brake	424	474	524	574	624	674	724	774	824	874	924	974	1,024	1,074	1,124	1,174	1,224	1,274	1,324	1,374	1,424
A	100	150	200	250	300	350	400	450	500	550	600	650	700	750	800	850	900	950	1,000	1,050	1,100	
B	251	301	351	401	451	501	551	601	651	701	751	801	851	901	951	1,001	1,051	1,101	1,151	1,201	1,251	
C	0	0	0	1	1	1	1	2	2	2	2	3	3	3	3	4	4	4	4	5	5	
D	151	201	251	101	151	201	251	101	151	201	251	101	151	201	251	101	151	201	251	101	151	
E	4	4	4	6	6	6	6	8	8	8	8	10	10	10	10	12	12	12	12	14	14	
F	151	201	251	301	351	401	451	501	551	601	651	701	751	801	851	901	951	1,001	1,051	1,101	1,151	
G	131	131	181	231	281	331	381	431	481	531	581	631	681	731	781	831	881	931	981	1,031	1,081	
H	0	0	0	0	0	0	1	1	1	1	2	2	2	3	3	3	3	3	4	4	4	
J	56	56	106	156	206	256	106	156	206	256	106	156	206	256	106	156	206	256	106	156	206	
K	0	50	50	50	50	50	50	50	50	50	50	50	50	50	50	50	50	50	50	50	50	
P	8	10	10	10	10	10	12	12	12	12	14	14	14	14	16	16	16	16	18	18	18	
Mass (kg)	w/o brake	3.2	3.6	4.0	4.3	4.7	5.0	5.4	5.7	6.1	6.5	6.8	7.2	7.5	7.9	8.2	8.6	8.9	9.3	9.7	10.0	10.4
	w/brake	3.5	3.9	4.3	4.6	5.0	5.3	5.7	6.0	6.4	6.8	7.1	7.5	7.8	8.2	8.5	8.9	9.2	9.6	10.0	10.3	10.7

Applicable Controllers

The ISB series actuators can be operated by the controllers indicated below. Please select the type depending on your intended use.

Type	External view	Max. number of controlled axes	Power supply voltage	Control method			Network *Option	Maximum number of positioning points	Ref. page
				Positioner	Pulse-train	Program			
SCON-CB/CGB		1	Single-phase 100/200VAC	●	●	-	 	512 points (768 for network spec.)	Please contact IAI for more details
SCON-LC/LCG		1		-	-	●		512 points (768 for network spec.)	
SCON-CAL/CGAL		1		●	-	-		512 points (768 for network spec.)	
MSCON-C		6		This model is network-compatible only.				256	
SSEL-CS		2		●	-	●		20,000	
XSEL-P/Q/R/S/RA/SA		8	Single-phase 200VAC Three-phase 200VAC	-	-	●	55,000 (depending on the type)		

Note:
The type of compatible networks will vary depending on the controller. Please contact IAI for more details.

Sold & Served By:

Toll Free Phone (877) 547V098
Toll Free Fax (877) 547V099
www.electromate.com
sales@electromate.com

ISB-SXL-100

±10μm
Battery-less Absolute
Compact X-axis Type
Long slider
Body Width 90mm
100W

Model Specification Items
ISB — **SXL** — **WA** — **100** — **36** — — **T2** — —
 Series — Type — Encoder Type — Motor Type — Lead — Stroke — Applicable Controllers — Cable Length — Options
WA: Battery-less absolute 100: 100W 36: 36mm 130: 130mm 1080: 1,080mm (50mm increments) T2: SCON, MSCON, SSEL, XSEL-P/Q, XSEL-R/S/RA/SA N: None, S: 3m, M: 5m Please refer to the option table below

* Does not include a controller.
 * Please contact IAI for more information about the model specification items.
 * Be sure to specify the AQ seal (AQ) option. Be sure to select a symbol for the cable outlet direction.

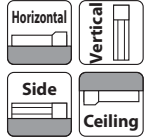

* Depending on the model, there may be some limitations to using the vertical, side, and ceiling mount positions. Please contact IAI for more information regarding mounting positions. Please contact IAI for more details.



POINT Selection Notes

(Note 1) The value of payload is when operating at an acceleration of 0.4G. When the acceleration is increased, the payload will be reduced. Please refer to P.21 for more information.

(Note 2) The straightness of straight line motion is the value when the straightness high precision specifications (optional) are specified.

Model/Specifications

Lead and Payload

Model	Motor wattage (W)	Lead (mm)	Max. payload (Note 1)		Rated thrust (N)	Stroke (mm)
			Horizontal (kg)	Vertical (kg)		
ISB-SXL-WA-100-36-①-T2-②-③	100	36	10	2	47.2	130~1,080 (Every 50mm)

Legend: ① Stroke ② Cable length ③ Option

Stroke and Max. Speed

Stroke	130	180	230	280	330	380	430
Max. Speed	1,425	1,700	1,925	2,075	2,125	2,160	

Stroke	480	530	580	630	680	730	780
Max. Speed	2,160	2,000	1,740	1,520	1,340	1,190	

Stroke	830	880	930	980	1,030	1,080
Max. Speed	1,065	960	865	790	721	660

(Unit: mm/s)

① Stroke

① Stroke (mm)	Standard
130/180	○
230/280	○
330/380	○
430/480	○
530/580	○
630/680	○
730/780	○
830/880	○
930/980	○
1,030/1,080	○

② Cable Length

Type	Cable code	Standard	With LS
Standard type	S (3m)		○
	M (5m)		○
Specified length	X06 (6m) ~X10 (10m)	○	○
	X11 (11m) ~X20 (20m)	○	○

* Only the robot cable is available for this model.
 * Please contact IAI for more information regarding the maintenance cables.
 * When using a cable of 21 to 30m, specify "N" for the cable length of the actuator model, and separately purchase the motor cable (CB-X-MA□□□□), encoder cable (CB-X1-PA□□□□-AWG24) or encoder cable with LS (CB-X1-PLA□□□□-AWG24). (Please contact IAI for more details on the cable.)

③ Options

Type	Model	Ref. Page	Type	Model	Ref. Page
Cable exits from the left side	A1S	See P.19	Home limit switch symmetrically opposite	LL	See P.19
Cable exits from the back left side	A1E	See P.19	Master axis specified	LM	See P.19
Cable exits from the right side	A3S	See P.19	Master axis spec. (sensor symmetrically opposite)	LLM	See P.19
Cable exits from the back right side	A3E	See P.19	Non-motor end spec.	NM	See P.19
AQ seal (Standard equipment)	AQ	See P.19	Slave axis specified	S	See P.19
Brake	B	See P.19	Straightness high precision spec. (stroke: 130~580)	ST	See P.20
Creep sensor	C	See P.19	Straightness high precision spec. (stroke: 630~1,080)	ST	See P.20
Creep sensor symmetrically opposite	CL	See P.19	Double slider spec.	W	See P.20
Home limit switch	L	See P.19			

Actuator Specifications

Item	Description
Positioning repeatability	±0.01mm
Drive system	Ball screw φ12mm, rolled C10
Lost motion	0.05mm or less
Static allowable moment	Ma: 216.0N-m Mb: 308.5N-m Mc: 415.1N-m
Dynamic allowable moment (*)	Ma: 46.3N-m Mb: 66.2N-m Mc: 89.0N-m
Straightness of straight line motion (Note 2)	0.02mm/m or less
Base	Material: Aluminum with white alumite treatment
Ambient operating temp. & humidity	0~40°C, 85% RH or less (Not Condensed)

Reference for overhang load length: Ma: 550mm or less, Mb: 300mm or less, Mc: 200mm or less
 (*) Assumes a standard rated life of 10,000km. The service life will vary depending on operation and installation conditions. Please contact IAI for the running life.
 (*) Please refer to P.22 for more information regarding the directions of motion, load moment and overhang load length when using the double slider.

Dimensions

CAD drawings can be downloaded from our website.
www.intelligentactuator.com



- *1 When the slider is returning to its home position, please be careful of interference from surrounding objects, as it will travel until it reaches the M.E.
M.E: Mechanical end
S.E: Stroke end
- *2 If the home direction needs to be changed after purchase, the actuator must be returned to IAI for adjustment.

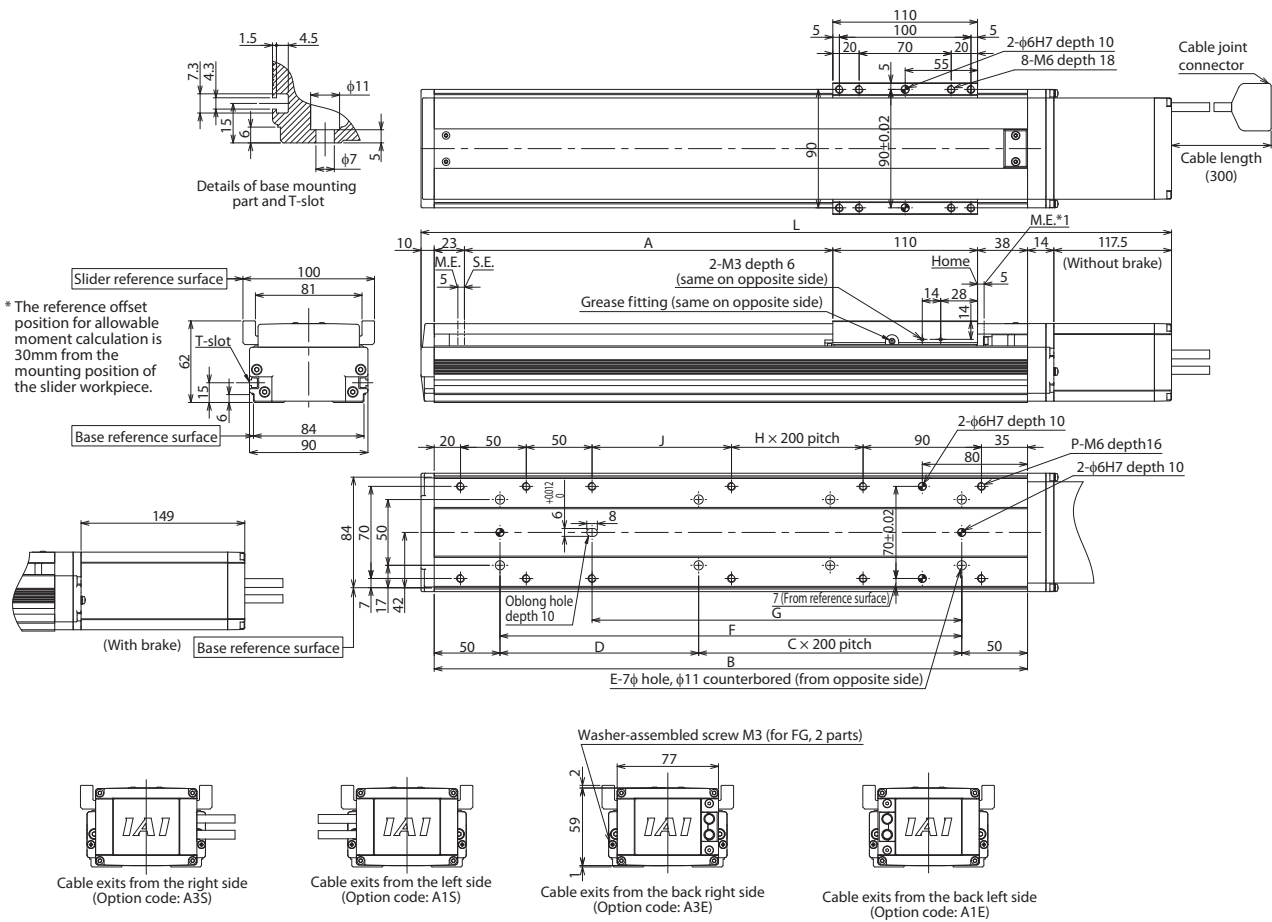

■ Dimensions and Mass by Stroke

Stroke	L	130	180	230	280	330	380	430	480	530	580	630	680	730	780	830	880	930	980	1,030	1,080
		w/o brake	442.5	492.5	542.5	592.5	642.5	692.5	742.5	792.5	842.5	892.5	942.5	992.5	1,042.5	1,092.5	1,142.5	1,192.5	1,242.5	1,292.5	1,342.5
w/brake		474	524	574	624	674	724	774	824	874	924	974	1,024	1,074	1,124	1,174	1,224	1,274	1,324	1,374	1,424
A		130	180	230	280	330	380	430	480	530	580	630	680	730	780	830	880	930	980	1,030	1,080
B		301	351	401	451	501	551	601	651	701	751	801	851	901	951	1,001	1,051	1,101	1,151	1,201	1,251
C		0	0	1	1	1	1	2	2	2	2	3	3	3	3	4	4	4	4	5	5
D		201	251	101	151	201	251	101	151	201	251	101	151	201	251	101	151	201	251	101	151
E		4	4	6	6	6	6	8	8	8	8	10	10	10	10	12	12	12	12	14	14
F		201	251	301	351	401	451	501	551	601	651	701	751	801	851	901	951	1,001	1,051	1,101	1,151
G		131	181	231	281	331	381	431	481	531	581	631	681	731	781	831	881	931	981	1,031	1,081
H		0	0	0	0	0	1	1	1	1	2	2	2	2	3	3	3	3	4	4	4
J		56	106	156	206	256	306	356	406	456	506	556	606	656	706	756	806	856	906	956	1,006
P		10	10	10	10	10	12	12	12	12	14	14	14	14	16	16	16	16	18	18	18
Mass (kg)	w/o brake	3.7	4.1	4.4	4.8	5.1	5.5	5.8	6.2	6.6	6.9	7.3	7.6	8.0	8.3	8.7	9.0	9.4	9.8	10.1	10.5
	w/brake	4.0	4.4	4.7	5.1	5.4	5.8	6.1	6.5	6.9	7.2	7.6	7.9	8.3	8.6	9.0	9.3	9.7	10.1	10.4	10.8

Applicable Controllers

The ISB series actuators can be operated by the controllers indicated below. Please select the type depending on your intended use.

Type	External view	Max. number of controlled axes	Power supply voltage	Control method			Network *Option	Maximum number of positioning points	Ref. page
				Positioner	Pulse-train	Program			
SCON-CB/CGB		1	Single-phase 100/200VAC	●	●	-	 	512 points (768 for network spec.)	Please contact IAI for more details
SCON-LC/LCG		1		-	-	●		512 points (768 for network spec.)	
SCON-CAL/CGAL		1		●	-	-		512 points (768 for network spec.)	
MSCON-C		6		This model is network-compatible only.				256	
SSEL-CS		2		●	-	●		20,000	
XSEL-P/Q/R/S/RA/SA		8	Single-phase 200VAC Three-phase 200VAC	-	-	●	55,000 (depending on the type)		

Note:
The type of compatible networks will vary depending on the controller.
Please contact IAI for more details.

Sold & Served By:

Toll Free Phone (877) 8-FRV098
Toll Free Fax (877) 8-FRV099
www.electromate.com
sales@electromate.com

ISB-MXM-400

±10μm Battery-less Absolute Medium X-axis Type Standard Slider Body Width 120mm 400W

Model Specification Items	ISB	MXM	WA	400	48		T2		
	Series	Type	Encoder Type	Motor Type	Lead	Stroke	Applicable Controllers	Cable Length	Options
			WA: Battery-less absolute	400 : 400W	48 : 48mm	100 : 100mm 1300 : 1,300mm (50mm increments)	T2 : SCON SSEL XSEL-P/Q XSEL-R/S/RA/SA	N : None S : 3m M : 5m X□□ : Specified Length	Please refer to the option table below

* Does not include a controller.
* Please contact IAI for more information about the model specification items.
* Be sure to specify the AQ seal (AQ) option. Be sure to select a symbol for the cable outlet direction.

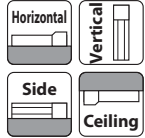

* Depending on the model, there may be some limitations to using the vertical, side, and ceiling mount positions. Please contact IAI for more information regarding mounting positions. Please contact IAI for more details.

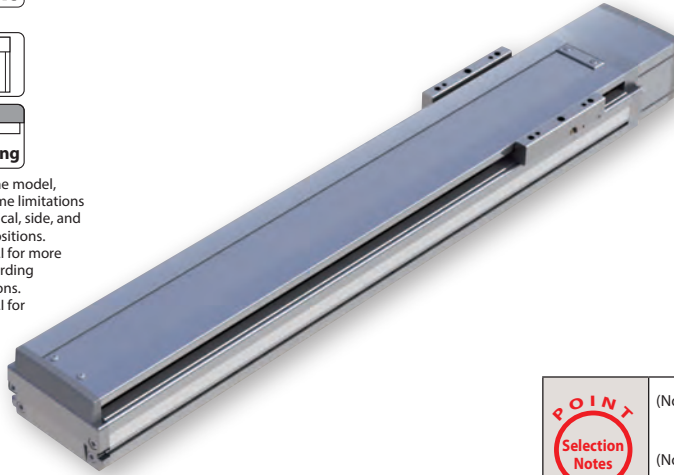

POINT Selection Notes

(Note 1) The value of payload is when operating at an acceleration of 0.4G. When the acceleration is increased, the payload will be reduced. Please refer to P.21 for more information.

(Note 2) The straightness of straight line motion is the value when the straightness high precision specifications (optional) are specified.

Model/Specifications

Lead and Payload

Model	Motor wattage (W)	Lead (mm)	Max. payload (Note 1)		Rated thrust (N)	Stroke (mm)
			Horizontal (kg)	Vertical (kg)		
ISB-MXM-WA-400-48-①-T2-②-③	400	48	20	6	141.3	100~1,300 (Every 50mm)

Legend: ① Stroke ② Cable length ③ Option

Stroke and Max. Speed

Stroke	100	150	200	250	300	350	400
Max. Speed	1,025	1,325	1,575	1,825	2,025	2,200	2,350
Stroke	450	500	550	600	650	700	750
Max. Speed	2,400			2,500			2,270
Stroke	800	850	900	950	1,000	1,050	1,100
Max. Speed	2,030	1,825	1,645	1,495	1,365	1,250	1,150
Stroke	1,150	1,200	1,250	1,300			
Max. Speed	1,060	980	910	845			

(Unit: mm/s)

① Stroke

① Stroke (mm)	Standard
100	○
150/200	○
250/300	○
350/400	○
450/500	○
550/600	○
650/700	○
750/800	○
850/900	○
950/1,000	○
1,050/1,100	○
1,150/1,200	○
1,250/1,300	○

② Cable Length

Type	Cable code	Standard	With LS
Standard type	S (3m)		○
	M (5m)		○
Specified length	X06 (6m) ~X10 (10m)	○	○
	X11 (11m) ~X20 (20m)	○	○

* Only the robot cable is available for this model.

* Please contact IAI for more information regarding the maintenance cables.

* When using a cable of 21 to 30m, specify "N" for the cable length of the actuator model, and separately purchase the motor cable (CB-X-MA□□□□), encoder cable (CB-X1-PA □□□□-AWG24) or encoder cable with LS (CB-X1-PLA □□□□-AWG24). (Please contact IAI for more details on the cable.)

③ Options

Type	Model	Ref. Page	Type	Model	Ref. Page
Cable exits from the left side	A1S	See P.19	Home limit switch symmetrically opposite	LL	See P.19
Cable exits from the back left side	A1E	See P.19	Master axis specified	LM	See P.19
Cable exits from the right side	A3S	See P.19	Master axis spec. (sensor symmetrically opposite)	LLM	See P.19
Cable exits from the back right side	A3E	See P.19	Non-motor end spec.	NM	See P.19
AQ seal (Standard equipment)	AQ	See P.19	Guide with ball retention mechanism	RT	See P.20
Brake	B	See P.19	Slave axis specified	S	See P.19
Creep sensor	C	See P.19	Straightness high precision spec. (stroke: 100~600)	ST	See P.20
Creep sensor symmetrically opposite	CL	See P.19	Straightness high precision spec. (stroke: 650~1,300)	ST	See P.20
Home limit switch	L	See P.19	Double slider spec.	W	See P.20

Actuator Specifications

Item	Description
Positioning repeatability	±0.01mm
Drive system	Ball screw φ16mm, rolled C10
Lost motion	0.05mm or less
Static allowable moment	Ma: 341.5N·m Mb: 487.0N·m Mc: 796.5N·m
Dynamic allowable moment (*)	Ma: 81.0N·m Mb: 116N·m Mc: 189N·m
Straightness of straight line motion (Note 2)	0.02mm/m or less
Base	Material: Aluminum with white alumite treatment.
Ambient operating temp. & humidity	0~40°C, 85% RH or less (Non-condensing)

* Reference for overhang load length: Ma: 600mm or less, Mb: 600mm or less, Mc: 600mm or less.
(*) Assumes a standard rated life of 10,000km. The service life will vary depending on operation and installation conditions. Please contact IAI for the running life.
(*) Please refer to P.22 for more information regarding the directions of the allowable moment and overhang load length when using the double slider.

ELECTROMATE

 Toll Free Phone (877) SERV098

 Toll Free Fax (877) SERV099

www.electromate.com

sales@electromate.com

Dimensions

CAD drawings can be downloaded from our website.
www.intelligentactuator.com



- *1 When the slider is returning to its home position, please be careful of interference from surrounding objects, as it will travel until it reaches the M.E.
M.E: Mechanical end
S.E: Stroke end
- *2 If the home direction needs to be changed after purchase, the actuator must be returned to IAI for adjustment.

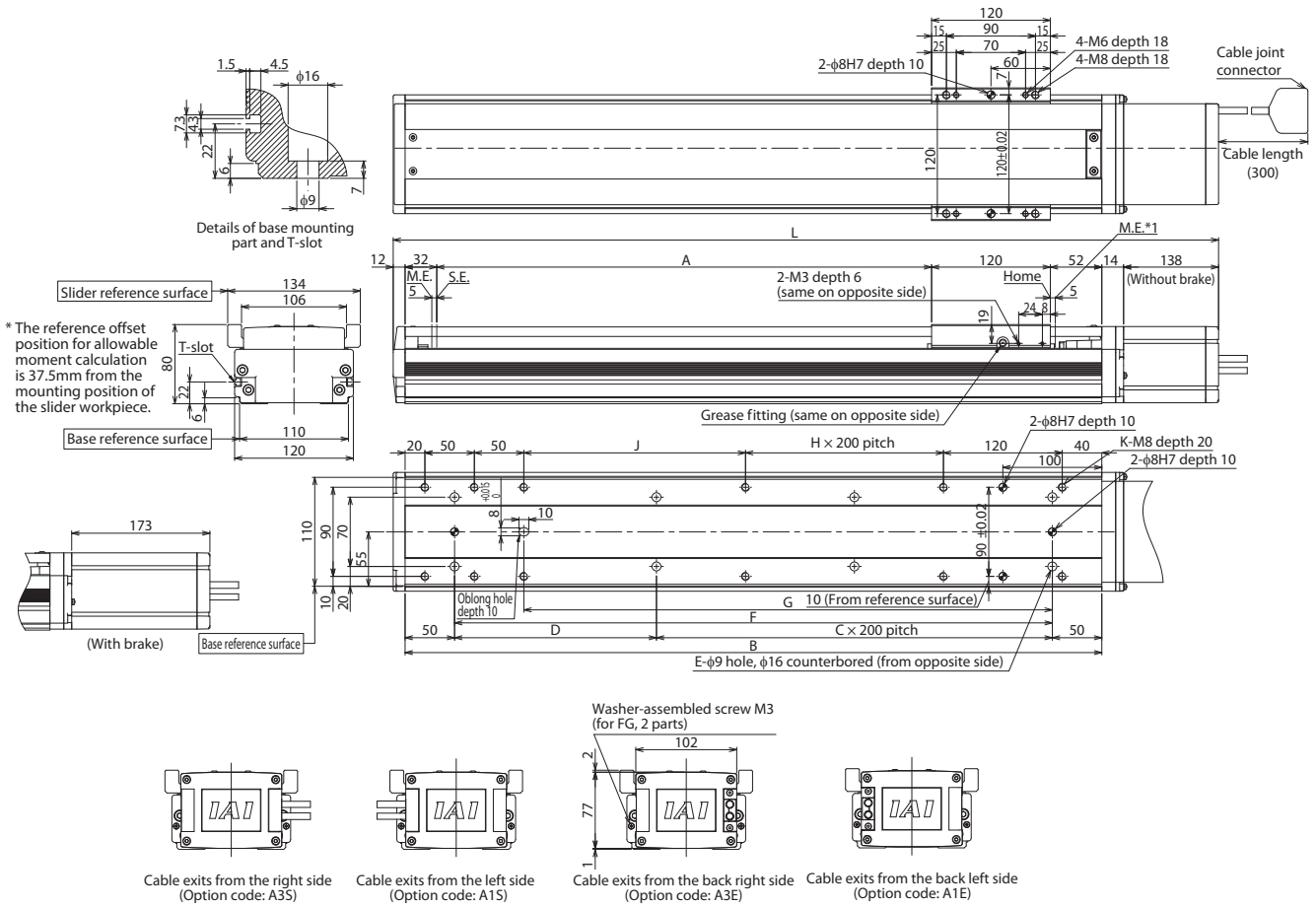

Dimensions and Mass by Stroke

Stroke	100	150	200	250	300	350	400	450	500	550	600	650	700	750	800	850	900	950	1,000	1,050	1,100	1,150	1,200	1,250	1,300
L	468	518	568	618	668	718	768	818	868	918	968	1,018	1,068	1,118	1,168	1,218	1,268	1,318	1,368	1,418	1,468	1,518	1,568	1,618	1,668
w/o brake	503	553	603	653	703	753	803	853	903	953	1,003	1,053	1,103	1,153	1,203	1,253	1,303	1,353	1,403	1,453	1,503	1,553	1,603	1,653	1,703
w/brake	304	354	404	454	504	554	604	654	704	754	804	854	904	954	1,004	1,054	1,104	1,154	1,204	1,254	1,304	1,354	1,404	1,454	1,504
A	100	150	200	250	300	350	400	450	500	550	600	650	700	750	800	850	900	950	1,000	1,050	1,100	1,150	1,200	1,250	1,300
B	304	354	404	454	504	554	604	654	704	754	804	854	904	954	1,004	1,054	1,104	1,154	1,204	1,254	1,304	1,354	1,404	1,454	1,504
C	0	0	1	1	1	1	2	2	2	2	3	3	3	3	4	4	4	4	5	5	5	5	6	6	6
D	204	254	304	354	404	454	504	554	604	654	704	754	804	854	904	954	1,004	1,054	1,104	1,154	1,204	1,254	1,304	1,354	1,404
E	4	4	6	6	6	6	8	8	8	8	10	10	10	10	12	12	12	12	14	14	14	14	16	16	16
F	204	254	304	354	404	454	504	554	604	654	704	754	804	854	904	954	1,004	1,054	1,104	1,154	1,204	1,254	1,304	1,354	1,404
G	134	184	234	284	334	384	434	484	534	584	634	684	734	784	834	884	934	984	1,034	1,084	1,134	1,184	1,234	1,284	1,334
H	0	0	0	0	0	0	1	1	1	1	2	2	2	2	3	3	3	3	4	4	4	4	5	5	5
J	24	74	124	174	224	274	324	374	424	474	524	574	624	674	724	774	824	874	924	974	1,024	1,074	1,124	1,174	1,224
K	10	10	10	10	10	10	12	12	12	12	14	14	14	14	16	16	16	16	18	18	18	18	20	20	20
Mass (kg)	7.0	7.6	8.3	8.9	9.5	10.2	10.8	11.4	12.1	12.7	13.3	14.0	14.6	15.2	15.9	16.5	17.2	17.8	18.4	19.1	19.7	20.3	21.0	21.6	22.2
w/o brake	7.6	8.2	8.9	9.5	10.1	10.8	11.4	12.0	12.7	13.3	13.9	14.6	15.2	15.8	16.5	17.1	17.7	18.4	19.0	19.6	20.3	20.9	21.6	22.2	22.8
w/brake																									

Applicable Controllers

The ISB series actuators can be operated by the controllers indicated below. Please select the type depending on your intended use.

Type	External view	Max. number of controlled axes	Power supply voltage	Control method			Network *Option	Maximum number of positioning points	Ref. page
				Positioner	Pulse-train	Program			
SCON-CB/CGB		1	Single-phase 200VAC	●	●	-	DeviceNet CC-Link CANopen CompoNet MED-ETHERCAT EtherCAT EtherNet/IP	512 points (768 for network spec.)	Please contact IAI for more details
SCON-LC/LCG		1		-	-	●		512 points (768 for network spec.)	
SSEL-CS		2	Single-phase 100/200VAC	●	-	●		20,000	
XSEL-P/Q/R/S/RA/SA		8	Single-phase 200VAC Three-phase 200VAC	-	-	●		55,000 (depending on the type)	

Note: The type of compatible networks will vary depending on the controller. Please contact IAI for more details.

Sold & Serviced By:

Toll Free Phone (877) 541-0998
Toll Free Fax (877) 541-0999
www.electromate.com
sales@electromate.com

ISB-MXL-400

±10μm Standard
Battery-less Absolute
Medium X-axis Type
Long slider
Body Width 120mm
400W

Model Specification Items
ISB — **MXL** — **WA** — **400** — **48** — — **T2** — —
 Series — Type — Encoder Type — Motor Type — Lead — Stroke — Applicable Controllers — Cable Length — Options
 WA: Battery-less absolute 400 : 400W 48 : 48mm 120 : 120mm T2 : SCON, SSEL, XSEL-P/Q, XSEL-R/S/RA/SA N : None, S : 3m, M : 5m Please refer to the option table below

* Does not include a controller.
 * Please contact IAI for more information about the model specification items.

* Be sure to specify the AQ seal (AQ) option. Be sure to select a symbol for the cable outlet direction.

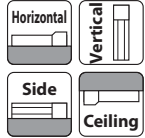

* Depending on the model, there may be some limitations to using the vertical, side, and ceiling mount positions. Please contact IAI for more information regarding mounting positions. Please contact IAI for more details.



POINT Selection Notes

(Note 1) The value of payload is when operating at an acceleration of 0.4G. When the acceleration is increased, the payload will be reduced. Please refer to P.21 for more information.

(Note 2) The straightness of straight line motion is the value when the straightness high precision specifications (optional) are specified.

Model/Specifications

Lead and Payload

Model	Motor wattage (W)	Lead (mm)	Max. payload (Note 1)		Rated thrust (N)	Stroke (mm)
			Horizontal (kg)	Vertical (kg)		
ISB-MXL-WA-400-48-①-T2-②③	400	48	20	6	141.3	120~1,270 (Every 50mm)

Legend: ① Stroke ② Cable length ③ Option

Stroke and Max. Speed

Stroke	120	170	220	270	320	370	420
Max. Speed	1,325	1,575	1,825	2,025	2,200	2,350	2,400
Stroke	470	520	570	620	670	720	770
Max. Speed	2,500				2,270, 2,030		
Stroke	820	870	920	970	1,020	1,070	1,120
Max. Speed	1,825	1,645	1,495	1,365	1,250	1,150	1,060
Stroke	1,170	1,220	1,270				
Max. Speed	980	910	845				

(Unit: mm/s)

① Stroke

① Stroke (mm)	Standard
120/170	<input type="radio"/>
220/270	<input type="radio"/>
320/370	<input type="radio"/>
420/470	<input type="radio"/>
520/570	<input type="radio"/>
620/670	<input type="radio"/>
720/770	<input type="radio"/>
820/870	<input type="radio"/>
920/970	<input type="radio"/>
1,020/1,070	<input type="radio"/>
1,120/1,170	<input type="radio"/>
1,220/1,270	<input type="radio"/>

② Cable Length

Type	Cable code	Standard	With LS
Standard type	S (3m)	<input type="radio"/>	<input type="radio"/>
	M (5m)	<input type="radio"/>	<input type="radio"/>
Specified length	X06 (6m) ~X10 (10m)	<input type="radio"/>	<input type="radio"/>
	X11 (11m) ~X20 (20m)	<input type="radio"/>	<input type="radio"/>

* Only the robot cable is available for this model.
 * Please contact IAI for more information regarding the maintenance cables.
 * When using a cable of 21 to 30m, specify "N" for the cable length of the actuator model, and separately purchase the motor cable (CB-X-MA□□□□), encoder cable (CB-X1-PA□□□□-AWG24) or encoder cable with LS (CB-X1-PLA□□□□-AWG24). (Please contact IAI for more details on the cable.)

③ Options

Type	Model	Ref. Page	Type	Model	Ref. Page
Cable exits from the left side	A1S	See P.19	Home limit switch symmetrical opposite	LL	See P.19
Cable exits from the back left side	A1E	See P.19	Master axis specified	LM	See P.19
Cable exits from the right side	A3S	See P.19	Master axis spec. (sensor symmetrical opposite)	LLM	See P.19
Cable exits from the back right side	A3E	See P.19	Non-motor end spec.	NM	See P.19
AQ seal (Standard equipment)	AQ	See P.19	Slave axis specified	S	See P.19
Brake	B	See P.19	Straightness high precision spec. (stroke: 120~570)	ST	See P.20
Creep sensor	C	See P.19	Straightness high precision spec. (stroke: 620~1,270)	ST	See P.20
Creep sensor symmetrical opposite	CL	See P.19	Double slider spec.	W	See P.20
Home limit switch	L	See P.19			

Actuator Specifications

Item	Description
Positioning repeatability	±0.01mm
Drive system	Ball screw φ16mm, rolled C10
Lost motion	0.05mm or less
Static allowable moment	Ma: 560.3N·m Mb: 800.2N·m Mc: 1030.8N·m
Dynamic allowable moment (*)	Ma: 123N·m Mb: 176N·m Mc: 227N·m
Straightness of straight line motion (Note 2)	0.02mm/m or less
Base	Material: Aluminum with white alumite treatment
Ambient operating temp. & humidity	0~40°C, 85% RH or less (Non-condensing)

* Reference for overhang load length: Ma: 750mm or less, Mb: 700mm or less, Mc: 700mm or less.
 (*) Assumes a standard rated life of 10,000km. The service life will vary depending on operation and installation conditions. Please contact IAI for the running life.
 (**) Please refer to P.22 for more information regarding the directions of the cable movement and overhang load length when using the double slider.

Dimensions

CAD drawings can be downloaded from our website.
www.intelligentactuator.com



- *1 When the slider is returning to its home position, please be careful of interference from surrounding objects, as it will travel until it reaches the M.E.
M.E: Mechanical end
S.E: Stroke end
- *2 If the home direction needs to be changed after purchase, the actuator must be returned to IAI for adjustment.

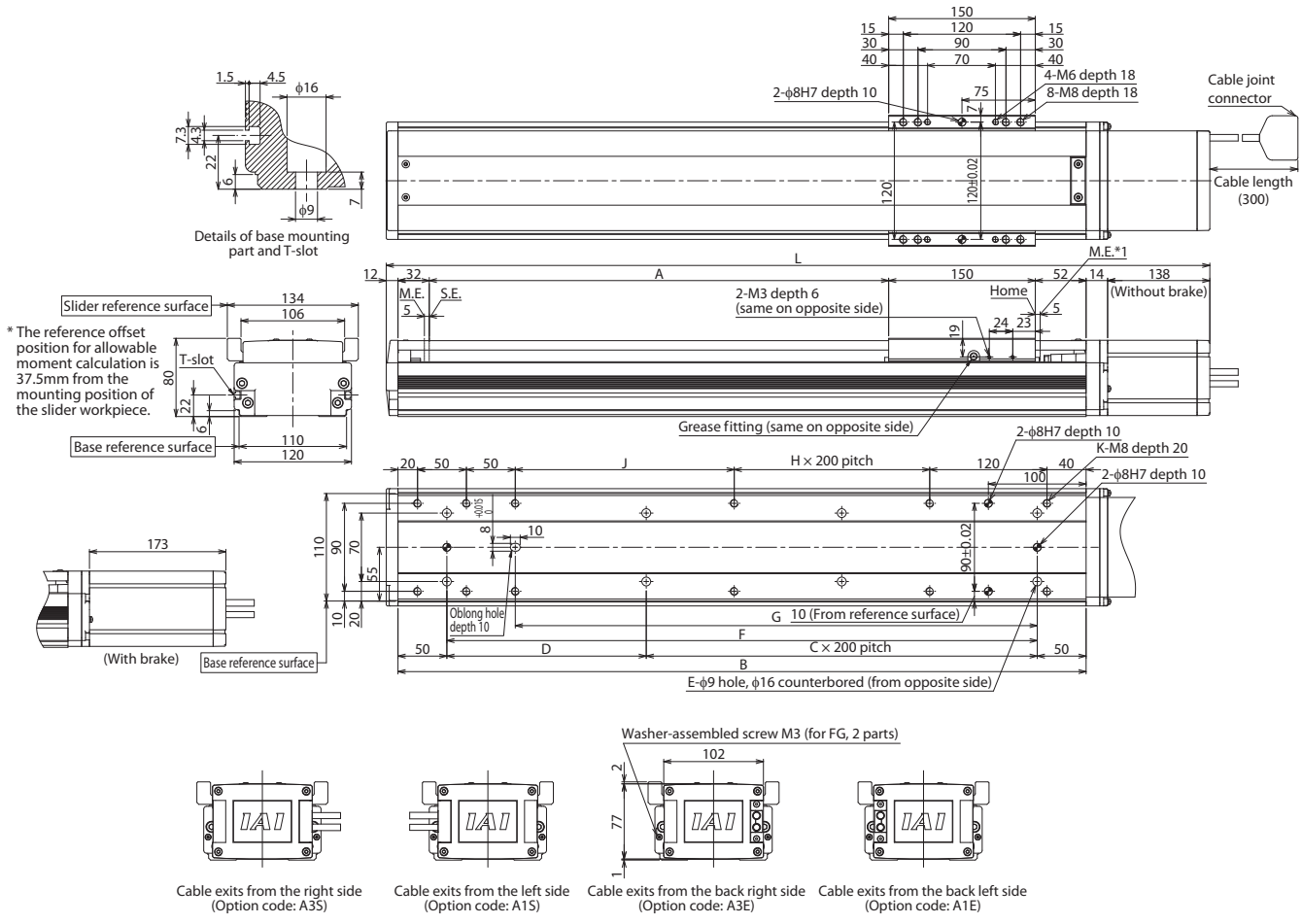

Dimensions and Mass by Stroke

Stroke	120	170	220	270	320	370	420	470	520	570	620	670	720	770	820	870	920	970	1,020	1,070	1,120	1,170	1,220	1,270
L	518	568	618	668	718	768	818	868	918	968	1,018	1,068	1,118	1,168	1,218	1,268	1,318	1,368	1,418	1,468	1,518	1,568	1,618	1,668
w/o brake	553	603	653	703	753	803	853	903	953	1,003	1,053	1,103	1,153	1,203	1,253	1,303	1,353	1,403	1,453	1,503	1,553	1,603	1,653	1,703
w/brake	120	170	220	270	320	370	420	470	520	570	620	670	720	770	820	870	920	970	1,020	1,070	1,120	1,170	1,220	1,270
A	354	404	454	504	554	604	654	704	754	804	854	904	954	1,004	1,054	1,104	1,154	1,204	1,254	1,304	1,354	1,404	1,454	1,504
B	0	1	1	1	1	2	2	2	2	3	3	3	3	4	4	4	4	5	5	5	5	6	6	6
C	254	104	154	204	254	104	154	204	254	104	154	204	254	104	154	204	254	104	154	204	254	104	154	204
D	4	6	6	6	6	8	8	8	8	10	10	10	10	12	12	12	12	14	14	14	14	16	16	16
E	254	304	354	404	454	504	554	604	654	704	754	804	854	904	954	1,004	1,054	1,104	1,154	1,204	1,254	1,304	1,354	1,404
F	184	234	284	334	384	434	484	534	584	634	684	734	784	834	884	934	984	1,034	1,084	1,134	1,184	1,234	1,284	1,334
G	0	0	0	0	0	1	1	1	1	2	2	2	2	3	3	3	3	4	4	4	4	5	5	5
H	74	124	174	224	274	124	174	224	274	124	174	224	274	124	174	224	274	124	174	224	274	124	174	224
J	10	10	10	10	10	12	12	12	12	14	14	14	14	16	16	16	16	18	18	18	18	20	20	20
K	7.9	8.6	9.2	9.8	10.5	11.1	11.7	12.4	13.0	13.6	14.3	14.9	15.5	16.2	16.8	17.5	18.1	18.7	19.4	20.0	20.6	21.3	21.9	22.5
Mass (kg)	8.5	9.2	9.8	10.4	11.1	11.7	12.3	13.0	13.6	14.2	14.9	15.5	16.1	16.8	17.4	18.0	18.7	19.3	19.9	20.6	21.2	21.9	22.5	23.1
w/o brake																								
w/brake																								

Applicable Controllers

The ISB series actuators can be operated by the controllers indicated below. Please select the type depending on your intended use.

Type	External view	Max. number of controlled axes	Power supply voltage	Control method			Network *Option	Maximum number of positioning points	Ref. page
				Positioner	Pulse-train	Program			
SCON-CB/CGB		1	Single-phase 200VAC	●	●	-	DeviceNet CC-Link CompoNet EtherCAT EtherNet/IP	512 points (768 for network spec.)	Please contact IAI for more details
SCON-LC/LCG		1		-	-	●		512 points (768 for network spec.)	
SSEL-CS		2	Single-phase 100/200VAC	●	-	●		20,000	
XSEL-P/Q/R/S/RA/SA		8	Single-phase 200VAC Three-phase 200VAC	-	-	●		55,000 (depending on the type)	

Note: The type of compatible networks will vary depending on the controller. Please contact IAI for more details.

Sold & Served By:

Toll Free Phone (877) SERVO98
Toll Free Fax (877) SERVO99
www.electromate.com
sales@electromate.com

Dimensions

CAD drawings can be downloaded from our website.
www.intelligentactuator.com



- *1 When the slider is returning to its home position, please be careful of interference from surrounding objects, as it will travel until it reaches the M.E.
M.E: Mechanical end
S.E: Stroke end
- *2 If the home direction needs to be changed after purchase, the actuator must be returned to IAI for adjustment.

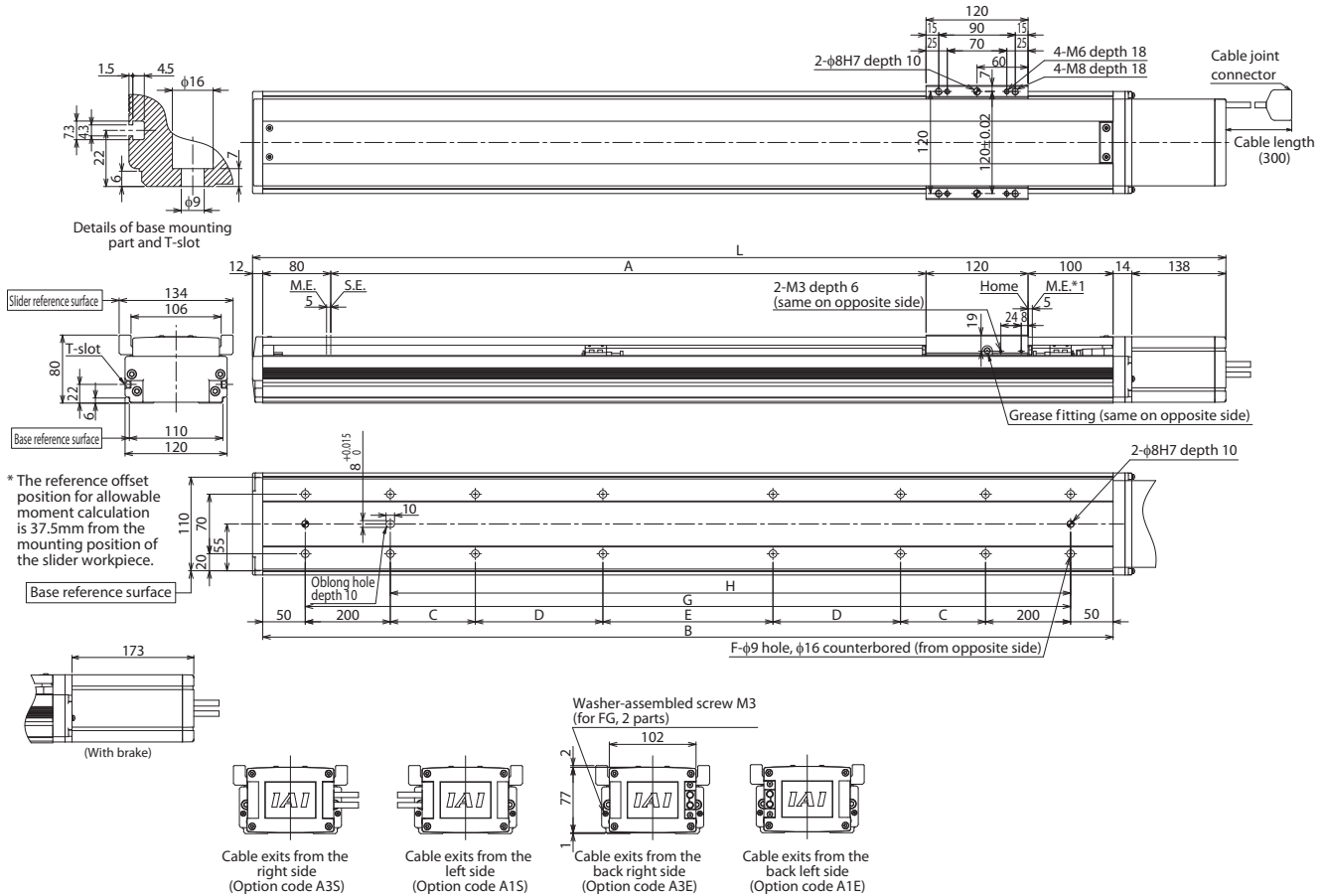

Dimensions and Mass by Stroke

Stroke	800	850	900	950	1,000	1,050	1,100	1,150	1,200	1,250	1,300	1,350	1,400	1,450	1,500	1,550	1,600	1,650	1,700	1,750	1,800	1,850	1,900	1,950	2,000	
L	w/o brake	1,264	1,314	1,364	1,414	1,464	1,514	1,564	1,614	1,664	1,714	1,764	1,814	1,864	1,914	1,964	2,014	2,064	2,114	2,164	2,214	2,264	2,314	2,364	2,414	2,464
	w/brake	1,299	1,349	1,399	1,449	1,499	1,549	1,599	1,649	1,699	1,749	1,799	1,849	1,899	1,949	1,999	2,049	2,099	2,149	2,199	2,249	2,299	2,349	2,399	2,449	2,499
A	800	850	900	950	1,000	1,050	1,100	1,150	1,200	1,250	1,300	1,350	1,400	1,450	1,500	1,550	1,600	1,650	1,700	1,750	1,800	1,850	1,900	1,950	2,000	
B	1,100	1,150	1,200	1,250	1,300	1,350	1,400	1,450	1,500	1,550	1,600	1,650	1,700	1,750	1,800	1,850	1,900	1,950	2,000	2,050	2,100	2,150	2,200	2,250	2,300	
C	200	200	200	200	200	225	250	275	300	325	350	375	400	425	450	475	500	525	550	575	200	200	200	200	200	
D	0	0	0	0	0	0	0	0	0	0	0	0	0	0	0	0	0	0	0	0	400	425	450	475	500	
E	200	250	300	350	400	400	400	400	400	400	400	400	400	400	400	400	400	400	400	400	400	400	400	400	400	400
F	12	12	12	12	12	12	12	12	12	12	12	12	12	12	12	12	12	12	12	12	12	16	16	16	16	
G	1,000	1,050	1,100	1,150	1,200	1,250	1,300	1,350	1,400	1,450	1,500	1,550	1,600	1,650	1,700	1,750	1,800	1,850	1,900	1,950	2,000	2,050	2,100	2,150	2,200	
H	800	850	900	950	1,000	1,050	1,100	1,150	1,200	1,250	1,300	1,350	1,400	1,450	1,500	1,550	1,600	1,650	1,700	1,750	1,800	1,850	1,900	1,950	2,000	
Mass (kg)	w/o brake	17.1	17.7	18.4	19.0	19.6	20.3	20.9	21.5	22.2	22.8	23.4	24.1	24.7	25.4	26.0	26.6	27.3	27.9	28.5	29.2	29.8	30.4	31.1	31.7	32.3
	w/brake	17.7	18.3	19.0	19.6	20.2	20.9	21.5	22.1	22.8	23.4	24.0	24.7	25.3	25.9	26.6	27.2	27.8	28.5	29.1	29.8	30.4	31.0	31.7	32.3	

Applicable Controllers

The ISB series actuators can be operated by the controllers indicated below. Please select the type depending on your intended use.

Type	External view	Max. number of controlled axes	Power supply voltage	Control method			Network *Option	Maximum number of positioning points	Ref. page
				Positioner	Pulse-train	Program			
SCON-CB/CGB		1	Single-phase 200VAC	●	●	—	DeviceNet CC-Link CompoNet EtherCAT EtherNet/IP	512 points (768 for network spec.)	Please contact IAI for more details
SCON-LC/LCG		1		—	—	●		512 points (768 for network spec.)	
SSEL-CS		2	Single-phase 100/200VAC	●	—	●	20,000		
XSEL-P/Q/R/S/RA/SA		8	Single-phase 200VAC Three-phase 200VAC	—	—	●	55,000 (depending on the type)		

Note: The type of compatible networks will vary depending on the controller. Please contact IAI for more details.

Sold & Served By:

Toll Free Phone (877) SEP-098
Toll Free Fax (877) SEP-099
www.electromate.com
sales@electromate.com

ISDB-S-100

±10μm Standard
Battery-less Absolute
Simple Dust-proof
Compact type
Body Width 90mm
100W

Model Specification Items
ISDB — **S** — **WA** — **100** — **36** — **T2** — **□** — **□**
 Series — Type — Encoder Type — Motor Type — Lead — Stroke — Applicable Controllers — Cable Length — Options
 WA: Battery-less absolute 100: 100W 36: 36mm 100: 100mm (800/800mm (50mm increments)) T2: SCON, MSCON, SSEL, XSEL-P/Q, XSEL-R/S/RA/SA N: None, S: 3m, M: 5m Please refer to the option table below

* Does not include a controller.
 * Please contact IAI for more information about the model specification items.
 * Be sure to specify the AQ seal (AQ) option. Be sure to select a symbol for the cable outlet direction.

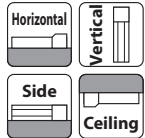

* Depending on the model, there may be some limitations to using the vertical, side, and ceiling mount positions. Please contact IAI for more information regarding mounting positions. Please contact IAI for more details.



POINT Selection Notes

(Note 1) The value of payload is when operating at an acceleration of 0.4G. When the acceleration is increased, the payload will be reduced. Please refer to P.21 for more information.

(Note 2) The value of straightness of straight line motion is when specifying the straightness high precision specifications (optional).

Model/Specifications

Lead and Payload

* When using the guide with ball retention mechanism (RT), the vertical payload will be -0.5kg.

Model	Motor wattage (W)	Lead (mm)	Max. payload (Note 1)		Rated thrust (N)	Stroke (mm)
			Horizontal (kg)	Vertical (kg)		
ISDB-S-WA-100-36-①-T2-②-③	100	36	10	2	47.2	100~800 (Every 50mm)

Legend: ① Stroke ② Cable length ③ Option

Stroke and Max. Speed

Stroke	100	150	200	250	300	350	400
Max. Speed	1,075	1,370	1,620	1,830	1,940	1,980	2,000
Stroke	450	500	550	600	650	700	750
Max. Speed	2,000	1,825	1,590	1,400	1,240		
Stroke	800						
Max. Speed	1,105						

(Unit: mm/s)

① Stroke

① Stroke (mm)	Standard
100	○
150/200	○
250/300	○
350/400	○
450/500	○
550/600	○
650/700	○
750/800	○

② Cable Length

Type	Cable code	Standard	With LS
Standard type	S (3m)		○
	M (5m)		○
Specified length	X06 (6m) ~X10 (10m)	○	○
	X11 (11m) ~X20 (20m)	○	○

* Only the robot cable is available for this model.
 * Please contact IAI for more information regarding the maintenance cables.
 * When using a cable of 21 to 30m, specify "N" for the cable length of the actuator model, and separately purchase the motor cable (CB-X-MA□□□□), encoder cable (CB-X1-PA □□□□-AWG24) or encoder cable with LS (CB-X1-PLA □□□□-AWG24). (Please contact IAI for more details on the cable.)

③ Options

Type	Model	Ref. Page	Type	Model	Ref. Page
Cable exits from the left side	A1S	See P.19	Master axis specified	LM	See P.19
Cable exits from the back left side	A1E	See P.19	Master axis spec. (sensor symmetrically opposite)	LLM	See P.19
Cable exits from the right side	A3S	See P.19	Non-motor end spec.	NM	See P.19
Cable exits from the back right side	A3E	See P.19	Guide with ball retention mechanism	RT	See P.20
AQ seal (Standard equipment)	AQ	See P.19	Slave axis specified	S	See P.19
Brake	B	See P.19	Slider section roller spec.	SR	See P.20
Creep sensor	C	See P.19	Straightness high precision spec. (stroke: 100~600)	ST	See P.20
Creep sensor symmetrically opposite	CL	See P.19	Straightness high precision spec. (stroke: 650~800)	ST	See P.20
Home limit switch	L	See P.19	Double slider spec.	W	See P.20
Home limit switch symmetrically opposite	LL	See P.19			

Actuator Specifications

Item	Description
Positioning repeatability	±0.01mm
Drive system	Ball screw φ12mm, rolled C10
Lost motion	0.05mm or less
Static allowable moment	Ma: 143.8N·m Mb: 205.4N·m Mc: 336.0N·m
Dynamic allowable moment (*)	Ma: 32.9N·m Mb: 47.0N·m Mc: 76.8N·m
Straightness of straight line motion (Note 2)	0.02mm/m or less
Base	Material: Aluminum with white alumite treatment
Protective structure	IP30
Ambient operating temp. & humidity	0~40°C, 85% RH or less (Non-condensing)

- Reference for overhang load length: Ma: 450mm or less, Mb: 400mm or less
 (*) Assumes a standard rated life of 10,000km. The service life will vary depending on operation and installation conditions. Please contact IAI for the running life.
 (*) Please refer to P.22 for more information regarding the directions of the allowable moment and overhang load length when using the double slider.

Sold & Serviced By:
ELECTROMATE
 Toll Free Phone (877) SERV098
 Toll Free Fax (877) SERV099
 www.electromate.com
 sales@electromate.com

ISDB-M-400



Model Specification Items
ISDB — **M** — **WA** — **400** — **48** — — **T2** — —
Series — **Type** — **Encoder Type** — **Motor Type** — **Lead** — **Stroke** — **Applicable Controllers** — **Cable Length** — **Options**
 WA: Battery-less absolute 400: 400W 48: 48mm 100: 100mm 1100: 1,100mm (50mm increments) T2: SCON, SSEL, XSEL-P/Q, XSEL-R/S/RA/SA N: None, S: 3m, M: 5m Please refer to the option table below

* Does not include a controller.

* Please contact IAI for more information about the model specification items.

* Be sure to specify the AQ seal (AQ) option. Be sure to select a symbol for the cable outlet direction.

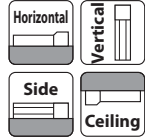

* Depending on the model, there may be some limitations to using the vertical, side, and ceiling mount positions. Please contact IAI for more information regarding mounting positions. Please contact IAI for more details.



(Note 1) The value of payload is when operating at an acceleration of 0.4G. When the acceleration is increased, the payload will be reduced. Please refer to P.21 for more information.

(Note 2) The value of straightness of straight line motion is when specifying the straightness high precision specifications (optional).

Model/Specifications

Lead and Payload

Model	Motor wattage (W)	Lead (mm)	Max. payload (Note 1)		Rated thrust (N)	Stroke (mm)
			Horizontal (kg)	Vertical (kg)		
ISDB-M-WA-400-48-①-T2-②③	400	48	20	6	141.3	100~1,100 (Every 50mm)

Legend: ① Stroke ② Cable length ③ Option

Stroke and Max. Speed

Stroke	100	150	200	250	300	350	400
Max. Speed	980	1,270	1,520	1,740	1,930	2,050	2,125
Stroke	450	500	550	600	650	700	750
Max. Speed	2,200						2,145
Stroke	800	850	900	950	1,000	1,050	1,100
Max. Speed	1,920	1,730	1,570	1,430	1,305	1,195	1,105

(Unit: mm/s)

① Stroke

① Stroke (mm)	Standard
100	<input type="radio"/>
150/200	<input type="radio"/>
250/300	<input type="radio"/>
350/400	<input type="radio"/>
450/500	<input type="radio"/>
550/600	<input type="radio"/>
650/700	<input type="radio"/>
750/800	<input type="radio"/>
850/900	<input type="radio"/>
950/1,000	<input type="radio"/>
1,050/1,100	<input type="radio"/>

② Cable Length

Type	Cable code	Standard	With LS
Standard type	S (3m)	<input type="radio"/>	<input type="radio"/>
	M (5m)	<input type="radio"/>	<input type="radio"/>
Specified length	X06 (6m) ~ X10 (10m)	<input type="radio"/>	<input type="radio"/>
	X11 (11m) ~ X20 (20m)	<input type="radio"/>	<input type="radio"/>

* Only the robot cable is available for this model.

* Please contact IAI for more information regarding the maintenance cables.

* When using a cable of 21 to 30m, specify "N" for the cable length of the actuator model, and separately purchase the motor cable (CB-X-MA□□□□), encoder cable (CB-X1-PA□□□□-AWG24) or encoder cable with LS (CB-X1-PLA□□□□-AWG24). (Please contact IAI for more details on the cable.)

③ Options

Type	Model Ref. Page	Type	Model Ref. Page
Cable exits from the left side	A1S See P.19	Master axis specified	LM See P.19
Cable exits from the back left side	A1E See P.19	Master axis spec. (sensor symmetrically opposite)	LLM See P.19
Cable exits from the right side	A3S See P.19	Non-motor end spec.	NM See P.19
Cable exits from the back right side	A3E See P.19	Guide with ball retention mechanism	RT See P.20
AQ seal (Standard equipment)	AQ See P.19	Slave axis specified	S See P.19
Brake	B See P.19	Slider section roller spec.	SR See P.20
Creep sensor	C See P.19	Straightness high precision spec. (stroke: 100~600)	ST See P.20
Creep sensor symmetrically opposite	CL See P.19	Straightness high precision spec. (stroke: 650~1,100)	ST See P.20
Home limit switch	L See P.19	Double slider spec.	W See P.20
Home limit switch symmetrically opposite	LL See P.19		

Actuator Specifications

Item	Description
Positioning repeatability	±0.01mm
Drive system	Ball screw φ16mm, rolled C10
Lost motion	0.05mm or less
Static allowable moment	Ma: 341.5N·m Mb: 487.0N·m Mc: 796.5N·m
Dynamic allowable moment (*)	Ma: 81.0N·m Mb: 116N·m Mc: 189N·m
Straightness of straight line motion (Note 2)	0.02mm/m or less
Base	Material: Aluminum with white alumite treatment
Protective structure	IP30
Ambient operating temp. & humidity	0~40°C, 85% RH or less (Non-condensing)

Sold & Serviced By:



* Reference for overhang load length: Ma: 600mm or less, Mb: 300mm or less

(*) Assumes a standard rated life of 10,000km. The service life will vary depending on operation and installation conditions. Please contact IAI for the running life.

(*) Please refer to P.22 for more information regarding the directions of the motor cable and overhang load length when using the double slider.

Dimensions

CAD drawings can be downloaded from our website.
www.intelligentactuator.com



- *1 When the slider is returning to its home position, please be careful of interference from surrounding objects, as it will travel until it reaches the M.E.
M.E: Mechanical end
S.E: Stroke end
- *2 If the home direction needs to be changed after purchase, the actuator must be returned to IAI for adjustment.

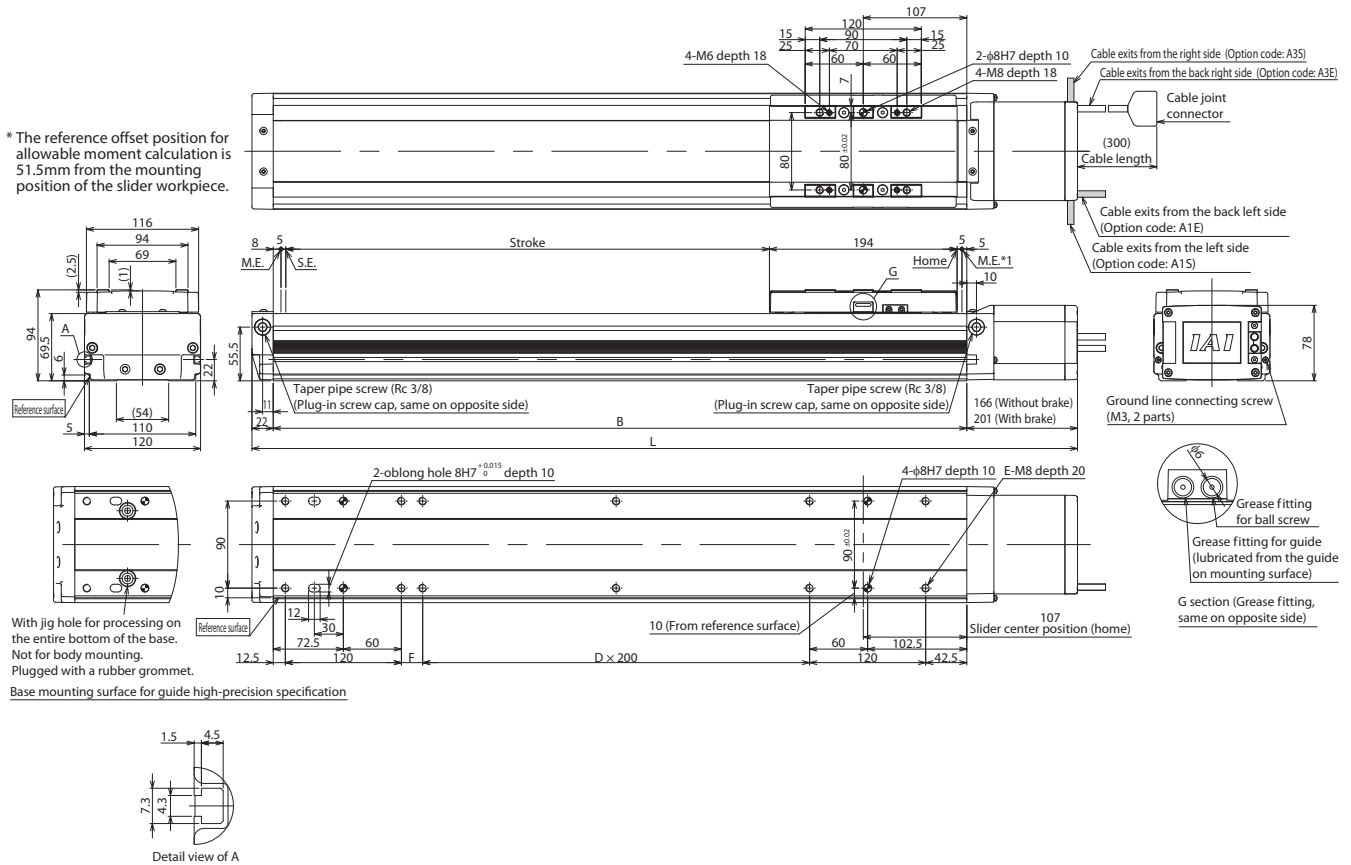

■ Dimensions and Mass by Stroke

Stroke	100	150	200	250	300	350	400	450	500	550	600	650	700	750	800	850	900	950	1,000	1,050	1,100	
L	w/o brake	505	555	605	655	705	755	805	855	905	955	1,005	1,055	1,105	1,155	1,205	1,255	1,305	1,355	1,405	1,455	1,505
	w/brake	540	590	640	690	740	790	840	890	940	990	1,040	1,090	1,140	1,190	1,240	1,290	1,340	1,390	1,440	1,490	1,540
B	317	367	417	467	517	567	617	667	717	767	817	867	917	967	1,017	1,067	1,117	1,167	1,217	1,267	1,317	
D	0	0	0	0	1	1	1	1	2	2	2	2	3	3	3	3	4	4	4	4	4	5
E	8	8	8	8	10	10	10	10	12	12	12	12	14	14	14	14	16	16	16	16	16	18
F	22	72	122	172	22	72	122	172	22	72	122	172	22	72	122	172	22	72	122	172	22	22
Mass (kg)	w/o brake	8.5	9.1	9.7	10.3	11.0	11.6	12.2	12.9	13.5	14.1	14.8	15.4	16.0	16.6	17.3	17.9	18.5	19.2	19.8	20.4	21.1
	w/brake	9.0	9.7	10.3	10.9	11.6	12.2	12.8	13.5	14.1	14.7	15.3	16.0	16.6	17.2	17.9	18.5	19.1	19.8	20.4	21.0	21.6

Applicable Controllers

The ISDB series actuators can be operated by the controllers indicated below. Please select the type depending on your intended use.

Type	External view	Max. number of controlled axes	Power supply voltage	Control method			Network *Option	Maximum number of positioning points	Ref. page
				Positioner	Pulse-train	Program			
SCON-CB/CGB		1	Single-phase 200VAC	●	●	-	DeviceNet CC-Link CompoNet MECHATROLINK EtherCAT EtherNet/IP	512 points (768 for network spec.)	Please contact IAI for more details
SCON-LC/LCG		1		-	-	●		512 points (768 for network spec.)	
SSEL-CS		2	Single-phase 100/200VAC	●	-	●	20,000		
XSEL-P/Q/R/S/RA/SA		8	Single-phase 200VAC Three-phase 200VAC	-	-	●	55,000 (depending on the type)		

Note: The type of compatible networks will vary depending on the controller. Please contact IAI for more details.

Sold & Served By:

ELECTROMATE
 Toll Free Phone (877) SERVO98
 Toll Free Fax (877) SERVO99
 www.electromate.com
 sales@electromate.com

ISDB-MX-400



Model Specification Items
ISDB — **MX** — **WA** — **400** — **48** — — **T2** — —
 Series — Type — Encoder Type — Motor Type — Lead — Stroke — Applicable Controllers — Cable Length — Options
 WA: Battery-less absolute 400: 400W 48: 48mm 800: 800mm T2: SCON, SSEL, XSEL-P/Q, XSEL-R/S/RA/SA N: None, S: 3m, M: 5m Please refer to the option table below

* Does not include a controller.

* Please contact IAI for more information about the model specification items.

* Be sure to specify the AQ seal (AQ) option. Be sure to select a symbol for the cable outlet direction.

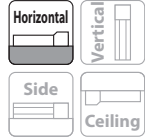

* Please contact IAI for more details on the installation method.



(Note 1) The value of payload is when operating at an acceleration of 0.4G. Please refer to P.21 for more information.

(Note 2) The value of straightness of straight line motion is when specifying the straightness high precision specifications (optional).

Model/Specifications

Lead and Payload

Model	Motor wattage (W)	Lead (mm)	Max. payload (Note 1)		Rated thrust (N)	Stroke (mm)
			Horizontal (kg)	Vertical (kg)		
ISDB-MX-WA-400-48-①-T2-②-③	400	48	20	—	141.3	800~1,600 (Every 50mm)

Legend: ① Stroke ② Cable length ③ Option

Stroke and Max. Speed

Stroke	800	850	900	950	1,000	1,050	1,100
Max. Speed	1,700	1,750	1,800	1,850	1,900	1,950	2,000
Stroke	1,150	1,200	1,250	1,300	1,350	1,400	1,450
Max. Speed	2,050	2,100	2,150	2,200	1,990	1,860	1,745
Stroke	1,500	1,550	1,600				
Max. Speed	1,640	1,540	1,450				

(Unit: mm/s)

① Stroke

① Stroke (mm)	Standard
800	<input type="radio"/>
850/900	<input type="radio"/>
950/1,000	<input type="radio"/>
1,050/1,100	<input type="radio"/>
1,150/1,200	<input type="radio"/>
1,250/1,300	<input type="radio"/>
1,350/1,400	<input type="radio"/>
1,450/1,500	<input type="radio"/>
1,550/1,600	<input type="radio"/>

② Cable Length

Type	Cable code	Standard	With LS
Standard type	S (3m)	<input type="radio"/>	<input type="radio"/>
	M (5m)	<input type="radio"/>	<input type="radio"/>
Specified length	X06 (6m) ~ X10 (10m)	<input type="radio"/>	<input type="radio"/>
	X11 (11m) ~ X20 (20m)	<input type="radio"/>	<input type="radio"/>

* Only the robot cable is available for this model.

* Please contact IAI for more information regarding the maintenance cables.

* When using a cable of 21 to 30m, specify "N" for the cable length of the actuator model, and separately purchase the motor cable (CB-X-MA□□□□), encoder cable (CB-X1-PA□□□□-AWG24) or encoder cable with LS (CB-X1-PLA□□□□-AWG24). (Please contact IAI for more details on the cable.)

③ Options

Type	Model Ref. Page	Type	Model Ref. Page
Cable exits from the left side	A1S See P.19	Home limit switch symmetrically opposite	LL See P.19
Cable exits from the back left side	A1E See P.19	Master axis specified	LM See P.19
Cable exits from the right side	A3S See P.19	Master axis spec. (sensor symmetrically opposite)	LLM See P.19
Cable exits from the back right side	A3E See P.19	Non-motor end spec.	NM See P.19
AQ seal (Standard equipment)	AQ See P.19	Guide with ball retention mechanism	RT See P.20
Brake	B See P.19	Slave axis specified	S See P.19
Creep sensor	C See P.19	Straightness high precision spec. (stroke: 800~1,300)	ST See P.20
Creep sensor symmetrically opposite	CL See P.19	Straightness high precision spec. (stroke: 1,350~1,600)	ST See P.20
Home limit switch	L See P.19		

Actuator Specifications

Item	Description
Positioning repeatability	±0.01mm
Drive system	Ball screw φ16mm, rolled C10
Lost motion	0.05mm or less
Static allowable moment	Ma: 341.5N·m Mb: 487.0N·m Mc: 796.5N·m
Dynamic allowable moment (*)	Ma: 81.0N·m Mb: 116N·m Mc: 189N·m
Straightness of straight line motion (Note 2)	0.02mm/m or less
Base	Material: Aluminum with white alumite treatment
Protective structure	IP30
Ambient operating temp. & humidity	0~40°C, 85% RH or less (No condensing)

(*) Reference for overhang load length: Ma: 600mm or less, Mb: 900mm or less, Mc: 1,200mm or less. (*) Assumes a standard rated life of 10,000km. The service life will vary depending on operation and installation conditions. Please contact IAI for the running life.

Sold & Serviced By:

 Toll Free Phone (877) SERV098
 Toll Free Fax (877) SERV099
 www.electromate.com
 sales@electromate.com

Dimensions

CAD drawings can be downloaded from our website.
www.intelligentactuator.com



- *1 When the slider is returning to its home position, please be careful of interference from surrounding objects, as it will travel until it reaches the M.E.
M.E: Mechanical end
S.E: Stroke end
- *2 If the home direction needs to be changed after purchase, the actuator must be returned to IAI for adjustment.

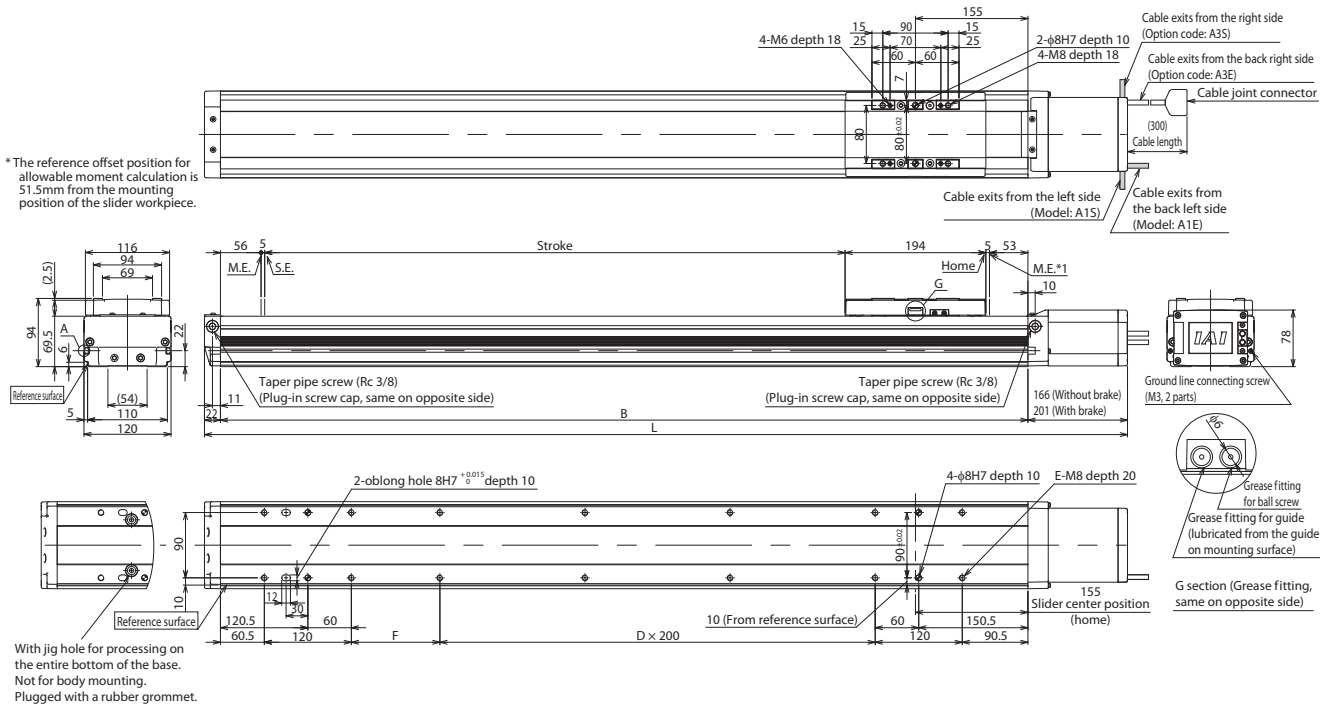

Base mounting surface for guide high-precision specification

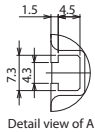

■ Dimensions and Mass by Stroke

Stroke	800	850	900	950	1,000	1,050	1,100	1,150	1,200	1,250	1,300	1,350	1,400	1,450	1,500	1,550	1,600	
L	w/o brake	1,301	1,351	1,401	1,451	1,501	1,551	1,601	1,651	1,701	1,751	1,801	1,851	1,901	1,951	2,001	2,051	2,101
	w/brake	1,336	1,386	1,436	1,486	1,536	1,586	1,636	1,686	1,736	1,786	1,836	1,886	1,936	1,986	2,036	2,086	2,136
B	1,113	1,163	1,213	1,263	1,313	1,363	1,413	1,463	1,513	1,563	1,613	1,663	1,713	1,763	1,813	1,863	1,913	
D	3	3	3	3	4	4	4	4	5	5	5	5	6	6	6	6	7	
E	14	14	14	14	16	16	16	16	18	18	18	18	20	20	20	20	22	
F	122	172	222	272	122	172	222	272	122	172	222	272	122	172	222	272	122	
Mass (kg)	w/o brake	18.9	19.5	20.2	20.8	21.4	22.1	22.7	23.4	24.0	24.6	25.3	25.9	26.6	27.2	27.8	28.5	29.1
	w/brake	19.5	20.1	20.7	21.4	22.0	22.7	23.3	23.9	24.6	25.2	25.9	26.5	27.1	27.8	28.4	29.1	29.7

Applicable Controllers

The ISDB series actuators can be operated by the controllers indicated below. Please select the type depending on your intended use.

Type	External view	Max. number of controlled axes	Power supply voltage	Control method			Network *Option	Maximum number of positioning points	Ref. page
				Positioner	Pulse-train	Program			
SCON-CB/CGB		1	Single-phase 200VAC	●	●	—	 	512 points (768 for network spec.)	Please contact IAI for more details
SCON-LC/LCG		1		—	—	●		512 points (768 for network spec.)	
SSEL-CS		2	Single-phase 100/200VAC	●	—	●	20,000		
XSEL-P/Q/R/S/RA/SA		8	Single-phase 200VAC Three-phase 200VAC	—	—	●	55,000 (depending on the type)		

Note: The type of compatible networks will vary depending on the controller. Please contact IAI for more details.

Sold & Served By:



Toll Free Phone (877) 567-0988
Toll Free Fax (877) 567-0999
www.electromate.com
sales@electromate.com

Options

Cable exit direction

Option code **A1S/A1E/A3S/A3E**

Description The extraction direction of the actuator cable can be selected from back left, left, back right and right.
* It is required to select an extraction direction.

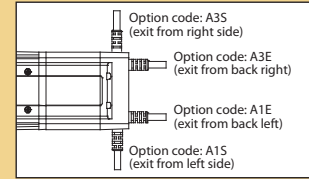

AQ seal

Option code **AQ**

Description AQ seal is a lubricant unit that uses a lubricating member made of lubricating oil solidified with resin. Because it is a porous member that contains a large amount of lubricating oil, the oil seeps out on the surface through capillary action. Lubricating oil is supplied by pressing the AQ seal on the surface of the guide and ball screw (steel ball rolling surface), enabling long-term use without maintenance in a synergistic effect by the combined use of the grease.

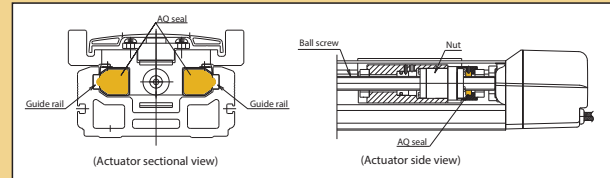

Brake

Option code **B**

Description This is a holding mechanism that prevents the slider from falling and damaging any attached fittings when the power or servo is turned off.

Creep sensor

Option code **C** (Standard) **CL** (Mounted on opposite side)

Description A sensor for performing homing at high speed. As homing is normally done by pressing the slider against the stopper on the motor side stroke end and reversing, the homing speed is kept to 10~20mm/s. Therefore, units with long stroke take time until homing is completed. In order to shorten this, this proximity sensor is used to return the slider at high speed halfway through then drop the speed to normal homing return speed just before the home. The mounting position of the sensor is by default at the right side of the actuator body as viewed from the motor side (Option code: C). It comes with the same cover on the outside of the sensor as the limit switch. When installing a sensor on the opposite side, be sure to select CL (mounting position on opposite side).

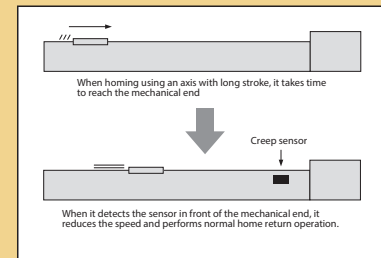

Home limit switch

Option code **L** (Standard) **LL** (Mounted on opposite side)

Description When performing home-return, the pressing method determines the home position upon pressing against the mechanical end and reversing. This is an option for triggering the reversion using the sensor. When L option is specified, 3 proximity sensors including HOME (for home detection), +OT (overtravel on opposite motor side) and -OT (overtravel on the motor side) will be installed. (HOME and -OT are integrated twin sensors) Use it to fine-tune the inverted position or enhance the certitude. (Please note that moving the home sensor excessively may shorten the stroke) The home limit switch and mounting position of the cover is by default at the right side of the actuator body as viewed from the motor side (Option code: L). When installing a sensor on the opposite side, be sure to select LL (mounting position on opposite side).

Master axis specification/Slave axis specification in synchronous operation

Option code **LM** (Limit master axis specification) **LLM** (Mounted on opposite side) **S** (Slave axis specified)

Description One of the features of the XSEL controller is "synchronous operation". This feature is used to operate the two axes of actuators at the same time. With one axis used as the master (M) and another as the slave (S), the slave follows the master in ultra-high-speed control in order to operate at the same time. Two axes of actuators that run synchronously need to have the same specifications (type, lead, motor wattage and stroke). When performing synchronous operation, the master axis needs to have the limit switch specification. Be sure to specify LM (limit specification master axis) for the option code of master axis and S for slave axis. The mounting position of the limit switch and cover is standardly at the right side of the actuator body as viewed from the motor side. When installing the limit switch of the master axis on the opposite side (symmetrically opposite), be sure to select LLM.

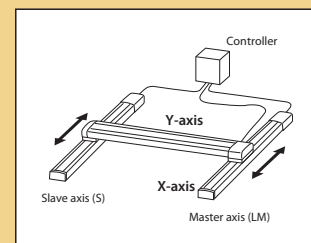

Non-motor end specification

Option code **NM**

Description The normal home position is set to the motor side, but this is the option to set the home position on the other side in order to accommodate variations in equipment layout, etc. (Please note that changing the home position after the actuators are shipped may require the products to be sent back to IAI for re-setting.)

Sold & Serviced By:

ELECTROMATE
Toll Free Phone (877) SERV098
Toll Free Fax (877) SERV099
www.electromate.com
sales@electromate.com

Guide with ball retention mechanism

Option code **RT**

Description A spacer (retainer) is placed between steel balls of the guide to achieve low noise and long life. It eliminates metallic noise due to balls colliding with each other, reducing harsh noise. It reduces wear caused by friction of balls, extending the life of the guide. It eliminates the interference between balls and smoothens the movement, improving the operability of the slider.

* It cannot be used with ISB-SXL/MXL

* When using ISB/ISDB guide with ball retention mechanism in vertical orientation, the vertical payload may differ for some models. Please refer to the pages of each type for details.

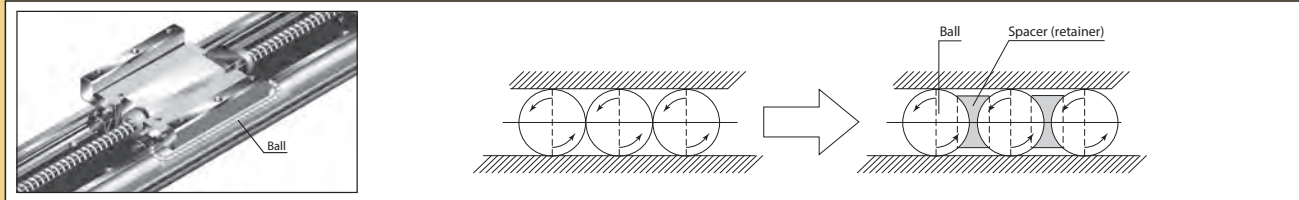

Slider section roller specification

Option code **SR**

Description Changes the slider structure of the standard slider type to the same roller structure of the cleanroom specification. Changing to roller specification will make the external view and dimensions of the slider cover the same as the cleanroom specification.

Straightness high-precision specification

Option code **ST**

Description A precision actuator that defines the running accuracy of slider parallelism of motion (horizontal/vertical) and straightness of straight line motion (horizontal/vertical) at a high level. Respective running accuracy is defined for each stroke of the actuator. The table below shows standard values per 1m. For the method of calculating the standard value for each stroke, please refer to the calculation example.

		Aluminum base	
		Without straightness high-precision specification	With straightness high-precision specification (*)
1	Parallelism of motion [mm/m or less]	0.05 [Stroke of 500mm or less is uniformly 0.025mm]	0.03 [Stroke of 500mm or less is uniformly 0.015mm]
2	Straightness of straight line motion [mm/m or less]	0.05 [Stroke of 500mm or less is uniformly 0.025mm]	0.020 [Stroke of 500mm or less is uniformly 0.01mm]

(*) The precision measurement method depends on the IAI inspection criteria.

Calculation example (with straightness high-precision specification)

① Aluminum base ISB/ISDB Series

Example: For 1,500m stroke

Parallelism of motion $\rightarrow 0.03\text{mm}$ (standard value per 1m) $\times 1.5\text{m}$ (stroke) = 0.045mm

Straightness of straight line motion $\rightarrow 0.02\text{mm}$ (standard value per 1m) $\times 1.5\text{m}$ (stroke) = 0.03mm

* Rounded up to four decimal places

1 Parallelism of motion (Horizontal/Vertical)

① Parallelism of base reference surface and slider movement (Vertical)

It represents the maximum difference between measured values when moving the entire stroke with the indicator on the slider placed on the straightedge placed in parallel with both ends of the base reference surface while fixing the base on the precision surface plate.

② Parallelism of base mounting surface and slider movement (Horizontal)

It represents the maximum difference between measured values when moving the entire stroke with the indicator on the slider placed on the surface plate while fixing the base on the precision surface plate.

2 Straightness of straight line motion (Horizontal/Vertical)

It represents the amount of deviation from the representative line in slider movement measured using a straightedge or autocollimator while the base is fixed to the precision surface plate.

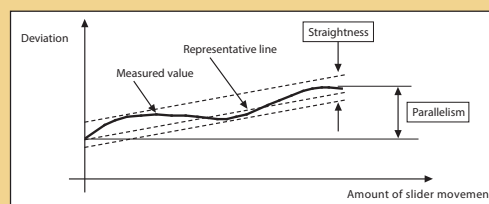
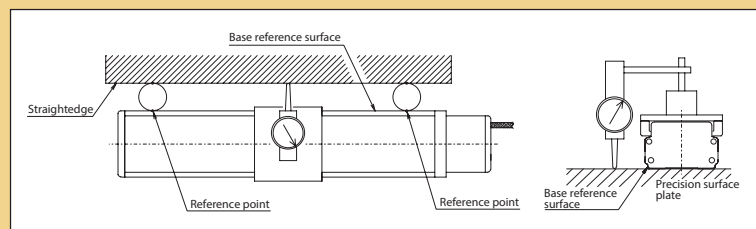

Double slider specification

Option code **W**

Description This option has an additional free slider that is not connected to a ball screw or drive belt. By doubling the slider, the moment and overhang load length can be increased.

* It cannot be used with the intermediate support (MXMX/MX). Please refer to P.22 for more information regarding the directions of the allowable moment and overhang load length when using the double slider.

Sold & Serviced By:

ELECTROMATE

Toll Free Phone (877) SERVO98
Toll Free Fax (877) SERVO99

www.electromate.com
sales@electromate.com

■ Tables of Payload by Acceleration

■ : Standard specification ■ : Off-board tuning specifications

Series	Type	Motor Number of W	Lead	Max. Speed	Installation	Tables of Payload per Acceleration/Deceleration (kg)																													
						0.4	0.5	0.6	0.7	0.8	0.9	1.0	1.1	1.2	1.3	1.4	1.5	1.6	1.7	1.8	1.9	2.0	2.1	2.2	2.3	2.4	2.5	2.6	2.7	2.8	2.9	3.0			
ISB	SXM/SXL	100	36	2,160	Horizontal	10.0	9.0	8.2	7.5	6.7	6.0	5.5	5.0	4.5	4.3	4.1	4.0	3.9	3.8	3.7	3.6	3.5	3.2	2.9	2.6	2.3	2.0	1.9	1.8	1.7	1.6	1.5			
					Vertical	2	2	2	2	2	2	2	2	2	2	2	2	2	2	2	2	2	2	2											
	MXM/MXL	400	48	2,500	Horizontal	20.0	19.1	18.2	17.3	16.4	15.5	14.6	13.8	13.0	12.6	12.2	11.8	11.4	11.0	10.8	10.4	10.0	9.4	8.8	8.2	7.6	7.0	6.6	6.2	5.8	5.4	5.0			
					Vertical	6	6	6	6	6	6	6	6	6	6	6	6	6	6	6	6	6	6												
	MXMX	400	48	2,200	Horizontal	20.0																													
					Vertical	—																													
ISDB	S	100	36	2,000	Horizontal	10.0	9.0	8.1	7.2	6.3	5.4	4.5	4.3	4.1	4.0	3.9	3.8	3.7	3.6	3.5	3.2	2.9	2.6	2.4	2.2	2.0	1.9	1.8	1.7	1.6	1.5	1.4			
					Vertical	2	2	2	2	2	2	2	2	2	2	2	2	2	2	2	2	2	2												
	M	400	48	2,200	Horizontal	20.0	18.8	17.6	16.4	15.2	14.0	13.0	12.6	12.2	11.8	11.4	11.0	10.6	10.3	10.0	9.5	9.0	8.5	8.0	7.5	7.0	6.6	6.2	5.9	5.6	5.3	5.0			
					Vertical	6	6	6	6	6	6	6	6	6	6	6	6	6	6	6	6	6													
	MX	400	48	2,200	Horizontal	20.0																													
					Vertical	—																													

(Note) When using ISB-SXM and ISDB-S guide with ball retention mechanism (RT), the vertical payload will be -0.5kg.

■ Off-board Tuning

Improves the carrying capacity of the actuator

Off-board tuning is a function that improves the carrying capacity and shortens the tact time by automatically setting the optimal gain according to the transport load and improving the payload and acceleration/deceleration.

PC Compatible Software
ver.11.00.02.00 or later

Off-board tuning allows you to obtain the following three effects.

- (1) It can transport over the rated payload by setting the acceleration/deceleration low.
- (2) If the transport weight is smaller than the rated payload, the acceleration/deceleration can be improved.
- (3) The max. speed can be improved.

Off-board tuning is enabled when combined with the SCON-CB/MSCON controller.
Please contact IAI for the further information.

Directions of the Allowable Moment and Overhang Load Length When Using the Double Slider

Please check the following specification table and notes when selecting the double slider.

Series name	Model	Dynamic allowable moment						Overhang load length (mm)	Slider mass to be added (kg)	Slider length (mm)	Minimum stroke for double slider (mm)	Minimum nominal stroke (mm) *	Maximum nominal stroke (mm) *
		Standard rated life (km)	Slider actual span (mm)	Slider cover span (mm)	Ma direction (N-m)	Mb direction (N-m)	Mc direction (N-m)						
ISB	SXM	10,000	Min.: 30	–	140	200	125	1,015	1.5	90	100	250	1,100
			Max.: 90	–	228	325	125	1,350					
	SXL		Min.: 30	–	188	269	145	1,250		110	130	280	1,080
			Max.: 90	–	286	409	145	1,550					
	MXM		Min.: 35	–	332	475	307	1,375	2.5	120	100	300	1,300
			Max.: 120	–	561	801	307	1,800					
MXL	Min.: 35	–	481	687	368	1,675	150	120	320	1,270			
	Max.: 120	–	743	1,060	368	2,100							
ISDB	M	10,000	110	46	259	370	125	1,050	1.5	154	100	300	1,100
			Min.: 80	6	448	640	307	1,375	2.5	194	100	300	1,300
			Max.: 120	46	561	801	307	1,800					

* Min. stroke/max. strokes indicated on the model.

Double slider view

● With slider cover (ISDB Series)

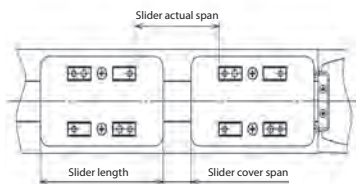

● Without slider cover (ISB Series)

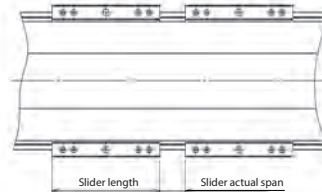

Notes in Using Double Slider

(1) Required stroke length

If the double slider option is specified, the actual operable stroke is the value where slider length + slider actual span (slider cover span) is subtracted from the stroke of the model. Be sure to select the stroke where the length in the table below is added to the required stroke. Also, make sure that the required stroke is higher than the "minimum stroke for double slider".

The selectable stroke is higher than the "minimum nominal stroke" and under the "maximum nominal stroke" in 50mm increments.

NO.	Actuator shape	Stroke length to be prepared
①	Models with slider cover	Greater than or equal to the length of "required stroke" + "slider cover span" + "slider length"
②	Models without slider cover	Greater than or equal to the length of "required stroke" + "slider actual span" + "slider length"

Example ① ISDB-S (With slider cover)

Required stroke: 200mm, slider cover span: 46mm, slider length: 154mm
 Set to $200\text{mm} + 46\text{mm} + 154\text{mm} = 400\text{mm}$ or more

Example ② ISB-SXM (Without slider cover)

Required stroke: 200mm, slider actual span: 30mm, slider length: 90mm
 Set to $200\text{mm} + 30\text{mm} + 90\text{mm} = 320\text{mm}$ or more

(2) Payload

The value where "added slider weight" is subtracted from the catalog specification value is the max. value.

(3) Max. Speed

Please refer to the specification values of the nominal stroke.

(4) When non-motor end specification is selected

Be sure to perform home-return operation upon connecting the drive slider and free slider.

Sold & Serviced By:

ELECTROMATE

Toll Free Phone (877) SEP098

Toll Free Fax (877) SEP099

www.electromate.com

sales@electromate.com