

# ROBO Cylinder IK Series Catalog



Sold & Serviced By:

 **ELECTROMATE**

Toll Free Phone (877) SERV098

Toll Free Fax (877) SERV099

[www.electromate.com](http://www.electromate.com)

[sales@electromate.com](mailto:sales@electromate.com)

# ROBO Cylinder IK Series

## IK Series: Components

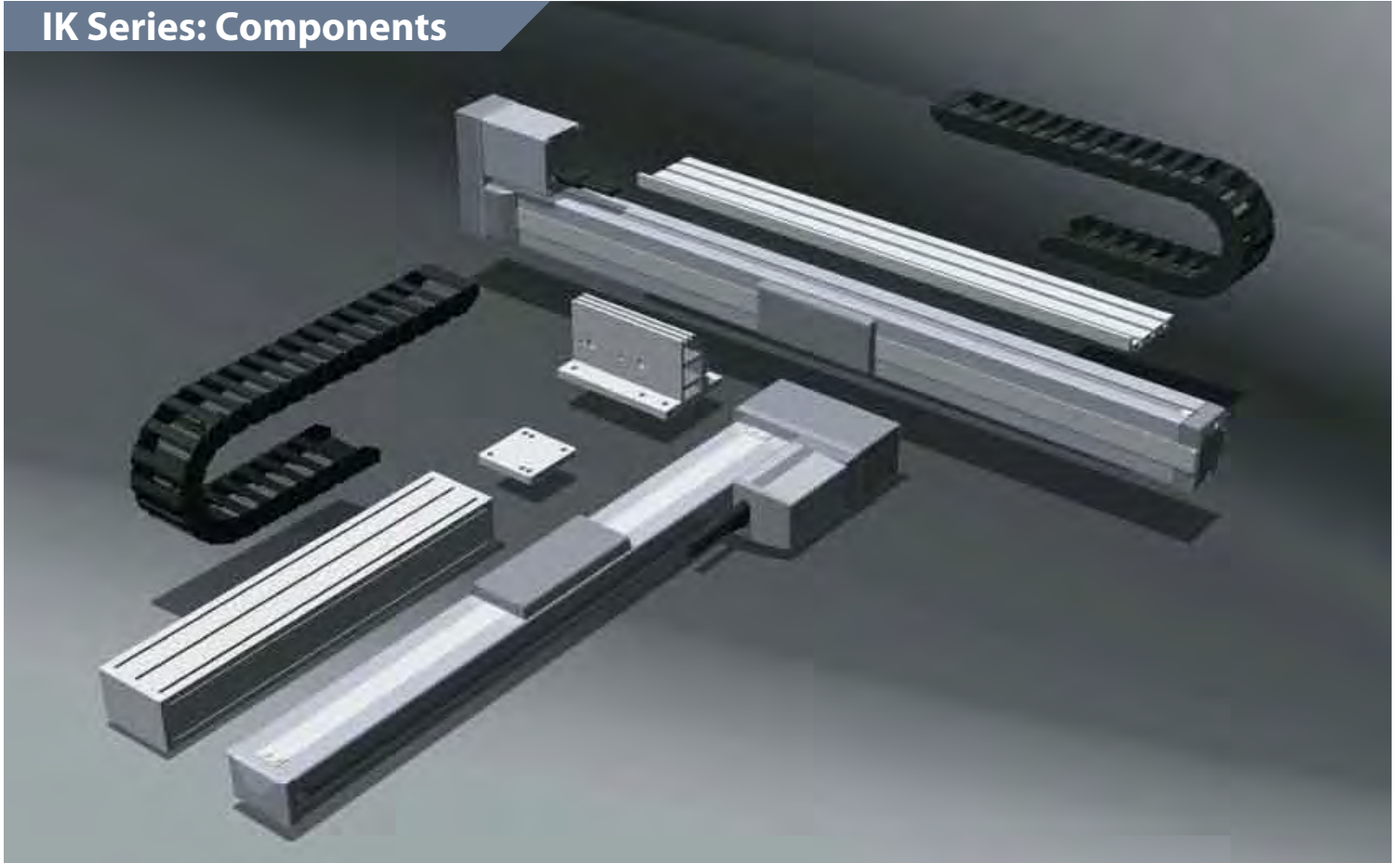

### 1. Wide Variation

The engineers at IAI have worked extensively to produce the highest quality products at affordable prices. The new IK Series lineup offers many variations and can be easily integrated and prepared to your specific needs.

### 2. Motor Options

The IK Series is offered in both pulse and servo motors. Choose the pulse motor for applications requiring high thrust at low speeds. Choose the servo motor for applications requiring constant thrust regardless of the operating speed.

### 3. Easy Assembly

The ROBO Cylinder IK Series multi-axes kit includes everything needed for fast and easy assembly.

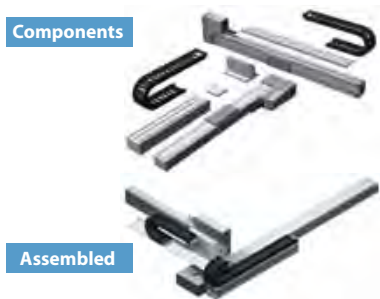

1 IK Series

# Multi-Axes Systems

## IK Series: Assembled



## 4. High Functionality

Combined with the PCON/PSEL/SCON/SSEL/XSEL controllers, complex programming is made easy.



## 5. Quality and Innovation

We at IAI are always working to offer high quality and innovative solutions tailored for your specific application. Whenever you need support, IAI's experienced teams of technical support engineers are available to help you diagnose and troubleshoot IAI products. When you require innovative and high quality robots, excellent service and support for your unique needs, demand IAI!



# Wide-ranging Lineup Lineup of IK Series

## Combinations

### XYB (XY, base mount)

Page  
IK2-PXBD Series ...13~  
IK2-SXBD Series ...43~

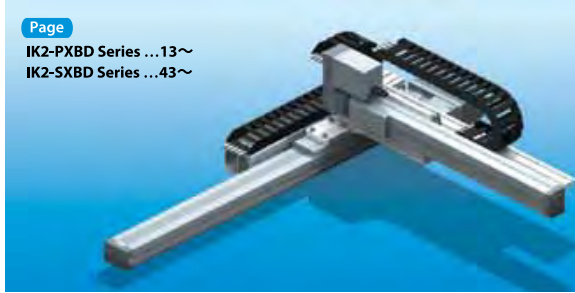

Page  
IK2-PXBC Series ...21~  
IK2-SXBC Series ...51~

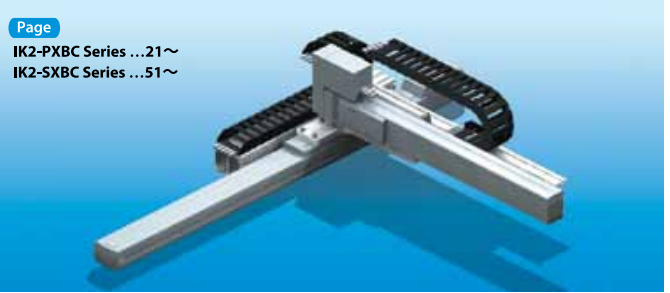

#### • IK2-PXBD Series • IK2-SXBD Series

		Maximum X-axis stroke	Maximum Y-axis stroke	Load capacity at maximum Y-axis stroke
Single-slider	Y high-speed type	600mm	200mm	2.5kg
	Y medium-speed type	600mm	200mm	5.0kg
Double-slider	Y high-speed type	450mm	400mm	2.0kg
	Y medium-speed type	450mm	400mm	4.0kg

#### • IK2-PXBC Series • IK2-SXBC Series

		Maximum X-axis stroke	Maximum Y-axis stroke	Load capacity at maximum Y-axis stroke
Single-slider	Y high-speed type	600mm	200mm	3.0kg
	Y medium-speed type	600mm	200mm	6.0kg
Double-slider	Y high-speed type	450mm	400mm	3.0kg
	Y medium-speed type	450mm	400mm	6.0kg

### XZ (Upright type)

Page  
IK2-PXZB Series ...37~  
IK2-SXZB Series ...75~



#### • IK2-PXZB Series • IK2-SXZB Series

		Maximum X-axis stroke	Maximum Z-axis stroke	Load capacity at maximum Y-axis stroke
Single-slider	X high-speed/Z high-speed type	1,000mm	250mm	1.5kg
	X high-speed/Z medium-speed type	1,000mm	250mm	2.5kg
	X high-speed/Z low-speed type	1,000mm	250mm	3.0kg
Double-slider	X high-speed/Z high-speed type	800mm	300mm	1.5kg
	X high-speed/Z medium-speed type	800mm	300mm	3.0kg
	X high-speed/Z low-speed type	800mm	300mm	5.5kg

### YZB (Cross type, base mount)

Page  
IK2-PYBB Series ...41~  
IK2-SYBB Series ...79~

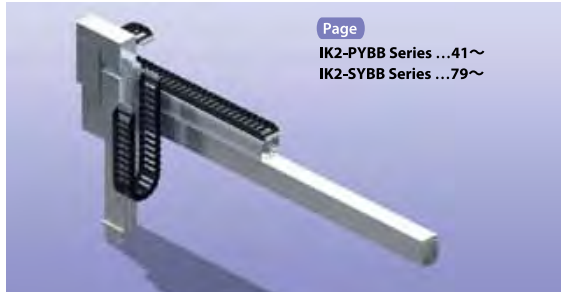

#### • IK2-PYBB Series • IK2-SYBB Series

		Maximum X-axis stroke	Maximum Z-axis stroke	Load capacity at maximum Y-axis stroke
Single-slider	X high-speed/Z high-speed type	1,000mm	300mm	1.5kg
	X high-speed/Z medium-speed type	1,000mm	300mm	3.0kg
	X high-speed/Z low-speed type	1,000mm	300mm	5.5kg

3 IK Series

<b>IK2-P Series / IK3-P Series</b>	<b>ROBO Cylinder RCP2 combinations based on pulse motor</b>
<b>IK2-S Series / IK3-S Series</b>	<b>ROBO Cylinder RCS2 combinations based on servo motor</b>

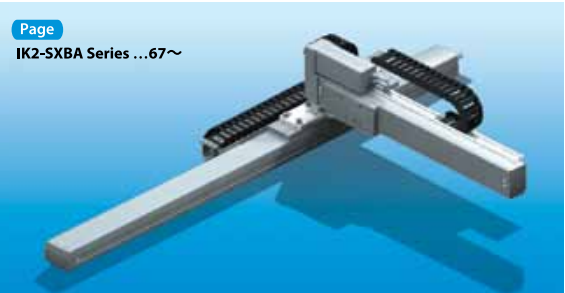
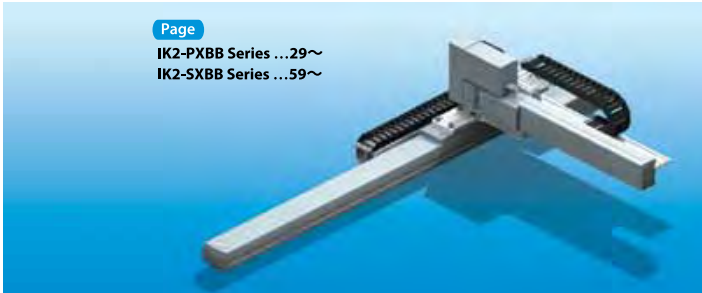

• **IK2-PXBB Series** • **IK2-SXBB Series**

		Maximum X-axis stroke	Maximum Y-axis stroke	Load capacity at maximum Y-axis stroke
Single-slider	High-speed type	1,000mm	300mm	6.0kg
	Medium-speed type	1,000mm	300mm	8.0kg
Double-slider	High-speed type	800mm	400mm	5.5kg
	Medium-speed type	800mm	400mm	10.5kg

• **IK2-SXBA Series**

		Maximum X-axis stroke	Maximum Y-axis stroke	Load capacity at maximum Y-axis stroke
Single-slider	High-speed type	1,000mm	350mm	7.0kg
	Medium-speed type	1,000mm	200mm	12.5kg
Double-slider	High-speed type	800mm	400mm	10.0kg
	Medium-speed type	800mm	400mm	11.5kg

**3-axis type (XYB+Z, base mount)**

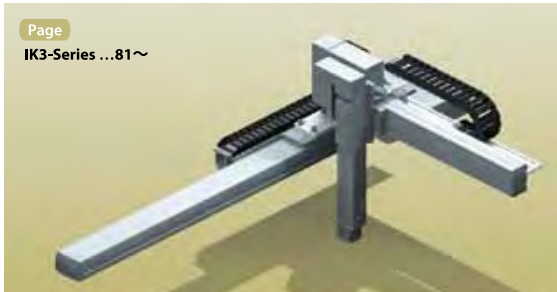

• **IK3 Series**

		Maximum X-axis stroke	Maximum Y-axis stroke	Maximum Z-axis stroke	Load capacity at maximum Y-axis stroke
Single-slider	X high-speed/Y high-speed/Z high-speed type	1,000mm	300mm	200mm	1.0kg
	X high-speed/Y high-speed/Z medium-speed type	1,000mm	300mm	200mm	2.0kg
	X high-speed/Y high-speed/Z low-speed type	1,000mm	300mm	200mm	4.0kg
Double-slider	X high-speed/Y high-speed/Z high-speed type	800mm	400mm	200mm	1.0kg
	X high-speed/Y high-speed/Z medium-speed type	800mm	400mm	200mm	2.0kg
	X high-speed/Y high-speed/Z low-speed type	800mm	400mm	200mm	4.0kg

**2-axis combination – Axis configurations**

	Axis 1	Axis 2
IK2-PXBD	RCP2-SS7□	RCP2-SA5R
IK2-SXBD	RCS2-SS7□	RCS2-SA5R
IK2-PXBC	RCP2-SS7□	RCP2-SA6R
IK2-SXBC	RCS2-SS7□	RCS2-SA6R
IK2-PXBB	RCP2-SS8□	RCP2-SA7R
IK2-SXBB	RCS2-SS8□ (100W)	RCS2-SA7R
IK2-SXBA	RCS2-SS8□ (150W)	RCS2-SS8R (100W)
IK2-PXZB	RCP2-SS8□	RCP2-SA7R
IK2-SXZB	RCS2-SS8□ (100W)	RCS2-SA7R
IK2-PYBB	RCP2-SS8□	RCP2-SA7R
IK2-SYBB	RCS2-SS8□ (100W)	RCS2-SA7R

**3-axis combination – Axis configurations**

	X axis	Y axis	Z axis
IK3	RCP2-SS8□	RCP2-SA7R	RCP2-SA6R
	RCS2-SS8□ (100W)	RCS2-SA7R	RCS2-SA6R

## IK Series

The IK Series is a set that includes the following components needed to assemble the cartesian robot.

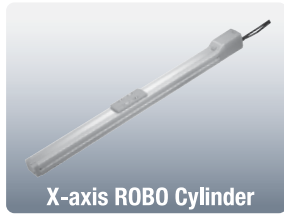

X-axis ROBO Cylinder

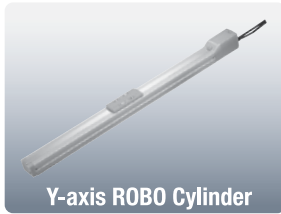

Y-axis ROBO Cylinder

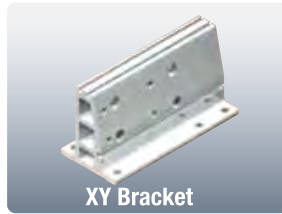

XY Bracket



X Guide Rail

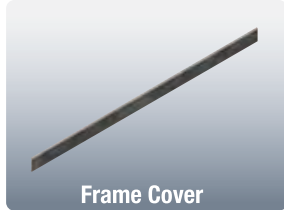

Frame Cover



Y Guide Rail



X Plate (Single)

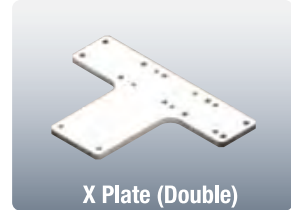

X Plate (Double)



Cable Track

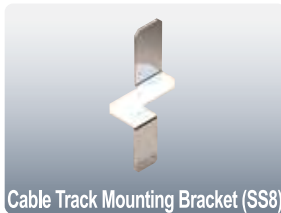

Cable Track Mounting Bracket (SS8)



Cable Track Mounting Bracket (SS7)

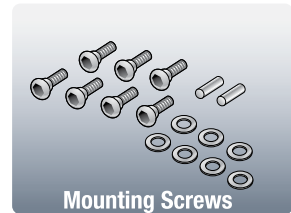

Mounting Screws

Note: The above images are provided for reference purposes only. The actual components may vary depending on the combination type, direction, etc.

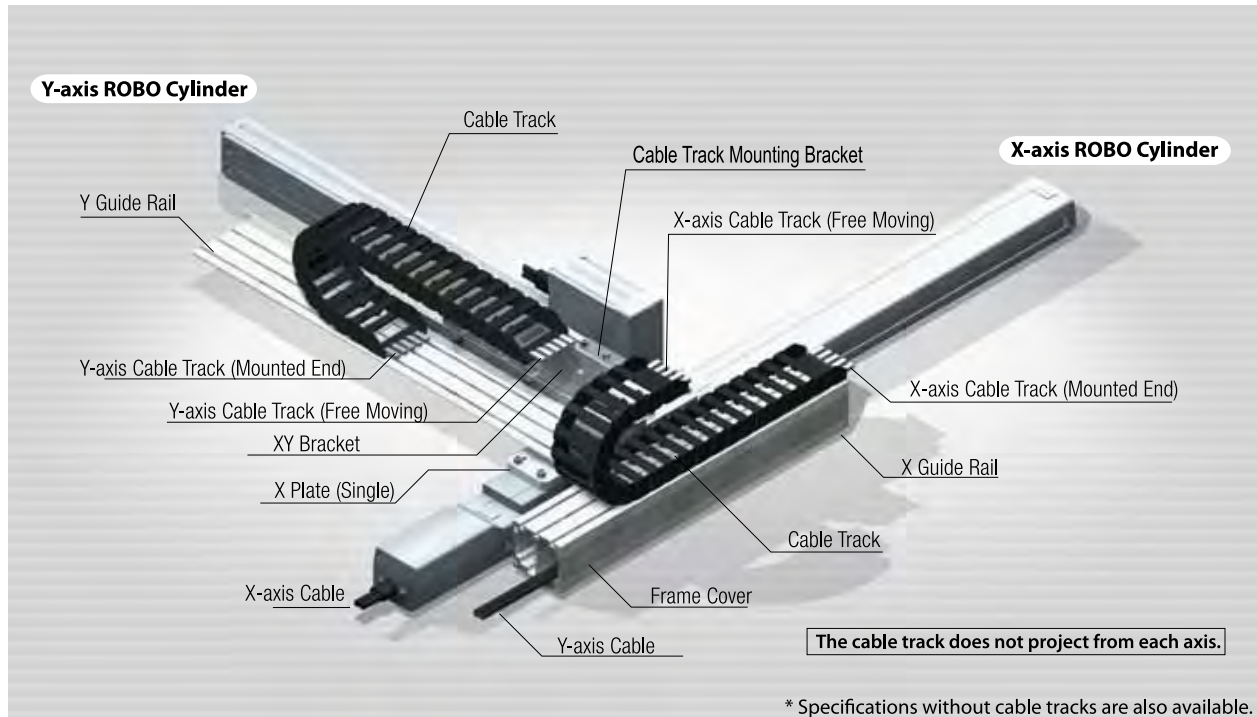

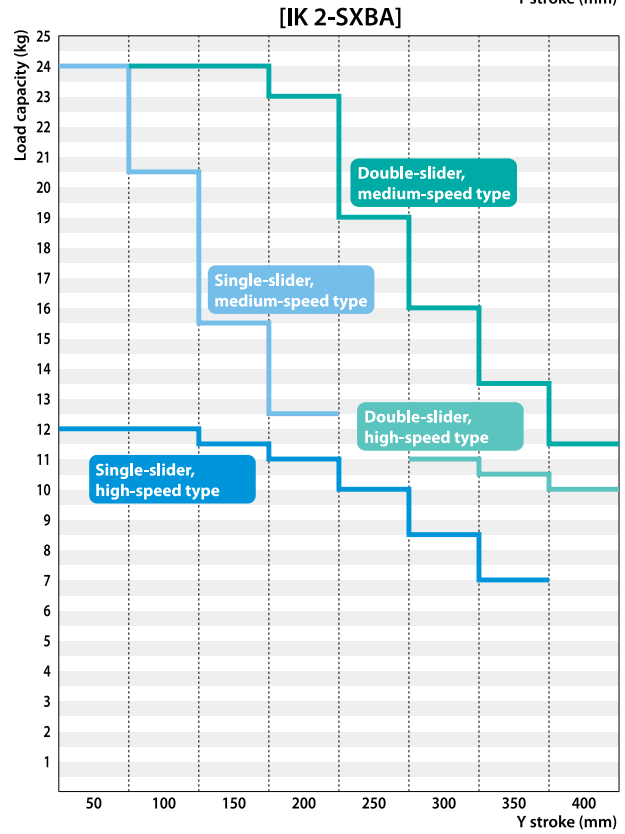
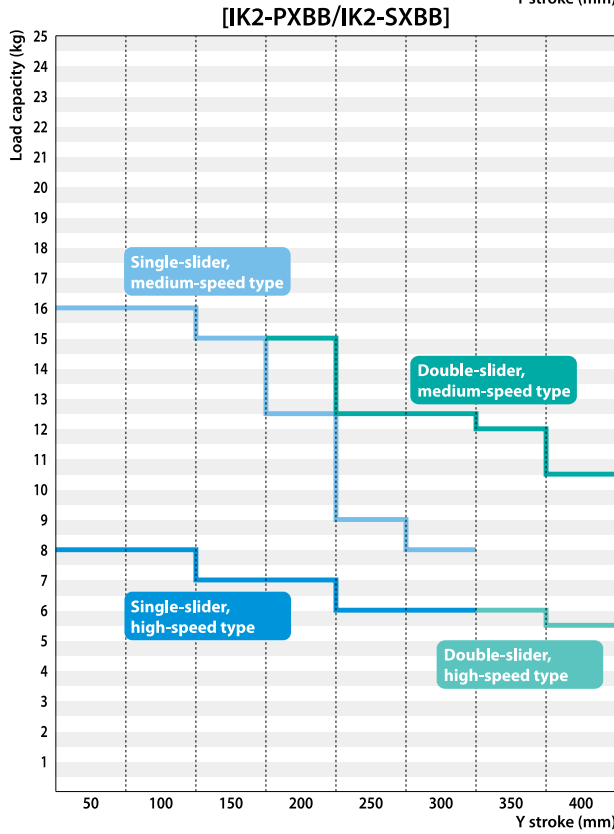
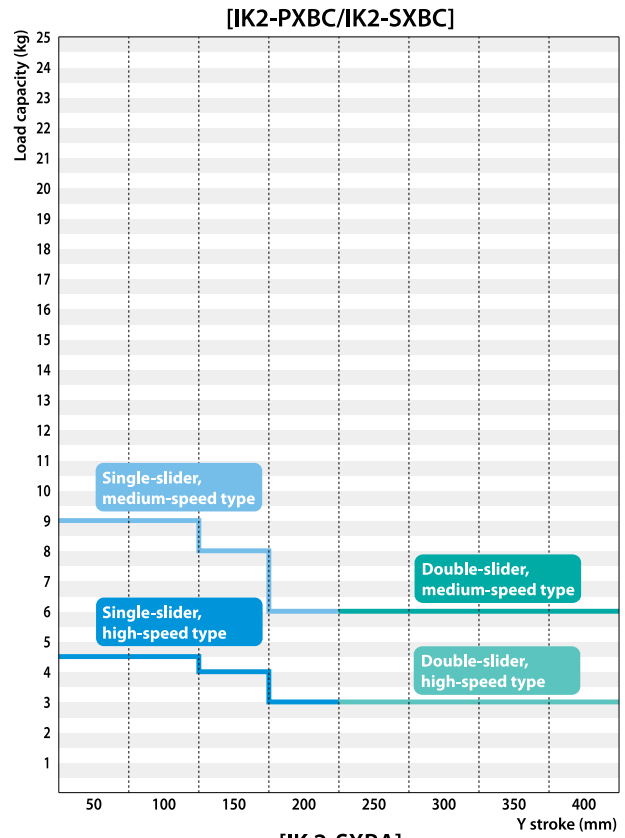
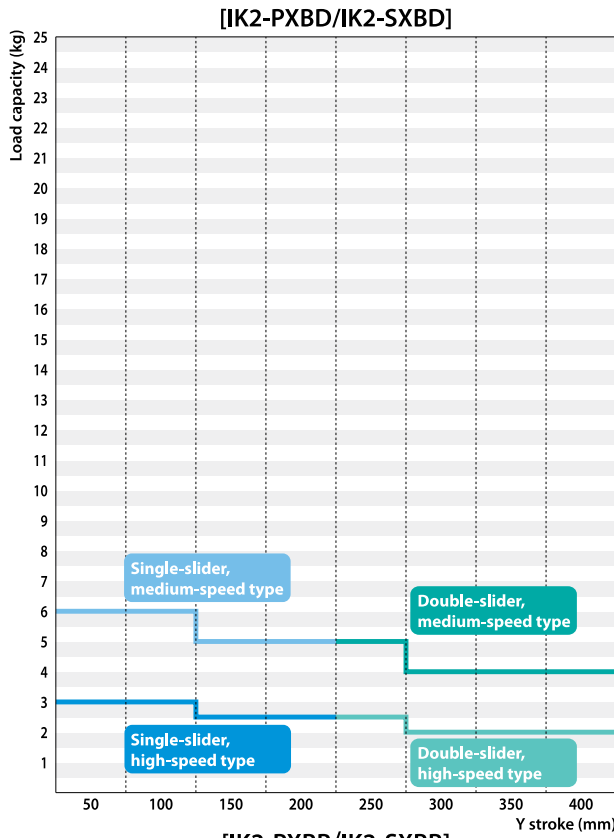

\* Specifications without cable tracks are also available.

# Load Capacity Graphs for XYB Combinations



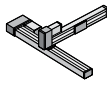
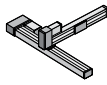
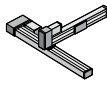
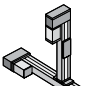

# Combination Unit List for IK Series

**RCP2** Combination Unit List for 2-axis Configuration (XYB) (□ in the model names indicates a value from 1 to 4 specifying the combination direction. For the combination directions, refer to P.10.)

Page	Combination model	Combined shape	Type	Axis 1				Axis 2										
				Motor size	Lead (mm)	Maximum speed (mm/sec)	Stroke (mm)	Type										
13	IK2-PXBD1□HHS		SS7R Reversed	42□	12	400	50-600	SA5R Reversed										
	IK2-PXBD1□HMS				12	350												
15	IK2-PXBD1□HHD		SS7R Reversed, double-slider		12	400	50-450											
	IK2-PXBD1□HMD				12	350												
17	IK2-PXBD2□HHS		SS7C Straight		12	400	50-600											
	IK2-PXBD2□HMS				12	350												
19	IK2-PXBD2□HHD		SS7C Straight, double-slider		12	400	50-450											
	IK2-PXBD2□HMD				12	350												
21	IK2-PXBC1□HHS				SS7R Reversed	56□	12	400		50-600	SA6R Reversed							
	IK2-PXBC1□HMS						12	250										
23	IK2-PXBC1□HHD				SS7R Reversed, double-slider		12	400		50-450								
	IK2-PXBC1□HMD						12	250										
25	IK2-PXBC2□HHS				SS7C Straight		12	400		50-600								
	IK2-PXBC2□HMS						12	250										
27	IK2-PXBC2□HHD				SS7C Straight, double-slider		12	400		50-450								
	IK2-PXBC2□HMD	12		250														
29	IK2-PXBB1□HHS			SS8R Reversed	56□		20	250	50-1000	SA7R Reversed								
	IK2-PXBB1□MMS						10	125										
31	IK2-PXBB1□HHD			SS8R Reversed, double-slider			20	250	50-800									
	IK2-PXBB1□MMD						10	125										
33	IK2-PXBB2□HHS			SS8C Straight			20	250	50-1000									
	IK2-PXBB2□MMS						10	125										
35	IK2-PXBB2□HHD			SS8C Straight, double-slider			20	250	50-800									
	IK2-PXBB2□MMD		10			125												
37	IK2-PXZB1□HHS			SS8R Reversed		56□	20	250	50-1000	SA7R Reversed								
	IK2-PXZB1□HMS																	
39	IK2-PXZB1□HHD			SS8R Reversed, double-slider					20				250	50-800				
	IK2-PXZB1□HMD																	
41	IK2-PYBB1□HHS								SS8R Reversed				56□	20	250	50-1000	SA7R Reversed	
	IK2-PYBB1□HMS																	

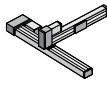
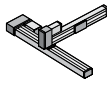
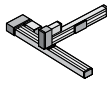
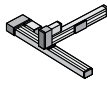
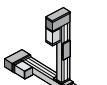
**RCS2** Combination Unit List for 2-axis Configuration (XYB) (□ in the model names indicates a value from 1 to 4 specifying the combination direction. For the combination directions, refer to P.10.)

Page	Combination model	Combined shape	Type	Axis 1				Axis 2										
				Motor output (W)	Lead (mm)	Maximum speed (mm/sec)	Stroke (mm)	Type										
43	IK2-SXBD1□HHS		SS7R Reversed	60	12	600	50-600	SA5R Reversed										
	IK2-SXBD1□HMS				12	600												
45	IK2-SXBD1□HHD		SS7R Reversed, double-slider		12	600	50-450											
	IK2-SXBD1□HMD				12	600												
47	IK2-SXBD2□HHS		SS7C Straight		12	600	50-600											
	IK2-SXBD2□HMS				12	600												
49	IK2-SXBD2□HHD		SS7C Straight, double-slider		12	600	50-450											
	IK2-SXBD2□HMD				12	600												
51	IK2-SXBC1□HHS				SS7R Reversed	100	12	600		50-600	SA6R Reversed							
	IK2-SXBC1□MMS						6	300										
53	IK2-SXBC1□HHD				SS7R Reversed, double-slider		12	600		50-450								
	IK2-SXBC1□MMD						6	300										
55	IK2-SXBC2□HHS				SS7C Straight		12	600		50-600								
	IK2-SXBC2□MMS						6	300										
57	IK2-SXBC2□HHD				SS7C Straight, double-slider		12	600		50-450								
	IK2-SXBC2□MMD	6		300														
59	IK2-SXBB1□HHS			SS8R (100W) Reversed	100		20	1000	50-1000	SA7R Reversed								
	IK2-SXBB1□MMS						10	500										
61	IK2-SXBB1□HHD			SS8R (100W) Reversed, double-slider			20	1000	50-800									
	IK2-SXBB1□MMD						10	500										
63	IK2-SXBB2□HHS			SS8C (100W) Straight			20	1000	50-1000									
	IK2-SXBB2□MMS						10	500										
65	IK2-SXBB2□HHD			SS8C (100W) Straight, double-slider			20	1000	50-800									
	IK2-SXBB2□MMD		10			500												
67	IK2-SXBA1□HHS			SS8R (150W) Reversed		150	20	1000	50-1000	SS8R (100W) Reversed								
	IK2-SXBA1□MMS						10	500										
69	IK2-SXBA1□HHD			SS8R (150W) Reversed, double-slider			20	1000	50-800									
	IK2-SXBA1□MMD						10	500										
71	IK2-SXBA2□HHS			SS8C (150W) Straight			20	1000	50-1000									
	IK2-SXBA2□MMS						10	500										
73	IK2-SXBA2□HHD			SS8C (150W) Straight, double-slider			20	1000	50-800									
	IK2-SXBA2□MMD	10			500													
75	IK2-SXZB1□HHS			SS8R (100W) Reversed	100		20	1000	50-1000	SA7R Reversed								
	IK2-SXZB1□HMS																	
77	IK2-SXZB1□HHD			SS8R (100W) Reversed, double-slider					20				1000	50-800				
	IK2-SXZB1□HMD																	
79	IK2-SYBB1□HHS								SS8R (100W) Reversed				100	20	1000	50-1000	SA7R Reversed	
	IK2-SYBB1□HMS																	

7 IK Series



Axis 1: Mount axis    Axis 2: Axis installed on axis 1    Axis 3: Axis installed on axis 2    Cable wiring 1: Wiring for axis 2    Cable wiring 2: Wiring for axis 3

Motor size	Axis 2			Load capacity by axis 2 stroke							
	Lead (mm)	Maximum speed (mm/sec)	Stroke (mm)	50	100	150	200	250	300	350	400
42□	12	600	50-200	3.0	3.0	2.5	2.5				
	6	300	50-200	6.0	6.0	5.0	5.0				
	12	600	250-400					2.5	2.0	2.0	2.0
	6	300	250-400					5.0	4.0	4.0	4.0
	12	600	50-200	3.0	3.0	2.5	2.5				
	6	300	50-200	6.0	6.0	5.0	5.0				
42□	12	600	250-400					2.5	2.0	2.0	2.0
	6	300	250-400					5.0	4.0	4.0	4.0
	12	600	50-200	4.5	4.5	4.0	3.0				
	6	300	50-200	9.0	9.0	8.0	6.0				
	12	600	250-400					3.0	3.0	3.0	3.0
	6	300	250-400					6.0	6.0	6.0	6.0
56□	16	450	50-300	8.0	8.0	7.0	7.0	6.0	6.0		
	8	220	50-300	16.0	16.0	15.0	12.5	9.0	8.0		
	16	450	350-400							6.0	5.5
	8	220	200-400				15.0	12.5	12.5	12.0	10.5
	16	450	50-300	8.0	8.0	7.0	7.0	6.0	6.0		
	8	220	50-300	16.0	16.0	15.0	12.5	9.0	8.0		
56□	16	450	350-400							6.0	5.5
	8	220	200-400				15.0	12.5	12.5	12.0	10.5
	16	360	50-250	2.0	2.0	2.0	2.0	1.5			
	8	180	50-250	4.0	4.0	3.5	3.5	2.5			
	4	90	50-250	8.0	7.0	5.0	4.0	3.0			
	16	400	300						1.5		
56□	8	200	300						3.0		
	4	100	150-300			7.0	7.0	5.5	5.5		
	16	360	50-300	2.0	2.0	2.0	2.0	1.5	1.5		
	8	180	50-300	4.0	4.0	3.5	3.5	3.0	3.0		
	4	90	50-300	8.0	8.0	7.0	7.0	6.0	5.5		

Motor output (W)	Axis 2			Load capacity by axis 2 stroke							
	Lead (mm)	Maximum speed (mm/sec)	Stroke (mm)	50	100	150	200	250	300	350	400
20	12	800	50-200	3.0	3.0	2.5	2.5				
	6	400		6.0	6.0	5.0	5.0				
	12	800	250-400					2.5	2.0	2.0	2.0
	6	400						5.0	4.0	4.0	4.0
	12	800	50-200	3.0	3.0	2.5	2.5				
	6	400		6.0	6.0	5.0	5.0				
30	12	800	250-400					2.5	2.0	2.0	2.0
	6	400						5.0	4.0	4.0	4.0
	12	800	50-200	4.5	4.5	4.0	3.0				
	6	400		9.0	9.0	8.0	6.0				
	12	800	250-400					3.0	3.0	3.0	3.0
	6	400						6.0	6.0	6.0	6.0
60	16	800	50-300	8.0	8.0	7.0	7.0	6.0	6.0		
	8	400		16.0	16.0	15.0	12.5	9.0	8.0		
	16	800	200-400				15.0	12.5	12.5	12.0	10.5
	8	400									
	16	800	50-300	8.0	8.0	7.0	7.0	6.0	6.0		
	8	400		16.0	16.0	15.0	12.5	9.0	8.0		
100	16	800	350-400							6.0	5.5
	8	400									
	16	800	200-400				15.0	12.5	12.5	12.0	10.5
	8	400									
	20	1000	50-350	12.0	12.0	11.5	11.0	10.0	8.5	7.0	
	10	500		24.0	20.5	15.5	12.5				
60	20	1000	300-400						11.0	10.5	10.0
	10	500			24.0	24.0	23.0	19.0	16.0	13.5	11.5
	20	1000	100-400	12.0	12.0	11.5	11.0	10.0	8.5	7.0	
	10	500		24.0	20.5	15.5	12.5				
	20	1000	300-400						11.0	10.5	10.0
	10	500			24.0	24.0	23.0	19.0	16.0	13.5	11.5
60	16	800	50-250	2.0	2.0	2.0	2.0	1.5			
	8	400		4.0	4.0	3.5	3.5	2.5			
	4	200	300	8.0	7.0	5.0	4.0	3.0			
	16	800							1.5		
	8	400	150-300			7.0	7.0	5.5	5.5		
	4	200									
60	16	800	50-300	2.0	2.0	2.0	2.0	1.5	1.5		
	8	400		4.0	4.0	3.5	3.5	3.0	3.0		
	4	200	50-300	8.0	8.0	7.0	7.0	6.0	5.5		
	16	800									

## RCP2 Combination Unit List for 3-axis Configuration (XYB+Z-axes, base mount) (□ in the model names indicates a value from 1 to 4 specifying the combination direction. For the combination directions, refer to P. 10.)

Page	Combination model	Combined shape	X axis					Y axis	
			Type	Motor size	Lead (mm)	Maximum speed (mm/sec)	Stroke (mm)	Type	
81	IK3-PBBG1□HHHS	XYB+Z, base mount	SS8R Reversed, single-slider	56□	20	220	50-1000	SA7R Reversed	
	IK3-PBBG1□HHMS								
	IK3-PBBG1□HHLS								
83	IK3-PBBG1□HHHD	XYB+Z, base mount	SS8R Reversed, double-slider	56□	20	220	50-800	SA7R Reversed	
	IK3-PBBG1□HHMD								
	IK3-PBBG1□HHLD								

## RCS2 Combination Unit List for 3-axis Configuration (XYB+Z-axes, base mount) (□ in the model names indicates a value from 1 to 4 specifying the combination direction. For the combination directions, refer to P. 10.)

Page	Combination model	Combined shape	X axis					Y axis	
			Type	Motor output (W)	Lead (mm)	Maximum speed (mm/sec)	Stroke (mm)	Type	
85	IK3-SBBG1□HHHS	XYB+Z, base mount	SS8R (100W) Reversed, single-slider	100	20	1000	50-1000	SA7R Reversed	
	IK3-SBBG1□HHMS								
	IK3-SBBG1□HHLS								
88	IK3-SBBG1□HHHD	XYB+Z, base mount	SS8R (100W) Reversed, double-slider	100	20	1000	50-800	SA7R Reversed	
	IK3-SBBG1□HHMD								
	IK3-SBBG1□HHLD								

# Tips on Selection

## 1. Differences between RCP2 and RCS2

### Features of RCP2

- [1] Adopting a pulse motor.
- [2] Characterized by high thrust at low speed.
- [3] Less expensive than the RCS2.



### Features of RCS2

- [1] Adopting a servo motor.
- [2] Able to operate at a constant thrust regardless of the speed.
- [3] Able to move at higher speeds than the RCP2.

## 2. Differences between X-axis Straight and Reversed Types

The X-axis reversed type can have a shorter dimension in the X-axis direction. When the 150-watt RCS2-SS8C (straight) and 150-watt SS8R (reversed) are compared, for example, the SS8R is shorter by 130 mm. Note, however, that the reversed type does not support configurations based on combination directions [3] and [4].

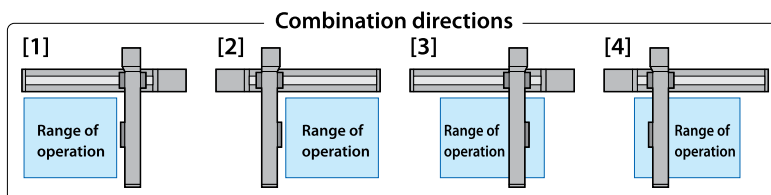
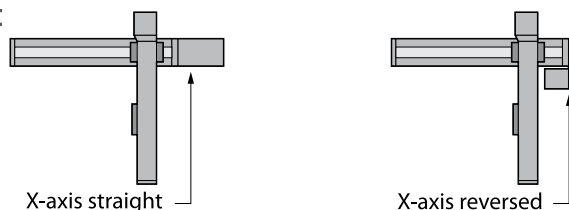

## 3. Differences between Single-slider and Double-slider Types

A double-slider consists of two sliders connected to each other and has a greater permissible load moment compared to a single-slider type. Accordingly, double-slider units are used as the X-axis in XY configurations with a long overhang. Note, however, that because the double-slider structure naturally has a longer slider section, a double-slider unit has a shorter stroke than a single-slider unit of the same total length.

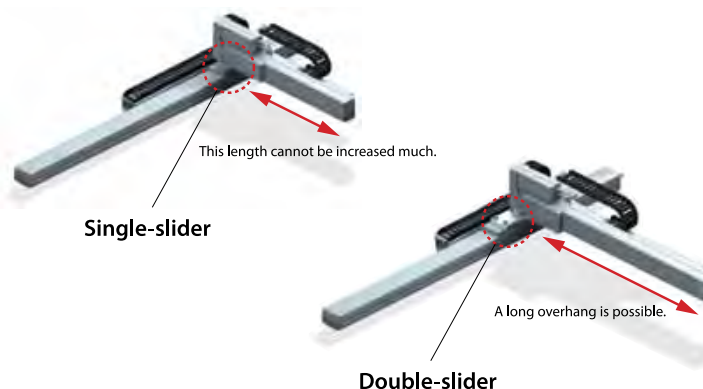

Y axis				Z axis				Load capacity by Y-axis stroke											
Motor size	Lead (mm)	Maximum speed (mm/sec)	Stroke (mm)	Type	Motor size	Lead (mm)	Maximum speed (mm/sec)	Stroke (mm)	50	100	150	200	250	300	350	400			
56□	16	420	50-300	SA6R Reversed	42□	12	500	50-200	1.0										
									2.0										
			4.0							1.0									
			350-400						6							2.0			
									3							4.0			
			6							250				1.0					
3							125				2.0								
											4.0								

Y axis				Z axis				Load capacity by Y-axis stroke											
Motor output (W)	Lead (mm)	Maximum speed (mm/sec)	Stroke (mm)	Type	Motor output (W)	Lead (mm)	Maximum speed (mm/sec)	Stroke (mm)	50	100	150	200	250	300	350	400			
60	16	800	50-300	SA6R Reversed	30	12	800	50-200	1.0										
									2.0										
			4.0							1.0									
			350-400						6							2.0			
									3							4.0			
			6							400				2.0					
3							200				4.0								

## Explanation of Items Comprising Model Name

### [IK Series, 2-axis combination unit]

IK2-□□□□□□-□□□□□□□□□□□□□□□□

[1] [2] [3] [4] [5] [6] [7] [8] [9] [10] [11] [14] [15] [16] [17] [18]

### [IK Series, 3-axis combination unit]

IK3-□□□□□□□□□□□□□□□□□□□□□□□□□□□□□□□□

[1] [2] [3] [4] [5] [6] [7] [8] [9] [10] [11] [12] [13] [14] [15] [16] [17] [18]

### [1] Axis configuration [2] Combined shape

Code	Model
P	RCP2
S	RCS2

Code	Combined shape	Name
XB	XYB	XY, base mount
XZ	XZ	Upright type
YB	YZB	Cross type, base mount
BB	XYB+ZB	XYB+Z, base mount

### [3] Configuration type

Code	Axis 1	Axis 2	Axis 3
A1	SS8R (150W)	SS8R (100W)	
A2	SS8C (150W)	SS8R (100W)	
B1	SS8R (100W)	SA7R	
B2	SS8C (100W)	SA7R	
C1	SS7R	SA6R	
C2	SS7C	SA6R	
D1	SS7R	SA5R	
D2	SS7C	SA5R	
G1	SS8R (100W)	SA7R	SA6R

### [4] Combination directions

XYB (XY, base mount) \*Only 1 and 2 are supported if the X-axis is of reversed type.

Code	1	2	3	4
Shape				

### XZ (Upright type)

Code	1	2	3	4
Shape				

### YZB (Cross type, base mount)

Code	1	2
Shape		

The combination directions supported by the 3-axis configuration (XYB+Z-axes, base mount) are the same as those of the XYB configuration shown above.

### [5] Speed type

Code	Type	
HH	High-speed	High-speed
HM	High-speed	Medium-speed
HL	High-speed	Low-speed
MM	Medium-speed	Medium-speed
HHH	High-speed	High-speed
HMM	High-speed	Medium-speed
HHL	High-speed	Low-speed

### [6] X-Axis Slider Type

Code	Type
S	Single
D	Double

### [7] Encoder Type

Code	Type
I	Incremental
A	Absolute

### [8] Axis 1 stroke (cm)

5:50mm-100:1000mm

(Can be set in 50-mm increments)

### [10] Axis 2 stroke (cm)

5:50mm-40:400mm

(Can be set in 50-mm increments)

### [12] Axis 3 stroke (cm)

5:50mm-20:200mm

(Can be set in 50-mm increments)

### [9] Axis 1 options

Code	Description
NM	Reversed-home specification
SR	Slider roller specification

### [11] Axis 2 options

Code	Description
B	Brake
NM	Reversed-home specification
SR	Slider roller specification

### [13] Axis 3 options

Code	Description
B	Brake
NM	Reversed-home specification
SR	Slider roller specification

Axis 1: Mount axis  
 Axis 2: Axis installed on axis 1  
 Axis 3: Axis 3: Axis installed on axis 2  
 Cable wiring 1: Wiring for axis 2  
 Cable wiring 2: Wiring for axis 3

### [14] Applicable controller

Code	Model
T1	XSEL-J/K
T2	SSEL, XSEL-P/Q
P1	PSEL, ROBOTNET

### [15] Cable length

Code	Description
1L	1m
3L	3m
5L	5m
□L	□m

### [16] Cable wiring 1

Code	Description
N	Cable only
CT	With cable track

### [17] Cable wiring 2

Code	Description
N	Cable only
CT	With cable track

### [18] Shipping configuration

Code	Description
K	Individual components (kit)

# Controller List

The IA kit supports the following controllers. For details on each controller, refer to the reference page describing the applicable controller.

	Exterior view	Features	Maximum number of positioning points	Input power supply	Reference page
<b>PCON</b>		A positioning controller for the RCP2 series. Pulse-train control and serial communication types are also available.	512	DC24V	Refer to the ROBO Cylinder General Catalog
<b>PSEL</b>		A program controller for the RCP2 series. Can be programmed using SEL language. 1-axis and 2-axis types are available.	1500	DC24V	P. 93
<b>SCON</b>		A positioning controller for the RCS2 series. Field networks are supported.	512	100 VAC Single-phase 200 VAC	Refer to the ROBO Cylinder General Catalog
<b>SSEL</b>		A program controller for the RCS2 series. Can be programmed using SEL language. 1-axis and 2-axis types are available.	1500	100 VAC Single-phase 200 VAC	P. 93
<b>ROBONET</b>		Able to operate 1 to 16 ROBO Cylinder axes via a field network. Less hassle of wiring and installation.	768	DC24V	P. 93
<b>XSEL-J/K</b>		For the RCS2 series. 3-axis and 4-axis configurations are supported. Two sets of 2-axis combination systems can be controlled. J type: Small size K type: Provides greater expandability because I/Os can be used.	3000	100 VAC Single-phase 200 VAC	P. 93
<b>XSEL-P/Q</b>		For the RCS2 series. 5-axis and 6-axis configurations are supported.	4000	Three-phase 200 VAC	P. 93



# OVER 30 YEARS OF IAI!

**E**STABLISHED IN 1976, IAI HAS GROWN GLOBALLY TO SERVE OVER 12 COUNTRIES. IAI HAS 24 REGIONAL OFFICES IN JAPAN AND IS PROUD TO ANNOUNCE A NEWLY CONSTRUCTED HEADQUARTERS, WITH AN ADJACENT STATE OF THE ART MANUFACTURING FACILITY TO PRODUCE THE HIGHEST QUALITY AUTOMATION ROBOTS. IAI IS CONSTANTLY STRIVING IN THE PURSUIT OF 'QUALITY AND INNOVATION.' OUR FOCUS IS ALWAYS ON THE NEEDS OF OUR CUSTOMERS AND TO OFFER HIGH QUALITY AND INNOVATIVE SOLUTIONS TAILORED FOR SPECIFIC CUSTOMER APPLICATIONS. IAI AMERICA INC. WAS ESTABLISHED IN 1989 TO BETTER SERVE THE NEEDS OF FACTORY AUTOMATION. WITH 3 MAIN OFFICES IN THE UNITED STATES, SUPPORT IS ALWAYS A PHONE CALL AWAY WHERE YOU CAN REACH EXPERIENCED TECHNICAL SUPPORT ENGINEERS.

FROM OUR EASY TO USE SOFTWARE, TO COMPLETE AUTOMATION SOLUTIONS, WE PROVIDE YOU WITH THE TOOLS NECESSARY TO SCALE YOUR BUSINESS. WHEN YOU DEMAND INNOVATIVE AND HIGH QUALITY ROBOTS, EXCELLENT SERVICE AND SUPPORT FOR YOUR UNIQUE NEEDS, DEMAND IAI!



#### IAI Headquarters

On the windows of the newly constructed headquarters spell out the character for 'heart' in Japanese. This character is rich and meaningful, symbolizing the heart, spirit, attention and sincerity of IAI's commitment to the users of IAI products.

#### ISO 9001:2000

IAI has been certified for ISO 9001:2000 and JIS Q9001:2000 by an independent auditor to be in conformance with ISO 9001:2000 and JIS 9001:2000. We at IAI are continually improving our methods to produce quality products and services that surpass customer expectations.



#### RoHS Compliant

IAI is RoHS compliant and recognizes the responsibility in reducing hazardous substances to better serve our customers and our environment.



# IK2-PXBD1□□S

RCP2 2-axis Combinations X axis: SS7R (Reversed, Single-slider)  
Y axis: SA5R (Reversed)

**Model Details** Series — Type — Encoder type — Axis 1 (X axis) — Axis 2 (Y axis) — Controllers — Cable — Shipping configuration

**IK2** — **PXBD1**□□**S** — □ — □ □ □ □ — **P1** — □ — □ — □ — □

**Combination directions** 1-2

**Differences between Single-slider and Double-slider Types**  
HH: X high-speed, Y high-speed  
HM: X high-speed, Y medium-speed

**Encoder type** I: Incremental

**Stroke (mm)** 5: 50mm  
(Can be set in 50-mm increments)

**Options**  
NM: Opposite-home specification  
SR: Slider roller specification

**Cable length**  
1L: 1m  
3L: 3m  
5L: 5m  
□L: □m

**Wiring 1** N: Cable only

**Wiring 2** CT: With cable track

**Shipping configuration** K: Individual components (kit)

\* Refer to P. 10 for details on the items comprising the model name.

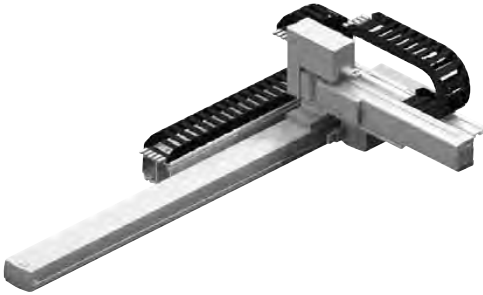

Both wiring 1 and wiring 2 assume use of a cable track.

**Maximum Stroke**

X axis 600 mm

Y axis 200 mm

**Maximum Speed (High-speed type)**

X axis 400 mm/s

Y axis 600 mm/s

**Maximum Load Capacity**

Y-axis stroke	X high-speed, Y high-speed	X high-speed, Y medium-speed
50mm	3.0kg	6.0kg
100mm	3.0kg	6.0kg
150mm	2.5kg	5.0kg
200mm	2.5kg	5.0kg

**List of Options**

Name	Option code
Opposite-home specification	NM
Slider roller specification	SR

**Specifications**

Item	X axis	Y axis
Axis model	RCP2-SS7R	RCP2-SA5R
Stroke (Can be set in 50-mm increments)	50-600mm	50-200mm
Max speed	HH type: 400mm/s HM type: 350mm/s	High-speed type: 600mm/s Medium-speed type: 300mm/s
Motor size	42-square pulse motor	
Ball screw lead	High-speed type: 12mm	High-speed type: 12mm Medium-speed type: 6mm
Drive method	Ball screw, ø10 mm, rolled, C10	
Positioning repeatability	±0.02mm	
Base material	Dedicated alloy steel	Aluminum
Surrounding air temperature/humidity	0 to 40°C, 85% RH or below (non-condensing)	

Note 1. The connected position shown in the drawing defines the home.  
 Note 2. Both wiring 1 and wiring 2 assume use of a cable track.  
 Note 3. For details on the cable track, refer to P.90.  
 Note 4. For details on the bracket on the moving end of the cable track, refer to P. 90.

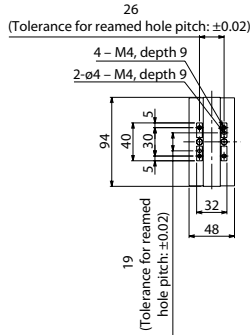
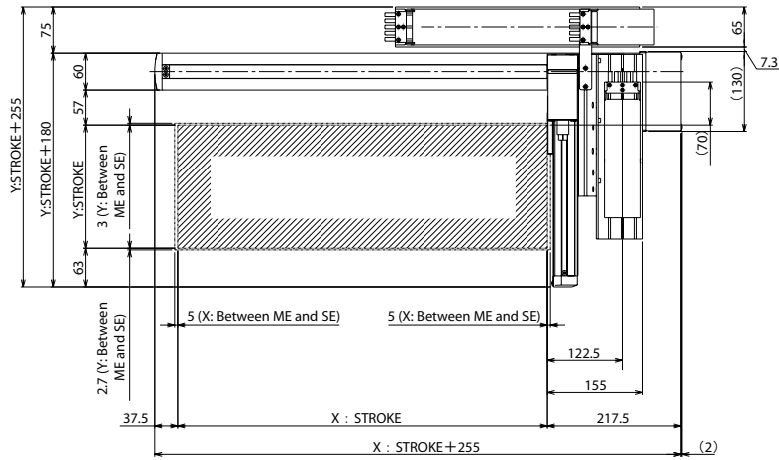
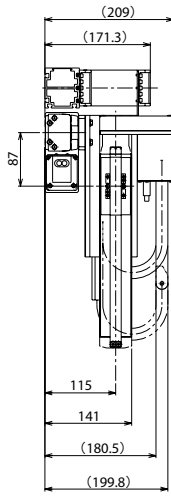

ME: Mechanical end  
 SE: Stroke end

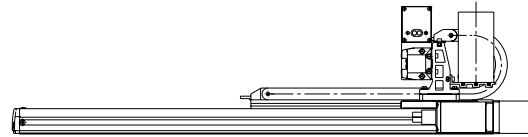

Detail view of Y-axis slider

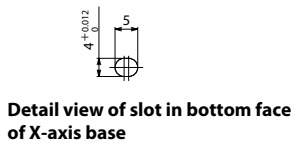

Detail view of slot in bottom face of X-axis base

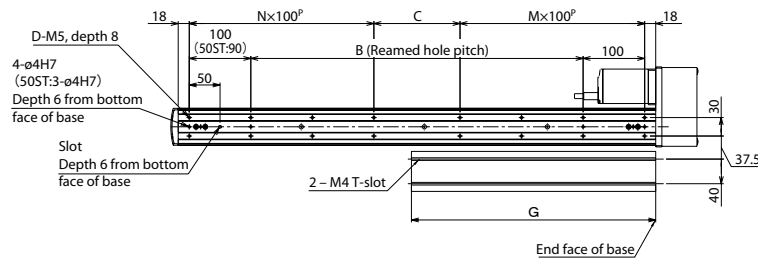

**■ Dimensions by Stroke**

X: Model	50	100	150	200	250	300	350	400	450	500	550	600
B	0	40	90	140	190	240	290	340	390	440	490	540
C	90	40	90	140	190	40	90	140	190	40	90	140
D	6	8	8	8	8	12	12	12	12	16	16	16
M	1	1	1	1	1	2	2	2	2	3	3	3
N	0	1	1	1	1	2	2	2	2	3	3	3
G	122	147	172	197	222	247	272	297	322	347	372	397

## Controllers

Applicable controller

Refer to P. 91 for the controllers.

# IK2-PXBD1□□D

RCP2 2-axis Combinations X axis: SS7R (Reversed, Double-slider) Y axis: SA5R (Reversed)

**Model Details** Series — Type — Encoder type — Axis 1 (X axis) — Axis 2 (Y axis) — Controllers — Cable — Shipping configuration

**IK2** — **PXBD1**□□**D** — □ — □ — □ — □ — **P1** — □ — □ — □ — □

**Combination directions** 1-2  
**Differences between Single-slider and Double-slider Types**  
 HH: X high-speed, Y high-speed  
 HM: X high-speed, Y medium-speed

**Encoder type** I: Incremental

**Stroke (mm)** 5: 50mm  
 ? (Can be set in 50-mm increments)

**Options**  
 NM: Opposite-home specification  
 SR: Slider roller specification

**Cable length**  
 1L: 1m  
 3L: 3m  
 5L: 5m  
 □L: □m

**Wiring 1** N: Cable only  
**Wiring 2** CT: With cable track

**Shipping configuration** K: Individual components (kit)

\* Refer to P. 10 for details on the items comprising the model name.

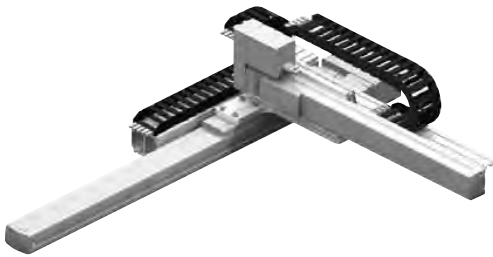

**Maximum Stroke**

X axis 450 mm      Y axis 400 mm

**Maximum Speed (High-speed type)**

X axis 400 mm/s      Y axis 600 mm/s

**Maximum Load Capacity**

Y-axis stroke	X high-speed, Y high-speed	X high-speed, Y medium-speed
250mm	2.5kg	5.0kg
300mm	2.0kg	4.0kg
350mm	2.0kg	4.0kg
400mm	2.0kg	4.0kg

Both wiring 1 and wiring 2 assume use of a cable track.

**List by Stroke**

		Incremental			
Y-axis stroke		250	300	350	400
X-axis stroke	50	-	-	-	-
	100	-	-	-	-
	150	-	-	-	-
	200	-	-	-	-
	250	-	-	-	-
	300	-	-	-	-
	350	-	-	-	-
	400	-	-	-	-
	450	-	-	-	-

**Cable track**

Wiring 1 (Next to X-axis)	X-axis stroke	50-300	350-450
		-	-
Wiring 2 (Next to Y-axis)	Y-axis stroke	250-400	-
		-	-

**List by Cable Length**

Type	Cable code	Length
Standard type	1L	1m
	3L	3m
	5L	5m

\* Axis 1 comes with a standard cable, while axis 2 comes with a robot cable.

\* Refer to P. 90 for lengths other than those specified above.

**List of Options**

Name	Option code	-
Opposite-home specification	NM	-
Slider roller specification	SR	Axis 1 (X-axis) Axis 2 (Y-axis)

**Specifications**

Item	X axis	Y axis
Axis model	RCP2-SS7R	RCP2-SA5R
Stroke (Can be set in 50-mm increments)	50-450mm	250-400mm
Max speed	HH type: 400mm/s HM type: 350mm/s	High-speed type: 600mm/s Medium-speed type: 300mm/s
Motor size	42-square pulse motor	
Ball screw lead	High-speed type: 12mm	High-speed type: 12mm Medium-speed type: 6mm
Drive method	Ball screw, ø10 mm, rolled, C10	
Positioning repeatability	±0.02mm	
Base material	Dedicated alloy steel	Aluminum
Surrounding air temperature/humidity	0 to 40°C, 85% RH or below (non-condensing)	

15

IK2-PXBD1□□D



Note 1. The connected position shown in the drawing defines the home.  
 Note 2. Both wiring 1 and wiring 2 assume use of a cable track.  
 Note 3. For details on the cable track, refer to P.90.  
 Note 4. For details on the bracket on the moving end of the cable track, refer to P.90.

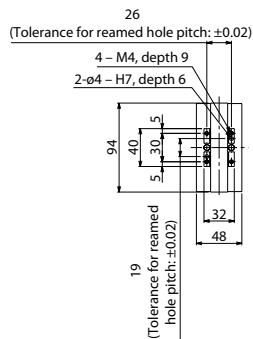
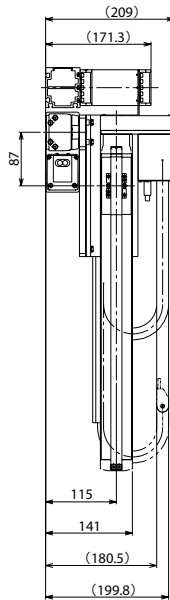

Detail view of Y-axis slider



Detail view of slot in bottom face of X-axis base

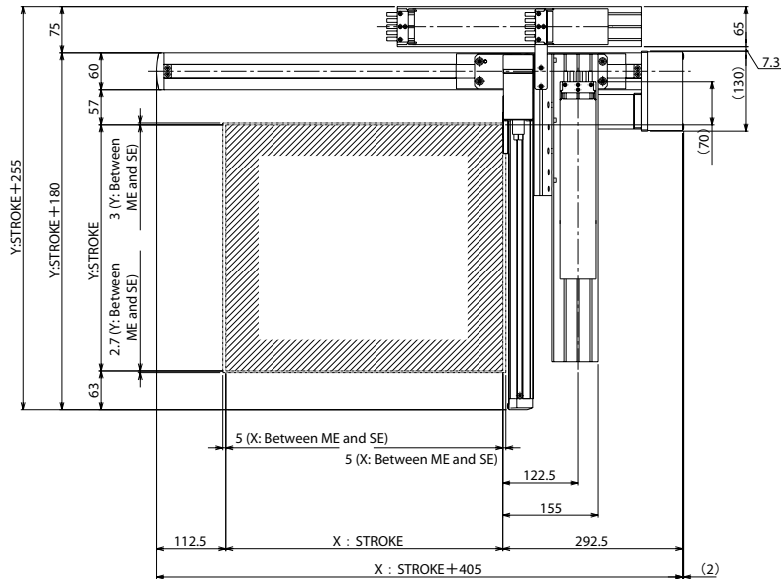

ME: Mechanical end  
 SE: Stroke end

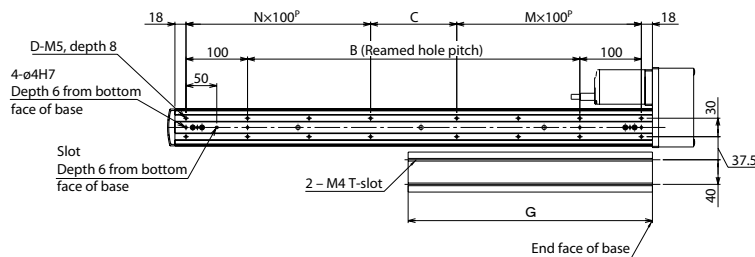
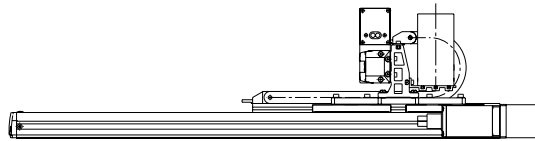

Detail view of X-axis installation

■ Dimensions by Stroke

X: Nominal stroke	200	250	300	350	400	450	500	550	600
X: Effective stroke	50	100	150	200	250	300	350	400	450
B	140	190	240	290	340	390	440	490	540
C	140	190	40	90	140	190	40	90	140
D	8	8	12	12	12	12	16	16	16
M	1	1	2	2	2	2	3	3	3
N	1	1	2	2	2	2	3	3	3
G	197	222	247	272	297	322	347	372	397

## Controllers

Applicable controller

☞ Refer to P. 91 for the controllers.

# IK2-PXBD2□□S

RCP2 2-axis Combinations X axis: SS7C (Straight, Single-slider)  
Y axis: SA5R (Reversed)

**Model Details** Series — Type — Encoder type — Axis 1 (X-axis) — Axis 2 (Y-axis) — Controllers — Cable — Shipping configuration

**IK2** — **PXBD2**□□**S** — □ — □ — □ — □ — **P1** — □ — □ — □ — □

**Combination directions** 1-4  
**Differences between Single-slider and Double-slider Types**  
HH: X high-speed, Y high-speed  
HM: X high-speed, Y medium-speed

**Encoder type** I: Incremental

**Stroke (mm)**  
5: 50mm  
? (Can be set in 50-mm increments)

**Options**  
NM: Opposite-home specification  
SR: Slider roller specification

**Cable length**  
1L: 1m  
3L: 3m  
5L: 5m  
□L: □m

**Wiring 1** N: Cable only  
**Wiring 2** CT: With cable track

**Shipping configuration** K: Individual components (kit)

\* Refer to P. 10 for details on the items comprising the model name.

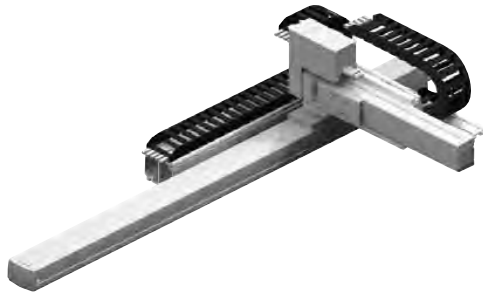

**Maximum Stroke**

X axis 600 mm      Y axis 200 mm

**Maximum Speed (High-speed type)**

X axis 400 mm/s      Y axis 600 mm/s

**Maximum Load Capacity**

Y-axis stroke	X high-speed, Y high-speed	X high-speed, Y medium-speed
50mm	3.0kg	6.0kg
100mm	3.0kg	6.0kg
150mm	2.5kg	5.0kg
200mm	2.5kg	5.0kg

Both wiring 1 and wiring 2 assume use of a cable track.

**List by Stroke**

Y-axis stroke	Incremental			
	50	100	150	200
50	-	-	-	-
100	-	-	-	-
150	-	-	-	-
200	-	-	-	-
250	-	-	-	-
300	-	-	-	-
350	-	-	-	-
400	-	-	-	-
450	-	-	-	-
500	-	-	-	-
550	-	-	-	-
600	-	-	-	-

**Cable track**

Wiring 1 (Next to X-axis)	X-axis stroke	50-300	350-600
		-	-
Wiring 2 (Next to Y-axis)	Y-axis stroke	50-200	-
		-	-

**List by Cable Length**

Type	Cable code	Length
Standard type	1L	1m
	3L	3m
	5L	5m

\* Axis 1 comes with a standard cable, while axis 2 comes with a robot cable.

\* Refer to P. 90 for lengths other than those specified above.

**List of Options**

Name	Option code	
Opposite-home specification	NM	
Slider roller specification	SR	Axis 1 (X-axis) Axis 2 (Y-axis)

**Specifications**

Item	X axis	Y axis
Axis model	RCP2-SS7C	RCP2-SA5R
Stroke (Can be set in 50-mm increments)	50-600mm	50-200mm
Max speed	HH type: 400mm/s HM type: 350mm/s	High-speed type: 600mm/s Medium-speed type: 300mm/s
Motor size	42-square pulse motor	
Ball screw lead	High-speed type: 12mm	High-speed type: 12mm Medium-speed type: 6mm
Drive method	Ball screw, ø10 mm, rolled, C10	
Positioning repeatability	±0.02mm	
Base material	Dedicated alloy steel	Aluminum
Surrounding air temperature/humidity	0 to 40°C, 85% RH or below (non-condensing)	

17 IK2-PXBD2□□S

Dimensions

Note 1. The connected position shown in the drawing defines the home.  
 Note 2. Both wiring 1 and wiring 2 assume use of a cable track.  
 Note 3. For details on the cable track, refer to P. 90.  
 Note 4. For details on the bracket on the moving end of the cable track, refer to P. 90.

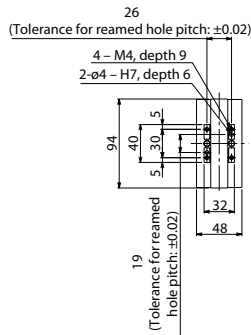
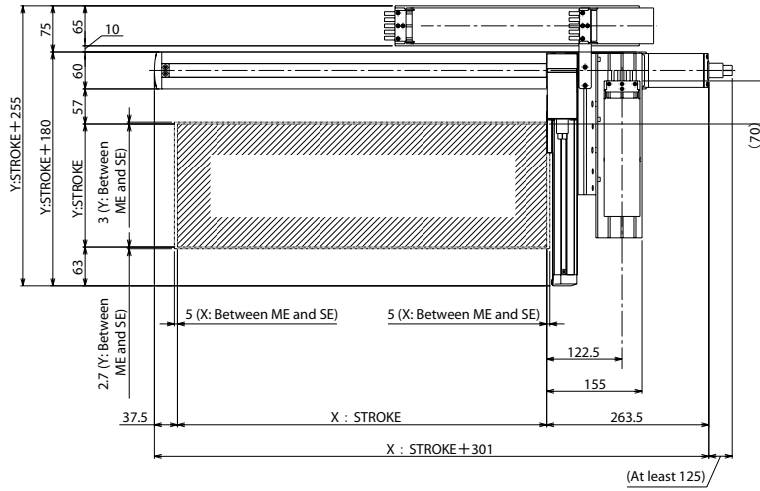
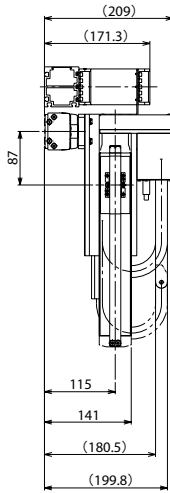

Detail view of Y-axis slider

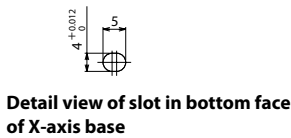

Detail view of slot in bottom face of X-axis base

ME: Mechanical end  
 SE: Stroke end

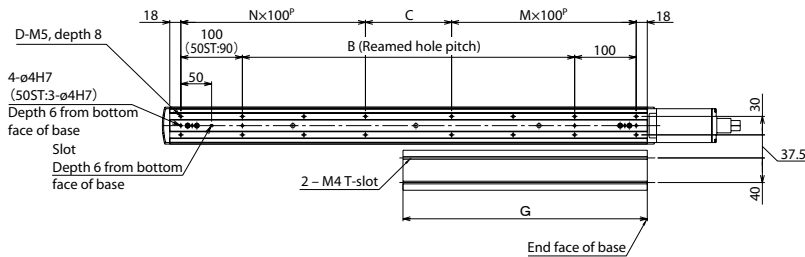
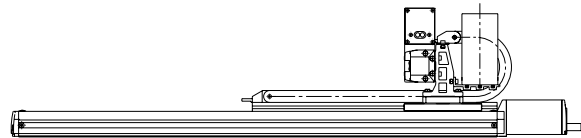

Detail view of X-axis installation

Dimensions by Stroke

X: Model	50	100	150	200	250	300	350	400	450	500	550	600
B	0	40	90	140	190	240	290	340	390	440	490	540
C	90	40	90	140	190	40	90	140	190	40	90	140
D	6	8	8	8	8	12	12	12	12	16	16	16
M	1	1	1	1	1	2	2	2	2	3	3	3
N	0	1	1	1	1	2	2	2	2	3	3	3
G	122	147	172	197	222	247	272	297	322	347	372	397

Controllers

Applicable controller

Refer to P. 91 for the controllers.

# IK2-PXBD2□□D

RCP2 2-axis Combinations X axis: SS7C (Straight, Double-slider) Y axis: SA5R (Reversed)

**Model Details** Series — Type — Encoder type — Axis 1 (X axis) — Axis 2 (Y axis) — Controllers — Cable — Shipping configuration

**IK2** — **PXBD2**□□**D** — □ — □ — □ — □ — **P1** — □ — □ — □ — □

**Combination directions** 1-4  
**Differences between Single-slider and Double-slider Types**  
 HH: X high-speed, Y high-speed  
 HM: X high-speed, Y medium-speed

**Encoder type** I: Incremental

**Stroke (mm)** 5: 50mm  
 ? (Can be set in 50-mm increments)

**Options**  
 NM: Opposite-home specification  
 SR: Slider roller specification

**Cable length**  
 1L: 1m  
 3L: 3m  
 5L: 5m  
 □L: □m

**Wiring 1** N: Cable only  
**Wiring 2** CT: With cable track

**Shipping configuration** K: Individual components (kit)

\* Refer to P. 10 for details on the items comprising the model name.

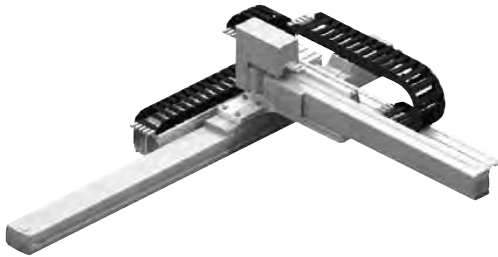

**Maximum Stroke**

X axis 450 mm      Y axis 400 mm

**Maximum Speed (High-speed type)**

X axis 400 mm/s      Y axis 600 mm/s

**Maximum Load Capacity**

Y-axis stroke	X high-speed, Y high-speed	X high-speed, Y medium-speed
250mm	2.5kg	5.0kg
300mm	2.0kg	4.0kg
350mm	2.0kg	4.0kg
400mm	2.0kg	4.0kg

Both wiring 1 and wiring 2 assume use of a cable track.

**List by Stroke**

		Incremental			
Y-axis stroke		250	300	350	400
X-axis stroke	50	-	-	-	-
	100	-	-	-	-
	150	-	-	-	-
	200	-	-	-	-
	250	-	-	-	-
	300	-	-	-	-
	350	-	-	-	-
	400	-	-	-	-
	450	-	-	-	-

**Cable track**

Wiring 1 (Next to X-axis)	X-axis stroke	50-300	350-450
		-	-
Wiring 2 (Next to Y-axis)	Y-axis stroke	250-400	-
		-	-

**List by Cable Length**

Type	Cable code	Length
Standard type	1L	1m
	3L	3m
	5L	5m

\* Axis 1 comes with a standard cable, while axis 2 comes with a robot cable.

\* Refer to P. 90 for lengths other than those specified above.

**List of Options**

Name	Option code	
Opposite-home specification	NM	
Slider roller specification	SR	Axis 1 (X-axis) Axis 2 (Y-axis)

**Specifications**

Item	X axis	Y axis
Axis model	RCP2-SS7C	RCP2-SA5R
Stroke (Can be set in 50-mm increments)	50-450mm	250-400mm
Max speed	HH type: 400mm/s HM type: 350mm/s	High-speed type: 600mm/s Medium-speed type: 300mm/s
Motor size	42-square pulse motor	
Ball screw lead	High-speed type: 12mm	High-speed type: 12mm Medium-speed type: 6mm
Drive method	Ball screw, ø10 mm, rolled, C10	
Positioning repeatability	±0.02mm	
Base material	Dedicated alloy steel	Aluminum
Surrounding air temperature/humidity	0 to 40°C, 85% RH or below (non-condensing)	

19

IK2-PXBD2□□D

Note 1. The connected position shown in the drawing defines the home.  
 Note 2. Both wiring 1 and wiring 2 assume use of a cable track.  
 Note 3. For details on the cable track, refer to P.90.  
 Note 4. For details on the bracket on the moving end of the cable track, refer to P.90.

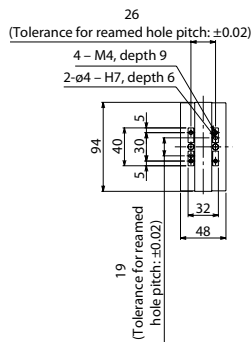
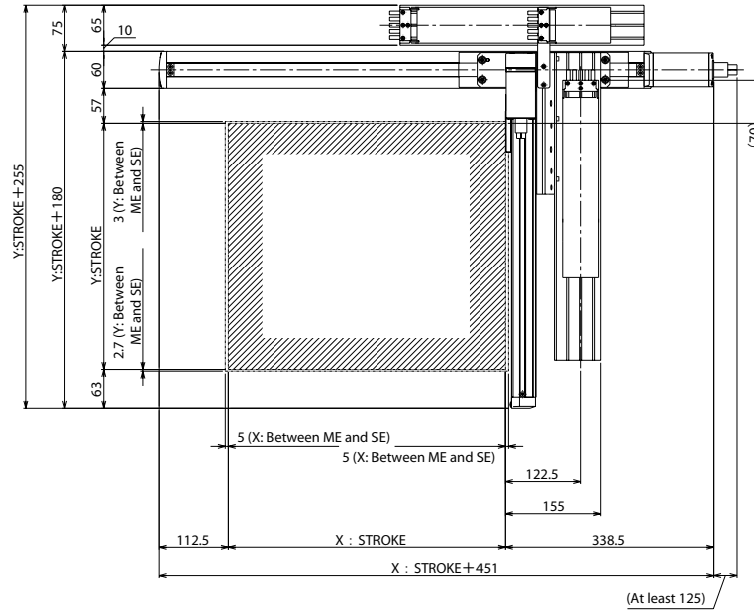
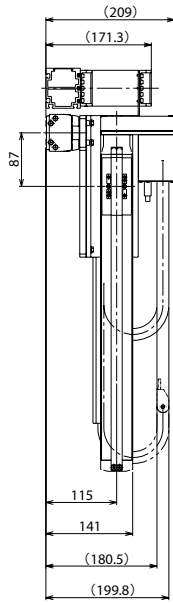

Detail view of Y-axis slider

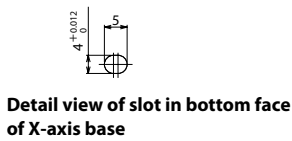

Detail view of slot in bottom face of X-axis base

ME: Mechanical end  
 SE: Stroke end

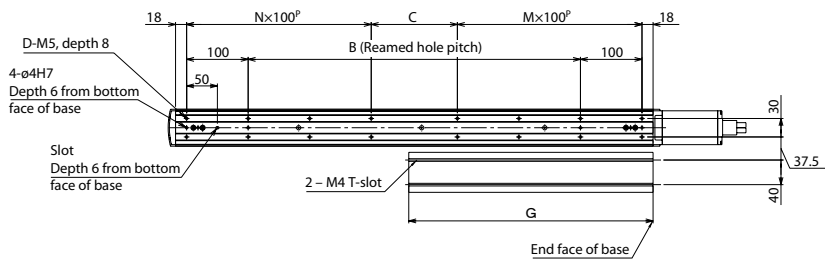
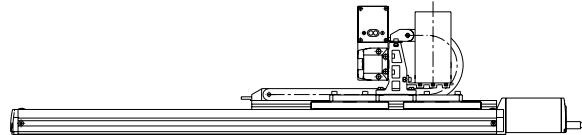

Detail view of X-axis installation

■ Dimensions by Stroke

X: Nominal stroke	200	250	300	350	400	450	500	550	600
X: Effective stroke	50	100	150	200	250	300	350	400	450
B	140	190	240	290	340	390	440	490	540
C	140	190	40	90	140	190	40	90	140
D	8	8	12	12	12	12	16	16	16
M	1	1	2	2	2	2	3	3	3
N	1	1	2	2	2	2	3	3	3
G	197	222	247	272	297	322	347	372	397

## Controllers

Applicable controller

☞ Refer to P. 91 for the controllers.

# IK2-PXBC1□□S

RCP2 2-axis Combinations X axis: SS7R (Reversed, Single-slider) Y axis: SA5R (Reversed)

**Model Details** Series — Type — Encoder type — Axis 1 (X axis) — Axis 2 (Y axis) — Controllers — Cable — Shipping configuration

**IK2** — **PXBC1**□□**S** — □ — □ — □ — □ — **P1** — □ — □ — □ — □

**Combination directions** 1-2

**Differences between Single-slider and Double-slider Types**  
 HH: X high-speed, Y high-speed  
 HM: X high-speed, Y medium-speed

**Encoder type** I: Incremental

**Stroke (mm)**  
 5: 50mm  
 ? (Can be set in 50-mm increments)

**Options**  
 NM: Opposite-home specification  
 SR: Slider roller specification

**Cable length**  
 1L: 1m  
 3L: 3m  
 5L: 5m  
 □L: □m

**Wiring 1** N: Cable only  
**Wiring 2** CT: With cable track

**Shipping configuration** K: Individual components (kit)

\* Refer to P. 10 for details on the items comprising the model name.



**Maximum Stroke**

X axis 600 mm      Y axis 200 mm

**Maximum Speed (High-speed type)**

X axis 400 mm/s      Y axis 600 mm/s

**Maximum Load Capacity**

Y-axis stroke	X high-speed, Y high-speed	X high-speed, Y medium-speed
50mm	4.5kg	9.0kg
100mm	4.5kg	9.0kg
150mm	4.0kg	8.0kg
200mm	3.0kg	6.0kg

Both wiring 1 and wiring 2 assume use of a cable track.

**List by Stroke**

		Incremental			
Y-axis stroke		50	100	150	200
X-axis stroke	50	-	-	-	-
	100	-	-	-	-
	150	-	-	-	-
	200	-	-	-	-
	250	-	-	-	-
	300	-	-	-	-
	350	-	-	-	-
	400	-	-	-	-
	450	-	-	-	-
	500	-	-	-	-
	550	-	-	-	-
600	-	-	-	-	

**Cable track**

Wiring 1 (Next to X-axis)	X-axis stroke	50-300	350-600
			-
Wiring 2 (Next to Y-axis)	Y-axis stroke	50-200	-
			-

**List of Cable Length**

Type	Cable code	Length
Standard type	1L	1m
	3L	3m
	5L	5m

\* Axis 1 comes with a standard cable, while axis 2 comes with a robot cable.

\* Refer to P. 90 for lengths other than those specified above.

**List of Options**

Name	Option code	
Opposite-home specification	NM	
Slider roller specification	SR	Axis 1 (X-axis) Axis 2 (Y-axis)

**Specifications**

Item	X axis	Y axis
Axis model	RCP2-SS7R	RCP2-SA6R
Stroke (Can be set in 50-mm increments)	50-600mm	50-200mm
Max speed	HH type: 400mm/s HM type: 250mm/s	High-speed type: 600mm/s Medium-speed type: 300mm/s
Motor size	42-square pulse motor	
Ball screw lead	High-speed type: 12mm	High-speed type: 12mm Medium-speed type: 6mm
Drive method	Ball screw, ø10 mm, rolled, C10	
Positioning repeatability	±0.02mm	
Base material	Dedicated alloy steel	Aluminum
Surrounding air temperature/humidity	0 to 40°C, 85% RH or below (non-condensing)	

21

IK2-PXBC1□□S

Dimensions

Note 1. The connected position shown in the drawing defines the home.  
 Note 2. Both wiring 1 and wiring 2 assume use of a cable track.  
 Note 3. For details on the cable track, refer to P.90.  
 Note 4. For details on the bracket on the moving end of the cable track, refer to P.90.

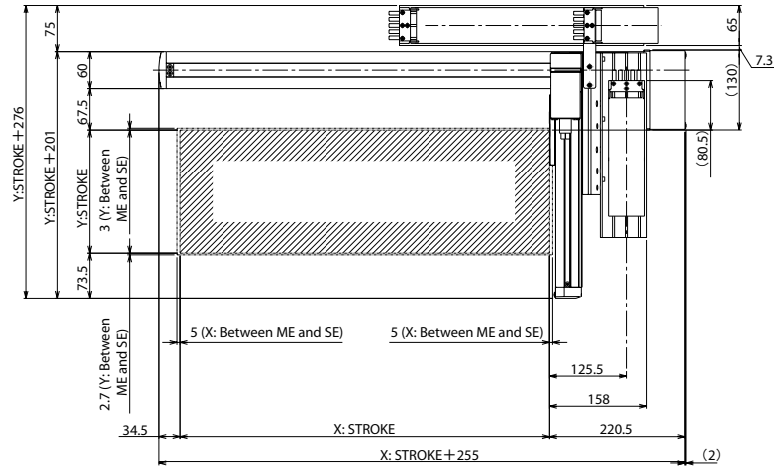
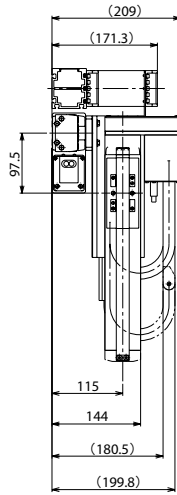

ME: Mechanical end  
 SE: Stroke end

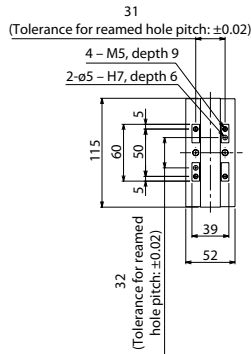

Detail view of Y-axis slider

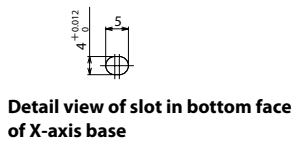

Detail view of slot in bottom face of X-axis base

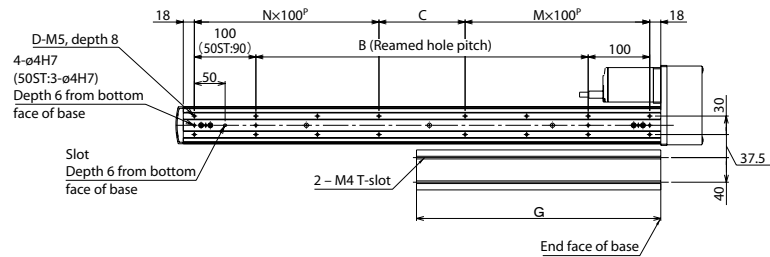

Detail view of X-axis installation

■ Dimensions by Stroke

X: Model	50	100	150	200	250	300	350	400	450	500	550	600
B	0	40	90	140	190	240	290	340	390	440	490	540
C	90	40	90	140	190	40	90	140	190	40	90	140
D	6	8	8	8	8	12	12	12	12	16	16	16
M	1	1	1	1	1	2	2	2	2	3	3	3
N	0	1	1	1	1	2	2	2	2	3	3	3
G	122	147	172	197	222	247	272	297	322	347	372	397

Controllers

Applicable controller

☞ Refer to P. 91 for the controllers.

2-axis  
Combinations  
R C P 2

2-axis  
Combinations  
R C S 2

3-axis  
Combinations  
R C P 2

3-axis  
Combinations  
R C S 2

Controllers

# IK2-PXBC1□□D

RCP2 2-axis Combinations X axis: SS7R (Reversed, Double-slider) Y axis: SA5R (Reversed)

**Model Details** Series — Type — Encoder type — Axis 1 (X axis) — Axis 2 (Y axis) — Controllers — Cable — Shipping configuration

**IK2** — **PXBC1**□□**D** — □ — □ — □ — □ — **P1** — □ — □ — □ — □

**Combination directions** 1-2

**Differences between Single-slider and Double-slider Types**  
 HH: X high-speed, Y high-speed  
 HM: X high-speed, Y medium-speed

**Encoder type** I: Incremental

**Stroke (mm)** 5: 50mm  
 ? (Can be set in 50-mm increments)

**Options**  
 NM: Opposite-home specification  
 SR: Slider roller specification

**Cable length**  
 1L: 1m  
 3L: 3m  
 5L: 5m  
 □L: □m

**Wiring 1** N: Cable only  
**Wiring 2** CT: With cable track

**Shipping configuration** K: Individual components (kit)

\* Refer to P. 10 for details on the items comprising the model name.

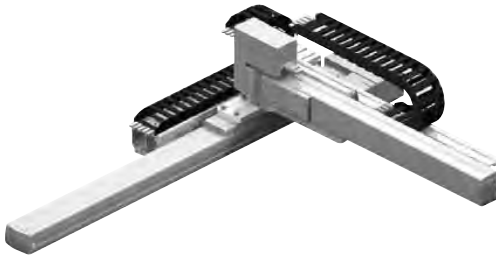

**Maximum Stroke**

X axis 450 mm      Y axis 400 mm

**Maximum Speed (High-speed type)**

X axis 400 mm/s      Y axis 600 mm/s

**Maximum Load Capacity**

Y-axis stroke	X high-speed, Y high-speed	X high-speed, Y medium-speed
250mm	3.0kg	6.0kg
300mm	3.0kg	6.0kg
350mm	3.0kg	6.0kg
400mm	3.0kg	6.0kg

Both wiring 1 and wiring 2 assume use of a cable track.

**List by Stroke**

		Incremental			
Y-axis stroke		250	300	350	400
X-axis stroke	50	-	-	-	-
	100	-	-	-	-
	150	-	-	-	-
	200	-	-	-	-
	250	-	-	-	-
	300	-	-	-	-
	350	-	-	-	-
	400	-	-	-	-
	450	-	-	-	-

**Cable track**

Wiring 1 (Next to X-axis)	X-axis stroke	50-300	350-450
			-
Wiring 2 (Next to Y-axis)	Y-axis stroke	250-400	-
			-

**List by Cable Length**

Type	Cable code	Length
Standard type	1L	1m
	3L	3m
	5L	5m

\* Axis 1 comes with a standard cable, while axis 2 comes with a robot cable.

\* Refer to P. 90 for lengths other than those specified above.

**List of Options**

Name	Option code	
Opposite-home specification	NM	
Slider roller specification	SR	Axis 1 (X-axis) Axis 2 (Y-axis)

**Specifications**

Item	X axis	Y axis
Axis model	RCP2-SS7R	RCP2-SA6R
Stroke (Can be set in 50-mm increments)	50-450mm	250-400mm
Max speed	HH type: 400mm/s HM type: 250mm/s	High-speed type: 600mm/s Medium-speed type: 300mm/s
Motor size	42-square pulse motor	
Ball screw lead	High-speed type: 12mm	High-speed type: 12mm Medium-speed type: 6mm
Drive method	Ball screw, ø10 mm, rolled, C10	
Positioning repeatability	±0.02mm	
Base material	Dedicated alloy steel	Aluminum
Surrounding air temperature/humidity	0 to 40°C, 85% RH or below (non-condensing)	

23

IK2-PXBC1□□D



Note 1. The connected position shown in the drawing defines the home.  
 Note 2. Both wiring 1 and wiring 2 assume use of a cable track.  
 Note 3. For details on the cable track, refer to P. 90.  
 Note 4. For details on the bracket on the moving end of the cable track, refer to P. 90.

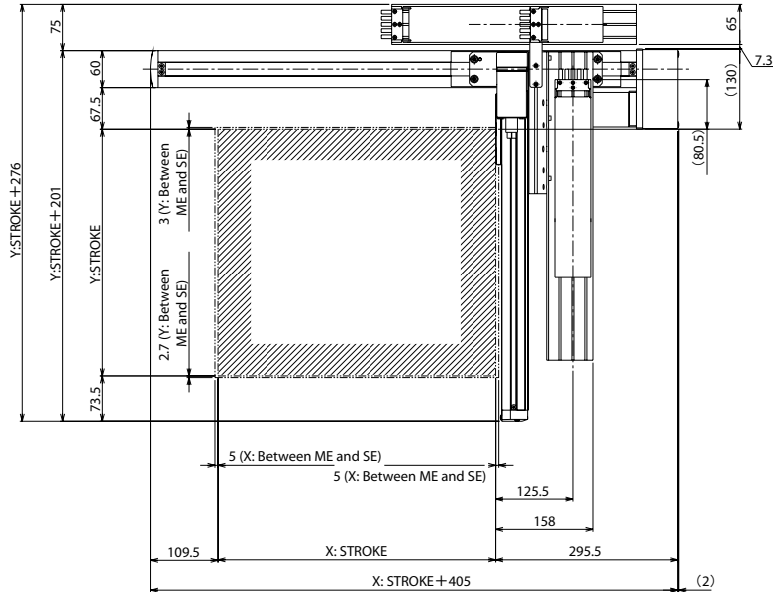
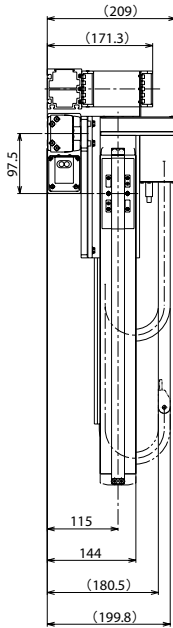

31  
(Tolerance for reamed hole pitch: ±0.02)

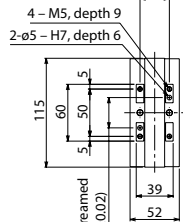

Detail view of Y-axis slider



Detail view of slot in bottom face of X-axis base

ME: Mechanical end  
SE: Stroke end

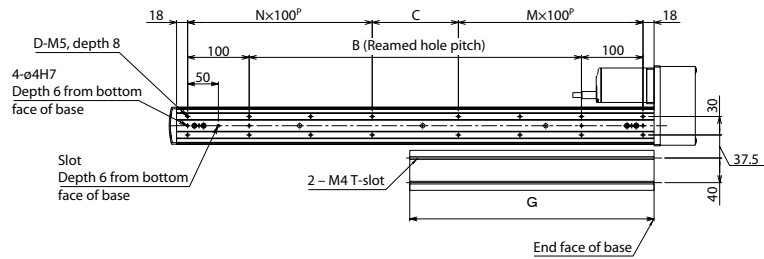
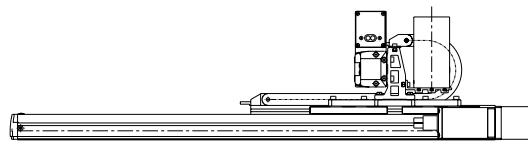

Detail view of X-axis installation

■ Dimensions by Stroke

X: Nominal stroke	200	250	300	350	400	450	500	550	600
X: Effective stroke	50	100	150	200	250	300	350	400	450
B	140	190	240	290	340	390	440	490	540
C	140	190	40	90	140	190	40	90	140
D	8	8	12	12	12	12	16	16	16
M	1	1	2	2	2	2	3	3	3
N	1	1	2	2	2	2	3	3	3
G	197	222	247	272	297	322	347	372	397

## Controllers

Applicable controller

Refer to P. 91 for the controllers.

# IK2-PXBC2□□S

RCP2 2-axis Combinations X axis: SS7C (Straight, Single-slider)  
Y axis: SA6R (Reversed)

**Model Details** Series — Type — Encoder type — Axis 1 (X axis) — Axis 2 (Y axis) — Controllers — Cable — Shipping configuration

**IK2** — **PXBC2**□□**S** — □ — □ — □ — □ — **P1** — □ — □ — □ — □

**Combination directions** 1-4  
**Differences between Single-slider and Double-slider Types**  
HH: X high-speed, Y high-speed  
HM: X high-speed, Y medium-speed

**Encoder type** I: Incremental

**Stroke (mm)** 5: 50mm  
(Can be set in 50-mm increments)

**Options**  
NM: Opposite-home specification  
SR: Slider roller specification

**Cable length**  
1L: 1m  
3L: 3m  
5L: 5m  
□L: □m

**Wiring 1** N: Cable only  
**Wiring 2** CT: With cable track

**Shipping configuration** K: Individual components (kit)

\* Refer to P. 10 for details on the items comprising the model name.

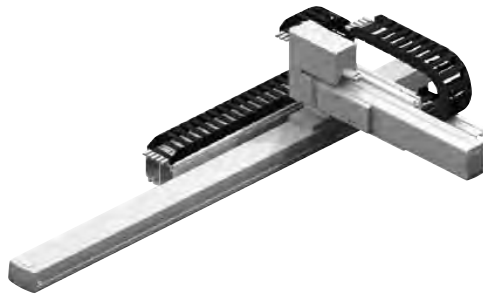

Both wiring 1 and wiring 2 assume use of a cable track.

**Maximum Stroke**

X axis 600 mm      Y axis 200 mm

**Maximum Speed (High-speed type)**

X axis 400 mm/s      Y axis 600 mm/s

**Maximum Load Capacity**

Y-axis stroke	X high-speed, Y high-speed	X high-speed, Y medium-speed
50mm	4.5kg	9.0kg
100mm	4.5kg	9.0kg
150mm	4.0kg	8.0kg
200mm	3.0kg	6.0kg

**List by Stroke**

Y-axis stroke	Incremental			
	50	100	150	200
50	-	-	-	-
100	-	-	-	-
150	-	-	-	-
200	-	-	-	-
250	-	-	-	-
300	-	-	-	-
350	-	-	-	-
400	-	-	-	-
450	-	-	-	-
500	-	-	-	-
550	-	-	-	-
600	-	-	-	-

**Cable track**

Wiring	Stroke	50-300	350-600
Wiring 1 (Next to X-axis)	X-axis stroke	50-300	350-600
Wiring 2 (Next to Y-axis)	Y-axis stroke	50-200	-

**List by Cable Length**

Type	Cable code	Length
Standard type	1L	1m
	3L	3m
	5L	5m

\* Axis 1 comes with a standard cable, while axis 2 comes with a robot cable.  
\* Refer to P. 90 for lengths other than those specified above.

**List of Options**

Name	Option code	
Opposite-home specification	NM	
Slider roller specification	SR	Axis 1 (X-axis) Axis 2 (Y-axis)

**Specifications**

Item	X axis	Y axis
Axis model	RCP2-SS7C	RCP2-SA6R
Stroke (Can be set in 50-mm increments)	50-600mm	50-200mm
Max speed	HH type: 400mm/s HM type: 250mm/s	High-speed type: 600mm/s Medium-speed type: 300mm/s
Motor size	42-square pulse motor	
Ball screw lead	High-speed type: 12mm	High-speed type: 12mm Medium-speed type: 6mm
Drive method	Ball screw, ø10 mm, rolled, C10	
Positioning repeatability	±0.02mm	
Base material	Dedicated alloy steel	Aluminum
Surrounding air temperature/humidity	0 to 40°C, 85% RH or below (non-condensing)	

25 IK2-PXBC2□□S

Note 1. The connected position shown in the drawing defines the home.  
 Note 2. Both wiring 1 and wiring 2 assume use of a cable track.  
 Note 3. For details on the cable track, refer to P. 90.  
 Note 4. For details on the bracket on the moving end of the cable track, refer to P. 90.

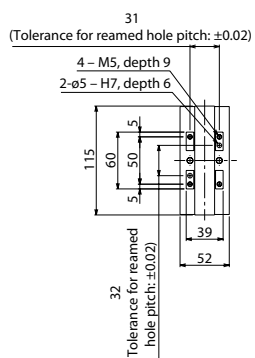
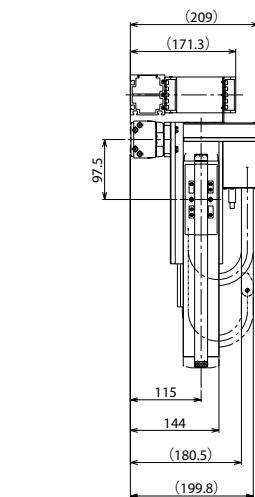

Detail view of Y-axis slider

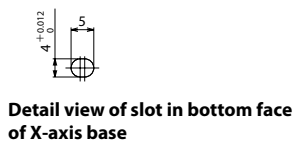

Detail view of slot in bottom face of X-axis base

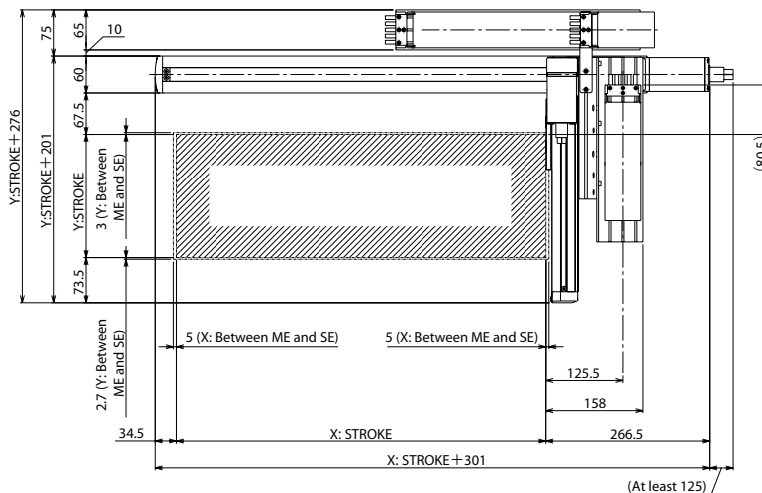

ME: Mechanical end  
 SE: Stroke end

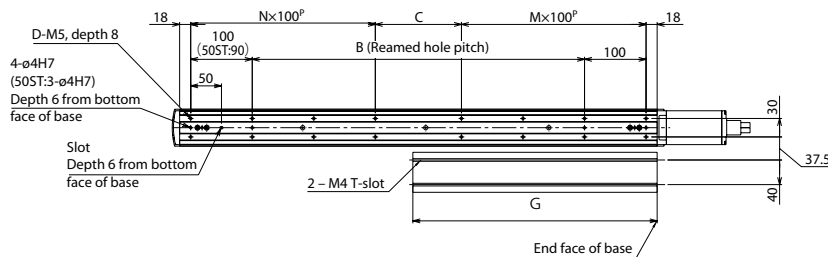
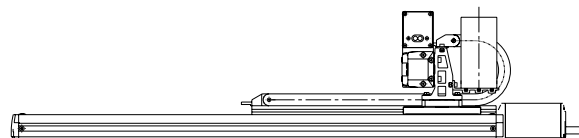

Detail view of X-axis installation

■ Dimensions by Stroke

X: Model	50	100	150	200	250	300	350	400	450	500	550	600
B	0	40	90	140	190	240	290	340	390	440	490	540
C	90	40	90	140	190	40	90	140	190	40	90	140
D	6	8	8	8	8	12	12	12	12	16	16	16
M	1	1	1	1	1	2	2	2	2	3	3	3
N	0	1	1	1	1	2	2	2	2	3	3	3
G	122	147	172	197	222	247	272	297	322	347	372	397

## Controllers

Applicable controller

Refer to P. 91 for the controllers.

# IK2-PXBC2□□D

RCP2 2-axis Combinations X axis: SS7C (Straight, Double-slider) Y axis: SA6R (Reversed)

**Model Details** Series — Type — Encoder type — Axis 1 (X axis) — Axis 2 (Y axis) — Controllers — Cable — Shipping configuration

**IK2** — **PXBC2**□□**D** — □ — □ — □ — □ — **P1** — □ — □ — □ — □

**Combination directions** 1-4  
**Differences between Single-slider and Double-slider Types**  
 HH: X high-speed, Y high-speed  
 HM: X high-speed, Y medium-speed

**Encoder type** I: Incremental

**Stroke (mm)** 5: 50mm  
 ? (Can be set in 50-mm increments)

**Options**  
 NM: Opposite-home specification  
 SR: Slider roller specification

**Cable length**  
 1L: 1m  
 3L: 3m  
 5L: 5m  
 □L: □m

**Wiring 1** N: Cable only  
**Wiring 2** CT: With cable track

**Shipping configuration** K: Individual components (kit)

\* Refer to P. 10 for details on the items comprising the model name.

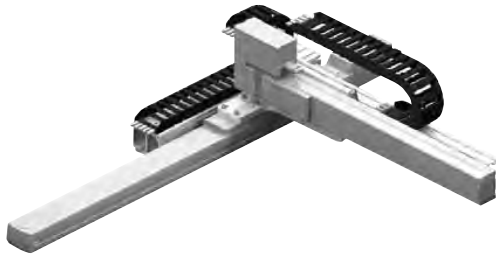

**Maximum Stroke**

X axis 450 mm      Y axis 400 mm

**Maximum Speed (High-speed type)**

X axis 400 mm/s      Y axis 600 mm/s

**Maximum Load Capacity**

Y-axis stroke	X high-speed, Y high-speed	X high-speed, Y medium-speed
250mm	3.0kg	6.0kg
300mm	3.0kg	6.0kg
350mm	3.0kg	6.0kg
400mm	3.0kg	6.0kg

Both wiring 1 and wiring 2 assume use of a cable track.

**List by Stroke**

		Incremental			
Y-axis stroke		250	300	350	400
X-axis stroke	50	-	-	-	-
	100	-	-	-	-
	150	-	-	-	-
	200	-	-	-	-
	250	-	-	-	-
	300	-	-	-	-
	350	-	-	-	-
	400	-	-	-	-
	450	-	-	-	-

**Cable track**

Wiring 1 (Next to X-axis)	X-axis stroke	50-300	350-450
			-
Wiring 2 (Next to Y-axis)	Y-axis stroke	250-400	-
			-

**List by Cable Length**

Type	Cable code	Length
Standard type	1L	1m
	3L	3m
	5L	5m

\* Axis 1 comes with a standard cable, while axis 2 comes with a robot cable.

\* Refer to P. 90 for lengths other than those specified above.

**List of Options**

Name	Option code	
Opposite-home specification	NM	
Slider roller specification	SR	Axis 1 (X-axis) Axis 2 (Y-axis)

**Specifications**

Item	X axis	Y axis
Axis model	RCP2-SS7C	RCP2-SA6R
Stroke (Can be set in 50-mm increments)	50-450mm	250-400mm
Max speed	HH type: 400mm/s HM type: 250mm/s	High-speed type: 600mm/s Medium-speed type: 300mm/s
Motor size	42-square pulse motor	
Ball screw lead	High-speed type: 12mm	High-speed type: 12mm Medium-speed type: 6mm
Drive method	Ball screw, ø10 mm, rolled, C10	
Positioning repeatability	±0.02mm	
Base material	Dedicated alloy steel	Aluminum
Surrounding air temperature/humidity	0 to 40°C, 85% RH or below (non-condensing)	

27

IK2-PXBC2□□D

Note 1. The connected position shown in the drawing defines the home.  
 Note 2. Both wiring 1 and wiring 2 assume use of a cable track.  
 Note 3. For details on the cable track, refer to P.90.  
 Note 4. For details on the bracket on the moving end of the cable track, refer to P.90.

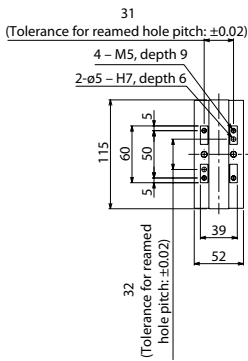
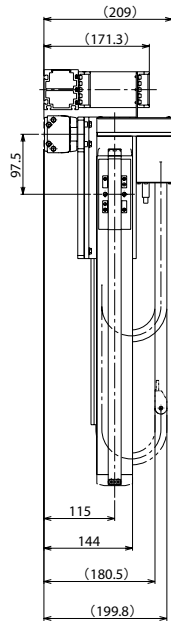

Detail view of Y-axis slider

Detail view of slot in bottom face of X-axis base

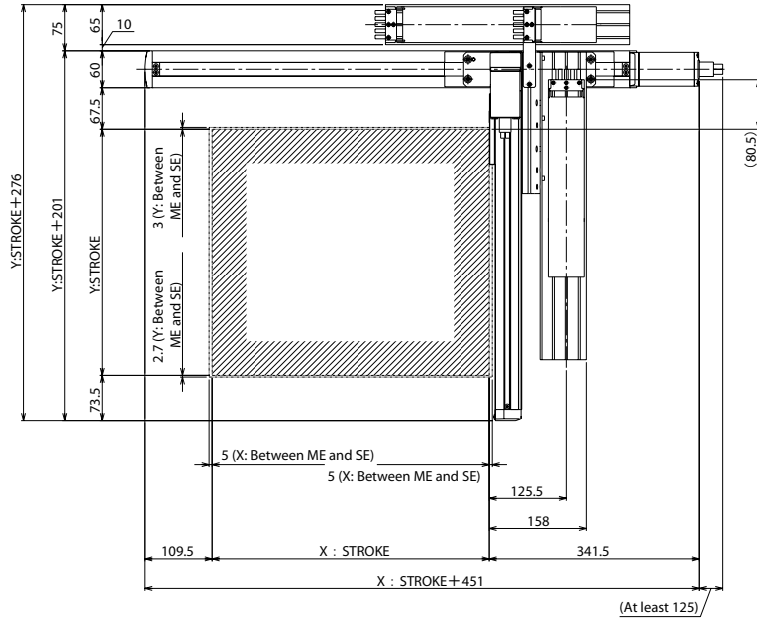

ME: Mechanical end  
 SE: Stroke end

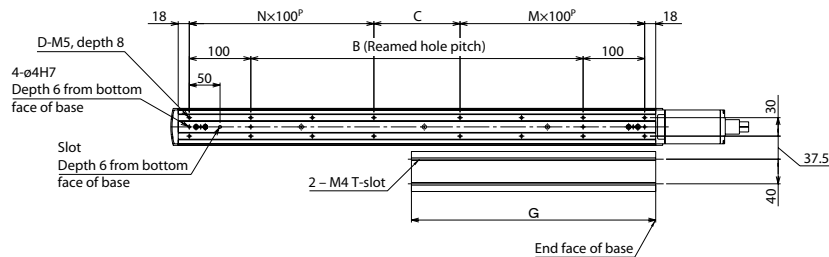
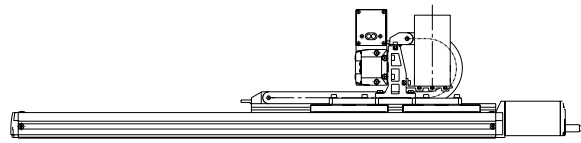

Detail view of X-axis installation

■ Dimensions by Stroke

X: Nominal stroke	200	250	300	350	400	450	500	550	600
X: Effective stroke	50	100	150	200	250	300	350	400	450
B	140	190	240	290	340	390	440	490	540
C	140	190	40	90	140	190	40	90	140
D	8	8	12	12	12	12	16	16	16
M	1	1	2	2	2	2	3	3	3
N	1	1	2	2	2	2	3	3	3
G	197	222	247	272	297	322	347	372	397

## Controllers

Applicable controller

Refer to P. 91 for the controllers.

# IK2-PXBB1□□S

RCP2 2-axis Combinations X axis: SS8R (Reversed, Single-slider) Y axis: SA7R (Reversed)

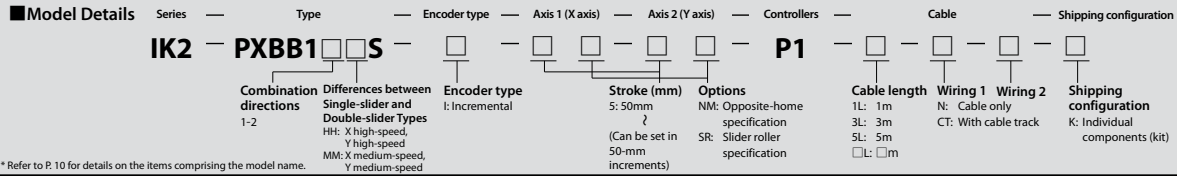

**Maximum Stroke**

X axis 1000 mm Y axis 300 mm

**Maximum Speed (High-speed type)**

X axis 250 mm/s Y axis 450 mm/s

**Maximum Load Capacity**

Y-axis stroke	X high-speed, Y high-speed	X medium-speed, Y medium-speed
50mm	8.0kg	16kg
100mm	8.0kg	16kg
150mm	7.0kg	15kg
200mm	7.0kg	12.5kg
250mm	6.0kg	9.0kg
300mm	6.0kg	8.0kg

Both wiring 1 and wiring 2 assume use of a cable track.

**List by Stroke**

Y-axis stroke	Incremental					
	50	100	150	200	250	300
50	-	-	-	-	-	-
100	-	-	-	-	-	-
150	-	-	-	-	-	-
200	-	-	-	-	-	-
250	-	-	-	-	-	-
300	-	-	-	-	-	-
350	-	-	-	-	-	-
400	-	-	-	-	-	-
450	-	-	-	-	-	-
500	-	-	-	-	-	-
550	-	-	-	-	-	-
600	-	-	-	-	-	-
650	-	-	-	-	-	-
700	-	-	-	-	-	-
750	-	-	-	-	-	-
800	-	-	-	-	-	-
850	-	-	-	-	-	-
900	-	-	-	-	-	-
950	-	-	-	-	-	-
1000	-	-	-	-	-	-

**Cable track**

Wiring 1 (Next to X-axis)	X-axis stroke	50-300	350-600	650-900	950-1000
Wiring 2 (Next to Y-axis)	Y-axis stroke	50-200	250-300	-	-

**List by Cable Length**

Type	Cable code	Length
Standard type	1L	1m
	3L	3m
	5L	5m

\* Axis 1 comes with a standard cable, while axis 2 comes with a robot cable.

\* Refer to P. 90 for lengths other than those specified above.

**List of Options**

Name	Option code
Opposite-home specification	NM
Slider roller specification	SR

Axis 1 (X-axis)  
Axis 2 (Y-axis)

**Specifications**

Item	X axis	Y axis
Axis model	RCP2-SS8R	RCP2-SA7R
Stroke (Can be set in 50-mm increments)	50-1000mm	50-300mm
Max speed	High-speed type: 250mm/s Medium-speed type: 125mm/s	High-speed type: 450mm/s Medium-speed type: 220mm/s
Motor size	56-square pulse motor	
Ball screw lead	High-speed type: 20mm Medium-speed type: 10mm	High-speed type: 16mm Medium-speed type: 8mm
Drive method	Ball screw, ø16mm, rolled, C10	Ball screw, ø12mm, rolled, C10
Positioning repeatability	±0.02mm	
Base material	Dedicated alloy steel	Aluminum
Surrounding air temperature/humidity	0 to 40°C, 85% RH or below (non-condensing)	

29 IK2-PXBB1□□S

Dimensions

Note 1. The connected position shown in the drawing defines the home.  
 Note 2. Both wiring 1 and wiring 2 assume use of a cable track.  
 Note 3. For details on the cable track, refer to P. 90.  
 Note 4. For details on the bracket on the moving end of the cable track, refer to P. 90.

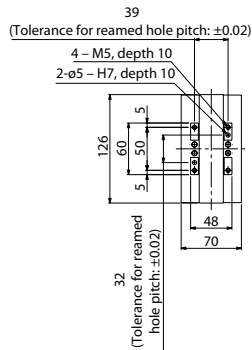
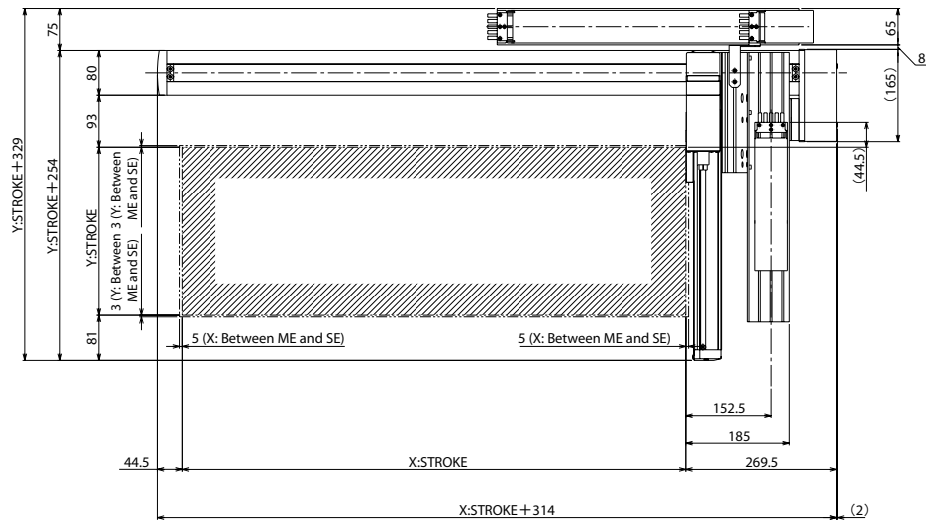
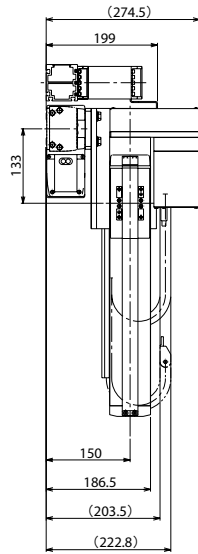

ME: Mechanical end  
 SE: Stroke end

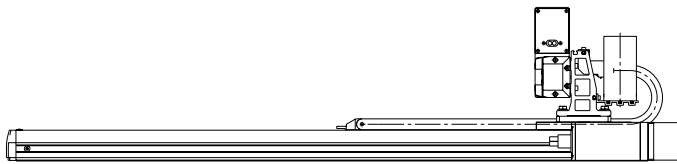

Detail view of Y-axis slider

Detail view of slot in bottom face of X-axis base

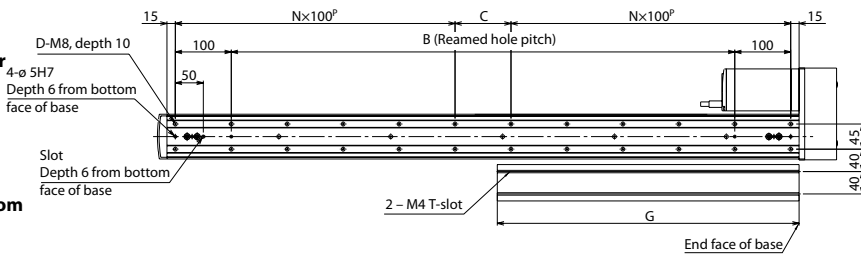

Detail view of X-axis installation

■ Dimensions by Stroke

X: Model	50	100	150	200	250	300	350	400	450	500	550	600	650	700	750	800	850	900	950	1000
B	50	100	150	200	250	300	350	400	450	500	550	600	650	700	750	800	850	900	950	1000
C	50	100	150	0	50	100	150	0	50	100	150	0	50	100	150	0	50	100	150	0
D	8	8	8	10	12	12	12	14	16	16	16	18	20	20	20	22	24	24	24	26
N	1	1	1	2	2	2	2	3	3	3	3	4	4	4	4	5	5	5	5	6
G	114.5	139.5	164.5	189.5	214.5	239.5	264.5	289.5	314.5	339.5	364.5	389.5	414.5	439.5	464.5	489.5	514.5	539.5	564.5	589.5

Controllers

Applicable controller

☞ Refer to P. 91 for the controllers.

2-axis  
Combinations  
R C P 2

2-axis  
Combinations  
R C S 2

3-axis  
Combinations  
R C P 2

3-axis  
Combinations  
R C S 2

Controllers

# IK2-PXBB1□□D

RCP2 2-axis Combinations X axis: SS8R (Reversed, Double-slider) Y axis: SA7R (Reversed)

**Model Details** Series — Type — Encoder type — Axis 1 (X axis) — Axis 2 (Y axis) — Controllers — Cable — Shipping configuration

**IK2** — **PXBB1**□□**D** — □ — □ — □ — □ — **P1** — □ — □ — □ — □

**Combination directions** 1-2  
**Differences between Single-slider and Double-slider Types**  
 HH: X high-speed, Y high-speed  
 MM: X medium-speed, Y medium-speed

**Encoder type** I: Incremental

**Stroke (mm)** 5: 50mm  
 ? (Can be set in 50-mm increments)

**Options**  
 NM: Opposite-home specification  
 SR: Slider roller specification

**Cable length**  
 1L: 1m  
 3L: 3m  
 5L: 5m  
 □L: □m

**Wiring 1** N: Cable only  
**Wiring 2** CT: With cable track

**Shipping configuration** K: Individual components (kit)

\* Refer to P. 10 for details on the items comprising the model name.

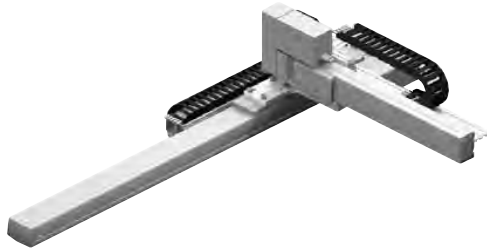

Both wiring 1 and wiring 2 assume use of a cable track.

**Maximum Stroke**

X axis 800 mm Y axis 400 mm

**Maximum Speed (High-speed type)**

X axis 250 mm/s Y axis 450 mm/s

**Maximum Load Capacity**

Y-axis stroke	X high-speed, Y high-speed	X medium-speed, Y medium-speed
200mm	—	15kg
250mm	—	12.5kg
300mm	—	12.5kg
350mm	6.0kg	12kg
400mm	5.5kg	10.5kg

**List by Stroke**

		Incremental				
Y-axis stroke		200	250	300	350	400
X-axis stroke	50	—	—	—	—	—
	100	—	—	—	—	—
	150	—	—	—	—	—
	200	—	—	—	—	—
	250	—	—	—	—	—
	300	—	—	—	—	—
	350	—	—	—	—	—
	400	—	—	—	—	—
	450	—	—	—	—	—
	500	—	—	—	—	—
	550	—	—	—	—	—
	600	—	—	—	—	—
	650	—	—	—	—	—
	700	—	—	—	—	—
	750	—	—	—	—	—
	800	—	—	—	—	—

Note: For the X high-speed/Y high-speed type, the Y-axis stroke must be 350 mm or more.

**Cable track**

Wiring 1 (Next to X-axis)	X-axis stroke	50-300	350-600	650-800
Wiring 2 (Next to Y-axis)	Y-axis stroke	200	250-400	—

**List by Cable Length**

Type	Cable code	Length
Standard type	1L	1m
	3L	3m
	5L	5m

\* Axis 1 comes with a standard cable, while axis 2 comes with a robot cable.

\* Refer to P. 90 for lengths other than those specified above.

**List of Options**

Name	Option code	
Opposite-home specification	NM	
Slider roller specification	SR	Axis 1 (X-axis) Axis 2 (Y-axis)

**Specifications**

Item	X axis	Y axis
Axis model	RCP2-SS8R	RCP2-SA7R
Stroke (Can be set in 50-mm increments)	50-800mm	High-speed type: 350-400mm Medium-speed type: 200-400mm
Max speed	High-speed type: 250mm/s Medium-speed type: 125mm/s	High-speed type: 450mm/s Medium-speed type: 220mm/s
Motor size	56-square pulse motor	
Ball screw lead	High-speed type: 20mm Medium-speed type: 10mm	High-speed type: 16mm Medium-speed type: 8mm
Drive method	Ball screw, ø16mm, rolled, C10	Ball screw, ø12mm, rolled, C10
Positioning repeatability	±0.02mm	
Base material	Dedicated alloy steel	Aluminum
Surrounding air temperature/humidity	0 to 40°C, 85% RH or below (non-condensing)	

31

IK2-PXBB1□□D



Note 1. The connected position shown in the drawing defines the home.  
 Note 2. Both wiring 1 and wiring 2 assume use of a cable track.  
 Note 3. For details on the cable track, refer to P.90.  
 Note 4. For details on the bracket on the moving end of the cable track, refer to P. 90.

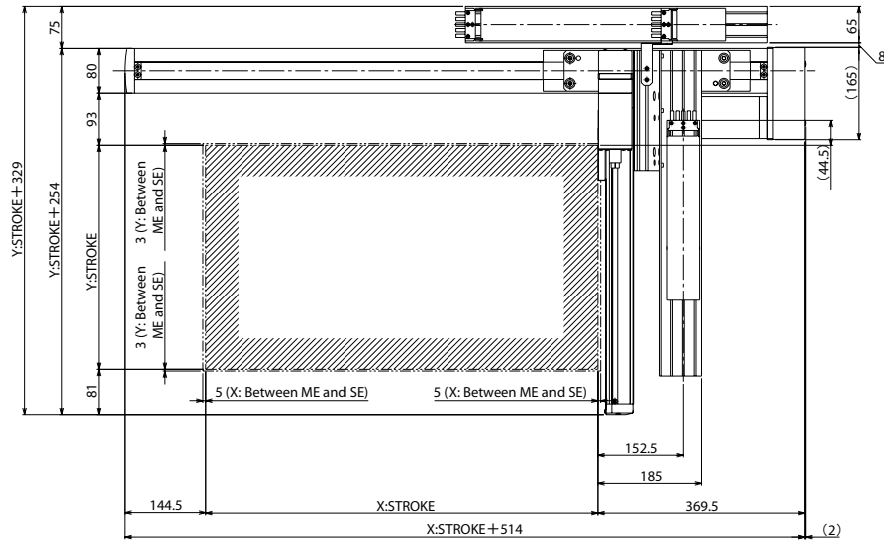
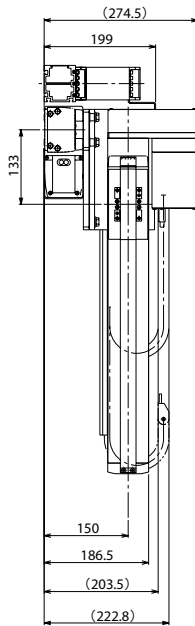

ME: Mechanical end  
 SE: Stroke end

39  
 (Tolerance for reamed hole pitch: ±0.02)  
 4 - M5, depth 10  
 2-ø5 - H7, depth 10

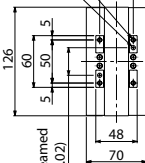

Detail view of Y-axis slider



Detail view of slot in bottom face of X-axis base

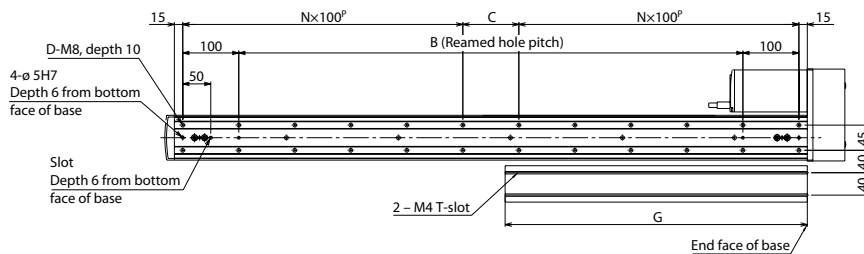
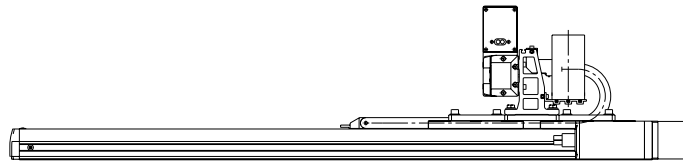

Detail view of X-axis installation

■ Dimensions by Stroke

	250	300	350	400	450	500	550	600	650	700	750	800	850	900	950	1000
X: Nominal stroke	250	300	350	400	450	500	550	600	650	700	750	800	850	900	950	1000
X: Effective stroke	50	100	150	200	250	300	350	400	450	500	550	600	650	700	750	800
B	250	300	350	400	450	500	550	600	650	700	750	800	850	900	950	1000
C	50	100	150	0	50	100	150	0	50	100	150	0	50	100	150	0
D	12	12	12	14	16	16	16	18	20	20	20	22	24	24	24	26
N	2	2	2	3	3	3	3	4	4	4	4	5	5	5	5	6
G	214.5	239.5	264.5	289.5	314.5	339.5	364.5	389.5	414.5	439.5	464.5	489.5	514.5	539.5	564.5	589.5

Controllers

Applicable controller

Refer to P. 91 for the controllers.

# IK2-PXBB2□□S

RCP2 2-axis Combinations X axis: SS8C (Straight, Single-slider) Y axis: SA7R (Reversed)

**Model Details** Series — Type — Encoder type — Axis 1 (X axis) — Axis 2 (Y axis) — Controllers — Cable — Shipping configuration

**IK2** — **PXBB2**□□**S** — □ — □ — □ — □ — **P1** — □ — □ — □ — □

**Combination directions** 1-4  
**Differences between Single-slider and Double-slider Types**  
 HH: X high-speed, Y high-speed  
 MM: X medium-speed, Y medium-speed

**Encoder type** I: Incremental

**Stroke (mm)** 5: 50mm  
 ? (Can be set in 50-mm increments)

**Options**  
 NM: Opposite-home specification  
 SR: Slider roller specification

**Cable length**  
 1L: 1m  
 3L: 3m  
 5L: 5m  
 □L: □m

**Wiring 1** N: Cable only  
**Wiring 2** CT: With cable track

**Shipping configuration** K: Individual components (kit)

\* Refer to P. 10 for details on the items comprising the model name.

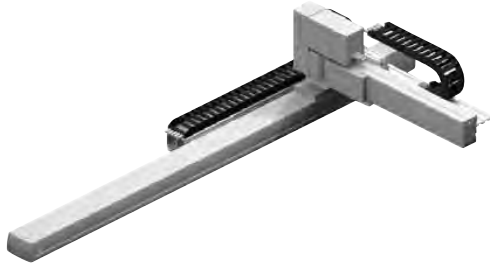

**Maximum Stroke**

X axis 1000 mm Y axis 300 mm

**Maximum Speed (High-speed type)**

X axis 250 mm/s Y axis 450 mm/s

**Maximum Load Capacity**

Y-axis stroke	X high-speed, Y high-speed	X medium-speed, Y medium-speed
50mm	8.0kg	16kg
100mm	8.0kg	16kg
150mm	7.0kg	15kg
200mm	7.0kg	12.5kg
250mm	6.0kg	9.0kg
300mm	6.0kg	8.0kg

Both wiring 1 and wiring 2 assume use of a cable track.

**List by Stroke**

Y-axis stroke	Incremental					
	50	100	150	200	250	300
50	-	-	-	-	-	-
100	-	-	-	-	-	-
150	-	-	-	-	-	-
200	-	-	-	-	-	-
250	-	-	-	-	-	-
300	-	-	-	-	-	-
350	-	-	-	-	-	-
400	-	-	-	-	-	-
450	-	-	-	-	-	-
500	-	-	-	-	-	-
550	-	-	-	-	-	-
600	-	-	-	-	-	-
650	-	-	-	-	-	-
700	-	-	-	-	-	-
750	-	-	-	-	-	-
800	-	-	-	-	-	-
850	-	-	-	-	-	-
900	-	-	-	-	-	-
950	-	-	-	-	-	-
1000	-	-	-	-	-	-

**Cable track**

Wiring 1 (Next to X-axis)	X-axis stroke	50-300	350-600	650-900	950-1000
Wiring 2 (Next to Y-axis)	Y-axis stroke	50-200	250-300	-	-

**List by Cable Length**

Type	Cable code	Length
Standard type	1L	1m
	3L	3m
	5L	5m

\* Axis 1 comes with a standard cable, while axis 2 comes with a robot cable.

\* Refer to P. 90 for lengths other than those specified above.

**List of Options**

Name	Option code
Opposite-home specification	NM
Slider roller specification	SR

Axis 1 (X-axis)  
Axis 2 (Y-axis)

**Specifications**

Item	X axis	Y axis
Axis model	RCP2-SS8C	RCP2-SA7R
Stroke (Can be set in 50-mm increments)	50-1000mm	50-300mm
Max speed	High-speed type: 250mm/s Medium-speed type: 125mm/s	High-speed type: 450mm/s Medium-speed type: 220mm/s
Motor size	56-square pulse motor	
Ball screw lead	High-speed type: 20mm Medium-speed type: 10mm	High-speed type: 16mm Medium-speed type: 8mm
Drive method	Ball screw, ø16mm, rolled, C10	Ball screw, ø12mm, rolled, C10
Positioning repeatability	±0.02mm	
Base material	Dedicated alloy steel	Aluminum
Surrounding air temperature/humidity	0 to 40°C, 85% RH or below (non-condensing)	

33

IK2-PXBB2□□S

Dimensions

Note 1. The connected position shown in the drawing defines the home.  
 Note 2. Both wiring 1 and wiring 2 assume use of a cable track.  
 Note 3. For details on the cable track, refer to P. 90.  
 Note 4. For details on the bracket on the moving end of the cable track, refer to P. 90.

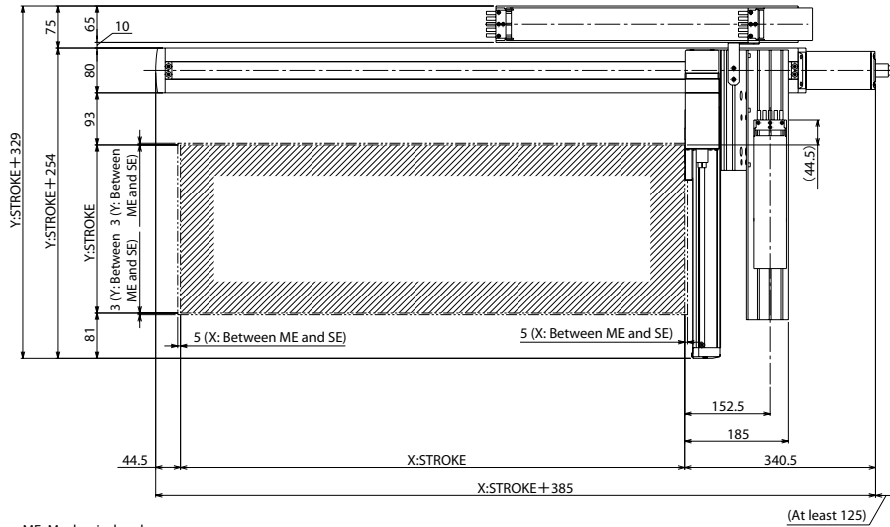
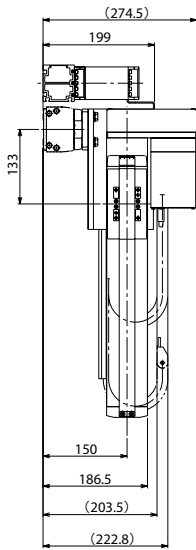

ME: Mechanical end  
 SE: Stroke end

39  
 (Tolerance for reamed hole pitch: ±0.02)

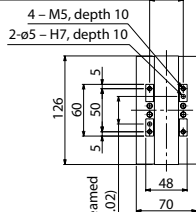

Detail view of Y-axis slider

Detail view of slot in bottom face of X-axis base

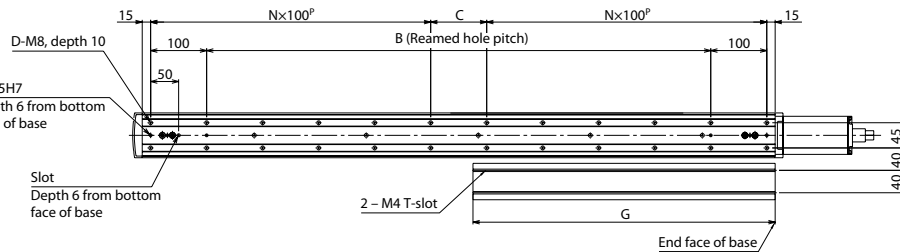
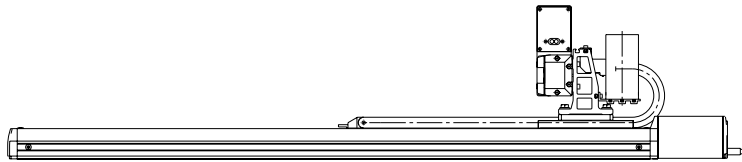

Detail view of X-axis installation

Dimensions by Stroke

X: Model	50	100	150	200	250	300	350	400	450	500	550	600	650	700	750	800	850	900	950	1000
B	50	100	150	200	250	300	350	400	450	500	550	600	650	700	750	800	850	900	950	1000
C	50	100	150	0	50	100	150	0	50	100	150	0	50	100	150	0	50	100	150	0
D	8	8	8	10	12	12	12	14	16	16	16	18	20	20	20	22	24	24	24	26
N	1	1	1	2	2	2	2	3	3	3	3	4	4	4	4	5	5	5	5	6
G	114.5	139.5	164.5	189.5	214.5	239.5	264.5	289.5	314.5	339.5	364.5	389.5	414.5	439.5	464.5	489.5	514.5	539.5	564.5	589.5

Controllers

Applicable controller

Refer to P. 91 for the controllers.

# IK2-PXBB2□□D

RCP2 2-axis Combinations X axis: SS8C (Straight, Double-slider) Y axis: SA7R (Reversed)

**Model Details** Series — Type — Encoder type — Axis 1 (X axis) — Axis 2 (Y axis) — Controllers — Cable — Shipping configuration

**IK2** — **PXBB2**□□**D** — □ — □ — □ — □ — **P1** — □ — □ — □ — □

**Combination directions** 1-4  
**Differences between Single-slider and Double-slider Types**  
 HH: X high-speed, Y high-speed  
 MM: X medium-speed, Y medium-speed

**Encoder type** I: Incremental

**Stroke (mm)** 5: 50mm  
 ? (Can be set in 50-mm increments)

**Options**  
 NM: Opposite-home specification  
 SR: Slider roller specification

**Cable length**  
 1L: 1m  
 3L: 3m  
 5L: 5m  
 □L: □m

**Wiring 1** N: Cable only  
**Wiring 2** CT: With cable track

**Shipping configuration** K: Individual components (kit)

\* Refer to P. 10 for details on the items comprising the model name.



**Maximum Stroke**

X axis 800 mm Y axis 400 mm

**Maximum Speed (High-speed type)**

X axis 250 mm/s Y axis 450 mm/s

**Maximum Load Capacity**

Y-axis stroke	X high-speed, Y high-speed	X medium-speed, Y medium-speed
200mm	—	15kg
250mm	—	12.5kg
300mm	—	12.5kg
350mm	6.0kg	12kg
400mm	5.5kg	10.5kg

Both wiring 1 and wiring 2 assume use of a cable track.

**List by Stroke**

Y-axis stroke	Incremental				
	200	250	300	350	400
50	—	—	—	—	—
100	—	—	—	—	—
150	—	—	—	—	—
200	—	—	—	—	—
250	—	—	—	—	—
300	—	—	—	—	—
350	—	—	—	—	—
400	—	—	—	—	—
450	—	—	—	—	—
500	—	—	—	—	—
550	—	—	—	—	—
600	—	—	—	—	—
650	—	—	—	—	—
700	—	—	—	—	—
750	—	—	—	—	—
800	—	—	—	—	—

Note: For the X high-speed/Y high-speed type, the Y-axis stroke must be 350 mm or more.

**Cable track**

Wiring 1 (Next to X-axis)	X-axis stroke	50-300	350-600	650-800
Wiring 2 (Next to Y-axis)	Y-axis stroke	200	250-400	—

**List by Cable Length**

Type	Cable code	Length
Standard type	1L	1m
	3L	3m
	5L	5m

\* Axis 1 comes with a standard cable, while axis 2 comes with a robot cable.  
 \* Refer to P. 90 for lengths other than those specified above.

**List of Options**

Name	Option code	
Opposite-home specification	NM	
Slider roller specification	SR	Axis 1 (X-axis) Axis 2 (Y-axis)

**Specifications**

Item	X axis	Y axis
Axis model	RCP2-SS8C	RCP2-SA7R
Stroke (Can be set in 50-mm increments)	50-800mm	High-speed type: 350-400mm Medium-speed type: 200-400mm
Max speed	High-speed type: 250mm/s Medium-speed type: 125mm/s	High-speed type: 450mm/s Medium-speed type: 220mm/s
Motor size	56-square pulse motor	
Ball screw lead	High-speed type: 20mm Medium-speed type: 10mm	High-speed type: 16mm Medium-speed type: 8mm
Drive method	Ball screw, ø16mm, rolled, C10	Ball screw, ø12mm, rolled, C10
Positioning repeatability	±0.02mm	
Base material	Dedicated alloy steel	Aluminum
Surrounding air temperature/humidity	0 to 40°C, 85% RH or below (non-condensing)	

35 IK2-PXBB2□□D

Note 1. The connected position shown in the drawing defines the home.  
 Note 2. Both wiring 1 and wiring 2 assume use of a cable track.  
 Note 3. For details on the cable track, refer to P.90.  
 Note 4. For details on the bracket on the moving end of the cable track, refer to P.90.

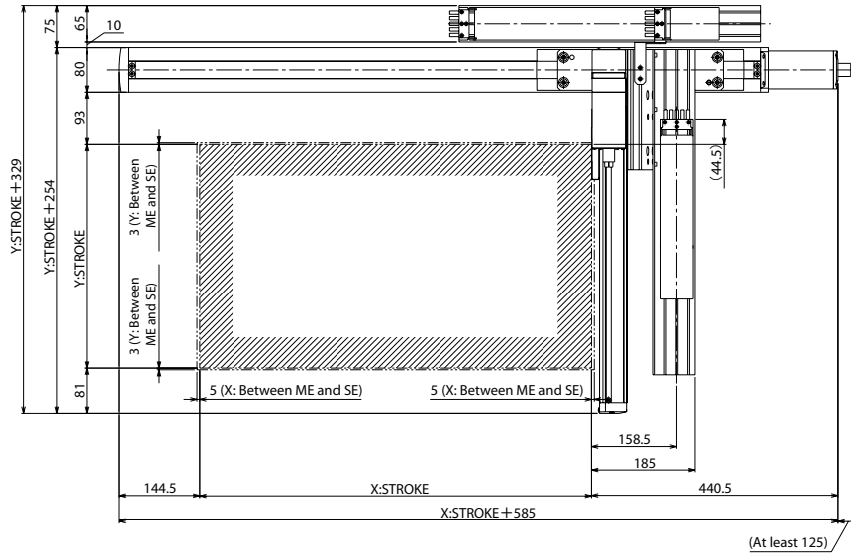
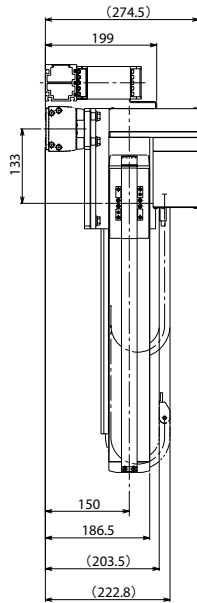

ME: Mechanical end  
 SE: Stroke end

39  
 (Tolerance for reamed hole pitch: ±0.02)

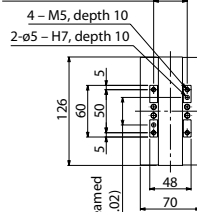

Detail view of Y-axis slider

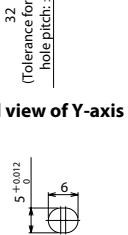

Detail view of slot in bottom face of X-axis base

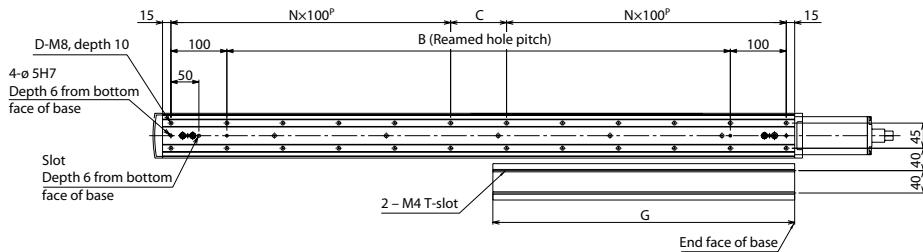
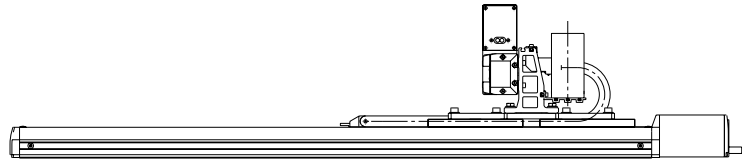

Detail view of X-axis installation

■ Dimensions by Stroke

X: Nominal stroke	250	300	350	400	450	500	550	600	650	700	750	800	850	900	950	1000
X: Effective stroke	50	100	150	200	250	300	350	400	450	500	550	600	650	700	750	800
B	250	300	350	400	450	500	550	600	650	700	750	800	850	900	950	1000
C	50	100	150	0	50	100	150	0	50	100	150	0	50	100	150	0
D	12	12	12	14	16	16	16	18	20	20	22	24	24	24	24	26
N	2	2	2	3	3	3	3	4	4	4	4	5	5	5	5	6
G	214,5	239,5	264,5	289,5	314,5	339,5	364,5	389,5	414,5	439,5	464,5	489,5	514,5	539,5	564,5	589,5

Controllers

Applicable controller:

☞ Refer to P. 91 for the controllers.

# IK2-PXZB1□□S

RCP2 2-axis Combinations X axis: SS8R (Reversed, Single-slider)  
Z axis: SA7R (Reversed)

**Model Details**

Series: IK2 | Type: PXZB1□□S | Encoder type: I: Incremental | Axis 1 (X axis): □ | Axis 2 (Z axis): □ | Controllers: P1 | Cable: □ | Shipping configuration: □

**Combination directions** 1-4

**Differences between Single-slider and Double-slider Types**  
 HH: X high-speed, Z high-speed  
 HM: X high-speed, Z medium-speed  
 HL: X high-speed, Z low-speed

**Encoder type** I: Incremental

**Stroke (mm)**  
 5: 50mm  
 ? (Can be set in 50-mm increments)

**Options**  
 B: Brake  
 NM: Opposite-home specification  
 SR: Slider roller specification

**Cable length**  
 1L: 1m  
 3L: 3m  
 5L: 5m  
 □L: □m

**Wiring 1** N: Cable only  
 CT: With cable track

**Wiring 2** □

**Shipping configuration** K: Individual components (kit)

\* Refer to P.10 for details on the items comprising the model name.



Wiring 1 with cable track

**Maximum Stroke**

X axis 1000 mm | Z axis 250 mm

**Maximum Speed (High-speed type)**

X axis 250 mm/s | Z axis 360 mm/s

**Maximum Load Capacity**

Z-axis stroke	Z high-speed, lead 16	Z medium-speed, lead 8	Z low-speed, lead 4
50mm	2.0kg	4.0kg	8.0kg
100mm	2.0kg	4.0kg	7.0kg
150mm	2.0kg	3.5kg	5.0kg
200mm	2.0kg	3.5kg	4.0kg
250mm	1.5kg	2.5kg	3.0kg

**List by Stroke**

Z-axis stroke	Incremental				
	50	100	150	200	250
50	-	-	-	-	-
100	-	-	-	-	-
150	-	-	-	-	-
200	-	-	-	-	-
250	-	-	-	-	-
300	-	-	-	-	-
350	-	-	-	-	-
400	-	-	-	-	-
450	-	-	-	-	-
500	-	-	-	-	-
550	-	-	-	-	-
600	-	-	-	-	-
650	-	-	-	-	-
700	-	-	-	-	-
750	-	-	-	-	-
800	-	-	-	-	-
850	-	-	-	-	-
900	-	-	-	-	-
950	-	-	-	-	-
1000	-	-	-	-	-

**Cable track**

Wiring 1 (Next to X-axis)	X-axis stroke	150-300	350-600	650-900	950-1000

**List by Cable Length**

Type	Cable code	Length
Standard type	1L	1m
	3L	3m
	5L	5m

\* Axis 1 comes with a standard cable, while axis 2 comes with a robot cable.

\* Refer to P.90 for lengths other than those specified above.

**List of Options**

Name	Option code	
Opposite-home specification	NM	
Slider roller specification	SR	Axis 1 (X-axis) Axis 2 (Z-axis)

**Specifications**

Item	X axis	Z axis
Axis model	RCP2-SS8R	RCP2-SA7R
Stroke (Can be set in 50-mm increments)	50-1000mm	50-250mm
Max speed	High-speed type: 250mm/s	High-speed type: 360mm/s Medium-speed type: 180mm/s Low-speed type: 90mm/s
Motor size	56-square pulse motor	
Ball screw lead	High-speed type: 20mm	High-speed type: 16mm Medium-speed type: 8mm Low-speed type: 4mm
Drive method	Ball screw, ø16mm, rolled, C10	Ball screw, ø12mm, rolled, C10
Positioning repeatability	±0.02mm	
Base material	Dedicated alloy steel	Aluminum
Surrounding air temperature/humidity	0 to 40°C, 85% RH or below (non-condensing)	

37

IK2-PXZB1□□S

Dimensions

Note 1. The connected position shown in the drawing defines the home.  
 Note 2. Both wiring 1 and wiring 2 assume use of a cable track.  
 Note 3. For details on the cable track, refer to P.90.  
 Note 4. For details on the bracket on the moving end of the cable track, refer to P. 90.

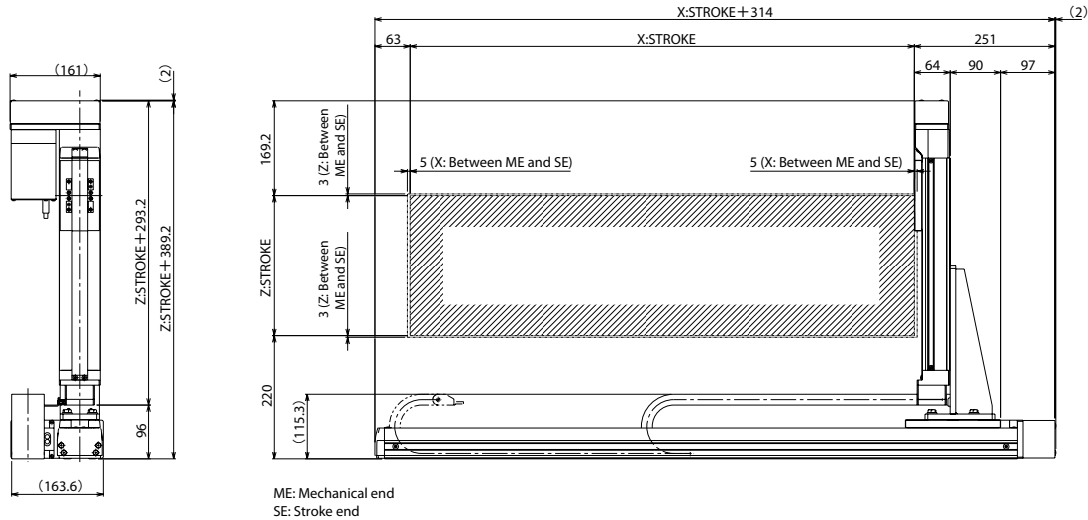

ME: Mechanical end  
 SE: Stroke end

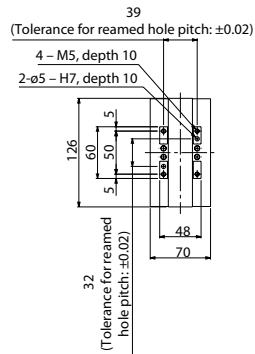

Detail view of Z-axis slider

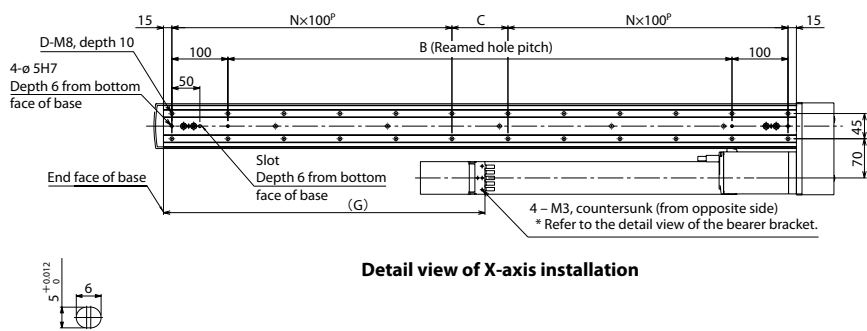

Detail view of slot in bottom face of X-axis base

Dimensions by Stroke

X: Model	50	100	150	200	250	300	350	400	450	500	550	600	650	700	750	800	850	900	950	1000
B	50	100	150	200	250	300	350	400	450	500	550	600	650	700	750	800	850	900	950	1000
C	50	100	150	0	50	100	150	0	50	100	150	0	50	100	150	0	50	100	150	0
D	8	8	8	10	12	12	12	14	16	16	16	18	20	20	20	22	24	24	24	26
N	1	1	1	2	2	2	2	3	3	3	3	4	4	4	4	5	5	5	5	6
G	-	-	199	224	249	274	299	324	349	374	399	424	449	474	499	524	549	574	599	624

\* A bearer is not set when the X stroke is 50 or 100.

Controllers

Applicable controller

Refer to P. 91 for the controllers.

2-axis  
Combinations  
R C P 2

2-axis  
Combinations  
R C S 2

3-axis  
Combinations  
R C P 2

3-axis  
Combinations  
R C S 2

Controllers

# IK2-PXZB1□□D

RCP2 2-axis Combinations X axis: SS8R (Reversed, Double-slider) Z axis: SA7R (Reversed)

**Model Details** Series — Type — Encoder type — Axis 1 (X-axis) — Axis 2 (Z-axis) — Controllers — Cable — Shipping configuration

**IK2** — **PXZB1**□□**D** — □ — □ — □ — □ — **P1** — □ — □ — □ — □

**Combination directions** 1-4  
**Differences between Single-slider and Double-slider Types**  
 HH: X high-speed, Z high-speed  
 HM: X high-speed, Z medium-speed  
 HL: X high-speed, Z low-speed

**Encoder type**  
 I: Incremental

**Stroke (mm)**  
 5: 50mm  
 ? (Can be set in 50-mm increments)

**Options**  
 B: Brake specification  
 NM: Opposite-home specification  
 SR: Slider roller specification

**Cable length**  
 1L: 1m  
 3L: 3m  
 5L: 5m  
 □L: □m

**Wiring 1**  
 N: Cable only

**Wiring 2**  
 CT: With cable track

**Shipping configuration**  
 K: Individual components (kit)

\* Refer to P.10 for details on the items comprising the model name.



Wiring 1 with cable track

**Maximum Stroke**

X axis **800 mm**      Z axis **300 mm**

**Maximum Speed (High-speed type)**

X axis **250 mm/s**      Z axis **400 mm/s**

**Maximum Load Capacity**

Z-axis stroke	Z high-speed, lead 16	Z medium-speed, lead 8	Z low-speed, lead 4
150mm	—	—	7.0kg
200mm	—	—	7.0kg
250mm	—	—	5.5kg
300mm	1.5kg	3.0kg	5.5kg

**List by Stroke**

X-axis stroke	Incremental			
	Z-axis stroke 150	200	250	300
50	—	—	—	—
100	—	—	—	—
150	—	—	—	—
200	—	—	—	—
250	—	—	—	—
300	—	—	—	—
350	—	—	—	—
400	—	—	—	—
450	—	—	—	—
500	—	—	—	—
550	—	—	—	—
600	—	—	—	—
650	—	—	—	—
700	—	—	—	—
750	—	—	—	—
800	—	—	—	—

Note: For the Z high-speed type and Z medium-speed type, The Z-axis stroke is limited to 300 mm.

**Cable track**

Wiring 1 (Next to X-axis)	X-axis stroke	150-300	350-600	650-800

**List by Cable Length**

Type	Cable code	Length
Standard type	1L	1m
	3L	3m
	5L	5m

\* Axis 1 comes with a standard cable, while axis 2 comes with a robot cable.

\* Refer to P.90 for lengths other than those specified above.

**List of Options**

Name	Option code	
Opposite-home specification	<b>NM</b>	
Slider roller specification	<b>SR</b>	Axis 1 (X-axis) Axis 2 (Z-axis)

**Specifications**

Item	X axis	Z axis
Axis model	RCP2-SS8R	RCP2-SA7R
Stroke (Can be set in 50-mm increments)	50-800mm	High-speed type: 300mm Medium-speed type: 300mm Low-speed type: 150-300mm
Max speed	High-speed type: 250mm/s	High-speed type: 400mm/s Medium-speed type: 200mm/s Low-speed type: 100mm/s
Motor size	56-square pulse motor	
Ball screw lead	High-speed type: 20mm	High-speed type: 16mm Medium-speed type: 8mm Low-speed type: 4mm
Drive method	Ball screw, ø16mm, rolled, C10	Ball screw, ø12mm, rolled, C10
Positioning repeatability	±0.02mm	
Base material	Dedicated alloy steel	Aluminum
Surrounding air temperature/humidity	0 to 40°C, 85% RH or below (non-condensing)	

39

IK2-PXZB1□□D



Note 1. The connected position shown in the drawing defines the home.  
 Note 2. Both wiring 1 and wiring 2 assume use of a cable track.  
 Note 3. For details on the cable track, refer to P.90.  
 Note 4. For details on the bracket on the moving end of the cable track, refer to P. 90.

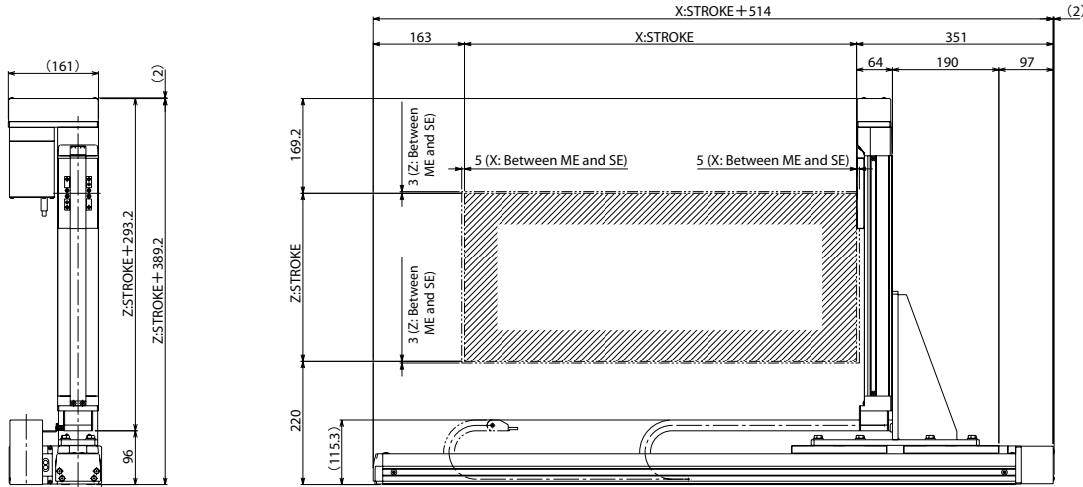
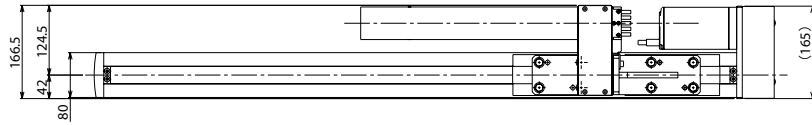

ME: Mechanical end  
 SE: Stroke end

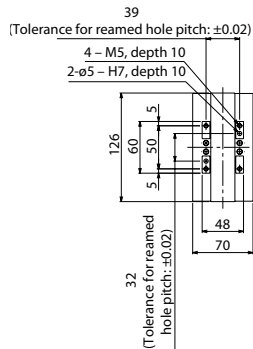

Detail view of Z-axis slider

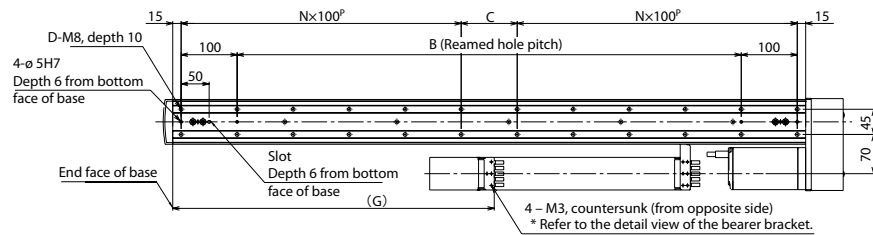

Detail view of X-axis installation

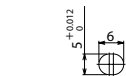

Detail view of slot in bottom face of X-axis base

■ Dimensions by Stroke

X: Nominal stroke	250	300	350	400	450	500	550	600	650	700	750	800	850	900	950	1000
X: Effective stroke	50	100	150	200	250	300	350	400	450	500	550	600	650	700	750	800
B	250	300	350	400	450	500	550	600	650	700	750	800	850	900	950	1000
C	50	100	150	0	50	100	150	0	50	100	150	0	50	100	150	0
D	12	12	12	14	16	16	16	18	20	20	20	22	24	24	24	26
N	2	2	2	3	3	3	3	4	4	4	4	5	5	5	5	6
G	-	-	299	324	349	374	399	424	449	474	499	524	549	574	599	624

\* A bearer is not set when the X stroke is 50 or 100.

## Controllers

Applicable controller

Refer to P. 91 for the controllers.

# IK2-PYBB1□□S

RCP2 2-axis Combinations Y axis: SS8R (Reversed, Double-slider)  
Z axis: SA7R (Reversed)

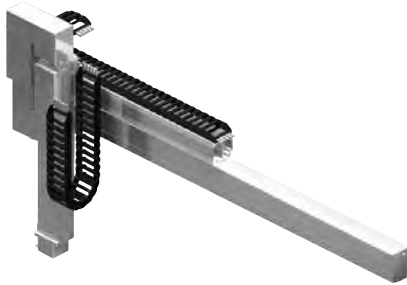
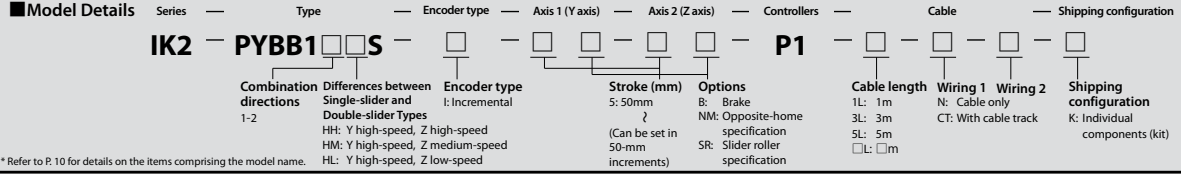

Both wiring 1 and wiring 2 assume use of a cable track.

**Maximum Stroke**

Y axis 1000 mm      Z axis 300 mm

**Maximum Speed (High-speed type)**

Y axis 250 mm/s      Z axis 360 mm/s

**Maximum Load Capacity**

Z-axis stroke	Z high-speed, lead 16	Z medium-speed, lead 8	Z low-speed, lead 4
50mm	2.0kg	4.0kg	8.0kg
100mm	2.0kg	4.0kg	8.0kg
150mm	2.0kg	3.5kg	7.0kg
200mm	2.0kg	3.5kg	7.0kg
250mm	1.5kg	3.0kg	6.0kg
300mm	1.5kg	3.0kg	5.5kg

**List by Stroke**

Y-axis stroke	Incremental					
	Z-axis stroke 50	100	150	200	250	300
50	-	-	-	-	-	-
100	-	-	-	-	-	-
150	-	-	-	-	-	-
200	-	-	-	-	-	-
250	-	-	-	-	-	-
300	-	-	-	-	-	-
350	-	-	-	-	-	-
400	-	-	-	-	-	-
450	-	-	-	-	-	-
500	-	-	-	-	-	-
550	-	-	-	-	-	-
600	-	-	-	-	-	-
650	-	-	-	-	-	-
700	-	-	-	-	-	-
750	-	-	-	-	-	-
800	-	-	-	-	-	-
850	-	-	-	-	-	-
900	-	-	-	-	-	-
950	-	-	-	-	-	-
1000	-	-	-	-	-	-

**Cable track**

	Y-axis stroke	50-300	350-600	650-900	950-1000
Wiring 1 (Next to Y-axis)					
Wiring 2 (Next to Z-axis)	Z-axis stroke	50-200	250-300	-	-

**List by Cable Length**

Type	Cable code	Length
Standard type	1L	1m
	3L	3m
	5L	5m

\* Axis 1 comes with a standard cable, while axis 2 comes with a robot cable.

\* Refer to P.90 for lengths other than those specified above.

**List of Options**

Name	Option code	
Opposite-home specification	NM	
Slider roller specification	SR	Axis 1 (Y-axis) Axis 2 (Z-axis)

**Specifications**

Item	Y axis	Z axis
Axis model	RCP2-SS8R	RCP2-SA7R
Stroke (Can be set in 50-mm increments)	50-1000mm	50-300mm
Max speed	High-speed type: 250mm/s	High-speed type: 360mm/s Medium-speed type: 180mm/s Low-speed type: 90mm/s
Motor size	56-square pulse motor	
Ball screw lead	High-speed type: 20mm	High-speed type: 16mm Medium-speed type: 8mm Low-speed type: 4mm
Drive method	Ball screw, ø16mm, rolled, C10	Ball screw, ø12mm, rolled, C10
Positioning repeatability	±0.02mm	
Base material	Dedicated alloy steel	Aluminum
Surrounding air temperature/humidity	0 to 40°C, 85% RH or below (non-condensing)	

41

IK2-PYBB1□□S

Dimensions

Note 1. The connected position shown in the drawing defines the home.  
 Note 2. Both wiring 1 and wiring 2 assume use of a cable track.  
 Note 3. For details on the cable track, refer to P.90.  
 Note 4. For details on the bracket on the moving end of the cable track, refer to P.90.

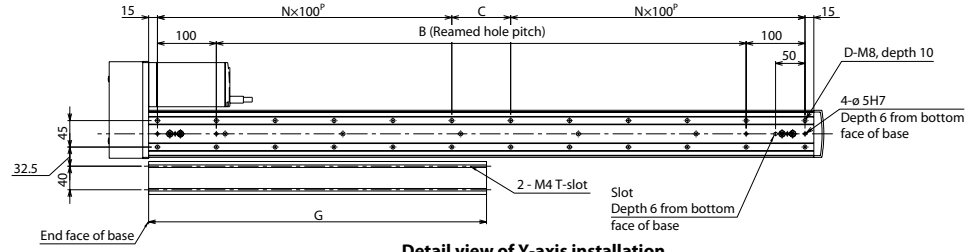

Detail view of Y-axis installation

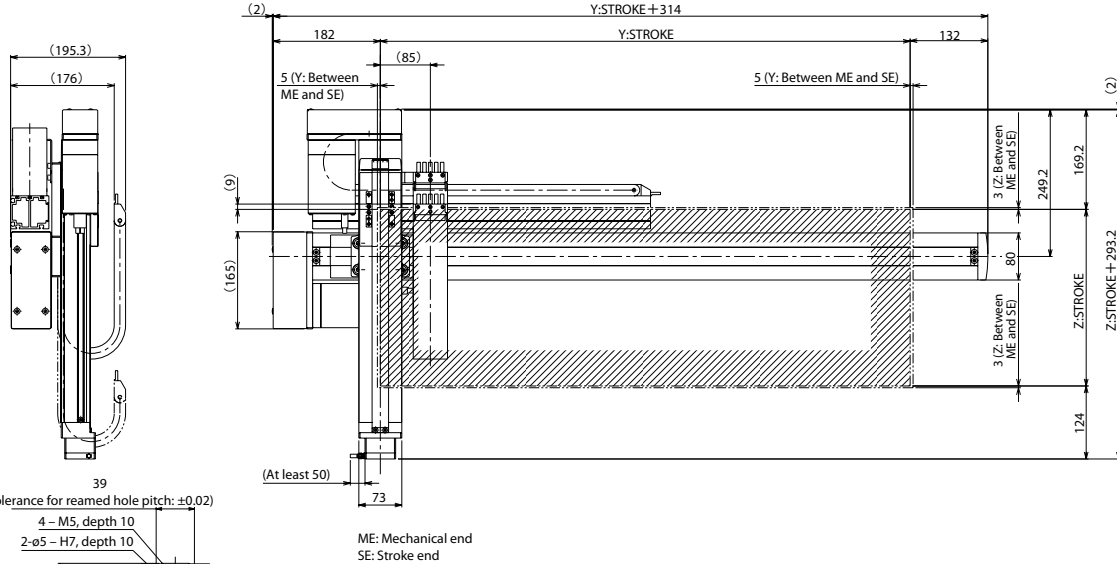
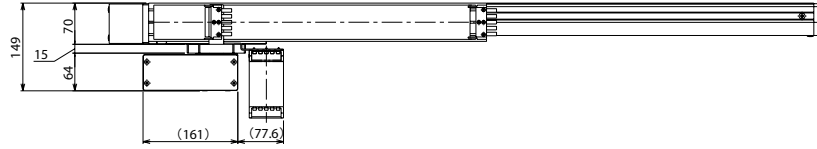

39  
(Tolerance for reamed hole pitch: ±0.02)

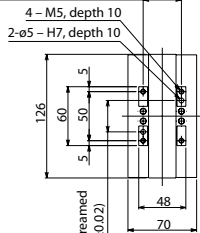

Detail view of Z-axis slider

Detail view of slot in bottom face of Y-axis base

■ Dimensions by Stroke

Y: Model	50	100	150	200	250	300	350	400	450	500	550	600	650	700	750	800	850	900	950	1000
B	50	100	150	200	250	300	350	400	450	500	550	600	650	700	750	800	850	900	950	1000
C	50	100	150	0	50	100	150	0	50	100	150	0	50	100	150	0	50	100	150	0
D	8	8	8	10	12	12	12	14	16	16	16	18	20	20	20	22	24	24	24	26
N	1	1	1	2	2	2	2	3	3	3	3	4	4	4	4	5	5	5	5	6
G	149	174	199	224	249	274	299	324	349	374	399	424	449	474	499	524	549	574	599	624

Controllers

Applicable controller

☞ Refer to P. 91 for the controllers.

2-axis  
Combinations  
R C P 2

2-axis  
Combinations  
R C S 2

3-axis  
Combinations  
R C P 2

3-axis  
Combinations  
R C S 2

Controllers

# IK2-SXBD1□□S

RCS2 2-axis Combinations X axis: SS7R (Reversed, Single-slider)  
Y axis: SA5R (Reversed)

**Model Details**

Series: IK2 — Type: SXBD1□□S — Encoder type: □ — Axis 1 (X axis): □ — Axis 2 (Y axis): □ — Controller: □ — Cable: □ — Shipping configuration: □

**Combination directions 1-2**  
HH: X high-speed, Y high-speed  
HM: X high-speed, Y medium-speed

**Differences between Single-slider and Double-slider Types**  
HH: X high-speed, Y high-speed  
HM: X high-speed, Y medium-speed

**Encoder type**  
I: Incremental  
A: Absolute

**Stroke (mm)**  
S: 50mm  
□: (Can be set in 50-mm increments)

**Options**  
NM: Opposite-home specification  
SR: Slider roller specification

**Controllers**  
T1: XSEL-J/K  
T2: SSEL  
XSEL-P/Q

**Cable length**  
1L: 1m  
3L: 3m  
5L: 5m  
□: □m

**Wiring 1**  
N: Cable only  
CT: With cable track

**Wiring 2**  
K: Individual components (kit)

\* Refer to P. 10 for details on the items comprising the model name.

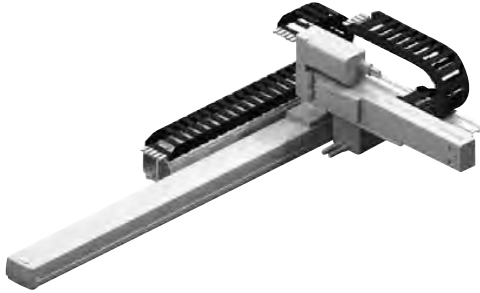

Both wiring 1 and wiring 2 assume use of a cable track.

**Maximum Stroke**

X axis 600 mm Y axis 200 mm

**Maximum Speed**

	High-speed type	Medium-speed type
X axis	600mm/s	—
Y axis	800mm/s	400mm/s

**Maximum Load Capacity**

Y-axis stroke	X high-speed, Y high-speed	X high-speed, Y medium-speed
50mm	3.0kg	6.0kg
100mm	3.0kg	6.0kg
150mm	2.5kg	5.0kg
200mm	2.5kg	5.0kg

**List by Stroke**

Y-axis stroke	Incremental				Absolute			
	50	100	150	200	50	100	150	200
50	—	—	—	—	—	—	—	—
100	—	—	—	—	—	—	—	—
150	—	—	—	—	—	—	—	—
200	—	—	—	—	—	—	—	—
250	—	—	—	—	—	—	—	—
300	—	—	—	—	—	—	—	—
350	—	—	—	—	—	—	—	—
400	—	—	—	—	—	—	—	—
450	—	—	—	—	—	—	—	—
500	—	—	—	—	—	—	—	—
550	—	—	—	—	—	—	—	—
600	—	—	—	—	—	—	—	—

**Cable track**

Wiring	Stroke	50-300	350-600
Wiring 1 (Next to X-axis)	X-axis stroke	—	—
Wiring 2 (Next to Y-axis)	Y-axis stroke	50-200	—

**List by Cable Length**

Type	Cable code	Length
Standard type	1L	1m
	3L	3m
	5L	5m

\* Axis 1 comes with a standard cable, while axis 2 comes with a robot cable.  
\* Refer to P. 90 for lengths other than those specified above.

**List of Options**

Name	Option code
Opposite-home specification	NM
Slider roller specification	SR

**Specifications**

Item	X axis	Y axis
Axis model	RCS2-SS7R	RCS2-SA5R
Stroke (Can be set in 50-mm increments)	50-600mm	50-200mm
Max speed	Stroke	50-500mm
	High speed	550-600mm
	Medium speed	—
Motor output (W)	60W	20W
Ball screw lead	High-speed type: 12mm	High-speed type: 12mm Medium-speed type: 6mm
Drive method	Ball screw, ø10 mm, rolled, C10	
Positioning repeatability	±0.02mm	
Base material	Dedicated alloy steel	Aluminum
Surrounding air temperature/humidity	0 to 40°C, 85% RH or below (non-condensing)	

43 IK2-SXBD1□□S

Note 1. The connected position shown in the drawing defines the home.  
 Note 2. Both wiring 1 and wiring 2 assume use of a cable track.  
 Note 3. For details on the cable track, refer to P. 90.  
 Note 4. For details on the bracket on the moving end of the cable track, refer to P. 90.

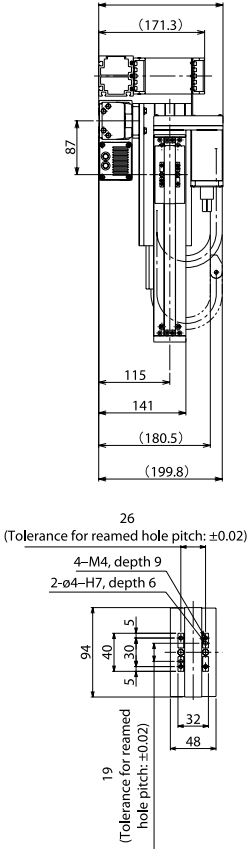

Detail view of Y-axis slider

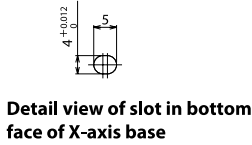

Detail view of slot in bottom face of X-axis base

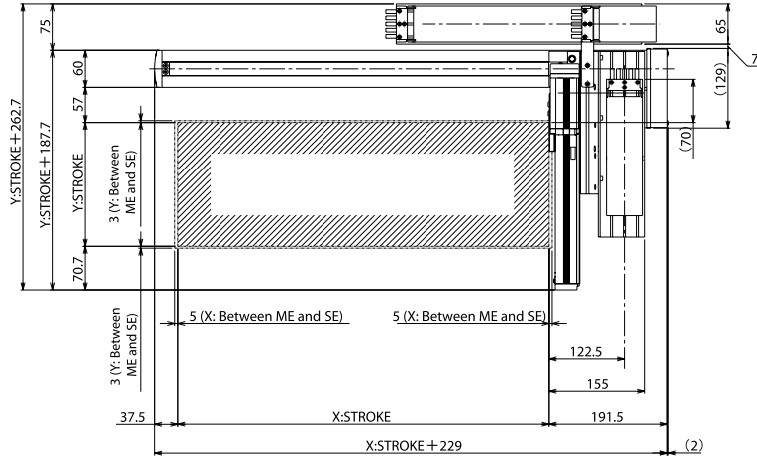

ME: Mechanical end  
 SE: Stroke end

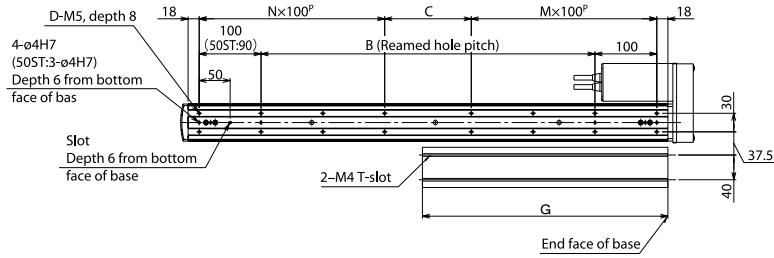
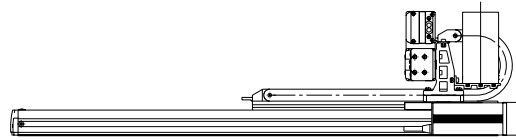

Detail view of X-axis installation

Dimensions by Stroke

X: Nominal stroke	50	100	150	200	250	300	350	400	450	500	550	600
B	0	40	90	140	190	240	290	340	390	440	490	540
C	90	40	90	140	190	40	90	140	190	40	90	140
D	6	8	8	8	8	12	12	12	12	16	16	16
M	1	1	1	1	1	2	2	2	2	3	3	3
N	0	1	1	1	1	2	2	2	2	3	3	3
G	122	147	172	197	222	247	272	297	322	347	372	397

Controllers

Applicable controller

Refer to P. 91 for the controllers.

# IK2-SXBD1□□D

RCS2 2-axis Combinations X axis: SS7R (Reversed, Double-slider) Y axis: SA5R (Reversed)

**Model Details**

Series: IK2 — Type: SXBD1□□D — Encoder type: — Axis 1 (X axis): — Axis 2 (Y axis): — Controller: — Cable: — Shipping configuration: —

**Combination directions 1-2**  
 Differences between Single-slider and Double-slider Types  
 HH: X high-speed, Y high-speed  
 HM: X high-speed, Y medium-speed

**Encoder type**  
 I: Incremental  
 A: Absolute

**Stroke (mm)**  
 S: 50mm  
 ? (Can be set in 50-mm increments)

**Options**  
 NM: Opposite-home specification  
 SR: Slider roller specification

**Controllers**  
 T1: XSEL-I/K  
 T2: SSEL  
 XSEL-P/Q

**Cable length**  
 1L: 1m  
 3L: 3m  
 5L: 5m  
 □L: □m

**Wiring 1**  
 N: Cable only  
 CT: With cable track

**Wiring 2**  
 N: Cable only  
 CT: With cable track

**Shipping configuration**  
 K: Individual components (kit)

\* Refer to P.10 for details on the items comprising the model name.

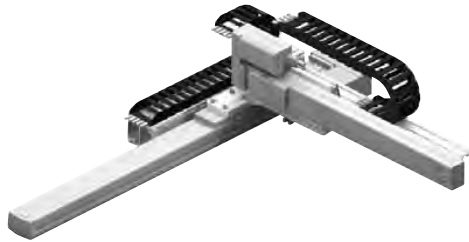

Both wiring 1 and wiring 2 assume use of a cable track.

**Maximum Stroke**

X axis 450 mm Y axis 400 mm

**Maximum Speed**

	High-speed type	Medium-speed type
X axis	600mm/s	—
Y axis	800mm/s	400mm/s

**Maximum Load Capacity**

Y-axis stroke	X high-speed, Y high-speed	X high-speed, Y medium-speed
250mm	2.5kg	5.0kg
300mm	2.0kg	4.0kg
350mm	2.0kg	4.0kg
400mm	2.0kg	4.0kg

**List by Stroke**

Y-axis stroke	Incremental				Absolute				
	250	300	350	400	250	300	350	400	
X-axis stroke	50	100	150	200	250	300	350	400	450
	—	—	—	—	—	—	—	—	—
	—	—	—	—	—	—	—	—	—
	—	—	—	—	—	—	—	—	—
	—	—	—	—	—	—	—	—	—
	—	—	—	—	—	—	—	—	—
	—	—	—	—	—	—	—	—	—
	—	—	—	—	—	—	—	—	—
	—	—	—	—	—	—	—	—	—

**Cable track**

Wiring	X-axis stroke	50-300	350-450
Wiring 1 (Next to X-axis)	Y-axis stroke	—	—
Wiring 2 (Next to Y-axis)	X-axis stroke	250-400	—
	Y-axis stroke	—	—

**List by Cable Length**

Type	Cable code	Length
Standard type	1L	1m
	3L	3m
	5L	5m

\* Axis 1 comes with a standard cable, while axis 2 comes with a robot cable.  
 \* Refer to P. 90 for lengths other than those specified above.

**List of Options**

Name	Option code
Opposite-home specification	NM
Slider roller specification	SR

**Specifications**

Item	X axis	Y axis	
Axis model	RCS2-SS7R	RCS2-SA5R	
Stroke (Can be set in 50-mm increments)	50-450mm	250-400mm	
Max speed	Stroke	250-400mm	
	High speed	600mm/s	800mm/s
	Medium speed	470mm/s	400mm/s
Motor output (W)	60W	20W	
Ball screw lead	High-speed type: 12mm	High-speed type: 12mm Medium-speed type: 6mm	
Drive method	Ball screw, ø10 mm, rolled, C10		
Positioning repeatability	±0.02mm		
Base material	Dedicated alloy steel	Aluminum	
Surrounding air temperature/humidity	0 to 40°C, 85% RH or below (non-condensing)		

Note 1. The connected position shown in the drawing defines the home.  
 Note 2. Both wiring 1 and wiring 2 assume use of a cable track.  
 Note 3. For details on the cable track, refer to P. 90.  
 Note 4. For details on the bracket on the moving end of the cable track, refer to P. 90.

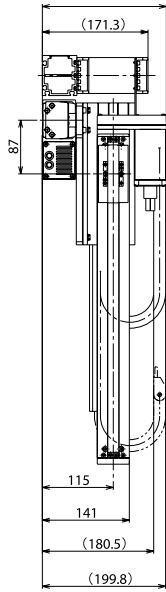

26  
 (Tolerance for reamed hole pitch: ±0.02)

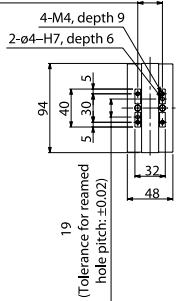

Detail view of Y-axis slider



Detail view of slot in bottom face of X-axis base

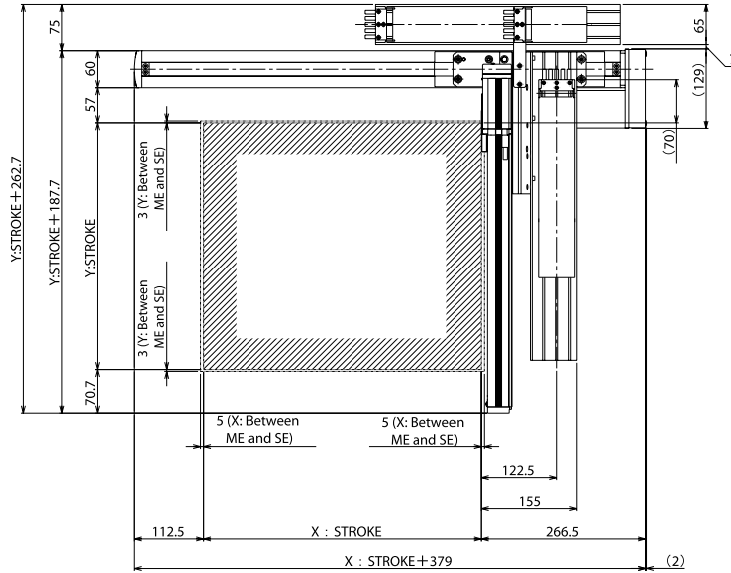

ME: Mechanical end  
 SE: Stroke end

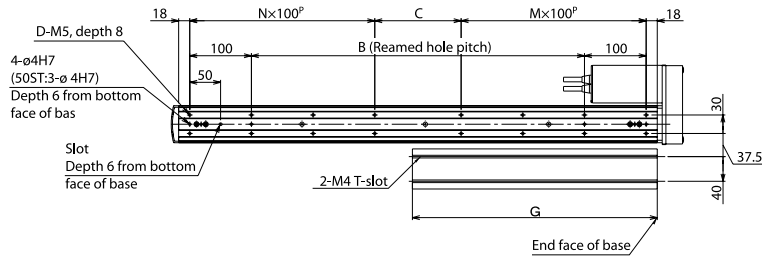
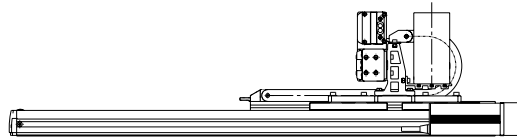

Detail view of X-axis installation

■ Dimensions by Stroke

X: Nominal stroke	200	250	300	350	400	450	500	550	600
X: Effective stroke	50	100	150	200	250	300	350	400	450
B	140	190	240	290	340	390	440	490	540
C	140	190	40	90	140	190	40	90	140
D	8	8	12	12	12	12	16	16	16
M	1	1	2	2	2	2	3	3	3
N	1	1	2	2	2	2	3	3	3
G	197	222	247	272	297	322	347	372	397

Controllers

Applicable controller

Refer to P. 91 for the controllers.

# IK2-SXBD2□□S

RCS2 2-axis Combinations X axis: SS7C (Reversed, Single-slider)  
Y axis: SA5R (Reversed)

**Model Details**

Series: IK2 — Type: SXBD2□□S — Encoder type:  — Axis 1 (X axis):  — Axis 2 (Y axis):  — Controller:  — Cable:  — Shipping configuration:

**Combination directions 1-4**

**Differences between Single-slider and Double-slider Types**  
 HH: X high-speed, Y high-speed  
 HM: X high-speed, Y medium-speed

**Encoder type**  
 I: Incremental  
 A: Absolute

**Stroke (mm)**  
 5: 50mm  
 ? (Can be set in 50-mm increments)

**Options**  
 NM: Opposite-home specification  
 SR: Slider roller specification

**Controllers**  
 T1: XSEL-J/K  
 T2: SSEL  
 XSEL-P/Q

**Cable length**  
 1L: 1m  
 3L: 3m  
 5L: 5m

**Wiring 1**  
 N: Cable only  
 CT: With cable track

**Wiring 2**  
 K: Individual components (kit)

**Shipping configuration**  
 K: Individual components (kit)

\* Refer to P.10 for details on the items comprising the model name.

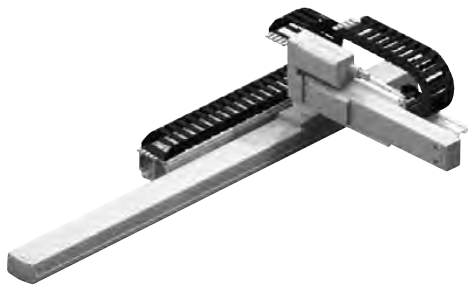

Both wiring 1 and wiring 2 assume use of a cable track.

**Maximum Stroke**

X axis 600 mm      Y axis 200 mm

**Maximum Speed**

	High-speed type	Medium-speed type
X axis	600mm/s	-
Y axis	800mm/s	400mm/s

**Maximum Load Capacity**

Y-axis stroke	X high-speed, Y high-speed	X high-speed, Y medium-speed
50mm	3.0kg	6.0kg
100mm	3.0kg	6.0kg
150mm	2.5kg	5.0kg
200mm	2.5kg	5.0kg

**List by Stroke**

Y-axis stroke	Incremental				Absolute			
	50	100	150	200	50	100	150	200
50	-	-	-	-	-	-	-	-
100	-	-	-	-	-	-	-	-
150	-	-	-	-	-	-	-	-
200	-	-	-	-	-	-	-	-
250	-	-	-	-	-	-	-	-
300	-	-	-	-	-	-	-	-
350	-	-	-	-	-	-	-	-
400	-	-	-	-	-	-	-	-
450	-	-	-	-	-	-	-	-
500	-	-	-	-	-	-	-	-
550	-	-	-	-	-	-	-	-
600	-	-	-	-	-	-	-	-

**Cable track**

Wiring	Stroke	50-300	350-600
Wiring 1 (Next to X-axis)	X-axis stroke	50-300	350-600
Wiring 2 (Next to Y-axis)	Y-axis stroke	50-200	-

**List by Cable Length**

Type	Cable code	Length
Standard type	1L	1m
	3L	3m
	5L	5m

\* Axis 1 comes with a standard cable, while axis 2 comes with a robot cable.

\* Refer to P.90 for lengths other than those specified above.

**List of Options**

Name	Option code	
Opposite-home specification	NM	
Slider roller specification	SR	Axis 1 (X-axis) Axis 2 (Y-axis)

**Specifications**

Item	X axis	Y axis
Axis model	RCS2-SS7C	RCS2-SA5R
Stroke (Can be set in 50-mm increments)	50-600mm	50-200mm
Max speed	Stroke	50-200mm
	High speed	800mm/s
Motor output (W)	Medium speed	400mm/s
	60W	20W
Ball screw lead	High-speed type: 12mm	High-speed type: 12mm
		Medium-speed type: 6mm
Drive method	Ball screw, ø10 mm, rolled, C10	
Positioning repeatability	±0.02mm	
Base material	Dedicated alloy steel	Aluminum
Surrounding air temperature/humidity	0 to 40°C, 85% RH or below (non-condensing)	

47

IK2-SXBD2□□S



Dimensions

Note 1. The connected position shown in the drawing defines the home.  
 Note 2. Both wiring 1 and wiring 2 assume use of a cable track.  
 Note 3. For details on the cable track, refer to P. 90.  
 Note 4. For details on the bracket on the moving end of the cable track, refer to P. 90.

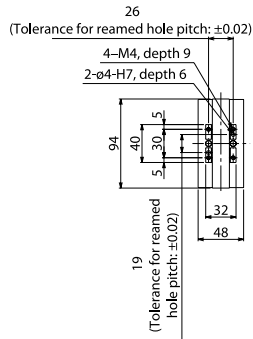
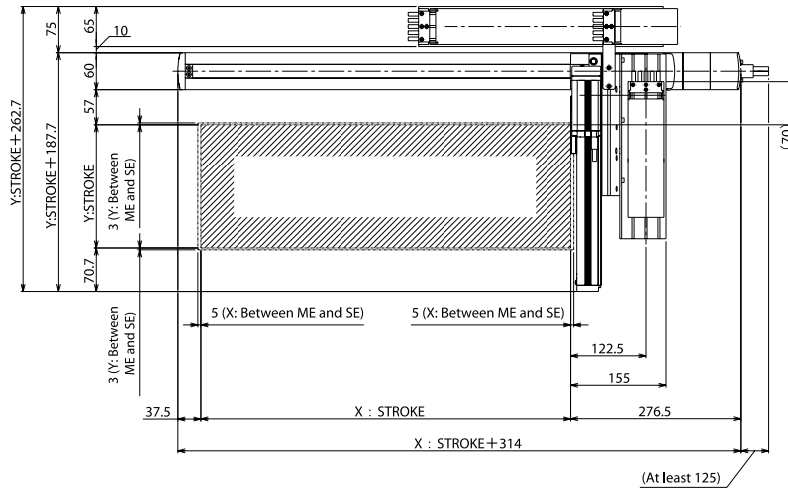
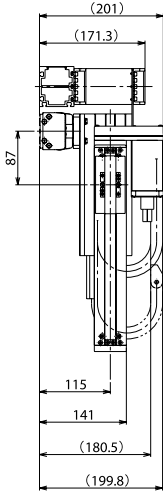

ME: Mechanical end  
 SE: Stroke end

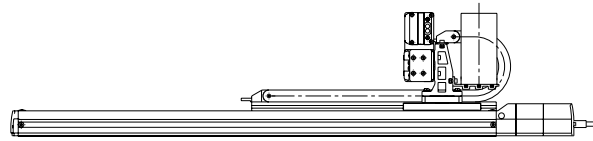

Detail view of Y-axis slider

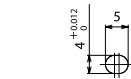

Detail view of slot in bottom face of X-axis base

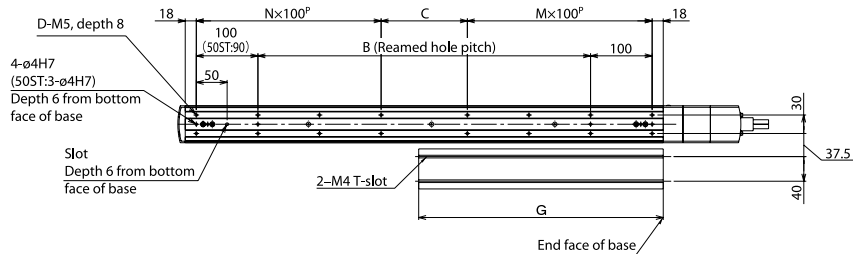

Detail view of X-axis installation

■ Dimensions by Stroke

X: Nominal stroke	50	100	150	200	250	300	350	400	450	500	550	600
B	0	40	90	140	190	240	290	340	390	440	490	540
C	90	40	90	140	190	40	90	140	190	40	90	140
D	6	8	8	8	8	12	12	12	12	16	16	16
M	1	1	1	1	1	2	2	2	2	3	3	3
N	0	1	1	1	1	2	2	2	2	3	3	3
G	122	147	172	197	222	247	272	297	322	347	372	397

Controllers

Applicable controller

☞ Refer to P. 91 for the controllers.

# IK2-SXBD2□□D

RCS2 2-axis Combinations X axis: SS7C (Straight, Double-slider) Y axis: SA5R (Reversed)

**Model Details**

Series: IK2 — Type: SXBD2□□D — Encoder type: □ — Axis 1 (X axis): □ — Axis 2 (Y axis): □ — Controllres: □ — Cable: □ — Shipping configuration: □

Combination directions 1-4: □  
 Differences between Single-slider and Double-slider Types: HH: X high-speed, Y high-speed; HM: X high-speed, Y medium-speed

Encoder type: L: Incremental; A: Absolute

Stroke (mm): 5: 50mm; ? (Can be set in 50-mm increments)

Options: NM: Opposite-home specification; SR: Slider roller specification

Controllres: T1: XSEL-J/K; T2: SSEL; XSEL-P/Q

Cable length: 1L: 1m; 3L: 3m; 5L: 5m; □L: □m

Wiring 1: N: Cable only; CT: With cable track

Wiring 2: □

Shipping configuration: R: Individual components (kit)

\* Refer to P. 10 for details on the items comprising the model name.

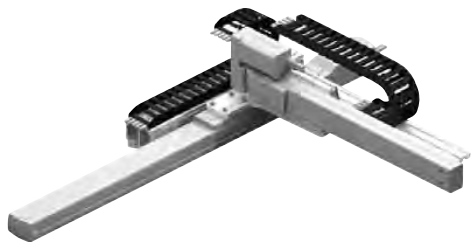

Both wiring 1 and wiring 2 assume use of a cable track.

**Maximum Stroke**

X axis 450 mm Y axis 400 mm

**Maximum Speed**

	High-speed type	Medium-speed type
X axis	600mm/s	—
Y axis	800mm/s	400mm/s

**Maximum Load Capacity**

Y-axis stroke	X high-speed, Y high-speed	X high-speed, Y medium-speed
250mm	2.5kg	5.0kg
300mm	2.0kg	4.0kg
350mm	2.0kg	4.0kg
400mm	2.0kg	4.0kg

**List by Stroke**

Y-axis stroke	Incremental	Incremental				Absolute			
		250	300	350	400	250	300	350	400
50	—	—	—	—	—	—	—	—	—
100	—	—	—	—	—	—	—	—	—
150	—	—	—	—	—	—	—	—	—
200	—	—	—	—	—	—	—	—	—
250	—	—	—	—	—	—	—	—	—
300	—	—	—	—	—	—	—	—	—
350	—	—	—	—	—	—	—	—	—
400	—	—	—	—	—	—	—	—	—
450	—	—	—	—	—	—	—	—	—

**Cable track**

Wiring	X-axis stroke	50-300	350-450
Wiring 1 (Next to X-axis)	Y-axis stroke	—	—
Wiring 2 (Next to Y-axis)	X-axis stroke	250-400	—
	Y-axis stroke	—	—

**List by Cable Length**

Type	Cable code	Length
Standard type	1L	1m
	3L	3m
	5L	5m

\* Axis 1 comes with a standard cable, while axis 2 comes with a robot cable.  
 \* Refer to P. 90 for lengths other than those specified above.

**List of Options**

Name	Option code	
Opposite-home specification	NM	
Slider roller specification	SR	Axis 1 (X-axis) Axis 2 (Y-axis)

**Specifications**

Item	X axis	Y axis
Axis model	RCS2-SS7C	RCS2-SA5R
Stroke (Can be set in 50-mm increments)	50-450mm	250-400mm
Max speed	Stroke	250-400mm
	High speed	800mm/s
	Medium speed	400mm/s
Motor output (W)	60W	20W
Ball screw lead	High-speed type: 12mm	High-speed type: 12mm Medium-speed type: 6mm
Drive method	Ball screw, ø10 mm, rolled, C10	
Positioning repeatability	±0.02mm	
Base material	Dedicated alloy steel	Aluminum
Surrounding air temperature/humidity	0 to 40°C, 85% RH or below (non-condensing)	

Note 1. The connected position shown in the drawing defines the home.  
 Note 2. Both wiring 1 and wiring 2 assume use of a cable track.  
 Note 3. For details on the cable track, refer to P. 90.  
 Note 4. For details on the bracket on the moving end of the cable track, refer to P. 90.

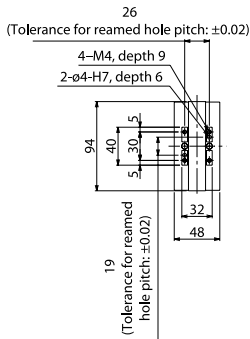
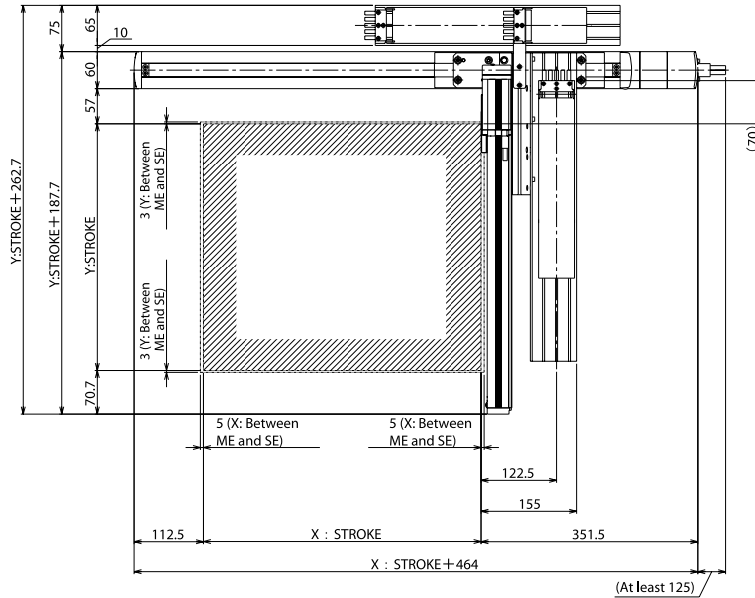
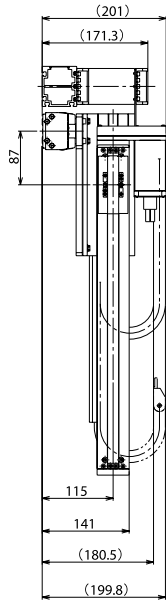

Detail view of Y-axis slider

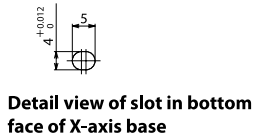

Detail view of slot in bottom face of X-axis base

ME: Mechanical end  
 SE: Stroke end

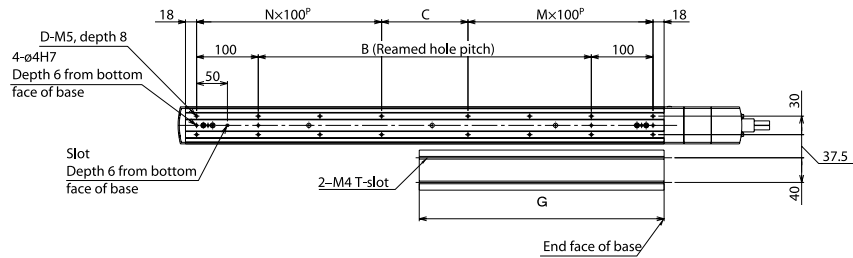
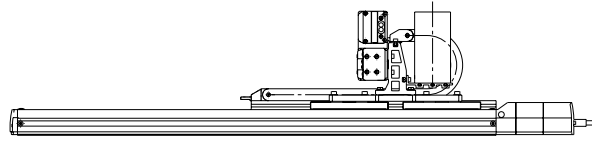

Detail view of X-axis installation

■ Dimensions by Stroke

	200	250	300	350	400	450	500	550	600
X: Nominal stroke	200	250	300	350	400	450	500	550	600
X: Effective stroke	50	100	150	200	250	300	350	400	450
B	140	190	240	290	340	390	440	490	540
C	140	190	40	90	140	190	40	90	140
D	8	8	12	12	12	12	16	16	16
M	1	1	2	2	2	2	3	3	3
N	1	1	2	2	2	2	3	3	3
G	197	222	247	272	297	322	347	372	397

Controllers

Applicable controller

☞ Refer to P. 91 for the controllers.

# IK2-SXBC1□□S

RCS2 2-axis Combinations X axis: SS7R (Reversed, Single-slider)  
Y axis: SA6R (Reversed)

**Model Details**

Series: IK2 — Type: SXBC1□□S — Encoder type: □ — Axis 1 (X axis): □ — Axis 2 (Y axis): □ — Controllers: □ — Cable: □ — Shipping configuration: □

Combination directions 1-2: □ — Differences between Single-slider and Double-slider Types: HH: X high-speed, Y high-speed; MM: X medium-speed, Y medium-speed — Encoder type: I: Incremental; A: Absolute — Stroke (mm): 5: 50mm; 2: (Can be set in 50-mm increments) — Options: NM: Opposite-home specification; SR: Slider roller specification — Controllers: T1: XSEL-I/X; T2: SSEL; XSEL-P/Q — Cable length: 1L: 1m; 3L: 3m; 5L: 5m; □L: □m — Wiring 1: N: Cable only; CT: With cable track — Wiring 2: □ — Shipping configuration: K: Individual components (kit)

\* Refer to P.10 for details on the items comprising the model name.

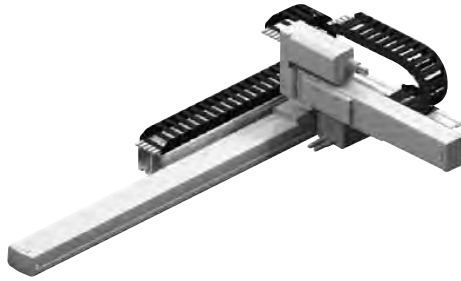

Both wiring 1 and wiring 2 assume use of a cable track.

**Maximum Stroke**

X axis 600 mm Y axis 200 mm

**Maximum Speed**

	High-speed type	Medium-speed type
X axis	600mm/s	300mm/s
Y axis	800mm/s	400mm/s

**Maximum Load Capacity**

Y-axis stroke	X high-speed, Y high-speed	X medium-speed, Y medium-speed
50mm	4.5kg	9.0kg
100mm	4.5kg	9.0kg
150mm	4.0kg	8.0kg
200mm	3.0kg	6.0kg

**List by Stroke**

Y-axis stroke		Incremental				Absolute			
		50	100	150	200	50	100	150	200
X-axis stroke	50	-	-	-	-	-	-	-	-
	100	-	-	-	-	-	-	-	-
	150	-	-	-	-	-	-	-	-
	200	-	-	-	-	-	-	-	-
	250	-	-	-	-	-	-	-	-
	300	-	-	-	-	-	-	-	-
	350	-	-	-	-	-	-	-	-
	400	-	-	-	-	-	-	-	-
	450	-	-	-	-	-	-	-	-
	500	-	-	-	-	-	-	-	-
	550	-	-	-	-	-	-	-	-
600	-	-	-	-	-	-	-	-	

**Cable track**

Wiring	Axis	50-300	350-600
Wiring 1 (Next to X-axis)	X-axis stroke	50-300	350-600
	Y-axis stroke	-	-
Wiring 2 (Next to Y-axis)	X-axis stroke	50-200	-
	Y-axis stroke	-	-

**List by Cable Length**

Type	Cable code	Length
Standard type	1L	1m
	3L	3m
	5L	5m

\* Axis 1 comes with a standard cable, while axis 2 comes with a robot cable.  
\* Refer to P.90 for lengths other than those specified above.

**List of Options**

Name	Option code	
Opposite-home specification	NM	
Slider roller specification	SR	Axis 1 (X-axis) Axis 2 (Y-axis)

**Specifications**

Item	X axis	Y axis
Axis model	RCS2-SS7R	RCS2-SA6R
Stroke (Can be set in 50-mm increments)	50-600mm	50-200mm
Max speed	Stroke	50-500mm / 550-600mm
	High speed	600mm/s / 470mm/s
	Medium speed	300mm/s / 230mm/s
Motor output (W)	60W	30W
Ball screw lead	High-speed type: 12mm Medium-speed type: 6mm	
Drive method	Ball screw, ø10 mm, rolled, C10	
Positioning repeatability	±0.02mm	
Base material	Dedicated alloy steel	Aluminum
Surrounding air temperature/humidity	0 to 40°C, 85% RH or below (non-condensing)	

51 IK2-SXBC1□□S

Note 1. The connected position shown in the drawing defines the home.  
 Note 2. Both wiring 1 and wiring 2 assume use of a cable track.  
 Note 3. For details on the cable track, refer to P.90.  
 Note 4. For details on the bracket on the moving end of the cable track, refer to P.90.

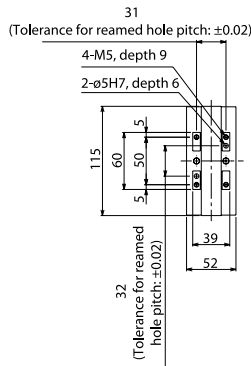
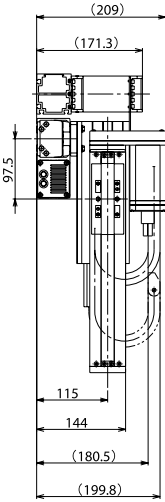

Detail view of Y-axis slider

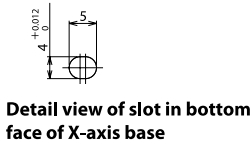

Detail view of slot in bottom face of X-axis base

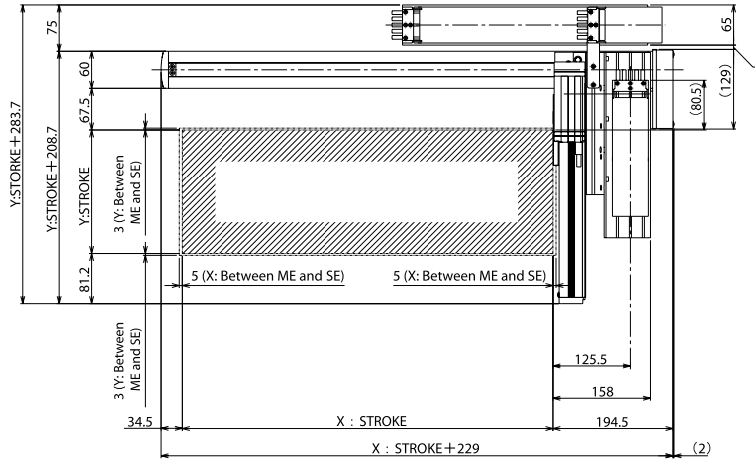

ME: Mechanical end  
 SE: Stroke end

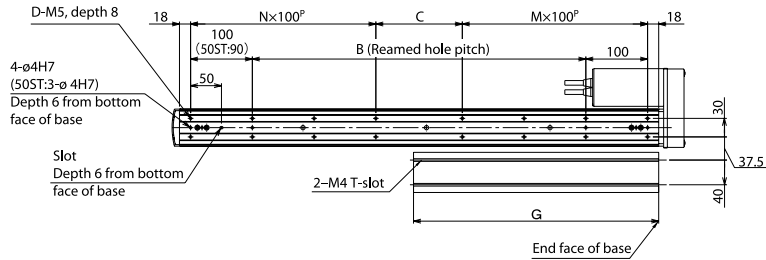
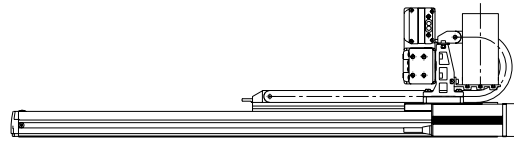

Detail view of X-axis installation

■ Dimensions by Stroke

X: Nominal stroke	50	100	150	200	250	300	350	400	450	500	550	600
B	0	40	90	140	190	240	290	340	390	440	490	540
C	90	40	90	140	190	40	90	140	190	40	90	140
D	6	8	8	8	8	12	12	12	12	16	16	16
M	1	1	1	1	1	2	2	2	2	3	3	3
N	0	1	1	1	1	2	2	2	2	3	3	3
G	122	147	172	197	222	247	272	297	322	347	372	397

Controllers

Applicable controller

☞ Refer to P. 91 for the controllers.

# IK2-SXBC1□□D

RCS2 2-axis Combinations X axis: SS7R (Reversed, Double-slider)  
Y axis: SA6R (Reversed)

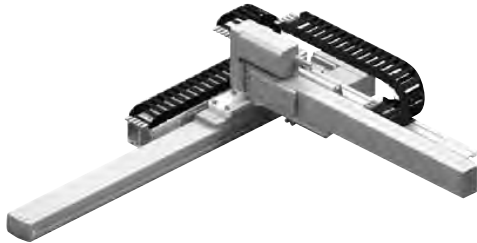
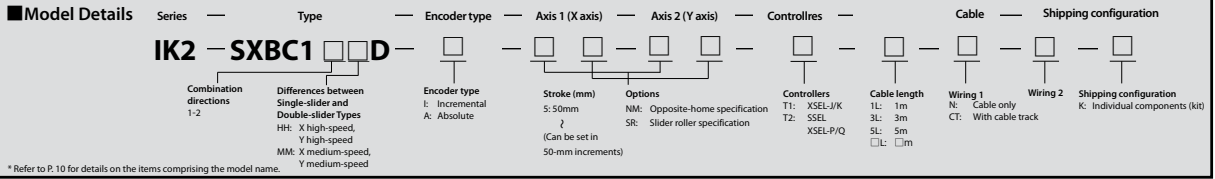

Both wiring 1 and wiring 2 assume use of a cable track.

**Maximum Stroke**

**X axis** 450 mm      **Y axis** 400 mm

**Maximum Speed**

	High-speed type	Medium-speed type
X axis	600mm/s	300mm/s
Y axis	800mm/s	400mm/s

**Maximum Load Capacity**

Y-axis stroke	X high-speed, Y high-speed	X medium-speed, Y medium-speed
250mm	3.0kg	6.0kg
300mm	3.0kg	6.0kg
350mm	3.0kg	6.0kg
400mm	3.0kg	6.0kg

**List by Stroke**

Y-axis stroke	Incremental				Absolute			
	250	300	350	400	250	300	350	400
50	-	-	-	-	-	-	-	-
100	-	-	-	-	-	-	-	-
150	-	-	-	-	-	-	-	-
200	-	-	-	-	-	-	-	-
250	-	-	-	-	-	-	-	-
300	-	-	-	-	-	-	-	-
350	-	-	-	-	-	-	-	-
400	-	-	-	-	-	-	-	-
450	-	-	-	-	-	-	-	-

**Cable track**

Wiring	Stroke	50-300	350-450
Wiring 1 (Next to X-axis)	X-axis stroke	-	-
Wiring 2 (Next to Y-axis)	Y-axis stroke	250-400	-

**List by Cable Length**

Type	Cable code	Length
Standard type	1L	1m
	3L	3m
	5L	5m

\* Axis 1 comes with a standard cable, while axis 2 comes with a robot cable.  
\* Refer to P.90 for lengths other than those specified above.

**List of Options**

Name	Option code
Opposite-home specification	NM
Slider roller specification	SR

Axis 1 (X-axis)  
Axis 2 (Y-axis)

**Specifications**

Item	X axis	Y axis
Axis model	RCS2-SS7R	RCS2-SA6R
Stroke (Can be set in 50-mm increments)	50-450mm	250-400mm
Max speed	Stroke	50-350mm / 400-450mm
	High speed	600mm/s / 470mm/s
	Medium speed	300mm/s / 230mm/s
Motor output (W)	60W	30W
Ball screw lead	High-speed type: 12mm Medium-speed type: 6mm	
Drive method	Ball screw, ø10 mm, rolled, C10	
Positioning repeatability	±0.02mm	
Base material	Dedicated alloy steel	Aluminum
Surrounding air temperature/humidity	0 to 40°C, 85% RH or below (non-condensing)	

Note 1. The connected position shown in the drawing defines the home.  
 Note 2. Both wiring 1 and wiring 2 assume use of a cable track.  
 Note 3. For details on the cable track, refer to P.90.  
 Note 4. For details on the bracket on the moving end of the cable track, refer to P.90.

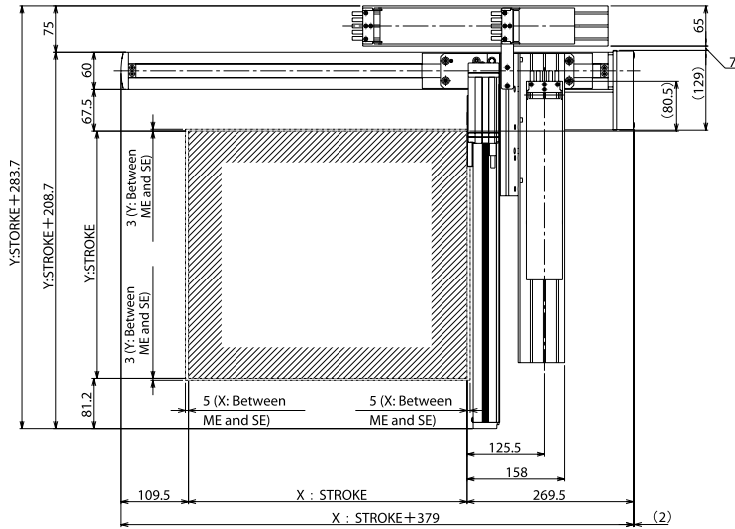
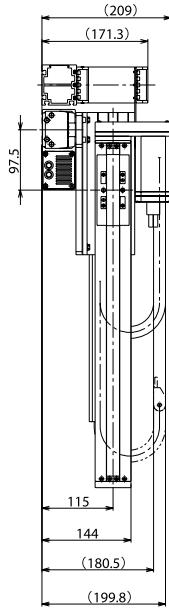

31  
 (Tolerance for reamed hole pitch: ±0.02)

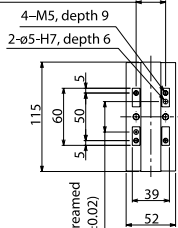

Detail view of Y-axis slider

Detail view of slot in bottom face of X-axis base



ME: Mechanical end  
 SE: Stroke end

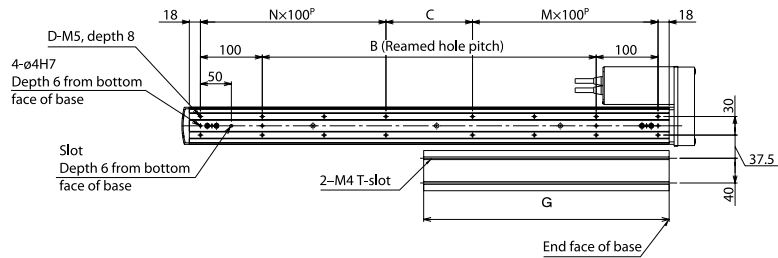
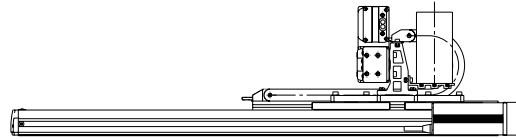

Detail view of X-axis installation

■ Dimensions by Stroke

X: Nominal stroke	200	250	300	350	400	450	500	550	600
X: Effective stroke	50	100	150	200	250	300	350	400	450
B	140	190	240	290	340	390	440	490	540
C	140	190	40	90	140	190	40	90	140
D	8	8	12	12	12	12	16	16	16
M	1	1	2	2	2	2	3	3	3
N	1	1	2	2	2	2	3	3	3
G	197	222	247	272	297	322	347	372	397

Controllers

Applicable controller



Refer to P. 91 for the controllers.

# IK2-SXBC2□□S

RCS2 2-axis Combinations X axis: SS7C (Straight, Single-slider) Y axis: SA6R (Reversed)

**Model Details**

Series: IK2 — Type: SXBC2□□S — Encoder type: I: Incremental, A: Absolute — Axis 1 (X axis): Stroke (mm) 5: 50mm, ? (Can be set in 50-mm increments) — Axis 2 (Y axis): Options: NM: Opposite-home specification, SR: Slider roller specification — Controllers: T1: XSEL-J/K, T2: XSEL — Cable length: TL: 1m, 3L: 3m, SL: 5m, □L: □m — Wiring 1: N: Cable only, CT: With cable track — Wiring 2: — Shipping configuration: K: Individual components (kit)

\* Refer to P.10 for details on the items comprising the model name.

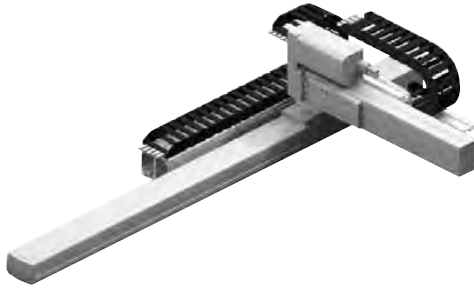

Both wiring 1 and wiring 2 assume use of a cable track.

**Maximum Stroke**

X axis 600 mm Y axis 200 mm

**Maximum Speed**

	High-speed type	Medium-speed type
X axis	600mm/s	300mm/s
Y axis	800mm/s	400mm/s

**Maximum Load Capacity**

Y-axis stroke	X high-speed, Y high-speed	X medium-speed, Y medium-speed
50mm	4.5kg	9.0kg
100mm	4.5kg	9.0kg
150mm	4.0kg	8.0kg
200mm	3.0kg	6.0kg

**List by Stroke**

Y-axis stroke	Incremental				Absolute			
	50	100	150	200	50	100	150	200
50	-	-	-	-	-	-	-	-
100	-	-	-	-	-	-	-	-
150	-	-	-	-	-	-	-	-
200	-	-	-	-	-	-	-	-
250	-	-	-	-	-	-	-	-
300	-	-	-	-	-	-	-	-
350	-	-	-	-	-	-	-	-
400	-	-	-	-	-	-	-	-
450	-	-	-	-	-	-	-	-
500	-	-	-	-	-	-	-	-
550	-	-	-	-	-	-	-	-
600	-	-	-	-	-	-	-	-

**Cable track**

Wiring	Stroke	50-300	350-600
Wiring 1 (Next to X-axis)	X-axis stroke	50-300	350-600
Wiring 2 (Next to Y-axis)	Y-axis stroke	50-200	-

**List by Cable Length**

Type	Cable code	Length
Standard type	1L	1m
	3L	3m
	5L	5m

\* Axis 1 comes with a standard cable, while axis 2 comes with a robot cable.  
\* Refer to P.90 for lengths other than those specified above.

**List of Options**

Name	Option code	
Opposite-home specification	NM	
Slider roller specification	SR	Axis 1 (X-axis) Axis 2 (Y-axis)

**Specifications**

Item	X axis	Y axis
Axis model	RCS2-SS7C	RCS2-SA6R
Stroke (Can be set in 50-mm increments)	50-600mm	50-200mm
Max speed	Stroke	50-500mm
	High speed	600mm/s
	Medium speed	300mm/s
Motor output (W)	60W	30W
Ball screw lead	High-speed type: 12mm Medium-speed type: 6mm	
Drive method	Ball screw, ø10 mm, rolled, C10	
Positioning repeatability	±0.02mm	
Base material	Dedicated alloy steel	Aluminum
Surrounding air temperature/humidity	0 to 40°C, 85% RH or below (non-condensing)	



Note 1. The connected position shown in the drawing defines the home.  
 Note 2. Both wiring 1 and wiring 2 assume use of a cable track.  
 Note 3. For details on the cable track, refer to P.90.  
 Note 4. For details on the bracket on the moving end of the cable track, refer to P.90.

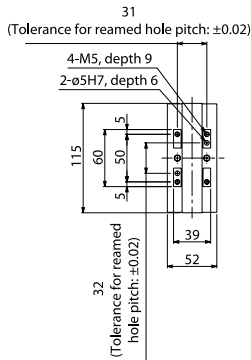
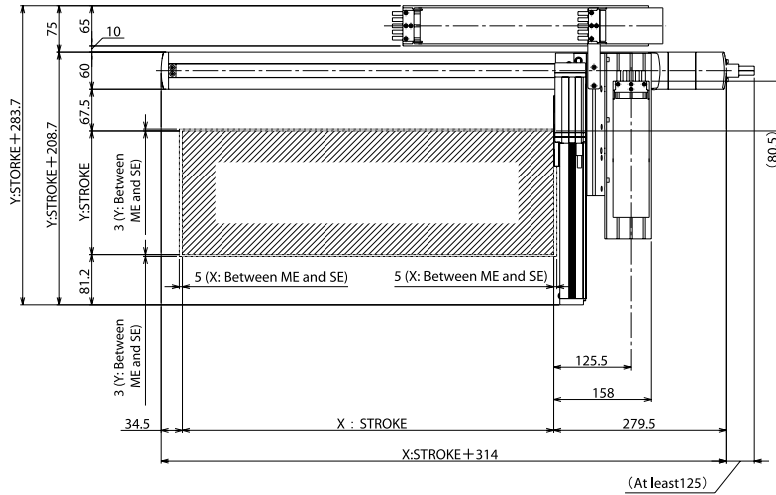
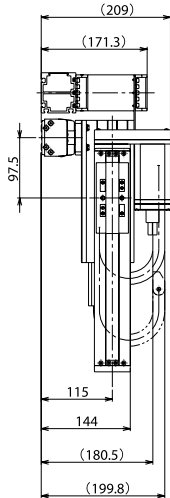

ME: Mechanical end  
 SE: Stroke end

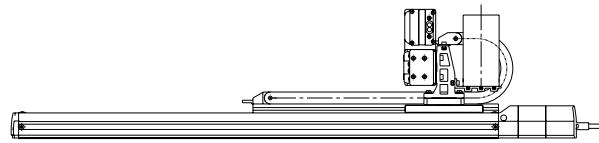

Detail view of Y-axis slider



Detail view of slot in bottom face of X-axis base

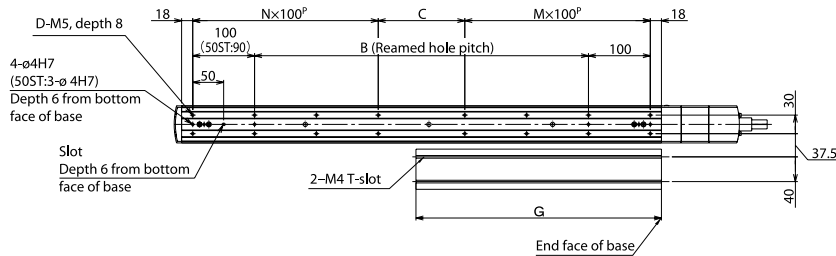

Detail view of X-axis installation

■ Dimensions by Stroke

X: Nominal stroke	50	100	150	200	250	300	350	400	450	500	550	600
B	0	40	90	140	190	240	290	340	390	440	490	540
C	90	40	90	140	190	40	90	140	190	40	90	140
D	6	8	8	8	8	12	12	12	12	16	16	16
M	1	1	1	1	1	2	2	2	2	3	3	3
N	0	1	1	1	1	2	2	2	2	3	3	3
G	122	147	172	197	222	247	272	297	322	347	372	397

Controllers

Applicable controller



Refer to P. 91 for the controllers.

# IK2-SXBC2□□D

RCS2 2-axis Combinations X axis: SS7C (Straight, Double-slider)  
Y axis: SA6R (Reversed)

## Model Details

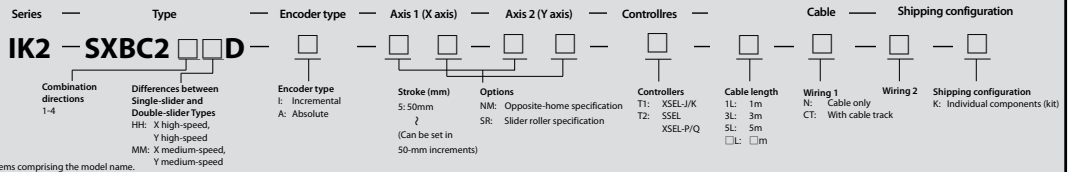

\* Refer to P.10 for details on the items comprising the model name.

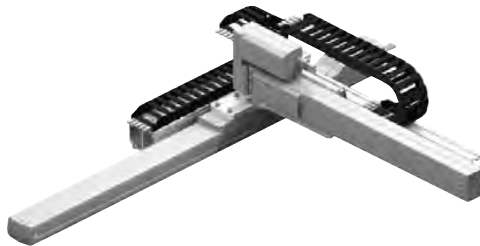

Both wiring 1 and wiring 2 assume use of a cable track.

## Maximum Stroke

X axis 450 mm Y axis 400 mm

## Maximum Speed

	High-speed type	Medium-speed type
X axis	600mm/s	300mm/s
Y axis	800mm/s	400mm/s

## Maximum Load Capacity

Y-axis stroke	X high-speed, Y high-speed	X medium-speed, Y medium-speed
250mm	3.0kg	6.0kg
300mm	3.0kg	6.0kg
350mm	3.0kg	6.0kg
400mm	3.0kg	6.0kg

## List by Stroke

		Incremental				Absolute			
		Y-axis stroke	250	300	350	400	250	300	350
X-axis stroke	50	-	-	-	-	-	-	-	-
	100	-	-	-	-	-	-	-	-
	150	-	-	-	-	-	-	-	-
	200	-	-	-	-	-	-	-	-
	250	-	-	-	-	-	-	-	-
	300	-	-	-	-	-	-	-	-
	350	-	-	-	-	-	-	-	-
	400	-	-	-	-	-	-	-	-
	450	-	-	-	-	-	-	-	-

## Cable track

Wiring 1 (Next to X-axis)	X-axis stroke	50-300	350-450
	Y-axis stroke	-	-
Wiring 2 (Next to Y-axis)	X-axis stroke	250-400	-
	Y-axis stroke	-	-

## List by Cable Length

Type	Cable code	Length
Standard type	1L	1m
	3L	3m
	5L	5m

\* Axis 1 comes with a standard cable, while axis 2 comes with a robot cable.

\* Refer to P.90 for lengths other than those specified above.

## List of Options

Name	Option code	
Opposite-home specification	NM	
Slider roller specification	SR	Axis 1 (X-axis) Axis 2 (Y-axis)

## Specifications

Item	X axis	Y axis	
Axis model	RCS2-SS7C	RCS2-SA6R	
Stroke (Can be set in 50-mm increments)	50-450mm	250-400mm	
Max speed	Stroke	400-450mm	
	High speed	600mm/s	470mm/s
	Medium speed	300mm/s	230mm/s
Motor output (W)	60W	30W	
Ball screw lead	High-speed type: 12mm Medium-speed type: 6mm		
Drive method	Ball screw, ø10 mm, rolled, C10		
Positioning repeatability	±0.02mm		
Base material	Dedicated alloy steel	Aluminum	
Surrounding air temperature/humidity	0 to 40°C, 85% RH or below (non-condensing)		

Note 1. The connected position shown in the drawing defines the home.  
 Note 2. Both wiring 1 and wiring 2 assume use of a cable track.  
 Note 3. For details on the cable track, refer to P. 90.  
 Note 4. For details on the bracket on the moving end of the cable track, refer to P. 90.

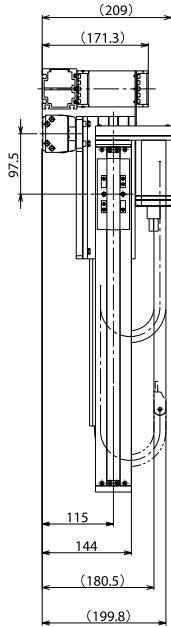

31  
 (Tolerance for reamed hole pitch: ±0.02)

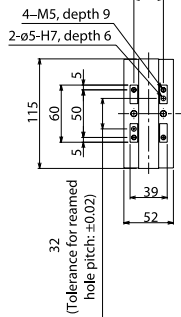

Detail view of Y-axis slider



Detail view of slot in bottom face of X-axis base

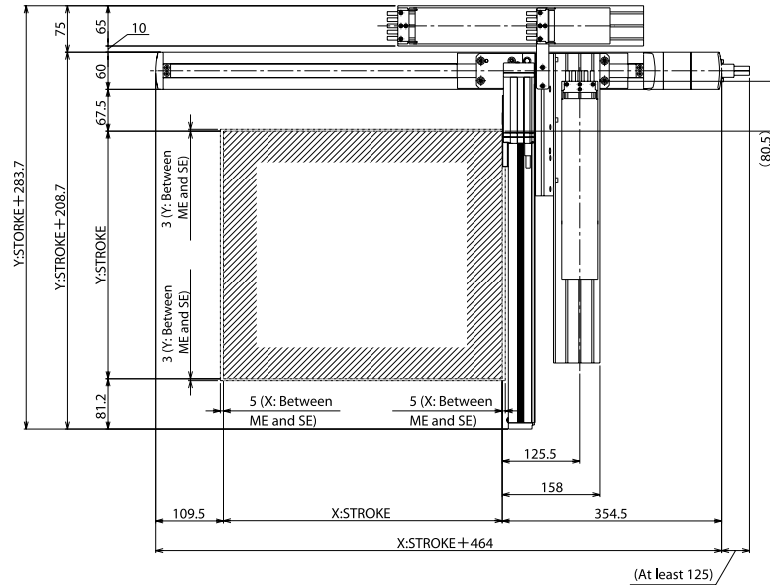

ME: Mechanical end  
 SE: Stroke end

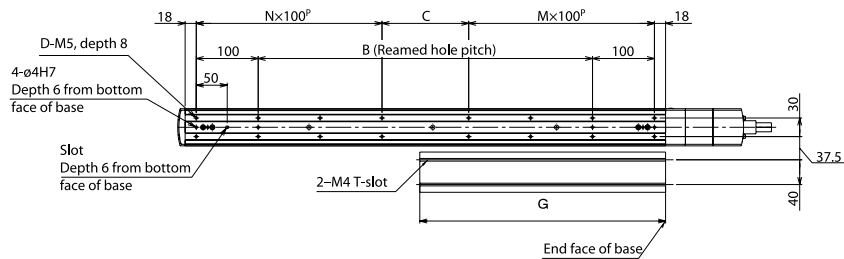
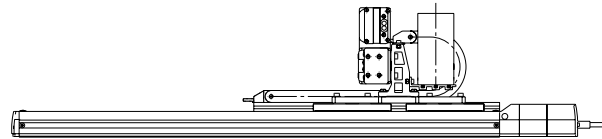

Detail view of X-axis installation

■ Dimensions by Stroke

X: Nominal stroke	200	250	300	350	400	450	500	550	600
X: Effective stroke	50	100	150	200	250	300	350	400	450
B	140	190	240	290	340	390	440	490	540
C	140	190	40	90	140	190	40	90	140
D	8	8	12	12	12	12	16	16	16
M	1	1	2	2	2	2	3	3	3
N	1	1	2	2	2	2	3	3	3
G	197	222	247	272	297	322	347	372	397

Controllers

Applicable controller



Refer to P. 91 for the controllers.

# IK2-SXBB1□□S

RCS2 2-axis Combinations X axis: SS8R (100W, Reversed, Single-slider)  
Y axis: SA7R (Reversed)

**Model Details** Series — Type — Encoder type — Axis 1 (X axis) — Axis 2 (Y axis) — Controller — Cable — Shipping configuration

**IK2 — SXBB1□□S**

**Combination directions 1-2**  
 Differences between Single-slider and Double-slider Types  
 HH: X high-speed, Y high-speed  
 MM: X medium-speed, Y medium-speed

**Encoder type**  
 I: Incremental  
 A: Absolute

**Stroke (mm)**  
 S: 50mm  
 ? (Can be set in 50-mm increments)

**Options**  
 NM: Opposite-home specification  
 SR: Slider roller specification

**Controllers**  
 T1: XSEL-J/K  
 T2: SSEL  
 XSEL-P/Q

**Cable length**  
 1L: 1m  
 3L: 3m  
 5L: 5m  
 L:  m

**Wiring 1**  
 N: Cable only  
 CT: With cable track

**Wiring 2**  
 N: Cable only  
 CT: With cable track

**Shipping configuration**  
 K: Individual components (kit)

\* Refer to P. 10 for details on the items comprising the model name.



Both wiring 1 and wiring 2 assume use of a cable track.

**Maximum Stroke**

X axis 1000 mm      Y axis 300 mm

**Maximum Speed**

	High-speed type	Medium-speed type
X axis	1000mm/s	500mm/s
Y axis	800mm/s	400mm/s

**Maximum Load Capacity**

Y-axis stroke	X high-speed, Y high-speed	X medium-speed, Y medium-speed
50mm	8.0kg	16kg
100mm	8.0kg	16kg
150mm	7.0kg	15kg
200mm	7.0kg	12.5kg
250mm	6.0kg	9.0kg
300mm	6.0kg	8.0kg

**List by Stroke**

Y-axis stroke	Incremental						Absolute					
	50	100	150	200	250	300	50	100	150	200	250	300
50	-	-	-	-	-	-	-	-	-	-	-	-
100	-	-	-	-	-	-	-	-	-	-	-	-
150	-	-	-	-	-	-	-	-	-	-	-	-
200	-	-	-	-	-	-	-	-	-	-	-	-
250	-	-	-	-	-	-	-	-	-	-	-	-
300	-	-	-	-	-	-	-	-	-	-	-	-
350	-	-	-	-	-	-	-	-	-	-	-	-
400	-	-	-	-	-	-	-	-	-	-	-	-
450	-	-	-	-	-	-	-	-	-	-	-	-
500	-	-	-	-	-	-	-	-	-	-	-	-
550	-	-	-	-	-	-	-	-	-	-	-	-
600	-	-	-	-	-	-	-	-	-	-	-	-
650	-	-	-	-	-	-	-	-	-	-	-	-
700	-	-	-	-	-	-	-	-	-	-	-	-
750	-	-	-	-	-	-	-	-	-	-	-	-
800	-	-	-	-	-	-	-	-	-	-	-	-
850	-	-	-	-	-	-	-	-	-	-	-	-
900	-	-	-	-	-	-	-	-	-	-	-	-
950	-	-	-	-	-	-	-	-	-	-	-	-
1000	-	-	-	-	-	-	-	-	-	-	-	-

**List by Cable Length**

Type	Cable code	Length
Standard type	1L	1m
	3L	3m
	5L	5m

\* Axis 1 comes with a standard cable, while axis 2 comes with a robot cable.  
\* Refer to P. 90 for lengths other than those specified above.

**Cable track**

Wiring 1 (Next to X-axis)	X-axis stroke	50-300	350-600	650-900	950-1000
Wiring 2 (Next to Y-axis)	Y-axis stroke	50-200	250-300	-	-

**List of Options**

Name	Option code	
Opposite-home specification	NM	
Slider roller specification	SR	Axis 1 (X-axis) Axis 2 (Y-axis)

**Specifications**

Item	X axis						Y axis
Axis model	RCS2-SS8R						RCS2-SA7R
Stroke (Can be set in 50-mm increments)	50-1000mm						50-300mm
Max speed	Stroke	50-600mm	650-700mm	750-800mm	850-900mm	950-1000mm	50-300mm
	High speed	1000mm/s	960mm/s	765mm/s	625mm/s	515mm/s	800mm/s
	Medium speed	500mm/s	480mm/s	380mm/s	310mm/s	255mm/s	400mm/s
Motor output (W)	100W						60W
Ball screw lead	High-speed type: 20mm Medium-speed type: 10mm						High-speed type: 16mm Medium-speed type: 8mm
Drive method	Ball screw, ø16 mm, rolled, C10						Ball screw, ø12 mm, rolled, C10
Positioning repeatability	±0.02mm						
Base material	Dedicated alloy steel						Aluminum
Surrounding air temperature/humidity	0 to 40°C, 85% RH or below (non-condensing)						

59

IK2-SXBB1□□S

Note 1. The connected position shown in the drawing defines the home.  
 Note 2. Both wiring 1 and wiring 2 assume use of a cable track.  
 Note 3. For details on the cable track, refer to P. 90.  
 Note 4. For details on the bracket on the moving end of the cable track, refer to P. 90.

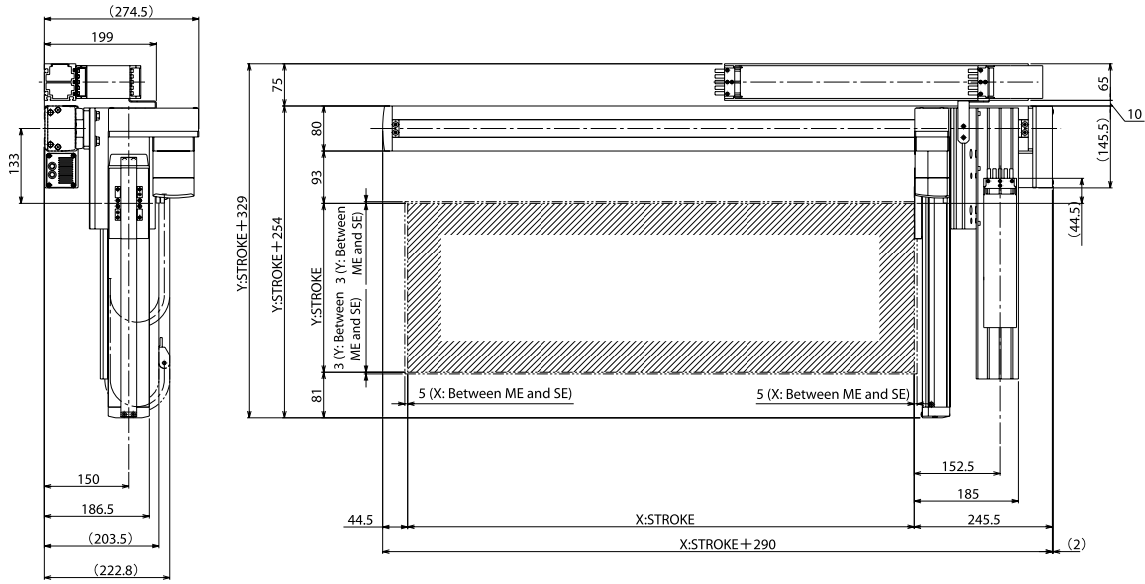

39  
 (Tolerance for reamed hole pitch: ±0.02)

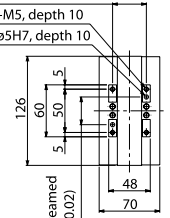

Detail view of Y-axis slider

Detail view of slot in bottom face of X-axis base



ME: Mechanical end  
 SE: Stroke end

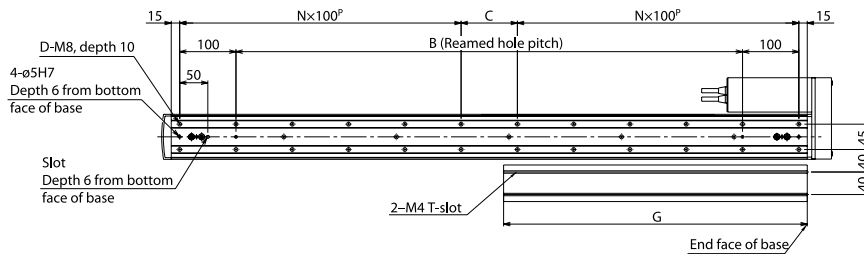
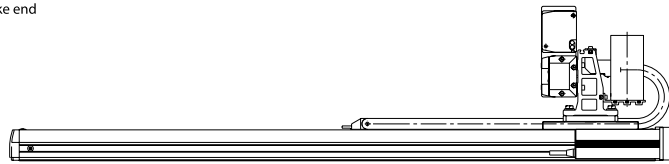

Detail view of X-axis installation

■ Dimensions by Stroke

X: Nominal stroke	50	100	150	200	250	300	350	400	450	500	550	600	650	700	750	800	850	900	950	1000
B	50	100	150	200	250	300	350	400	450	500	550	600	650	700	750	800	850	900	950	1000
C	50	100	150	0	50	100	150	0	50	100	150	0	50	100	150	0	50	100	150	0
D	8	8	8	10	12	12	12	14	16	16	16	18	20	20	20	22	24	24	24	26
N	1	1	1	2	2	2	2	3	3	3	3	4	4	4	4	5	5	5	5	6
G	114.5	139.5	164.5	189.5	214.5	239.5	264.5	289.5	314.5	339.5	364.5	389.5	414.5	439.5	464.5	489.5	514.5	539.5	564.5	589.5

Controllers

Applicable controller



Refer to P. 91 for the controllers.

# IK2-SXBB1□□D

RCS2 2-axis Combinations X axis: SS8R (100W, Reversed, Double-slider)  
Y axis: SA7R (Reversed)

Model Details

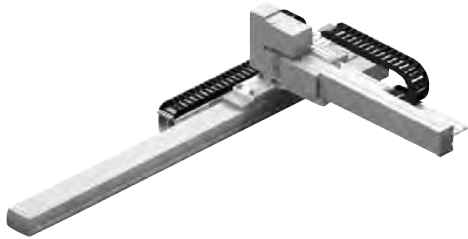
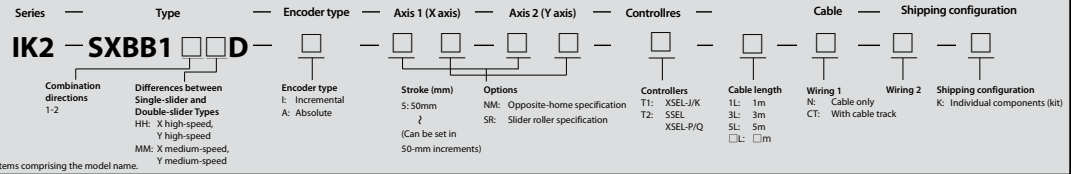

Both wiring 1 and wiring 2 assume use of a cable track.

Maximum Stroke

X axis	800 mm	Y axis	400 mm
--------	--------	--------	--------

Maximum Speed

	High-speed type	Medium-speed type
X axis	1000mm/s	500mm/s
Y axis	800mm/s	400mm/s

Maximum Load Capacity

Y-axis stroke	X high-speed, Y high-speed	X medium-speed, Y medium-speed
200mm	—	15kg
250mm	—	12.5kg
300mm	—	12.5kg
350mm	6.0kg	12kg
400mm	5.5kg	10.5kg

List by Stroke

Y-axis stroke	Incremental					Absolute				
	200	250	300	350	400	200	250	300	350	400
50	—	—	—	—	—	—	—	—	—	—
100	—	—	—	—	—	—	—	—	—	—
150	—	—	—	—	—	—	—	—	—	—
200	—	—	—	—	—	—	—	—	—	—
250	—	—	—	—	—	—	—	—	—	—
300	—	—	—	—	—	—	—	—	—	—
350	—	—	—	—	—	—	—	—	—	—
400	—	—	—	—	—	—	—	—	—	—
450	—	—	—	—	—	—	—	—	—	—
500	—	—	—	—	—	—	—	—	—	—
550	—	—	—	—	—	—	—	—	—	—
600	—	—	—	—	—	—	—	—	—	—
650	—	—	—	—	—	—	—	—	—	—
700	—	—	—	—	—	—	—	—	—	—
750	—	—	—	—	—	—	—	—	—	—
800	—	—	—	—	—	—	—	—	—	—

Note: For the X high-speed/Y high-speed type, the Y-axis stroke must be 350 mm or more.

List by Cable Length

Type	Cable code	Length
Standard type	1L	1m
	3L	3m
	5L	5m

\* Axis 1 comes with a standard cable, while axis 2 comes with a robot cable.

\* Refer to P.90 for lengths other than those specified above.

Cable track

Wiring 1 (Next to X-axis)	X-axis stroke	50-300	350-600	650-800
Wiring 2 (Next to Y-axis)	Y-axis stroke	200	250-400	—

List of Options

Name	Option code	
Opposite-home specification	NM	
Slider roller specification	SR	Axis 1 (X-axis) Axis 2 (Y-axis)

Specifications

Item	X axis					Y axis	
Axis model	RCS2-SS8R					RCS2-SA7R	
Stroke (Can be set in 50-mm increments)	50-800mm					High-speed type: 350-400mm Medium-speed type: 200-400mm	
Max speed	Stroke	50-400mm	450-500mm	550-600mm	650-700mm	750-800mm	200-400mm
	High speed	1000mm/s	960mm/s	765mm/s	625mm/s	515mm/s	800mm/s
	Medium speed	500mm/s	480mm/s	380mm/s	310mm/s	255mm/s	400mm/s
Motor output (W)	100W					60W	
Ball screw lead	High-speed type: 20mm Medium-speed type: 10mm					High-speed type: 16mm Medium-speed type: 8mm	
Drive method	Ball screw, ø16 mm, rolled, C10					Ball screw, ø12 mm, rolled, C10	
Positioning repeatability	±0.02mm						
Base material	Dedicated alloy steel					Aluminum	
Surrounding air temperature/humidity	0 to 40°C, 85% RH or below (non-condensing)						

Note 1. The connected position shown in the drawing defines the home.  
 Note 2. Both wiring 1 and wiring 2 assume use of a cable track.  
 Note 3. For details on the cable track, refer to P.90.  
 Note 4. For details on the bracket on the moving end of the cable track, refer to P.90.

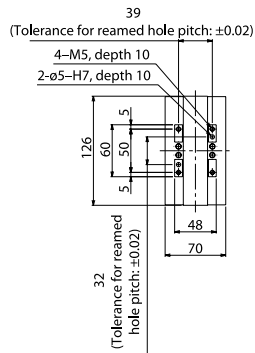
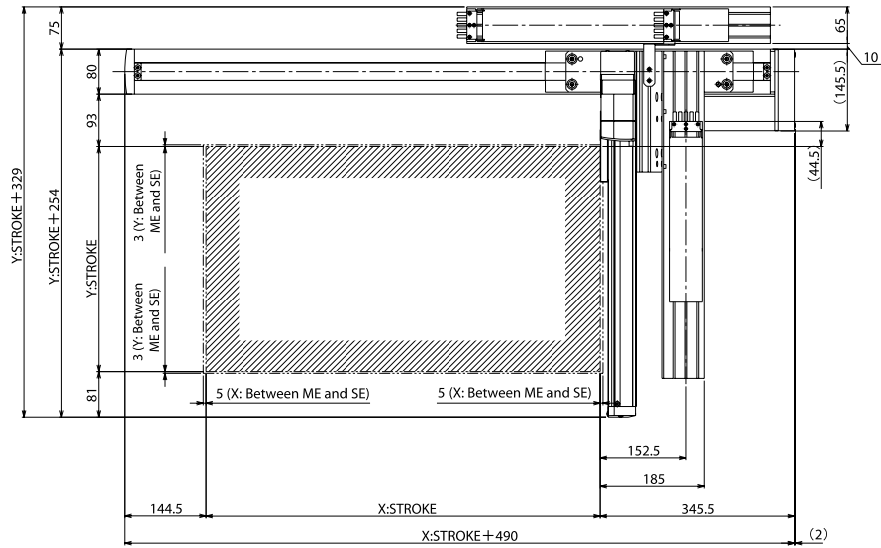
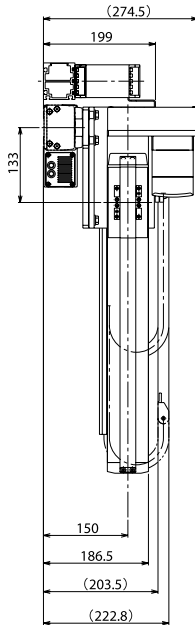

Detail view of Y-axis slider

Detail view of slot in bottom face of X-axis base



ME: Mechanical end  
 SE: Stroke end

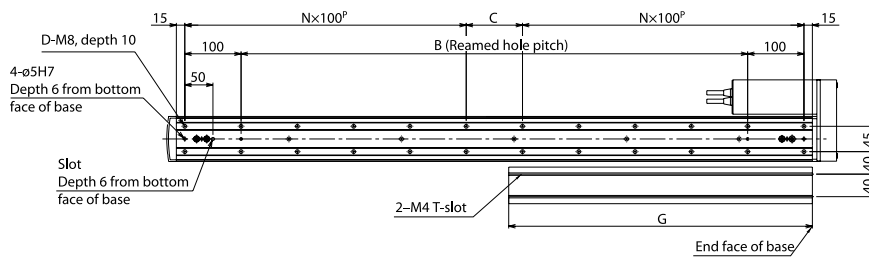
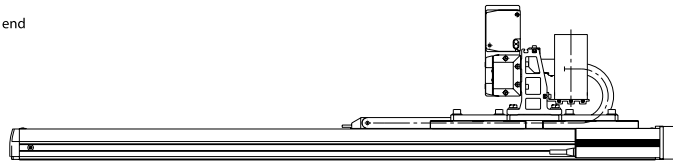

Detail view of X-axis installation

■ Dimensions by Stroke

	250	300	350	400	450	500	550	600	650	700	750	800	850	900	950	1000
X: Nominal stroke	250	300	350	400	450	500	550	600	650	700	750	800	850	900	950	1000
X: Effective stroke	50	100	150	200	250	300	350	400	450	500	550	600	650	700	750	800
B	250	300	350	400	450	500	550	600	650	700	750	800	850	900	950	1000
C	50	100	150	0	50	100	150	0	50	100	150	0	50	100	150	0
D	12	12	12	14	16	16	16	18	20	20	20	22	24	24	24	26
N	2	2	2	3	3	3	3	4	4	4	4	5	5	5	5	6
G	214.5	239.5	264.5	289.5	314.5	339.5	364.5	389.5	414.5	439.5	464.5	489.5	514.5	539.5	564.5	589.5

Controllers

Applicable controller



Refer to P. 91 for the controllers.

# IK2-SXBB2□□S

RCS2 2-axis Combinations X axis: SS8C (100W, Straight, Single-slider)  
Y axis: SA7R (Reversed)

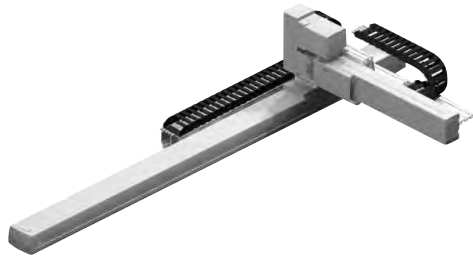
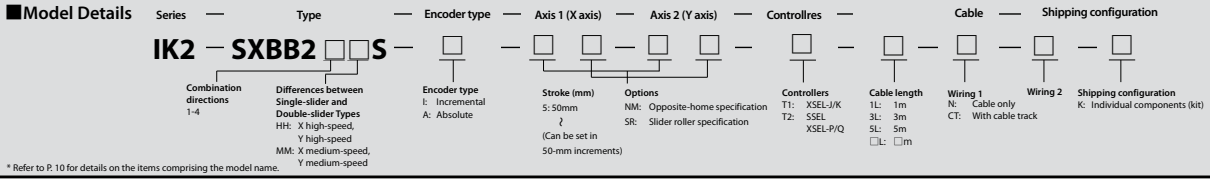

Both wiring 1 and wiring 2 assume use of a cable track.

**Maximum Stroke**

X axis 1000 mm      Y axis 300 mm

**Maximum Speed**

	High-speed type	Medium-speed type
X axis	1000mm/s	500mm/s
Y axis	800mm/s	400mm/s

**Maximum Load Capacity**

Y-axis stroke	X high-speed, Y high-speed	X medium-speed, Y medium-speed
50mm	8.0kg	16kg
100mm	8.0kg	16kg
150mm	7.0kg	15kg
200mm	7.0kg	12.5kg
250mm	6.0kg	9.0kg
300mm	6.0kg	8.0kg

**List by Stroke**

Y-axis stroke	Incremental						Absolute					
	50	100	150	200	250	300	50	100	150	200	250	300
50	-	-	-	-	-	-	-	-	-	-	-	-
100	-	-	-	-	-	-	-	-	-	-	-	-
150	-	-	-	-	-	-	-	-	-	-	-	-
200	-	-	-	-	-	-	-	-	-	-	-	-
250	-	-	-	-	-	-	-	-	-	-	-	-
300	-	-	-	-	-	-	-	-	-	-	-	-
350	-	-	-	-	-	-	-	-	-	-	-	-
400	-	-	-	-	-	-	-	-	-	-	-	-
450	-	-	-	-	-	-	-	-	-	-	-	-
500	-	-	-	-	-	-	-	-	-	-	-	-
550	-	-	-	-	-	-	-	-	-	-	-	-
600	-	-	-	-	-	-	-	-	-	-	-	-
650	-	-	-	-	-	-	-	-	-	-	-	-
700	-	-	-	-	-	-	-	-	-	-	-	-
750	-	-	-	-	-	-	-	-	-	-	-	-
800	-	-	-	-	-	-	-	-	-	-	-	-
850	-	-	-	-	-	-	-	-	-	-	-	-
900	-	-	-	-	-	-	-	-	-	-	-	-
950	-	-	-	-	-	-	-	-	-	-	-	-
1000	-	-	-	-	-	-	-	-	-	-	-	-

**List by Cable Length**

Type	Cable code	Length
Standard type	1L	1m
	3L	3m
	5L	5m

\* Axis 1 comes with a standard cable, while axis 2 comes with a robot cable.  
\* Refer to P.90 for lengths other than those specified above.

**Cable track**

	X-axis stroke	50-300	350-600	650-900	950-1000
Wiring 1 (Next to X-axis)	Y-axis stroke				
Wiring 2 (Next to Y-axis)	Y-axis stroke	50-200	250-300	-	-

**List of Options**

Name	Option code	
Opposite-home specification	NM	
Slider roller specification	SR	Axis 1 (X-axis) Axis 2 (Y-axis)

**Specifications**

Item	X axis						Y axis
Axis model	RCS2-SS8C						RCS2-SA7R
Stroke (Can be set in 50-mm increments)	50-1000mm						50-300mm
Max speed	Stroke	50-600mm	650-700mm	750-800mm	850-900mm	950-1000mm	50-300mm
	High speed	1000mm/s	960mm/s	765mm/s	625mm/s	515mm/s	800mm/s
	Medium speed	500mm/s	480mm/s	380mm/s	310mm/s	255mm/s	400mm/s
Motor output (W)	100W						60W
Ball screw lead	High-speed type: 20mm Medium-speed type: 10mm						High-speed type: 16mm Medium-speed type: 8mm
Drive method	Ball screw, ø16 mm, rolled, C10						Ball screw, ø12 mm, rolled, C10
Positioning repeatability	±0.02mm						
Base material	Dedicated alloy steel						Aluminum
Surrounding air temperature/humidity	0 to 40°C, 85% RH or below (non-condensing)						

63 IK2-SXBB2□□S



Note 1. The connected position shown in the drawing defines the home.  
 Note 2. Both wiring 1 and wiring 2 assume use of a cable track.  
 Note 3. For details on the cable track, refer to P.90.  
 Note 4. For details on the bracket on the moving end of the cable track, refer to P.90.

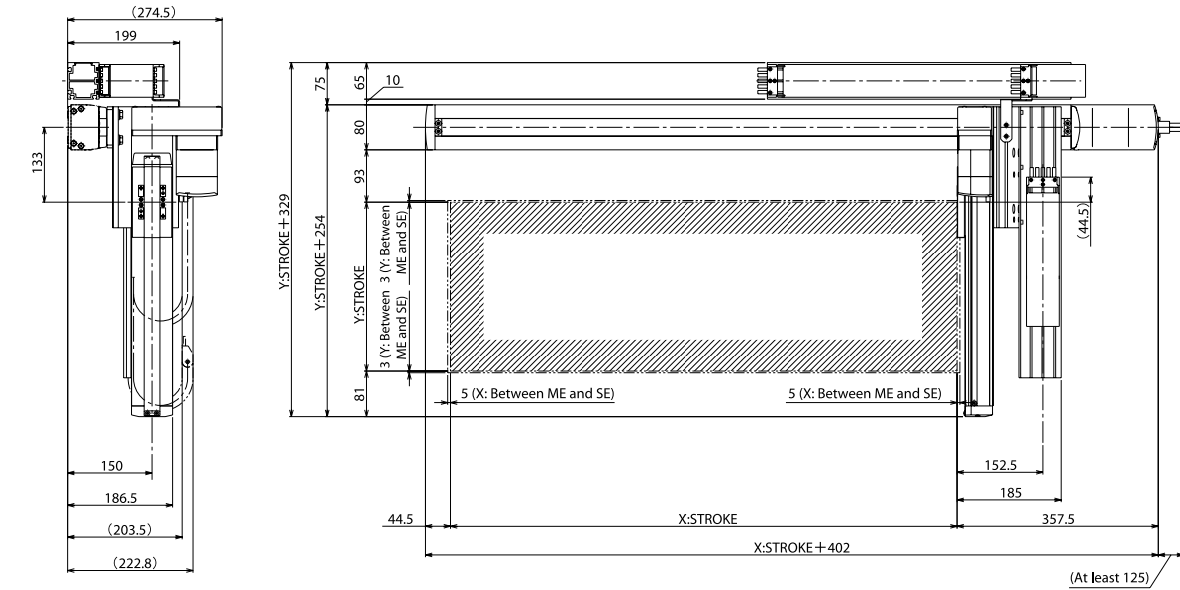

39  
 (Tolerance for reamed hole pitch: ±0.02)

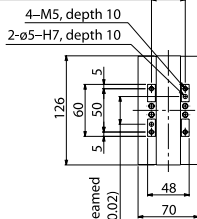

Detail view of Y-axis slider

Detail view of slot in bottom face of X-axis base



ME: Mechanical end  
 SE: Stroke end

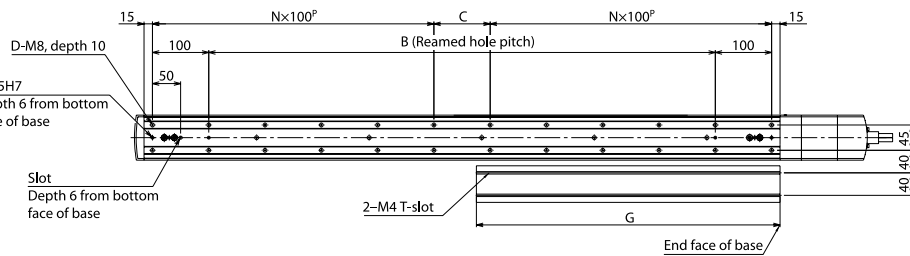
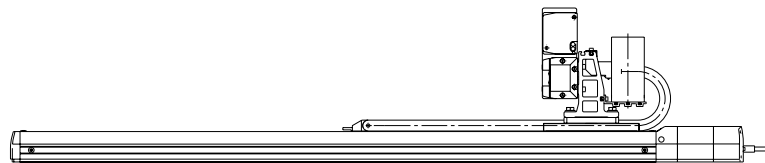

Detail view of X-axis installation

■ Dimensions by Stroke

X: Nominal stroke	50	100	150	200	250	300	350	400	450	500	550	600	650	700	750	800	850	900	950	1000
B	50	100	150	200	250	300	350	400	450	500	550	600	650	700	750	800	850	900	950	1000
C	50	100	150	0	50	100	150	0	50	100	150	0	50	100	150	0	50	100	150	0
D	8	8	8	10	12	12	12	14	16	16	16	18	20	20	20	22	24	24	24	26
N	1	1	1	2	2	2	2	3	3	3	3	4	4	4	4	5	5	5	5	6
G	114.5	139.5	164.5	189.5	214.5	239.5	264.5	289.5	314.5	339.5	364.5	389.5	414.5	439.5	464.5	489.5	514.5	539.5	564.5	589.5

Controllers

Applicable controller



Refer to P. 91 for the controllers.

# IK2-SXBB2□□D

RCS2 2-axis Combinations X axis: SS8C (100W, Straight, Double-slider)  
Y axis: SA7R (Reversed)

**Model Details**

Series: IK2 — Type: SXBB2□□D — Encoder type: □ — Axis 1 (X axis): □ — Axis 2 (Y axis): □ — Controller: □ — Cable: □ — Shipping configuration: □

**Combination directions 1-4**

**Differences between Single-slider and Double-slider Types**  
 HH: X high-speed, Y high-speed  
 MM: X medium-speed, Y medium-speed

**Encoder type**  
 I: Incremental  
 A: Absolute

**Stroke (mm)**  
 5: 50mm  
 { (Can be set in 50-mm increments)

**Options**  
 NM: Opposite-home specification  
 SR: Slider roller specification

**Cable length**  
 1L: 1m  
 3L: 3m  
 5L: 5m  
 □L: □m

**Wiring 1**  
 N: Cable only  
 CT: With cable track

**Wiring 2**

**Shipping configuration**  
 K: Individual components (kit)

\* Refer to P.10 for details on the items comprising the model name.

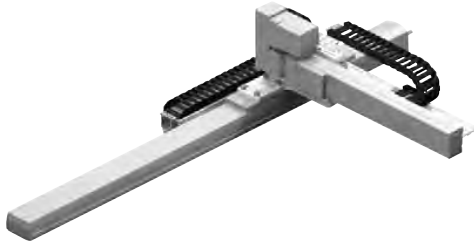

Both wiring 1 and wiring 2 assume use of a cable track.

**Maximum Stroke**

X axis 800 mm Y axis 400 mm

**Maximum Speed**

	High-speed type	Medium-speed type
X axis	1000mm/s	500mm/s
Y axis	800mm/s	400mm/s

**Maximum Load Capacity**

Y-axis stroke	X high-speed, Y high-speed	X medium-speed, Y medium-speed
200mm	—	15kg
250mm	—	12.5kg
300mm	—	12.5kg
350mm	6.0kg	12kg
400mm	5.5kg	10.5kg

**List by Stroke**

Y-axis stroke	Incremental					Absolute				
	200	250	300	350	400	200	250	300	350	400
50	—	—	—	—	—	—	—	—	—	—
100	—	—	—	—	—	—	—	—	—	—
150	—	—	—	—	—	—	—	—	—	—
200	—	—	—	—	—	—	—	—	—	—
250	—	—	—	—	—	—	—	—	—	—
300	—	—	—	—	—	—	—	—	—	—
350	—	—	—	—	—	—	—	—	—	—
400	—	—	—	—	—	—	—	—	—	—
450	—	—	—	—	—	—	—	—	—	—
500	—	—	—	—	—	—	—	—	—	—
550	—	—	—	—	—	—	—	—	—	—
600	—	—	—	—	—	—	—	—	—	—
650	—	—	—	—	—	—	—	—	—	—
700	—	—	—	—	—	—	—	—	—	—
750	—	—	—	—	—	—	—	—	—	—
800	—	—	—	—	—	—	—	—	—	—

Note: For the X high-speed/Y high-speed type, the Y-axis stroke must be 350 mm or more.

**List by Cable Length**

Type	Cable code	Length
Standard type	1L	1m
	3L	3m
	5L	5m

\* Axis 1 comes with a standard cable, while axis 2 comes with a robot cable.  
 \* Refer to P.90 for lengths other than those specified above.

**Cable track**

Wiring 1 (Next to X-axis)	X-axis stroke	50-300	350-600	650-800
Wiring 2 (Next to Y-axis)	Y-axis stroke	200	250-400	—

**List of Options**

Name	Option code	
Opposite-home specification	NM	
Slider roller specification	SR	Axis 1 (X-axis) Axis 2 (Y-axis)

**Specifications**

Item		X axis					Y axis
Axis model		RCS2-SS8C					RCS2-SA7R
Stroke (Can be set in 50-mm increments)		50-800mm					High-speed type: 350-400mm Medium-speed type: 200-400mm
Max speed	Stroke	50-400mm	450-500mm	550-600mm	650-700mm	750-800mm	200-400mm
	High speed	1000mm/s	960mm/s	765mm/s	625mm/s	515mm/s	800mm/s
	Medium speed	500mm/s	480mm/s	380mm/s	310mm/s	255mm/s	400mm/s
Motor output (W)		100W					60W
Ball screw lead		High-speed type: 20mm Medium-speed type: 10mm					High-speed type: 16mm Medium-speed type: 8mm
Drive method		Ball screw, ø16 mm, rolled, C10					Ball screw, ø12 mm, rolled, C10
Positioning repeatability		±0.02mm					
Base material		Dedicated alloy steel					Aluminum
Surrounding air temperature/humidity		0 to 40°C, 85% RH or below (non-condensing)					

65 IK2-SXBB2□□D

Dimensions

Note 1. The connected position shown in the drawing defines the home.  
 Note 2. Both wiring 1 and wiring 2 assume use of a cable track.  
 Note 3. For details on the cable track, refer to P. 90.  
 Note 4. For details on the bracket on the moving end of the cable track, refer to P. 90.

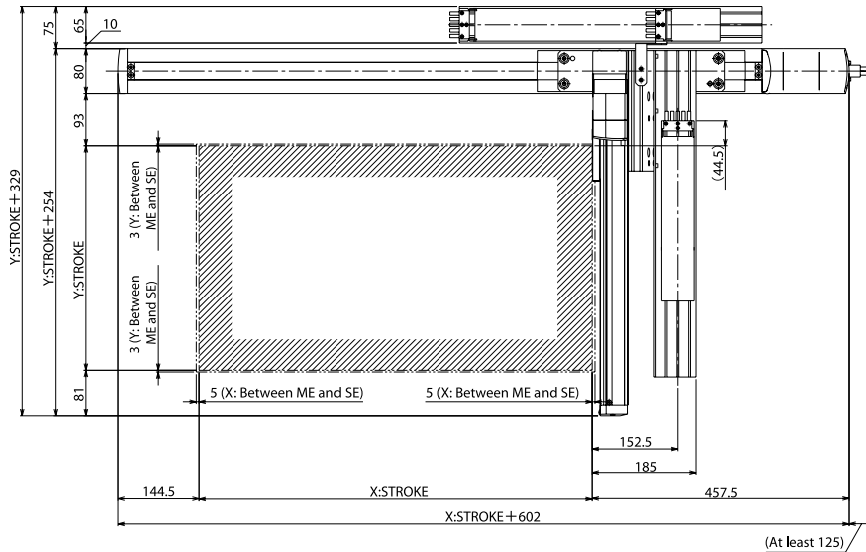
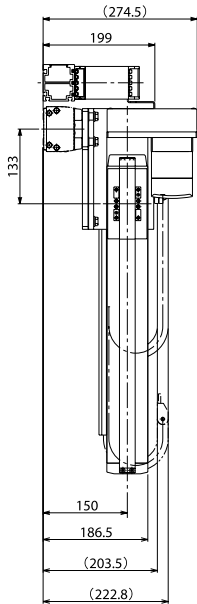

ME: Mechanical end  
 SE: Stroke end

39  
 (Tolerance for reamed hole pitch: ±0.02)

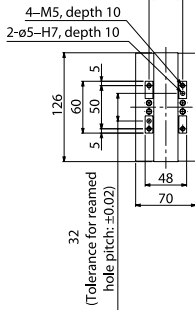

Detail view of Y-axis slider

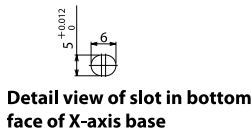

Detail view of slot in bottom face of X-axis base

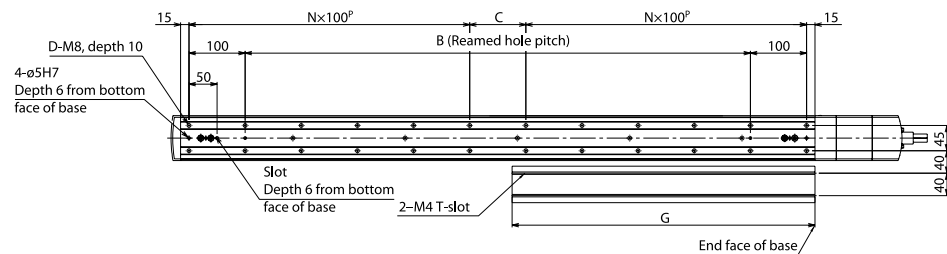
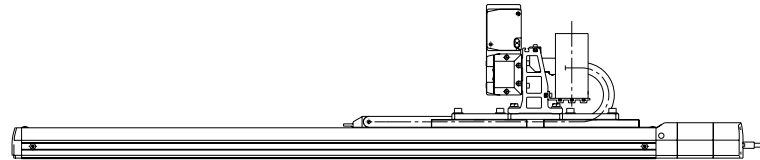

Detail view of X-axis installation

■ Dimensions by Stroke

X: Nominal stroke	250	300	350	400	450	500	550	600	650	700	750	800	850	900	950	1000
X: Effective stroke	50	100	150	200	250	300	350	400	450	500	550	600	650	700	750	800
B	250	300	350	400	450	500	550	600	650	700	750	800	850	900	950	1000
C	50	100	150	0	50	100	150	0	50	100	150	0	50	100	150	0
D	12	12	12	14	16	16	16	18	20	20	20	22	24	24	24	26
N	2	2	2	3	3	3	3	4	4	4	4	5	5	5	5	6
G	214.5	239.5	264.5	289.5	314.5	339.5	364.5	389.5	414.5	439.5	464.5	489.5	514.5	539.5	564.5	589.5

Controllers

Applicable controller



Refer to P. 91 for the controllers.

# IK2-SXBA1□□S

RCS2 2-axis Combinations X axis: SS8R (150W, Reversed, Single-slider)  
Y axis: SS8R (100W, Reversed)

**Model Details**

Series: IK2 — Type: SXBA1□□S — Encoder type: E: Incremental, A: Absolute

Axis 1 (X axis): Stroke (mm) 5: 50mm, ? (Can be set in 50-mm increments)

Axis 2 (Y axis): Options: NM: Opposite-home specification, SR: Slider roller specification

Controllers: T1: XSEL-J/X, T2: SSEL, XSEL-P/Q

Cable length: 1L: 1m, 3L: 3m, 5L: 5m, □L: □m

Wiring 1: R: Cable only, CT: With cable track

Wiring 2: R: Cable only, CT: With cable track

Shipping configuration: K: Individual components (kit)

\* Refer to P.10 for details on the items comprising the model name.



Both wiring 1 and wiring 2 assume use of a cable track.

**Maximum Stroke**

X axis 1000 mm      Y axis 350 mm

**Maximum Speed**

	High-speed type	Medium-speed type
X axis	1000mm/s	500mm/s
Y axis	1000mm/s	500mm/s

**Maximum Load Capacity**

Y-axis stroke	X high-speed, Y high-speed	X medium-speed, Y medium-speed
50mm	12kg	24kg
100mm	12kg	20.5kg
150mm	11.5kg	15.5kg
200mm	11kg	12.5kg
250mm	10kg	—
300mm	8.5kg	—
350mm	7kg	—

**List by Stroke**

Y-axis stroke	Incremental							Absolute						
	50	100	150	200	250	300	350	50	100	150	200	250	300	350
50	-	-	-	-	-	-	-	-	-	-	-	-	-	-
100	-	-	-	-	-	-	-	-	-	-	-	-	-	-
150	-	-	-	-	-	-	-	-	-	-	-	-	-	-
200	-	-	-	-	-	-	-	-	-	-	-	-	-	-
250	-	-	-	-	-	-	-	-	-	-	-	-	-	-
300	-	-	-	-	-	-	-	-	-	-	-	-	-	-
350	-	-	-	-	-	-	-	-	-	-	-	-	-	-
400	-	-	-	-	-	-	-	-	-	-	-	-	-	-
450	-	-	-	-	-	-	-	-	-	-	-	-	-	-
500	-	-	-	-	-	-	-	-	-	-	-	-	-	-
550	-	-	-	-	-	-	-	-	-	-	-	-	-	-
600	-	-	-	-	-	-	-	-	-	-	-	-	-	-
650	-	-	-	-	-	-	-	-	-	-	-	-	-	-
700	-	-	-	-	-	-	-	-	-	-	-	-	-	-
750	-	-	-	-	-	-	-	-	-	-	-	-	-	-
800	-	-	-	-	-	-	-	-	-	-	-	-	-	-
850	-	-	-	-	-	-	-	-	-	-	-	-	-	-
900	-	-	-	-	-	-	-	-	-	-	-	-	-	-
950	-	-	-	-	-	-	-	-	-	-	-	-	-	-
1000	-	-	-	-	-	-	-	-	-	-	-	-	-	-

Note: For the X medium-speed/Y medium-speed type, the Y-axis stroke must be 200 mm or less.

**List by Cable Length**

Type	Cable code	Length
Standard type	1L	1m
	3L	3m
	5L	5m

\* Axis 1 comes with a standard cable, while axis 2 comes with a robot cable.  
\* Refer to P.90 for lengths other than those specified above.

**Cable track**

Wiring 1 (Next to X-axis)	X-axis stroke	50-300	350-600	650-900	950-1000
Wiring 2 (Next to Y-axis)	Y-axis stroke	50-200	250-300	—	—

**List of Options**

Name	Option code	
Opposite-home specification	NM	
Slider roller specification	SR	Axis 1 (X-axis) Axis 2 (Y-axis)

**Specifications**

Item	X axis	Y axis
Axis model	RCS2-SS8R	RCS2-SS8R
Stroke (Can be set in 50-mm increments)	50-1000mm	High-speed type: 50-350mm Medium-speed type: 50-200mm
Max speed	Stroke	50-600mm: 1000mm/s 650-700mm: 960mm/s 750-800mm: 765mm/s 850-900mm: 625mm/s 950-1000mm: 515mm/s
	High speed	1000mm/s
Motor output (W)	150W	100W
Ball screw lead	High-speed type: 20mm Medium-speed type: 10mm	
Drive method	Ball screw, ø16 mm, rolled, C10	
Positioning repeatability	±0.02mm	
Base material	Dedicated alloy steel	
Surrounding air temperature/humidity	0 to 40°C, 85% RH or below (non-condensing)	

Note 1. The connected position shown in the drawing defines the home.  
 Note 2. Both wiring 1 and wiring 2 assume use of a cable track.  
 Note 3. For details on the cable track, refer to P. 90.  
 Note 4. For details on the bracket on the moving end of the cable track, refer to P. 90.

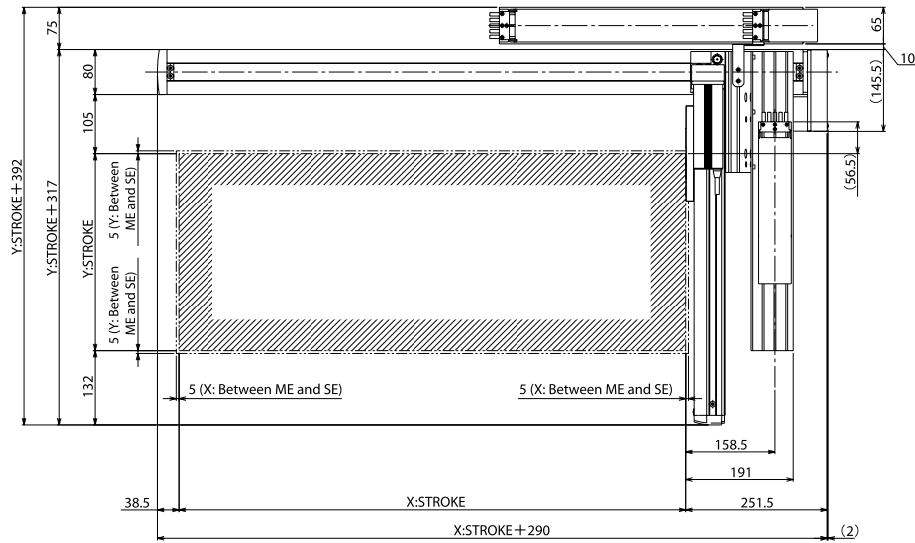
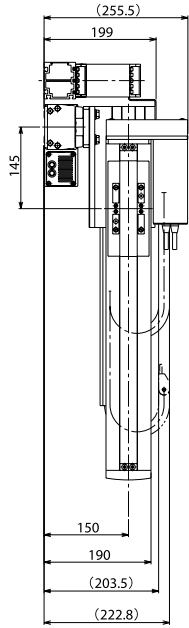

ME: Mechanical end  
 SE: Stroke end

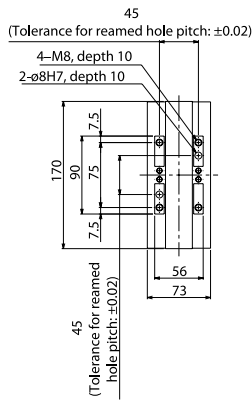

Detail view of Y-axis slider



Detail view of slot in bottom face of X-axis base

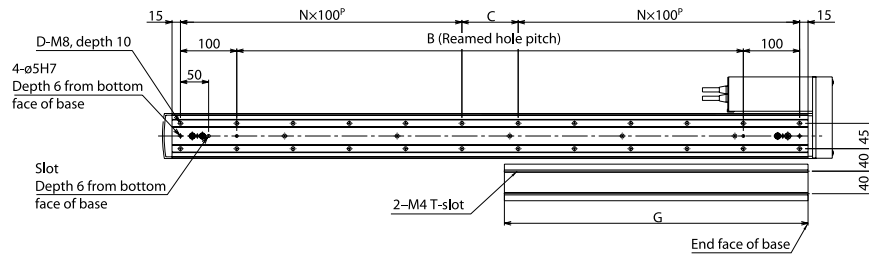
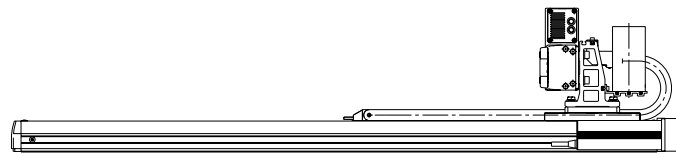

Detail view of X-axis installation

■ Dimensions by Stroke

X: Nominal stroke	50	100	150	200	250	300	350	400	450	500	550	600	650	700	750	800	850	900	950	1000
B	50	100	150	200	250	300	350	400	450	500	550	600	650	700	750	800	850	900	950	1000
C	50	100	150	0	50	100	150	0	50	100	150	0	50	100	150	0	50	100	150	0
D	8	8	8	10	12	12	12	14	16	16	16	18	20	20	20	22	24	24	24	26
N	1	1	1	2	2	2	2	3	3	3	3	4	4	4	4	5	5	5	5	6
G	114.5	139.5	164.5	189.5	214.5	239.5	264.5	289.5	314.5	339.5	364.5	389.5	414.5	439.5	464.5	489.5	514.5	539.5	564.5	589.5

Controllers

Applicable controller



Refer to P. 91 for the controllers.

# IK2-SXBA1□□D

RCS2 2-axis Combinations X axis: SS8R (150W, Reversed, Double-slider)  
Y axis: SS8R (100W, Reversed)

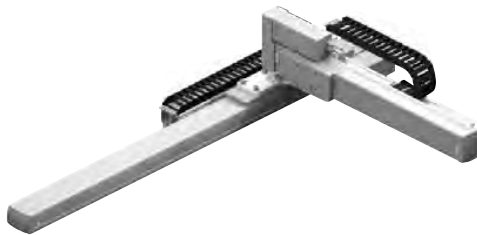
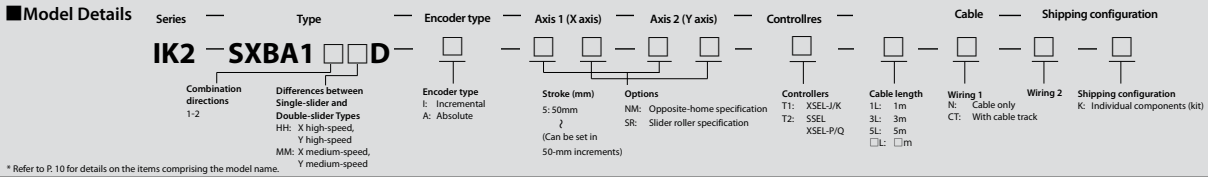

Both wiring 1 and wiring 2 assume use of a cable track.

**Maximum Stroke**

X axis **800 mm** Y axis **400 mm**

**Maximum Speed**

	High-speed type	Medium-speed type
X axis	1000mm/s	500mm/s
Y axis	1000mm/s	500mm/s

**Maximum Load Capacity**

Y-axis stroke	X high-speed, Y high-speed	X medium-speed, Y medium-speed
100mm	—	24kg
150mm	—	24kg
200mm	—	23kg
250mm	—	19kg
300mm	11kg	16kg
350mm	10.5kg	13.5kg
400mm	10kg	11.5kg

**List by Stroke**

Y-axis stroke	Incremental								Absolute							
	100	150	200	250	300	350	400	100	150	200	250	300	350	400		
50	-	-	-	-	-	-	-	-	-	-	-	-	-	-		
100	-	-	-	-	-	-	-	-	-	-	-	-	-	-		
150	-	-	-	-	-	-	-	-	-	-	-	-	-	-		
200	-	-	-	-	-	-	-	-	-	-	-	-	-	-		
250	-	-	-	-	-	-	-	-	-	-	-	-	-	-		
300	-	-	-	-	-	-	-	-	-	-	-	-	-	-		
350	-	-	-	-	-	-	-	-	-	-	-	-	-	-		
400	-	-	-	-	-	-	-	-	-	-	-	-	-	-		
450	-	-	-	-	-	-	-	-	-	-	-	-	-	-		
500	-	-	-	-	-	-	-	-	-	-	-	-	-	-		
550	-	-	-	-	-	-	-	-	-	-	-	-	-	-		
600	-	-	-	-	-	-	-	-	-	-	-	-	-	-		
650	-	-	-	-	-	-	-	-	-	-	-	-	-	-		
700	-	-	-	-	-	-	-	-	-	-	-	-	-	-		
750	-	-	-	-	-	-	-	-	-	-	-	-	-	-		
800	-	-	-	-	-	-	-	-	-	-	-	-	-	-		

Note: For the X high-speed/Y high-speed type, the Y-axis stroke must be 300 mm or more.

**List by Cable Length**

Type	Cable code	Length
Standard type	1L	1m
	3L	3m
	5L	5m

\* Axis 1 comes with a standard cable, while axis 2 comes with a robot cable.

\* Refer to P.90 for lengths other than those specified above.

**Cable track**

Wiring 1 (Next to X-axis)	X-axis stroke	50-300	350-600	650-800
Wiring 2 (Next to Y-axis)	Y-axis stroke	200	250-400	—

**List of Options**

Name	Option code	
Opposite-home specification	NM	
Slider roller specification	SR	Axis 1 (X-axis) Axis 2 (Y-axis)

**Specifications**

Item	X axis	Y axis
Axis model	RCS2-SS8R	RCS2-SS8R
Stroke (Can be set in 50-mm increments)	50-800mm	
Max speed	Stroke	100-400mm
	High speed	1000mm/s
	Medium speed	500mm/s
Motor output (W)	150W	100W
Ball screw lead	High-speed type: 20mm Medium-speed type: 10mm	
Drive method	Ball screw, ø16 mm, rolled, C10	
Positioning repeatability	±0.02mm	
Base material	Dedicated alloy steel	
Surrounding air temperature/humidity	0 to 40°C, 85% RH or below (non-condensing)	

Note 1. The connected position shown in the drawing defines the home.  
 Note 2. Both wiring 1 and wiring 2 assume use of a cable track.  
 Note 3. For details on the cable track, refer to P.90.  
 Note 4. For details on the bracket on the moving end of the cable track, refer to P.90.

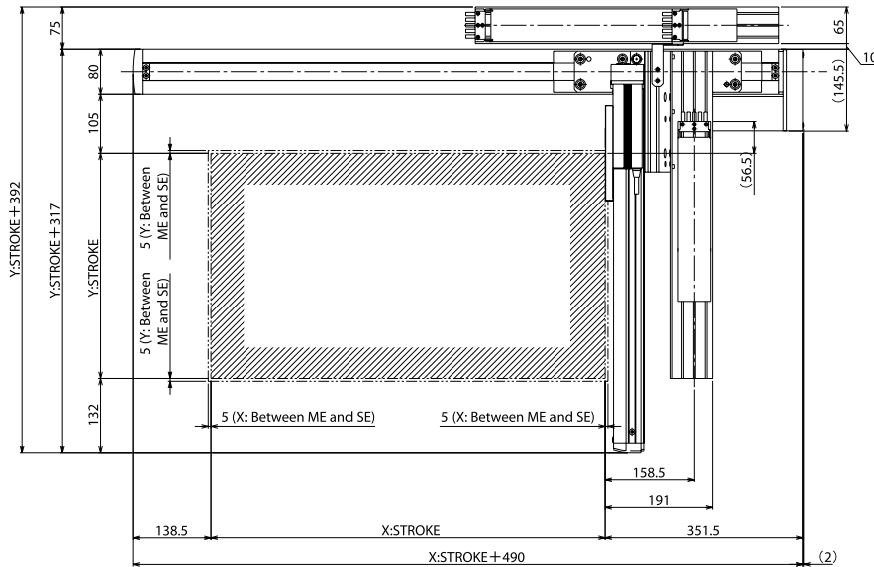
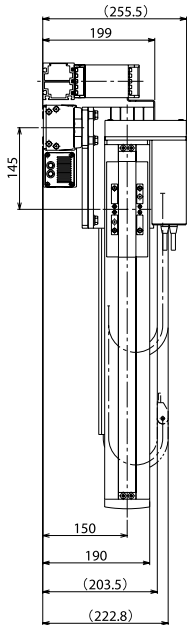

ME: Mechanical end  
 SE: Stroke end

45  
 (Tolerance for reamed hole pitch: ±0.02)

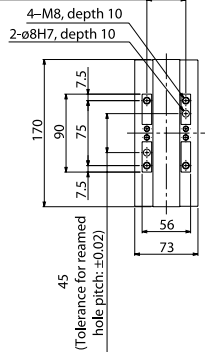

Detail view of Y-axis slider



Detail view of slot in bottom face of X-axis base

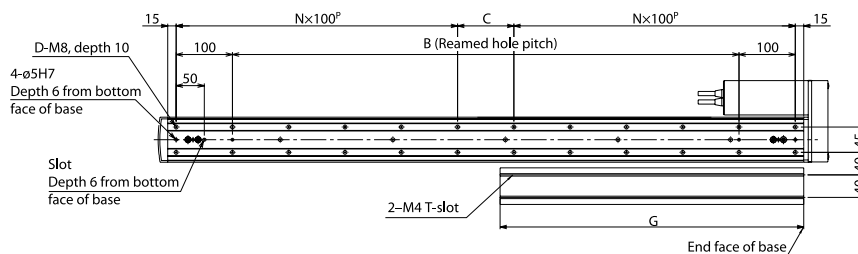
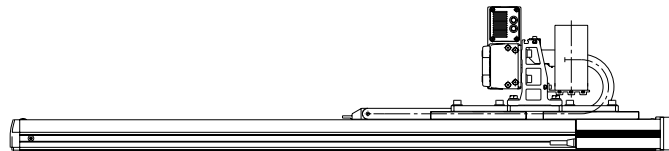

Detail view of X-axis installation

■ Dimensions by Stroke

X: Nominal stroke	250	300	350	400	450	500	550	600	650	700	750	800	850	900	950	1000
X: Effective stroke	50	100	150	200	250	300	350	400	450	500	550	600	650	700	750	800
B	250	300	350	400	450	500	550	600	650	700	750	800	850	900	950	1000
C	50	100	150	0	50	100	150	0	50	100	150	0	50	100	150	0
D	12	12	12	14	16	16	16	18	20	20	20	22	24	24	24	26
N	2	2	2	3	3	3	3	4	4	4	4	5	5	5	5	6
G	214.5	239.5	264.5	289.5	314.5	339.5	364.5	389.5	414.5	439.5	464.5	489.5	514.5	539.5	564.5	589.5

Controllers

Applicable controller



Refer to P. 91 for the controllers.

# IK2-SXBA2□□S

RCS2 2-axis Combinations X axis: SS8C (150W, Straight, Single-slider)  
Y axis: SS8R (100W, Reversed)

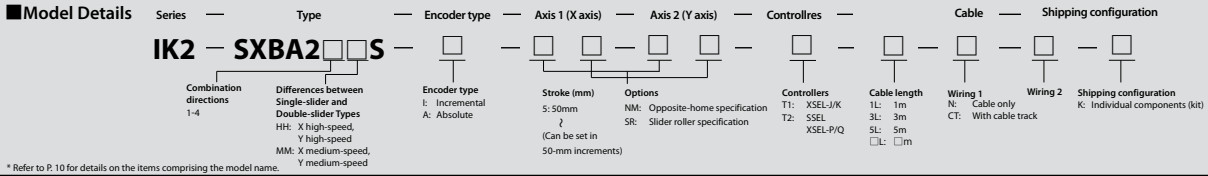

Both wiring 1 and wiring 2 assume use of a cable track.

**Maximum Stroke**

X axis 1000 mm      Y axis 350 mm

**Maximum Speed**

	High-speed type	Medium-speed type
X axis	1000mm/s	500mm/s
Y axis	1000mm/s	500mm/s

**Maximum Load Capacity**

	X high-speed, Y high-speed	X high-speed, Y high-speed	X medium-speed, Y medium-speed
50mm	12kg	12kg	24kg
100mm	12kg	12kg	20.5kg
150mm	11.5kg	11.5kg	15.5kg
200mm	11kg	11kg	12.5kg
250mm	10kg	10kg	—
300mm	8.5kg	8.5kg	—
350mm	7kg	7kg	—

**List by Stroke**

Y-axis stroke	Incremental							Absolute						
	50	100	150	200	250	300	350	50	100	150	200	250	300	350
50	-	-	-	-	-	-	-	-	-	-	-	-	-	-
100	-	-	-	-	-	-	-	-	-	-	-	-	-	-
150	-	-	-	-	-	-	-	-	-	-	-	-	-	-
200	-	-	-	-	-	-	-	-	-	-	-	-	-	-
250	-	-	-	-	-	-	-	-	-	-	-	-	-	-
300	-	-	-	-	-	-	-	-	-	-	-	-	-	-
350	-	-	-	-	-	-	-	-	-	-	-	-	-	-
400	-	-	-	-	-	-	-	-	-	-	-	-	-	-
450	-	-	-	-	-	-	-	-	-	-	-	-	-	-
500	-	-	-	-	-	-	-	-	-	-	-	-	-	-
550	-	-	-	-	-	-	-	-	-	-	-	-	-	-
600	-	-	-	-	-	-	-	-	-	-	-	-	-	-
650	-	-	-	-	-	-	-	-	-	-	-	-	-	-
700	-	-	-	-	-	-	-	-	-	-	-	-	-	-
750	-	-	-	-	-	-	-	-	-	-	-	-	-	-
800	-	-	-	-	-	-	-	-	-	-	-	-	-	-
850	-	-	-	-	-	-	-	-	-	-	-	-	-	-
900	-	-	-	-	-	-	-	-	-	-	-	-	-	-
950	-	-	-	-	-	-	-	-	-	-	-	-	-	-
1000	-	-	-	-	-	-	-	-	-	-	-	-	-	-

Note: For the X medium-speed/Y medium-speed type, the Y-axis stroke must be 200 mm or less.

**List by Cable Length**

Type	Cable code	Length
Standard type	1L	1m
	3L	3m
	5L	5m

\* Axis 1 comes with a standard cable, while axis 2 comes with a robot cable.  
 \* Refer to P.90 for lengths other than those specified above.

**Cable track**

Wiring 1 (Next to X-axis)	X-axis stroke	50-300	350-600	650-900	950-1000
Wiring 2 (Next to Y-axis)	Y-axis stroke	50-200	250-300	—	—

**List of Options**

Name	Option code
Opposite-home specification	NM
Slider roller specification	SR

**Specifications**

Item		X axis					Y axis
Axis model		RCS2-SS8C					RCS2-SS8R
Stroke (Can be set in 50-mm increments)		50-1000mm					High-speed type: 50-350mm Medium speed type: 50-200mm
Max speed	Stroke	50-600mm	650-700mm	750-800mm	850-900mm	950-1000mm	50-350mm
	High speed	1000mm/s	960mm/s	765mm/s	625mm/s	515mm/s	1000mm/s
	Medium speed	500mm/s	480mm/s	380mm/s	310mm/s	255mm/s	500mm/s
Motor output (W)		150W					100W
Ball screw lead		High-speed type: 20mm Medium-speed type: 10mm					
Drive method		Ball screw, ø16 mm, rolled, C10					
Positioning repeatability		±0.02mm					
Base material		Dedicated alloy steel					
Surrounding air temperature/humidity		0 to 40°C, 85% RH or below (non-condensing)					

71

IK2-SXBA2□□S



Note 1. The connected position shown in the drawing defines the home.  
 Note 2. Both wiring 1 and wiring 2 assume use of a cable track.  
 Note 3. For details on the cable track, refer to P. 90.  
 Note 4. For details on the bracket on the moving end of the cable track, refer to P. 90.

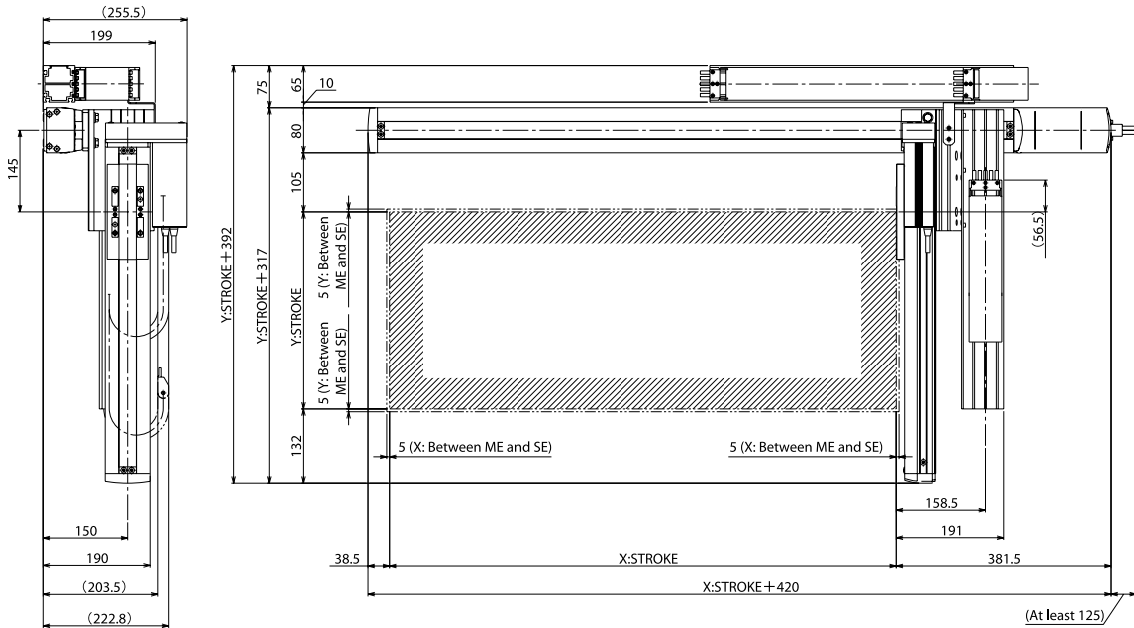

ME: Mechanical end  
 SE: Stroke end

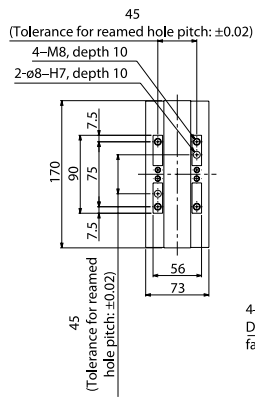

Detail view of Y-axis slider



Detail view of slot in bottom face of X-axis base

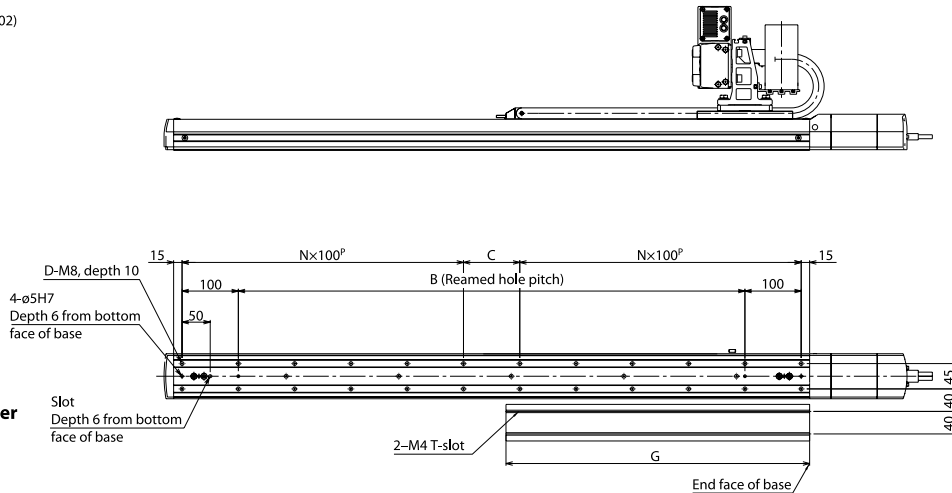

Detail view of X-axis installation

■ Dimensions by Stroke

X: Model	50	100	150	200	250	300	350	400	450	500	550	600	650	700	750	800	850	900	950	1000
B	50	100	150	200	250	300	350	400	450	500	550	600	650	700	750	800	850	900	950	1000
C	50	100	150	0	50	100	150	0	50	100	150	0	50	100	150	0	50	100	150	0
D	8	8	8	10	12	12	12	14	16	16	16	18	20	20	20	22	24	24	24	26
N	1	1	1	2	2	2	2	3	3	3	3	4	4	4	4	5	5	5	5	6
G	114.5	139.5	164.5	189.5	214.5	239.5	264.5	289.5	314.5	339.5	364.5	389.5	414.5	439.5	464.5	489.5	514.5	539.5	564.5	589.5

Controllers

Applicable controller



Refer to P. 91 for the controllers.

# IK2-SXBA2□□D

RCS2 2-axis Combinations X axis: SS8C (150W, Straight, Double-slider)  
Y axis: SS8R (100W, Reversed)

**Model Details** Series — Type — Encoder type — Axis 1 (X axis) — Axis 2 (Y axis) — Controller — Cable — Shipping configuration

**IK2-SXBA2□□D**

**Combination directions 1-4**  
Differences between Single-slider and Double-slider Types  
HH: X high-speed, Y high-speed  
MM: X medium-speed, Y medium-speed

**Encoder type**  
I: Incremental  
A: Absolute

**Stroke (mm)**  
5: 50mm  
? (Can be set in 50-mm increments)

**Options**  
NM: Opposite-home specification  
SR: Slider roller specification

**Controllers**  
T1: XSEL-J/X  
T2: XSEL-P/Q

**Cable length**  
1L: 1m  
3L: 3m  
5L: 5m  
□L: □m

**Wiring 1**  
R: Cable only  
CT: With cable track

**Wiring 2**

**Shipping configuration**  
K: Individual components (kit)

\* Refer to P.10 for details on the items comprising the model name.



Both wiring 1 and wiring 2 assume use of a cable track.

**Maximum Stroke**

X axis **800 mm**      Y axis **400 mm**

**Maximum Speed**

	High-speed type	Medium-speed type
X axis	1000mm/s	500mm/s
Y axis	1000mm/s	500mm/s

**Maximum Load Capacity**

Y-axis stroke	X high-speed, Y high-speed	X medium-speed, Y medium-speed
100mm	—	24kg
150mm	—	24kg
200mm	—	23kg
250mm	—	19kg
300mm	11kg	16kg
350mm	10.5kg	13.5kg
400mm	10kg	11.5kg

**List by Stroke**

Y-axis stroke	Incremental								Absolute							
	100	150	200	250	300	350	400	100	150	200	250	300	350	400		
50	-	-	-	-	-	-	-	-	-	-	-	-	-	-		
100	-	-	-	-	-	-	-	-	-	-	-	-	-	-		
150	-	-	-	-	-	-	-	-	-	-	-	-	-	-		
200	-	-	-	-	-	-	-	-	-	-	-	-	-	-		
250	-	-	-	-	-	-	-	-	-	-	-	-	-	-		
300	-	-	-	-	-	-	-	-	-	-	-	-	-	-		
350	-	-	-	-	-	-	-	-	-	-	-	-	-	-		
400	-	-	-	-	-	-	-	-	-	-	-	-	-	-		
450	-	-	-	-	-	-	-	-	-	-	-	-	-	-		
500	-	-	-	-	-	-	-	-	-	-	-	-	-	-		
550	-	-	-	-	-	-	-	-	-	-	-	-	-	-		
600	-	-	-	-	-	-	-	-	-	-	-	-	-	-		
650	-	-	-	-	-	-	-	-	-	-	-	-	-	-		
700	-	-	-	-	-	-	-	-	-	-	-	-	-	-		
750	-	-	-	-	-	-	-	-	-	-	-	-	-	-		
800	-	-	-	-	-	-	-	-	-	-	-	-	-	-		

Note: For the X high-speed/Y high-speed type, the Y-axis stroke must be 300 mm or more.

**List by Cable Length**

Type	Cable code	Length
Standard type	1L	1m
	3L	3m
	5L	5m

\* Axis 1 comes with a standard cable, while axis 2 comes with a robot cable.  
\* Refer to P.90 for lengths other than those specified above.

**Cable track**

Wiring 1 (Next to X-axis)	X-axis stroke	50-300	350-600	650-800
	Y-axis stroke	200	250-400	—
Wiring 2 (Next to Y-axis)	Y-axis stroke	200	250-400	—

**List of Options**

Name	Option code	
Opposite-home specification	NM	
Slider roller specification	SR	Axis 1 (X-axis) Axis 2 (Y-axis)

**Specifications**

Item	X axis						Y axis
Axis model	RCS2-SS8C						RCS2-SS8R
Stroke (Can be set in 50-mm increments)	50-800mm						High-speed type: 300-400mm Medium speed type: 100-400mm
Max speed	Stroke	50-400mm	450-500mm	550-600mm	650-700mm	750-800mm	100-400mm
	High speed	1000mm/s	960mm/s	765mm/s	625mm/s	515mm/s	1000mm/s
	Medium speed	500mm/s	480mm/s	380mm/s	310mm/s	255mm/s	500mm/s
Motor output (W)	150W						100W
Ball screw lead	High-speed type: 20mm Medium-speed type: 10mm						
Drive method	Ball screw, ø16 mm, rolled, C10						
Positioning repeatability	±0.02mm						
Base material	Dedicated alloy steel						
Surrounding air temperature/humidity	0 to 40°C, 85% RH or below (non-condensing)						

73 IK2-SXBA2□□D

Note 1. The connected position shown in the drawing defines the home.  
 Note 2. Both wiring 1 and wiring 2 assume use of a cable track.  
 Note 3. For details on the cable track, refer to P.90.  
 Note 4. For details on the bracket on the moving end of the cable track, refer to P.90.

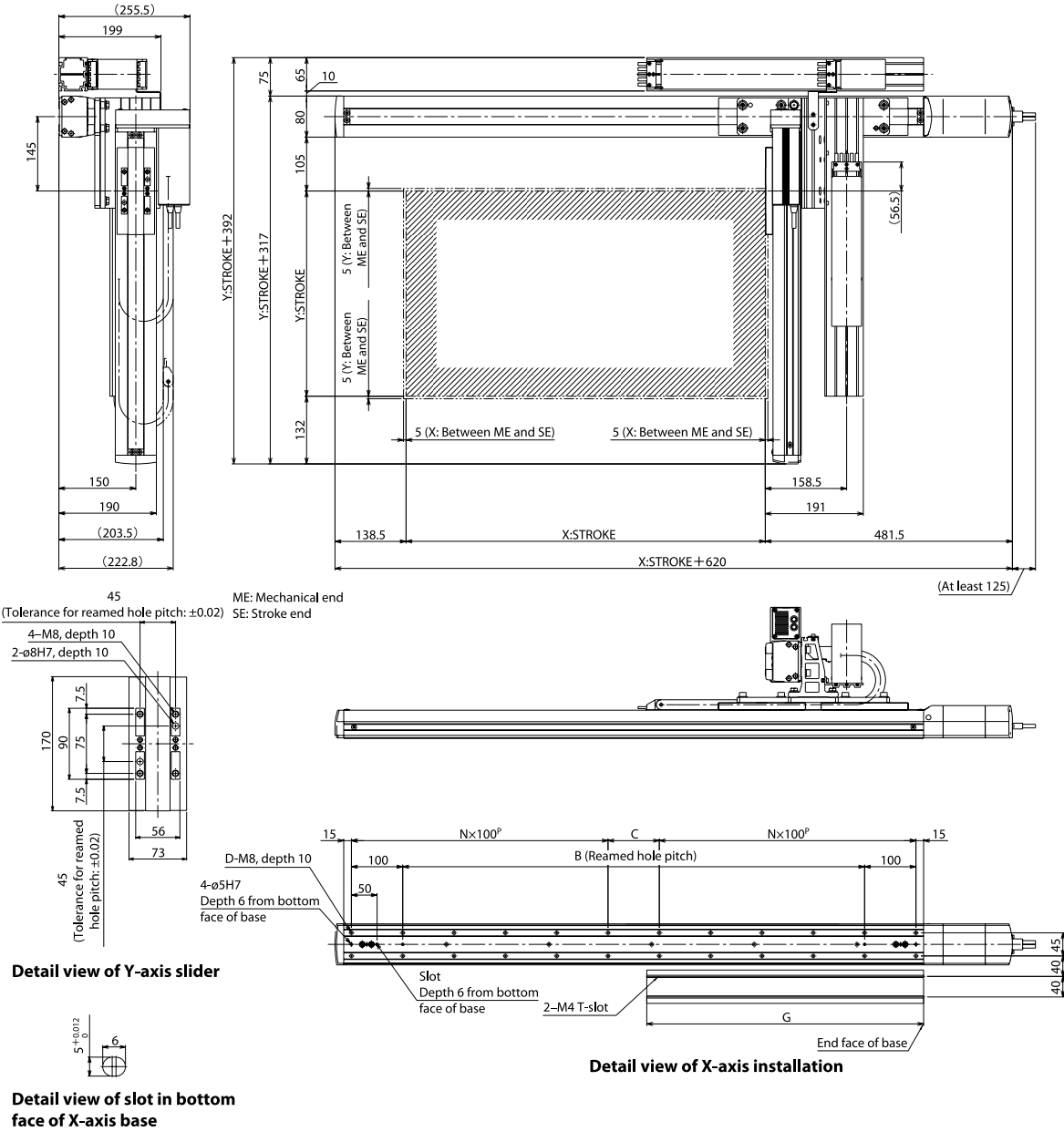

■ Dimensions by Stroke

X: Nominal stroke	250	300	350	400	450	500	550	600	650	700	750	800	850	900	950	1000
X: Effective stroke	50	100	150	200	250	300	350	400	450	500	550	600	650	700	750	800
B	250	300	350	400	450	500	550	600	650	700	750	800	850	900	950	1000
C	50	100	150	0	50	100	150	0	50	100	150	0	50	100	150	0
D	12	12	12	14	16	16	16	18	20	20	20	22	24	24	24	26
N	2	2	2	3	3	3	3	4	4	4	4	5	5	5	5	6
G	214.5	239.5	264.5	289.5	314.5	339.5	364.5	389.5	414.5	439.5	464.5	489.5	514.5	539.5	564.5	589.5

Controllers

Applicable controller

Refer to P. 91 for the controllers.

# IK2-SXZB1□□S

RCS2 2-axis combination (XZ) X axis: SS8R (100W, Reversed, Single-slider)  
Z axis: SA7R (Reversed)

**Model Details**

Series: IK2 — Type: SXZB1□□S — Encoder type: □ — Axis 1 (X axis): □ — Axis 2 (Z axis): B□ — Controller: □ — Cable: □ — Shipping configuration: □

**Combination directions 1-4:**  
 HH: X high-speed, Z high-speed  
 HM: X high-speed, Z medium-speed  
 HL: X high-speed, Z low-speed

**Differences between Single-slider and Double-slider Types:**

**Encoder type:**  
 I: Incremental  
 A: Absolute

**Stroke (mm):**  
 S: 50mm  
 ? (Can be set in 50-mm increments)

**Options:**  
 B: Brake  
 NM: Opposite-home specification  
 SR: Slider roller specification

**Controllers:**  
 T1: XSEL-J/K  
 T2: SSEL  
 XSEL-P/Q

**Cable length:**  
 1L: 1m  
 3L: 3m  
 5L: 5m  
 □L: □m

**Wiring:**  
 N: Cable only  
 CT: With cable track

**Shipping configuration:**  
 K: Individual components (kit)

\* Refer to P.10 for details on the items comprising the model name.

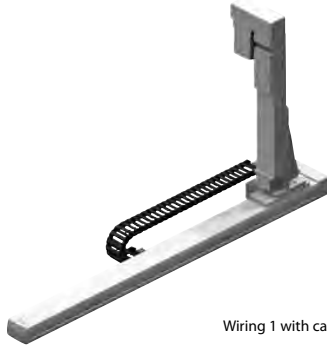

Wiring 1 with cable track

**Maximum Stroke**

X axis 1000 mm      Z axis 250 mm

**Maximum Speed**

	High-speed type	Medium-speed type	Low-speed type
X axis	1000mm/s	—	—
Z axis	800mm/s	400mm/s	200mm/s

**Maximum Load Capacity**

Z-axis stroke	Z-axis high-speed, lead 16	Z-axis medium-speed, lead 8	Z-axis low-speed, lead 4
50mm	2.0kg	4.0kg	8.0kg
100mm	2.0kg	4.0kg	7.0kg
150mm	2.0kg	3.5kg	5.0kg
200mm	2.0kg	3.5kg	4.0kg
250mm	1.5kg	2.5kg	3.0kg

**List by Stroke**

Z-axis stroke	Incremental					Absolute				
	50	100	150	200	250	50	100	150	200	250
50	-	-	-	-	-	-	-	-	-	-
100	-	-	-	-	-	-	-	-	-	-
150	-	-	-	-	-	-	-	-	-	-
200	-	-	-	-	-	-	-	-	-	-
250	-	-	-	-	-	-	-	-	-	-
300	-	-	-	-	-	-	-	-	-	-
350	-	-	-	-	-	-	-	-	-	-
400	-	-	-	-	-	-	-	-	-	-
450	-	-	-	-	-	-	-	-	-	-
500	-	-	-	-	-	-	-	-	-	-
550	-	-	-	-	-	-	-	-	-	-
600	-	-	-	-	-	-	-	-	-	-
650	-	-	-	-	-	-	-	-	-	-
700	-	-	-	-	-	-	-	-	-	-
750	-	-	-	-	-	-	-	-	-	-
800	-	-	-	-	-	-	-	-	-	-
850	-	-	-	-	-	-	-	-	-	-
900	-	-	-	-	-	-	-	-	-	-
950	-	-	-	-	-	-	-	-	-	-
1000	-	-	-	-	-	-	-	-	-	-

**List by Cable Length**

Type	Cable code	Length
Standard type	1L	1m
	3L	3m
	5L	5m

\* Axis 1 comes with a standard cable, while axis 2 comes with a robot cable.  
 \* Refer to P.90 for lengths other than those specified above.

**Cable track**

Wiring 1 (Next to X-axis)	X-axis stroke	150-300	350-600	650-900	950-1000

**List of Options**

Name	Option code
Opposite-home specification	NM
Slider roller specification	SR
	Axis 1 (X-axis) Axis 2 (Z-axis)

**Specifications**

Item	X axis					Z axis
Axis model	RCS2-SS8R					RCS2-SA7R
Stroke (Can be set in 50-mm increments)	50-1000mm					50-250mm
Max speed	Stroke	50-600mm	650-700mm	750-800mm	850-900mm	950-1000mm
	High speed	1000mm/s	960mm/s	765mm/s	625mm/s	515mm/s
	Medium speed	-	-	-	-	-
	Low speed	-	-	-	-	-
Motor output (W)	100W					60W
Ball screw lead	High-speed type: 20mm					High-speed type: 16mm Medium-speed type: 8mm Low-speed type: 4mm
Drive method	Ball screw, ø16 mm, rolled, C10					Ball screw, ø12 mm, rolled, C10
Positioning repeatability	±0.02mm					
Base material	Dedicated alloy steel					Aluminum
Surrounding air temperature/humidity	0 to 40°C, 85% RH or below (non-condensing)					

75 IK2-SXZB1□□S

Dimensions

You can download CAD drawings from our website. [www.intelligentactuator.com](http://www.intelligentactuator.com)

2D CAD

Note 1. The connected position shown in the drawing defines the home.  
 Note 2. Both wiring 1 and wiring 2 assume use of a cable track.  
 Note 3. For details on the cable track, refer to P. 90.  
 Note 4. For details on the bracket on the moving end of the cable track, refer to P. 90.

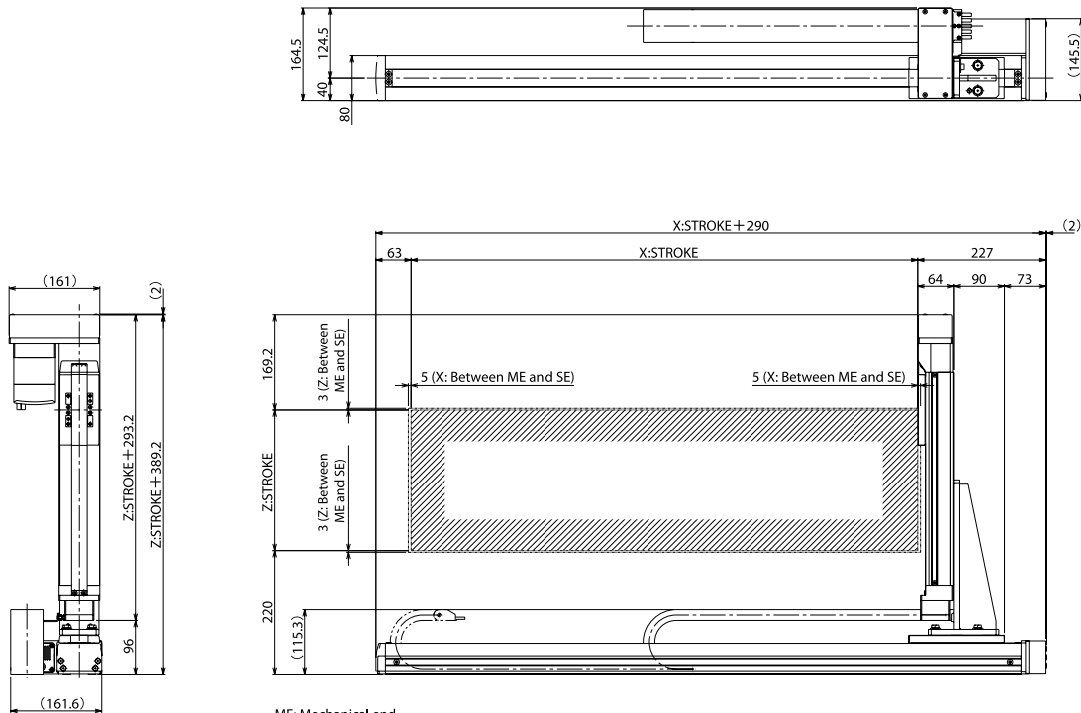

ME: Mechanical end  
 SE: Stroke end

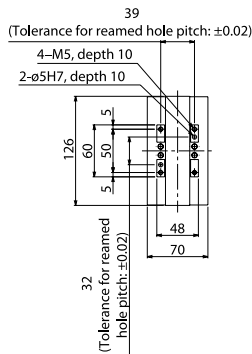

Detail view of Z-axis slider

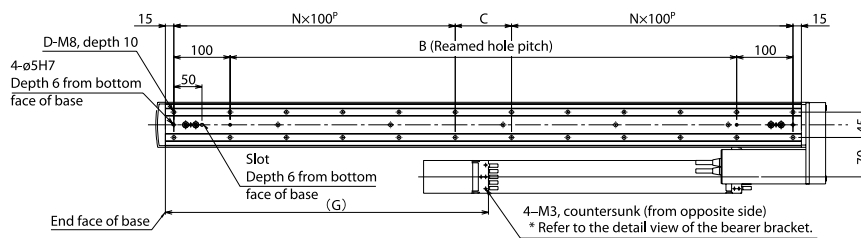

Detail view of slot in bottom face of X-axis base

Detail view of X-axis installation

Dimensions by Stroke

X: Model	50	100	150	200	250	300	350	400	450	500	550	600	650	700	750	800	850	900	950	1000
B	50	100	150	200	250	300	350	400	450	500	550	600	650	700	750	800	850	900	950	1000
C	50	100	150	0	50	100	150	0	50	100	150	0	50	100	150	0	50	100	150	0
D	8	8	8	10	12	12	12	14	16	16	16	18	20	20	20	22	24	24	24	26
N	1	1	1	2	2	2	2	3	3	3	3	4	4	4	4	5	5	5	5	6
G	-	-	199	224	249	274	299	324	349	374	399	424	449	474	499	524	549	574	599	624

\* A bearer is not set when the X stroke is 50 or 100.

Controllers

Applicable controller

Refer to P. 91 for the controllers.

2-axis Combinations RCP2  
 2-axis Combinations RCS2  
 3-axis Combinations RCP2  
 3-axis Combinations RCS2  
 Controllers

# IK2-SXZB1□□D

RCS2 2-axis Combinations(XZ)

X axis: SS8R (100W, Reversed, Double-slider)  
Z axis: SA7R (Reversed)

### Model Details

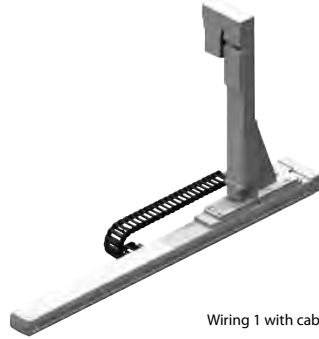
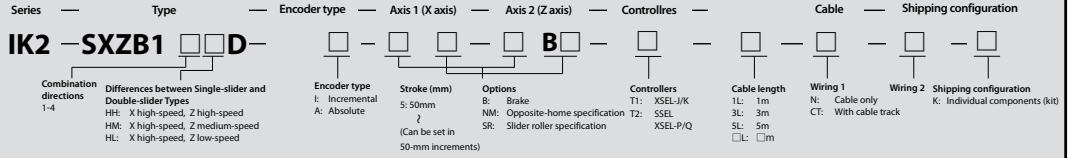

Wiring 1 with cable track

### Maximum Stroke

**X axis** 800 mm      **Z axis** 300 mm

### Maximum Speed

	High-speed type	Medium-speed type	Low-speed type
X axis	1000mm/s	—	—
Z axis	800mm/s	400mm/s	200mm/s

### Maximum Load Capacity

Z-axis stroke	Z-axis high-speed, lead 16	Z-axis medium-speed, lead 8	Z-axis low-speed, lead 4
150mm	—	—	7.0kg
200mm	—	—	7.0kg
250mm	—	—	5.5kg
300mm	1.5kg	3.0kg	5.5kg

### List by Stroke

Y-axis stroke	Incremental				Absolute			
	150	200	250	300	150	200	250	300
50	—	—	—	—	—	—	—	—
100	—	—	—	—	—	—	—	—
150	—	—	—	—	—	—	—	—
200	—	—	—	—	—	—	—	—
250	—	—	—	—	—	—	—	—
300	—	—	—	—	—	—	—	—
350	—	—	—	—	—	—	—	—
400	—	—	—	—	—	—	—	—
450	—	—	—	—	—	—	—	—
500	—	—	—	—	—	—	—	—
550	—	—	—	—	—	—	—	—
600	—	—	—	—	—	—	—	—
650	—	—	—	—	—	—	—	—
700	—	—	—	—	—	—	—	—
750	—	—	—	—	—	—	—	—
800	—	—	—	—	—	—	—	—

Note: For the Z high-speed type and Z medium-speed type, The Z-axis stroke is limited to 300 mm.

### List by Cable Length

Type	Cable code	Length
Standard type	1L	1m
	3L	3m
	5L	5m

\* Axis 1 comes with a standard cable, while axis 2 comes with a robot cable.  
 \* Refer to P. 90 for lengths other than those specified above.

### Cable track

Wiring 1 (Next to X-axis)	X-axis stroke	150-300	350-600	650-800

### List of Options

Name	Option code
Opposite-home specification	NM
Slider roller specification	SR
	Axis 1 (X-axis) Axis 2 (Z-axis)

### Specifications

Item		X axis					Z axis
Axis model		RCS2-SS8R					RCS2-SA7R
Stroke (Can be set in 50-mm increments)		50-800mm					High-speed type: 300mm Medium-speed type: 300mm Low-speed type: 150-300mm
Max speed	Stroke	50-400mm	450-500mm	550-600mm	650-700mm	750-800mm	150-300mm
	High speed	1000mm/s	960mm/s	765mm/s	625mm/s	515mm/s	800mm/s
	Medium speed	-	-	-	-	-	400mm/s
	Low speed	-	-	-	-	-	200mm/s
Motor output (W)		100W					60W
Ball screw lead		High-speed type: 20mm					High-speed type: 16mm Medium-speed type: 8mm Low-speed type: 4mm
Drive method		Ball screw, ø16 mm, rolled, C10					Ball screw, ø12 mm, rolled, C10
Positioning repeatability		±0.02mm					
Base material		Dedicated alloy steel					Aluminum
Surrounding air temperature/humidity		0 to 40°C, 85% RH or below (non-condensing)					

77

IK2-SXZB1□□D

Note 1. The connected position shown in the drawing defines the home.  
 Note 2. Both wiring 1 and wiring 2 assume use of a cable track.  
 Note 3. For details on the cable track, refer to P. 90.  
 Note 4. For details on the bracket on the moving end of the cable track, refer to P. 90.

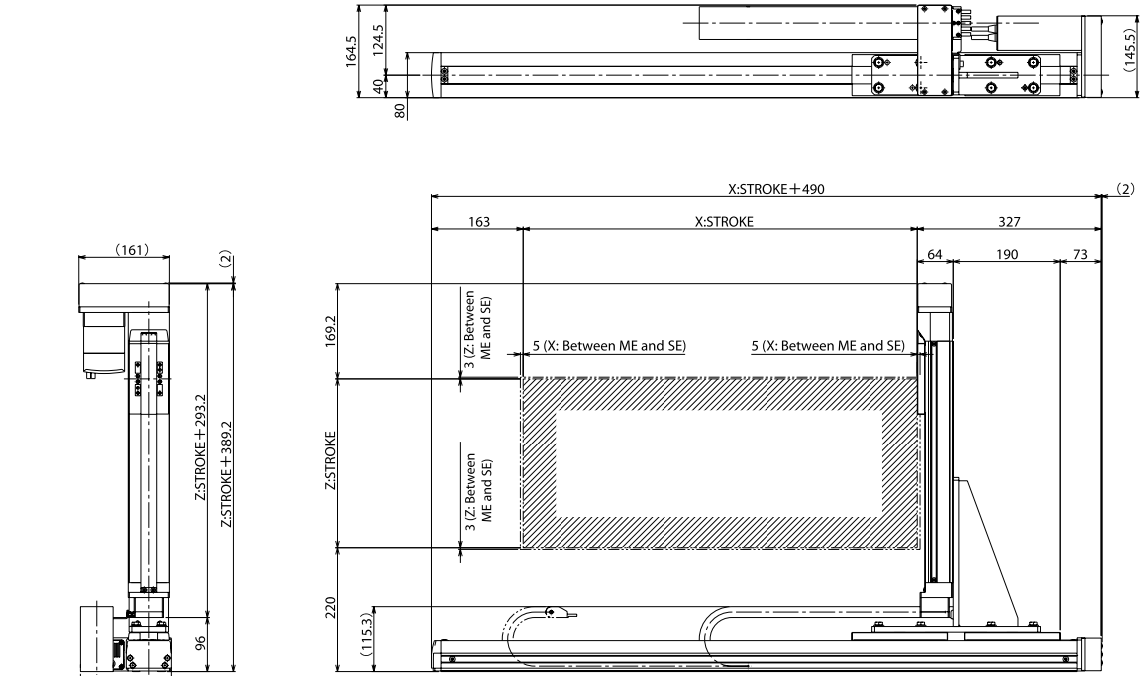

ME: Mechanical end  
 SE: Stroke end

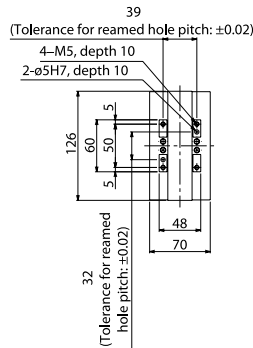

Detail view of Z-axis slider

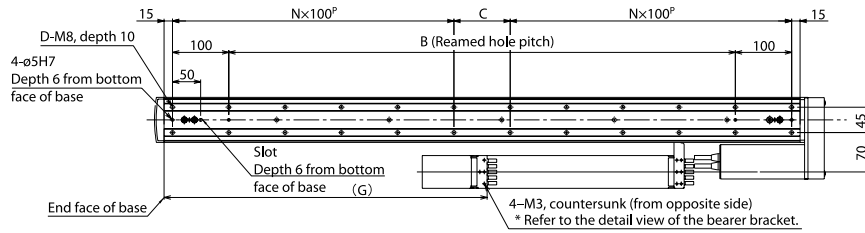

Detail view of X-axis installation

Detail view of slot in bottom face of X-axis base



■ Dimensions by Stroke

X: Nominal stroke	250	300	350	400	450	500	550	600	650	700	750	800	850	900	950	1000
X: Effective stroke	50	100	150	200	250	300	350	400	450	500	550	600	650	700	750	800
B	250	300	350	400	450	500	550	600	650	700	750	800	850	900	950	1000
C	50	100	150	0	50	100	150	0	50	100	150	0	50	100	150	0
D	12	12	12	14	16	16	16	18	20	20	20	22	24	24	24	26
N	2	2	2	3	3	3	3	4	4	4	4	5	5	5	5	6
G	-	-	299	324	349	374	399	424	449	474	499	524	549	574	599	624

\* A bearer is not set when the X stroke is 50 or 100.

Controllers

Applicable controller



Refer to P. 91 for the controllers.

# IK2-SYBB1□□S

RCS2 2-axis combination (YZ) Y axis: SS8R (100W, Reversed, Single-slider)  
Z axis: SA7R (Reversed)

**Model Details** Series — Type — Encoder type — Axis 1 (Y axis) — Axis 2 (Z axis) — Controller — Cable — Shipping configuration

**IK2-SYBB1□□S**

**Combination directions 1-2**  
HH: Y high-speed, Z high-speed  
HM: Y high-speed, Z medium-speed  
HL: Y high-speed, Z low-speed

**Differences between Single-slider and Double-slider Types**

**Encoder type**  
I: Incremental  
A: Absolute

**Stroke (mm)**  
5-50mm  
(Can be set in 50-mm increments)

**Options**  
B: Brake  
NM: Opposite-home specification  
SR: Slider roller specification

**Controllers**  
T1: XSEL-J/K  
T2: SSEL  
XSEL-P/Q

**Cable length**  
1L: 1m  
3L: 3m  
5L: 5m

**Wiring 1**  
N: Cable only  
CT: With cable track

**Wiring 2**  
K: Individual components (kit)

**Shipping configuration**

\* Refer to P.10 for details on the items comprising the model name.

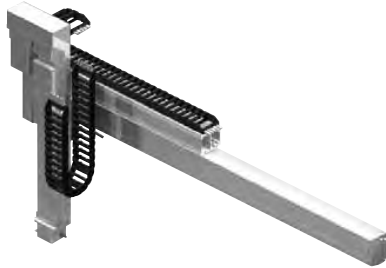

Both wiring 1 and wiring 2 assume use of a cable track.

**Maximum Stroke**

**Y axis 1000 mm**      **Z axis 300 mm**

**Maximum Speed**

	High-speed type	Medium-speed type	Low-speed type
Y axis	1000mm/s	-	-
Z axis	800mm/s	400mm/s	200mm/s

**Maximum Load Capacity**

Z-axis stroke	Z-axis high-speed, lead 16	Z-axis medium-speed, lead 8	Z-axis low-speed, lead 4
50mm	2.0kg	4.0kg	8.0kg
100mm	2.0kg	4.0kg	8.0kg
150mm	2.0kg	3.5kg	7.0kg
200mm	2.0kg	3.5kg	7.0kg
250mm	1.5kg	3.0kg	6.0kg
300mm	1.5kg	3.0kg	5.5kg

**List by Stroke**

Z-axis stroke	Incremental						Absolute					
	50	100	150	200	250	300	50	100	150	200	250	300
50	-	-	-	-	-	-	-	-	-	-	-	-
100	-	-	-	-	-	-	-	-	-	-	-	-
150	-	-	-	-	-	-	-	-	-	-	-	-
200	-	-	-	-	-	-	-	-	-	-	-	-
250	-	-	-	-	-	-	-	-	-	-	-	-
300	-	-	-	-	-	-	-	-	-	-	-	-
350	-	-	-	-	-	-	-	-	-	-	-	-
400	-	-	-	-	-	-	-	-	-	-	-	-
450	-	-	-	-	-	-	-	-	-	-	-	-
500	-	-	-	-	-	-	-	-	-	-	-	-
550	-	-	-	-	-	-	-	-	-	-	-	-
600	-	-	-	-	-	-	-	-	-	-	-	-
650	-	-	-	-	-	-	-	-	-	-	-	-
700	-	-	-	-	-	-	-	-	-	-	-	-
750	-	-	-	-	-	-	-	-	-	-	-	-
800	-	-	-	-	-	-	-	-	-	-	-	-
850	-	-	-	-	-	-	-	-	-	-	-	-
900	-	-	-	-	-	-	-	-	-	-	-	-
950	-	-	-	-	-	-	-	-	-	-	-	-
1000	-	-	-	-	-	-	-	-	-	-	-	-

**List by Cable Length**

Type	Cable code	Length
Standard type	1L	1m
	3L	3m
	5L	5m

\* Axis 1 comes with a standard cable, while axis 2 comes with a robot cable.  
\* Refer to P.90 for lengths other than those specified above.

**Cable track**

Wiring 1 (Next to Y-axis)	Y-axis stroke	50-300	350-600	650-900	950-1000
Wiring 2 (Next to Z-axis)	Z-axis stroke	50-200	250-300	-	-

**List of Options**

Name	Option code	
Opposite-home specification	NM	
Slider roller specification	SR	Axis 1 (Y-axis) Axis 2 (Z-axis)

**Specifications**

Item	Y axis					Z axis
Axis model	RCS2-SS8R					RCS2-SA7R
Stroke (Can be set in 50-mm increments)	50-1000mm					50-300mm
Max speed	Stroke	50-600mm	650-700mm	750-800mm	850-900mm	950-1000mm
	High speed	1000mm/s	960mm/s	765mm/s	625mm/s	515mm/s
	Medium speed	-	-	-	-	-
Low speed	-	-	-	-	-	
Motor output (W)	100W					60W
Ball screw lead	High-speed type: 20mm					High-speed type: 16mm Medium-speed type: 8mm Low-speed type: 4mm
Drive method	Ball screw, ø16 mm, rolled, C10					Ball screw, ø12 mm, rolled, C10
Positioning repeatability	±0.02mm					
Base material	Dedicated alloy steel					Aluminum
Surrounding air temperature/humidity	0 to 40°C, 85% RH or below (non-condensing)					

79 IK2-SYBB1□□S



Dimensions

- Note 1. The connected position shown in the drawing defines the home.
- Note 2. Both wiring 1 and wiring 2 assume use of a cable track.
- Note 3. For details on the cable track, refer to P. 90.
- Note 4. For details on the bracket on the moving end of the cable track, refer to P. 90.

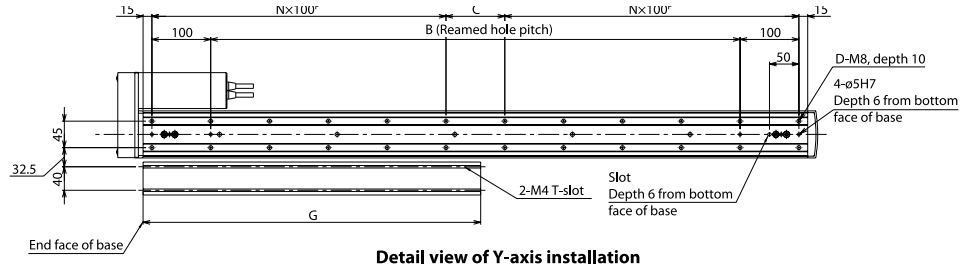

Detail view of Y-axis installation

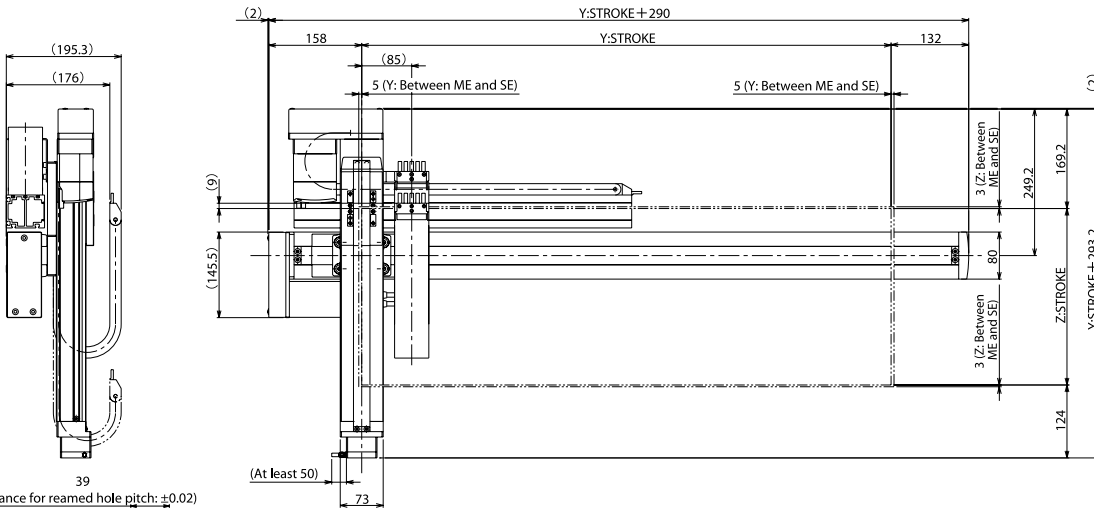
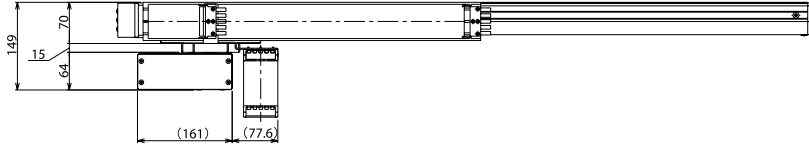

(Tolerance for reamed hole pitch: ±0.02)

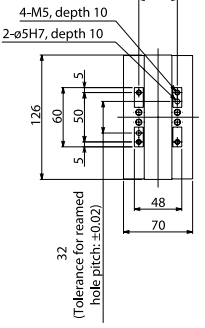

ME: Mechanical end  
SE: Stroke end

Detail view of Z-axis slider    Detail view of slot in bottom face of Y-axis base

■ Dimensions by Stroke

Y: Model	50	100	150	200	250	300	350	400	450	500	550	600	650	700	750	800	850	900	950	1000
B	50	100	150	200	250	300	350	400	450	500	550	600	650	700	750	800	850	900	950	1000
C	50	100	150	0	50	100	150	0	50	100	150	0	50	100	150	0	50	100	150	0
D	8	8	8	10	12	12	12	14	16	16	16	18	20	20	20	22	24	24	24	26
N	1	1	1	2	2	2	2	3	3	3	3	4	4	4	4	5	5	5	5	6
G	149	174	199	224	249	274	299	324	349	374	399	424	449	474	499	524	549	574	599	624

Controllers

Applicable controller

☞ Refer to P. 91 for the controllers.

- 2-axis Combinations RCP2
- 2-axis Combinations RCS2
- 3-axis Combinations RCP2
- 3-axis Combinations RCS2
- Controllers

# IK3-PBBG1□□S

RCP2 3-axis combination (XYB+Z-axes, base mount)  
 X axis: SS8R (Reversed, Single-slider)  
 Y axis: SA7R (Reversed) Z axis: SA6R (Reversed)

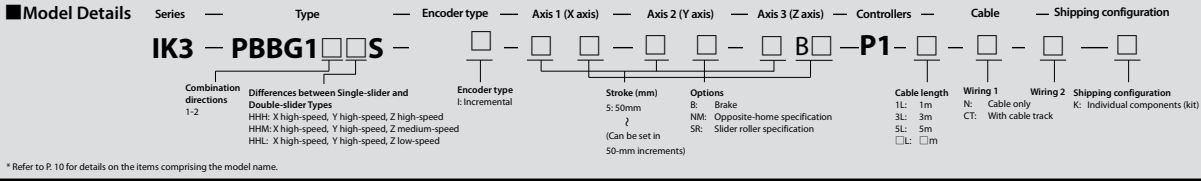

With cable tracks (Wiring 3 does not come with a cable track.)

**Maximum Stroke**  
 X axis 1000 mm | Y axis 300 mm | Z axis 200 mm

**Maximum Speed**

	X high-speed, Y high-speed, Z high-speed	X high-speed, Y high-speed, Z medium-speed	X high-speed, Y high-speed, Z low-speed
X axis	220mm/s		
Y axis	420mm/s		
Z axis	500mms	250mm/s	125mm/s

**Maximum Load Capacity**

Y-axis stroke	X high-speed, Y high-speed, Z high-speed	X high-speed, Y high-speed, Z medium-speed	X high-speed, Y high-speed, Z low-speed
50mm	1.0kg	2.0kg	4.0kg
100mm			
150mm			
200mm			
250mm			
300mm			

**List by Stroke**

		Incremental											
Y-axis stroke		50				100				150			
X-axis stroke	Z-axis stroke	50	100	150	200	50	100	150	200	50	100	150	200
	50	-	-	-	-	-	-	-	-	-	-	-	-
	100	-	-	-	-	-	-	-	-	-	-	-	-
	150	-	-	-	-	-	-	-	-	-	-	-	-
	200	-	-	-	-	-	-	-	-	-	-	-	-
	250	-	-	-	-	-	-	-	-	-	-	-	-
	300	-	-	-	-	-	-	-	-	-	-	-	-
	350	-	-	-	-	-	-	-	-	-	-	-	-
	400	-	-	-	-	-	-	-	-	-	-	-	-
	450	-	-	-	-	-	-	-	-	-	-	-	-
	500	-	-	-	-	-	-	-	-	-	-	-	-
	550	-	-	-	-	-	-	-	-	-	-	-	-
	600	-	-	-	-	-	-	-	-	-	-	-	-
	650	-	-	-	-	-	-	-	-	-	-	-	-
	700	-	-	-	-	-	-	-	-	-	-	-	-
750	-	-	-	-	-	-	-	-	-	-	-	-	
800	-	-	-	-	-	-	-	-	-	-	-	-	
850	-	-	-	-	-	-	-	-	-	-	-	-	
900	-	-	-	-	-	-	-	-	-	-	-	-	
950	-	-	-	-	-	-	-	-	-	-	-	-	
1000	-	-	-	-	-	-	-	-	-	-	-	-	

		Incremental											
Y-axis stroke		200				250				300			
X-axis stroke	Z-axis stroke	50	100	150	200	50	100	150	200	50	100	150	200
	50	-	-	-	-	-	-	-	-	-	-	-	-
	100	-	-	-	-	-	-	-	-	-	-	-	-
	150	-	-	-	-	-	-	-	-	-	-	-	-
	200	-	-	-	-	-	-	-	-	-	-	-	-
	250	-	-	-	-	-	-	-	-	-	-	-	-
	300	-	-	-	-	-	-	-	-	-	-	-	-
	350	-	-	-	-	-	-	-	-	-	-	-	-
	400	-	-	-	-	-	-	-	-	-	-	-	-
	450	-	-	-	-	-	-	-	-	-	-	-	-
	500	-	-	-	-	-	-	-	-	-	-	-	-
	550	-	-	-	-	-	-	-	-	-	-	-	-
	600	-	-	-	-	-	-	-	-	-	-	-	-
	650	-	-	-	-	-	-	-	-	-	-	-	-
	700	-	-	-	-	-	-	-	-	-	-	-	-
750	-	-	-	-	-	-	-	-	-	-	-	-	
800	-	-	-	-	-	-	-	-	-	-	-	-	
850	-	-	-	-	-	-	-	-	-	-	-	-	
900	-	-	-	-	-	-	-	-	-	-	-	-	
950	-	-	-	-	-	-	-	-	-	-	-	-	
1000	-	-	-	-	-	-	-	-	-	-	-	-	

**List by Cable Length**

Type	Cable code	Length
Standard type	1L	1m
	3L	3m
	5L	5m

\* Axis 1 comes with a standard cable, while axes 2 and 3 come with a robot cable.  
 \* Refer to P.90 for lengths other than those specified above.

**Cable track**

		Y-axis stroke	
		50-200	250-300
X-axis stroke	50-400	-	-
	450-600	-	-
	650-800	-	-
	850-1000	-	-

Note) Both wiring 1 and wiring 2 should have a cable bear, or neither of the two should have a cable track. A cable track cannot be specified for one of the wirings.

**List by Cable Length**

Name	Option code
Opposite-home specification	NM
Slider roller specification	SR

**Specifications**

Item	X axis	Y axis	Z axis
Axis model	RCP2-SS8R	RCP2-SA7R	RCP2-SA6R
Stroke (Can be set in 50-mm increments)	50-1000mm	50-300mm	50-200mm
Axis 2	High-speed type: 220mm/s	High-speed type: 420mm/s	High-speed type: 500mm/s Medium-speed type: 250mm/s Low-speed type: 125mm/s
Motor size	56-square pulse motor	56-square pulse motor	42-square pulse motor
Ball screw lead	High-speed type: 20mm	High-speed type: 16mm	High-speed type: 12mm Medium-speed type: 6mm Low-speed type: 3mm
Drive method	Ball screw, $\phi$ 16mm, rolled, C10	Ball screw, $\phi$ 12mm, rolled, C10	Ball screw, $\phi$ 10mm, rolled, C10
Positioning repeatability	$\pm 0.02$ mm		
Base material	Dedicated alloy steel		Aluminum
Surrounding air temperature/humidity	0 to 40°C, 85% RH or below (non-condensing)		

**Dimensions**

Note 1. The connected position shown in the drawing defines the home.  
 Note 2. The drawing below assumes that both wiring 1 and wiring 2 have a cable track.  
 Note 3. For details on the cable track, refer to P. 90.

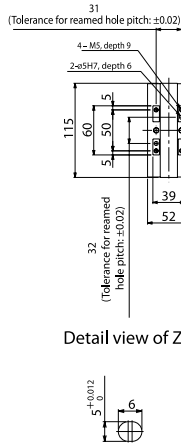
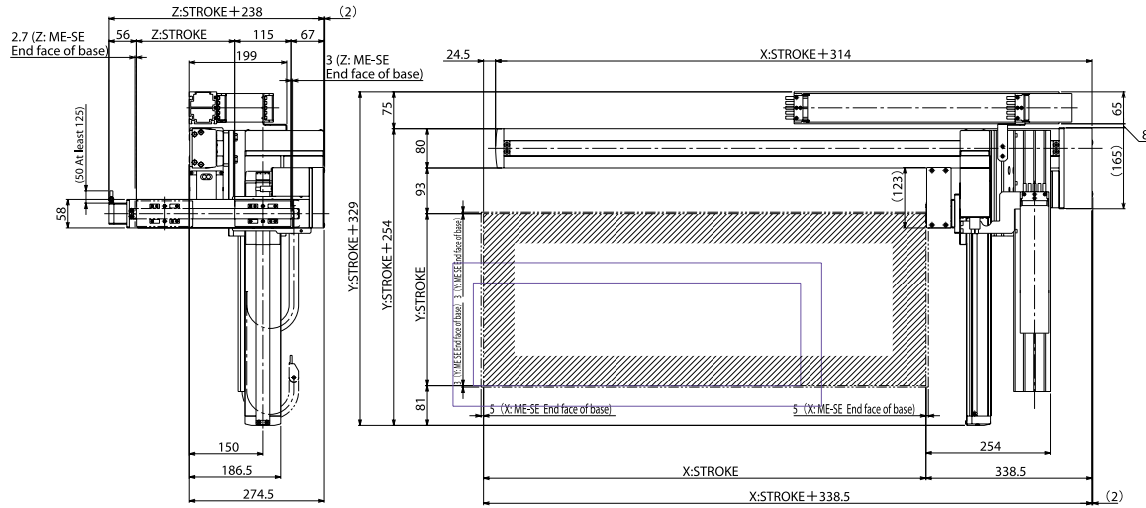

Detail view of Z-axis slider

Detail view of slot in bottom face of X-axis base

ME: Mechanical end  
 SE: Stroke end

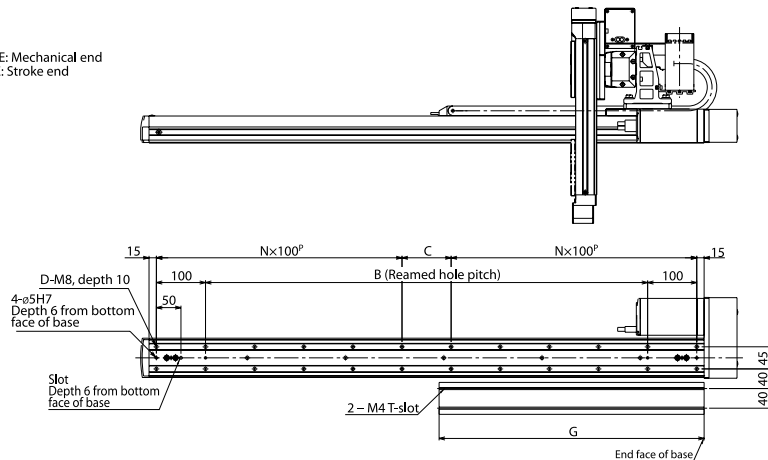

Detail view of X-axis installation

**Dimensions by Stroke**

X: Model	50	100	150	200	250	300	350	400	450	500	550	600	650	700	750	800	850	900	950	1000
B	50	100	150	200	250	300	350	400	450	500	550	600	650	700	750	800	850	900	950	1000
C	50	100	150	0	50	100	150	0	50	100	150	0	50	100	150	0	50	100	150	0
D	8	8	8	10	12	12	12	14	16	16	16	18	20	20	20	22	24	24	24	26
N	1	1	1	2	2	2	2	3	3	3	3	4	4	4	4	5	5	5	5	6
G	114.5	139.5	164.5	189.5	214.5	239.5	264.5	289.5	314.5	339.5	364.5	389.5	414.5	439.5	464.5	489.5	514.5	539.5	564.5	589.5

**Controllers**

Applicable controller



Refer to P. 91 for the controllers.

2-axis  
Combinations  
R C P 2

2-axis  
Combinations  
R C S 2

3-axis  
Combinations  
R C P 2

3-axis  
Combinations  
R C S 2

Controllers

# IK3-PBBG1□□D

RCP2 3-axis combination (XYB+Z-axes, base mount)

X axis: SS8R (Reversed, Double-slider)

Y axis: SA7R (Reversed) Z axis: SA6R (Reversed)

## Model Details

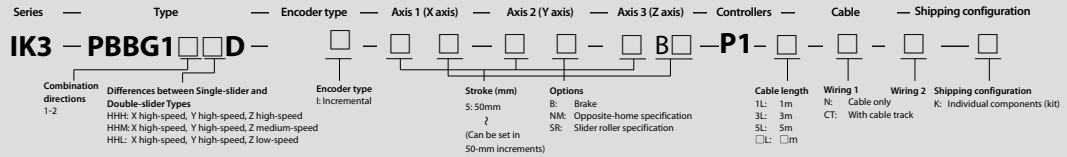

\* Refer to P.10 for details on the items comprising the model name.

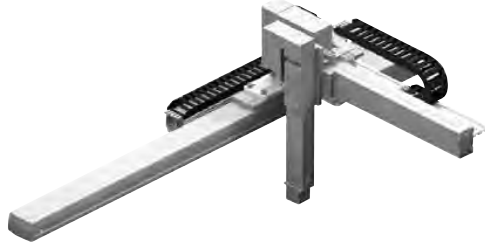

With cable tracks (Wiring 3 does not come with a cable track.)

## Maximum Stroke

<b>X axis</b>	800 mm	<b>Y axis</b>	400 mm	<b>Z axis</b>	200 mm
---------------	--------	---------------	--------	---------------	--------

## Maximum Speed

	X high-speed, Y high-speed, Z high-speed	X high-speed, Y high-speed, Z medium-speed	X high-speed, Y high-speed, Z low-speed
<b>X axis</b>	220mm/s		
<b>Y axis</b>	420mm/s		
<b>Z axis</b>	500mm/s	250mm/s	125mm/s

## Maximum Load Capacity

Y-axis stroke	X high-speed, Y high-speed, Z high-speed	X high-speed, Y high-speed, Z medium-speed	X high-speed, Y high-speed, Z low-speed
350mm	1.0kg	2.0kg	4.0kg
400mm			

## List by Stroke

		Incremental							
		350				400			
Y-axis stroke		50	100	150	200	50	100	150	200
X-axis stroke	50	—	—	—	—	—	—	—	—
	100	—	—	—	—	—	—	—	—
	150	—	—	—	—	—	—	—	—
	200	—	—	—	—	—	—	—	—
	250	—	—	—	—	—	—	—	—
	300	—	—	—	—	—	—	—	—
	350	—	—	—	—	—	—	—	—
	400	—	—	—	—	—	—	—	—
	450	—	—	—	—	—	—	—	—
	500	—	—	—	—	—	—	—	—
	550	—	—	—	—	—	—	—	—
	600	—	—	—	—	—	—	—	—
	650	—	—	—	—	—	—	—	—
	700	—	—	—	—	—	—	—	—
	750	—	—	—	—	—	—	—	—
	800	—	—	—	—	—	—	—	—

## List by Cable Length

Type	Cable code	Length
Standard type	1L	1m
	3L	3m
	5L	5m

\* Axis 1 comes with a standard cable, while axis 2 comes with a robot cable.

\* Refer to P.90 for lengths other than those specified above.

## Cable track

		Y-axis stroke
X-axis stroke	50-400	—
	450-600	—
	650-800	—

Note) Both wiring 1 and wiring 2 should have a cable bear, or neither of the two should have a cable track. A cable track cannot be specified for one of the wirings.

## List by Cable Length

Name	Option code
Opposite-home specification	NM
Slider roller specification	SR

## Specifications

Item	X axis	Y axis	Z axis
Axis model	RCP2-SS8R	RCP2-SA7R	RCP2-SA6R
Stroke (Can be set in 50-mm increments)	50-800mm	350-400mm	50-200mm
Max speed	High-speed type: 220mm/s	High-speed type: 420mm/s	High-speed type: 500mm/s Medium-speed type: 250mm/s Low-speed type: 125mm/s
Motor size	56-square pulse motor	56-square pulse motor	42-square pulse motor
Ball screw lead	High-speed type: 20mm	High-speed type: 16mm	High-speed type: 12mm Medium-speed type: 6mm Low-speed type: 3mm
Drive method	Ball screw, ø16mm, rolled, C10	Ball screw, ø12mm, rolled, C10	Ball screw, ø10mm, rolled, C10
Positioning repeatability	±0.02mm		
Base material	Dedicated alloy steel	Aluminum	
Surrounding air temperature/humidity	0 to 40°C, 85% RH or below (non-condensing)		

Note 1. The connected position shown in the drawing defines the home.  
 Note 2. The drawing below assumes that both wiring 1 and wiring 2 have a cable track.  
 Note 3. For details on the cable track, refer to P. 90.

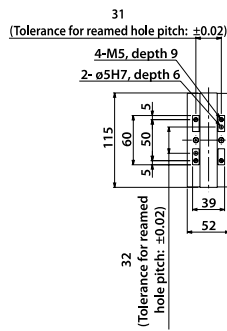
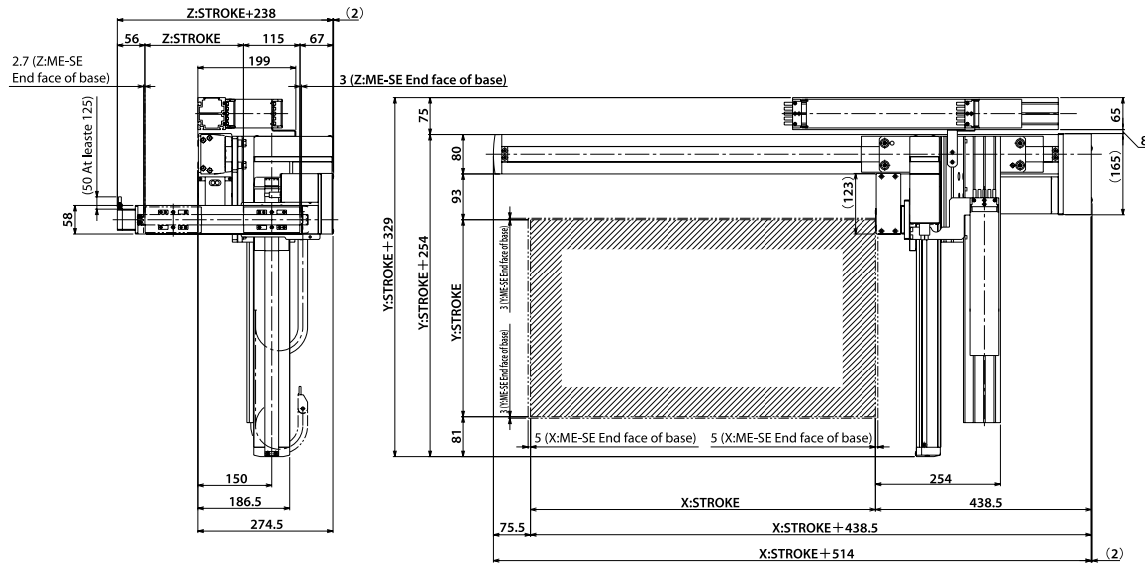

Detail view of Z-axis slider



Detail view of slot in bottom

ME: Mechanical end  
 SE: Stroke end

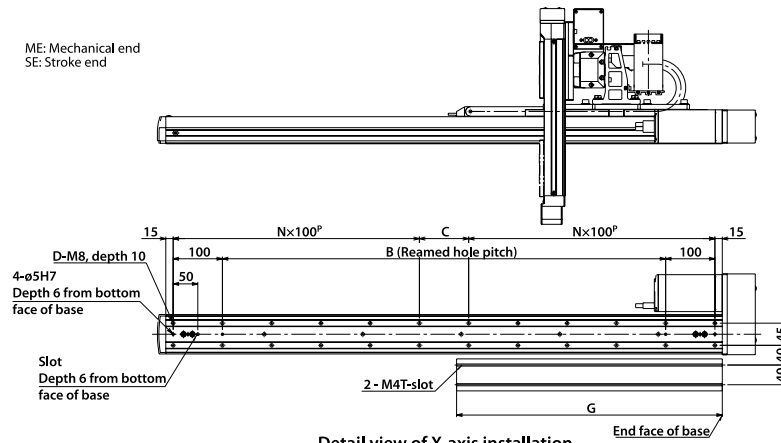

Detail view of X-axis installation

■ Dimensions by Stroke

X: Nominal stroke	250	300	350	400	450	500	550	600	650	700	750	800	850	900	950	1000
X: Effective stroke	50	100	150	200	250	300	350	400	450	500	550	600	650	700	750	800
B	250	300	350	400	450	500	550	600	650	700	750	800	850	900	950	1000
C	50	100	150	0	50	100	150	0	50	100	150	0	50	100	150	0
D	12	12	12	14	16	16	16	18	20	20	20	22	24	24	24	26
N	2	2	2	3	3	3	3	4	4	4	4	5	5	5	5	6
G	214.5	239.5	264.5	289.5	314.5	339.5	364.5	389.5	414.5	439.5	464.5	489.5	514.5	539.5	564.5	589.5

Controllers

Applicable controller



Refer to P. 91 for the controllers.

# IK3-SBBG1□□S

RCS2 3-axis combination (XYB+Z-axes, base mount)

X axis: SS8R (100W, Reversed, Single-slider)

Y axis: SA7R (Reversed) Z axis: SA6R (Reversed)

**Model Details** Series — Type — Encoder type — Axis 1 (X axis) — Axis 2 (Y axis) — Axis 3 (Z axis) — Controllers — Cable — Shipping configuration

**IK3** — **SBBG1**□□**S** — □ — □ — □ — □ — □ — □ — □ — □ — □

**Combination directions 1-2**  
 Differences between Single-slider and Double-slider Types  
 HHH: X high-speed, Y high-speed, Z high-speed  
 HHM: X high-speed, Y high-speed, Z medium-speed  
 HHL: X high-speed, Y high-speed, Z low-speed

**Encoder type**  
 I: Incremental  
 A: Absolute

**Stroke (mm)**  
 S: 50mm  
 ? (Can be set in 50-mm increments)

**Options**  
 B: Brake  
 NM: Opposite-home specification  
 SR: Slider roller specification

**Controllers**  
 T1: XSEL-J/K  
 T2: SSEL  
 XSEL-P/Q

**Cable length**  
 1L: 1m  
 3L: 3m  
 5L: 5m  
 □L: □m

**Wiring 1**  
 N: Cable only  
 CT: With cable track

**Wiring 2**  
 K: Individual components (kit)

**Shipping configuration**  
 K: Individual components (kit)

\* Refer to P.10 for details on the items comprising the model name.

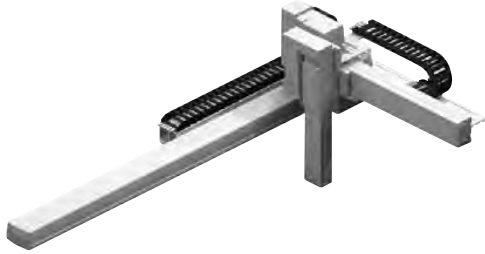

With cable tracks (Wiring 3 does not come with a cable track.)

**Maximum Stroke**

X axis 1000 mm Y axis 300 mm Z axis 200 mm

**Maximum Speed**

	X high-speed, Y high-speed, Z high-speed	X high-speed, Y high-speed, Z medium-speed	X high-speed, Y high-speed, Z low-speed
X axis	1000mm/s		
Y axis	800mm/s		
Z axis	800mm/s	400mm/s	200mm/s

**Maximum Load Capacity**

Y-axis stroke	X high-speed, Y high-speed, Z high-speed	X high-speed, Y high-speed, Z medium-speed	X high-speed, Y high-speed, Z low-speed
50mm	1.0kg	2.0kg	4.0kg
100mm			
150mm			
200mm			
250mm			
300mm			

**List by Stroke**

Y-axis stroke	Incremental											
	50				100				150			
	50	100	150	200	50	100	150	200	50	100	150	200
X-axis stroke 50	-	-	-	-	-	-	-	-	-	-	-	-
100	-	-	-	-	-	-	-	-	-	-	-	-
150	-	-	-	-	-	-	-	-	-	-	-	-
200	-	-	-	-	-	-	-	-	-	-	-	-
250	-	-	-	-	-	-	-	-	-	-	-	-
300	-	-	-	-	-	-	-	-	-	-	-	-
350	-	-	-	-	-	-	-	-	-	-	-	-
400	-	-	-	-	-	-	-	-	-	-	-	-
450	-	-	-	-	-	-	-	-	-	-	-	-
500	-	-	-	-	-	-	-	-	-	-	-	-
550	-	-	-	-	-	-	-	-	-	-	-	-
600	-	-	-	-	-	-	-	-	-	-	-	-
650	-	-	-	-	-	-	-	-	-	-	-	-
700	-	-	-	-	-	-	-	-	-	-	-	-
750	-	-	-	-	-	-	-	-	-	-	-	-
800	-	-	-	-	-	-	-	-	-	-	-	-
850	-	-	-	-	-	-	-	-	-	-	-	-
900	-	-	-	-	-	-	-	-	-	-	-	-
950	-	-	-	-	-	-	-	-	-	-	-	-
1000	-	-	-	-	-	-	-	-	-	-	-	-

Y-axis stroke	Incremental											
	200				250				300			
	50	100	150	200	50	100	150	200	50	100	150	200
X-axis stroke 50	-	-	-	-	-	-	-	-	-	-	-	-
100	-	-	-	-	-	-	-	-	-	-	-	-
150	-	-	-	-	-	-	-	-	-	-	-	-
200	-	-	-	-	-	-	-	-	-	-	-	-
250	-	-	-	-	-	-	-	-	-	-	-	-
300	-	-	-	-	-	-	-	-	-	-	-	-
350	-	-	-	-	-	-	-	-	-	-	-	-
400	-	-	-	-	-	-	-	-	-	-	-	-
450	-	-	-	-	-	-	-	-	-	-	-	-
500	-	-	-	-	-	-	-	-	-	-	-	-
550	-	-	-	-	-	-	-	-	-	-	-	-
600	-	-	-	-	-	-	-	-	-	-	-	-
650	-	-	-	-	-	-	-	-	-	-	-	-
700	-	-	-	-	-	-	-	-	-	-	-	-
750	-	-	-	-	-	-	-	-	-	-	-	-
800	-	-	-	-	-	-	-	-	-	-	-	-
850	-	-	-	-	-	-	-	-	-	-	-	-
900	-	-	-	-	-	-	-	-	-	-	-	-
950	-	-	-	-	-	-	-	-	-	-	-	-
1000	-	-	-	-	-	-	-	-	-	-	-	-

85 IK3-SBBG1□□S

		Incremental											
Y-axis stroke		50				100				150			
Z-axis stroke		50	100	150	200	50	100	150	200	50	100	150	200
X-axis stroke	50	-	-	-	-	-	-	-	-	-	-	-	-
	100	-	-	-	-	-	-	-	-	-	-	-	-
	150	-	-	-	-	-	-	-	-	-	-	-	-
	200	-	-	-	-	-	-	-	-	-	-	-	-
	250	-	-	-	-	-	-	-	-	-	-	-	-
	300	-	-	-	-	-	-	-	-	-	-	-	-
	350	-	-	-	-	-	-	-	-	-	-	-	-
	400	-	-	-	-	-	-	-	-	-	-	-	-
	450	-	-	-	-	-	-	-	-	-	-	-	-
	500	-	-	-	-	-	-	-	-	-	-	-	-
	550	-	-	-	-	-	-	-	-	-	-	-	-
	600	-	-	-	-	-	-	-	-	-	-	-	-
	650	-	-	-	-	-	-	-	-	-	-	-	-
	700	-	-	-	-	-	-	-	-	-	-	-	-
	750	-	-	-	-	-	-	-	-	-	-	-	-
	800	-	-	-	-	-	-	-	-	-	-	-	-
	850	-	-	-	-	-	-	-	-	-	-	-	-
900	-	-	-	-	-	-	-	-	-	-	-	-	
950	-	-	-	-	-	-	-	-	-	-	-	-	
1000	-	-	-	-	-	-	-	-	-	-	-	-	

		Incremental											
Y-axis stroke		200				250				300			
Z-axis stroke		50	100	150	200	50	100	150	200	50	100	150	200
X-axis stroke	50	-	-	-	-	-	-	-	-	-	-	-	-
	100	-	-	-	-	-	-	-	-	-	-	-	-
	150	-	-	-	-	-	-	-	-	-	-	-	-
	200	-	-	-	-	-	-	-	-	-	-	-	-
	250	-	-	-	-	-	-	-	-	-	-	-	-
	300	-	-	-	-	-	-	-	-	-	-	-	-
	350	-	-	-	-	-	-	-	-	-	-	-	-
	400	-	-	-	-	-	-	-	-	-	-	-	-
	450	-	-	-	-	-	-	-	-	-	-	-	-
	500	-	-	-	-	-	-	-	-	-	-	-	-
	550	-	-	-	-	-	-	-	-	-	-	-	-
	600	-	-	-	-	-	-	-	-	-	-	-	-
	650	-	-	-	-	-	-	-	-	-	-	-	-
	700	-	-	-	-	-	-	-	-	-	-	-	-
	750	-	-	-	-	-	-	-	-	-	-	-	-
	800	-	-	-	-	-	-	-	-	-	-	-	-
	850	-	-	-	-	-	-	-	-	-	-	-	-
900	-	-	-	-	-	-	-	-	-	-	-	-	
950	-	-	-	-	-	-	-	-	-	-	-	-	
1000	-	-	-	-	-	-	-	-	-	-	-	-	

**List by Cable Length**

Type	Cable code	Length
Standard type	1L	1m
	3L	3m
	5L	5m

\* Axis 1 comes with a standard cable, while axis 2 comes with a robot cable.  
 \* Refer to P. 90 for lengths other than those specified above.

**Cable track**

		Y-axis stroke	
Z-axis stroke		50-200	250-300
X-axis stroke	50-400	-	-
	450-600	-	-
	650-800	-	-
	850-1000	-	-

Note) Both wiring 1 and wiring 2 should have a cable bear, or neither of the two should have a cable track. A cable track cannot be specified for one of the wirings.

**Options**

Name	Option code
Opposite-home specification	NM
Slider roller specification	SR

**Specifications**

Item	X axis	Y axis	Z axis
Axis model	RCS2-SS8R	RCS2-SA7R	RCS2-SA6R
Stroke (Can be set in 50-mm increments)	50-1000mm	50-300mm	50-200mm
Max speed	High-speed type: 1000mm/s	High-speed type: 800mm/s	High-speed type: 800mm/s Medium-speed type: 400mm/s Low-speed type: 200mm/s
Motor output (W)	100W	60W	30W
Ball screw lead	High-speed type: 20mm	High-speed type: 16mm	High-speed type: 12mm Medium-speed type: 6mm Low-speed type: 3mm
Drive method	Ball screw, ø16mm, rolled, C10	Ball screw, ø12mm, rolled, C10	Ball screw, ø10mm, rolled, C10
Positioning repeatability	±0.02mm		
Base material	Dedicated alloy steel		Aluminum
Surrounding air temperature/humidity	0 to 40°C, 85% RH or below (non-condensing)		

Note 1. The connected position shown in the drawing defines the home.  
 Note 2. The drawing below assumes that both wiring 1 and wiring 2 have a cable track.  
 Note 3. For details on the cable track, refer to P. 90.

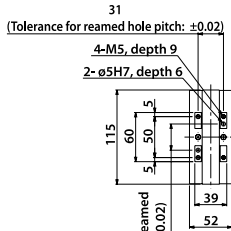
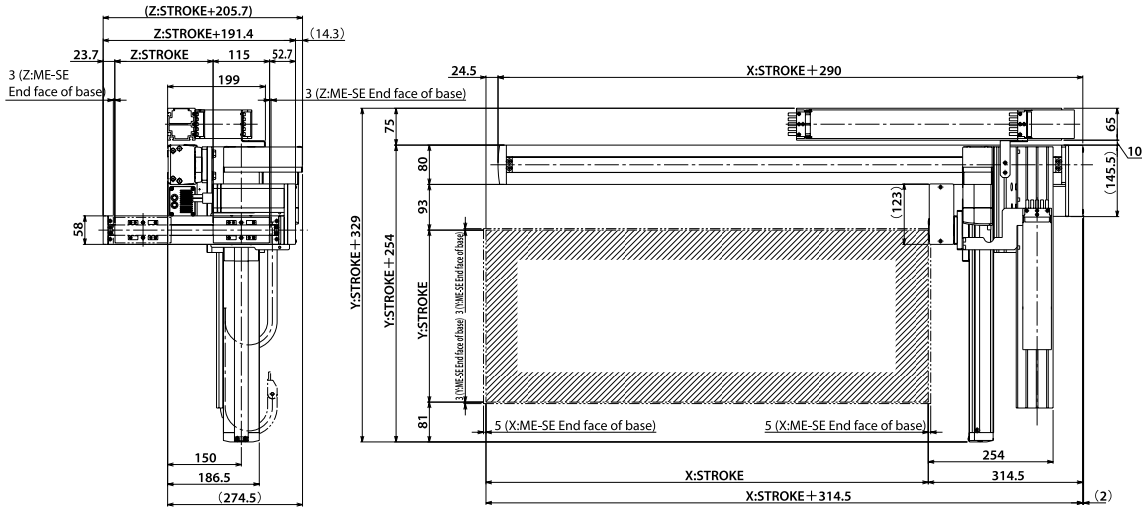

Detail view of Z-axis slider

Detail view of slot in bottom face of X-axis base

ME: Mechanical end  
 SE: Stroke end

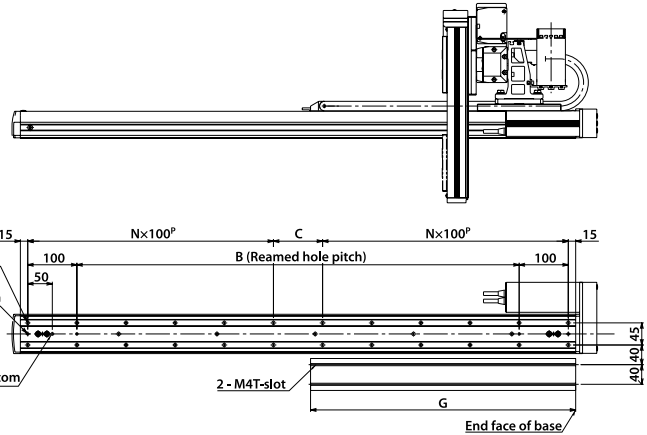

Detail view of X-axis installation

■ Dimensions by Stroke

X: Model	50	100	150	200	250	300	350	400	450	500	550	600	650	700	750	800	850	900	950	1000
B	50	100	150	200	250	300	350	400	450	500	550	600	650	700	750	800	850	900	950	1000
C	50	100	150	0	50	100	150	0	50	100	150	0	50	100	150	0	50	100	150	0
D	8	8	8	10	12	12	12	14	16	16	16	18	20	20	20	22	24	24	24	26
N	1	1	1	2	2	2	2	3	3	3	3	4	4	4	4	5	5	5	5	6
G	114.5	139.5	164.5	189.5	214.5	239.5	264.5	289.5	314.5	339.5	364.5	389.5	414.5	439.5	464.5	489.5	514.5	539.5	564.5	589.5

Controllers

Applicable controller

☞ Refer to P. 91 for the controllers.

87

IK3-SBBG1□□5



# IK3-SBBG1□□D

RCS2 3-axis combination (XYB+Z-axis, base mount)

X axis: SS8R (100W, Reversed, Single-slider)

Y axis: SA7R (Reversed) Z axis: SA6R (Reversed)

**Model Details**

Series: **IK3** — Type: **SBBG1□□D** — Encoder type: **B** — Axis 1 (X axis): **□** — Axis 2 (Y axis): **□** — Axis 3 (Z axis): **□** — Controllers: **□** — Cable: **□** — Shipping configuration: **□**

**Combination directions** 1-2

**Differences between Single-slider and Double-slider Types**  
 HH: X high-speed, Y high-speed, Z high-speed  
 HM: X high-speed, Y high-speed, Z medium-speed  
 HL: X high-speed, Y high-speed, Z low-speed

**Encoder type**  
 I: Incremental  
 A: Absolute

**Stroke (mm)**  
 5: 50mm  
 ? (Can be set in 50-mm increments)

**Options**  
 B: Brake  
 NM: Opposite-home specification  
 SR: Slider roller specification

**Controllers**  
 T1: XSEL-J/K  
 T2: SSEL  
 XSEL-P/Q

**Cable length**  
 1L: 1m  
 3L: 3m  
 5L: 5m  
 L:  m

**Wiring 1**  
 N: Cable only  
 CT: With cable track

**Wiring 2**  
 K: Individual components (kit)

**Shipping configuration**  
 K: Individual components (kit)

\* Refer to P.10 for details on the items comprising the model name.



**Maximum Stroke**

X axis 800 mm    Y axis 400 mm    Z axis 200 mm

**Maximum Speed**

	X high-speed, Y high-speed, Z high-speed	X high-speed, Y high-speed, Z medium-speed	X high-speed, Y high-speed, Z low-speed
X axis	1000mm/s		
Y axis	800mm/s		
Z axis	800mm/s	400mm/s	200mm/s

**Maximum Load Capacity**

Y-axis stroke	X high-speed, Y high-speed, Z high-speed	X high-speed, Y high-speed, Z medium-speed	X high-speed, Y high-speed, Z low-speed
350mm	1.0kg		
400mm	1.0kg	2.0kg	4.0kg

With cable tracks (Wiring 3 does not come with a cable track.)

**List by Stroke**

Y-axis stroke	Incremental								Absolute							
	350				400				350				400			
Z-axis stroke	50	100	150	200	50	100	150	200	50	100	150	200	50	100	150	200
50	-	-	-	-	-	-	-	-	-	-	-	-	-	-	-	-
100	-	-	-	-	-	-	-	-	-	-	-	-	-	-	-	-
150	-	-	-	-	-	-	-	-	-	-	-	-	-	-	-	-
200	-	-	-	-	-	-	-	-	-	-	-	-	-	-	-	-
250	-	-	-	-	-	-	-	-	-	-	-	-	-	-	-	-
300	-	-	-	-	-	-	-	-	-	-	-	-	-	-	-	-
350	-	-	-	-	-	-	-	-	-	-	-	-	-	-	-	-
400	-	-	-	-	-	-	-	-	-	-	-	-	-	-	-	-
450	-	-	-	-	-	-	-	-	-	-	-	-	-	-	-	-
500	-	-	-	-	-	-	-	-	-	-	-	-	-	-	-	-
550	-	-	-	-	-	-	-	-	-	-	-	-	-	-	-	-
600	-	-	-	-	-	-	-	-	-	-	-	-	-	-	-	-
650	-	-	-	-	-	-	-	-	-	-	-	-	-	-	-	-
700	-	-	-	-	-	-	-	-	-	-	-	-	-	-	-	-
750	-	-	-	-	-	-	-	-	-	-	-	-	-	-	-	-
800	-	-	-	-	-	-	-	-	-	-	-	-	-	-	-	-

**Cable track**

X-axis stroke	Y-axis stroke
50-400	-
450-600	-
650-800	-

Note) Both wiring 1 and wiring 2 should have a cable bear, or neither of the two should have a cable track. A cable track cannot be specified for one of the wirings.

**List by Cable Length**

Type	Cable code	Length
Standard type	1L	1m
	3L	3m
	5L	5m

\* Axis 1 comes with a standard cable, while axis 2 comes with a robot cable.

\* Refer to P.90 for lengths other than those specified above.

**List by Cable Length**

Name	Option code
Opposite-home specification	NM
Slider roller specification	SR

**Specifications**

Item	X axis	Y axis	Z axis
Axis model	RCS2-SS8R	RCS2-SA7R	RCS2-SA6R
Stroke (Can be set in 50-mm increments)	50-800mm	350-400mm	50-200mm
Max speed	High-speed type: 1000mm/s	High-speed type: 800mm/s	High-speed type: 800mm/s Medium-speed type: 400mm/s Low-speed type: 200mm/s
Motor output (W)	100W	60W	30W
Ball screw lead	High-speed type: 20mm	High-speed type: 16mm	High-speed type: 12mm Medium-speed type: 6mm Low-speed type: 3mm
Drive method	Ball screw, ø16mm, rolled, C10	Ball screw, ø12mm, rolled, C10	Ball screw, ø10mm, rolled, C10
Positioning repeatability	±0.02mm		
Base material	Dedicated alloy steel / Aluminum		
Surrounding air temperature/humidity	0 to 40°C, 85% RH or below (non-condensing)		

2-axis Combinations  
RCP2  
2-axis Combinations  
RCS2  
3-axis Combinations  
RCP2  
3-axis Combinations  
RCS2  
Controllers

Note 1. The connected position shown in the drawing defines the home.  
 Note 2. The drawing below assumes that both wiring 1 and wiring 2 have a cable track.  
 Note 3. For details on the cable track, refer to P. 90.

2-axis  
Combinations  
RCP2

2-axis  
Combinations  
RCS2

3-axis  
Combinations  
RCP2

3-axis  
Combinations  
RCS2

Controllers

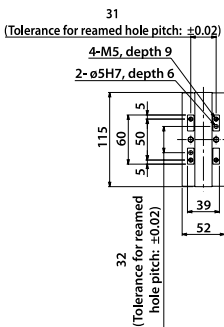
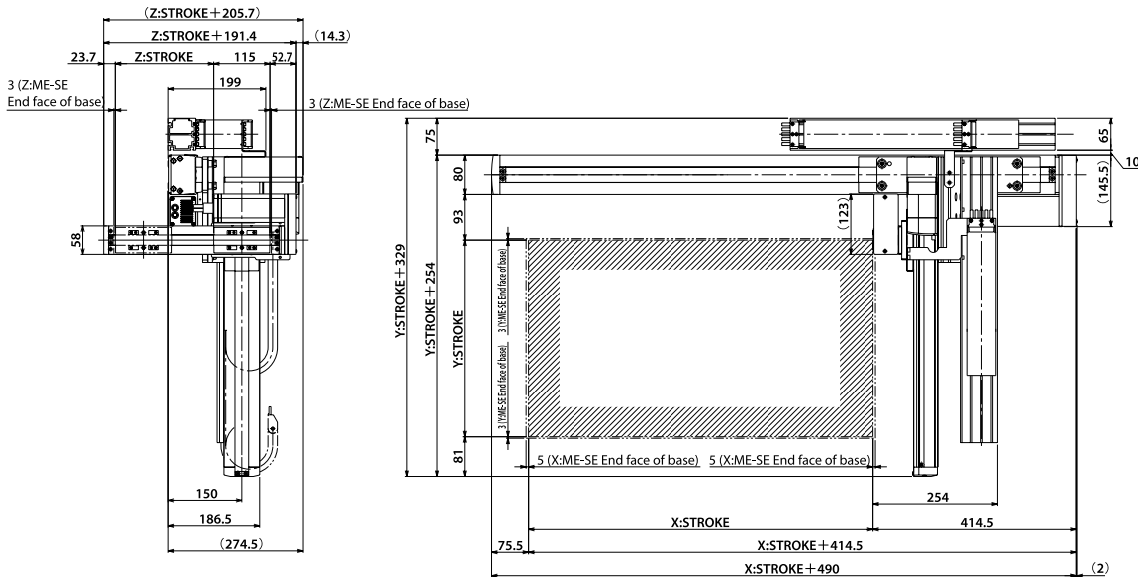

Detail view of Z-axis slider



Detail view of slot in bottom face of X-axis base

ME: Mechanical end  
SE: Stroke end

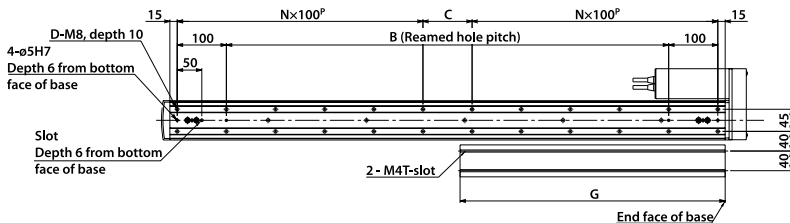
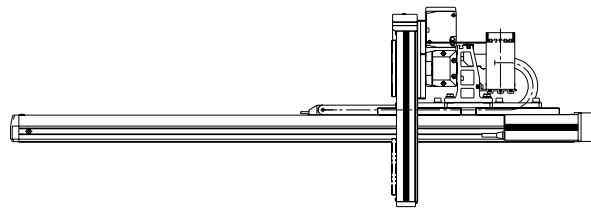

Detail view of X-axis installation

■ Dimensions by Stroke

X: Nominal stroke	250	300	350	400	450	500	550	600	650	700	750	800	850	900	950	1000
X: Effective stroke	50	100	150	200	250	300	350	400	450	500	550	600	650	700	750	800
B	250	300	350	400	450	500	550	600	650	700	750	800	850	900	950	1000
C	50	100	150	0	50	100	150	0	50	100	150	0	50	100	150	0
D	12	12	12	14	16	16	16	18	20	20	20	22	24	24	24	26
N	2	2	2	3	3	3	3	4	4	4	4	5	5	5	5	6
G	214.5	239.5	264.5	289.5	314.5	339.5	364.5	389.5	414.5	439.5	464.5	489.5	514.5	539.5	564.5	589.5

Controllers

Applicable controller

☞ Refer to P. 91 for the controllers.

89

IK3-SBBG1□□D

# Reference

## ● Cable Track

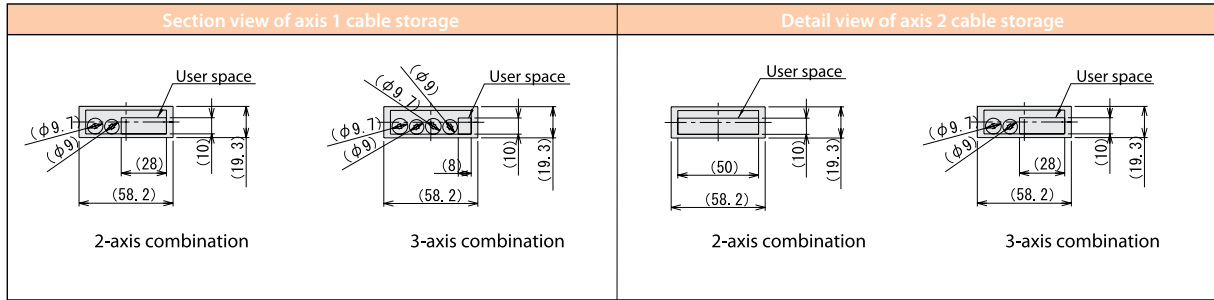

## Detail View of Bracket on Moving End of Cable Track

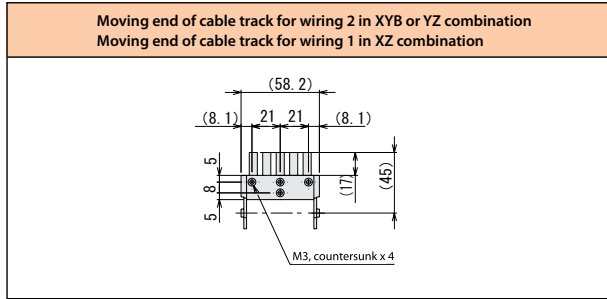

## ● List by Cable Length

Cable code	Length	RCP2 2-axis	RCS2 2-axis	RCP2 3-axis	RCS2 3-axis
		IK2-P	IK2-S	IK3-P	IK3-S
1L	1m	—	—	—	—
2L	2m	—	—	—	—
3L	3m	—	—	—	—
4L	4m	—	—	—	—
5L	5m	—	—	—	—
6L	6m	—	—	—	—
7L	7m	—	—	—	—
8L	8m	—	—	—	—
9L	9m	—	—	—	—
10L	10m	—	—	—	—
11L	11m	—	—	—	—
12L	12m	—	—	—	—
13L	13m	—	—	—	—
14L	14m	—	—	—	—
15L	15m	—	—	—	—
16L	16m	—	—	—	—
17L	17m	—	—	—	—
18L	18m	—	—	—	—
19L	19m	—	—	—	—
20L	20m	—	—	—	—

\* Axis 1 comes with a standard cable, while axes 2 and 3 come with a robot cable.

2-axis Combinations  
RCP2

2-axis Combinations  
RCS2

3-axis Combinations  
RCP2

3-axis Combinations  
RCS2

3-axis Combinations  
RCS2

Controllers

2-axis  
Combinations  
RCP2

2-axis  
Combinations  
RCS2

3-axis  
Combinations  
RCP2

3-axis  
Combinations  
RCS2



Controllers

# Controllers

<b>PSEL</b>	<b>RPC2-series program controller</b>	<b>PSEL-C</b>	<b>93</b>
<b>SSEL</b>	<b>RCS2-series program controller</b>	<b>SSEL-C</b>	<b>103</b>
<b>ROBONET</b>	<b>Field network controller</b>	<b>RPCON/RACON/Gateway units</b>	<b>113</b>
<b>XSEL</b>	<b>RCS2-series multi-axis program controller</b>	<b>X-SEL-J / K / P / Q</b>	<b>125</b>

Model  
List

PSEL

SSEL

ROBONET

XSEL

# List of Applicable Controllers

	IA kit model	Applicable controller	
2-axis	IK2-PXBD	PSEL-C-2-42PI-42PI-NP-2-0	2-axis controller
		PCON-C-42PI-NP-2-0	1-axis controller
	IK2-PXBC	RPCON-42P	1 unit
	IK2-PXBB	PSEL-C-2-56PI-56PI-NP-2-0	2-axis controller
		PCON-C-56PI-NP-2-0	1-axis controller
	IK2-PXZB	RPCON-56P	1 unit
	IK2-SXBD	SSEL-C-2-60I-20I-NP-2-[1]	2-axis controller (incremental)
		SSEL-C-2-60A-20A-NP-2-[1]	2-axis controller (absolute)
		SCON-C-60I-NP-2-[1]	1-axis controller (incremental for X-axis)
		SCON-C-60A-NP-2-[1]	1-axis controller (absolute for X-axis)
		SCON-C-20I-NP-2-[1]	1-axis controller (incremental for Y-axis)
		SCON-C-20A-NP-2-[1]	1-axis controller (absolute for Y-axis)
	IK2-SXBC	SSEL-C-2-60I-30I-NP-2-[1]	2-axis controller (incremental)
		SSEL-C-2-60A-30A-NP-2-[1]	2-axis controller (absolute)
		SCON-C-60I-NP-2-[1]	1-axis controller (incremental for X-axis)
		SCON-C-60A-NP-2-[1]	1-axis controller (absolute for X-axis)
		SCON-C-30I-NP-2-[1]	1-axis controller (incremental for Y-axis)
		SCON-C-30A-NP-2-[1]	1-axis controller (absolute for Y-axis)
	IK2-SXBB	SSEL-C-2-100I-60I-NP-2-[1]	2-axis controller (incremental)
		SSEL-C-2-100A-60A-NP-2-[1]	2-axis controller (absolute)
		SCON-C-100I-NP-2-[1]	1-axis controller (incremental for X-axis)
		SCON-C-100A-NP-2-[1]	1-axis controller (absolute for X-axis)
		SCON-C-60I-NP-2-[1]	1-axis controller (incremental for Y-axis)
		SCON-C-60A-NP-2-[1]	1-axis controller (absolute for Y-axis)
	IK2-SXBA	SSEL-C-2-150I-100I-NP-2-[1]	2-axis controller (incremental)
		SSEL-C-2-150A-100A-NP-2-[1]	2-axis controller (absolute)
		SCON-C-150I-NP-2-[1]	1-axis controller (incremental for X-axis)
		SCON-C-150A-NP-2-[1]	1-axis controller (absolute for X-axis)
		SCON-C-100I-NP-2-[1]	1-axis controller (incremental for Y-axis)
		SCON-C-100A-NP-2-[1]	1-axis controller (absolute for Y-axis)
IK2-SXZB	SSEL-C-2-100I-60I-NP-2-[1]	2-axis controller (incremental)	
	SSEL-C-2-100A-60A-NP-2-[1]	2-axis controller (absolute)	
	SCON-C-100I-NP-2-[1]	1-axis controller (incremental for X-axis)	
	SCON-C-100A-NP-2-[1]	1-axis controller (absolute for X-axis)	
	SCON-C-60I-NP-2-[1]	1-axis controller (incremental for Z-axis)	
	SCON-C-60A-NP-2-[1]	1-axis controller (absolute for Z-axis)	
IK2-SYBB	SSEL-C-2-100I-60I-NP-2-[1]	2-axis controller (incremental)	
	SSEL-C-2-100A-60A-NP-2-[1]	2-axis controller (absolute)	
	SCON-C-100I-NP-2-[1]	1-axis controller (incremental for Y-axis)	
	SCON-C-100A-NP-2-[1]	1-axis controller (absolute for Y-axis)	
	SCON-C-60I-NP-2-[1]	1-axis controller (incremental for Z-axis)	
	SCON-C-60A-NP-2-[1]	1-axis controller (absolute for Z-axis)	
3-axis	IK3-PBBG	PSEL-C-2-56PI-42PI-NP-2-0	2-axis controller (for X/Y-axes)
		PCON-C-56PI-NP-2-0	1-axis controller (for X-axis)
		PCON-C-42PI-NP-2-0	1-axis controller (for Y-axis, Z-axis)
		RPCON-56P	1-axis controller (for X-axis)
		RPCON-42P	1-axis controller (for Y-axis, Z-axis)
	IK3-SBBG	SSEL-C-2-100I-60I-NP-2-[1]	2-axis controller (incremental for X/Y-axis)
		SSEL-C-2-100A-60A-NP-2-[1]	2-axis controller (absolute for X/Y-axis)
		SCON-C-100I-NP-2-[1]	1-axis controller (incremental for X-axis)
		SCON-C-100A-NP-2-[1]	1-axis controller (absolute for X-axis)
		SCON-C-60I-NP-2-[1]	1-axis controller (incremental for Y-axis)
		SCON-C-60A-NP-2-[1]	1-axis controller (absolute for Y-axis)
		SCON-C-30I-NP-2-[1]	1-axis controller (incremental for Z-axis)
		SCON-C-30A-NP-2-[1]	1-axis controller (absolute for Z-axis)
		XSEL-J/K/P/Q	Multi-axis controller (incremental or absolute for X/Y/Z-axis)

[1] Power-supply voltage (1: Single-phase 100 VAC / 2: Single-phase 200 VAC)

2-axis Combinations R C P 2

2-axis Combinations R C S 2

3-axis Combinations R C P 2

3-axis Combinations R C S 2

Controllers

Model List

PSEL

SSEL

ROBONET

XSEL

2-axis  
Combinations  
RCP2

2-axis  
Combinations  
RCS2

3-axis  
Combinations  
RCP2

3-axis  
Combinations  
RCS2

Controllers

# PSEL



RCP2-series  
program controller

### Model List

A program controller capable of operating RCP2-series actuators. Various controls can be performed with a single unit.

Type	C	
Name	Program mode	Positioner mode
Exterior view		
Description	This controller can operate actuators and communicate with external devices without requiring any additional device. If two axes are operated, arc interpolation and path operation can be performed.	Up to 1,500 positioning points are supported. Push-motion operation and teaching operation are also possible.
Number of positions	1,500	

### Model

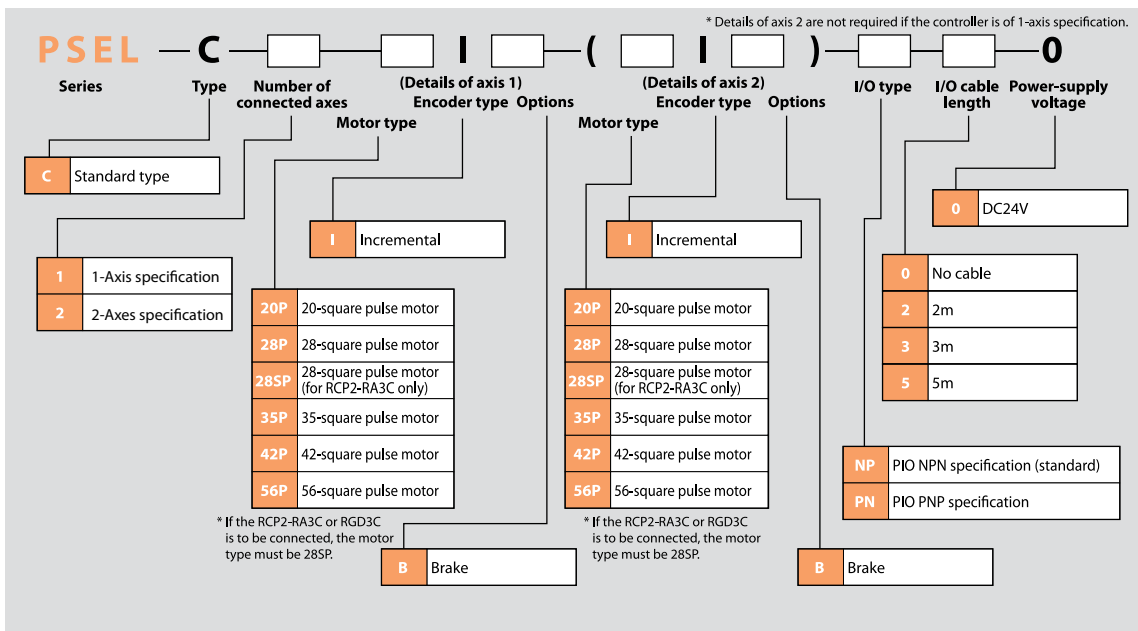

93 PSEL

## I/O Specifications

### Input External input specifications

Item	Specification
Input voltage	DC24V ±10%
Input current	7 mA per circuit
ON/OFF voltages	ON voltage (min.) NPN: DC16V/PNP: DC8V OFF voltage (max.) NPN: DC5V/PNP: DC19V
Insulation method	Photo-coupler

#### NPN specification

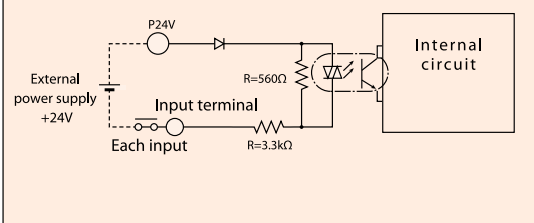

#### PNP specification

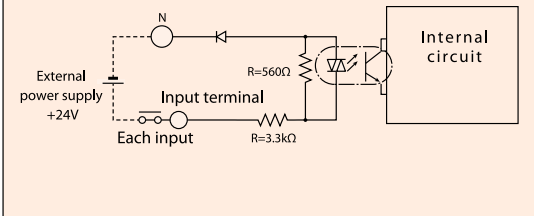

### Output External output specifications

Item	Specification
Load voltage	DC24V
Maximum load current	100 mA per point, total 400 mA for 8 points
Leak current (max.)	Max. 0.1 mA per point
Insulation method	Photo-coupler

#### NPN specification

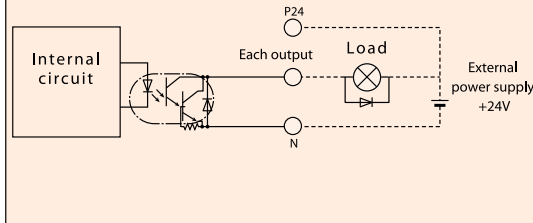

#### PNP specification

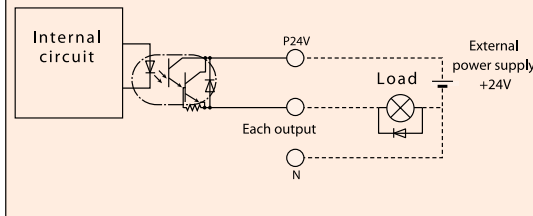

## Explanation of I/O Functions

The PSEL controller can be operated in the "Program Mode" where a program is entered to operate the actuator or "Positioner Mode" where the actuator is moved to positions specified by signals received from a host PLC.

The positioner mode includes the following five input patterns to support various applications.

### Functions by Controller Type

Operation mode	Features
Program mode	You can use Super SEL, a language that allows for complex controls using simple commands, to perform linear and smooth interpolation operations, path operation ideal for coating and other applications, arch motion and palletizing operations, and more.
Product-type Switchover Mode	<b>Standard mode</b> The basic operation mode where all you need is to specify a position number and enter a start signal. Push-motion operation, and linear interpolation operation of two axes, is also supported.
	<b>Type switching mode</b> When the system handles multiple loads of the same shape but slightly different hole positions, you can issue movement commands to the same position number by changing the type number.
	<b>2-axis independent mode</b> When a 2-axis controller is used, the two axes can be operated independently using separate commands.
	<b>Teaching mode</b> The slider (rod) can be moved using an external signal to register the stopped position as position data.
	<b>DS-S-C1 compatible mode</b> If you have been using a DS-S-C1 controller, you can swap it with a PSEL controller without having to change the host programs. * Compatibility with actuators is not assured.

2-axis  
Combinations  
R C P 2

2-axis  
Combinations  
R C S 2

3-axis  
Combinations  
R C P 2

3-axis  
Combinations  
R C S 2

Controllers

Model  
List

PSEL

SSEL

ROBONET

XSEL

**System Configuration**

- 2-axis Combinations RCP2
- 2-axis Combinations RCS2
- 3-axis Combinations RCP2
- 3-axis Combinations RCS2
- Controllers
- Model List
- PSEL
- SSEL
- ROBONET
- XSEL

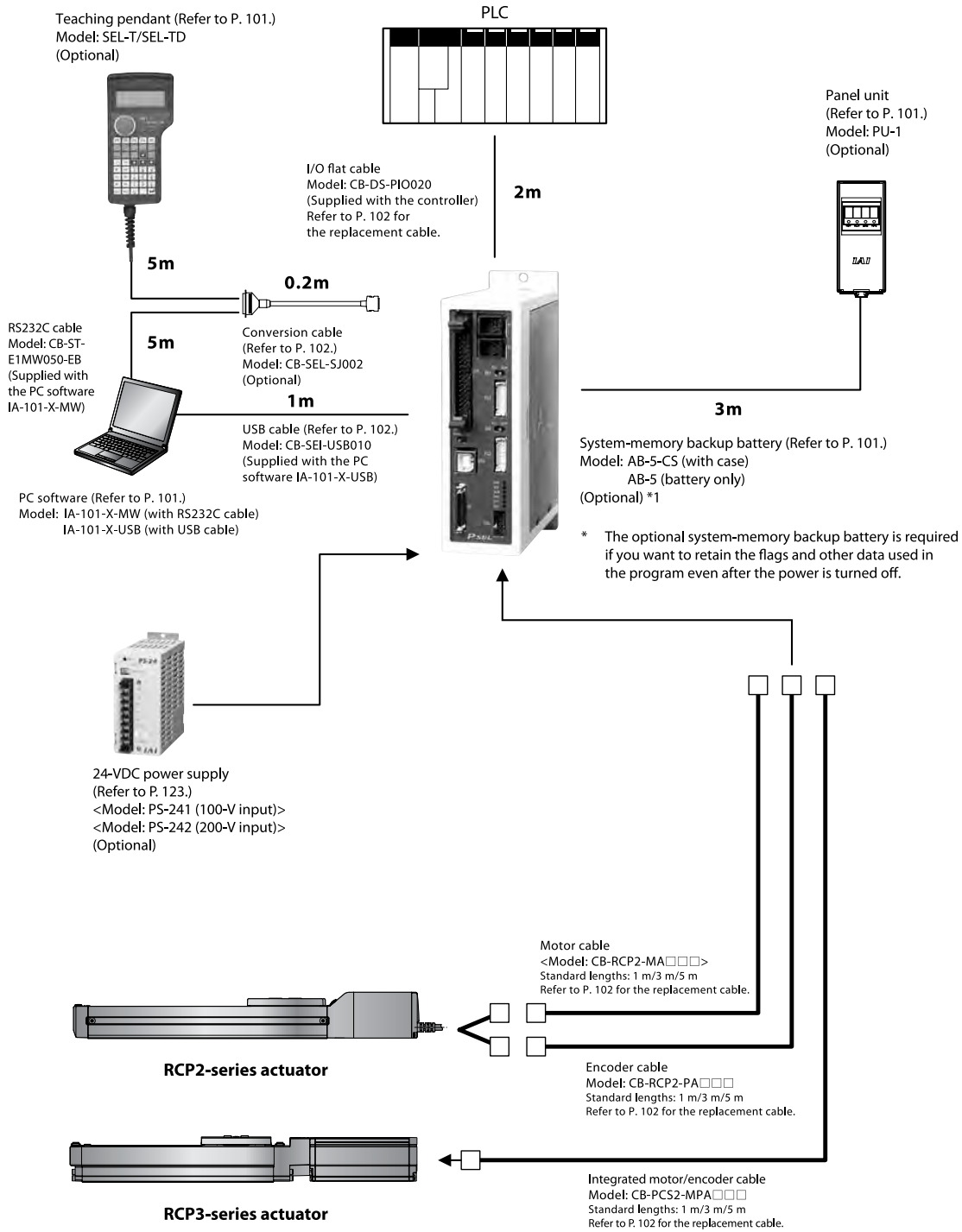



Explanation of I/O Functions

Program Mode

Pin No.	Category	Port No.	Program Mode	Function	Wiring diagram	
1A	P24		24-V input	Connect 24 V.		
1B	Input	016	Program No. 1 selection	Select the program number of the program you want to start. (Enter one of ports 016 to 022 by a BCD code.)		
2A		017	Program No. 2 selection			
2B		018	Program No. 4 selection			
3A		019	Program No. 8 selection			
3B		020	Program No. 10 selection			
4A		021	Program No. 20 selection			
4B		022	Program No. 40 selection			
5A		023	CPU reset			The system is reset and enters the same state achieved after the power has been reconnected.
5B		000	Start			The program selected by one of port Nos. 016 to 022 is started.
6A		001	General-purpose input			The system waits for an external input in response to a program command.
6B	002	General-purpose input				
7A	003	General-purpose input				
7B	004	General-purpose input				
8A	005	General-purpose input				
8B	006	General-purpose input				
9A	007	General-purpose input				
9B	008	General-purpose input				
10A	009	General-purpose input				
10B	010	General-purpose input				
11A	011	General-purpose input				
11B	012	General-purpose input				
12A	013	General-purpose input				
12B	014	General-purpose input				
13A	015	General-purpose input				
13B	Output	300	Alarm	This signal is output when an alarm has occurred. (Contact B)		
14A		301	Ready	This signal is output when the controller has started properly and become ready to operate.		
14B		302	General-purpose output	These signals can be turned ON/OFF freely using program commands.		
15A		303	General-purpose output			
15B		304	General-purpose output			
16A		305	General-purpose output			
16B		306	General-purpose output			
17A	307	General-purpose output				
17B	N		OV input	Connect OV.		

Positioner, Standard Mode

Pin No.	Category	Port No.	Standard Positioner Mode	Function	Wiring diagram	
1A	P24		24-V input	Connect 24 V.		
1B	Input	016	Position input 10	Use one of port Nos. 007 to 019 to specify the position number corresponding to the position to move the actuator to. The value can be specified by either a BCD or binary code.		
2A		017	Position input 11			
2B		018	Position input 12			
3A		019	Position input 13			
3B		020	-			
4A		021	-			
4B		022	-			
5A		023	Error reset			This signal resets minor errors. (The power must be reconnected to reset major errors.)
5B		000	Start			The actuator starts moving to the position corresponding to the selected position number.
6A		001	Home return			The actuator returns home.
6B	002	Servo ON	The servo is turned ON/OFF.			
7A	003	Push motion	The actuator performs push-motion operation.			
7B	004	Pause	The actuator pauses when this signal turns OFF, and resumes the remaining operation when the signal turns ON.			
8A	005	Cancel	The actuator stops when this signal turns OFF, and the remaining operation is cancelled.			
8B	006	Interpolation setting	In the case of a 2-axis specification, the actuators move via linear interpolation while this signal is ON.			
9A	007	Position input 1	Use one of port Nos. 007 to 019 to specify the position number corresponding to the position to move the actuator to. The value can be specified by either a BCD or binary code.			
9B	008	Position input 2				
10A	009	Position input 3				
10B	010	Position input 4				
11A	011	Position input 5				
11B	012	Position input 6				
12A	013	Position input 7				
12B	014	Position input 8				
13A	015	Position input 9				
13B	Output	300	Alarm	This signal is output when an alarm has occurred. (Contact B)		
14A		301	Ready	This signal is output when the controller has started properly and become ready to operate.		
14B		302	Positioning complete	This signal is output when movement to the specified position has completed.		
15A		303	Home return complete	This signal is output when home return has completed.		
15B		304	Servo ON output	This signal is output while the servo is ON.		
16A		305	Push-motion complete	This signal is output when push-motion operation has completed.		
16B		306	System battery error	This signal is output when the system battery voltage has dropped (to the warning level).		
17A	307	-	-			
17B	N		OV input	Connect OV.		

2-axis Combinations R C P 2  
 2-axis Combinations R C S 2  
 3-axis Combinations R C P 2  
 3-axis Combinations R C S 2  
 Controllers

Model List  
 PSEL  
 SSEL  
 ROBOTNET  
 XSEL

Explanation of I/O Functions

Positioner, Product-Type Switchover Mode

Pin No.	Category	Port No.	Type-switching Positioner Mode	Function	
1A	P24		24-V input	Connect 24 V.	
1B		016	Position/type input 10	Use one of port Nos. 007 to 022 to specify the position number corresponding to the position to move the actuator to, and another to specify the type number. Assignment of position numbers and type numbers are set using parameters. The value can be specified by either a BCD or binary code.	
2A		017	Position/type input 11		
2B		018	Position/type input 12		
3A		019	Position/type input 13		
3B		020	Position/type input 14		
4A		021	Position/type input 15		
4B		022	Position/type input 16		
5A		023	Error reset		This signal resets minor errors. (The power must be reconnected to reset major errors.)
5B		000	Start		The actuator starts moving to the position corresponding to the selected position number.
6A		001	Home return		The actuator returns home.
6B		002	Servo ON	The servo is turned ON/OFF.	
7A		003	Push motion	The actuator performs push-motion operation.	
7B		004	Pause	The actuator pauses when this signal turns OFF, and resumes the remaining operation when the signal turns ON.	
8A		005	Cancel	The actuator stops when this signal turns OFF, and the remaining operation is cancelled.	
8B		006	Interpolation setting	In the case of a 2-axis specification, the actuators move via linear interpolation while this signal is ON.	
9A		007	Position/type input 1	Use one of port Nos. 007 to 022 to specify the position number corresponding to the position to move the actuator to, and another to specify the type number. Assignment of position numbers and type numbers are set using parameters. The value can be specified by either a BCD or binary code.	
9B		008	Position/type input 2		
10A		009	Position/type input 3		
10B		010	Position/type input 4		
11A		011	Position/type input 5		
11B		012	Position/type input 6		
12A		013	Position/type input 7		
12B		014	Position/type input 8		
13A		015	Position/type input 9		
13B		300	Alarm		This signal is output when an alarm has occurred. (Contact B)
14A		301	Ready	This signal is output when the controller has started properly and become ready to operate.	
14B		302	Positioning complete	This signal is output when movement to the specified position has completed.	
15A		303	Home return complete	This signal is output when home return has completed.	
15B		304	Servo ON output	This signal is output while the servo is ON.	
16A		305	Push-motion complete	This signal is output when push-motion operation has completed.	
16B		306	System battery error	This signal is output when the system battery voltage has dropped (to the warning level).	
17A		307	-	-	
17B	N		OV input	Connect OV.	

Wiring diagram

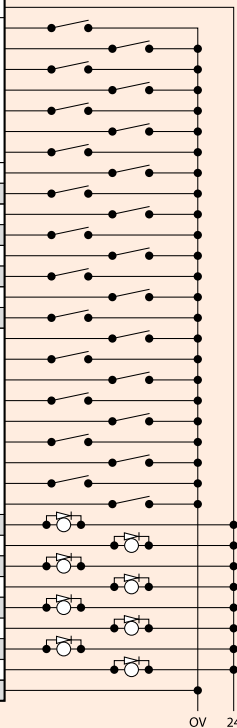

Positioner, 2-axes Independent Mode

Pin No.	Category	Port No.	Type-switching Positioner Mode	Function	
1A	P24		24-V input	Connect 24 V.	
1B		016	Position input 7	Use any of port Nos. 010 to 022 to specify the position number corresponding to the position to move the actuator to. Assignment of position numbers for axes 1 and 2 are set using parameters. The value can be specified by either a BCD or binary code.	
2A		017	Position input 8		
2B		018	Position input 9		
3A		019	Position input 10		
3B		020	Position input 11		
4A		021	Position input 12		
4B		022	Position input 13		
5A		023	Error reset		This signal resets minor errors. (The power must be reconnected to reset major errors.)
5B		000	Start 1		Axis 1 starts moving to the selected position number.
6A		001	Home return 1		Axis 1 returns home.
6B		002	Servo ON 1	The servo of axis 1 is turned ON/OFF.	
7A		003	Pause 1	Axis 1 pauses when this signal turns OFF, and resumes the remaining operation when the signal turns ON.	
7B		004	Cancel 1	Movement of axis 1 is cancelled.	
8A		005	Start 2	Axis 2 starts moving to the selected position number.	
8B		006	Home return 2	Axis 2 returns home.	
9A		007	Servo ON 2	The servo of axis 2 is turned ON/OFF.	
9B		008	Pause 2	Axis 2 pauses when this signal turns OFF, and resumes the remaining operation when the signal turns ON.	
10A		009	Cancel 2	Movement of axis 2 is cancelled.	
10B		010	Position input 1	Use any of port Nos. 010 to 022 to specify the position number corresponding to the position to move the actuator to. Assignment of position numbers for axes 1 and 2 are set using parameters. The value can be specified by either a BCD or binary code.	
11A		011	Position input 2		
11B		012	Position input 3		
12A		013	Position input 4		
12B		014	Position input 5		
13A		015	Position input 6		
13B		300	Alarm		This signal is output when an alarm has occurred. (Contact B)
14A		301	Ready		This signal is output when the controller has started properly and become ready to operate.
14B		302	Positioning complete 1		This signal is output when movement of axis 1 to the specified position has completed.
15A		303	Home return complete 1		This signal is output when home return of axis 1 has completed.
15B		304	Servo ON output 1	This signal is output while the servo of axis 1 is ON.	
16A		305	Positioning complete 2	This signal is output when movement of axis 2 to the specified position has completed.	
16B		306	Home return complete 2	This signal is output when home return of axis 2 has completed.	
17A		307	Servo ON output 2	This signal is output while the servo of axis 2 is ON.	
17B	N		OV input	Connect OV.	

Wiring diagram

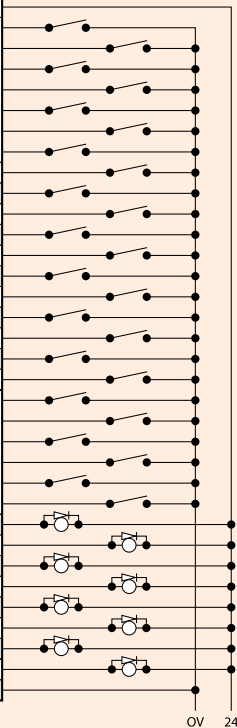

Explanation of I/O Functions

Positioner, Teach Mode

Pin No.	Category	Port No.	Type-switching Positioner Mode	Function	
1A	Input	P24	24-V input	Connect 24 V.	
1B			016	Axis 1 JOG -	Axis 1 moves in the negative direction while this signal is input.
2A			017	Axis 2 JOG +	Axis 2 moves in the positive direction while this signal is input.
2B			018	Axis 2 JOG -	Axis 2 moves in the negative direction while this signal is input.
3A			019	Inching specification (0.01 mm)	Specify the travel over which to move the actuator by inching. (The travel is the sum of values specified by port Nos. 019 to 022.)
3B			020	Inching specification (0.1 mm)	
4A			021	Inching specification (0.5 mm)	
4B			022	Inching specification (1 mm)	
5A			023	Error reset	
5B			000	Start	The actuator starts moving to the position corresponding to the selected position number.
6A			001	Servo ON	The servo is turned ON/OFF.
6B			002	Pause	The actuator pauses when this signal turns OFF, and resumes the remaining operation when the signal turns ON.
7A			003	Position input 1	Use one of port Nos. 003 to 013 to specify the position number corresponding to the position to move the actuator to, and another to specify the position number under which to input the current position. If port No. 014 for teaching mode specification is ON, the current value is written to the specified position number when port No. 000 for start signal turns ON.
7B	004	Position input 2			
8A	005	Position input 3			
8B	006	Position input 4			
9A	007	Position input 5			
9B	008	Position input 6			
10A	009	Position input 7			
10B	010	Position input 8			
11A	011	Position input 9			
11B	012	Position input 10			
12A	013	Position input 11	Output		
12B	014	Teaching mode specification			
13A	015	Axis 1 JOG +		Axis 1 moves in the positive direction while this signal is input.	
13B	300	Alarm		This signal is output when an alarm has occurred. (Contact B)	
14A	301	Ready		This signal is output when the controller has started properly and become ready to operate.	
14B	302	Positioning complete		This signal is output when movement to the specified position has completed.	
15A	303	Home return complete		This signal is output when home return has completed.	
15B	304	Servo ON output		This signal is output while the servo is ON.	
16A	305	-		-	
16B	306	System battery error		This signal is output when the system battery voltage has dropped (to the warning level).	
17A	307	-	-		
17B	N	OV input	Connect OV.		

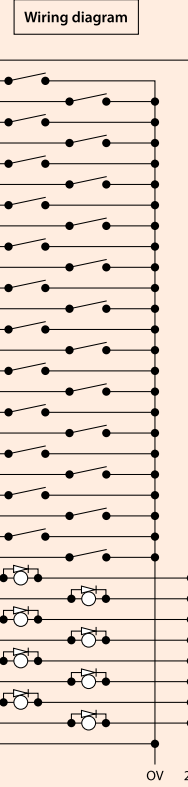

Positioner, DS-S-C1 Compatible Mode

Pin No.	Category	Port No.	Standard Positioner Mode	Function	
1A	Input	P24	24-V input	Connect 24 V.	
1B			016	Position No. 1000	(Same with port Nos. 004 to 015.)
2A			017	-	-
2B			018	-	-
3A			019	-	-
3B			020	-	-
4A			021	-	-
4B			022	-	-
5A			023	CPU reset	The system is reset and enters the same state achieved after the power has been reconnected.
5B			000	Start	The actuator starts moving to the position corresponding to the selected position number.
6A			001	Hold (pause)	The actuator pauses when this signal turns ON, and resumes the remaining operation when the signal turns OFF.
6B			002	Cancel	The actuator stops when this signal turns ON, and the remaining operation is cancelled.
7A			003	Interpolation setting	In the case of a 2-axis specification, the actuators move via linear interpolation while this signal is ON.
7B	004	Position No. 1	Use one of port Nos. 004 to 016 to specify the position number corresponding to the position to move the actuator to. The value is specified by a BCD code.		
8A	005	Position No. 2			
8B	006	Position No. 4			
9A	007	Position No. 8			
9B	008	Position No. 10			
10A	009	Position No. 20			
10B	010	Position No. 40			
11A	011	Position No. 80			
11B	012	Position No. 100			
12A	013	Position No. 200			
12B	014	Position No. 400	Output		
13A	015	Position No. 800			
13B	300	Alarm		This signal is output when an alarm has occurred. (Contact A)	
14A	301	Ready		This signal is output when the controller has started properly and become ready to operate.	
14B	302	Positioning complete		This signal is output when movement to the specified position has completed.	
15A	303	-		-	
15B	304	-		-	
16A	305	-		-	
16B	306	System battery error		This signal is output when the system battery voltage has dropped (to the warning level).	
17A	307	-		-	
17B	N	OV input	Connect OV.		

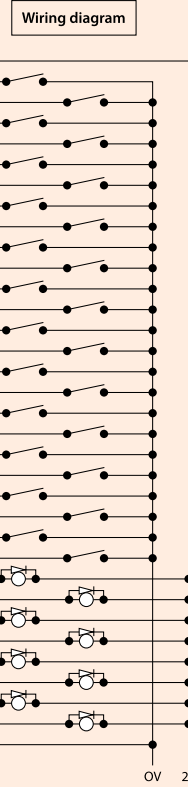

- 2-axis Combinations R C P 2
- 2-axis Combinations R C S 2
- 3-axis Combinations R C P 2
- 3-axis Combinations R C S 2
- Controllers
- Model List
- PSEL
- SSEL
- ROBONET
- XSEL

- 2-axis Combinations RCP2
- 2-axis Combinations RCS2
- 3-axis Combinations RCP2
- 3-axis Combinations RCS2
- Controllers

**Specification Table**

	Item	Specification
Base specifications	Connected actuator	RCP2-series actuator (Note 1)
	Input voltage	24 VDC ±10%
	Power-supply capacity	Max. 5.5 A
	Dielectric strength	500 VDC, 10 MΩ or more
	Withstand voltage	500 VAC, 1 minute
	Rush current	Max. 30 A
Control specifications	Vibration resistance	XYZ directions: 10 to 57 Hz: (Single amplitude) 0.035 mm (continuous), 0.075 mm (intermittent) 58 to 150 Hz: 4.9 m/sec <sup>2</sup> (continuous), 9.8 m/sec <sup>2</sup> (intermittent)
	Number of controlled axes	1/2
	Maximum total output of connected axes	-
	Position detection method	Incremental encoder
Program	Speed setting	1 mm/sec ~ (The maximum limit varies depending on the actuator.)
	Acceleration setting	0.01 G ~ (The maximum limit varies depending on the actuator.)
	Operation method	Program operation/positioner operation (switchable)
	Program language	Super SEL
	Number of programs	64
	Number of program steps	2,000
	Number of multi-tasking programs	8
	Number of positioning points	1500
	Data storage device	Flash ROM (An optional system-memory backup battery can be added.)
	Data input method	Teaching pendant or PC software
Communication related	Number of I/O points	24 input points/8 output points (NPN/PNP selectable)
	I/O power supply	24 VDC ±10%, externally supplied
	PIO cable	CB-DS-PIO□□□ (supplied with the controller)
	Serial communication function	RS232C (half-pitch connector)/USB connector
	Field network cable	(To be supported in the future)
	Motor cable	CB-RCP2-MA□□□ (max. 20 m)
	Encoder cable	CB-RCP2-PA□□□ (max. 20 m)
General specifications	Protective functions	Motor/driver temperature check, encoder open check, soft limit overtravel, system error, battery error, etc.
	Surrounding air temperature/humidity	0 to 40°C, 10 to 95% (non-condensing)
	Surrounding ambience	Free from corrosive gases or significant dust.
	Protection degree	IP20
	Weight	Approx. 450 g
	External dimensions	43 mm (W) x 159 mm (H) x 110 mm (D)

The high-thrust type (RA10C), high-speed type (HS8C/HS8R) and waterproof type (RCP2W-SA16) are not operated.

**External Dimensions**

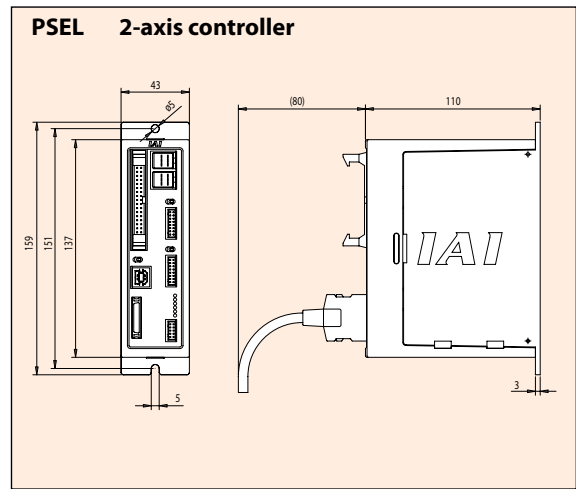
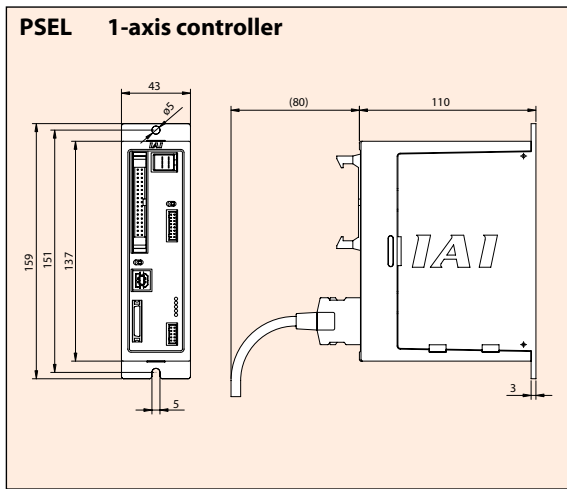

- Model List
- PSEL
- SSEL
- ROBONET
- XSEL

Name of Each part

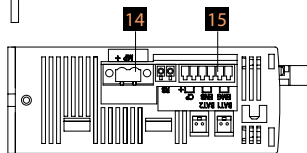
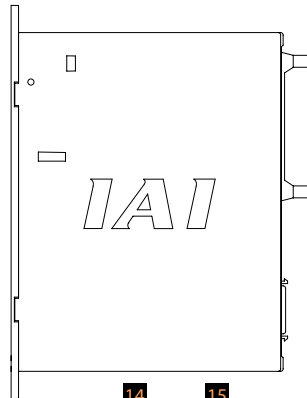
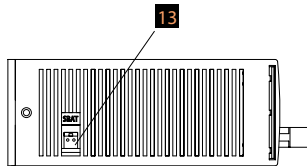
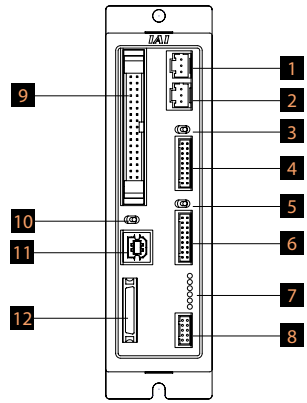

**1** Axis 1 motor connector

Connect the motor cable for actuator axis 1 here.

**2** Axis 2 motor connector

Connect the motor cable for actuator axis 2 here.

**3** Axis 1 brake switch

This switch is used to release the axis brake. When the switch is set to the left (RLS) position, the brake is forcibly released. When the switch is set to the right (NOM) position, the brake is controlled automatically by the controller.

**4** Axis 1 encoder connector

Connect the encoder cable for actuator axis 1 here.

**5** Axis 2 brake switch

This switch is used to release the axis brake. When the switch is set to the left (RLS) position, the brake is forcibly released. When the switch is set to the right (NOM) position, the brake is controlled automatically by the controller.

**6** Axis 2 encoder connector

Connect the encoder cable for actuator axis 2 here.

**7** Status indicator LEDs

These LEDs indicate the operating status of the controller. What is indicated by each LED is explained below:

- PWR:** The power is currently input to the controller.
- RDY:** The controller is ready to perform program operation.
- ALM:** The controller is abnormal.
- EMG:** An emergency stop has been actuated and the drive source is being cut off.
- SV1:** The servo of actuator axis 1 is turned ON.
- SV2:** The servo of actuator axis 2 is turned ON.

**8** Panel unit connector

This connector is used to connect the panel unit (optional) for displaying the controller status and error numbers.

**9** IO connector

A connector for interface IOs.

If a DIO (24IN/8OUT) interface is used, this connector accepts a 34-pin flat cable connector.

The IO power is also supplied to the controller through this connector (pins 1 and 34).

**10** Mode switch

This switch is used to indicate the operation mode of the controller.

The left position indicates the MANU (manual operation) mode, while the right position indicates the AUTO (auto operation) mode. Teaching operation can only be performed in the MANU mode, and operation using external IOs cannot be performed in the MANU mode.

**11** USB connector

This connector is used to make USB connection with a PC. When the USB connector is in use, the TP connector cannot be used because communication through the TP connector is cut off.

**12** Teaching pendant connector

This half-pitch, IO26-pin connector is used to connect a teaching pendant when the operation mode is MANU. You need a dedicated conversion cable to connect to a conventional D-sub, 25-pin connector.

**13** System-memory backup battery connector

This connector is used to connect the battery needed to retain the various data stored in the built-in SRAM of the controller even after the power is cut off. The system-memory backup battery is installed on the exterior of the unit. This battery is not a standard accessory (available as an option).

**14** Motor-power input connector

This connector is used to input the motor power and consists of a 2-pin, 2-piece connector by Phoenix Contact.

**15** Control-power/system input connector

This connector is used to connect the controller power input, emergency stop switch and enable switch, and consists of a 6-pin, 2-piece connector by Phoenix Contact.

2-axis  
Combinations  
R C P 2

2-axis  
Combinations  
R C S 2

3-axis  
Combinations  
R C P 2

3-axis  
Combinations  
R C S 2

Controllers

Model  
List

PSEL

SSEL

ROBONET

XSEL

**Options**

**Teaching Pendant**

**Features** A teaching device offering functions for program/position input, test operation, monitoring, and more.

**Model/Price**

Model	Description
SEL-T-J	Standard type with connector conversion cable
SEL-TD-J	Deadman switch type with connector conversion cable

**Configuration**

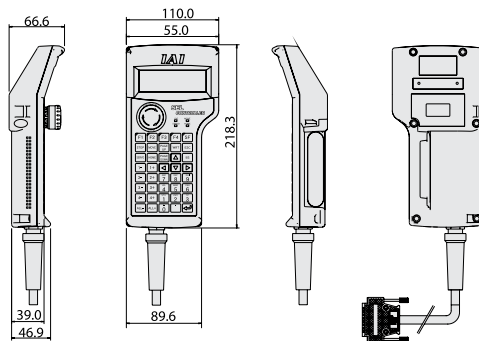
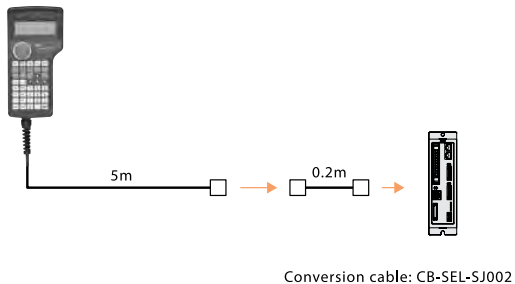

**Specification**

Item	SEL-T-J	SEL-TD-J
3-position enable switch	Not equipped	Equipped
ANSI/UL standard	Not compliant	Compliant
CE mark	Compliant	
Display	20 characters x 4 lines	
Surrounding air temperature/humidity	0-40°C 10-90%RH (non-condensing)	
Protection structure	IP54	
Weight	Approx. 0.4 kg (excluding cables)	

**PC Software (Windows only)**

**Features** A software program that assists the initial startup of your system, offering functions for program/position input, test operation, monitoring, and more. The enhanced debugging functions help reduce the startup time.

**Model** **IA-101-X-MW-J** (with RS232C cable + connector conversion cable)

**Configuration**

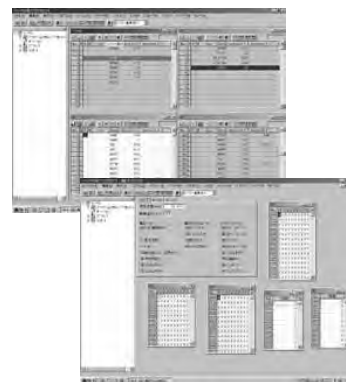
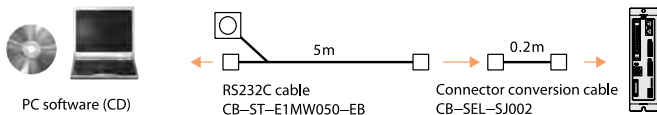

**Note**  
The PSEL controller only supports version 7.0.0.0 or later.

**Model** **IA-101-X-USB** (with USB cable)

**Configuration**

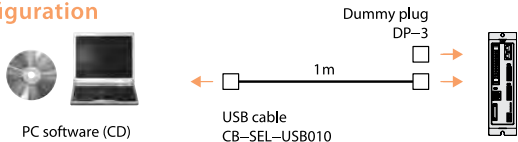

**Panel Unit**

**Features** A display for checking controller error codes and the program number of the current program.

**Model** **PU-1** (cable length: 3 m)

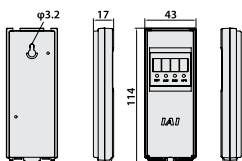

**System memory backup battery**

**Features** This battery is needed when global flags, etc., are used in the program and you want the data to be retained even after the power is turned off.

**Model** **AB-5-CS** (with case)  
**AB-5** (battery)



**Dummy plug**

**Features** This plug is connected to the teaching pendant to cut off the enable circuit when connecting the PSEL controller to a PC via a USB cable. (This plug is supplied with the PC software IA-101-X-USB.)

**Model** **DP-3**



2-axis Combinations R C P 2  
 2-axis Combinations R C S 2  
 3-axis Combinations R C P 2  
 3-axis Combinations R C S 2  
 Controllers  
 Model List  
 PSEL  
 SSEL  
 ROBOTNET  
 XSEL

Options

USB cable

- Features** This cable is used to connect a controller with USB port to a PC. To connect a controller without USB port (XSEL) to a PC, connect the controller's RS232C cable to a USB cable via a USB conversion adapter and connect the USB cable to the USB port on the PC. (Refer to the PC software IA-101-X-USBMW.)
- Model** **CB-SEL-USB010** (cable length: 1 m)



Connector conversion cable

- Features** This conversion cable is used to connect the D-sub, 25-pin connector for teaching pendant or PC to the teaching connector (half-pitch) on the PSEL controller.
- Model** **CB-SEL-SJ002** (cable length: 0.2 m)



Replacement Parts

If you must order a replacement cable, etc., after the initial purchase of your product, specify the correct model by referring to the information below.

Motor Cable

Item **CB-RCP2-MA** [ ] [ ] [ ] \* The standard motor cable is a robot cable. [ ] [ ] indicates the cable length (L). A desired length up to 20 m can be specified. Example) 080 = 8 m

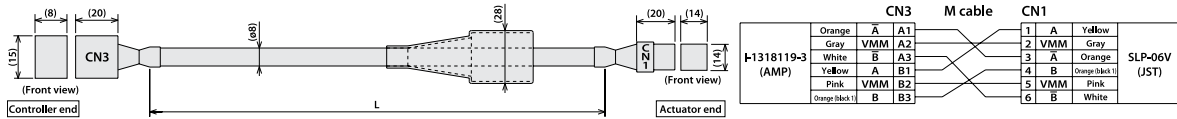

Encoder Cable/Robot Encoder Cable

Item **CB-RCP2-PB** [ ] [ ] [ ] / **CB-RCP2-PB** [ ] [ ] [ ] -**RB** \* The standard encoder cable is a normal cable. A robot cable can be specified as an option. [ ] [ ] indicates the cable length (L). A desired length up to 20 m can be specified. Example) 080 = 8 m

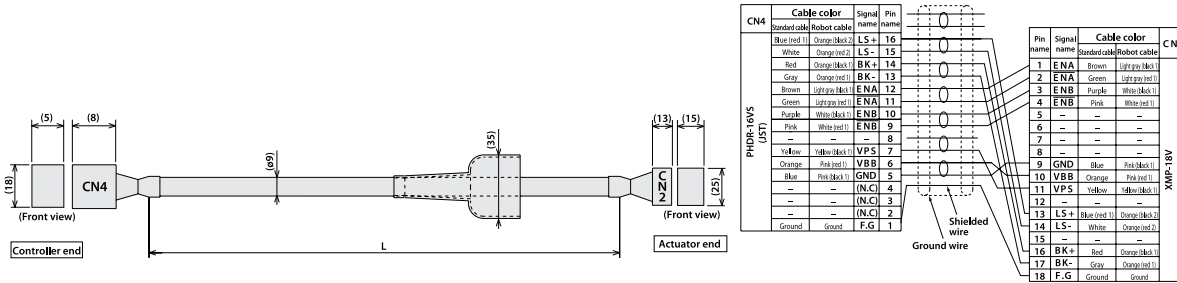

Integrated Motor/Encoder Cable for RCP3

Item **CB-PCS-MPA** [ ] [ ] [ ] \* [ ] [ ] indicates the cable length (L). A desired length up to 10 m can be specified. Example) 080 = 8 m

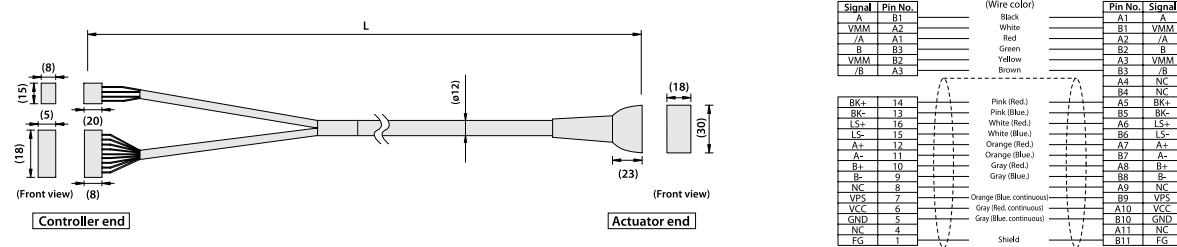

I/O Flat Cable

Item **CB-DS-PIO** [ ] [ ] [ ] \* [ ] [ ] indicates the cable length (L). A desired length up to 10 m can be specified. Example) 080 = 8 m

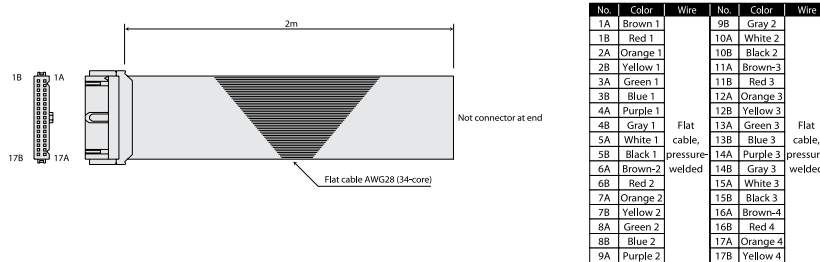

2-axis Combinations RCP2  
 2-axis Combinations RCS2  
 3-axis Combinations RCP2  
 3-axis Combinations RCS2  
 Controllers  
 Model List  
 PSEL  
 SSEL  
 ROBOTNET  
 XSEL

2-axis  
Combinations  
RCP2

2-axis  
Combinations  
RCS2

3-axis  
Combinations  
RCP2

3-axis  
Combinations  
RCS2

Controllers

# SSEL



RCS2-series  
program controller

### Model List/Pricing

A program controller capable of operating RCS2-series actuators. Various controls can be performed with a single unit.

Type	C	
Name	Program mode	Positioner mode
Exterior view		
Description	This controller can operate actuators and communicate with external devices without requiring any additional device. If two axes are operated, arc interpolation, path operation and synchronized operation can be performed.	Up to 20,000 positioning points are supported. Push-motion operation and teaching operation are also possible.
Number of positions	20,000	

### Model

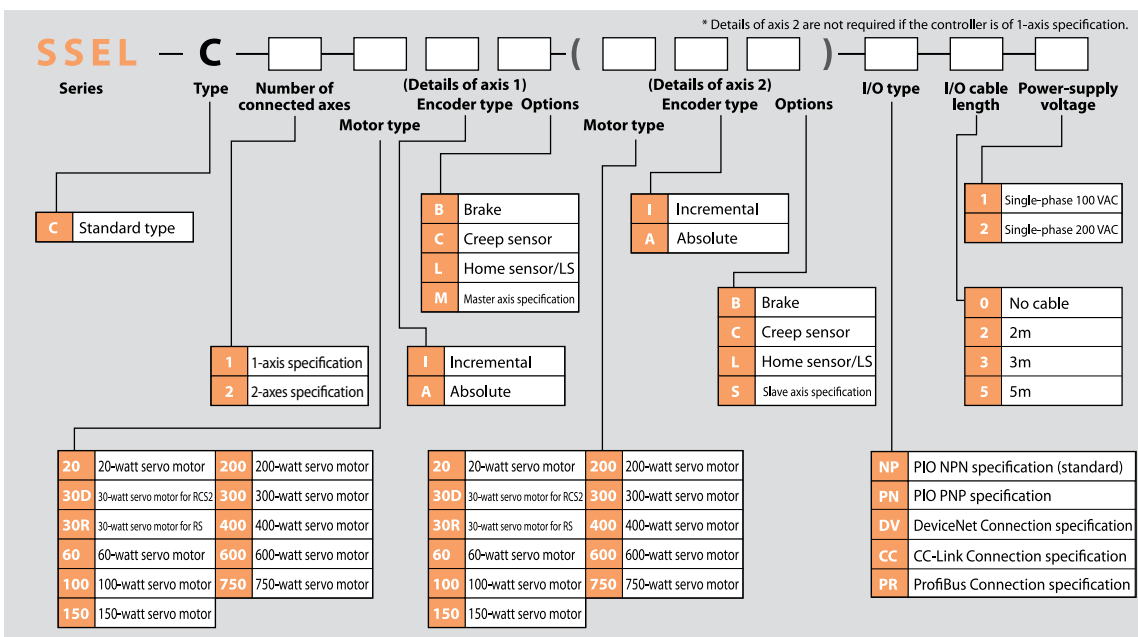

103 SSEL



System Configuration

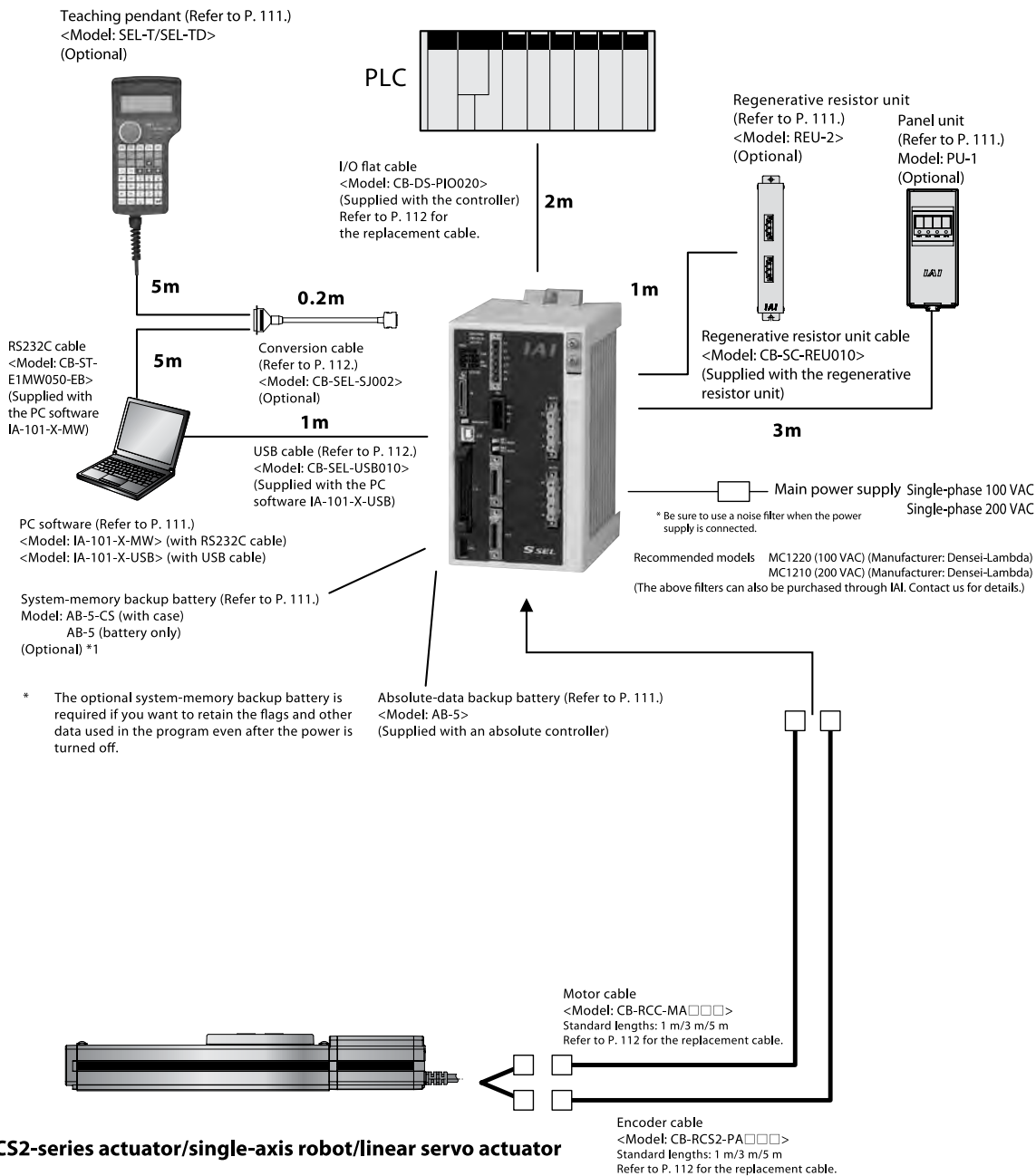

2-axis Combinations R C P 2
2-axis Combinations R C S 2
3-axis Combinations R C P 2
3-axis Combinations R C S 2
<b>Controllers</b>
Model List
PSEL
<b>SSEL</b>
ROBONET
XSEL

**I/O Specifications**

**Input** External input specifications

Item	Specification
Input voltage	DC24V ±10%
Input current	7 mA per circuit
ON/OFF voltages	ON voltage (min.) NPN: DC16V/PNP: DC8V OFF voltage (max.) NPN: DC5V/PNP: DC19V
Insulation method	Photo-coupler

**NPN specification**

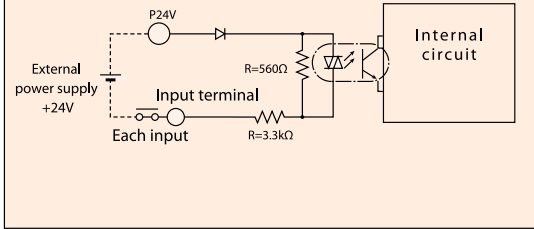

**PNP specification**

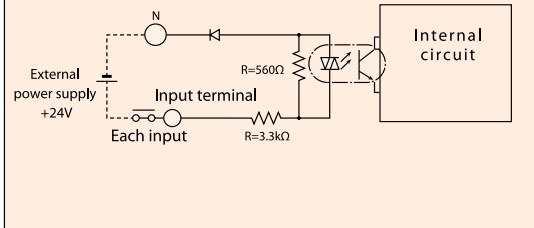

**Output** External output specifications

Item	Specification
Load voltage	DC24V
Maximum load current	100 mA per point, total 400 mA for 8 points
Leak current (max.)	Max. 0.1 mA per point
Insulation method	Photo-coupler

**NPN specification**

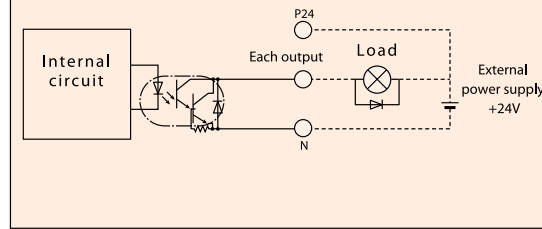

**PNP specification**

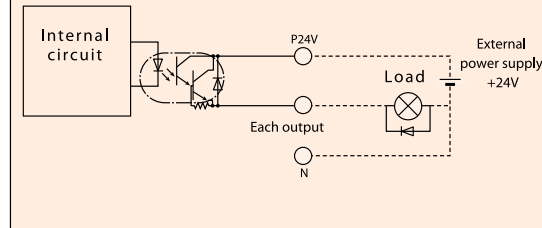

**Explanation of I/O Functions**

The SSEL controller can be operated in the “Program Mode” where a program is entered to operate the actuator or “Positioner Mode” where the actuator is moved to positions specified by signals received from a host PLC. The positioner mode includes the following five input patterns to support various applications.

**Functions by Controller Type**

Operation mode	Features
Program mode	You can use Super SEL, a language that allows for complex controls using simple commands, to perform linear and smooth interpolation operations, path operation ideal for coating and other applications, arch motion and palletizing operations, and more.
Product-Type Switchover Mode	<b>Standard mode</b> The basic operation mode where all you need is to specify a position number and enter a start signal. Push-motion operation, and linear interpolation operation of two axes, is also supported.
	<b>Type switching mode</b> When the system handles multiple loads of the same shape but slightly different hole positions, you can issue movement commands to the same position number by changing the type number.
	<b>2-axis independent mode</b> When a 2-axis controller is used, the two axes can be operated independently using separate commands.
	<b>Teaching mode</b> The slider (rod) can be moved using an external signal to register the stopped position as position data.
	<b>DS-S-C1 compatible mode</b> If you have been using a DS-S-C1 controller, you can swap it with a PSEL controller without having to change the host programs. * Compatibility with actuators is not assured.

Explanation of I/O Functions

Program Mode

Pin No.	Category	Port No.	Program Mode	Function	Wiring diagram		
1A	P24	016-022	24-V input	Connect 24 V.			
1B			Program No. 1 selection	Select the program number of the program you want to start. (Enter one of ports 016 to 022 by a BCD code.)			
2A			Program No. 2 selection				
2B			Program No. 4 selection				
3A			Program No. 8 selection				
3B			Program No. 10 selection				
4A			Program No. 20 selection				
4B			Program No. 40 selection				
5A			023			CPU reset	The system is reset and enters the same state achieved after the power has been reconnected.
5B			000			Start	The program selected by one of port Nos. 016 to 022 is started.
6A			001			General-purpose input	The system waits for an external input in response to a program command.
6B			002			General-purpose input	
7A			003			General-purpose input	
7B	004	General-purpose input					
8A	005	General-purpose input					
8B	006	General-purpose input					
9A	007	General-purpose input					
9B	008	General-purpose input					
10A	009	General-purpose input					
10B	010	General-purpose input					
11A	011	General-purpose input					
11B	012	General-purpose input					
12A	013	General-purpose input					
12B	014	General-purpose input					
13A	015	General-purpose input					
13B	Output	300	Alarm	This signal is output when an alarm has occurred. (Contact B)			
14A		301	Ready	This signal is output when the controller has started properly and become ready to operate.			
14B		302	General-purpose output	These signals can be turned ON/OFF freely using program commands.			
15A		303	General-purpose output				
15B		304	General-purpose output				
16A		305	General-purpose output				
16B		306	General-purpose output				
17A	307	General-purpose output					
17B	N		OV input	Connect OV.			

Positioner, Standard Mode

Pin No.	Category	Port No.	Standard Positioner Mode	Function	Wiring diagram		
1A	P24	016-022	24-V input	Connect 24 V.			
1B			Position input 10	Use one of port Nos. 007 to 019 to specify the position number corresponding to the position to move the actuator to. The value can be specified by either a BCD or binary code.			
2A			Position input 11				
2B			Position input 12				
3A			Position input 13				
3B			Position input 14				
4A			Position input 15				
4B			Position input 16				
5A			023			Error reset	This signal resets minor errors. (The power must be reconnected to reset major errors.)
5B			000			Start	The actuator starts moving to the position corresponding to the selected position number.
6A			001			Home return	The actuator returns home.
6B			002			Servo ON	The servo is turned ON/OFF.
7A			003			Push motion	The actuator performs push-motion operation.
7B	004	Pause	The actuator pauses when this signal turns OFF, and resumes the remaining operation when the signal turns ON.				
8A	005	Cancel	The actuator stops when this signal turns OFF, and the remaining operation is cancelled.				
8B	006	Interpolation setting	In the case of a 2-axis specification, the actuators move via linear interpolation while this signal is ON.				
9A	007	Position input 1	Use one of port Nos. 007 to 019 to specify the position number corresponding to the position to move the actuator to. The value can be specified by either a BCD or binary code.				
9B	008	Position input 2					
10A	009	Position input 3					
10B	010	Position input 4					
11A	011	Position input 5					
11B	012	Position input 6					
12A	013	Position input 7					
12B	014	Position input 8					
13A	015	Position input 9					
13B	Output	300	Alarm	This signal is output when an alarm has occurred. (Contact B)			
14A		301	Ready	This signal is output when the controller has started properly and become ready to operate.			
14B		302	Positioning complete	This signal is output when movement to the specified position has completed.			
15A		303	Home return complete	This signal is output when home return has completed.			
15B		304	Servo ON output	This signal is output while the servo is ON.			
16A		305	Push-motion complete	This signal is output when push-motion operation has completed.			
16B		306	System battery error	This signal is output when the system battery voltage has dropped (to the warning level).			
17A	307	Absolute battery error	This signal is output when the absolute battery voltage has dropped (to the warning level).				
17B	N		OV input	Connect OV.			

2-axis Combinations R C P 2  
2-axis Combinations R C S 2  
3-axis Combinations R C P 2  
3-axis Combinations R C S 2

Controllers

Model List

PSEL

SSEL

ROBONET

XSEL

Explanation of I/O Functions

Positioner, Product-Type Switchover Mode

Pin No.	Category	Port No.	Type-switching Positioner Mode	Function	
1A	P24		24-V input	Connect 24 V.	
1B	Input	016	Position/type input 10	Use one of port Nos. 007 to 022 to specify the position number corresponding to the position to move the actuator to, and another to specify the type number. Assignment of position numbers and type numbers are set using parameters. The value can be specified by either a BCD or binary code.	
2A		017	Position/type input 11		
2B		018	Position/type input 12		
3A		019	Position/type input 13		
3B		020	Position/type input 14		
4A		021	Position/type input 15		
4B		022	Position/type input 16		
5A		023	Error reset		This signal resets minor errors. (The power must be reconnected to reset major errors.)
5B		000	Start		The actuator starts moving to the position corresponding to the selected position number.
6A		001	Home return		The actuator returns home.
6B		002	Servo ON		The servo is turned ON/OFF.
7A		003	Push motion		The actuator performs push-motion operation.
7B		004	Pause		The actuator pauses when this signal turns OFF, and resumes the remaining operation when the signal turns ON.
8A	005	Cancel	The actuator stops when this signal turns OFF, and the remaining operation is cancelled.		
8B	006	Interpolation setting	In the case of a 2-axis specification, the actuators move via linear interpolation while this signal is ON.		
9A	007	Position/type input 1	Use one of port Nos. 007 to 022 to specify the position number corresponding to the position to move the actuator to, and another to specify the type number. Assignment of position numbers and type numbers are set using parameters. The value can be specified by either a BCD or binary code.		
9B	008	Position/type input 2			
10A	009	Position/type input 3			
10B	010	Position/type input 4			
11A	011	Position/type input 5			
11B	012	Position/type input 6			
12A	013	Position/type input 7			
12B	014	Position/type input 8			
13A	015	Position/type input 9			
13B	Output	300	Alarm	This signal is output when an alarm has occurred. (Contact B)	
14A		301	Ready	This signal is output when the controller has started properly and become ready to operate.	
14B		302	Positioning complete	This signal is output when movement to the specified position has completed.	
15A		303	Home return complete	This signal is output when home return has completed.	
15B		304	Servo ON output	This signal is output while the servo is ON.	
16A		305	Push-motion complete	This signal is output when push-motion operation has completed.	
16B		306	System battery error	This signal is output when the system battery voltage has dropped (to the warning level).	
17A	307	Absolute battery error	This signal is output when the absolute battery voltage has dropped (to the warning level).		
17B	N		OV input	Connect OV.	

Wiring diagram

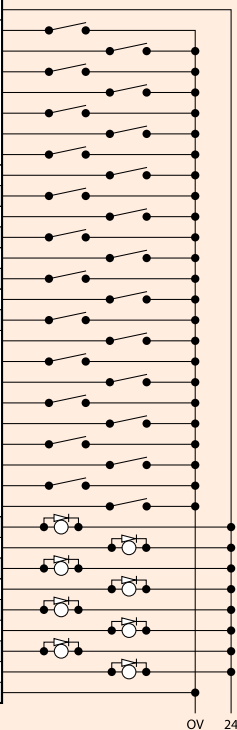

Positioner, 2-axes Independent Mode

Pin No.	Category	Port No.	Type-switching Positioner Mode	Function	
1A	P24		24-V input	Connect 24 V.	
1B	Input	016	Position input 7	Use any of port Nos. 010 to 022 to specify the position number corresponding to the position to move the actuator to. Assignment of position numbers for axes 1 and 2 are set using parameters. The value can be specified by either a BCD or binary code.	
2A		017	Position input 8		
2B		018	Position input 9		
3A		019	Position input 10		
3B		020	Position input 11		
4A		021	Position input 12		
4B		022	Position input 13		
5A		023	Error reset		This signal resets minor errors. (The power must be reconnected to reset major errors.)
5B		000	Start 1		Axis 1 starts moving to the selected position number.
6A		001	Home return 1		Axis 1 returns home.
6B		002	Servo ON 1		The servo of axis 1 is turned ON/OFF.
7A		003	Pause 1		Axis 1 pauses when this signal turns OFF, and resumes the remaining operation when the signal turns ON.
7B		004	Cancel 1		Movement of axis 1 is cancelled.
8A	005	Start 2	Axis 2 starts moving to the selected position number.		
8B	006	Home return 2	Axis 2 returns home.		
9A	007	Servo ON 2	The servo of axis 2 is turned ON/OFF.		
9B	008	Pause 2	Axis 2 pauses when this signal turns OFF, and resumes the remaining operation when the signal turns ON.		
10A	009	Cancel 2	Movement of axis 2 is cancelled.		
10B	010	Position input 1	Use any of port Nos. 010 to 022 to specify the position number corresponding to the position to move the actuator to. Assignment of position numbers for axes 1 and 2 are set using parameters. The value can be specified by either a BCD or binary code.		
11A	011	Position input 2			
11B	012	Position input 3			
12A	013	Position input 4			
12B	014	Position input 5			
13A	015	Position input 6			
13B	Output	300	Alarm	This signal is output when an alarm has occurred. (Contact B)	
14A		301	Ready	This signal is output when the controller has started properly and become ready to operate.	
14B		302	Positioning complete 1	This signal is output when movement of axis 1 to the specified position has completed.	
15A		303	Home return complete 1	This signal is output when home return of axis 1 has completed.	
15B		304	Servo ON output 1	This signal is output while the servo of axis 1 is ON.	
16A		305	Positioning complete 2	This signal is output when movement of axis 2 to the specified position has completed.	
16B		306	Home return complete 2	This signal is output when home return of axis 2 has completed.	
17A	307	Servo ON output 2	This signal is output while the servo of axis 2 is ON.		
17B	N		OV input	Connect OV.	

Wiring diagram

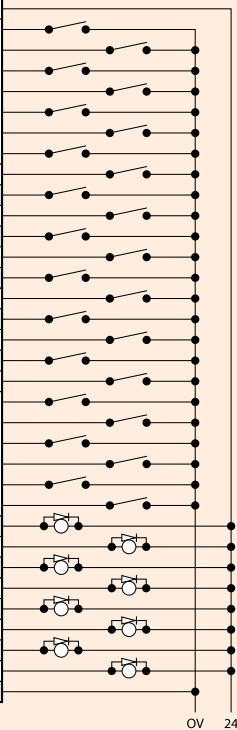

Explanation of I/O Functions

Positioner, Teaching Mode

Pin No.	Category	Port No.	Type-switching Positioner Mode	Function	Wiring diagram	
1A	P24		24-V input	Connect 24 V.		
1B			016	Axis 1 JOG -		Axis 1 moves in the negative direction while this signal is input.
2A			017	Axis 2 JOG +		Axis 2 moves in the positive direction while this signal is input.
2B			018	Axis 2 JOG -		Axis 2 moves in the negative direction while this signal is input.
3A			019	Inching specification (0.01 mm)		Specify the travel over which to move the actuator by inching. (The travel is the sum of values specified by port Nos. 019 to 022.)
3B			020	Inching specification (0.1 mm)		
4A			021	Inching specification (0.5 mm)		
4B			022	Inching specification (1 mm)		
5A			023	Error reset		This signal resets minor errors. (The power must be reconnected to reset major errors.)
5B			000	Start		The actuator starts moving to the position corresponding to the selected position number.
6A			001	Servo ON		The servo is turned ON/OFF.
6B			002	Pause		The actuator pauses when this signal turns OFF and resumes the remaining operation when the signal turns ON.
7A	Input	003	Position input 1	Use one of port Nos. 003 to 013 to specify the position number corresponding to the position to move the actuator to, and another to specify the position number under which to input the current position. If port No. 14 for teaching mode specification is ON, the current value is written to the specified position number when port No. 000 for start signal turns ON.		
7B		004	Position input 2			
8A		005	Position input 3			
8B		006	Position input 4			
9A		007	Position input 5			
9B		008	Position input 6			
10A		009	Position input 7			
10B		010	Position input 8			
11A		011	Position input 9			
11B		012	Position input 10			
12A		013	Position input 11			
12B	014	Teaching mode specification				
13A	015	Axis 1 JOG +	Axis 1 moves in the positive direction while this signal is input.			
13B	300	Alarm	This signal is output when an alarm has occurred. (Contact B)			
14A	301	Ready	This signal is output when the controller has started properly and become ready to operate.			
14B	302	Positioning complete	This signal is output when movement to the specified position has completed.			
15A	303	Home return complete	This signal is output when home return has completed.			
15B	304	Servo ON output	This signal is output while the servo is ON.			
16A	305	-	-			
16B	306	System battery error	This signal is output when the system battery voltage has dropped (to the warning level).			
17A	307	Absolute battery error	This signal is output when the absolute battery voltage has dropped (to the warning level).			
17B	N	OV input	Connect OV.			

Positioner, DS-S-C1 Compatible Mode

Pin No.	Category	Port No.	Standard Positioner Mode	Function	Wiring diagram	
1A	P24		24-V input	Connect 24 V.		
1B			016	Position No. 1000		(Same with port Nos. 004 to 015.)
2A			017	Position No. 2000		-
2B			018	Position No. 4000		-
3A			019	Position No. 8000		-
3B			020	Position No. 10000		-
4A			021	Position No. 20000		-
4B			022	NC (*1)		-
5A			023	CPU reset		The system is reset and enters the same state achieved after the power has been reconnected.
5B			000	Start		The actuator starts moving to the position corresponding to the selected position number.
6A			001	Hold (pause)		The actuator pauses when this signal turns ON and resumes the remaining operation when the signal turns OFF.
6B			002	Cancel		The actuator stops when this signal turns ON, and the remaining operation is cancelled.
7A	Input	003	Interpolation setting	In the case of a 2-axis specification, the actuators move via linear interpolation while this signal is ON.		
7B		004	Position No. 1	Use one of port Nos. 004 to 016 to specify the position number corresponding to the position to move the actuator to. The value is specified by a BCD code.		
8A		005	Position No. 2			
8B		006	Position No. 4			
9A		007	Position No. 8			
9B		008	Position No. 10			
10A		009	Position No. 20			
10B		010	Position No. 40			
11A		011	Position No. 80			
11B		012	Position No. 100			
12A		013	Position No. 200			
12B	014	Position No. 400				
13A	015	Position No. 800				
13B	300	Alarm	This signal is output when an alarm has occurred. (Contact A)			
14A	301	Ready	This signal is output when the controller has started properly and become ready to operate.			
14B	302	Positioning complete	This signal is output when movement to the specified position has completed.			
15A	303	-	-			
15B	304	-	-			
16A	305	-	-			
16B	306	System battery error	This signal is output when the system battery voltage has dropped (to the warning level).			
17A	307	Absolute battery error	This signal is output when the absolute battery voltage has dropped (to the warning level).			
17B	N	OV input	Connect OV.			

(\*1) This input must be turned OFF. Make sure the signal is not connected.

2-axis Combinations R C P 2

2-axis Combinations R C S 2

3-axis Combinations R C P 2

3-axis Combinations R C S 2

Controllers

Model List

PSEL

SSEL

ROBONET

XSEL

2-axis  
Combinations  
RCP2

2-axis  
Combinations  
RCS2

3-axis  
Combinations  
RCP2

3-axis  
Combinations  
RCS2

Controllers

**Specification Table**

	Item	Specification
Base specifications	Connected actuator	RCS2-series actuator/single-axis robot/linear servo actuator
	Input power supply	Single-phase 100 VAC ±10%      Single-phase 200 VAC ±10%
	Power-supply capacity	Max. 1660 VA (400 W, 2-axis operation)
	Dielectric strength	500 VDC, 10 MΩ or more
	Withstand voltage	500 VAC, 1 minute
	Rush current	Max. 30 A
	Vibration resistance	XYZ directions: 10 to 57 Hz: (Single amplitude) 0.035 mm (continuous), 0.075 mm (intermittent) 58 to 150 Hz: 4.9 m/sec <sup>2</sup> (continuous), 9.8 m/sec <sup>2</sup> (intermittent)
Control specifications	Number of controlled axes	1/2
	Maximum total output of connected axes	400 W      800 W
	Position detection method	Incremental encoder/Absolute encoder
	Speed setting	1 mm/sec ~ (The maximum limit varies depending on the actuator.)
Program	Acceleration setting	0.01 G ~ (The maximum limit varies depending on the actuator.)
	Operation method	Program operation/positioner operation (switchable)
Communication related	Program language	Super SEL
	Number of programs	128 (*1)
	Number of program steps	9999 (*1)
	Number of multi-tasking programs	8
	Number of positioning points	20000 (*1)
	Data storage device	Flash ROM (An optional system-memory backup battery can be added.)
	Data input method	Teaching pendant or PC software
	Number of I/O points	24 input points/8 output points (NPN/PNP selectable)
	I/O power supply	24 VDC ±10%, externally supplied
	PIO cable	CB-DS-PIO □□□ (supplied with the controller)
General specifications	Serial communication function	RS232C (half-pitch connector)/USB connector
	Field network cable	(To be supported in the future)
	Motor cable	CB-RCC2-MA □□□ (max. 20 m)
	Encoder cable	CB-RCS2-PA □□□ (max. 20 m)
	Protective functions	Motor overcurrent, motor/driver temperature check, overload check, encoder open check, soft limit overtravel, system battery error, etc.
	Surrounding air temperature/humidity	0 to 40°C, 10 to 95% (non-condensing)
	Surrounding ambience	Free from corrosive gases or significant dust.
Protection degree	IP20	
Weight	1.4 kg	
External dimensions		100 mm (W) x 202.6 mm (H) x 126 mm (D)

(\*1) These specifications are different for PNP controllers. Contact IAI for details.

**External Dimensions**

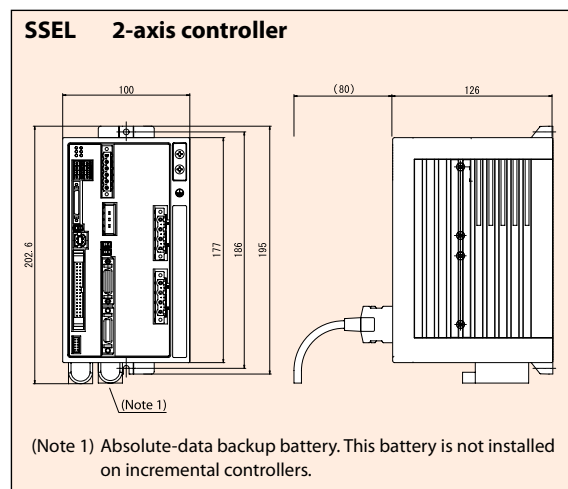
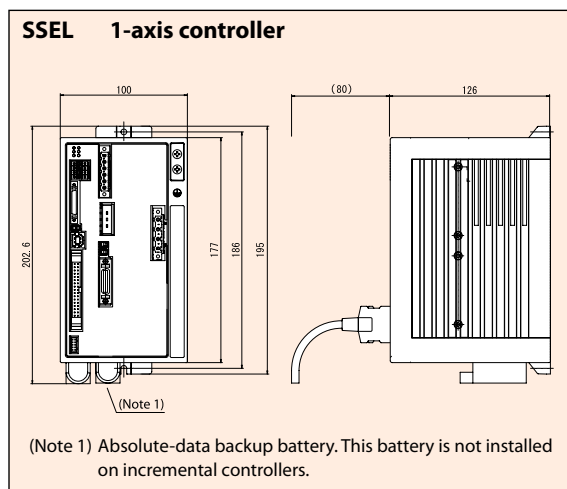

Model  
List

PSEL

SSEL

ROBONET

XSEL

Name of Each Part

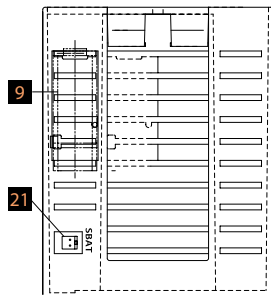
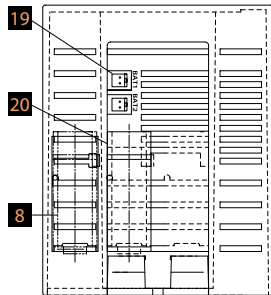
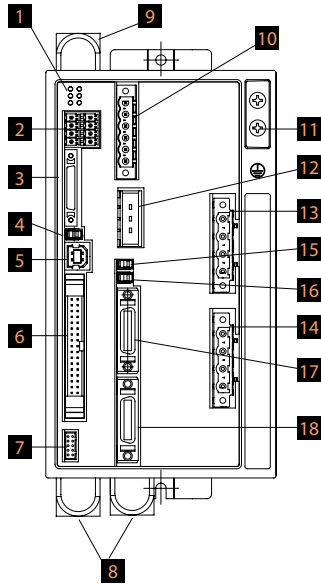

**1** Status indicator LEDs

These LEDs indicate the operating status of the controller. What is indicated by each LED is explained below:

- PWR:** The power is currently input to the controller.
- RDY:** The controller is ready to perform program operation.
- ALM:** The controller is abnormal.
- EMG:** An emergency stop has been actuated and the drive source is being cut off.
- SV1:** The servo of actuator axis 1 is turned ON.
- SV2:** The servo of actuator axis 2 is turned ON.

**2** System I/O connector

This connector connects the emergency stop input, enable input, brake power input, etc.

**3** Teaching pendant connector

This half-pitch, IO26-pin connector is used to connect a teaching pendant when the operation mode is MANU. You need a dedicated conversion cable to connect to a conventional D-sub, 25-pin connector.

**4** Mode switch

This switch is used to indicate the operation mode of the controller. The left position indicates the MANU (manual operation) mode, while the right position indicates the AUTO (auto operation) mode. Teaching operation can only be performed in the MANU mode, and auto operation using external IOs cannot be performed in the MANU mode.

**5** USB connector

This connector is used to make USB connection with a PC. When the USB connector is in use, the TP connector cannot be used because communication through the TP connector is cut off.

**6** IO connector

A connector for interface IOs. If a DIO (24IN/8OUT) interface is used, this connector accepts a 34-pin flat cable connector. The I/O power is also supplied to the controller through this connector (pins 1 and 34).

**7** Panel unit connector

This connector is used to connect the panel unit (optional) for displaying the controller status and error numbers.

**8** Absolute-data backup battery

This battery is used to retain position data even after the power is cut off when an absolute axis is operated.

**9** System-memory backup battery (optional)

This connector is used to connect the battery needed to retain the various data stored in the built-in SRAM of the controller even after the power is cut off. The system-memory backup battery is an optional. Specify the battery only if necessary.

**10** Power-supply connector

A connector for AC power supply. The control power and motor power are input separately.

**11** Grounding screw

A screw for protective grounding. Be sure to connect this screw to ground.

**12** External regenerative resistor connector

This connector is used to connect an additional regenerative resistor when the built-in regenerative resistor is not enough due to high acceleration, high load, etc. Whether or not an external regenerative resistor is needed depends on the specifics of the application, such as the axis configuration.

**13** Axis 1 motor connector

Connect the motor cable for actuator axis 1 here.

**14** Axis 2 motor connector

Connect the motor cable for actuator axis 2 here.

**15** Axis 1 brake switch

This switch is used to release the axis brake. When the switch is set to the left (RLS) position, the brake is forcibly released. When the switch is set to the right (NOM) position, the brake is controlled automatically by the controller.

**16** Axis 2 brake switch

This switch is used to release the axis brake. When the switch is set to the left (RLS) position, the brake is forcibly released. When the switch is set to the right (NOM) position, the brake is controlled automatically by the controller.

**17** Axis 1 encoder connector

Connect the encoder cable for actuator axis 1 here.

**18** Axis 2 encoder connector

Connect the encoder cable for actuator axis 2 here.

**19** Axis 1 absolute battery connector

This connector is used to connect the absolute-data backup battery for axis 1 when the actuator is equipped with an absolute encoder.

**20** Axis 2 absolute battery connector

This connector is used to connect the absolute-data backup battery for axis 2 when the actuator is equipped with an absolute encoder.

**21** System-memory backup battery connector

This connector is used to connect the system-memory backup battery.

2-axis  
Combinations  
R C P 2

2-axis  
Combinations  
R C S 2

3-axis  
Combinations  
R C P 2

3-axis  
Combinations  
R C S 2

Controllers

Model  
List

PSEL

SSEL

ROBONET

XSEL

## Options

### Teaching Pendant

**Features** A teaching device offering functions for program/position input, test operation, monitoring, and more.

#### Model/Price

Model	Description
SEL-T-J	Standard type with connector conversion cable
SEL-TD-J	Deadman switch type with connector conversion cable

#### Configuration

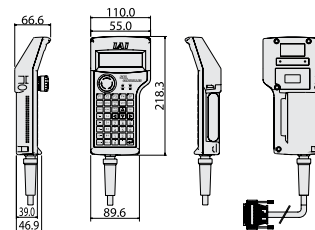
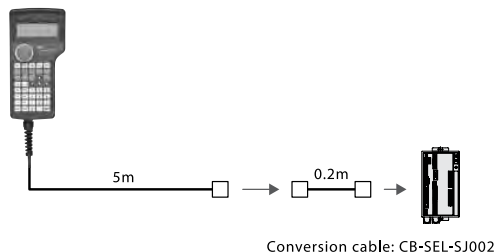

#### Specification

Item	SEL-T-J	SEL-TD-J
3-position enable switch	Not equipped	Equipped
ANSI/UL standard	Not compliant	Compliant
CE mark	Compliant	
Display	20 characters x 4 lines	
Surrounding air temperature/humidity	0-40°C 10-90%RH (non-condensing)	
Protection structure	IP54	
Weight	Approx. 0.4 kg (excluding cables)	

### PC Software (Windows only)

**Features** A software program that assists the initial startup of your system, offering functions for program/position input, test operation, monitoring, and more. The enhanced debugging functions help reduce the startup time.

**Model IA-101-X-MW-J** (with RS232C cable + connector conversion cable)

**IA-101-X-MW** (with RS232C cable)

#### Configuration

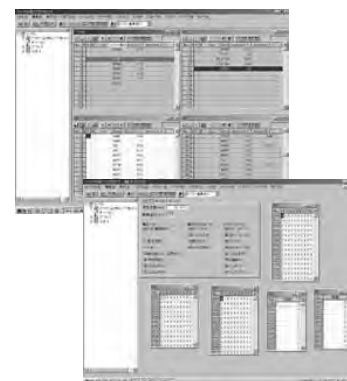
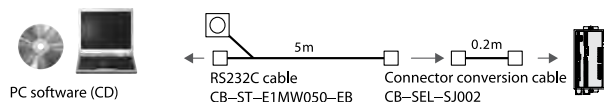

**Model IA-101-X-USB** (with USB cable)

#### Configuration

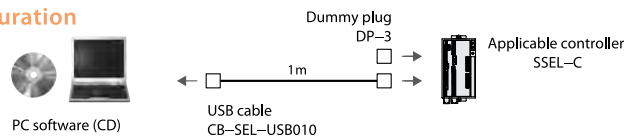

**Note**  
The SSEL controller only supports version 6.0.0.0 or later.

### Regenerative Resistor Unit

**Features** This unit converts to heat the regenerative current produced when the motor decelerates. Use the table on the right to check the total wattage of the actuators to be operated, and provide a regenerative resistor or resistors if necessary.

**Item REU-2** (for SCON/SSEL)

#### Specification

Weight	0.9kg
Built-in regenerative resistor	220Ω 80W
Unit-controller connection cable (supplied)	CB-SC-REU010 (for SSEL)

#### Guide for Determining Necessary Number of Regenerative Resistor Units

	Horizontal	Vertical
0 unit	~800W	~200W
1 unit	~600W	~600W
2 unit	~800W	~800W

\* Depending on the operating conditions, the required number of regenerative resistor unit(s) may be more than what is specified above.

\* If two regeneration units are required, order one REU-2 and one REU-1 (refer to P. 132).

#### External Dimensions

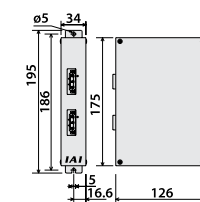

### Panel Unit

**Features** A display for checking controller error codes and the program number of the current program.

**Model PU-1** (cable length: 3 m)

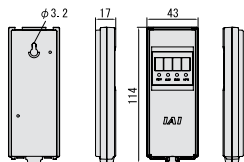

### Absolute-data Backup Battery

**Features** An absolute-data backup battery used when an absolute actuator is operated. The battery is the same as the system-memory backup battery.

**Model AB-5**



### System memory backup battery

**Features** This battery is needed when global flags, etc., are used in the program and you want the data to be retained even after the power is turned off.

**Model AB-5-CS** (with case)  
**AB-5** (battery)



111 SSEL



Options

Dummy plug

**Features** This plug is connected to the teaching pendant to cut off the enable circuit when connecting the SSEL controller to a PC via a USB cable. (This plug is supplied with the PC software IA-101-X-USB.)

**Model** DP-3



USB cable

**Features** This cable is used to connect a controller with USB port to a PC. To connect a controller without USB port (XSEL) to a PC, connect the controller's RS232C cable to a USB cable via a USB conversion adapter and connect the USB cable to the USB port on the PC. (Refer to the PC software IA-101-X-USBMW.)

**Model** CB-SEL-USB010 (cable length: 1 m)



Connector conversion cable

**Features** This conversion cable is used to connect the D-sub, 25-pin connector for teaching pendant or PC to the teaching connector (half-pitch) on the SSEL controller.

**Model** CB-SEL-SJ002 (cable length: 0.2 m)



Replacement Parts

If you must order a replacement cable, etc., after the initial purchase of your product, specify the correct model by referring to the information below.

Motor Cable/Robot Motor Cable

Item **CB-RCC-MA** [ ] [ ] [ ] / **CB-RCC-MA** [ ] [ ] [ ] -**RB**

\* [ ] [ ] indicates the cable length (L). A desired length up to 30 m can be specified. Example) 080 = 8 m

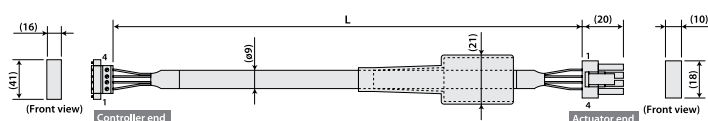

Wire	Color	Signal	No.	Signal	Color	Wire
Green	PE	1	1	U	Red	0.75sq
Red	U	2	2	V	White	(Crimped)
White	V	3	3	W	Black	
Black	W	4	4	PE	Green	

Encoder Cable/Robot Encoder Cable

Item **CB-RCS2-PA** [ ] [ ] [ ] / **CB-X3-PA** [ ] [ ] [ ]

\* [ ] [ ] indicates the cable length (L). A desired length up to 30 m can be specified. Example) 080 = 8 m

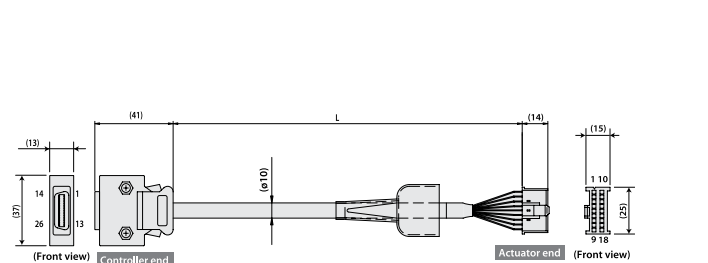

Wire	Color	Signal	No.	No.	Signal	Color	Wire
AWG26 (Soldered)	White	AS	1	1	A	Pink	
	Purple	AV	2	2	B	Purple	
	White	BS	3	3	B	White	
	Black	BY	4	4	F	Black/Red	
	Orange/White	Z	5	5	Z	Orange/White	
	Green/White	CP	6	6	CP	Green/White	
	Orange	SD	7	7	LS+	Brown/White	
	Blue	SBD	8	8			
	Black	BAT+	14	9	FG	Ground	
	White	BAT-	15	10	SD	Blue	
	Green	VCC	16	11	SB	Orange	
	Brown	GND	17	12	BAT+	Black	
	Gray	BRS	20	13	BAT-	Pink	
	Red	BRS+	21	14	VCC	Green	
			22	15	GND	Brown	
				16	LS-	Gray/White	
				17	BB-	Gray	
				18	BB+	Red	

Encoder Cable/Robot Encoder Cable for RCS2-RT6/RT6R/RT7R

Item **CB-RCS2-PLA** [ ] [ ] [ ] / **CB-X2-PLA** [ ] [ ] [ ]

\* [ ] [ ] indicates the cable length (L). A desired length up to 30 m can be specified. Example) 080 = 8 m

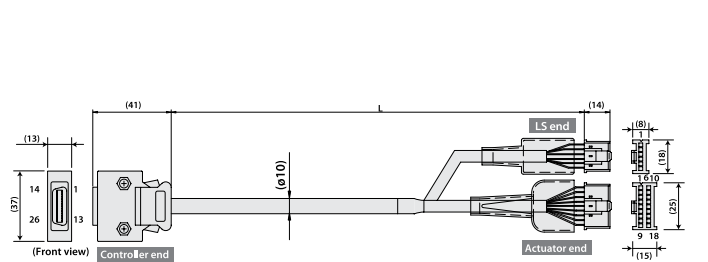

Wire	Color	Signal	No.	No.	Signal	Color	Wire
AWG26 (Soldered)	White/Orange	E2W	12	1	E2W	White/Orange	
	White/Green	GV	13	2	GV	White/Green	
	Brown/Blue	LS	26	3	LS	Brown/Blue	
	Brown/Black	GND	25	4	CP	Brown/Black	
	Brown/Red	OT	24	5	OT	Brown/Red	
	Brown/Black	RSV	23	6	RSV	Brown/Black	
			18				
			19				
	White/Blue	As	1	1	A	White/Blue	
	White/Black	Bs	2	2	B	White/Black	
	White/Purple	Z+	5	2	Z	White/Purple	
	White/Gray	Z-	6	3			
	Orange	SBD+	7	4			
	Green	SBD-	8	5			
	Black	BAT+	14	6	FG	Ground	
	White	BAT-	15	7	SD	Orange	
	Gray	VCC	16	8	SB	White/Black	
	Black	GND	17	9	BAT+	Purple	
	Blue	BRS-	20	10	BAT-	Gray	
	Yellow	BRS+	21	11	VCC	Red	
			22	12	GND	Black	
				13	BB-	Gray	
				14	BB+	White	

I/O Flat Cable

Item **CB-DS-PIO** [ ] [ ] [ ]

\* [ ] [ ] indicates the cable length (L). A desired length up to 10 m can be specified. Example) 080 = 8 m

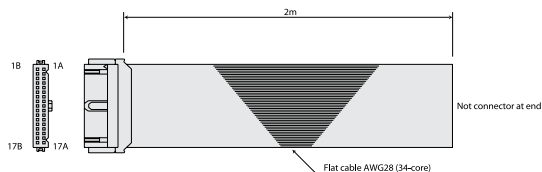

No.	Color	Wire	No.	Color	Wire
1A	Brown 1		9B	Gray 2	
1B	Red 1		10A	White 2	
2A	Orange 1		10B	Black 2	
2B	Yellow 1		11A	Brown 3	
3A	Green 1		11B	Red 3	
3B	Blue 1		12A	Orange 3	
4A	Purple 1		12B	Yellow 3	
4B	Gray 1		13A	Green 3	
5A	White 1		13B	Blue 3	
5B	Black 1		14A	Purple 3	
6A	Brown-2		14B	Gray 3	
6B	Red 2		15A	White 3	
7A	Orange 2		15B	Black 3	
8A	Green 2		16A	Brown-4	
8B	Blue 2		16B	Red 4	
9A	Purple 2		17A	Orange 4	
			17B	Yellow 4	

# ROBONET



Dedicated field network controller

The ROBONET is a new type of controller unit capable of operating ROBO Cylinders at will via a field network. Adopting the wire-saving design, compact size and DIN-rail installation feature, the ROBONET lets you save the hassle of wiring and installation considerably compared to existing controllers.

## Standard type

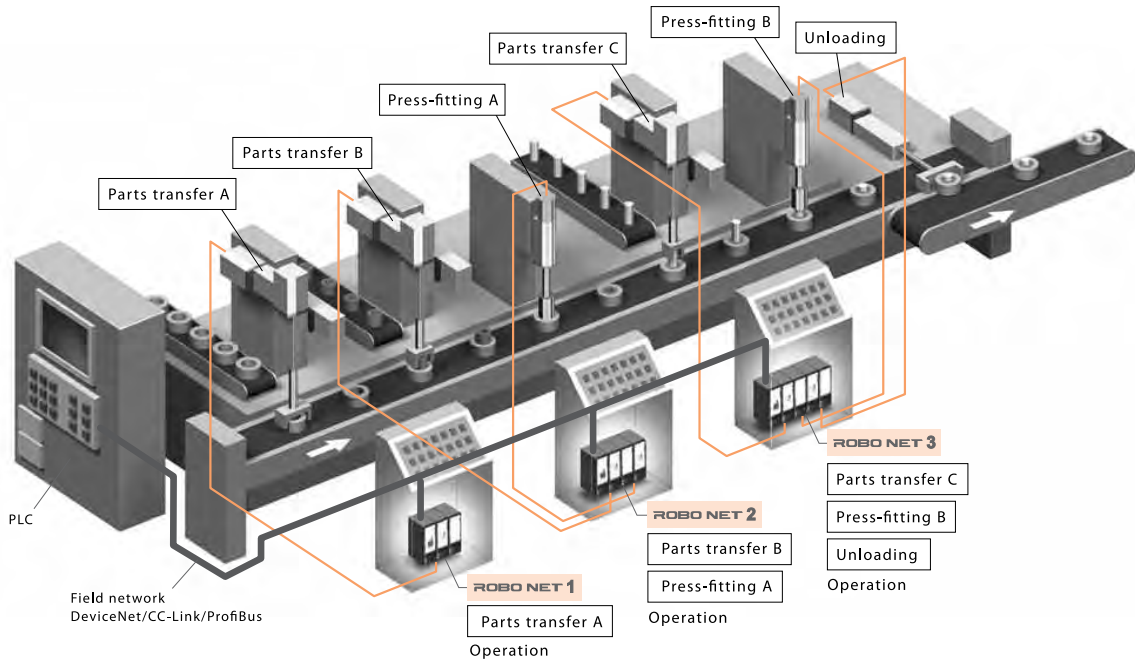

## 1 Wire-saving

Instead of connecting the I/O cables one by one to the PLC terminal, all I/Os can be connected via a field network. This means all you need to complete the wiring is to connect one dedicated cable. Also, units can be linked simply by interconnecting the unit connection boards, which significantly reduces the hassle of controller wiring.

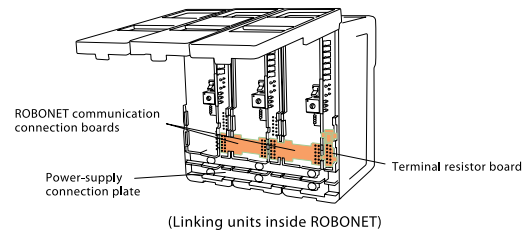
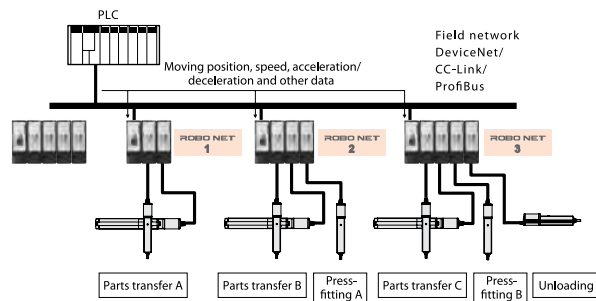

## 2 Operation by Direct Numerical Specification of Moving Position, Speed, Acceleration/Deceleration, Etc.

In addition to using the traditional method of entering moving positions and speeds under position numbers and then specifying desired position numbers eternally, you can also send moving positions (coordinates), speeds, accelerations/decelerations, etc., as numeric data to operate the actuator.

This method is effective in situations where the moving position changes for each load or you want to move the load to a desired position.

	ROBONET controller	Standard controller (ACON/PCON)
Movement by position specification	○	○
Movement by direct numerical specification	○	△
Speed/acceleration specification	○	(Not supported in the PIO mode) (Supported in the serial communication mode.)
Current value output	○	

\* The ROBONET operates via a field network, while the standard controller operates using PIOs.

## 3 Ultra-compact

Each unit adopts an ultra-compact size of just 34 mm (w) x 100 mm (h) x 73 mm (d).

Since there is no base unit and the controllers are linked using connectors, the installation space is minimized even when many units must be connected.

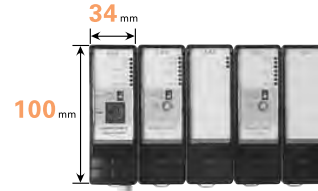

## 4 Up to 16 Controllers Can Be Operated

Up to 16 controller units can be connected to one communication unit (Gateway R unit). You can connect a desired combination of RACON units (RCA controllers) and RPCON units (RCP2 controllers).

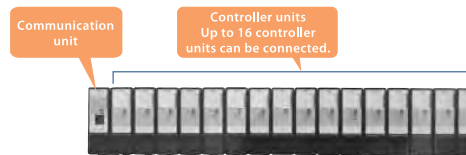

## 5 Simple Absolute Specification Not Requiring Home Return

The simple absolute R unit lets you operate incremental axes without returning the axes to their home first. If a simple absolute R unit is installed on an RACON unit (RCA controller) or RPCON unit (RCP2 controller), the actuator's encoder data will be backed up even after the power is cut off.



## 6 Installation to DIN Rail

Since the ROBONET adopts a DIN-rail installation feature, each controller can be affixed or removed with a single touch.

2-axis Combinations RCP2

2-axis Combinations RCS2

3-axis Combinations RCP2

3-axis Combinations RCS2

Controllers

Model List

PSEL

SSEL

ROBONET

XSEL

## System Configuration

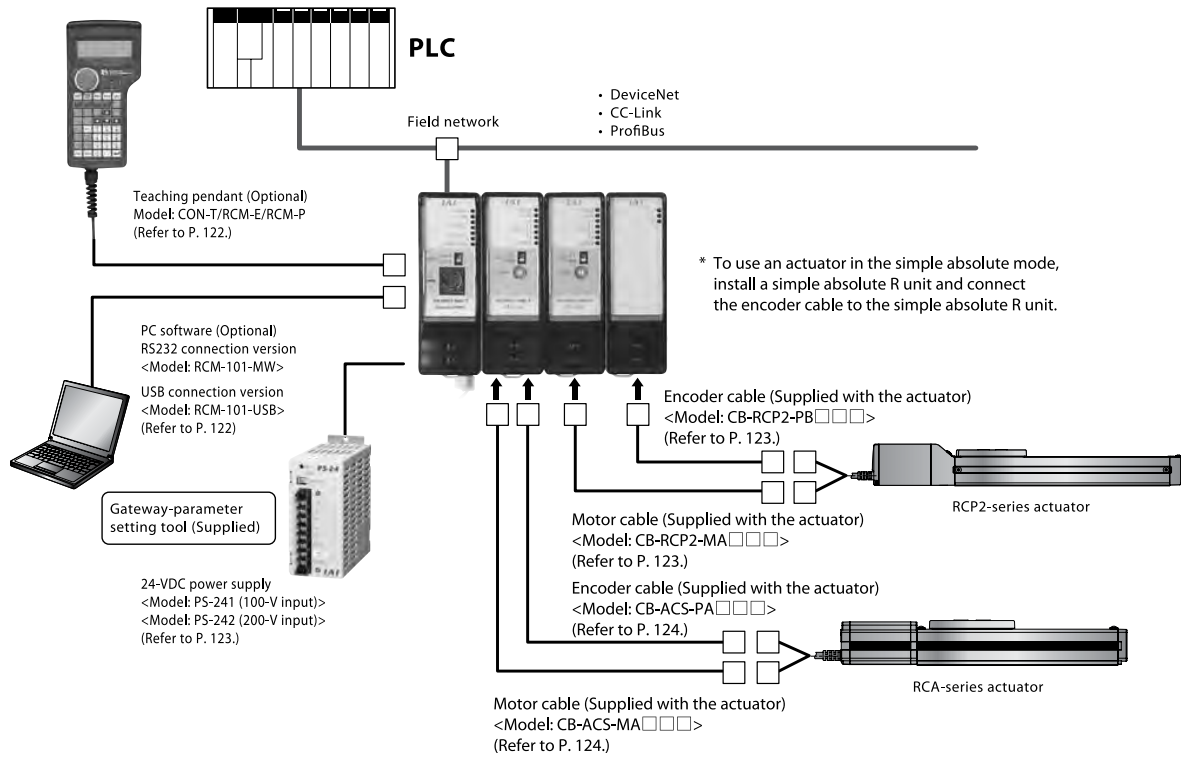

## ROBONET Expansion unit

The ROBONET expansion unit (optional) lets you fold the unit link using a cable when many ROBONET units have been connected and the system has become too wide. You can also connect an SCON or other standalone controller to the network via the ROBONET.

### [ROBONET expansion set A]

#### (Unit-folding set)

Model: REXT-SIO

(Items included in the set)

ROBONET expansion unit (model: REXT) x 2

Unit link cable x 1

Model: CB-REXT-SIO010

### [ROBONET expansion set B]

#### (Controller connection set)

Model: REXT-CTL

(Items included in the set)

ROBONET expansion unit (model: REXT) x 1

Controller connection cable x 1

Model: CB-REXT-CTL010

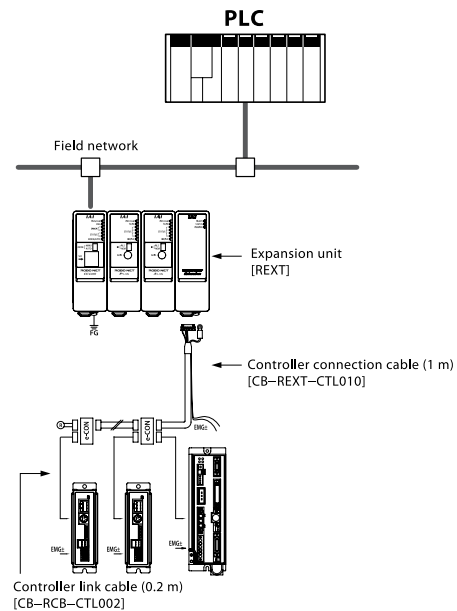
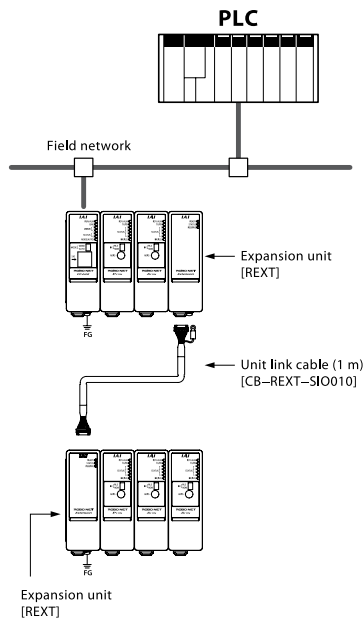

# 115

ROBONET

**Component Units**

You can order the necessary ROBONET components individually and combine them at your will.

If a need arises to add an actuator later, you can extend the system simply by adding an RACON/RPCON unit.



Gateway unit    RACON unit    RPCON unit    Simple absolute R unit    Expansion unit

Unit name	Description	Reference page
Gateway unit	A unit for making connection to a field network. One of four types (DeviceNet, CC-Link, Profibus and SIO) can be selected. * This unit is required in every ROBONET configuration.	P118 P119
RACON unit	A controller unit for operating an RCA actuator. (One RACON is required for one actuator axis.) Although the standard specification is incremental, you can also combine a simple absolute R unit to use the RACON unit as a simple absolute controller.	P120
RPCON unit	A controller unit for operating an RCP2 actuator. (One RPCON is required for one actuator axis.) Although the standard specification is incremental, you can also combine a simple absolute R unit to use the RPCON unit as a simple absolute controller.	P120
Simple absolute R unit	A backup battery unit for retaining the encoder data of the actuator after the power is cut off.	P121
Expansion unit	A unit for enabling operation via a network by folding the ROBONET link or connecting a standalone controller (SCON/PCON-CF) to the ROBONET.	P121

**How to Order/Notes**

You can individually order the necessary units comprising your ROBONET system. The delivered units are assembled by the customer. This feature lets you add units to the system or change existing units at will.

<Example of order> The following two axes are operated via CC-Link. The models specified below assume that the system is intended as an absolute system.

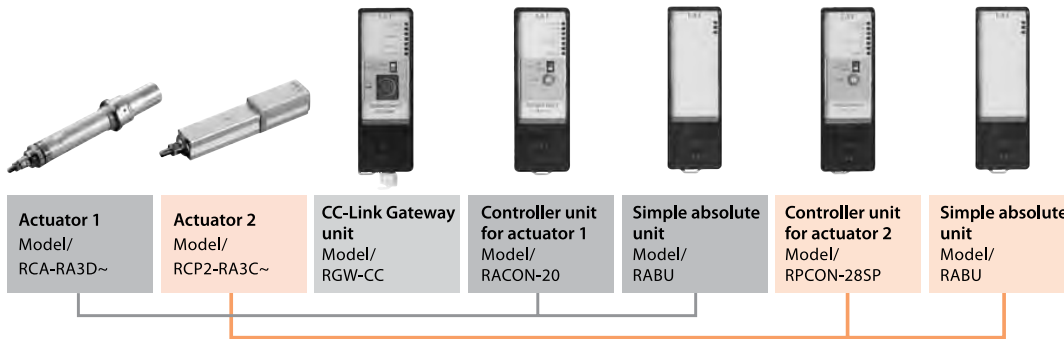

- **Operation Manual**    The operation manual that comes with each ROBONET product is provided in a CD-ROM, not on paper (as a paper manual). If you wish to have a paper operation manual, please specify so in your order. (Both the CD-ROM and paper manuals are free.)  
You can also download the operation manual from our website.
- **Gateway-parameter Setting Tool**    To connect the ROBONET to a field network, you need the gateway-parameter setting tool to set up the network. This tool can be obtained free of charge through the following methods:  
(1) Download the tool from IAI's website.  
(2) Purchase each PC software, and the tool will come with the PC software (included in the CD).  
To use the gateway-parameter setting tool, you need a cable to connect the PC and controller (PC software cable (model: CB-RCA-SIO050+RCB-CV-MW)). If you don't have any PC software, purchase this cable separately.
- **PC Software, Teaching Pendant**    To input position data, etc., to a ROBONET controller unit (RACON/RPCON), you need the PC software or teaching pendant.  
The ROBONET supports the PC software (model: RCM-101-MW/USB) of Version 6.04 or later. As for teaching pendants, the ROBONET supports the RCM-T of Version 2.06 or later and RCM-E/RCM-P of Version 2.08 or later.  
The ROBONET can be used with any version of the CON-T.  
If the version of your current PC software or teaching pendant is old, contact your IAI representative.

2-axis Combinations RCP2  
2-axis Combinations RCS2  
3-axis Combinations RCP2  
3-axis Combinations RCS2  
Controllers  
Model List  
PSEL  
SSEL  
ROBONET  
XSEL

**Explanation of Operation Modes**

The ROBONET operates by receiving instructions from a PLC via a field network.

The ROBONET can be operated in any of the three modes specified below. Use a desired mode according to how your system should be operated and controlled.

	Name	Description
1	<b>Positioner mode</b>	In this mode, the actuator is operated by specifying position numbers. The position data, speed, acceleration/ deceleration, etc., are input to the position table beforehand. Up to 768 positions can be registered.
2	<b>Simple direct mode</b>	In this mode, only the position data is specified directly by a value, and the remaining items such as speed, acceleration/deceleration, positioning band and current-limiting value during push-motion operation are specified by a position number. Up to 768 positions can be registered.
3	<b>Direct numerical specification mode</b>	In this mode, the actuator is operated by specifying the position data, speed, acceleration/deceleration, positioning band and current-limiting value during push-motion operation directly by values. Since positions are specified numerically, there is no limit to the number of positioning points that can be registered.

**List of Functions by Operation Mode**

	Positioner mode	Simple direct mode	Direct numerical specification mode
Number of registerable positions	768	768	—
Movement by position number specification	○	×	×
Direct specification of position data	×	○	○
Direct specification of speed and acceleration/deceleration	×	×	○
Direct specification of positioning band	×	×	○
Push-motion operation	○	○	○
Monitoring of completed position number	○	○	×
Monitoring of zone output	○	○	○
Monitoring of position zone output	○	○	×
Teaching function	○	×	×
Jogging operation	○	○	○
Inching operation	○	○	○
Monitoring of various status signals (*)	○	○	○
Monitoring of current position (*)	○	○	○
Monitoring of alarm codes (*)	○	○	○
Monitoring of speed/current (*)	×	×	○
Maximum specifiable value of position data	9999.99mm	9999.99mm	9999.99mm
Number of connectable axes	16	16	8

\* The various status signals, current position, alarm codes and speed/current can be monitored by accessing each address of the Gateway R unit from the PLC.

Explanation of Component Units (Gateway R Unit)

Gateway R Unit of DeviceNet Specification



This communication unit is used to operate the ROBONET via DeviceNet.  
Model **RGW-DV**

Specification

Item	Specification	Item	Specification		
Power supply	DC24V ±10%	DeviceNet specifications	Communication cable length (*)		
Current consumption	Max. 600 mA			Baud rate	Maximum network length
DeviceNet specifications	Communication protocol			500kbps	Maximum branch length
	Communication specification			Certified DeviceNet 2.0 interface module	100m
		Group 2 only server	250kbps	250m	39m
	Insulation node of network-power operation type	125kbps	500m	78m	
	Bit strobe	Note) When a thick DeviceNet cable is used.			
	Master-slave connection	Number of occupied nodes	1 node		
	Polling	Surrounding air temperature	0~40°C		
	Cyclic	Surrounding humidity	95% RH or below (non-condensing)		
Baud rate	500k/250k/125kbps (switchable using dedicated software)	Operating ambience	Free from corrosive gases, flammable gas, oil mist or powder dust.		
		Protection degree	IP20		
		Weight	140g		
		Accessories	Terminal resistor board (model:TN-1) Network connector/emergency stop connector		

\*1 If T-branching communication is to be used, refer to the operation manuals of the master unit and PLC installed in the master unit.

Network Connector

Gateway connector:  
MSTBA2.5/5-G-5.08 ABGY AU  
(by Phoenix Contact)

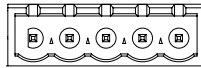

Cable-end connector  
MSTB2.5/5-ST-5.08 ABGY AU  
(by Phoenix Contact)  
= Standard accessory

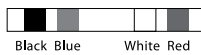

Pin color	Explanation
Black	Power-supply cable -
Blue	Communication data low
-	Shield
White	Communication data high
Red	Power-supply cable +

Applicable Wire for Cable-end Connector

Item	Description
Applicable wire size	Stranded wires: AWG24-12(0.2~2.5mm <sup>2</sup> )
Stripped length	7mm

Gateway R Unit of CC-Link Specification



This communication unit is used to operate the ROBONET via CC-Link.  
Model **RGW-CC**

Specification

Item	Specification	Item	Specification					
Power supply	DC24V ±10%	CC-Link specifications	Error control method					
Current consumption	Max. 600 mA		Number of occupied stations					
CC-Link specifications	Communication protocol	Communication cable length (*)	Remote device station					
	Communication specification		x1: 4 stations	x4: 2 stations	x8: 2 stations			
	Communication method		Baud rate (bps)	10M	5M	2.5M	625k	156k
	Synchronization method	10M/5M/2.5M/625k/156kbps (switchable using dedicated software)	Communication cable	Total cable length (m)				
	Encoding method	Broadcast polling method		100	160	400	900	1200
	Transmission path format	Frame synchronization method	Environment conditions	Dedicated CC-Link cable				
	Transmission format	NRZI		Surrounding air temperature	0~40°C			
	Bus format (conforming to EIA RS485)	Surrounding humidity		95% RH or below (non-condensing)				
	Conforming to HDLC	Operating ambience	Free from corrosive gases, flammable gas, oil mist or powder dust.					
		Protection degree	IP20					
		Weight	140g					
		Accessories	Terminal resistor board (model:TN-1) Network connector/emergency stop connector Terminal resistor cable (110Ω/130Ω)					

\*1 Certified  
\*2 If T-branching communication is to be used, refer to the operation manuals of the master unit and PLC installed in the master unit.

Network Connector

Gateway connector:  
MSTBA2.5/5-G-5.08AU  
(by Phoenix Contact)

Cable-end connector  
MSTB2.5/5-ST-5.08 ABGY AU  
(by Phoenix Contact)  
= Standard accessory

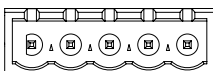

DA DB DG SLD FG

Signal name	Explanation
DA	Communication line A
DB	Communication line B
CG	Ground
SLD	Connect the shield or cable shield. The SLD signal is connected to "FG" and the enclosure.
FG	Frame ground. The FG signal is connected to "SLD" and the enclosure.

Applicable Wire for Cable-end Connector

Item	Description
Applicable wire size	Stranded wires: AWG24-12(0.2~2.5mm <sup>2</sup> )
Stripped length	7mm

### Gateway R Unit of ProfiBus Specification



This communication unit is used to operate the ROBONET via ProfiBus.  
 Model **RGW-PR**

**Specification**

Item	Specification	Item	Specification		
Power supply	DC24V ±10%	Environment conditions	Surrounding air temperature	0~40°C	
Current consumption	Max. 600 mA		Surrounding humidity	95% RH or below (non-condensing)	
ProfiBus specifications	Communication protocol	DP slave	Operating ambience	Free from corrosive gases, flammable gas, oil mist or powder dust.	
	Baud rate	9.6kbps~12Mbps	Protection degree	IP20	
		9.6kbps	1500m	Weight	140g
	Communication cable length	500kbps	400m	Accessories	Terminal resistor board (model:TN-1) Network connector/emergency stop connector
		1.5Mbps	200m		
3Mbps		200m			
	12Mbps	100m			

**Network Connector**

Gateway connector:  
 D-sub, 9-pin connector,  
 socket end

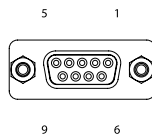

Pin No.	Signal name	Explanation	Pin No.	Signal name	Explanation
3	B-Line	Communication line B (RS485)	6	+5V	+5-V output (insulated)
4	RTS	Request to send	8	A-Line	Communication line A (RS485)
5	GND	Signal ground (insulated)	Housing	Shield	Cable shield. Connected to the enclosure.

\* The mating connector (D-sub, 9-pin connector) is not supplied.  
 \* Pins 1, 2, 7 and 9 are not connected.

### Gateway R Unit of SIO Specification



This communication unit is used to operate the ROBONET in serial communication from an XSEL controller (\*1) or Modbus communication unit.

Model **RGW-SIO**

**Specification**

Item	Specification	Item	Specification		
SIO specifications	Power supply	DC24V ±10%	Environment conditions	Surrounding air temperature	0~40°C
	Current consumption	Max. 600 mA		Surrounding humidity	95% RH or below (non-condensing)
	Communication format	Conforming to RS485 (Modbus protocol), 1:1 communication connection	Operating ambience	Free from corrosive gases, flammable gas, oil mist or powder dust.	
	Communication method	Asynchronous, half-duplex	Protection degree	IP20	
	Baud rate	Max. 230.4 kbps	Weight	140g	
	Cable length	100 m or less	Accessories	Terminal resistor board (model:TN-1) Network connector/emergency stop connector	
	Recommended cable	Twisted paired cable (shielded) x 2			

**Network Connector**

Gateway connector:  
 MC1.5/4-G-3.5  
 (by Phoenix Contact)

Cable-end connector  
 MC1.5/4-ST-3.5  
 (by Phoenix Contact)  
 = Standard accessory

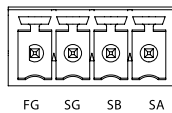

Signal name	Explanation
SA	Communication line A (+) Conforming to RS485 With a built-in terminal resistor (220Ω)
SB	Communication line A (-)
SG	Signal ground
FG	Frame ground. Connected to the enclosure.

**Applicable Wire for Cable-end Connector**

Item	Description
Applicable wire size	Stranded wires: AWG28-16 (0.14~1.5mm <sup>2</sup> )
Stripped length	7mm



**RACON Unit: RCA-series Controller**



This controller unit is used to operate an RCA actuator in a ROBONET system.

Model **RACON-[1]-[2]**

\* Specify the motor wattage in [1] in the model name. (Refer to the table below.)  
In [2], specify "ABU" only if you are using the simple absolute unit. (If the simple absolute unit is not used, leave this space blank.)

Model	Applicable actuators
RACON-20-[2]	RCA-SA4□ / SS4□ / SA5□ / SS5□ / RA4□-20 / RG□4□-20/ A4R / A5R RCACR-SA4C / SA5□ RCAW-RA4□-20
RACON-20S-[2]	RCA-RA3□ / RG□3 RCAW-RA3□
RACON-30-[2]	RCA-SA6□ / SS6□ / RA4□-30 / RG□4□-30 / A6R RCACR-SA6□ RCAW-RA4□-30

**Specification**

Item	Specification	Item	Specification		
General specifications	Power supply	DC24V ±10%	Environment conditions	Surrounding air temperature	0~50°C
	Power-supply capacity	Max. 5.1 A (The specific capacity varies depending on the actuator.)		Surrounding humidity	95% RH or below (non-condensing)
	Operated actuator	RCA series		Operating ambience	Free from corrosive gases, flammable gas, oil mist or powder dust.
	Number of positioning points	768	Weight	Protection degree	IP20
	Backup memory	EEPROM		Accessories	
	Position detection method	Incremental encoder			ROBONET communication connection board (model JB-1), power-supply connection plate (model PP-1)
	Forced release of electromagnetic brake	Brake release switch			
	Motor cable	Model CB-ACS-MA□□□□			
	Encoder cable	Model CB-ACS-PA□□□□			

**RPCON Unit: RCP2-series Controller**



This controller unit is used to operate an RCP2 actuator in a ROBONET system.

Model **RACON-[1]-[2]**

\* Specify the motor type in [1] in the model name. (Refer to the table below.)  
In [2], specify "ABU" only if you are using the simple absolute unit. (If the simple absolute unit is not used, leave this space blank.)

\* The simple absolute unit cannot be used with the RCP2-RA2C, GRS, RTB and RTC.

Model	Applicable actuators
RPCON-20P	RCP2-RA2C / GRS
RPCON-28P-[2]	RCP2-GRM / GR3LS / GR3SS / RTB / RTC
RPCON-28SP-[2]	RCP2-RA3C / RGD3C
RPCON-42P-[2]	RCP2-SA5□ / SA6□ / SS7□ / BA6□ / BA7□ / RA4C / RG□4C / GR3LM / GR3SM RCP2CR-SA5C / SA6C / SS7C RCP2W-RA4C
RPCON-56P-[2]	RCP2-SA7□ / SS8□ / RA6C / RG□6C / RCP2CR-SA7C / SS8C RCP2W-RA6C

\* RCP2 actuators of old types are also supported. (Contact IAI for details.)

**Specification**

Item	Specification	Item	Specification		
General specifications	Power supply	DC24V ±10%	Environment conditions	Surrounding air temperature	0~50°C
	Power-supply capacity	Max. 2 A		Surrounding humidity	95% RH or below (non-condensing)
	Operated actuator	RCP2 series		Operating ambience	Free from corrosive gases, flammable gas, oil mist or powder dust.
	Number of positioning points	768	Weight	Protection degree	IP20
	Backup memory	EEPROM		Accessories	
	Position detection method	Incremental encoder			ROBONET communication connection board (model JB-1), power-supply connection plate (model PP-1)
	Forced release of electromagnetic brake	Brake release switch			
	Motor cable	Model CB-RCP2-MA□□□□			
	Encoder cable	Model CB-RCP2-PB□□□□			

2-axis Combinations RCP2

2-axis Combinations RCS2

3-axis Combinations RCP2

3-axis Combinations RCS2

Controllers

Model List

PSEL

SSEL

ROBONET

XSEL

**Explanation of Component Units (Simple Absolute R Unit/Expansion Unit)**

**Simple absolute R unit**



When this data-backup battery unit is connected to an RACON or RPCON (\*1), an incremental actuator can be used as an absolute actuator.

\*1 One simple absolute R unit is required for one RACON or RPCON unit.

Model **RABU** (RACON/RPCON)

\* To order a simple absolute R unit together with a controller unit (RACON/RPCON), specify “-ABU” at the end of the model code of the controller to which the simple absolute R unit will be installed.

**Specification**

Item	Specification				Item	Specification		
General specifications	Power supply	DC24V ±10%				Environment conditions	Surrounding air temperature	0~40°C
	Current consumption	Max. 300 mA					Surrounding humidity	95% RH or below (non-condensing)
	Applicable battery	Ni-MH battery, nickel hydrogen battery					Operating ambience	Free from corrosive gases, flammable gas, oil mist or powder dust.
	Charge time	Approx. 78 hours					Protection degree	IP20
	Battery life	3 years				Weight	330g	
	Maximum rotation speed at which absolute data can be backed up (rpm)	800	400	200	100	Accessories	ROBONET communication connection board (model: JB-1), Simple absolute connection board (model: JB-1), power-supply connection plate (model: PP-1)	
		Absolute-data backup time (h)	120	240	360			480

**Example of order**



In certain situations, such as when many controllers have been linked to the ROBONET and the system has become too wide to fit the control panel, this unit can be used to fold the controller link by connecting a cable in the middle of the link.

You can also install the expansion unit at the end of the ROBONET link and use an external controller cable to operate an SCON or other standalone controller on the network just like the controller units linked to the ROBONET.

Model **REXT** (RPCON/RACON)

**Specification**

Item	Specification	
General specifications	Power supply	DC24V ±10%
	Current consumption	Max. 100 mA
Environment conditions	Surrounding air temperature	0~40°C
	Surrounding humidity	95% RH or below (non-condensing)
	Operating ambience	Free from corrosive gases, flammable gas, oil mist or powder dust.
	Protection degree	IP20
Weight	140g	
Accessories	ROBONET communication connection board (model: JB-1), power-supply connection plate (model: PP-1)	

(Note) The cable used when the ROBONET link is folded is different from the one used to connect a standalone controller. For details, refer to the system configuration (ROBONET expansion unit) on P. 117.

2-axis Combinations RCP2

2-axis Combinations RCS2

3-axis Combinations RCP2

3-axis Combinations RCS2

Controllers

Model List

PSEL

SSEL

ROBONET

XSEL

**External Dimensions**

The Gateway R unit, RACON unit, RPCON unit and simple absolute R unit all have the same external dimensions.

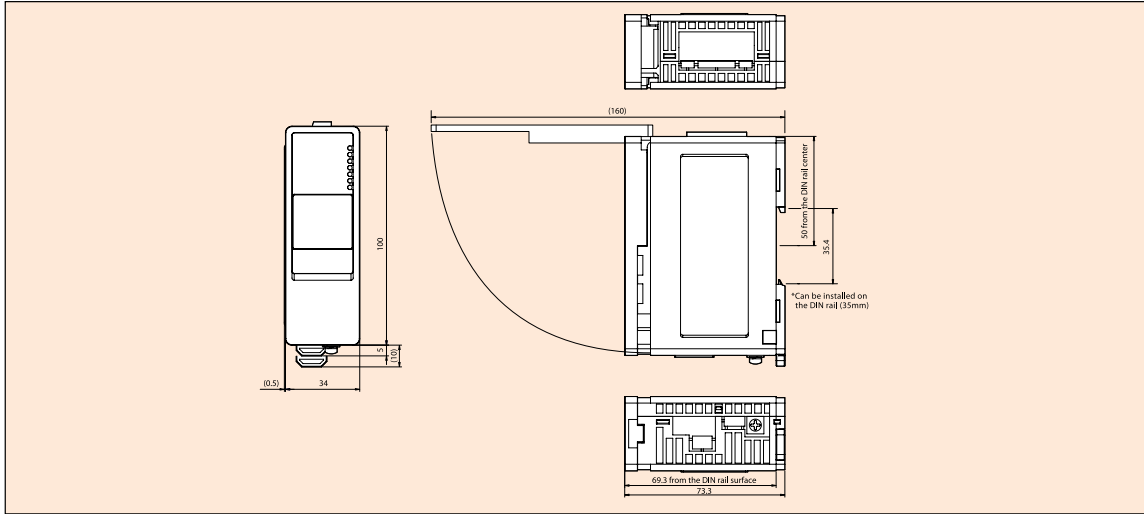

**Options**



ROBONET communication connection board (simple absolute connection board)  
Model JB-1



Terminal resistor board  
Model TN-1



Power-supply connection plate  
Model PP-1

2-axis Combinations RCP 2

2-axis Combinations RCS 2

3-axis Combinations RCP 2

3-axis Combinations RCS 2

**Controllers**

Model List

PSEL

SSEL

**ROBONET**

XSEL

2-axis  
Combinations  
RCP2

2-axis  
Combinations  
RCS2

3-axis  
Combinations  
RCP2

3-axis  
Combinations  
RCS2

## Options

### 24-VDC Power Supply

#### Features

This 24-V power supply for ROBO Cylinder has the rated maximum instantaneous output of 17 A. Since multiple PS units can be operated in parallel, you can add up to five PS units to your system if one PS does not provide enough capacity.

#### Model

**PS-241**  
(100-V input specification)  
**PS-242**  
(200-V input specification)

#### Relationship of actuator and power-supply current

Controller type	Actuator type	Power-supply current (A)		Number of connectable units per PS-24	
		Rating (= Max.)	2	Servos of all axes are turned ON simultaneously*	Servos of all axes are not turned ON simultaneously*
RPCON PCON PSEL	All RCP2 models (Note)	Rating Max.	2 4.4	8	8
RACON ACON ASEL	SA4, SA5 (20W)	Rating	1.3	3	6
		Max.	4.4		
	SA6 (30W)	Rating	1.3	4	6
		Max.	4		
	RA3 (20W)	Rating	1.7	3	5
Max.		5.1			
RA4 (20W)	Rating	1.3	3	6	
	Max.	4.4			
RA4 (30W)	Rating	1.3	4	6	
	Max.	4			

\* The first servo ON action after the power is turned on.  
(Note) The HS8C, HS8R and RAIOC are excluded.



## Replacement Parts

If you must order a replacement cable, etc., after the initial purchase of your product, specify the correct model by referring to the information below.

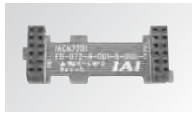

ROBONET communication connection board (simple absolute connection board)  
Model JB-1



Terminal resistor board  
Model TN-1



Power-supply connection plate  
Model PP-1

### Motor Cable for RCP2

Item **CB-RCP2-MA** □ □ □

\* The standard motor cable is a robot cable. You can select whether or not to use a robot cable.  
□ □ □ indicates the cable length (L). A desired length up to 20 m can be specified.  
Example) 080 = 8 m

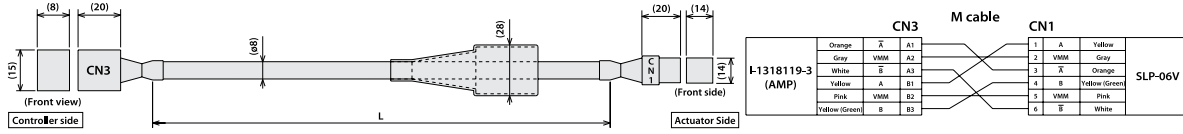

### Encoder Cable/Robot Encoder Cable for RCP2

Item **CB-RCP2-PB** □ □ □ □ / **CB-RCP2-PB** □ □ □ □ -**RB**

\* The standard encoder cable is a normal cable. A robot cable can be specified as an option.  
□ □ □ □ indicates the cable length (L). A desired length up to 20 m can be specified.  
Example) 080 = 8 m

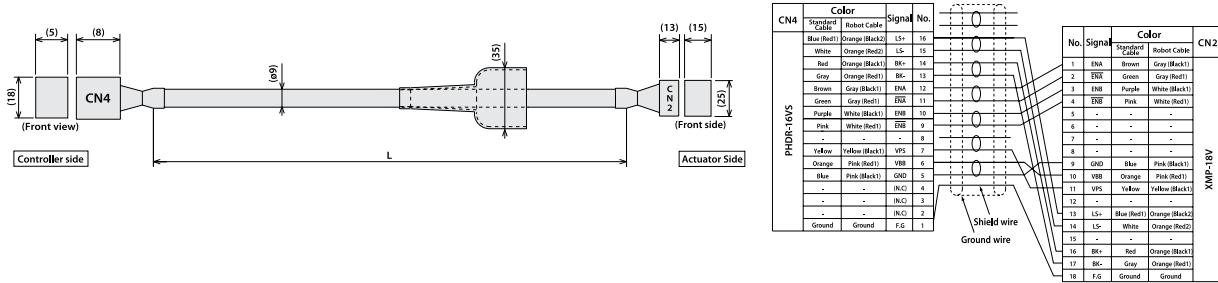

### Integrated Motor/Encoder Cable for RCP3

Item **CB-PCS-MPA** □ □ □

\* □ □ □ indicates the cable length (L). A desired length up to 10 m can be specified.  
Example) 080 = 8 m

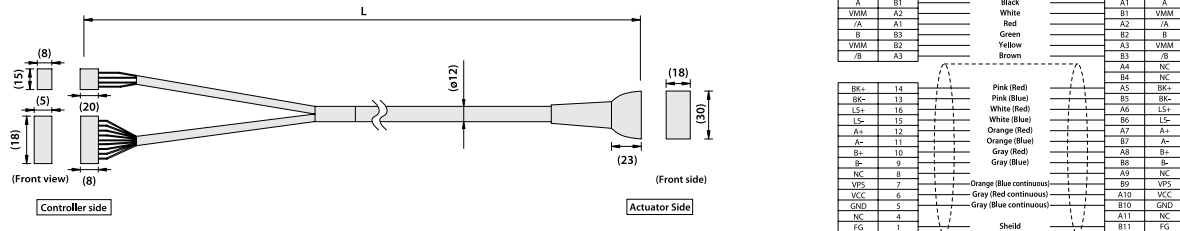

**123** ROBONET

Controllers

Model  
List

PSEL

SSEL

ROBONET

XSEL

## Replacement Parts

### Motor Cable for RCA

Item **CB-ACS-MA**

\*  indicates the cable length (L). A desired length up to 20 m can be specified.  
Example) 080 = 8 m

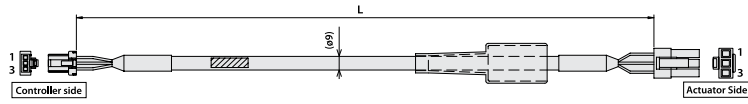

Wire	Color	Signal	No.	No.	Signal	Color	Wire
AWG22 (Press fit)	Red	U	1	1	U	Red	AWG22 (Press fit)
	White	V	2	2	V	White	
	Black	W	3	3	W	Black	

### Encoder Cable/Robot Encoder Cable for RCA

Item **CB-ACS-PA**  / **CB-ACS-PA** -**RB**

\* The standard encoder cable is a normal cable. A robot cable can be specified as an option.  
\*  indicates the cable length (L). A desired length up to 20 m can be specified.  
Example) 080 = 8 m

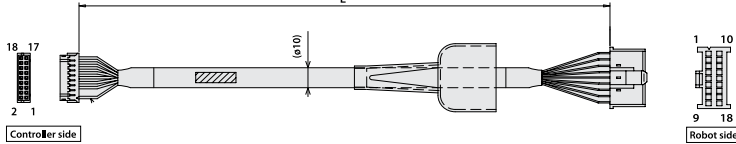

CN2				CN1			
Color	Standard Cable	Signal	No.	No.	Signal	Color	Robot Cable
Robot Cable	Standard Cable	Signal	No.	1	ENA	Gray	White/Blue
White/Purple	Blue	LS+	18	2	ENB	Red	White/Yellow
White/Gray	Orange	LS-	17	3	ENZ	Black	White/Black
Yellow	Green	BK+	16	4	ENL	Yellow	White/Black
Blue	Brown	BK-	15	5	-	-	-
White/Blue	Gray	ENA	14	6	-	-	-
White/Yellow	Red	ENB	13	7	LS+	Blue	White/Purple
White/Red	Black	ENL	12	8	-	-	-
White/Black	Yellow	ENZ	11	9	FG	Ground	Ground
Orange	Pink	ENZ	10	10	ENZ	Pink	Orange
Green	Purple	ENZ	9	11	ENZ	Purple	Green
Purple	White	-	8	12	-	-	-
Orange	Blue/White	VPS	7	13	VPS	Blue/Red	Gray
Red	Orange/White	SV	6	14	SV	Orange/White	Red
Black	Green/White	GND	5	15	GND	Green/White	Black
-	-	-	4	16	LS-	Orange	White/Gray
-	-	-	3	17	BK-	Brown	Black
-	-	-	2	18	BK+	Green	Yellow
Ground	Ground	F.G.	1				

Housing: PH06-08V  
Contact: SPHD-001FP0.5

Plug Housing: XMP-18V  
Socket Contact: BUH-0011FP0.6  
Retainer: XMS-09V

### Integrated Motor/Encoder Cable for RCA2

Item **CB-ACS-MPA**

\*  indicates the cable length (L). A desired length up to 20 m can be specified.  
Example) 080 = 8 m

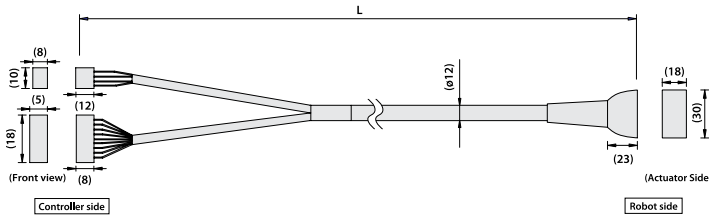

Signal	No.	(Color)	No.	Signal
U	1	Red	A1	U
V	2	Yellow	B1	V
W	3	Black	A2	W
			B2	NC
			A3	NC
			B3	NC
			A4	BK-
			B4	BK+
			A5	LS+
			B5	LS-
			A6	A+
			B6	A-
			A7	B+
			B7	B-
			A8	Z+
			B8	Z-
			A9	-
			B9	VPS
			A10	VCC
			B10	GND
			A11	NC
			B11	FG

### Unit Link Cable for Expansion Unit

Item **CB-REXT-SIO010**

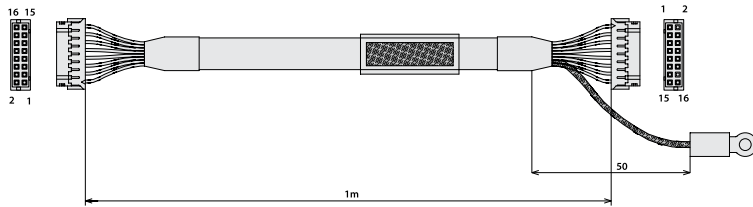

DF11-16DS-2C		Shielded group		DF11-16DS-2C	
Signal name	No.			No.	Signal name
/RSV1	16	Black2/White	Black2/White	16	/RSV1
RSV1	15	Red2/White	Red2/White	15	RSV1
/ROUT	14	Black2/Gray	Black2/Gray	14	/ROUT
ROUT	13	Red2/Gray	Red2/Gray	13	ROUT
/RSV0	12	Black2/Orange	Black2/Orange	12	/RSV0
RSV0	11	Red2/Orange	Red2/Orange	11	RSV0
/ENA	10	Black1/Pink	Black1/Pink	10	/ENA
ENA	9	Red1/Pink	Red1/Pink	9	ENA
/COM2	8	Black1/Yellow	Black1/Yellow	8	/COM2
COM2	7	Red1/Yellow	Red1/Yellow	7	COM2
/COM1	6	Black1/White	Black1/White	6	/COM1
COM1	5	Red1/White	Red1/White	5	COM1
/SD+	4	Black1/Gray	Black1/Gray	4	/SD+
SD+	3	Red1/Gray	Red1/Gray	3	SD+
/RD+	2	Black1/Orange	Black1/Orange	2	/RD+
RD+	1	Red1/Orange	Red1/Orange	1	RD+
EMG+	1	Red1/Orange	Red1/Orange	1	EMG+

Ground: RAV1.25-3  
FG

Legend of wire color: Dot color and number of dot(s)/insulator color

### Controller Connection Cable for Expansion Unit

Item **CB-REXT-CTL010**

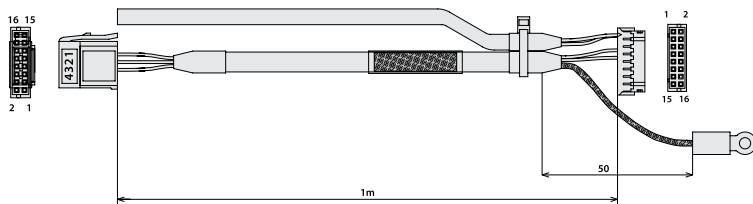

37104-3122-000FL		Shielded group		DF11-16DS-2C	
No.	Signal			No.	Signal
4	NC	White	White	9	ENA
3	GND	Gray	Gray	8	COM2
2	SD-	Orange	Orange	7	COM1
1	SD+	Orange	Orange	6	SD-
				5	SD+
				4	RD-
				3	RD+
				2	EMG-
				1	EMG+

Ground: RAV1.25-3  
FG

2-axis  
Combinations  
RCP2

2-axis  
Combinations  
RCS2

3-axis  
Combinations  
RCP2

3-axis  
Combinations  
RCS2

Controllers

Model  
List

PSEL

SSEL

ROBONET

XSEL

# X-SEL

## RCS2-series program controller



### Model List/Pricing

A multi-axis program controller capable of operating RCS2-series actuators. Up to six axes can be controlled simultaneously.

Type	J	K	P	Q
Name	Small type	General-purpose type	Large-capacity type	Large-capacity type (conforming to safety category)
Exterior view				
Description	A small, low-cost type ideal for operating low-output actuators	A standard type offering great expandability	A large-capacity type capable of operating up to six axes or 2400 W	A large-capacity type that can be configured to meet safety category 4
Maximum number of controlled axes	4		6	
Number of positions	3000		4000	
Total wattage of connectable axes	800W		2400W	
Power supply	Single-phase 100 VAC, Single-phase 200 VAC		Single-phase 200 VAC, Three-phase 200 VAC	
Safety category	B		B	Can be configured to meet category 4.
Safety standard	-		CE	CE, ANSI
Standard price	Contact IAL.			

### Model

#### [XSEL-J/K Types]

\* If you are selecting multiple options, specify them in an alphabetical order. (Example: Brake + Home sensor [] BL)

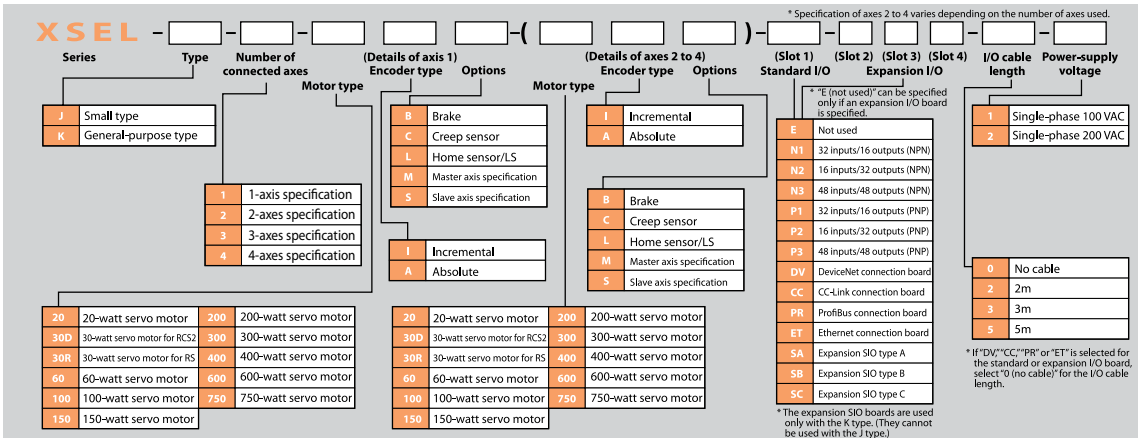

#### [XSEL-P/Q Types]

\* Specification of axes 2 to 6 varies depending on the number of axes used.

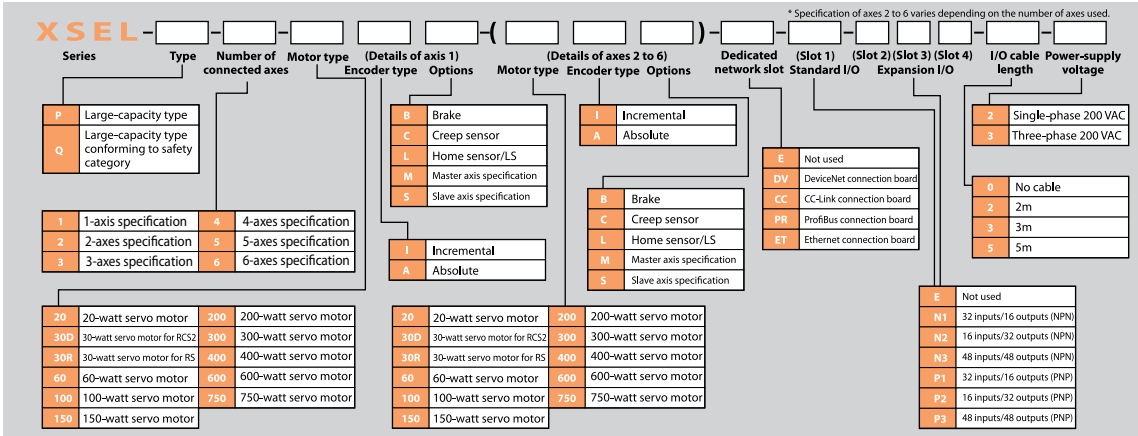

# 125

XSEL

**Regenerative resistor unit**

**J (Small Type)/K (General-purpose Type)/KE (CE Type)**

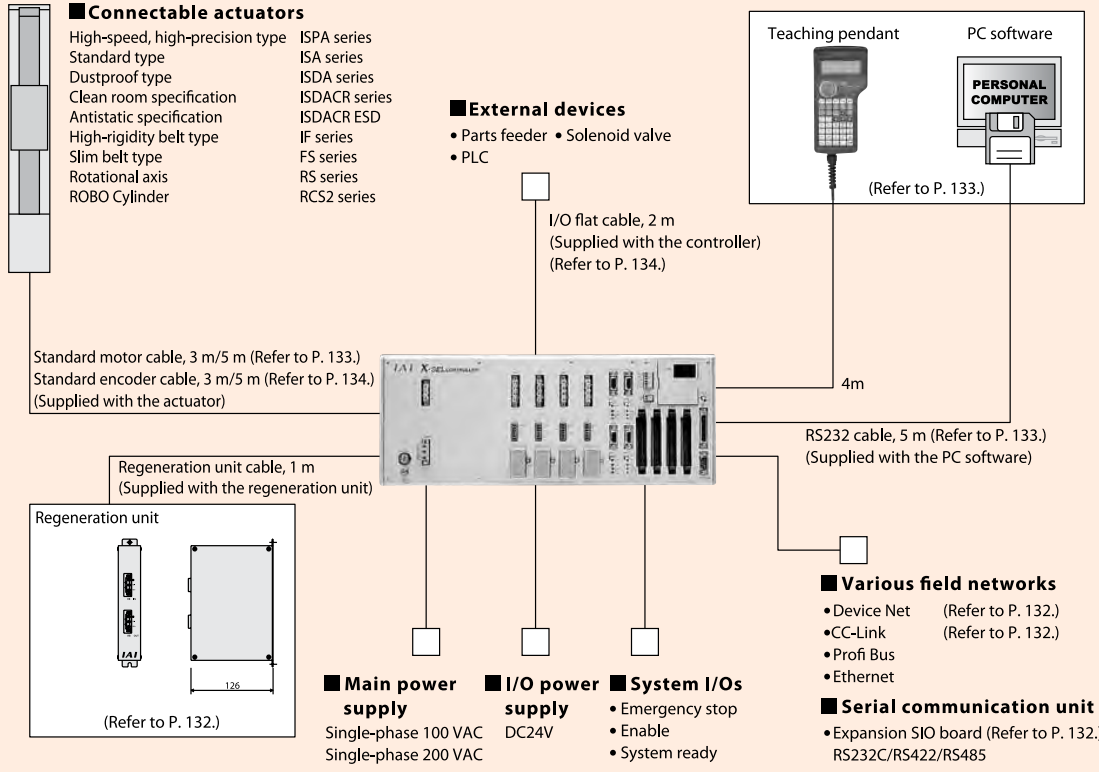

**P (Large-capacity Type)/Q (Large-capacity Global Type)**

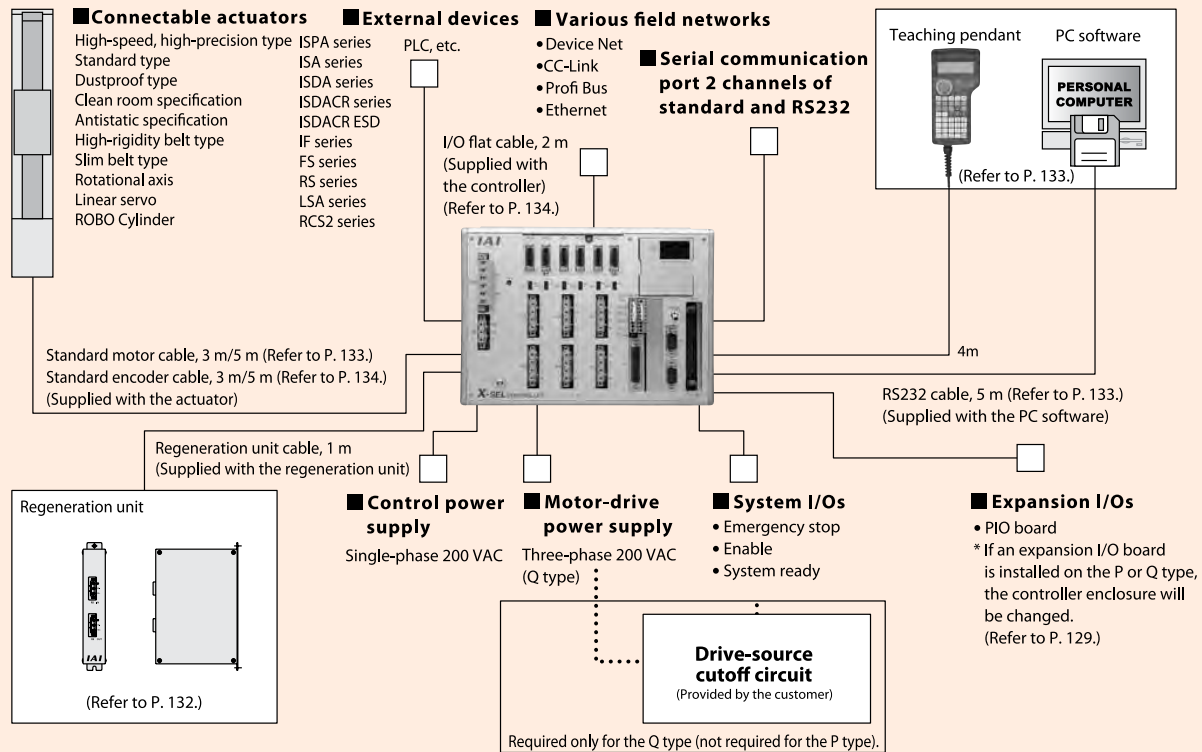

- 2-axis Combinations R C P 2
- 2-axis Combinations R C S 2
- 3-axis Combinations R C P 2
- 3-axis Combinations R C S 2
- Controllers
- Model List
- PSEL
- SSEL
- ROBONET
- XSEL

I/O Wiring

Input External input specifications (NPN specification)

Item	Specification
Input voltage	DC24V ±10%
Input current	7 mA per circuit
ON/OFF voltages	ON voltage --- Min. 16.0VDC / OFF voltage --- Max. 5.0VDC
Insulation method	Photo-coupler insulation
Externally connected devices	[1] No-voltage contacts (minimum load of approx. 5 VDC/1 mA) [2] Photoelectric/proximity sensors (NPN type) [3] Sequencer transistor outputs (open-collector type) [4] Sequencer contact outputs (minimum load of approx. 5 VDC/1 mA)

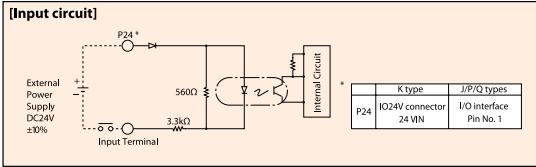

Input External input specifications (PNP specification)

Item	Specification
Input voltage	DC24V ±10%
Input current	7 mA per circuit
ON/OFF voltages	ON voltage --- Min. 8.0VDC / OFF voltage --- Max. 19.0VDC
Insulation method	Photo-coupler insulation
Externally connected devices	[1] No-voltage contacts (minimum load of approx. 5 VDC/1 mA) [2] Photoelectric/proximity sensors (PNP type) [3] Sequencer transistor outputs (open-collector type) [4] Sequencer contact outputs (minimum load of approx. 5 VDC/1 mA)

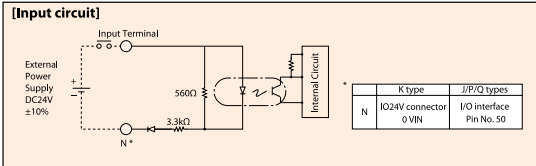

Output External output specifications (NPN specification)

Item	Specification
Load voltage	DC24V
Maximum load current	100 mA per point, 400 mA peak (total current)
Leak current (max.)	Max. 0.1 mA per point
Insulation method	Photo-coupler insulation
Externally connected devices	[1] Miniature relays [2] Sequence input units

TD62084 (or equivalent) is used.

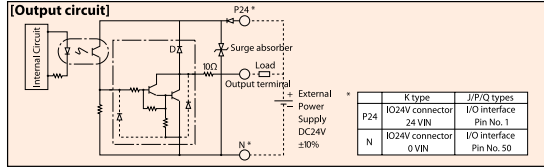

Output External output specifications (PNP specification)

Item	Specification
Load voltage	DC24V
Maximum load current	100 mA per point 400 mA per 8 ports Note)
Leak current (max.)	Max. 0.1 mA per point
Insulation method	Photo-coupler insulation
Externally connected devices	[1] Miniature relays [2] Sequence input units

TD62784 (or equivalent) is used.

Note) The maximum total load current for every eight ports from output port No. 300 is 400 mA.  
(The maximum total load current of output port Nos. 300+n to 300+n+7 is 400 mA, where n is 0 or a multiple of 8.)

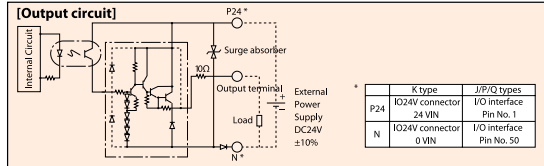

I/O Signal Tables

Standard I/O Signal Table (When N1 or P1 is selected)

Pin No.	Category	Port No.	Standard setting
1			(I/P/Q types: 24-V connection / K type: NC)
2		000	Program start
3		001	General-purpose input
4		002	General-purpose input
5		003	General-purpose input
6		004	General-purpose input
7		005	General-purpose input
8		006	General-purpose input
9		007	Program specification (PRG No. 1)
10		008	Program specification (PRG No. 2)
11		009	Program specification (PRG No. 4)
12		010	Program specification (PRG No. 8)
13		011	Program specification (PRG No. 10)
14		012	Program specification (PRG No. 20)
15		013	Program specification (PRG No. 40)
16		014	General-purpose input
17	Input	015	General-purpose input
18		016	General-purpose input
19		017	General-purpose input
20		018	General-purpose input
21		019	General-purpose input
22		020	General-purpose input
23		021	General-purpose input
24		022	General-purpose input
25		023	General-purpose input
26		024	General-purpose input
27		025	General-purpose input
28		026	General-purpose input
29		027	General-purpose input
30		028	General-purpose input
31		029	General-purpose input
32		030	General-purpose input
33		031	General-purpose input
34		300	Alarm output
35		301	Ready output
36		302	Emergency stop output
37		303	General-purpose output
38		304	General-purpose output
39		305	General-purpose output
40		306	General-purpose output
41		307	General-purpose output
42	Output	308	General-purpose output
43		309	General-purpose output
44		310	General-purpose output
45		311	General-purpose output
46		312	General-purpose output
47		313	General-purpose output
48		314	General-purpose output
49		315	General-purpose output
50		—	(I/P/Q types: 0-V connection / K type: NC)

Expansion I/O Signal Table (When N1 or P1 is selected)

Pin No.	Category	Standard setting
1		(I/P/Q types: 24-V connection / K type: NC)
2		General-purpose input
3		General-purpose input
4		General-purpose input
5		General-purpose input
6		General-purpose input
7		General-purpose input
8		General-purpose input
9		General-purpose input
10		General-purpose input
11		General-purpose input
12		General-purpose input
13		General-purpose input
14		General-purpose input
15		General-purpose input
16		General-purpose input
17	Input	General-purpose input
18		General-purpose input
19		General-purpose input
20		General-purpose input
21		General-purpose input
22		General-purpose input
23		General-purpose input
24		General-purpose input
25		General-purpose input
26		General-purpose input
27		General-purpose input
28		General-purpose input
29		General-purpose input
30		General-purpose input
31		General-purpose input
32		General-purpose input
33		General-purpose input
34		General-purpose output
35		General-purpose output
36		General-purpose output
37		General-purpose output
38		General-purpose output
39		General-purpose output
40		General-purpose output
41		General-purpose output
42	Output	General-purpose output
43		General-purpose output
44		General-purpose output
45		General-purpose output
46		General-purpose output
47		General-purpose output
48		General-purpose output
49		General-purpose output
50		(I/P/Q types: 0-V connection / K type: NC)

Expansion I/O Signal Table (When N2 or P2 is selected)

Pin No.	Category	Standard setting
1		(I/P/Q types: 24-V connection / K type: NC)
2		General-purpose input
3		General-purpose input
4		General-purpose input
5		General-purpose input
6		General-purpose input
7		General-purpose input
8		General-purpose input
9	Input	General-purpose input
10		General-purpose input
11		General-purpose input
12		General-purpose input
13		General-purpose input
14		General-purpose input
15		General-purpose input
16		General-purpose input
17		General-purpose input
18		General-purpose output
19		General-purpose output
20		General-purpose output
21		General-purpose output
22		General-purpose output
23		General-purpose output
24		General-purpose output
25		General-purpose output
26		General-purpose output
27		General-purpose output
28		General-purpose output
29		General-purpose output
30		General-purpose output
31		General-purpose output
32		General-purpose output
33		General-purpose output
34	Output	General-purpose output
35		General-purpose output
36		General-purpose output
37		General-purpose output
38		General-purpose output
39		General-purpose output
40		General-purpose output
41		General-purpose output
42		General-purpose output
43		General-purpose output
44		General-purpose output
45		General-purpose output
46		General-purpose output
47		General-purpose output
48		General-purpose output
49		General-purpose output
50		(I/P/Q types: 0-V connection / K type: NC)



**Specification Table**

**J (Small Type)/K (General-purpose Type)**

Item	Description											
Controller series/type	J (small type)						K (general-purpose type)/KE (CE type)					
Connected actuators	RCS2/ISA/ISPA/ISP/ISDA/ISDADR/ISPDACR/IF/FS/RS											
Applicable motor output (W)	20/30/60/100/150/200/300/400/600/750											
Number of connected axes	1	2	3	4	1	2	3	4				
Maximum output of connected axes (W)	Max 800 (at power-supply voltage of 200 V) Max 400 (at power-supply voltage of 100 V)				Max 800		Max 1600 (at power-supply voltage of 200 V) Max 800 (at power-supply voltage of 200 V)					
Input power supply	100-V specification: Single-phase 100 to 115 VAC 200-V specification: Single-phase 200 to 230 VAC											
Operating power-supply voltage range	±10%											
Power-supply frequency	50Hz/60Hz											
Power-supply capacity	Max 1670VA		Max 1720VA		Max 1810VA		Max 1670VA		Max 3120VA		Max 3310VA	
Position detection method	Incremental encoder (wire-saving type) Multi-rotation data backup absolute encoder (wire-saving type)											
Speed setting	1 mm/sec ~ (The maximum limit varies depending on the actuator.)											
Acceleration setting	0.01 G ~ (The maximum limit varies depending on the actuator.)											
Program language	Super SEL											
Number of programs	64											
Number of program steps	6,000 (total)											
Number of multi-tasking programs	16											
Number of positions	3,000											
Data storage device	Flash ROM + SRAM backup battery											
Data input method	Teaching pendant or PC software											
Standard I/Os	32 points (total of dedicated inputs + general-purpose inputs)/16 points (total of dedicated outputs + general-purpose outputs)											
Expansion I/Os	None			1 unit, 48 points (1 unit can be added)			1 unit, 48 points (Up to 3 units can be added)					
Serial communication function	Standard RS232 port (D-sub, 25-pin)						Standard RS232 port + Expansion SIO board (optional)					
Other I/Os	System I/Os (emergency stop input, enable input, system ready output)											
Protective functions	Motor overcurrent, overload, motor/driver temperature check, overload check, encoder open detection, soft limit overtravel, system error, battery error, etc.											
Surrounding air temperature/humidity	Temperature 0 to 40°C, humidity 30 to 85%											
Surrounding ambience	Free from corrosive gases or significant dust.											
Weight	2.6kg		3.3kg		5.0kg		6.0kg		7.0kg			
Accessory	I/O flat cable											

**P (Large-capacity Type)/Q (Large-capacity Type Conforming to Safety Category)**

Item	Description												
Controller series/type	P (standard) type						Q (global) type						
Connected actuators	RCS2/ISA/ISPA/ISP/ISDA/ISDADR/ISPDACR/IF/FS/RS/LSA												
Applicable motor output	20/30/60/100/150/200/300/400/600/750												
Number of controlled axes	1	2	3	4	5	6	1	2	3	4	5	6	
Maximum output of connected axes (W)	Max2400W (1600 W for single-phase 200-VAC specification)												
Control power input	AC 200/230, single-phase -15%, +10%						AC 200/230, single-phase -15%, +10%						
Motor power input	AC 200/230, single-phase/three-phase -10%, +10%						AC 200/230, single-phase/three-phase -10%, +10%						
Power-supply frequency	50/60Hz												
Insulation resistance	10MΩ or more (at 500 VDC, between the power-supply terminal and each I/O terminal and between all external terminals and the case)												
Withstand voltage	1500 VAC (1 minute)						1500 VAC (1 minute)						
Power-supply capacity (*1)	Max 1744VA	Max 3266VA	Max 4787VA	Max 4878VA	Max 4931VA	Max 4998VA	Max 1744VA	Max 3266VA	Max 4787VA	Max 4878VA	Max 4931VA	Max 4998VA	
Position detection method	Incremental encoder (wire-saving type) Multi-rotation data backup absolute encoder (wire-saving type)												
Safety circuit configuration	Redundancy not supported						Redundancy supported						
Drive-source cutoff method	Internal cutoff relay						External safety circuit						
Enable input	Contact B input (power supplied internally)						Contact B input (power supplied externally, redundant)						
Speed setting	1 mm/sec ~ (The maximum limit varies depending on the actuator.)												
Acceleration setting	0.01 G ~ (The maximum limit varies depending on the actuator.)												
Program language	Super SEL												
Number of programs	64												
Number of program steps	6,000 (total)												
Number of multi-tasking programs	16												
Number of positions	4,000 (total)												
Data storage device	Flash ROM + SRAM backup battery												
Data input method	Teaching pendant or PC												
Standard I/Os	1 of PIO board with 48 I/O points (NPN/PNP) or PIO board with 96 I/O points (NPN/PNP) can be installed.												
Expansion I/Os	Up to 3 of PIO board with 48 I/O points (NPN/PNP) and/or PIO board with 96 I/O points (NPN/PNP) can be installed.												
Serial communication function	Standard teaching port (D-sub, 25-pin) + 2-channel RS232C port (D-sub, 9-pin x 2)												
Protective functions	Motor overcurrent, overload, motor/driver temperature check, overload check, encoder open detection, soft limit overtravel, system error, battery error												
Surrounding air temperature/humidity, ambience	0 to 40°C, 10 to 95% (non-condensing); free from corrosive gases or significant dust.												
Weight (*2)	5.2kg				5.7kg				4.5kg				5kg
Accessory	I/O flat cable												

\*1 When axes corresponding to the maximum wattage are connected.  
\*2 Including the absolute battery, brake mechanism and expansion I/O box.

2-axis Combinations R C P 2  
2-axis Combinations R C S 2  
3-axis Combinations R C P 2  
3-axis Combinations R C S 2  
Controllers  
Model List  
PSEL  
SSEL  
ROBONET  
XSEL

**External Dimensions**

■ **J (Small Type)/K (General-purpose Type)**

	1-axis specification	2-axis specification	3/4-axis specification	Side view
J type (Small type)				
K type (General-purpose type)				

■ **P (Large-capacity Standard Type)/Q (Large-capacity Global Type)**

The shapes and dimensions of SEL-P/Q types vary depending on the controller specifications (encoder type, with/without brake, and with/without I/O expansion).

The following four shapes are available. Check the applicable dimensions based on the desired type and number of axes to be connected.

Controller specification	Base shape (incremental specification)		With brake/absolute unit	With I/O expansion base	With brake/absolute unit + I/O expansion base	Side view
	Encoder	Incremental	Absolute	Incremental	Absolute	
	Brake	Not equipped	Equipped	Not equipped	Equipped	
P type (Large-capacity)	I/O	Standard only	Standard only	Standard + Expansion	Standard + Expansion	
	1 to 4-axis specification					
5 to 6-axis specification						
Q type (Large capacity conforming to safety standard)	1 to 4-axis specification					
	5 to 6-axis specification					

\* The dimensions of single-phase 200-VAC controllers conform to those of the P type.

Name of Each Part

J Type (Small)

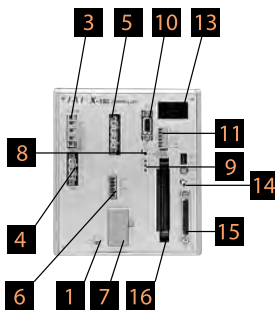

**1** FG connection terminal

A connection edge to connect the FG terminal of the enclosure. This terminal is connected to the PE terminal of the AC input part internally through the controller.

**2** Fuse holder (K type only)

A half-cut fuse holder for protecting the AC input part from overcurrent.

**3** Main-power input connector

A connector for 100/200-VAC single-phase input. (This connector comes with a cable-end plug. Refer to the right page.)

**4** Regenerative-resistor unit connector

This connector is used to connect the regenerative resistor unit (optional: REU-1) that may be required if the built-in regenerative connector is not enough due to high acceleration, high load, etc.

**5** Motor cable connector

A connector for the motor power cable of the actuator motor.

**6** Actuator-sensor input connector

A connector for the LS, CREEP, OT and other axis sensors.

**7** Absolute-data backup battery

A battery unit for backing up the absolute encoder if used. This battery is not connected to non-absolute axes.

**8** Brake release switch (brake specification only)

An alternate switch with lock for releasing the axis brake. To operate this switch, pull the switch toward you and then tilt it to a desired position. Tilt the switch to the top (RLS) position to forcibly release the brake, or tilt it to the bottom (NOM) position to let the controller control the brake automatically.

**9** Axis-driver status LEDs

These LEDs are used to monitor the operating status of the driver CPU that controls the motor drive. The following three LEDs are provided.

Name	Color	Meaning when the LED is lit
ALM	Orange	The driver has detected an error.
SVON	Green	The servo is ON and the motor is being driven.
BATT ALM	Orange	The absolute battery voltage is low.

**10** Encoder cable connector

This 15-pin, D-sub connector is used to connect the encoder cable of the actuator.

K Type (General-purpose)

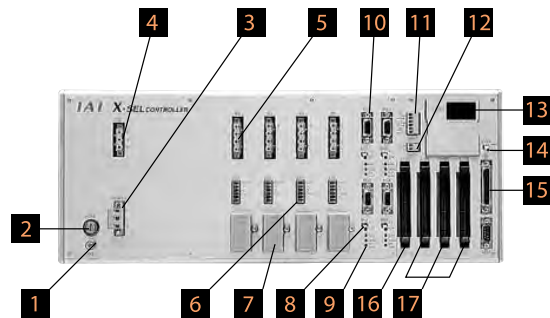

**11** System IO connector

This connector has a total of three I/Os including two inputs for controlling the controller operation and one output regarding the system status. (This connector comes with a cable-end plug. Refer to the right page.)

Name		
EMG	Emergency stop input	Operation is enabled when this signal is ON. An emergency stop is actuated when the signal turns OFF.
ENB	Safety gate input	Operation is enabled when this signal is ON. The servo turns OFF when the signal turns OFF.
RDY	System ready relay output	The controller status is output. Cascade connection is supported. The controller is ready when the output contacts are shorted and not ready when the contacts are open.

**12** IO24V power connector (K type only)

If DI/DOs are installed in the IO slots **16**, **17**, this connector is used to supply the I/O power to the insulated part externally.

**13** Panel window

The 4-digit 7-segment LED display and five LED lamps indicating the system status can be visually checked.

**14** Mode switch

An alternate switch with lock for specifying the operation mode of the controller. To operate this switch, pull the switch toward you and then tilt it to a desired position. The top position indicates the MANU (manual operation) mode, while the bottom position indicates the AUTO (auto operation) mode. Teaching operation can only be performed in the MANU mode, and auto operation using external I/Os cannot be performed in the MANU mode.

**15** Teaching connector

This D-sub, 25-pin connector is used to connect a teaching pendant or PC to input program positions.

**16** Standard I/O slot (slot 1)

The standard PIO board with 32 input points and 16 output points is installed in this slot.

**17** Expansion I/O slots (slot 2, slot 3, slot 4)

An expansion IO board (optional) can be installed in each of these slots.

2-axis  
Combinations  
R C P 2

2-axis  
Combinations  
R C S 2

3-axis  
Combinations  
R C P 2

3-axis  
Combinations  
R C S 2

Controllers

Model  
List

PSEL

SSEL

ROBONET

XSEL

**P type (standard, 4-axis)**

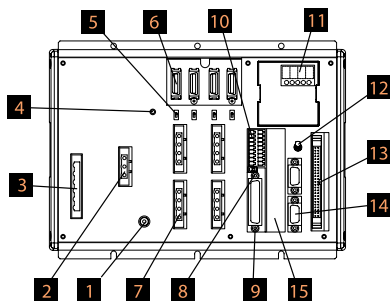

**1** FG connection terminal

A connection edge to connect the FG terminal of the enclosure. This terminal is connected to the PE terminal of the AC input part internally through the controller.

**2** External regeneration unit connector

This connector is used to connect an additional regenerative resistor when the built-in regenerative resistor is not enough due to high acceleration, high load, etc. Whether or not an external regenerative resistor is needed depends on the specifics of the application, such as the axis configuration.

**3** AC-power input connector

A connector for 200-VAC three-phase input. This connector consists of six terminals including the motor power-supply, control power-supply and PE terminals.

The standard specification only comes with a terminal block.

**Caution** To prevent electric shock, do not touch this connector while the power is supplied.

**4** Control power-supply monitor LED

A green light is lit while the control power supply is generating the internal controller power properly.

**5** Absolute-battery enable/disable switch

This switch is used to enable or disable the encoder backup operation using the absolute battery. The factory setting is to disable the backup. Connect the encoder and axes-sensor cables, turn on the power, and then set this switch to the top position.

**6** Encoder/axis-sensor connector

A connector for the actuator encoder and axis sensors such as LS, CREEP and OT. \*: LS, CREEP and OT sensors are optional.

**7** Motor connector

A connector for driving the motor in the actuator.

**8** Teaching-pendant type selector switch

This switch is used to change the type of the teaching pendant connected to the teaching connector **9**. You can switch between IAI's standard teaching pendant and ANSI teaching pendant. Set the switch provided on the front side of the board according to the teaching pendant to be used.

**9** Teaching connector

This teaching interface is used to connect IAI's teaching pendant or PC (PC software) to operate, set or otherwise manipulate the system.

**10** System I/O connector

This I/O connector controls the safety operations of the controller. With the global specification, this connector can be used, together with an external safety circuit, to configure a safety circuit meeting up to category 4.

**11** Panel window

The panel window consists of the 4-digit, 7-segment LED display and five LED lamps indicating the status of the system.

**Q type (with absolute brake unit + expansion base, 6-axis)**

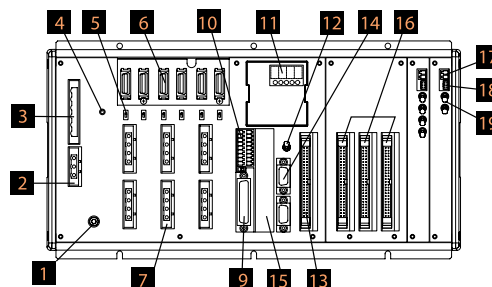

Meanings of 5 LEDs

Name	Condition when the LED is lit
RDY	The CPU is ready (to perform program operation).
ALM	A CPU alarm (system-shutdown level error) or CPU hardware error is present.
EMG	An emergency stop is actuated or CPU hardware error or power-supply hardware error is present.
PSE	A power-supply hardware error is present.
CLK	The system clock is abnormal.

**12** Mode switch

An alternate switch with lock for specifying the operation mode of the controller. To operate this switch, pull the switch toward you and then tilt it to a desired position. The top position indicates the MANU (manual operation) mode, while the bottom position indicates the AUTO (auto operation) mode. Teaching operation can only be performed in the MANU mode, and auto operation using external I/Os cannot be performed in the MANU mode.

**13** Standard I/O connector

Overview of standard IO interface specifications

Item	Photo-coupler
Connector name	I/O
Applicable connector	Flat connector, 50-pins
Power supply	Power is supplied from connector pin Nos. 1 and 50.
Inputs	32 points (including general-purpose and dedicated inputs)
Outputs	16 points (including general-purpose and dedicated outputs)
Connected to	External PLC, sensor, etc.

**14** General-purpose RS232C port connector

This port is used to connect general-purpose RS232C devices. (Two channels are provided.)

**15** Field-network board slot

A fieldbus interface module is installed in this slot.

**16** Expansion I/O boards (optional)

Optional expansion boards are installed in these slots.

**17** Brake-power input connector

A power input connector for driving the brake of the actuator. 24 VDC must be supplied externally. If the specified power is not supplied, the actuator brake cannot be released. Be sure to supply this power to axes with brake. For the brake power cable, use a shielded cable and connect the shield on the 24-v power supply side.

**18** Brake-release switch connector

This connector is used to connect a switch that releases the actuator brake from outside the controller. The brake is released when the COM and BKML\* terminals of this connector are shorted. Use this connector if you want to manually operate the actuator when the controller power is cut off or other abnormality is present.

**19** Brake switch

An alternate switch with lock for releasing the axis brake. To operate this switch, pull the switch toward you and then tilt it to a desired position. Tilt the switch to the top (RLS) position to forcibly release the brake, or tilt it to the bottom (NOM) position to let the controller control the brake automatically.

Options

Regenerative Resistor Unit

Model REU-1

Description

This unit converts to heat the regenerative current produced when the motor decelerates. Although the controller has a built-in regenerative resistor, a regeneration unit or units may be required if its capacity is not enough for the vertical axis load. (Refer to the table on the right.)

Specification

Item	Specification
Dimensions	W34mm×H195mm×D126mm
Weight	0.9kg
Built-in regenerative resistor	220Ω 80W
Accessory	Controller connection cable (model: CB-ST-REU101), 1 m

**Installation Standards** Determine the required number of unit(s) according to the total motor capacity of the connected vertical axes.

Horizontal application

Motor wattage	P/Q type	J type	K type
~200W	Not required	Not required	Not required
~800W	1 unit	Not required	Not required
~1000W	1 unit	-	Not required
~1500W	2 units	-	Not required
~2000W	3 units	-	-
~2400W	4 units	-	-

Vertical application

Motor wattage	P/Q type	J type	K type
~100W	Not required	Not required	Not required
~200W	1 unit	Not required	Not required
~400W	1 unit	1 unit	Not required
~600W	1 unit	1 unit	1 unit
~800W	1 unit	2 units	1 unit
~1200W	2 units	-	2 units
~1600W	3 units	-	Consult IAL
~2000W	4 units	-	-
~2400W	5 units	-	-

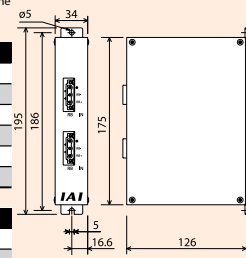

Absolute-data Backup Battery (for XSEL-J/K/KE/KT/KET)

Model IA-XAB-BT

**Features** A data backup battery for absolute axes. Replace the battery as soon as the controller generates a battery alarm.

Packing specification

Individually packed. (One battery is required for one axis. Specify an appropriate quantity according to the number of axes to be used.)



Absolute-data Backup Battery

Model AB-5

**Features** This absolute-data backup battery is used when absolute actuators are operated.



Expansion SIO Board (for General-purpose Type Only)

Model Specification

- IA-105-X-MW-A (for RS232C connection) (board + joint cable [1] x 2)
- IA-105-X-MW-B (for RS422 connection) (board + joint cable [2] x 1)
- IA-105-X-MW-C (for RS485 connection) (board + joint cable [2] x 1)

Description

This board is used to perform serial communication with external devices. The 2-channel port supports three communication patterns according to the supplied joint cable.

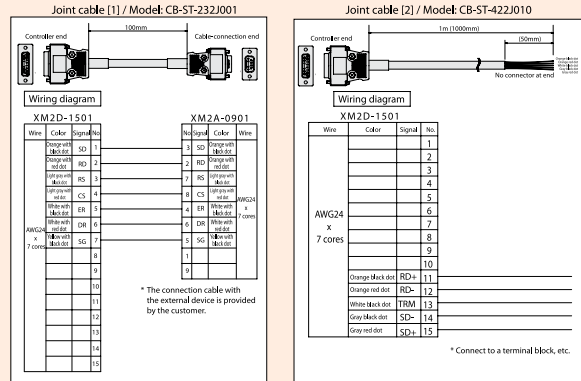

Expansion PIO Board

Description

This optional board is used to add I/Os (inputs/outputs). On the general-purpose and large-capacity types, up to three expansion PIO boards can be installed in the expansion slots. (On the small type, only one expansion PIO board can be installed in the expansion slot, provided that the controller is of 3 or 4-axis type.)

DeviceNet Connection Board

This board is used to connect the XSEL controller to DeviceNet.

Item	Specification			
Number of I/O points	256 input points/256 output points per board * Only one board can be installed.			
Communication protocol	Certified DeviceNet 2.0 interface module (Certification pending)			
	Group 2 only server			
Communication specification	Insulation node of network-power operation type			
	Master-slave connection	Bit strobe		
		Polling		
		Cyclic		
Baud rate	500k/250k/125kbps (Switchable via DIP switches)			
Communication cable length	Baud rate	Maximum network length	Maximum branch length	Total branch length
	500kbps	100m	6m	39m
	250kbps	250m		78m
	125kbps	500m	156m	
Note) When a thick DeviceNet cable is used.				
Communication power supply	24 VDC (supplied from DeviceNet)			
Current consumption of communication power supply	60 mA or more			
Number of occupied stations	1 node			
Connector	MSTBA2.5/5-G.08AUM by Phoenix Contact (*1)			

(\*1) The cable-end connector (SMSTB2.5/5-ST-5.08AU by Phoenix Contact) is a standard accessory.

CC-Link Connection Board

This board is used to connect the XSEL controller to CC-Link.

Item	Specification					
Number of I/O points	256 input points/256 output points per board * Only one board can be installed.					
Communication protocol	CC-Link Ver1.10 (Certified)					
Baud rate	10M/5M/2.5M/625k/156kbps (switchable via a rotary switch)					
Communication method	Broadcast polling method					
Synchronization method	Frame synchronization method					
Encoding method	NRZI					
Transmission path format	Bus format (conforming to EIA RS485)					
Transmission format	Conforming to HDLC					
Error control method	CRC(X <sup>16</sup> +X <sup>5</sup> +X <sup>2</sup> +1)					
Number of occupied stations	1 to 3 stations (remote device stations)					
Communication cable length	Baud rate (bps)	10M	5M	2.5M	625k	156k
	Cable length (m)	100	160	400	900	1200
Connector (controller end)	MSTBA2.5/5-G.08AUM by Phoenix Contact (*1)					

(\*1) The cable-end connector (SMSTB2.5/5-ST-5.08AU by Phoenix Contact) is a standard accessory.

- 2-axis Combinations R C P 2
- 2-axis Combinations R C S 2
- 3-axis Combinations R C P 2
- 3-axis Combinations R C S 2
- Controllers
- Model List
- PSEL
- SSEL
- ROBONET
- XSEL

## Options

### Teaching Pendant

**Features** A teaching device offering functions for program/position input, test operation, monitoring, and more.

#### Model/Price

Model	Description
SEL-T	Standard type with connector conversion cable
SEL-TD	Deadman switch type with connector conversion cable

#### Configuration

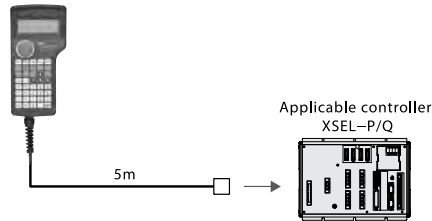

#### Specification

Item	SEL-T-J	SEL-TD-J
3-position enable switch	Not equipped	Equipped
ANSI/UL standard	Not compliant	Compliant
CE mark	Compliant	
Display	20 characters x 4 lines	
Surrounding air temperature/humidity	0-40°C 10-90%RH (non-condensing)	
Protection structure	IP54	
Weight	Approx. 0.4 kg (excluding cables)	

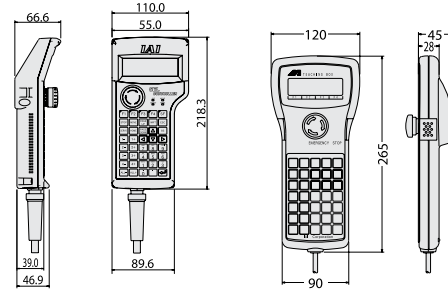

### PC Software (Windows only)

**Features** A software program that assists the initial startup of your system, offering functions for program/position input, test operation, monitoring, and more. The enhanced debugging functions help reduce the startup time.

**Model IA-101-X-MW** (with RS232C cable)

#### Configuration

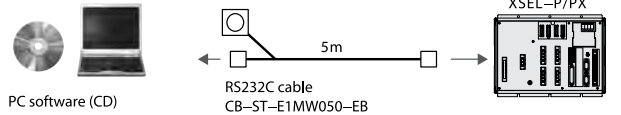

**Model IA-101-XA-MW** (with safety category 4 cable)

#### Configuration

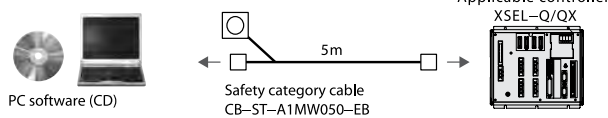

**Model IA-101-X-USBW** (with USB conversion adapter + cable)

#### Configuration

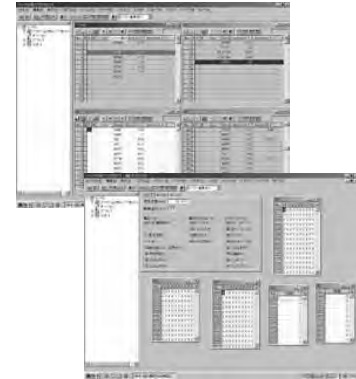
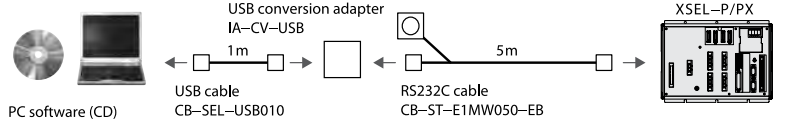

## Replacement Parts

If you must order a replacement cable, etc., after the initial purchase of your product, specify the correct model by referring to the information below.

### Motor Cable/Robot Motor Cable

Item **CB-RCC-MA** / **CB-RCC-MA** -RB

\* □ indicates the cable length (L). A desired length up to 20 m can be specified. Example) 080 = 8 m

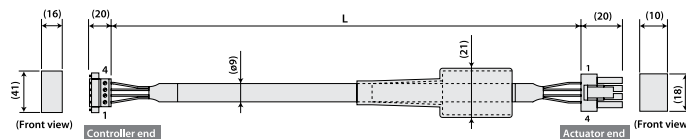

	Signal	No.	No.	Signal	Wire
0.75sq	PE	1	1	U	0.75sq (crimped)
	U	2	2	V	
	V	3	3	W	
	W	4	4	PE	

# 133

XSEL

Replacement Parts

Encoder Cable/Robot Encoder Cable (for XSEL-J/K types)

Item **CB-RCBC-PA** [ ] [ ] [ ] / **CB-RCBC-PA** [ ] [ ] [ ] **-RB**

\* [ ] [ ] indicates the cable length (L). A desired length up to 15 m can be specified. Example) 080 = 8 m

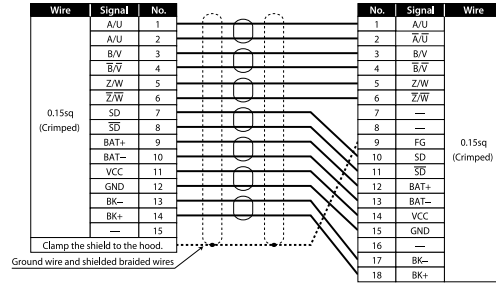
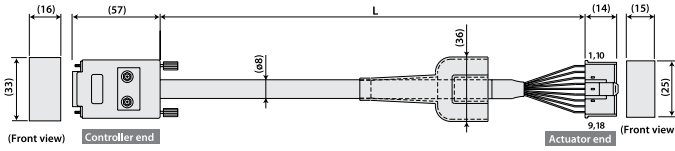

Encoder Cable/Robot Encoder Cable (for XSEL-P/Q types)

Item **CB-RCS2-PA** [ ] [ ] [ ] / **CB-X3-PA** [ ] [ ] [ ]

\* [ ] [ ] indicates the cable length (L). A desired length up to 20 m can be specified. Example) 080 = 8 m

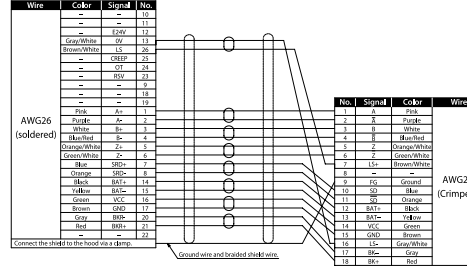
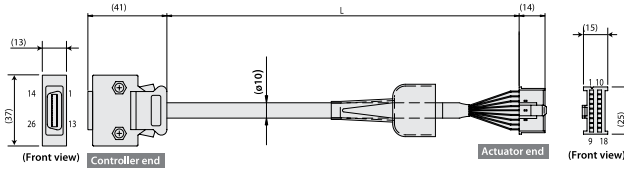

Dedicated Encoder Cable/Robot Encoder Cable for Rotary Robots

Item **CB-RCS2-PLA** [ ] [ ] [ ] / **CB-X2-PLA** [ ] [ ] [ ]

\* [ ] [ ] indicates the cable length (L). A desired length up to 30 m can be specified. Example) 080 = 8 m

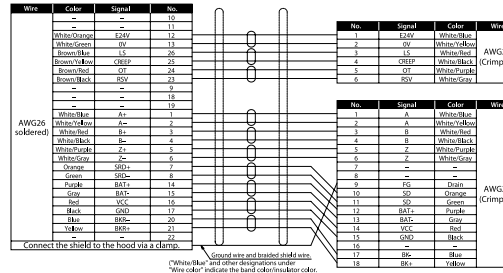
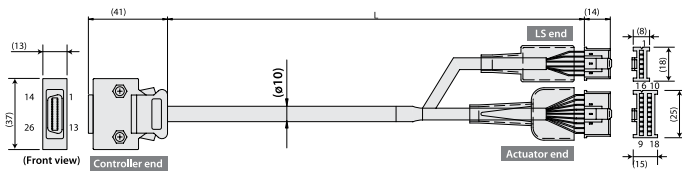

Limit Switch Cable (for X-SEL-J/K types)

Item **CB-X-LC** [ ] [ ] [ ]

\* [ ] [ ] indicates the cable length (L). A desired length up to 20 m can be specified. Example) 080 = 8 m

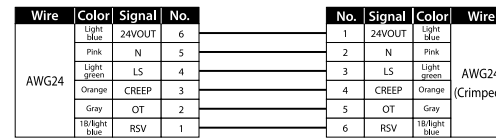
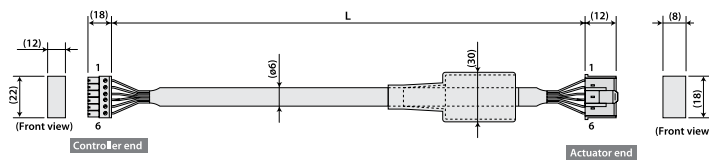

Note) "1B" indicates one black dot.

I/O Flat Cable (XSEL-J/K/P/Q types)

Item **CB-X-PIO** [ ] [ ] [ ]

\* [ ] [ ] indicates the cable length (L). A desired length up to 10 m can be specified. Example) 080 = 8 m

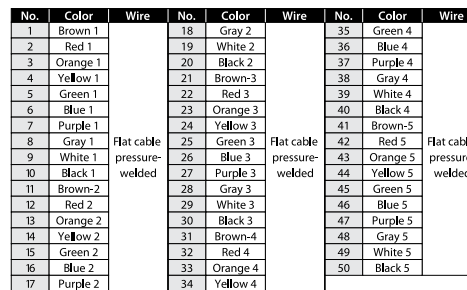
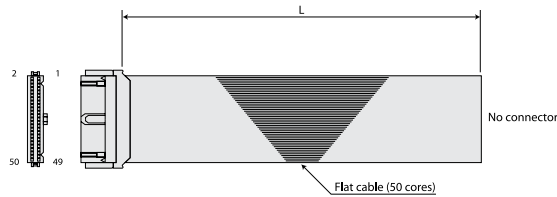

2-axis Combinations RCP 2  
 2-axis Combinations RCS 2  
 3-axis Combinations RCP 2  
 3-axis Combinations RCS 2  
 Controllers  
 Model List  
 PSEL  
 SSEL  
 ROBONET  
 XSEL

## [A]

AB-5	(System-memory backup battery)	101 • 111
AB-5	(Absolute-data backup battery)	111 • 132
AB-5-CS	(System-memory backup battery)	101 • 111

## [C]

CB-ACS-MA□□□□	(Cable)	124
CB-ACS-MPA□□□□	(Cable)	124
CB-ACS-PA□□□□	(Cable)	124
CB-ACS-PA□□□□-RB	(Cable)	124
CB-DS-PIO□□□□	(Cable)	102 • 112
CB-PCS-MPA□□□□	(Cable)	102 • 123
CB-RCBC-PA□□□□	(Cable)	134
CB-RCBC-PA□□□□-RB	(Cable)	134
CB-RCC-MA□□□□	(Cable)	112 • 133
CB-RCC-MA□□□□-RB	(Cable)	112 • 133
CB-RCP2-MA□□□□	(Cable)	102 • 123
CB-RCP2-PB□□□□	(Cable)	123
CB-RCP2-PB□□□□-RB	(Cable)	123
CB-RCP2-PB□□□□	(Cable)	102
CB-RCP2-PB□□□□-RB	(Cable)	102
CB-RCS2-PA□□□□	(Cable)	112
CB-RCS2-PA□□□□	(Cable)	134
CB-RCS2-PLA□□□□	(Cable)	112 • 134
CB-REXT-CTL010	(Cable)	124
CB-REXT-SIO010	(Cable)	124
CB-SEL-SJ002	(Cable)	102 • 112
CB-SEL-USB010	(Cable)	102 • 112
CB-X2-PLA□□□□	(Cable)	112 • 134
CB-X3-PA□□□□	(Cable)	112 • 134
CB-X-LC□□□□	(Cable)	134
CB-X-PIO□□□□	(Cable)	134
CON-T	(Teaching pendant)	122

## [D]

DP-3	(Dummy plug)	101 • 112
------	--------------	-----------

## [I]

IA-101-XA-MW	(PC software)	133
IA-101-X-MW	(PC software)	111 • 133
IA-101-X-MW-J	(PC software)	101 • 111
IA-101-X-USB	(PC software)	101 • 111
IA-101-X-USBMW	(PC software)	133
IA-105-X-MW-A	(Expansion SIO board)	132
IA-105-X-MW-B	(Expansion SIO board)	132
IA-105-X-MW-C	(Expansion SIO board)	132
IA-XAB-BT	(Absolute-data backup battery)	132
IK2-PXBB1□□□D	(IA kit)	31
IK2-PXBB1□□□S	(IA kit)	29
IK2-PXBB2□□□D	(IA kit)	35
IK2-PXBB2□□□S	(IA kit)	33
IK2-PXBC1□□□D	(IA kit)	23
IK2-PXBC1□□□S	(IA kit)	21
IK2-PXBC2□□□D	(IA kit)	27
IK2-PXBC2□□□S	(IA kit)	25
IK2-PXBD1□□□D	(IA kit)	15
IK2-PXBD1□□□S	(IA kit)	13
IK2-PXBD2□□□D	(IA kit)	19
IK2-PXBD2□□□S	(IA kit)	17
IK2-PXZB1□□□D	(IA kit)	39
IK2-PXZB1□□□S	(IA kit)	37
IK2-PYBB1□□□S	(IA kit)	41
IK2-SXBA1□□□D	(IA kit)	69

IK2-SXBA1□□□S	(IA kit)	67
IK2-SXBA2□□□D	(IA kit)	73
IK2-SXBA2□□□S	(IA kit)	71
IK2-SXBB1□□□D	(IA kit)	61
IK2-SXBB1□□□S	(IA kit)	59
IK2-SXBB2□□□D	(IA kit)	65
IK2-SXBB2□□□S	(IA kit)	63
IK2-SXBC1□□□D	(IA kit)	53
IK2-SXBC1□□□S	(IA kit)	51
IK2-SXBC2□□□D	(IA kit)	57
IK2-SXBC2□□□S	(IA kit)	55
IK2-SXBD1□□□D	(IA kit)	45
IK2-SXBD1□□□S	(IA kit)	43
IK2-SXBD2□□□D	(IA kit)	49
IK2-SXBD2□□□S	(IA kit)	47
IK2-SXZB1□□□D	(IA kit)	77
IK2-SXZB1□□□S	(IA kit)	75
IK2-SYBB1□□□S	(IA kit)	79
IK3-PBBG1□□□D	(IA kit)	83
IK3-PBBG1□□□S	(IA kit)	81
IK3-SBBG1□□□D	(IA kit)	88
IK3-SBBG1□□□S	(IA kit)	85

## [J]

JB-1	(ROBONET communication connection board)	123
------	--	-----

## [P]

PP-1	(Power-supply connection plate)	123
PS-241	(24-V power supply)	123
PS-242	(24-V power supply)	123
PSEL-C	(Controller)	93
PU-1	(Panel unit)	101 • 111

## [R]

RABU	(Simple absolute R unit)	121
RACON	(RACON unit)	120
RCM-101-MW	(PC software)	122
RCM-101-USB	(PC software)	122
RCM-E	(Teaching pendant)	122
RCM-P	(Teaching pendant)	122
REU-1	(Regenerative resistor unit)	132
REU-2	(Regenerative resistor unit)	111
REXT	(Expansion unit)	121
RGW-CC	(Gateway R unit)	118
RGW-DV	(Gateway R unit)	118
RGW-PR	(Gateway R unit)	119
RGW-SIO	(Gateway R unit)	119
ROBONET	(Controller)	113
RPCON	(RPCON unit)	120

## [S]

SEL-T	(Teaching pendant)	133
SEL-TD	(Teaching pendant)	133
SEL-TD-J	(Teaching pendant)	10 • 11
SEL-T-J	(Teaching pendant)	10 • 11
SSEL-C	(Controller)	103

## [T]

TN-1	(Terminal resistor board)	123
------	---------------------------	-----

## [X]

XSEL-J	(Controller)	125
XSEL-K	(Controller)	125
XSEL-P	(Controller)	125
XSEL-Q	(Controller)	125