

- Slider Type
- Mini
- Standard
- Controllers Integrated
- Rod Type
- Mini
- Standard
- Controllers Integrated
- Table/Arm /Flat Type
- Mini
- Standard
- Gripper/ Rotary Type
- Linear Servo Type
- Cleanroom Type
- Splash-Proof
- Controllers
- PMEC /AMEC
- PSEP /ASEP
- ROBO NET
- ERC2
- PCON
- ACON
- SCON
- PSEL
- ASEL
- SSEL
- XSEL
- Pulse Motor
- Servo Motor (24V)
- Servo Motor (200V)
- Linear Servo Motor



List of models

Program controller for operating RCA2/RCA Series actuators. One unit can handle various controls.

Type	C	
Name	Program mode	Positioner Mode
External view		
Description	Both the actuator operation and communication with external equipment can be handled by a single controller. When two axes are connected, arc interpolation, path operations, and synchronization can be performed.	Up to 1500 positioning points are supported. Push-motion operation and teaching operation are also possible.
Position points	1500 points	
Number of control axes	Up to 2 axes	

Model

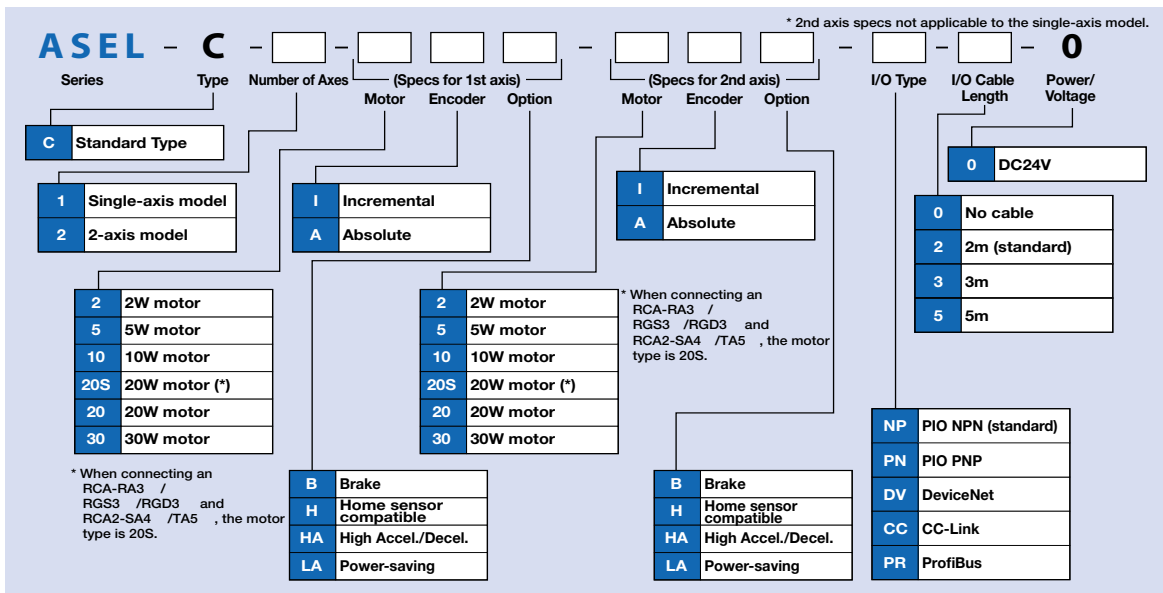

567

ASEL

System configuration

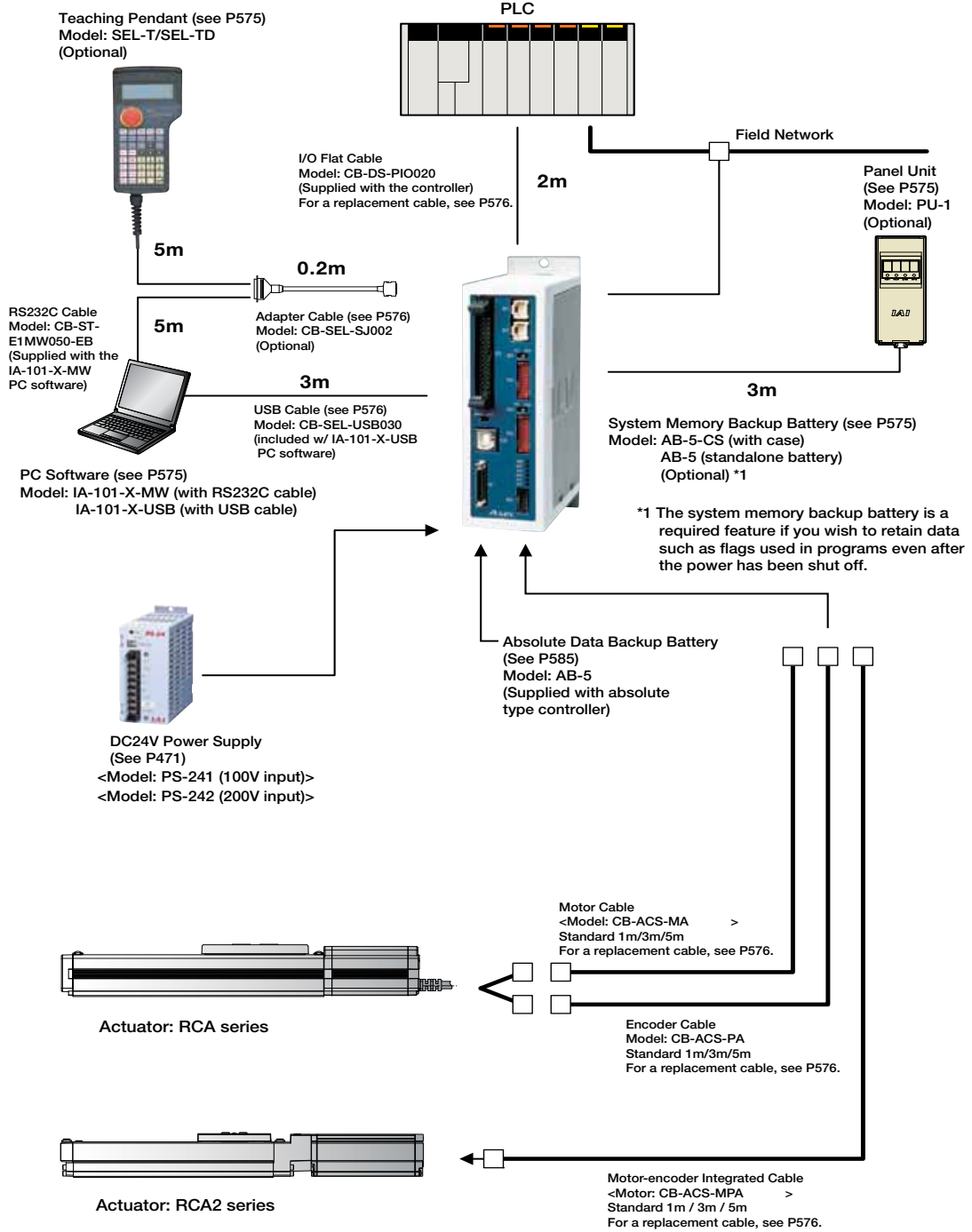

- Slider Type
- Mini
- Standard
- Controllers Integrated
- Rod Type
- Mini
- Standard
- Controllers Integrated
- Table/Arm /Flat Type
- Mini
- Standard
- Gripper/ Rotary Type
- Linear Servo Type
- Cleanroom Type
- Splash-Proof
- Controllers**
- PMEC /AMEC
- PSEP /ASEP
- ROBO NET
- ERC2
- PCON
- ACON
- SCON
- PSEL
- ASEL**
- SSEL
- XSEL
- Pulse Motor
- Servo Motor (24V)**
- Servo Motor (200V)
- Linear Servo Motor

I/O Specifications

Input section External input specifications

Item	Specifications
Input voltage	DC24V ±10%
Input current	7mA / circuit
ON/OFF voltage	ON voltage (min.) NPN : DC16V / PNP : DC8V OFF voltage (max.) NPN : DC5V / PNP : DC19V
Isolation method	Photocoupler

NPN Specifications

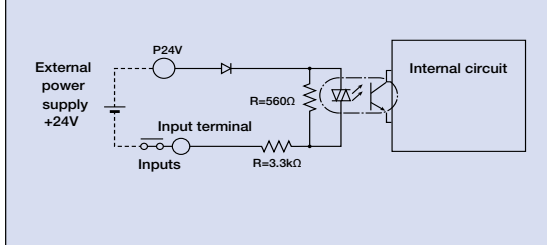

Output section External output specifications

Item	Specifications
Load Voltage	DC24V
Max. load current	100mA / 1 point 400mA / 8 points in total
Residual voltage (Max.)	Max 0.1mA / 1 point
Isolation method	Photocoupler

NPN Specifications

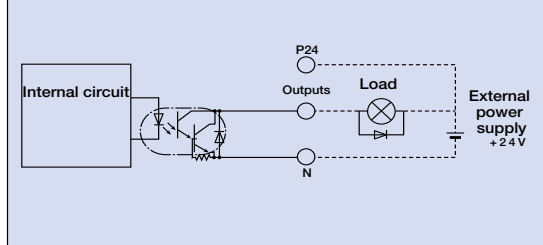

PNP Specifications

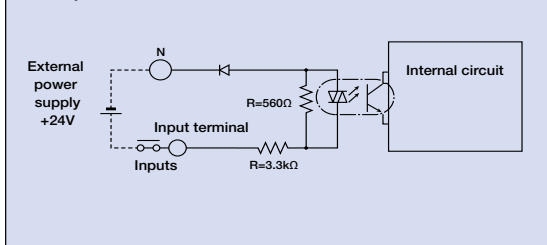

PNP Specifications

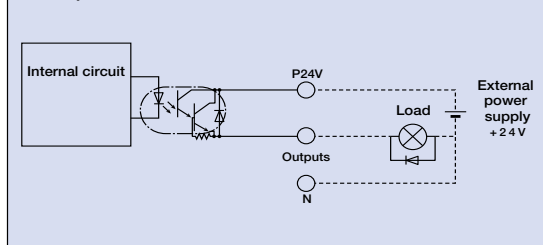

Explanation of I/O Signal Functions

Two modes can be selected for the ASEL controller: "Program Mode," in which the actuator is operated by entering a program, and "Positioner Mode," in which PLC signals are received and the actuator is moved to designated positions. The Positioner Mode has the five input patterns listed below to enable various applications.

Control Function by Type

Operation mode	Features
Program mode	Various operations including linear/arc interpolation operation, path operation ideal for coating processes, etc., arch-motion operation and palletizing operation can be performed using the Super SEL language that lets you program complex control actions using simple commands.
Positioner mode	Standard mode This is the basic mode from which operations can be conducted by designating position numbers and inputting the start signal. Push-motion operation and teaching operation are also possible.
	Product Change mode Multiple parts of the same shape with slightly different hole positions can be handled using movement commands to the same position numbers by simply changing the product type number.
	2-axis independent mode With a 2-axis controller, each axis can be commanded and operated separately.
	Teaching mode In this mode, the slider (rod) moves based on an external signal, when the actuator is stopped, the current location can be registered as position data.
	DS-S-C1 Compatible mode If you were using a DS-S-C1 controller, you can replace it with a ASEL controller without having to change the host programs. *This mode does not ensure actuator compatibility.

569

ASEL

- Slider Type
- Mini
- Standard
- Controllers Integrated
- Rod Type
- Mini
- Standard
- Controllers Integrated
- Table/Arm /Flat Type
- Mini
- Standard
- Gripper/ Rotary Type
- Linear Servo Type
- Cleanroom Type
- Splash-Proof
- Controllers
- PMEC /AMEC
- PSEP /ASEP
- ROBO NET
- ERC2
- PCON
- ACON
- SCON
- PSEL
- ASEL
- SSEL
- XSEL
- Pulse Motor
- Servo Motor (24V)
- Servo Motor (200V)
- Linear Servo Motor

Explanation of I/O Signal Functions

Program mode

Pin Number	Category	Port No.	Program Mode	Functions	Wiring Diagram			
1A	P24	016-022	24V input	Connect 24V.				
1B			Select Program No. 1	Selects the program number to start. (Input as BCD values to ports 016 to 022)				
2A			Select Program No. 2					
2B			Select Program No. 4					
3A			Select Program No. 8					
3B			Select Program No. 10					
4A			Select Program No. 20					
4B			Select Program No. 40					
5A			CPU reset		Resets the system to the same state as when the power is turned on.			
5B			Start		Starts the program selected by ports 016 to 022.			
6A			Input		001-015		General-purpose input	Waits for external input via program instructions.
6B							General-purpose input	
7A							General-purpose input	
7B							General-purpose input	
8A	General-purpose input							
8B	General-purpose input							
9A	General-purpose input							
9B	General-purpose input							
10A	General-purpose input							
10B	General-purpose input							
11A	Output	300-307	Alarm	Turns off when an alarm occurs. (Contact B)				
13B			Ready	Turns on when the controller starts up normally and is in an operable state.				
14A			General-purpose output	303-307	These outputs can be turned ON/OFF as desired via program instructions.			
14B								
15A								
15B								
16A								
16B	N	0V input	Connect 0V.					
17B								

Note: This is for NPN. PNP will be different.

Positioner mode

Pin Number	Category	Port No.	Positioner Standard Mode	Functions	Wiring Diagram	
1A	P24	016-022	24V input	Connect 24V.		
1B			Position input 10	Specifies the position numbers to move to, using port number 007 to 019. The number can be specified either as BCD or binary.		
2A			Position input 11			
2B			Position input 12			
3A			Position input 13			
3B			-			
4A			-			
4B			-			
5A			Error reset		Resets minor errors. (Severe errors require a restart.)	
5B			Start		Starts moving to the selected position.	
6A			Home Return		Performs Home Return.	
6B			Servo ON		Switches between Servo ON and OFF.	
7A			Push		Performs a push motion.	
7B			Pause		Pauses the motion when turned OFF, and resumes motion when turned ON.	
8A	Cancel	Stops the motion when turned OFF. The remaining motion is canceled.				
8B	Input	006-015	Interpolation settings	When this signal turned ON for a 2-axis model, the actuator moves by linear interpolation.		
9A			Position input 1	Specifies the position numbers to move to, using ports 007 to 019. The number can be specified either as BCD or binary.		
9B			Position input 2			
10A			Position input 3			
10B			Position input 4			
11A			Position input 5			
11B			Position input 6			
12A			Position input 7			
12B			Position input 8			
13A	Position input 9					
13B	Output	300-307	Alarm	Turns off when an alarm occurs. (Contact B)		
14A			Ready	Turns on when the controller starts up normally and is in an operable state.		
14B			Positioning complete	Turns on when the movement to the destination is complete.		
15A			Home Return complete	Turns on when the home return operation is complete.		
15B			Servo ON output	Turns on when servo is ON.		
16A			Pushing complete	Turns on when a push motion is complete.		
16B			System battery error	Turns on when the system battery runs low (warning level).		
17A	Absolute encoder battery error	Turns on when the battery for the absolute encoder runs low (warning level).				
17B	N	0V input	Connect 0V.			

Note: This is for NPN. PNP will be different.

- Slider Type
- Mini
- Standard
- Controllers Integrated
- Rod Type
- Mini
- Standard
- Controllers Integrated
- Table/Arm /Flat Type
- Mini
- Standard
- Gripper/ Rotary Type
- Linear Servo Type
- Cleanroom Type
- Splash-Proof
- Controllers
- PMEC /AMEC
- PSEP /ASEP
- ROBO NET
- ERC2
- PCON
- ACON
- SCON
- PSEL
- ASEL
- SSEL
- XSEL
- Pulse Motor
- Servo Motor (24V)
- Servo Motor (200V)
- Linear Servo Motor

ASEL 570

Explanation of I/O Signal Functions

Positioner, Product-Type Change Mode

Pin Number	Category	Port No.	Positioner Product Type Change Mode	Functions		
1A	P24	016	24V input	Connect 24V.		
1B			Position/Product Type Input 10	Specifies the position numbers to move to, and the product type numbers, using ports 007 to 022. The position and product type numbers are assigned by parameter settings. The number can be specified either as BCD or binary.		
2A			Position/Product Type Input 11			
2B			Position/Product Type Input 12			
3A			Position/Product Type Input 13			
3B			Position/Product Type Input 14			
4A			Position/Product Type Input 15			
4B			Position/Product Type Input 16			
5A			023		Error reset	Resets minor errors. (Severe errors require a restart.)
5B			000		Start	Starts moving to the selected position.
6A			001		Home Return	Performs Home Return.
6B			002		Servo ON	Switches between Servo ON and OFF.
7A			003		Push	Performs a push motion.
7B			004		Pause	Pauses the motion when turned OFF, and resumes motion when turned ON.
8A			005		Cancel	Stops the motion when turned OFF. The remaining motion is canceled.
8B			006		Interpolation settings	When this signal is turned ON for a 2-axis model, the actuator moves by linear interpolation.
9A	Input	007	Position/Product Type Input 1		Specifies the position numbers to move to, and the product type numbers, using ports 007 to 022. The position and product type numbers are assigned by parameter settings. The number can be specified either as BCD or binary.	
9B			Position/Product Type Input 2			
10A			Position/Product Type Input 3			
10B			Position/Product Type Input 4			
11A			Position/Product Type Input 5			
11B			Position/Product Type Input 6			
12A			Position/Product Type Input 7			
12B			Position/Product Type Input 8			
13A			015	Position/Product Type Input 9		
13B	Output	300	Alarm	Turns off when an alarm occurs (Contact B)		
14A			301	Ready	Turns on when the controller starts up normally and is in an operable state.	
14B			302	Positioning complete	Turns on when the movement to the destination is complete.	
15A			303	Home Return complete	Turns on when the home return operation is complete.	
15B			304	Servo ON output	Turns on when servo is ON.	
16A			305	Pushing complete	Turns on when a push motion is complete.	
16B			306	System battery error	Turns on when the system battery runs low (warning level).	
17A			307	Absolute encoder battery error	Turns on when the battery for the absolute encoder runs low (warning level).	
17B	N		0V input	Connect 0V.		

Wiring Diagram

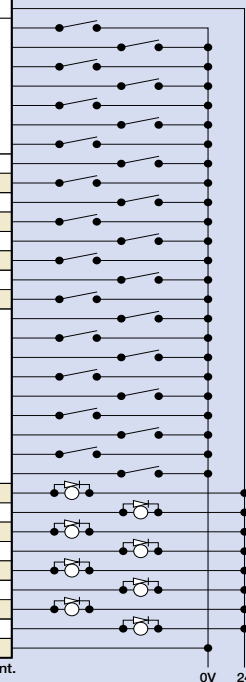

Note: This is for NPN. PNP will be different.

Positioner, 2-axis Independent Mode

Pin Number	Category	Port No.	Positioner 2-axis Independent Mode	Functions		
1A	P24	016	24V input	Connect 24V.		
1B			Position input 7	Specifies the position numbers to move to, using ports 010 to 022. The position numbers on the 1st and 2nd axes are assigned by parameter settings. The number can be specified either as BCD or binary.		
2A			Position input 8			
2B			Position input 9			
3A			Position input 10			
3B			Position input 11			
4A			Position input 12			
4B			Position input 13			
5A			023		Error reset	Resets minor errors. (Severe errors require a restart.)
5B			000		Start 1	Starts movement to the selected position number on the 1st axis.
6A			001		Home Return 1	Performs home return on the 1st axis.
6B			002		Servo ON 1	Switches between servo ON and OFF for the 1st axis.
7A			003		Pause 1	Pauses the motion on 1st axis when turned OFF, and resumes motion when turned ON.
7B	004	Cancel 1	Cancels the movement on the 1st axis.			
8A	005	Start 2	Starts the movement to the selected position number on the 2nd axis.			
8B	006	Home Return 2	Performs home return on the 2nd axis.			
9A	007	Servo ON 2	Switches between servo ON and OFF for the 2nd axis.			
9B	008	Pause 2	Pauses the motion on 2nd axis when turned OFF, and resumes when turned ON.			
10A	009	Cancel 2	Cancels the movement on the 2nd axis.			
10B	Input	010	Position input 1	Specifies the position numbers to move to, using ports 010 to 022. The position numbers on the 1st and 2nd axes are assigned by parameter settings. The number can be specified either as BCD or binary.		
11A			Position input 2			
11B			Position input 3			
12A			Position input 4			
12B			Position input 5			
13A			015		Position input 6	
13B	Output	300	Alarm	Turns off when an alarm occurs (Contact B)		
14A			301	Ready	Turns on when the controller starts up normally and is in an operable state.	
14B			302	Positioning complete 1	Turns on when the movement to the specified position on the 1st axis is complete.	
15A			303	Home Return complete 1	Turns on when home return on the 1st axis is complete.	
15B			304	Servo ON output 1	Turns on when the 1st axis is in a servo ON state.	
16A			305	Positioning complete 2	Turns on when the movement to the specified position on the 2nd axis is complete.	
16B			306	Home Return complete 2	Turns on when home return on the 2nd axis is complete.	
17A	307	Servo ON output 2	Turns on when the 2nd axis is in a servo ON state.			
17B	N		0V input	Connect 0V.		

Wiring Diagram

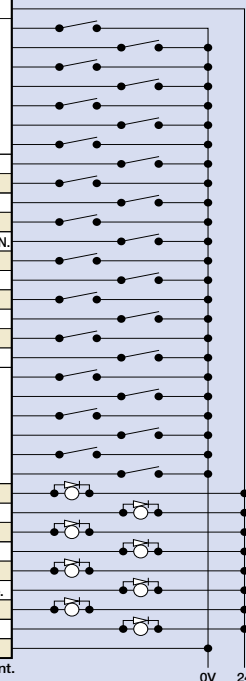

Note: This is for NPN. PNP will be different.

571

ASEL

- Slider Type
- Mini
- Standard
- Controllers Integrated
- Rod Type
- Mini
- Standard
- Controllers Integrated
- Table/Arm /Flat Type
- Mini
- Standard
- Gripper/ Rotary Type
- Linear Servo Type
- Cleanroom Type
- Splash-Proof
- Controllers
- PMEC /AMEC
- PSEP /ASEP
- ROBO NET
- ERC2
- PCON
- ACON
- SDON
- PSEL
- ASEL
- SSEL
- XSEL
- Pulse Motor
- Servo Motor (24V)
- Servo Motor (200V)
- Linear Servo Motor

Explanation of I/O Signal Functions

Positioner, Teaching Mode

Pin Number	Category	Port No.	Positioner Teaching Mode	Functions	Wiring Diagram		
1A	P24	016	24V input	Connect 24V.			
1B			JOG- on 1st axis	While the signal is on, the 1st axis is moved in the - (negative) direction.			
2A			JOG+ on 2nd axis	While the signal is on, the 2nd axis is moved in the + (positive) direction.			
2B			JOG- on 2nd axis	While the signal is on, the 2nd axis is moved in the - (negative) direction.			
3A			Specify inching (0.01mm)	020	Specify inching (0.01mm)		Specifies how much to move during inching. (Total of the values specified for ports 019 to 022)
3B					Specify inching (0.1mm)		
4A					Specify inching (0.5mm)		
4B					Specify inching (1mm)		
5A			023	Error reset	Resets minor errors. (Severe errors require a restart.)		
5B			000	Start	Starts moving to selected position.		
6A			001	Servo ON	Switches between Servo ON and OFF.		
6B			002	Pause	Pauses the motion when turned OFF, and resumes motion when turned ON.		
7A			Input	003	Position input 1		Ports 003 to 013 are used to specify the position number to move, and the position number for inputting the current position. - When the teaching mode setting on port 014 is in the ON state, the current value is written to the specified position number.
7B				004	Position input 2		
8A				005	Position input 3		
8B				006	Position input 4		
9A				007	Position input 5		
9B	008	Position input 6					
10A	009	Position input 7					
10B	010	Position input 8					
11A	011	Position input 9					
11B	012	Position input 10					
12A	013	Position input 11					
12B	014	Teaching mode setting					
13A	015	JOG+ on 1st axis	While the signal is input, the 1st axis is moved in the + (positive) direction.				
13B	300	Alarm	Turns off when an alarm occurs. (Contact B)				
14A	301	Ready	Turns on when the controller starts up normally and is in an operable state.				
14B	302	Positioning complete	Turns on when the movement to the destination is complete.				
15A	303	Home return complete	Turns on when the home return operation is complete.				
15B	304	Servo ON output	Turns on when servo is ON.				
16A	305	-	-				
16B	306	System battery error	Turns on when the system battery runs low (warning level).				
17A	307	Absolute encoder battery error	Turns on when the battery for the absolute encoder runs low (warning level).				
17B	N	0V input	Connect 0V.				

Note: This is for NPN. PNP will be different.

Positioner, DS-S-C1 Compatible Mode

Pin Number	Category	Port No.	Positioner DS-S-C1 Compatible Mode	Functions	Wiring Diagram	
1A	P24	016	24V input	Connect 24V.		
1B			Position No. 1000	(Same as ports 004 through 015)		
2A			017	-	-	
2B			018	-	-	
3A			019	-	-	
3B			020	-	-	
4A			021	-	-	
4B			022	-	-	
5A			023	CPU reset	Resets the system to the same state as when the power is turned on.	
5B			000	Start	Starts moving to selected position.	
6A			001	Hold (Pause)	Pauses the motion when turned ON, and resumes when turned OFF.	
6B			002	Cancel	Stops the motion when turned ON. The remaining motion is canceled.	
7A			003	Interpolation settings	When this signal is turned ON for a 2-axis model, the actuator moves by linear interpolation.	
7B			004	Position No. 1	Ports 004 through 016 are used to specify the position number to move. The numbers are specified as BCD.	
8A			005	Position No. 2		
8B			006	Position No. 4		
9A			007	Position No. 8		
9B	008	Position No. 10				
10A	009	Position No. 20				
10B	010	Position No. 40				
11A	011	Position No. 80				
11B	012	Position No. 100				
12A	013	Position No. 200				
12B	014	Position No. 400				
13A	015	Position No. 800				
13B	300	Alarm	Turns off when an alarm occurs. (Contact A)			
14A	301	Ready	Turns on when the controller starts up normally and is in an operable state.			
14B	302	Positioning complete	Turns on when the movement to the destination is complete.			
15A	303	-	-			
15B	304	-	-			
16A	305	-	-			
16B	306	System battery error	Turns on when the system battery runs low (warning level).			
17A	307	Absolute encoder battery error	Turns on when the battery for the absolute encoder runs low (warning level).			
17B	N	0V input	Connect 0V.			

Note: This is for NPN. PNP will be different.

- Slider Type
- Mini
- Standard
- Controllers Integrated
- Rod Type
- Mini
- Standard
- Controllers Integrated
- Table/Arm /Flat Type
- Mini
- Standard
- Gripper/ Rotary Type
- Linear Servo Type
- Cleanroom Type
- Splash-Proof
- Controllers
- PMEC /AMEC
- PSEP /ASEP
- ROBO NET
- ERC2
- PCON
- ACON
- SCON
- PSEL
- ASEL
- SSEL
- XSEL
- Pulse Motor
- Servo Motor (24V)
- Servo Motor (200V)
- Linear Servo Motor

Table of specifications

	Item	Specifications
Basic Specifications	Connected actuator	RCA/RCA2 Series Actuator
	Input Voltage	DC24V ±10%
	Power Supply Capacity	Control power supply (Max. 1.2A) + motor power supply (See the table below)
	Dielectric strength voltage	DC500V 10MΩ or higher
	Withstand voltage	AC500V 1 min.
	Rush current	Max. 30A
	Vibration resistance	XYZ directions 10 to 57Hz, One side amplitude: 0.035mm (continuous), 0.075mm (intermittent) 58 to 150 Hz 4.9 m/s ² (continuous), 9.8 m/s ² (intermittent)
Control specification	Number of control axes	1 axis / 2 axis
	Maximum total output of connected axis	60W (30W + 30W)
	Position detection method	Incremental encoder / Absolute encoder
	Speed setting	1mm/sec and up, the maximum depends on actuator specifications
	Acceleration setting	0.01G and up, the maximum depends on the actuator
	Operating method	Program operation / Positioner operation (switchable)
Program	Programming language	Super SEL language
	Number of programs	64 programs
	Number of program steps	2000 steps
	Number of multi-tasking programs	8 points
	Positioning Points	1500 points
	Data memory device	FLASHROM (A system-memory backup battery can be added as an option)
Communication	Data input method	Teaching pendant or PC software
	Number of I/O	24 input points / 8 output points (NPN or PNP selectable)
	I/O power	Externally supplied 24VDC ± 10%
	PIO cable	CB-DS-PIO □□□ (supplied with the controller)
	Serial communications function	RS232C (D-Sub Half-pitch connector) / USB connector
	Field Network	DeviceNet, CC-Link, ProfiBus
	Motor Cable	CB-ACS-MA □□□ (Max. 20m)
	Encoder cable	CB-ACS-PA □□□ (Max. 20m)
General specifications	Protection function	Motor overcurrent, Motor driver temperature check, Overload check, Encoder open-circuit check Soft limit over, system error, battery error, etc.
	Ambient operating humidity and temperature	0 to 40°C 10 to 95% (non-condensing)
	Ambient atmosphere	Free from corrosive gases. In particular, there shall be no significant dust.
	Protection class	IP20
	Weight	Approx. 450g
	External dimensions	43 mm (W) x 159 mm (H) x 110 mm (D)

Actuator type	1-Axis specification				2-Axis specification				
	Standard specifications/high acceleration and deceleration model		Power-saving		Standard specifications/high acceleration and deceleration model		Power-saving		
	Rated	Max. (Note2)	Rated	Max. (Note3)	Rated	Max. (Note2)	Rated	Max. (Note3)	
RCA RCA2	10W, 20W [Model symbol: 20]	1.3A	4.4A	1.3A	2.5A	2.6A	8.8A	2.6A	5.0A
	30W	1.3A	4.4A	1.3A	2.2A	2.6A	8.8A	2.6A	4.4A
	20W [Model symbol: 20S] SA4, RA3, TA5 type dedicated	1.7A	5.1A	1.7A	3.4A	3.4A	10.2A	3.4A	6.8A
RCL	2W	0.8A	4.6A	-	-	1.6A	9.2A	-	-
	5W	1.0A	6.4A	-	-	2.0A	12.8A	-	-
	10W	1.3A	6.4A	-	-	2.6A	12.8A	-	-

(Note 1) For both 1-axis and 2-axis specifications, approx. 30.0A inrush current flows for 5 ms when the control power supply is turned on.

(Note 2) Max. current at accelerating/decelerating

(Note 3) Current reaches the maximum when detecting the servo motor excitation phase at the first servo on after the power is on. (Normal: Approx. 1 to 2 sec., Max.: 10 sec)

(Note 4) Other than motor power supply capacity, it increases 0.5A for control power.

External Dimensions

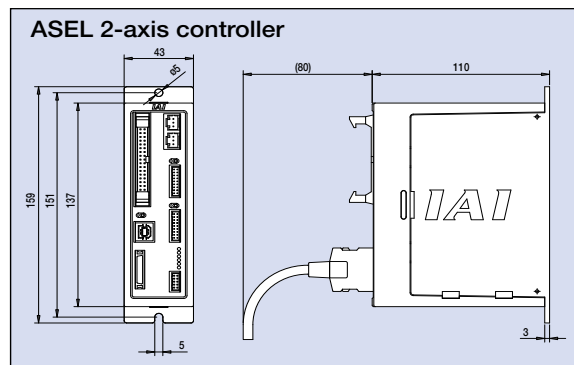
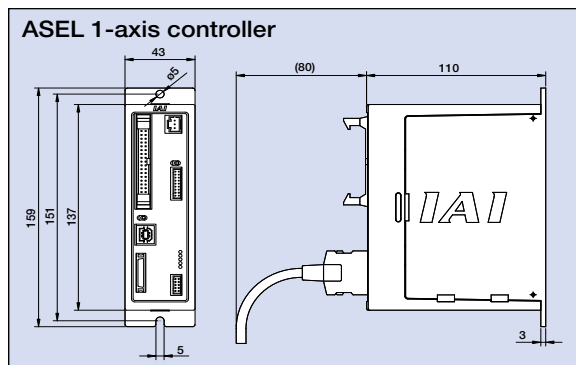

573

ASEL

Name of Each Part

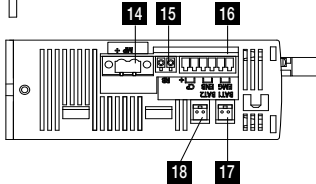
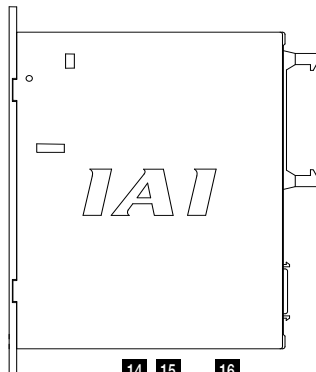
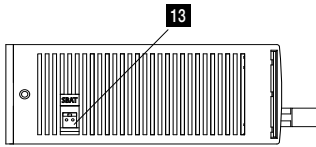
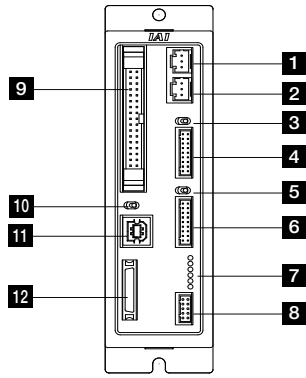

1 Motor connector for axis 1

Connect the motor cable of the axis 1 actuator.

2 Motor connector for axis 2

Connect the motor cable of the axis 2 actuator.

3 Brake switch for axis 1

This switch is used to release the axis brake. Setting it to the left position (RLS side) forcibly releases the brake, while setting it to the right position (NOM side) causes the controller to automatically control the brake.

4 Encoder connector for axis 1

Connect the encoder cable of the axis 1 actuator.

5 Brake switch for axis 2

This switch is used to release the axis brake.

Setting it to the left position (RLS side) forcibly releases the brake, while setting it to the right position (NOM side) causes the controller to automatically control the brake.

6 Encoder connector for axis 2

Connect the encoder cable of the axis 2 actuator.

7 Status indicator LEDs

These LEDs are used to indicate the operating condition of the controller.

The LED status indicators are as follows:

- PWR : Power is input to controller.
- RDY : The controller is ready to perform program operation.
- ALM : The controller is abnormal.
- EMG : An emergency stop is actuated and the drive source is cut off.
- SV1 : The axis 1 actuator servo is on.
- SV2 : The axis 2 actuator servo is on.

8 Panel unit connector

A connector for the panel unit (optional) that displays the controller status and error codes.

9 I/O Connector

A connector for interface I/Os.

34-pin flat cable connector for DIO (24IN/8OUT) interface.

I/O power is also supplied to the controller via this connector (Pin No. 1 and No. 34).

10 Mode switch

This switch is used to specify the running mode of the controller. The left position indicates the MANU (manual operation) mode, while the right position indicates the AUTO (automatic operation) mode. Teaching can only be performed in manual operation, and automatic operation using external I/Os is not possible in the MANU mode.

11 USB connector

A connector for PC connection via USB. If the USB connector is connected, the TP connector is disabled and all communication inputs to the TP connector are cut off.

12 Teaching pendant connector

A half-pitch I/O 26-pin connector that connects a teaching pendant when the running mode is MANU. A special conversion cable is needed to connect a conventional Dsub, 25-pin connector.

13 System-memory backup battery connector

If you wish to retain the various data recorded in the SRAM of the controller even after the power is cut off, connect the necessary battery to this connector. This battery is installed externally to the unit. The controller does not come standard with the battery (Option).

14 Motor power input connector

This connector is used to input the motor power. It consists of a 2-pin, 2-piece connector by Phoenix Contact.

15 External regenerative resistor connector

A connector for the regenerative resistor that must be connected when the built-in regenerative resistor alone does not offer sufficient capacity in high-acceleration/high-load operation, etc.

Whether or not an external regenerative resistor is necessary depends on the conditions of your specific application such as the axis configuration.

16 Control power/System input connector

This connector is used to connect the control power input, emergency stop switch, and enable switch. It consists of a Phoenix Contact 6-pin 2-piece connector.

17 Absolute-data backup battery connector for axis 1

A connector for the battery that backs up absolute data when the actuator uses an absolute encoder. Secure installation of the battery is the customer's responsibility.

18 Absolute-data backup battery connector for axis 2

A connector for the battery that backs up absolute data when the actuator uses an absolute encoder. Secure installation of the battery is the customer's responsibility.

- Slider Type
- Mini
- Standard
- Controllers Integrated
- Rod Type
- Mini
- Standard
- Controllers Integrated
- Table/Arm /Flat Type
- Mini
- Standard
- Gripper/ Rotary Type
- Linear Servo Type
- Cleanroom Type
- Splash-Proof
- Controllers
- PMEC /AMEC
- PSEP /ASEP
- ROBO NET
- ERC2
- PCON
- ACON
- SCON
- PSEL
- ASEL
- SSEL
- XSEL

- Pulse Motor
- Servo Motor (24V)
- Servo Motor (200V)
- Linear Servo Motor

Option

Teaching Pendant

Features This is a teaching device that provides information on functions such as position input, test runs, and monitoring.

Model

Model	Description
SEL-T-J	Standard type with adapter cable
SEL-TD-J	Equipped with a deadman switch and adapter cable

Configuration

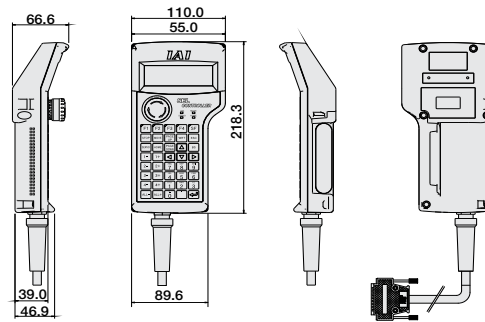
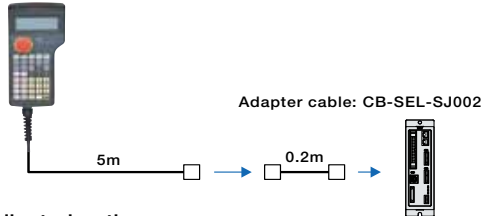

Specifications

Item	SEL-T-J	SEL-TD-J
3-position Enable Switch	No	Yes
ANSI/UL standards	Non-compliant	Compliant
CE mark	Compliant	
Display	20 char. x 4 lines	
Ambient Operating Temp./Humidity	0-40°C 10-90% RH (non-condensing)	
Protective structure	IP54	
Weight	Approx. 0.4kg (not incl. cable)	

SEL-T dedicated options

- Wall-mounting hook Model HK-1
- Strap Model STR-1



PC Software (Windows Only)

Features A startup support software for entering programs/positions, performing test runs, and monitoring. More functions have been added for debugging, and improvements have been made to shorten the start-up time.

Model IA-101-X-MW-J (with RS232C cable + adapter cable)

Configuration

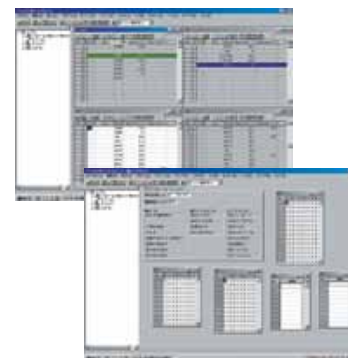
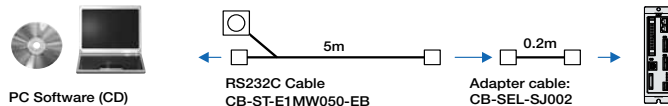

Note:
Only versions 7.0.0.0 and later can be used with the PSEL controller.

Model IA-101-X-USB (with USB cable)

Configuration

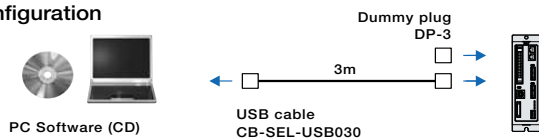

Panel Unit

Features Display device that shows the error code from the controller or the currently running program number.

Model PU-1 (Cable length: 3m)

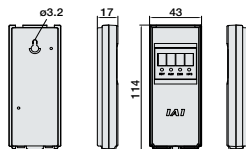

Absolute Data Backup Battery

Features Battery for saving absolute data, when operating an actuator with an absolute encoder. Same as the battery used for system memory backup.

Model AB-5



System Memory Backup Battery

Features This battery is required when you are using global flags in the program and you want to retain your data even after the power has been turned OFF.

Model AB-5-CS (with case)
AB-5 (Standalone battery)



575

ASEL

Option

Dummy Plug

Features When connecting the ASEL controller to a computer with a USB cable, this plug is inserted in the teaching port to shut off the enable circuit.
(Supplied with the PC software IA-101-X-USB)

Model DP-3



USB Cable

Features A cable for connecting the controller to the USB port to a computer. A controller with no USB port (e.g. XSEL) can be connected to the USB port of a computer by connecting an RS232C cable to the USB cable via a USB adapter.
(See PC software IA-101-X-USBMW)

Model CB-SEL-USB030 (Cable length: 3m)



Adapter Cable

Features An adapter cable to connect the D-sub 25-pin connector from the teaching pendant or a PC to the teaching connector (half-pitch) of the ASEL controller.

Model CB-SEL-SJ002 (Cable length: 0.2m)



Spare Parts

When you need spare parts after purchasing the product, such as when replacing a cable, refer to the list of models below.

Motor cable

Model CB-ACS-MA

* The standard motor cable is a robot cable.

* Enter the cable length (L) into . Compatible to a maximum of 20 meters.
Ex.: 080 = 8 m

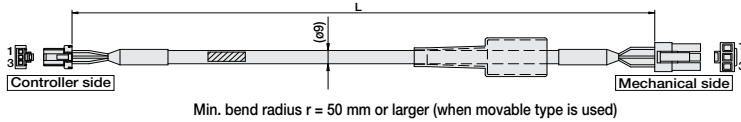

Min. bend radius r = 50 mm or larger (when movable type is used)

Wire	Color	Signal/Pin No.
Red	U	1
White	V	2
Black	W	3

Pin No.	Signal	Color	Wire
1	ENA	Gray	White/Blue
2	ENB	Red	White/Yellow
3	ENB	Black	White/Red
4	ENB	Yellow	White/Black
5	—	—	—
6	—	—	—
7	LS-	Blue	White/Purple
8	—	—	—
9	FG	Ground	Ground
10	ENZ	Pink	Orange
11	ENZ	Purple	Green
12	—	—	—
13	VPS	White	Purple
14	SV	Blue/Red	Gray
15	GND	Green/White	Red
16	LS	Orange	White/Gray
17	BK-	Brown	Blue
18	BK-	Green	Yellow
19	Ground	F.G	1

Encoder cable/Encoder robot cable

Model CB-ACS-PA / **CB-ACS-PA** **-RB**

* The standard cable for the encoder cable is a normal cable. * Enter the cable length (L) into . Compatible to a maximum of 20 meters.
A robot cable can be specified as an option. Ex.: 080 = 8 m

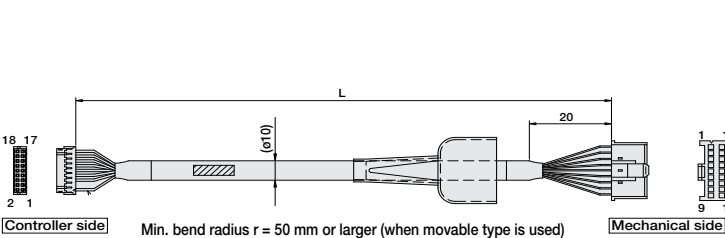

Min. bend radius r = 50 mm or larger (when movable type is used)
* Only the robot cable is to be used in a cable track.

CN2			CN1			
Cable color	Signal	Pin No.	Signal	Cable color	Pin No.	
Robot Cable	Standard Cable	Robot Cable	1	ENA	Gray	White/Blue
White/Purple	Blue	LS+	2	ENB	Red	White/Yellow
White/Gray	Orange	LS-	3	ENB	Black	White/Red
Yellow	Green	BK+	4	ENB	Yellow	White/Black
Blue	Brown	BK-	5	—	—	—
White/Blue	Gray	EMA	6	—	—	—
White/Yellow	Red	YMA	7	LS-	Blue	White/Purple
White/Red	Black	ENB	8	—	—	—
White/Black	Yellow	ENS	9	FG	Ground	Ground
Orange	Pink	ENZ	10	ENZ	Pink	Orange
Green	Purple	ENZ	11	ENZ	Purple	Green
Purple	White	—	12	—	—	—
Gray	Blue/red	VPS	13	VPS	White	Purple
Red	Orange/White	SV	14	SV	Blue/Red	Gray
Black	Green/White	GND	15	GND	Green/White	Red
—	—	—	16	LS	Orange	White/Gray
—	—	—	17	BK-	Brown	Blue
—	—	—	18	BK-	Green	Yellow
—	—	—	19	Ground	F.G	1

Housing : PHDR-18VR (JST)
Contact : SPHD-0011-PO.5 (JST)
Plug housing : XMP-18V (JST)
Socket contact : BXA-0011-PO.6 (JST)
Retainer : XMS-09V (SST)

Motor-Encoder Integrated Cable for RCA2

Model CB-ACS-MPA

* Enter the cable length (L) into . Compatible to a maximum of 20 meters.
Ex.: 080 = 8 m

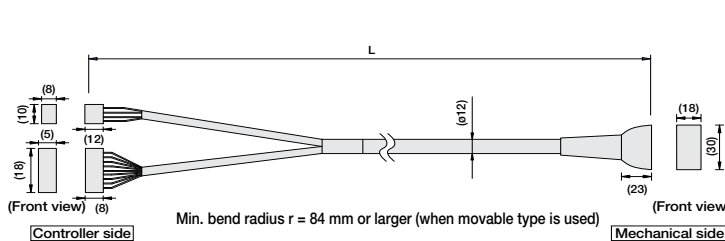

Min. bend radius r = 84 mm or larger (when movable type is used)

Signal	Pin No.	(Wire color)	Pin No.	Signal
U	1	Red	A1	U
V	2	Yellow	B1	V
W	3	Black	B2	W
			B3	NC
			B4	NC
			B5	NC
BK+	16	Yellow (Red ●)	A4	BK+
LS+	18	Yellow (Blue ●)	A5	LS+
LS-	17	Pink (Red ●)	B5	LS-
A+	14	White (Red ●)	A6	A+
A-	13	White (Blue ●)	B6	A-
B+	11	Orange (Red ●)	B7	B+
B-	10	Orange (Blue ●)	B8	B-
Z+	9	Gray (Red ●)	A8	Z+
Z-	8	Gray (Blue ●)	B8	Z-
			A9	—
VPS	7	Orange (Red ● Contiguous)	B9	VPS
VOC	6	Orange (Blue ● Contiguous)	A10	VOC
GND	5	Gray (Red ● Contiguous)	B10	GND
NC		Gray (Blue ● Contiguous)	A11	NC
FG	1	Shield	B11	FG

I/O Flat Cable

Model CB-DS-PIO

* Enter the cable length (L) into . Compatible to a maximum of 10 meters.
Ex.: 080 = 8 m

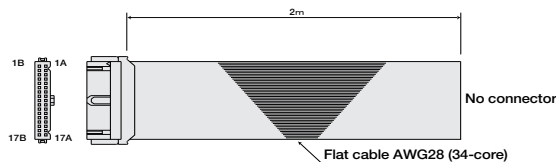

Flat cable AWG28 (34-core)

Pin No.	Color	Wire	Pin No.	Color	Wire
1A	Brown 1	9B	Gray 2	10A	White 2
1B	Red 1	10A	White 2	10B	Black 2
2A	Orange 1	11A	Brown-3	11B	Red 3
2B	Yellow 1	12A	Orange 3	12B	Yellow 3
3A	Green 1	13A	Green 3	13B	Blue 3
3B	Blue 1	14A	Purple 3	14B	Gray 3
4A	Purple 1	15A	White 3	15B	Black 3
4B	Gray 1	16A	Brown-4	16B	Red 4
5A	White 1	17A	Orange 4	17B	Yellow 4
5B	Black 1	17B	Yellow 4		
6A	Brown-2				
6B	Red 2				
7A	Orange 2				
7B	Yellow 2				
8A	Green 2				
8B	Blue 2				
9A	Purple 2				