

RCA/RCA2/RCL Positioner Controller

RCD Positioner Controller

# ACON-CA DCON-CA



## Smart & Small

# Smart & Small

## High functionality and performance is packed in a space-saving, compact body

### Shorter cycle time and greater ease of use achieved by new functions

The offboard tuning function lets you set an optimal gain for the load. Furthermore, the simple absolute function has been extended to support the absolute encoders of the RCA series.

Function	ACON-CA	DCON-CA
Offboard tuning function	○	—
Absolute encoder support	○	—
Simple absolute function	○	—
Vibration damping control function	○	—
Servo monitor function	○	○
Maintenance function (see below)	○	○
Calendar function (see below)	○	○

### DCON-CA

### Micro cylinder capable of multi-point positioning to 512 positions

The ultra-compact micro cylinder is tiny enough to replace a small air cylinder and supports up to 512 positioning points. Advanced position settings are possible for transfer, push-motion and up/down applications.

Micro cylinder with an actuator size of □12 mm

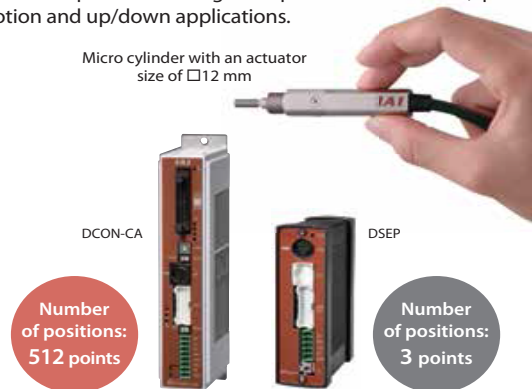

### ACON-CA

### DCON-CA

### Maintenance timings can be checked using the traveled distance calculation function

The total distance travelled by the actuator is calculated and recorded in the controller, and if the preset distance is exceeded, a signal is output from the controller. This function can be used to check when to add grease or perform the next periodic inspection.

"Maintenance/inspection timing notification function" will help you.

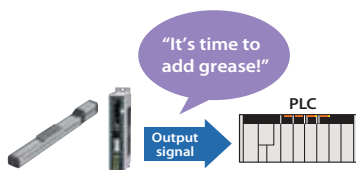

A signal is automatically output to the PLC when the preset maintenance/inspection timing (number of operations or distance travelled) is reached.

### ACON-CA

### DCON-CA

### Alarm timestamps can be retained by the calendar function

The built-in calendar function (clock function) records alarms and other events with timestamps, which helps analyze the causes of troubles should they occur.

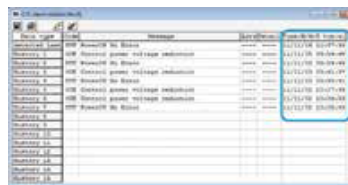

### ACON-CA

### DCON-CA

### Supporting a comprehensive range of field networks

DeviceNet, CC-Link, PROFIBUS-DP, PROFINET-IO, CompoNet, Mechatrolink (\*), EtherCAT and EtherNet/IP are supported. Field network connection allows for wire-saving, direct numerical specification, position number specification and current position read, among others.



(\* Mechatrolink w/o CE conformity etc.)

I/O type	PIO type	Pulse-train type	Field network type (*) Mechatrolink w/o CE conformity yet.								
			DeviceNet	CC-Link	PROFIBUS-DP	CompoNet	MECHATROLINK	EtherCAT	EtherNet/IP	PROFINET-IO	
<b>I/O type model number</b>	NP/PN	PLN/PLP	DV	CC	PR	CN	ML	EC	EP	PRT	
ACON-CA	Incremental specification	○	○	○	○	○	○	○	○	○	
	Simple absolute specification	With absolute battery ("AB")	○	—	○	○	○	○	○	○	○
		With absolute battery unit ("ABU")	○	—	○	○	○	○	○	○	○
		No absolute battery ("ABUN")	○	—	○	○	○	○	○	○	○
Absolute specification	○	—	○	○	○	○	○	○	○		
DCON-CA	Incremental specification	○	○	○	○	○	○	○	○	○	

(Note) The simple absolute specification controllers can operate RCA or RCA2 series incremental specification actuators similar to absolute specification actuators. The absolute specification controller can operate RCA series absolute specification actuators.

Model Number

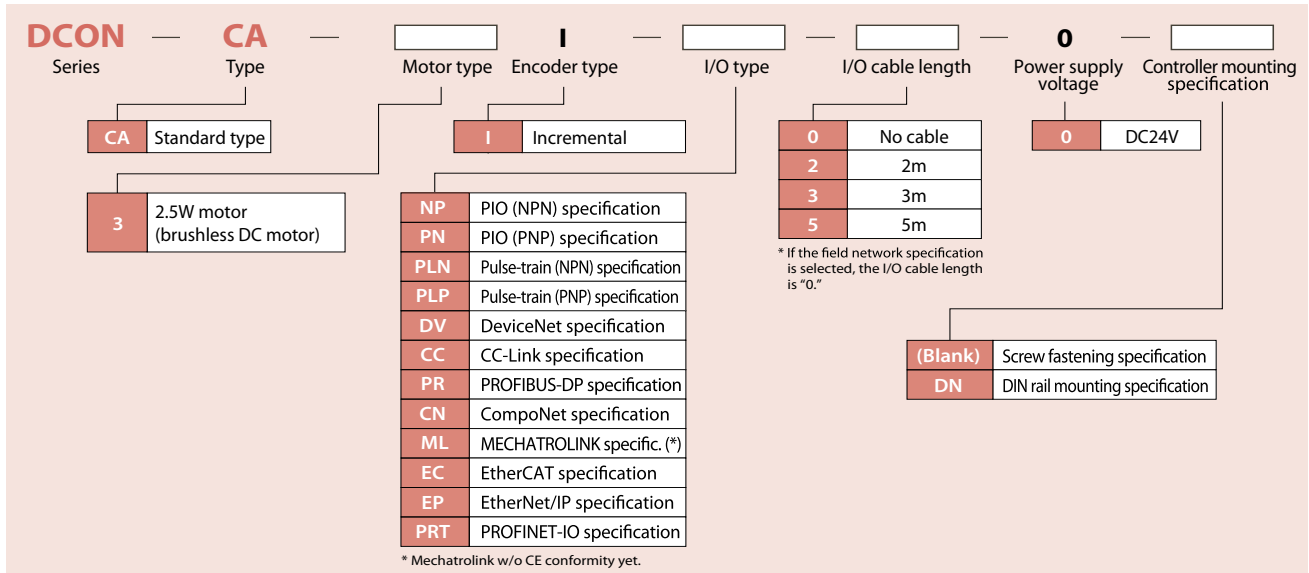
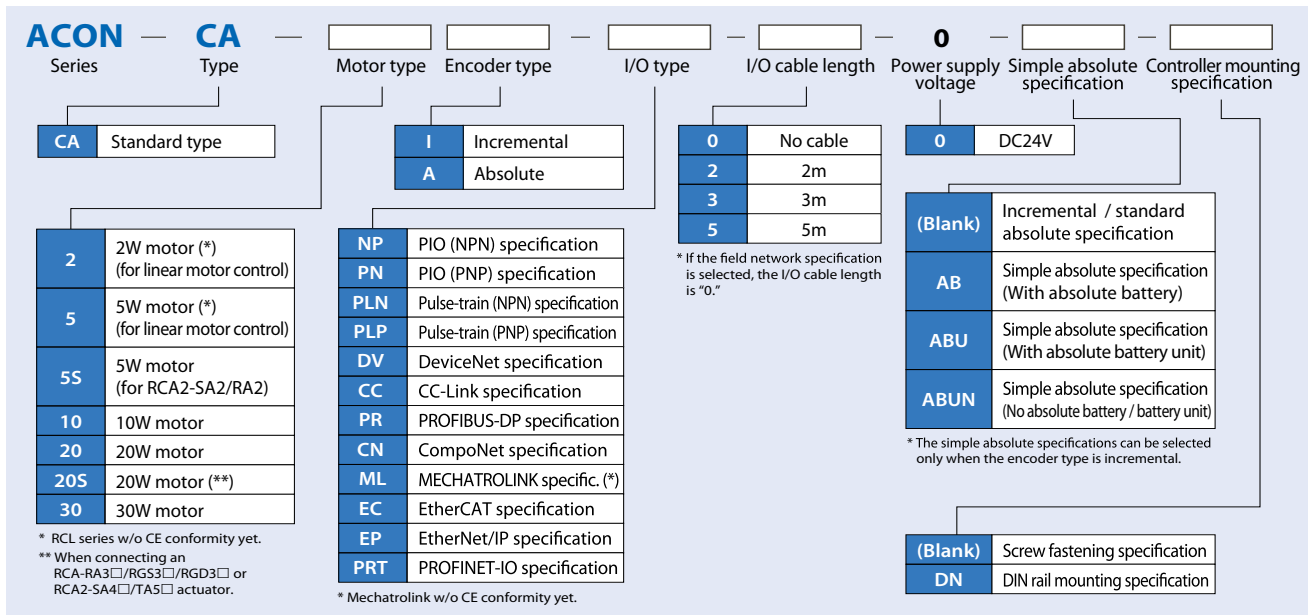

## ACON Configuration

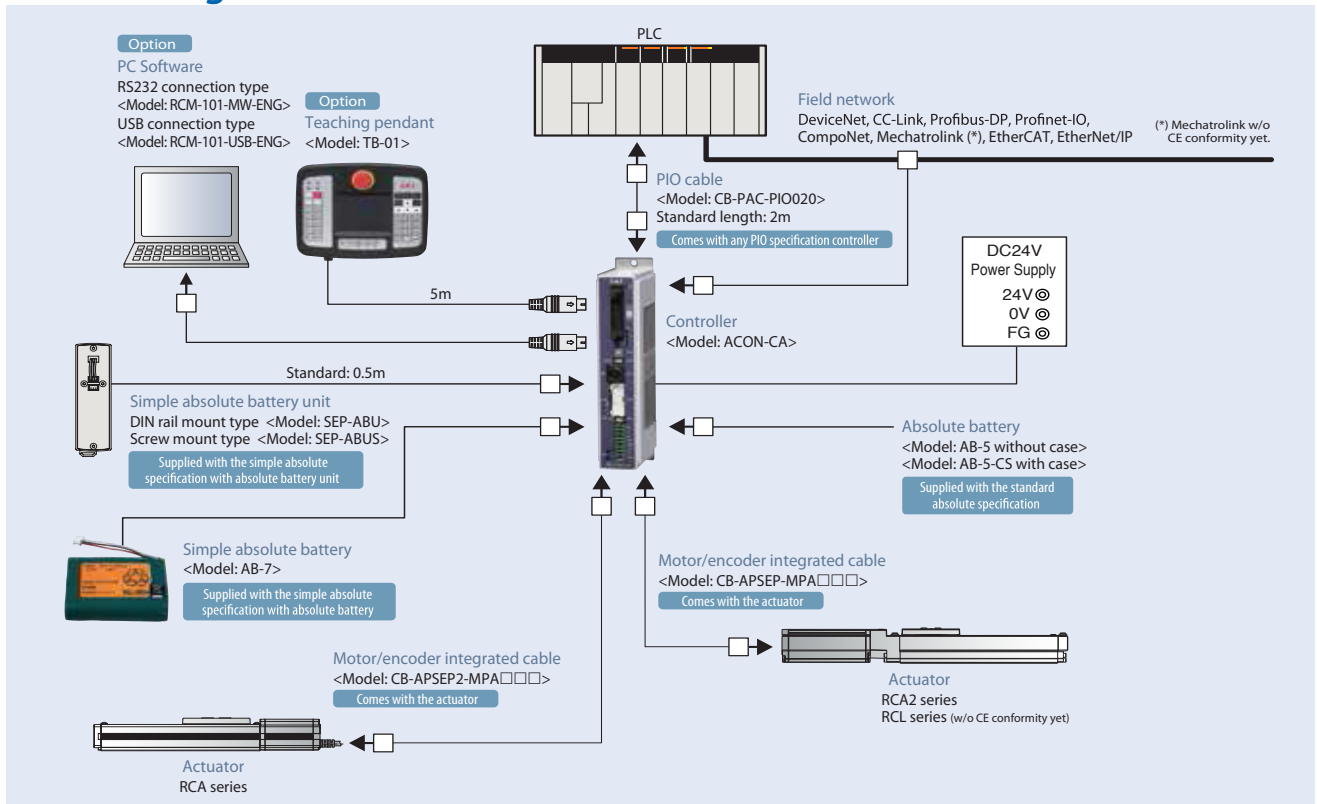

■ If the RCA/RCA2 actuator is operated with the ACON-CA, specify "A5" as the applicable controller for the RCA/RCA2.

RCA(2)	—	SAS5	—	I	—	20	—	12	—	500	—	A5	—	M
Series		Type		Encoder		Motor		Lead		Stroke		Applicable controller		Cable length

## DCON Configuration

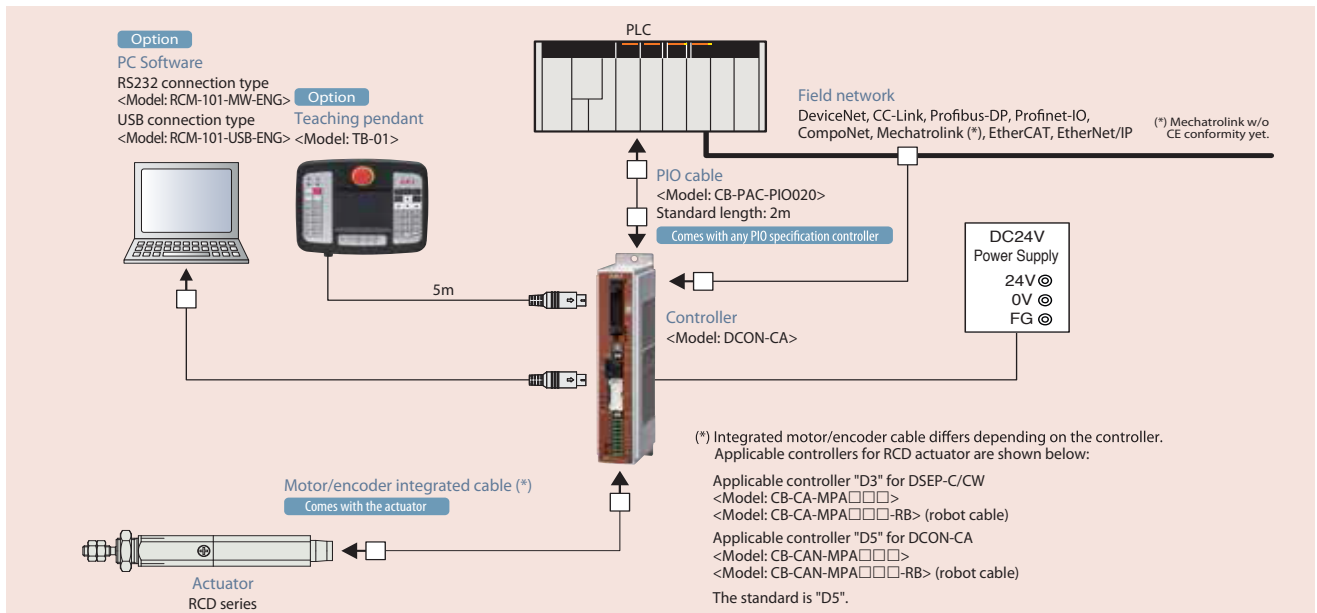

■ When the actuator RCD is moved by DCON-CA, the call-out for the applicable controller of RCD is "D5".

RCD	—	RA1D	—	I	—	3	—	2	—	10	—	D5	—	M
Series		Type		Encoder		Motor		Lead		Stroke		Applicable controller		Cable length

3



**Input Part** External Input Specifications

Item	Specification
Input voltage	24 VDC ± 10%
Input current	5mA, 1 circuit
ON/OFF voltage	ON voltage: 18 VDC min. OFF voltage: 6 VDC max.

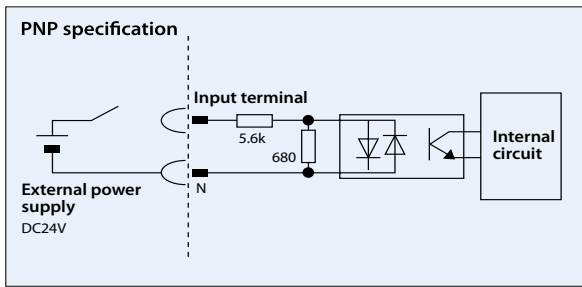
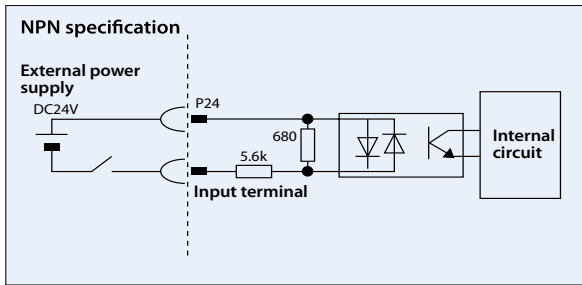

**Output Part** External Output Specifications

Item	Specification
Load voltage	24 VDC
Maximum load current	50mA, 1 circuit
Leak current	2mA max. per point

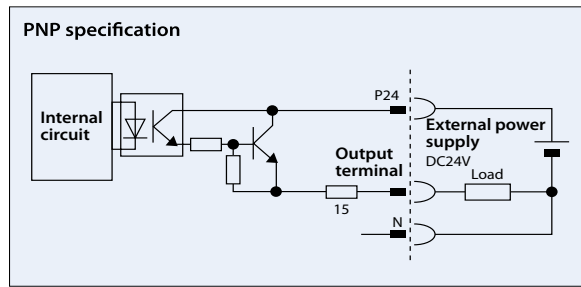
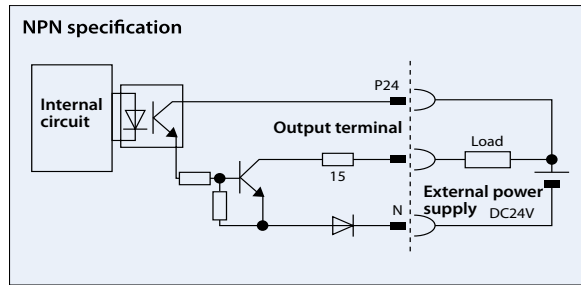

**Types of PIO Patterns (Control Patterns) (Common to ACON-CA/DCON-CA)**

**This controller supports seven types of control methods. Select in Parameter No. 25, "PIO pattern selection" the PIO pattern that best suits your purpose of use.**

Type	Set value of Parameter No. 25	Mode	Overview
PIO pattern 0	0 (factory setting)	Positioning mode (standard type)	<ul style="list-style-type: none"> <li>Number of positioning points: 64 points</li> <li>Position number command: Binary Coded</li> <li>Zone signal output*: 1 point</li> <li>Position zone signal output*: 1 point</li> </ul>
PIO pattern 1	1	Teaching mode (teaching type)	<ul style="list-style-type: none"> <li>Number of positioning points: 64 points</li> <li>Position number command: Binary Coded</li> <li>Position zone signal output*: 1 point</li> <li>Jog (inching) operation using PIO signals is supported.</li> <li>Current position data can be written to the position table using PIO signals.</li> </ul>
PIO pattern 2	2	256-point mode (256 positioning points)	<ul style="list-style-type: none"> <li>Number of positioning points: 256 points</li> <li>Position number command: Binary Coded</li> <li>Position zone signal output*: 1 point</li> </ul>
PIO pattern 3	3	512-point mode (512 positioning points)	<ul style="list-style-type: none"> <li>Number of positioning points: 512 points</li> <li>Position number command: Binary Coded</li> <li>No zone signal output</li> </ul>
PIO pattern 4	4	Solenoid valve mode 1 (7-point type)	<ul style="list-style-type: none"> <li>Number of positioning points: 7 points</li> <li>Position number command: Individual number signal ON</li> <li>Zone signal output*: 1 point</li> <li>Position zone signal output*: 1 point</li> </ul>
PIO pattern 5	5	Solenoid valve mode 2 (3-point type)	<ul style="list-style-type: none"> <li>Number of positioning points: 3 points</li> <li>Position number command: Individual number signal ON</li> <li>Completion signal: A signal equivalent to a LS (limit switch) signal can be output.</li> <li>Zone signal output*: 1 point</li> <li>Position zone signal output*: 1 point</li> </ul>
PIO pattern 6 (Note)	6	Pulse-train control mode	<ul style="list-style-type: none"> <li>Differential pulse input (200 kpps max.)</li> <li>Home return function</li> <li>Zone signal output*: 2 points</li> <li>No feedback pulse output</li> </ul>

\*1 Zone signal output: A desired zone is set by Parameter Nos. 1 and 2 or 23 and 24, and the set zone always remains effective once home return has completed.

\*2 Position zone signal output: This function is available as part of a position number. A desired zone is set in the position table and becomes effective only when the corresponding position is specified, but not with commands specifying other positions.

(Note) Pulse Train Control Model is available only if the pulse train control type is indicated (from ACON/DCON-CA-\*PLN and -PLP) at the time of purchase.

The table below lists the signal assignments for the I/O flat cable under different PIO patterns. Connect an external device (such as a PLC) according to this table.

Pin number	Category	PIO function	Parameter No. 25, "PIO pattern selection"					
			0	1	2	3	4	5
			Positioning mode	Teaching mode	256-point mode	512-point mode	Solenoid valve mode 1	Solenoid valve mode 2
		Number of positioning points	64 points	64 points	256 points	512 points	7 points	3 points
	Input	Home return signal	○	○	○	○	○	—
		Jog signal	—	○	—	—	—	—
		Teaching signal (writing of current position)	—	○	—	—	—	—
		Brake release	○	—	○	○	○	○
		Moving signal	○	○	—	—	—	—
	Output	Zone signal	○	△ (Note 1)	△ (Note 1)	—	○	○
		Position zone signal	○	○	○	—	○	○
1A	24V		P24					
2A	24V		P24					
3A	Pulse input		—					
4A			—					
5A	Input	IN0	PC1	PC1	PC1	PC1	ST0	ST0
6A		IN1	PC2	PC2	PC2	PC2	ST1	ST1(JOG+)
7A		IN2	PC4	PC4	PC4	PC4	ST2	ST2 (Note 2)
8A		IN3	PC8	PC8	PC8	PC8	ST3	—
9A		IN4	PC16	PC16	PC16	PC16	ST4	—
10A		IN5	PC32	PC32	PC32	PC32	ST5	—
11A		IN6	—	MODE	PC64	PC64	ST6	—
12A		IN7	—	JISL	PC128	PC128	—	—
13A		IN8	—	JOG+	—	PC256	—	—
14A		IN9	BKRL	JOG-	BKRL	BKRL	BKRL	BKRL
15A		IN10	RMOD	RMOD	RMOD	RMOD	RMOD	RMOD
16A		IN11	HOME	HOME	HOME	HOME	HOME	—
17A		IN12	*STP	*STP	*STP	*STP	*STP	—
18A		IN13	CSTR	CSTR/PWRT	CSTR	CSTR	—	—
19A		IN14	RES	RES	RES	RES	RES	RES
20A		IN15	SON	SON	SON	SON	SON	SON
1B	Output	OUT0	PM1(ALM1)	PM1(ALM1)	PM1(ALM1)	PM1(ALM1)	PE0	LSO
2B		OUT1	PM2(ALM2)	PM2(ALM2)	PM2(ALM2)	PM2(ALM2)	PE1	LS1(TRQS)
3B		OUT2	PM4(ALM4)	PM4(ALM4)	PM4(ALM4)	PM4(ALM4)	PE2	LS2 (Note 2)
4B		OUT3	PM8(ALM8)	PM8(ALM8)	PM8(ALM8)	PM8(ALM8)	PE3	—
5B		OUT4	PM16	PM16	PM16	PM16	PE4	—
6B		OUT5	PM32	PM32	PM32	PM32	PE5	—
7B		OUT6	MOVE	MOVE	PM64	PM64	PE6	—
8B		OUT7	ZONE1	MODES	PM128	PM128	ZONE1	ZONE1
9B		OUT8 (Note 1)	PZONE/ZONE2	PZONE/ZONE1	PZONE/ZONE1	PM256	PZONE/ZONE2	PZONE/ZONE2
10B		OUT9	RMDS	RMDS	RMDS	RMDS	RMDS	RMDS
11B		OUT10	HEND	HEND	HEND	HEND	HEND	HEND
12B		OUT11	PEND	PEND/WEND	PEND	PEND	PEND	—
13B		OUT12	SV	SV	SV	SV	SV	SV
14B		OUT13	*EMGS	*EMGS	*EMGS	*EMGS	*EMGS	*EMGS
15B		OUT14	*ALM	*ALM	*ALM	*ALM	*ALM	*ALM
16B	OUT15	*BALM (Note 3)/ALML	*BALM (Note 3)/ALML	*BALM (Note 3)/ALML	*BALM (Note 3)/ALML	*BALM (Note 3)/ALML	*BALM (Note 3)/ALML	
17B	Pulse input		—					
18B			—					
19B	0V		N					
20B	0V		N					

(Note) In the table above, asterisk \* symbol accompanying each code indicates a negative logic signal. PM1 to PM8 are alarm binary code output signals that are used when an alarm generates.  
 (Note 1) In all PIO patterns other than 3, this signal can be switched with PZONE by setting Parameter No. 149 accordingly.  
 (Note 2) The setting will not become effective until the origin return is completed.  
 (Note 3) This signal is dedicated only for ACON-CA.

**Reference) Negative logic signal**

Signals denoted by \* are negative logic signals. Negative logic input signals are processed when turned OFF. Negative logic output signals normally remain ON while the power is supplied, and turn OFF when the signal is output.

Note: The names of the signals above inside () are functions before the unit returns home.

■ Host Unit = Differential Type

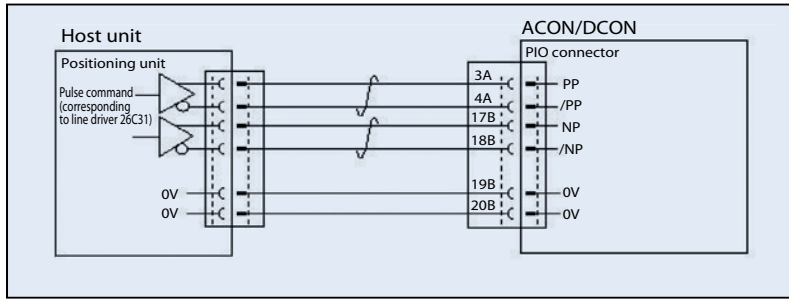

■ Host Unit = Open Collector Type The AK-04 (optional) is needed to input pulses.

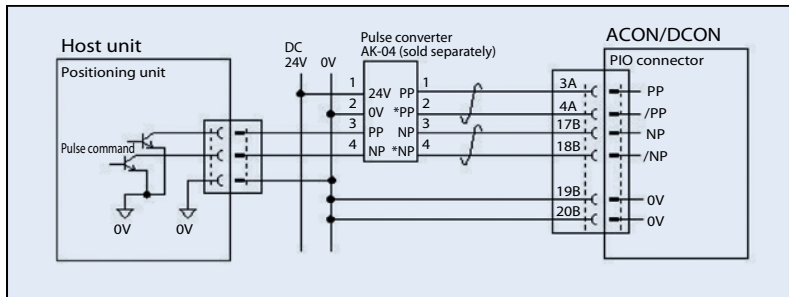

■ Pulse Converter: AK-04

Open-collector command pulses are converted to differential command pulses.  
Use this converter if the host controller outputs open-collector pulses.

■ Specification

Item	Specification
Input power	24 VDC ±10% (max. 50mA)
Input pulse	Open-collector (Collector current: max. 12mA)
Input frequency	200kHz or less
Output pulse	Differential output (max. 10mA) (26C31 or equiv.)
Mass	10g or less (excluding cable connectors)
Accessories	37104-3122-000L (e-CON connector) x 2 Applic. wire: AWG No. 24~26

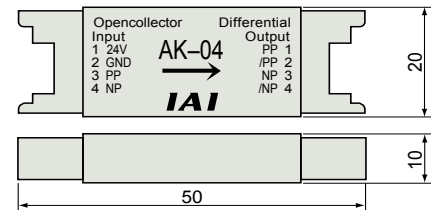

**Caution:** Use the same power supply for open collector input/output to/from the host and for the AK-04.

Command Pulse Input Patterns

	Command pulse-train pattern	Input terminal	Forward	Reverse	
Negative logic	Forward pulse-train	PP-/PP			
	Reverse pulse-train	NP-/NP			
	A forward pulse-train indicates the amount of motor rotation in the forward direction, while a reverse pulse-train indicates the amount of motor rotation in the reverse direction.				
	Pulse-train	PP-/PP			
	Sign	NP-/NP	Low	High	
	The command pulses indicate the amount of motor rotation, while the sign indicates the rotating direction.				
Positive logic	Forward pulse train	PP-/PP			
	Reverse pulse-train	NP-/NP			
	Command phases A and B having a 90° phase difference (multiplier is 4) indicate the amount of rotation and the rotating direction.				
	Pulse-train	PP-/PP			
	Sign	NP-/NP	High	Low	
	The command pulses indicate the amount of motor rotation, while the sign indicates the rotating direction.				
	Phase A/B pulse-train	PP-/PP			
		NP-/NP			

The table below lists the signal assignments for the flat cable in the pulse-train control mode. Connect an external device (such as PLC) according to this table.

Pin number	Category	I/O number	Signal abbreviation	Signal name	Function description
1A	24V		P24	Power supply	I/O power supply +24 V
2A	24V		P24	Power supply	I/O power supply +24 V
3A	Pulse input		PP	Differential pulse-train input (+)	Differential pulses are input from the host. Up to 200 kpps can be input.
4A			/PP	Differential pulse-train input (-)	
5A	Input	IN0	SON	Servo ON	The servo is ON while this signal is ON, and OFF while the signal is OFF.
6A		IN1	RES	Reset	Present alarms are reset when this signal is turned ON.
7A		IN2	HOME	Home return	Home return operation is performed when this signal is turned ON.
8A		IN3	TL	Torque limit selection	When this signal is turned ON, the motor torque is limited to the value set by the parameter.
9A		IN4	CSTP	Forced stop	The actuator is forcibly stopped when this signal has remained ON for 16 ms or more. The actuator decelerates to a stop at the torque set in the controller and the servo turns OFF.
10A		IN5	DCLR	Deviation counter clear	This signal clears the deviation counter.
11A		IN6	BKRL	Forced brake release	The brake is forcibly released.
12A		IN7	RMOD	Operation mode switching	The operation mode can be switched when the MODE switch on the controller is set to AUTO. (AUTO when this signal is OFF, and to MANU when the signal is ON.)
13A		IN8	NC	—	Not used
14A		IN9	NC	—	Not used
15A		IN10	NC	—	Not used
16A		IN11	NC	—	Not used
17A		IN12	NC	—	Not used
18A		IN13	NC	—	Not used
19A		IN14	NC	—	Not used
20A	IN15	NC	—	Not used	
1B	Output	OUT0	PWR	System ready	This signal turns ON when the controller becomes ready after the main power has been turned on.
2B		OUT1	SV	Servo ON status	This signal turns ON when the servo is ON.
3B		OUT2	INP	Positioning complete	This signal turns ON when the amount of remaining travel pulses in the deviation counter falls within the in-position band.
4B		OUT3	HEND	Home return complete	This signal turns ON upon completion of home return.
5B		OUT4	TLR	Torque limited	This signal turns ON upon reaching the torque limit while the torque is limited.
6B		OUT5	*ALM	Controller alarm status	This signal turns ON when the controller is normal, and turns OFF when an alarm generates.
7B		OUT6	*EMGS	Emergency stop status	This signal turns ON when the emergency stop of the controller is cancelled, and turns OFF when an emergency stop is actuated.
8B		OUT7	RMDS	Operation mode status	The operation mode status is output. This signal turns ON when the controller is in the manual mode.
9B		OUT8	ALM1	Alarm code output signal	An alarm code is output when an alarm generates. For details, refer to the operation manual.
10B		OUT9	ALM2		
11B		OUT10	ALM4		
12B		OUT11	ALM8		
13B		OUT12	*ALML		
14B		OUT13	NC	—	Not used
15B		OUT14	ZONE1	Zone signal 1	This signal turns ON when the current position of the actuator falls within the parameter-set range.
16B	OUT15	ZONE2	Zone signal 2		
17B	Pulse input		NP	Differential pulse-train input (+)	Differential pulses are input from the host. Up to 200 kpps can be input.
18B			/NP	Differential pulse-train input (-)	
19B	0V		N	Power supply	I/O power supply 0 V
20B	0V		N	Power supply	I/O power supply 0 V

(Note) \* indicates a negative logic signal. Negative logic signals are normally ON while the power is supplied, and turn OFF when the signal is output.

If the ACON-CA/DCON-CA is controlled via a field network, you can select one of the following five modes to operate the actuator.

Take note that the required data areas on the PLC side vary depending on the mode.

■ Explanation of Modes

Mode	Description
0 Remote I/O mode	In this mode, the actuator is operated by controlling the ON/OFF of bits via the network, just like with the PIO specification. The number of positioning points and functions vary with each of the operation patterns (PIO patterns) that can be set by the controller's parameter.
1 Position/simple direct numerical mode	The target position is specified by directly entering a value, while other operating conditions (speed, acceleration, etc.) are set by specifying the desired position number corresponding to the desired operating conditions already input to the position data table.
2 Half direct numerical mode	The actuator is operated by specifying the speed, acceleration/deceleration and push current, in addition to the target position, by directly entering values.
3 Full direct numerical mode	The actuator is operated by specifying the target position, speed, acceleration/deceleration, push current control value, etc., by directly entering values. The current position, current speed, command current, etc., can also be read.
4 Remote I/O mode 2	Same as the above remote I/O mode, plus the current position read function and command current read function.

■ Required Data Size for Each Network

(\*) Mechatrolink w/o CE conformity yet.

	DeviceNet	CC-Link	PROFIBUS-DP	CompoNet	MECHATROLINK (*)	EtherCAT	EtherNet/IP	PROFINET
0 Remote I/O mode	1CH	1 station	2 bytes	2 bytes	α	2 bytes	2 bytes	2 bytes
1 Position/simple direct numerical mode	4CH	1 station	8 bytes	8 bytes	α	8 bytes	8 bytes	8 bytes
2 Half direct numerical mode	8CH	2 stations	16 bytes	16 bytes	α	16 bytes	16 bytes	16 bytes
3 Full direct numerical mode	16CH	4 stations	32 bytes	32 bytes	α	32 bytes	32 bytes	32 bytes
4 Remote I/O mode 2	6CH	1 station	12 bytes	12 bytes	α	12 bytes	12 bytes	12 bytes

\* "α" indicates that no required data size is set for MECHATROLINK I and II.

■ List of Functions by Operation Mode

	Remote I/O mode	Position/simple direct numerical mode	Half direct numerical mode	Full direct numerical mode	Remote I/O mode 2
Number of positioning points	512 points	768 points	Not limited	Not limited	512 points
Operation by direct position data specification	—	○	○	○	—
Direct speed/acceleration specification	—	—	○	○	—
Push-motion operation	○	○	○	○	○
Current position read	—	○	○	○	○
Current speed read	—	—	○	○	—
Operation by position number specification	○	○	—	—	○
Completed position number read	○	○	—	—	○

\* "○" indicates that the operation is supported, and "—" indicates that it is not supported.

# External Dimensions (Common to ACON-CA/DCON-CA)

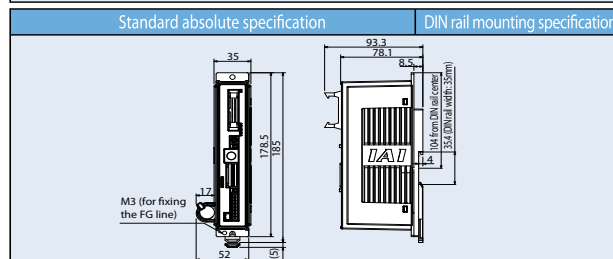
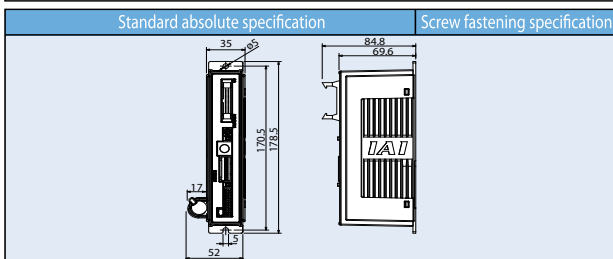
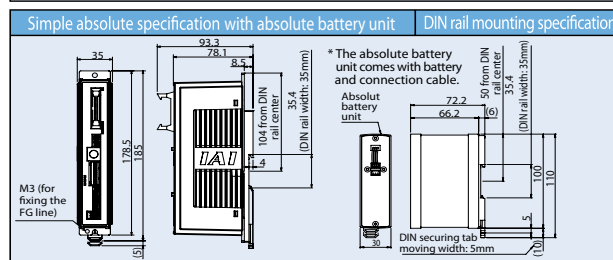
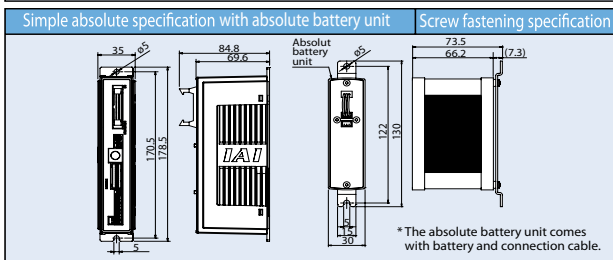
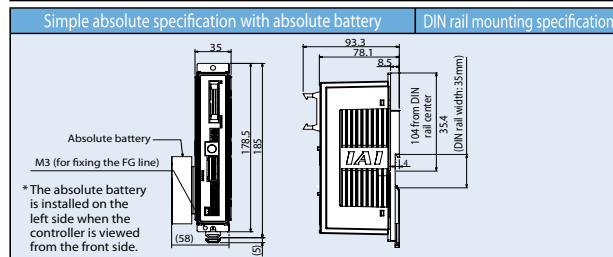
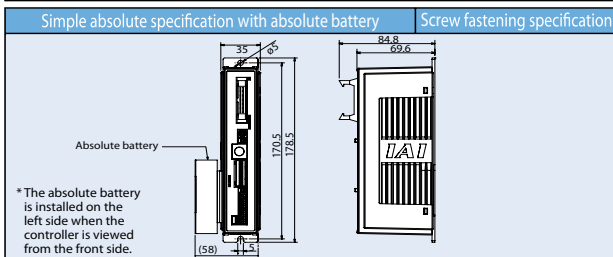
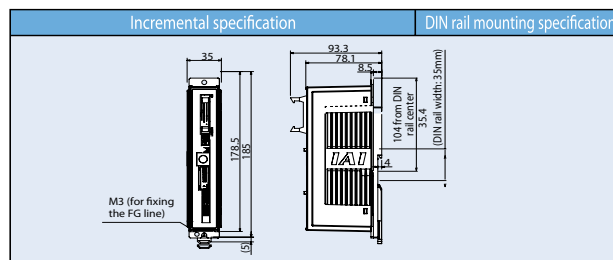
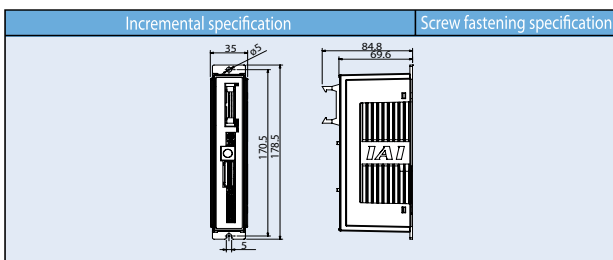

## Specification Table

Item	ACON-CA	DCON-CA
Number of controlled axes	1 axis	
Power supply voltage	24VDC ± 10%	
Rush current from power supply	10 A (Rush current limiting circuit is provided)	
Cooling method	Natural air cooling	
Simple tuning	Available (RCA only)	Not available
Support of absolute function	Standard absolute, simple absolute	Not available
Backup memory	FRAM (256 kbit) Number of rewrite: No limit	
I/O power supply	24VDC ± 10%	
Number of I/Os	16IN / 16OUT	
Pulse-train specification	Available (differential type only; AK-04 is used for the open-collector type)	
Fieldbus specification	Available	
Serial communication	RS485: 1 channel (conforming to Modbus protocol)	
Ambient operating temperature	0 to 40°C	
Ambient operating humidity	85% RH or less (non-condensing)	
Protection degree	IP20	
Weight	Incremental spec.: 230 g, simple absolute spec.: 240 g (incl. battery; 430 g) Standard absolute spec.: 240 g (including battery; 260 g)	Incremental specification: 230 g

## Motor power capacity

	Motor type	Standard/High-acceleration		Power-saving		
		Rated [A]	Max. [A]	Rated [A]	Max. [A]	
ACON-CA	RCA/RCA2	10W	1.3	4.4	1.3	2.5
		20W	1.3	4.4	1.3	2.5
		30W	1.3	4	1.3	2.2
		20W(20S)	1.7	5.1	1.7	3.4
	RCL (w/o CE conformity yet)	2W	0.8	4.6	—	—
		5W	1	6.4	—	—
DCON-CA	RCD	10W	1.3	6.4	—	—
		3W	0.7	1.5	—	—



## Teaching pendant

■ Summary A teaching device that has position input, test operation, monitoring function, etc.

■ Model **TB-01-□**

■ Setting

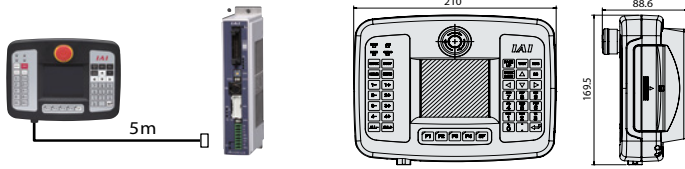

Specifications

Rated voltage	24 VDC
Power consumption	3.6 W or less (150 mA or less)
Ambient operating temperature	0 to 50°C
Ambient operating humidity	20 to 85%RH (Non-condensing)
Environmental resistance	IP40 (initial state)
Weight	507 g (TB-01 only)

■ Types This teaching pendant supports all of the controllers listed below, but the cable(s) must be selected according to each controller.  
Model kit: teaching pendant + cable set (model number of teaching pendant: TB-01-N-ENG)

Model kit	Supplied cable	Applicable controller
TB-01-SC-ENG	Position controller cable	Position controller
	Program controller cable + conversion cable	PSEL, ASEL, SSEL, XSEL-K/P/Q/R/S, TT, TTA
TB-01-C-ENG	Position controller cable	Position controller

## PC software (Windows only)

■ Summary A startup support software for inputting positions, performing test runs, and monitoring. With enhancements for adjustment functions, the startup time is shortened.

■ Model **RCM-101-MW-ENG** (External device communication cable + RS232 conversion unit)

■ Setting

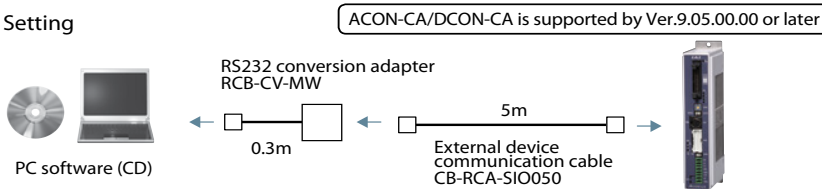

■ Model **RCM-101-USB-ENG** (External device communication cable + USB converter adaptor + USB cable)

■ Setting

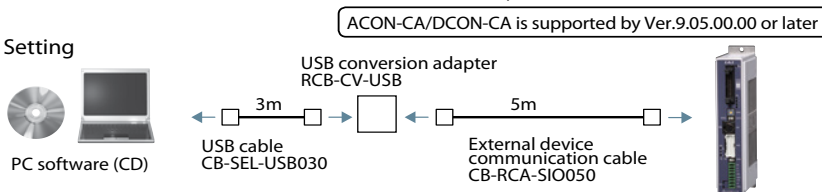

## Absolute Battery Unit

■ Summary Battery unit that comes with a simple absolute controller, used to back up the current controller position.

■ Model **SEP-ABU** (DIN rail mounting specification)

**SEP-ABUS** (screw fastening specification)

■ Specifications

Item	SEP-ABU / SEP-ABUS
Operating ambient temperature, humidity	0 to 40°C (desirably around 20°C), 95% RH or below (non-condensing)
Operating ambience	Free from corrosive gases
Absolute battery	Model: AB-7 (Ni-MH battery / Life: ca. 3 years)
Controller / absolute battery unit link cable	Model: CB-APSEP-AB005 (Length: 0.5m)
Mass	Battery box: 140g or less Battery: 140g or less

■ External Dimensions (Refer to P.9)

## Replacement battery (simple absolute specification)

■ Summary The replacement battery for the simple absolute specification type

■ Absolute data retention time Up to 20 days

■ Model **AB-7**



## Replacement battery (standard absolute specification)

■ Summary The replacement battery for the standard absolute specification type

■ Absolute data retention time Up to 2 years

■ Model **AB-5**



Maintenance parts

Integrated Motor-Encoder Robot Cable for [RCA]-[ACON-CA] Connection

Model **CB-ASEP2-MPA**□□□□

\* The default specification of this cable is robot cable.

\* Please indicate cable length (L) in □□□□, maximum 20m. Example: 080=8m

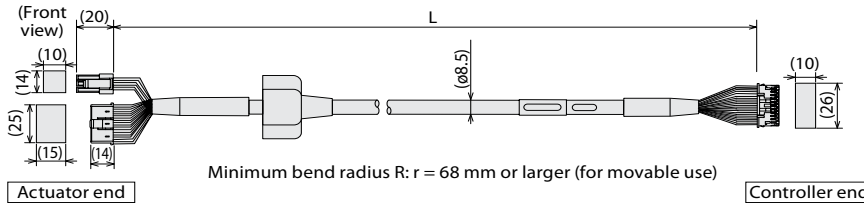

Actuator end Pin number		Controller end Pin number
1	Red [U]	1
2	Yellow [V]	2
	NC	3
	NC	4
3	Black [W]	5
	NC	6
18	Orange [BK+]	7
17	Gray [BK-]	8
7	Black [LS+]	9
16	Brown [LS-]	10
1	White [A+]	11
2	Yellow [A-]	12
3	Red [B+]	13
4	Green [B-]	14
10	Black (identification tape) [Z+]	15
11	Brown (identification tape) [Z-]	16
14	White (identification tape) [VCC]	17
13	Yellow (identification tape) [VPS]	18
15	Red (identification tape) [GND]	19
6	Green (ident. tape) [Preparation]	20
5	NC	21
8	NC	22
12	NC	23
9	Shield [FG]	24

Integrated Motor-Encoder Robot Cable for [RCA2/RCL]-[ACON-CA] Connection

Model **CB-APSEP-MPA**□□□□

\* The default specification of this cable is robot cable.

\* Please indicate cable length (L) in □□□□, maximum 20m. Example: 080=8m

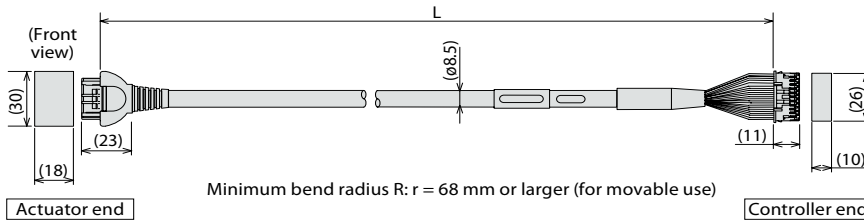

Actuator end Pin number		Controller end Pin number
A1	(PCON) (ACON)	1
B2	Black [ØA] (U)	2
A2	White [VMM] (V)	3
B2	Brown [ØA] (W)	4
A3	Green [ØB] (-)	5
A3	Yellow [VMM] (-)	6
B3	Red [ØB] (-)	7
A4	Orange [LS+] [BK+]	8
B4	Gray [LS-] [BK-]	9
A6	White [-] [A+]	11
B6	Yellow [-] [A-]	12
A7	Red [A+] [B+]	13
B7	Green [A-] [B-]	14
A8	Black [B+] [Z+]	15
B8	Brown [B-] [Z-]	16
A5	Black (identification tape) [BK+] [LS+]	17
B5	Brown (identification tape) [BK-] [LS-]	18
A9	Green (identification tape) [GND+] [VPS]	19
B9	Red (identification tape) [VCC] [VCC]	20
A10	White (identification tape) [VCC] [VCC]	21
B10	Yellow (identification tape) [GND] [GND]	22
A11	NC	23
B11	Shield [FG] (FG)	24

Integrated Motor-Encoder Cable / Integrated Motor-Encoder Robot Cable for [RCD]-[DCON-CA] Connection

Model **CB-CAN-MPA**□□□□ / **CB-CAN-MPA**□□□□-RB

\* Please indicate cable length (L) in □□□□, maximum 20m. Example: 080=8m

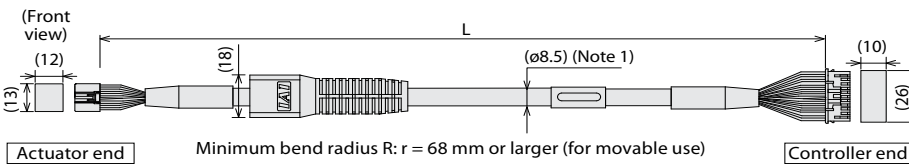

\* Robot cables are cables resistant to flexing forces. If the cable must be guided in a cable track, use a robot cable.

Pin no.	Signal name	Pin no.	Signal name
3	øA/U	1	øA/U
5	VMM/V	2	VMM/V
10	ø A/W	3	ø A/W
9	øB/-	4	øB/-
4	VMM/-	5	VMM/-
15	ø B/-	6	ø B/-
8	LS+/BK+	7	LS+/BK+
14	LS-/BK-	5	LS-/BK-
12	-/A+	11	-/A+
17	-/A-	12	-/A-
1	A+/B+	13	A+/B+
6	A-/B-	14	A-/B-
11	B+/Z+	15	B+/Z+
16	B-/Z-	16	B-/Z-
20	BK+/LS+	9	BK+/LS+
2	BK-/LS-	10	BK-/LS-
7	LS_GND	17	LS_GND
15	VPS	19	VPS
13	VCC	15	VCC
19	GND	20	GND
22	-	21	-
23	-	22	-
24	FG	23	FG
		24	FG

(Note 1) If the cable length is 5 m or more, the diameter of the non-robot cable becomes ø9.1, while that of the robot cable becomes ø10.

I/O Flat Cable

Model **CB-PAC-PIO**□□□□

\* Please indicate cable length (L) in □□□□, maximum 10m. Example: 080=8m

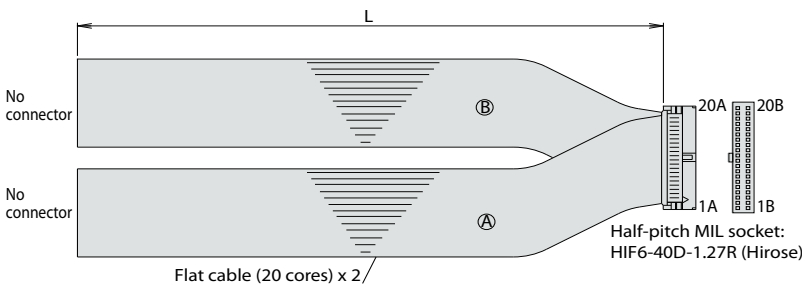

HIF6-40D-1.27R

No.	Signal name	Cable color	Wiring	No.	Signal name	Cable color	Wiring
1A	24V	Brown-1		18	OUT0	Brown-3	
2A	24V	Red-1		2B	OUT1	Red-3	
3A	Pulse	Orange-1		3B	OUT2	Orange-3	
4A	Input	Yellow-1		4B	OUT3	Yellow-3	
5A	IN0	Green-1		5B	OUT4	Green-3	
6A	IN1	Blue-1		6B	OUT5	Blue-3	
7A	IN2	Purple-1		7B	OUT6	Purple-3	
8A	IN3	Gray-1		8B	OUT7	Gray-3	
9A	IN4	White-1		9B	OUT8	White-3	
10A	IN5	Black-1		10B	OUT9	Black-3	
11A	IN6	Brown-2		11B	OUT10	Brown-4	
12A	IN7	Red-2		12B	OUT11	Red-4	
13A	IN8	Orange-2		13B	OUT12	Orange-4	
14A	IN9	Yellow-2		14B	OUT13	Yellow-4	
15A	IN10	Green-2		15B	OUT14	Green-4	
16A	IN11	Blue-2		16B	OUT15	Blue-4	
17A	IN12	Purple-2		17B	Pulse	Purple-4	
18A	IN13	Gray-2		18B	input	Gray-4	
19A	IN14	White-2		19B	0V	White-4	
20A	IN15	Black-2		20B	0V	Black-4	