

POSITAL

FRABA

POSITION AND MOTION SENSORS



At Your
Fingertips
1,000,000
Sensors

The One Stop Encoder Shop

Sold & Serviced By:

 **ELECTROMATE**

Toll Free Phone (877) SERV098

www.electromate.com

sales@electromate.com

FRABA WORLDWIDE

POSITAL Service

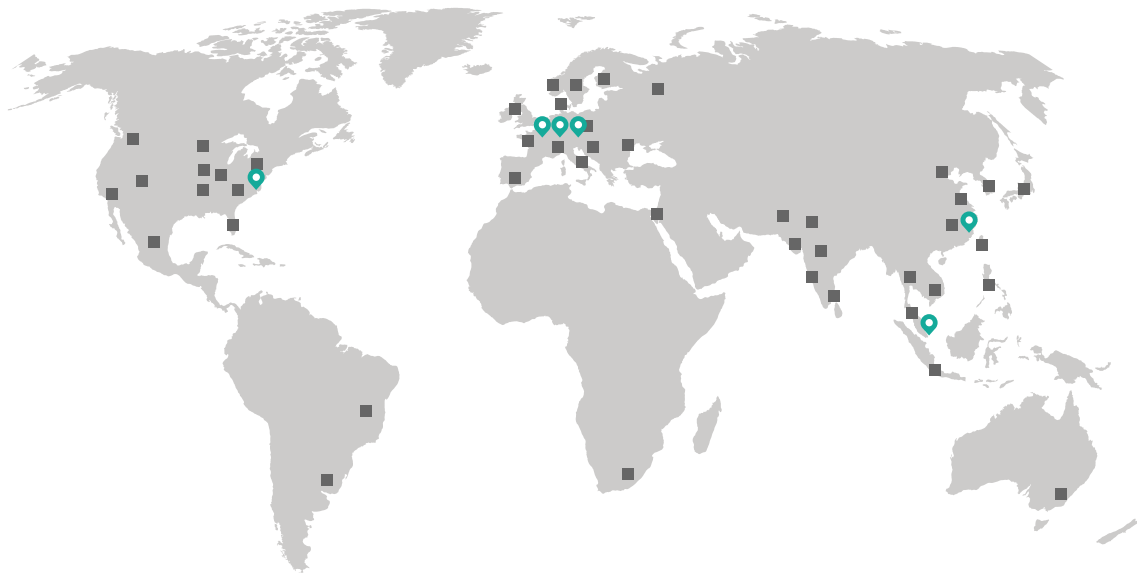

36 Month Warranty

All products sold under the POSITAL brand name will include a warranty extending 36 months (3 years) from the date of shipping. This is an industry leading timeframe, supported by decades of experience with rotary encoders.



Partner Network

POSITAL is evolving and growing, entering new markets and increasing distribution. Our global distribution network includes sales partners and system integrators who can provide expert guidance and technical support.



24 Hours Delivery

POSITAL's standard production is typically 72 hours. Thanks to the mass customization approach and state-of-the-art production facility, POSITAL can easily offer a 24h expedited production for a wide range of products (which comes with a modest surcharge).



Contact us!

Feel free to contact us for any questions or requests regarding POSITAL sensors.

Europe: info@posital.eu

Asia: info@posital.sg

Americas: info@posital.com

FRABA WORLDWIDE

FRABA Locations



FRABA Cologne



FRABA Singapore



FRABA Heerlen



CONISTICS Slubice

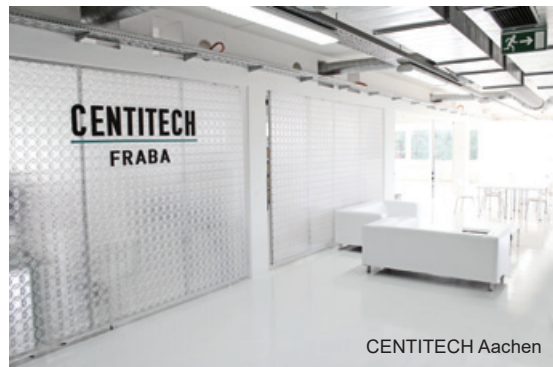

CENTITECH Aachen



FRABA New Jersey



FRABA Shanghai

COMPANY

Over 50 Years Experience with Position Sensors



POSITAL

POSITAL is a manufacturer of sensors for motion control and safety assurance systems. The company's products, which include rotary encoders, inclinometers, linear position sensors and a large variety of accessories, are used in a wide range of settings, from manufacturing to mining, agriculture to energy.

FRABA Group

POSITAL is a member of the international FRABA Group, with a history that dates from 1918, when Franz Baumgartner established a workshop to build electromagnetic relays in Cologne, Germany. In its current form, the FRABA Group is a market-leading enterprise that makes use of advanced product design and manufacturing process to ensure that its customers enjoy the benefits of technology leadership, choice, product quality and competitive prices. Other FRABA Group subsidiaries include VITECTOR which focuses on protection sensors to guard doors and production machine covers.

Service

POSITAL's unique online product finder is providing access to a huge variety of solutions without requiring specialized knowledge. Many hundred thousand specific datasheets are available in 11 languages and easy to browse. The traditional practice of customization has been replaced by this new approach to a large extent. Furthermore experienced engineers are available in Europe, North America and Asia at different locations to support the large global network of distributors and customers within their time zone and in many languages.

Production

POSITAL's sensors are produced through a highly innovative, data-centered manufacturing system that enables us to build a wide variety of product configurations on a made-to-order basis, while maintaining the cost efficiencies of large-scale mass production. Even with hundred thousands of unique configurations available, standard products are ready to ship within 3 working days of receiving an order.



COMPANY

FRABA Revolutions



Mass Customization

POSITAL encoders are based on a modular architecture that makes it possible for the company to offer an extremely wide range of configuration options. Using POSITAL's online product finder tool, customers can "build" the devices that they need, specifying the performance characteristics, mechanical features, communications interfaces and so on.

Once customers have identified exactly what they require, devices are custom-assembled through a computer-controlled manufacturing system that ensures quality, traceability and rapid delivery of the final product at prices comparable to standardized mass-produced items. This approach makes the vision of "MOQ-1" (minimum order quantity – one) a practical reality!

Magnetic Technology to a New Level

Magnetic encoders are typically more compact and rugged, but until now, have offered lower levels of precision and dynamic response. POSITAL has eliminated the need for compromise by developing a new generation of magnetic absolute and incremental encoders that match the performance of optical shaft-mounted encoders in all but the most demanding applications.

The core element of POSITAL's series of magnetic encoders is an advanced Hall-effect sensor system, combined with a powerful 32-bit microprocessor and carefully optimized signal processing software. This combination results in levels of resolution, accuracy and dynamic response that rival the performance level of optical encoders.



POSITAL STORY

1918

Founded by Franz Baumgartner in Cologne, Germany and originally specialized in mechanical relays.



2000

The first foreign subsidiary opens up in Princeton, New Jersey, USA.

1973

FRABA manufactures one of the first encoders based on optical measurement technology.



2002



POSITAL product portfolio expands to include industrial inclinometers.

1963

FRABA starts selling "brush" absolute rotary encoders.



1993

Dr. Achim Leeser, Christian Leeser and Axel Wiemann take over the company. They restructure the company into a group of independent companies combined by a common Mission and Guiding Principles.



2001

FRABA introduces 2 new business units, **POSITAL** which continues the encoder and position sensor business and **VITECTOR** which focuses on safety systems for the door and gate market.

POSITAL
FRABA

VITECTOR
FRABA

Sold & Serviced By:

 **ELECTROMATE**

Toll Free Phone (877) SERV098
www.electromate.com
sales@electromate.com

POSITAL STORY

2005

POSITAL launches a new line of magnetic multiturn encoders based on a Wiegand Wire Energy Harvesting Technology.



2009

The first Asian subsidiary opens in Singapore.

2013



High precision magnetic absolute and incremental encoders offered by POSITAL. POSITAL introduces a unique online product finder where users can select from more than 1 million sensors.

2015

The first Chinese subsidiary opens in Shanghai. Planning for production in Asia and North America.

2006

CONISTICS, FRABA's advanced manufacturing plant opens in Slubice, Poland. CONISTICS is tailored to produce small lot sizes in a wide range of configurations.



2011

FRABA's holding office opens in Heerlen, NL and product development cell, CENTITECH, moves to Aachen.

2016

POSITAL continues the "mass customization" business system by offering more mechanical and electric options for the existing product lines as well as adding a large variety of product accessories.

2014



POSITAL launches a new generation of programmable absolute and incremental encoders. With the new configuration tool customers have access to more than 1 million sensors.

CATALOG OVERVIEW

> POSITAL Products

Rotary Encoders, Linear Sensor, Inclinometers and Accessories	10
---	----

> Industries

Power Generation and Water	12
Material Handling	13
Mobile Machinery	14
Factory Automation	15
Healthcare and Elevators	16

> IXARC Rotary Encoders

Technology Magnetic Encoder	18
Technology Optical Encoder	19
Absolute vs Incremental Encoders	20
Programmable Encoders	21
Product Overview and Selection	22

> Kit Encoders

Innovation in Motor Feedback	69
------------------------------	----

> LINARIX Linear Sensors

Draw Wire Technology Linear Sensor	74
Product Overview and Selection	75

> TILTIX Inclinometers

Technology Industrial Inclinometer	86
Explosion Proof Certified Inclinometers	87
Product Overview and Selection	88

> Accessories

Wide Selection of Accessories	97
-------------------------------	----

> Encodermatch

Competitor Cross Reference Finder	106
-----------------------------------	-----

> POSITAL Partnership

Want to Become Our Partner?	107
-----------------------------	-----

Disclaimer

© FRABA B.V. all rights reserved. We do not assume responsibility for technical inaccuracies or omissions. Specifications are subject to change without notice.

Version 20161231

POSITAL PRODUCTS

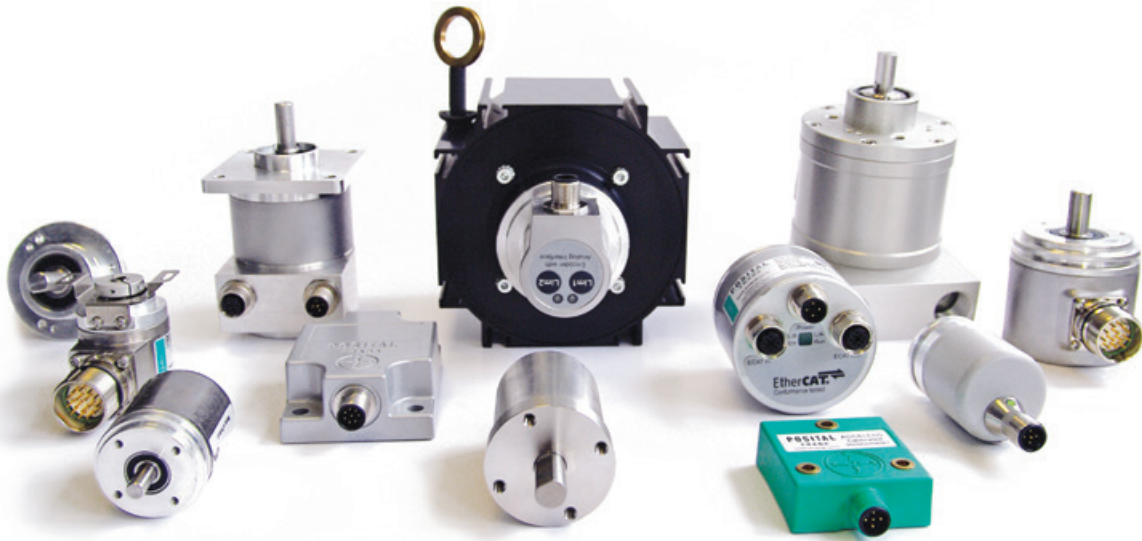

A Million Possibilities

Sold & Serviced By:

 **ELECTROMATE**

Toll Free Phone (877) SERV098
www.electromate.com
sales@electromate.com

PRODUCTS

Position and Motion Sensors



High Precision IXARC Rotary Encoders

Motion control applications – ranging from factory automation to mobile machinery – require accurate, realtime information about the location of mechanical components. The IXARC line of rotary encoders provide precise and reliable measurement of the angular positions of joints, drive shafts, pulleys, etc... Available electronic connections range from simple analog outputs to sophisticated Fieldbus and Industrial Ethernet interfaces.

- **Absolute and Incremental Technology**
- **Optical and Magnetic Encoders up to 16 bit Resolution**

Compact Industrial TILTIX Inclinometers

Accurate measurement of tilt or inclination is very important for motion control and safety systems. Inclinometers provide single or dual-axis angle measurement in an economical package. Relying on gravity for their measurement, these sensors have no exposed moving parts, resulting in easy installation and high environmental protection.

- **High Accuracy of 0.1° and Resolution of 0.01°**
- **Measurement Range ±90° (Dual Axis) or 360° (Single Axis)**

Versatile LINARIX Linear Sensors

Many applications require linear motion to be monitored for system control or to ensure safety. With lengths ranging from 1 m to 30 m [3 to 98 ft], LINARIX draw wire sensors are available in many configurations to meet an application's requirements. Options include a wide variety of outputs (including analog, incremental, Fieldbus and Ethernet variants), heavy duty housings and compact designs.

- **Position Measurement with Resolutions up to 2 μm**
- **Variety of Materials**

Wide Selection of Accessories

POSITAL offers a wide variety of accessories that simplify sensor installation. Mating connectors of different styles and lengths ensure proper electrical connections. Using appropriate mounting accessories minimize wear and tear on encoders and help to ensure a long and reliable life cycle. Interface modules and displays are also available to provide users with immediate access to measurements.

- **Different Cable Designs and Lengths**
- **Adapter Flanges for Precise Installation**



INDUSTRIES



Find the Right Product for your Application!

Sold & Serviced By:

 **ELECTROMATE**

Toll Free Phone (877) SERV098

www.electromate.com

sales@electromate.com

INDUSTRIES

Power Generation and Water



Wind Energy

IXARC heavy duty absolute and incremental encoders provide precise angle measurement for pitch control systems that dynamically adjust the angle of wind turbine rotor blades. High resolution encoders are also ideal for yaw control ensuring optimal positioning of the nacelle with respect to wind direction.

- Salt Resistant Sensors
- Increased Efficiency in Extreme Environments

Solar Energy

For both photovoltaic systems and concentrated power plants (CSP, CPV), solar tracking systems increase energy efficiency. The compact and accurate IXARC encoders and TILTIX inclinometers are ideal for both single and two axis tracking systems which not only follow the sun from east to west but also have an adjusting elevation system.

- Optimized Solar Panel Orientation
- Position Maintained even after Power Loss

Water / Wastewater

Accurate monitoring of sluice gates for flood control, sewage and power plants, dams or irrigation facilities can be monitored remotely with IXARC rotary encoders and LINARIX linear sensors. The IXARC magnetic rotary encoders are also ideal for precise valve positioning.

- Minimum Maintenance, Increased Reliability
- Easy Remote Control, Variety of Interfaces

Oil and Gas

Whether it's offshore or onshore, an exploration platform or a refinery POSITAL explosion proof IECEx and ATEX certified products can provide accurate positioning and speed monitoring in pipe handling equipment or in blow out preventer (BOP) systems.

- Certified Sensors for Explosive Environments
- Accurate Leveling for Subsea Systems



INDUSTRIES

Material Handling



Automated Storage Retrieval Systems

Increasing warehouse and labor costs make the use of automatic storage and retrieval systems economically attractive. IXARC rotary encoders and LINARIX linear sensors are used in these systems to give the position of the loading equipment with respect to the vertical racks where goods are stored.

- Vertical and Horizontal Positioning of the Units
- Accurate Monitoring of the Arms

Overhead Conveyors

Assembly lines for automotive production have dedicated work stations for different processes. Typically the vehicle chassis is moved through a series of such work stations using overhead conveyors. IXARC absolute encoders help achieve this movement in a safe and controlled manner.

- Fieldbus & Ethernet for Fast Communication
- For SIL2, SIL3 Certified for Safe Operation

Baggage Handling

Due to stringent security requirements, all airline baggage needs to be screened and distributed in a secure manner. A labyrinth of conveyors helps sort these in a correct fashion. Programmable Fieldbus IXARC rotary encoders help track the position of multiple baggage conveyors.

- Diagnostics LED, Reduced System Installation
- Simplified Wiring, Decreased Time & Costs

Forklifts and Automated Guided Vehicles

For forklifts and AGVs that carry loads from one point to another, safety is of utmost importance. TILTIX inclinometers and LINARIX linear sensors help to avoid accidental contact and insure precise positioning of loads.

- Simple Communication with Analog Interfaces
- Programmable Measurement by the User

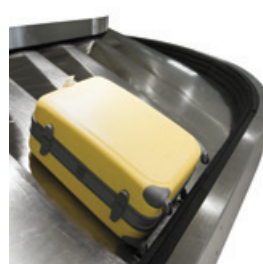

INDUSTRIES

Mobile Machinery



Mining

Drill rigs, excavators and mobile hammering systems are complicated machines which must perform flawlessly under the harshest conditions. For these applications the ATEX certified IXARC rotary encoders can be used to provide precise positioning of drill heads and masts. Single and dual axis POSITAL TILTIX inclinometers further equip operators with essential information for platform leveling and arm positioning.

- **Certified Sensors for Explosive Environments**
- **Precise Positioning & Leveling**

Cranes

Cranes and other construction machinery are required to be safe, efficient and reliable. Positioning is of prime importance, and redundant systems are often used to eliminate errors. To address this requirement the IXARC SIL-2 encoders are an excellent fit, combining redundant measurement with an easy-to-integrate interface.

- **Sensors for High Levels of Shock & Vibration**
- **Increased Accuracy & Safety**

Arm / Boom Extension

Trucks with long boom extensions such as fire trucks or concrete pumps have to reach to high-rise buildings, often over large obstacles. IXARC rotary encoders can be mounted directly on the rotational joints to provide data for active damping systems. TILTIX single or dual axis inclinometers can be used to monitor the position of the boom arm or for base leveling.

- **IP69K Sensors, Pressure & Temperature Resistant**
- **Easy Communication, CAN, Incremental & Analog Interfaces**

Scissor Lifts and Aerial Work Platforms

Scissor lifts need constant tilt monitoring to prevent tip-overs, an easy job for the dual axis TILTIX inclinometers. IXARC rotary encoders and LINARIX linear sensors are ideal for situations where the height of the lift needs to be known.

- **Compact & Economical Sensors**
- **For SIL2, SIL3 Certified for Safe Operation**



INDUSTRIES

Factory Automation



Packaging

High precision is needed in processes like form filling, sealing, palletizing, pick and place, cartoning and cardboard folding. The IXARC rotary encoders with Fieldbus, Ethernet or incremental interfaces can simplify wiring and keep costs down while their stainless steel housing can withstand high temperatures and pressure wash downs.

- **Precise and Fast Position Feedback**
- **Reliability at Maximum Work Speed**

Textile and Plastic

In both textile and plastic manufacturing the material used are changed periodically and constant adjustments need to be made in roll and nozzle positioning. IXARC rotary encoders and LINARIX linear sensors can help speed up these changes.

- **Reduced Downtime and Increased Efficiency**
- **Reliable Positioning in Hot & Humid Areas**

Food and Beverage

Filling bottles to the right level, accurate labeling and strict regulatory requirements are a few issues that manufactures have to deal with. IXARC rotary encoders and LINARIX linear sensors are used in the food and beverage industry to support efficient and hygienic food packaging.

- **Stainless Steel Version, Chemical Resistance**
- **Accurate Process Monitoring**

Industrial Robots

Industrial robots are used widely in manufacturing processes around the world. They carry out activities like welding, painting, assembling which all demand high accuracy. IXARC rotary encoders and kit encoders mounted on the joints of robots can measure and control their movements.

- **Compact Size, Ideal for Retrofitting**
- **Absolute & Incremental Measurement**



INDUSTRIES

Healthcare and Elevators



Healthcare

Modern devices used in the healthcare industry demand advanced technology for precise positioning. TILTIX compact inclinometers provide accurate measurements and are built to last the life of the equipment. LINARIX linear sensors offer a solution for tracking the position of patient tables. For more complex applications, such as fluoroscopy or radiography tables or surgical C-arms, that require coordinated positioning of several components, IXARC rotary encoders are an excellent option.

- Precise Positioning of Patient & Scanner
- Simple Installation, Easier Calibration

Elevators

Elevator cars need to be accurately positioned with respect to each floor they visit. IXARC absolute encoders help provide this information without the need of a ground reference. With IXARC absolute encoders, knowledge of the position of the elevator car is always retained, even during power failures. IXARC encoders supporting the CANopen Lift protocol help meet the high safety standards of this industry. Cost efficient LINARIX linear sensors are an excellent solution for door positioning.

- Absolute & Incremental Positioning
- High Shaft Load, Increased Safety

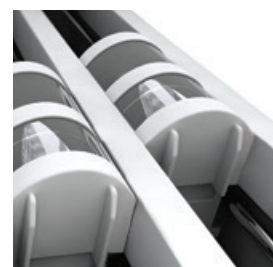
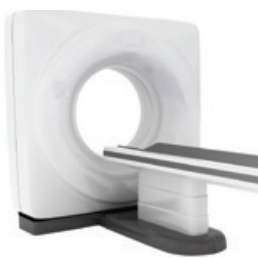

IXARC ROTARY ENCODERS



High Performance Absolute and Incremental Encoders

Sold & Serviced By:

 **ELECTROMATE**

Toll Free Phone (877) SERV098

www.electromate.com

sales@electromate.com

IXARC ROTARY ENCODERS

Magnetic Measurement Principles



Magnetic rotary encoders determine angular position using magnetic field sensor technology. A permanent magnet **A** fixed to the encoder's shaft creates a magnetic field which is sampled by a sensor **B** that generates an accurate absolute position reading.

Signal Processing is the Key to High Performance

The technological leap that pushes POSITAL's IXARC magnetic encoders to the performance level of optical systems is based on a new generation of sensor systems. The combination of a custom Hall-effect sensor and complex signal processing algorithms running on a powerful 32 bit microprocessor results in a considerably improved resolution and accuracy, along with latency times of only a few microseconds. POSITAL has also implemented an incremental interface and can now offer a complete range of encoder solutions.

Multiturn Innovation

POSITAL can also provide absolute multiturn measurements by means of a revolution counter system

that uses an energy harvesting system based on the Wiegand effect. This system requires no gears or batteries. Eliminating batteries brings about many advantages. Batteries have a limited lifespan, weigh a lot, and often contain harmful substances. Gear units have disadvantages of their own being large, complex, costly and vulnerable to shock and vibration. Regardless of the rotational speed, even at near-zero, the energy harvesting system generates short, powerful voltage pulses, sufficient to power the counting electronics. The result is a revolution counter that is independent of any external power supply. This technology, which has proven itself since 2005, enables maintenance-free reliable measurement of absolute positions, even in demanding environments, for years to come.

Advantages of Magnetic Encoders

- > Robust and Durable
- > Mechanically Simple and Economical – No Battery, No Gear
- > Compact Design for Installation in Small Spaces

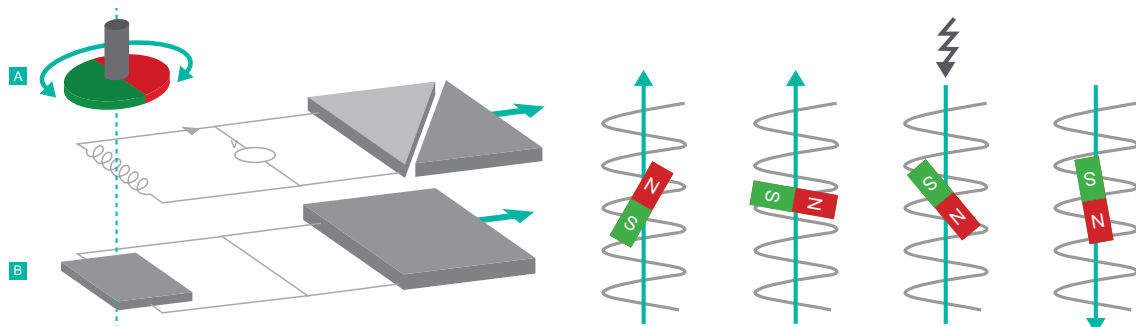

IXARC ROTARY ENCODERS

Optical Measurement Principles

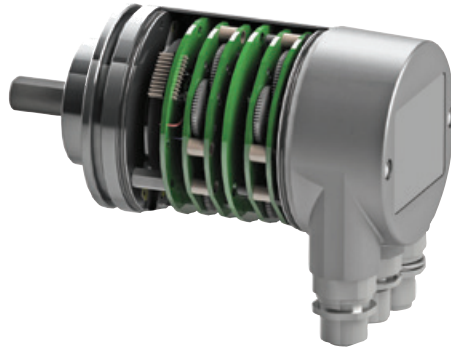

A key component of optical rotary encoders is a code disk **A** mounted on the encoder shaft **B**. This disk is made of unbreakable plastic that has a concentric pattern of transparent and opaque areas. Infrared light from an LED **C** shines through the code disk, onto an array of photoreceptors. As the shaft turns, a unique combination of photoreceptors are illuminated or blocked from light by the pattern on the disk. For multiturn models, there is an additional set of code discs arranged in a gear train **D**. As the main encoder shaft rotates, these discs are geared together to turn like the wheels of an odometer. The rotational position of each disc is monitored optically and the output is a count of the net number of rotations of the encoder shaft.

Functionality

POSITAL's IXARC optical absolute rotary encoders use highly integrated Opto-ASICs, providing a resolution up to 16 bits (65,536 steps) per turn. For multiturn models, the measuring range is extended by the mechanically geared code disks to as many as 16,384 (2^{14}) revolutions.

Advantages of Optical Encoders

- > High Resolution and Accuracy along with Excellent Dynamic Response
- > For Use in Areas with High Magnetic Fields
- > No Risk of These Devices Losing Track of Their Absolute Position
- > No Backup Batteries Required

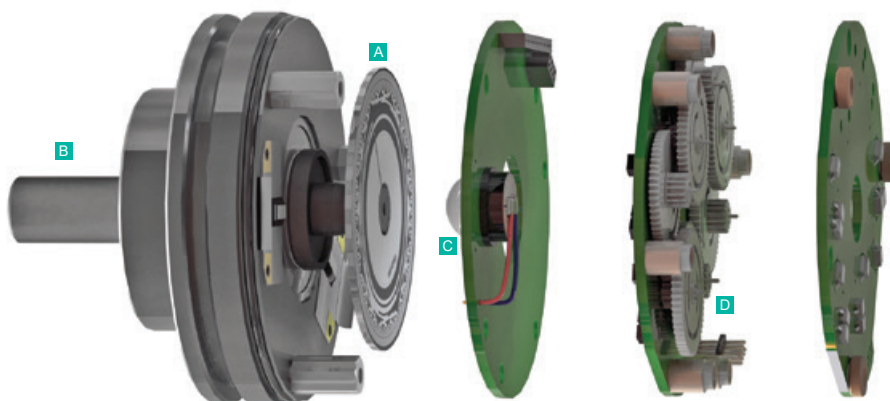

IXARC ROTARY ENCODERS

Absolute vs Incremental Rotary Encoders



Absolute Rotary Encoders

Absolute rotary encoders are capable of providing unique position values from the moment they are switched on. This is accomplished by detecting the position of a coded element. All positions in these systems correspond to a unique code. Even movements that occur while the system is without power are translated into accurate position values once the encoder is powered up again.

Advantages

- Multiple Interface Options: Analog, Ethernet, Fieldbus, Parallel, Serial
- Singleturn and Multiturn Revolution
- Resolution up to 16 bit
- Optical and Magnetic Measuring Principle

Incremental Rotary Encoders

Incremental encoders generate an output signal each time the shaft rotates a certain angle. The number of signals (pulses) per turn (PPR defines the resolution of the device. Each time the encoder is powered on it begins counting from zero, regardless of where the shaft is. Initial homing to a reference point is therefore inevitable in all positioning tasks, both upon start up of the control system and whenever power to the encoder has been interrupted.

Advantages

- A, B, Z, and Inverted Signals as HTL (Push-Pull) or TTL (RS422)
- Any Pulse Count up to 16384 Pulses per Revolution Available
- 65384 Edges Quadrature
- Programmable for Flexibility
- Magnetic Measuring Principle

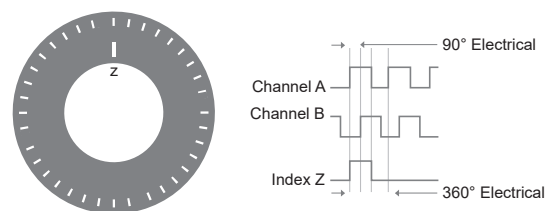
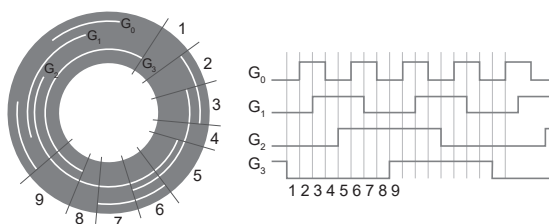

IXARC ROTARY ENCODERS

Programmable Encoders



Programmable Features – Save Time and Money

POSITAL has replaced hardware by software and has taken versatility to a new level. Resolution (PPR) can be set anywhere from one to 16,384 pulses per turn. Similarly, pulse direction and the output driver – either Push-Pull (HTL) or RS422 (TTL) – can be defined through software parameters. All of these parameters can be configured very easily using the UBIFAST tool and any WiFi-enabled smartphone, tablet or laptop computer. It is not necessary to install any software or app. Additionally all the configuration data for each encoder is sent to POSITAL's ERP system and can be retrieved in the future for replacement. since a small number of devices can be programmed to take on a wide range of measurement tasks. Distributors and OEM customers can reduce their inventory levels and simplify the supply chain. System integrators can decide at the last minute how to tailor the encoder to specific requirements on site and initiate the purchase of the encoders while final design requirements are still under discussion. End users can receive spare parts from a distributor or system integrator quickly.

Simple Programming

With the new capabilities, the encoders' performance characteristics can be extensively modified through software changes, without requiring any changes to physical components. In a related development, POSITAL is introducing the UBIFAST configuration tool, a hardware module that can be easily connected to programmable encoders through accessory cables. The UBIFAST tool features a built-in WiFi hotspot and webserver. Once the tool has been powered up, any WiFi-enabled smartphone, tablet, or laptop computer can connect to the WiFi hotspot and the configuration interface will automatically open up in a standard web browser window – no app, no software installation, and no internet connection are required. POSITAL also presents an internet-enabled configuration management system for IXARC programmable encoders. Whenever a device is reconfigured, the operator has the option of registering the changes with POSITAL through an automatic e-mail interface.

**PROGRAMMABLE
INCREMENTAL**

Magnetic **ENCODERS**







At Your
Fingertips
**1,000,000
Sensors**

A Million Possibilities

Unparalleled Choice of
Mechanical Features and
Electrical Connections!

IXARC ROTARY ENCODERS

Product Overview – Incremental Encoders

		Max. Protection Class	Pulses per Revolution	Accuracy (INL)	Accuracy (DNL)	Flange Size in mm [in]	Clamp Flange	Synchro Flange	Hollow Flange	Square Flange	Supply Voltage in V	Cable	Connector	Connection Cap	Shock / Vibration in g	Radial Shaft Load in N
	> Magnetic	IP68	1 ...	0.09°	0.003°	36 [1.42]	■	■	■		4.75–30	■	■		300	300
	> Programmable	IP69K	16384			42 [1.65]									30	
	> IP69K															
	> Magnetic	IP64	1 ...	0.09°	0.003°	38 [1.5]	■				4.75–30	■	■		100	110
	> Programmable	IP65	16384			58 [2.28]									10	
	> Clamp Flange	IP67				(More p. 36)										
	> Magnetic	IP64	1 ...	0.09°	0.003°	36 [1.42]		■			4.75–30	■	■		100	110
	> Programmable	IP65	16384			38 [1.5]									10	
	> Synchro Flange	IP67				58 [2.28]										
	> Magnetic	IP64	1 ...	0.09°	0.003°	36 [1.42]			■		4.75–30	■	■		100	110
	> Programmable	IP65	16384			42 [1.65]									10	
	> Hollow Flange	IP67				58 [2.28]										
	> Magnetic	IP64	1 ...	0.09°	0.003°	52.3 [2.0]				■	4.75–30	■	■		100	110
	> Programmable	IP65	16384			63.5 [2.5]									10	
	> Square Flange	IP67														
	> Optical	IP66	Up to	Up to	Up to	115 [4.52]	■				4.5 – 5.5	■	■		200	350
	> Incremental	IP67	2500	0.02	0.01						4.5 – 30				20	
	> Heavy Duty															

> Related Industries



> Find What You Need

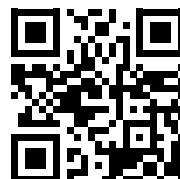

Configure Your POSITAL Encoder Online

**PRODUCT
FINDER**

IXARC ROTARY ENCODERS

Product Selection Guide – Incremental Encoders

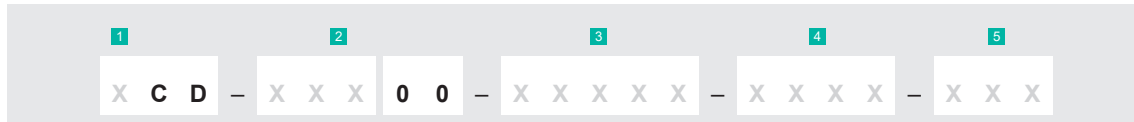

1 Accuracy (Technology)

- U** ≤ 0.09° (Magnetic)
- O** ≤ 0.14° at 360 pulses,
0.02° at 2500 pulses (Optical)

2 Communication Interface

- IPT** Default RS422 (TTL) , Programmable HTL/TTL
- IPH** Default Push-Pull (HTL), Programmable HTL/TTL
- INS** RS422 (TTL) (Optical)
- INH** Push-Pull (HTL) (Optical)

3 Pulses per Revolution

XXXXX For Programmable:

Choose Any Pulse Count 1 to 16384

- 00360** 360 Pulses (for Optical)
- 00512** 512 Pulses (for Optical)
- 01000** 1000 Pulses (for Optical)
- 01024** 1024 Pulses (for Optical)
- 02000** 2000 Pulses (for Optical)
- 02048** 2048 Pulses (for Optical)
- 02500** 2500 Pulses (for Optical)

4 Mechanical Design and Protection Class

- Blind Hollow Shaft (Page 36)
- Synchro (Page 43)
- Clamp (Page 50)
- Through Hollow (Page 58)
- Square (Page 59)

5 Connection Type

- CAW** Cable: Axial 1 m
- 2AW** Cable: Axial 2 m
- 5AW** Cable: Axial 5 m
- AAW** Cable: Axial 10 m
- CRW** Cable: Radial 1 m
- 2RW** Cable: Radial 2 m
- 5RW** Cable: Radial 5 m
- ARW** Cable: Radial 10 m
- PAM** Connector: Axial M12, 5 pin
- PAQ** Connector: Axial M12, 8 pin
- PAL** Connector: Axial M23, 12 pin
- PRM** Connector: Radial M12, 5 pin
- PRQ** Connector: Radial M12, 8 pin
- PRL** Connector: Radial M23, 12 pin
- PRD** Connector: Radial MIL MS14
- PRE** Connector: Radial MIL MS16
- PRF** Connector: Radial MIL MS18
- TB1** Terminal Box (Optical)



> UBIFAST Configuration Tool







- Compact Housing with WLAN to Create Hotspot
- Connects to Smart Phone/ Tablets/ Notebooks
- Web Browser Based Simple Programming
- Configuration Data Sent Back to POSITAL via E-mail
- Parameters to Program: PPR, Resolution, Number of Turns, Direction

> Learn More



IXARC ROTARY ENCODERS

Product Overview – Analog and Parallel Encoders

		Protection Class	Max. Revolutions (Turns)	Max. Resolution in bit	Accuracy / Linearity (±)	Flange Size in mm [in]	Clamp Flange	Synchro Flange	Hollow Flange	Square Flange	Supply Voltage in V	Cable	Connector	Connection Cap	Shock / Vibration in g	Radial Shaft Load in N
 <ul style="list-style-type: none"> ➤ Program. Output ➤ Voltage, Current ➤ IP68, IP69K 	IP69K	65536	13	0.09°	36 [1.42]	■	■	■			8-32	■	■		300	300
	IP68			0.15%	42 [1.65]										30	
	IP67															
 <ul style="list-style-type: none"> ➤ Program. Output ➤ Analog Voltage ➤ Magnetic 	IP64	65536	13	0.09°	38 [1.5]	■	■	■	■		8-32	■	■		100	110
	IP65			0.15%	58 [2.28]										10	
	IP67				(More p. 36)											
 <ul style="list-style-type: none"> ➤ Program. Output ➤ Analog Current ➤ Magnetic 	IP64	65536	13	0.09°	38 [1.5]	■	■	■	■		8-32	■	■		100	110
	IP65			0.15%	58 [2.28]										10	
	IP67				(More p. 36)											
 <ul style="list-style-type: none"> ➤ Program. Output ➤ Analog Voltage ➤ Pushbuttons 	IP64	65536	13	0.09°	52.3 [2]	■	■	■	■		8-32	■	■		100	110
	IP65			0.15%	63.5 [2.5]										10	
	IP67															
 <ul style="list-style-type: none"> ➤ Program. Output ➤ Analog Current ➤ Pushbuttons 	IP64	65536	13	0.09°	36 [1.42]	■	■	■	■		8-32	■	■		100	110
	IP65			0.15%	58 [2.28]										10	
	IP67				(More p. 36)											
 <ul style="list-style-type: none"> ➤ Optical ➤ Parallel ➤ Binary, Gray 	IP64	16384	16	0.022°	58 [2.28]	■	■	■	■		10-30	■	■		100	110
	IP65														10	
	IP67															

➤ Related Industries



➤ Find What You Need



Configure Your POSITAL Encoder Online

PRODUCT
FINDER

IXARC ROTARY ENCODERS

Product Selection Guide – Analog and Parallel Encoders



1 Accuracy (Technology)

U ≤ 0.09° (Magnetic)

O ≤ 0.022° (Optical)

2 Communication Interface

AV001 Analog Voltage: 0 to 5 V

AV002 Analog Voltage: 0 to 10 V

AV003 Analog Voltage: 0.5 to 4.5 V

AV004 Analog Voltage: 0.5 to 9.5 V

AC005 Analog Current: 4 to 20 mA

AC006 Analog Current: 0 to 20 mA

AVP01 Analog Voltage: 0 to 5 V w. Pushbuttons

AVP02 Analog Voltage: 0 to 10 V w. Pushbuttons

AVP03 Analog Voltage: 0.5 to 4.5 V w. Pushbuttons

AVP04 Analog Voltage: 0.5 to 9.5 V w. Pushbuttons

ACP05 Analog Current: 4 to 20 mA w. Pushbuttons

ACP06 Analog Current: 0 to 20 mA w. Pushbuttons

PPA1B Parallel Binary

P1A1B Parallel Preset Binary

PPA1G Parallel Gray

P1A1G Parallel Preset Gray

PP00E Parallel Excess Gray

P100E Parallel Preset Excess Gray

3 Revolution

00 Singleturn

04 Multiturn: 4 bit (16 rev)

07 Multiturn: 7 bit (128 rev)

08 Multiturn: 8 bit (256 rev)

12 Multiturn: 12 bit (4096 rev)

14 Multiturn: 14 bit (16384 rev)

4 Resolution

08 8 bit (256 Steps / 0.35°) Parallel only

09 9 bit (512 Steps / 1°) Parallel only

AA 9 bit (360 Steps / 0.7°) Parallel only

10 10 bit (1024 Steps / 0.35°) Parallel only

12 12 bit (4096 Steps / 0.088°)

13 13 bit (8192 Steps / 0.044°)

14 14 bit (16384 Steps / 0.02°)

16 16 bit (65536 Steps / 0.005°)

AP 90° Analog for Singleturn only

AR 180° Analog for Singleturn only

AS 270° Analog for Singleturn only

5 Mechanical Design and Protection Class

Blind Hollow Shaft (Page 36)

Synchro (Page 43)

Clamp (Page 50)

Square (Page 59)

6 Connection Type

CAW Cable: Axial 1 m

2AW Cable: Axial 2 m

5AW Cable: Axial 5 m

AAW Cable: Axial 10 m

CRW Cable: Radial 1 m

2RW Cable: Radial 2 m

5RW Cable: Radial 5 m

ARW Cable: Radial 10 m

PAM Connector: Axial M12, 5 pin (Analog)

PAP Connector: Axial M23, 16 pin (Parallel)

PAT Connector: Axial M27, 26 pin (Parallel)

PRM Connector: Radial M12, 5 pin (Analog)

PRP Connector: Radial M23, 16 pin (Parallel)

PRT Connector: Radial M27, 26 pin (Parallel)

Sold & Serviced By:











Toll Free Phone (877) SERV098

www.electromate.com

sales@electromate.com

IXARC ROTARY ENCODERS

Product Overview – SSI and SSI+Incremental Encoders

		Max. Protection Class	Max. Revolutions (Turns)	Max. Resolution in bit	Accuracy / Linearity (±)	Flange Size in mm [in]	Clamp Flange	Synchro Flange	Hollow Flange	Square Flange	Supply Voltage in V	Cable Connector	Connection Cap	Shock / Vibration in g	Radial Shaft Load in N
 <ul style="list-style-type: none"> > Magnetic > SSI > Programmable 	IP68	65536	16	0.09°	36 [1.42]	■	■	■			4.5–30	■	■	300	300
	IP69K				42 [1.65]									30	
 <ul style="list-style-type: none"> > Magnetic > SSI > Programmable 	IP64	65536	16	0.09°	36 [1.42]	■	■	■	■		4.5–30	■	■	100	110
	IP65				58 [2.28]									10	
	IP67				(More p. 36)										
 <ul style="list-style-type: none"> > Magnetic > SSI + Incremental > Programmable 	IP68	65536	16	0.09°	36 [1.42]						4.5–30	■	■	300	300
	IP69K				42 [1.65]									30	
 <ul style="list-style-type: none"> > Magnetic > SSI + Incremental > Programmable 	IP64	65536	16	0.09°	36 [1.42]	■	■	■	■		4.5–30	■	■	100	110
	IP65				58 [2.28]									10	
	IP67				(More p. 36)										
 <ul style="list-style-type: none"> > Optical > SSI > Up to 16 bit 	IP67	16384	16	0.022°	58 [2.28]	■	■	■	■		4.5–30	■	■	100	110
					63.5 [2.5]									10	
 <ul style="list-style-type: none"> > Optical > SSI + Incremental > Up to 16 bit 	IP65	16384	16	0.022°	58 [2.28]	■	■	■	■		4.5–30	■	■	100	110
					63.5 [2.5]									10	
 <ul style="list-style-type: none"> > Optical > SSI > Push-Buttons 	IP67	16384	16	0.022°	58 [2.28]	■	■	■	■		4.5–30	■	■	100	110
					63.5 [2.5]									10	

> Related Industries

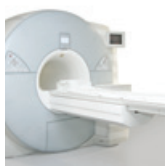

> Find What You Need

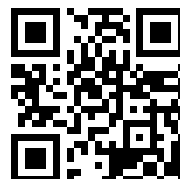

Configure Your POSITAL Encoder Online

**PRODUCT
FINDER**

IXARC ROTARY ENCODERS

Product Selection Guide – SSI and SSI+Incremental Encoders



1 Accuracy (Technology)

U ≤ 0.09° (Magnetic)

O ≤ 0.022° (Optical)

2 Communication Interface

S101B SSI Binary

SLF1B SSI Binary Fast

S101G SSI Gray

S101E SSI Excess-Gray

SHPPP Programmable SSI+Incr. Push-Pull (HTL) 4.75 to 30 VDC

SRPPP Programmable SSI+Incr. RS422 (TTL) 8 to 30 VDC

SSPPP Programmable SSI+Incr. RS422 (TTL) 5 VDC

SHxxB SSI+Incr. Binary + A/B/Z (Push-Pull) 4.75 to 30 VDC

SRxxB SSI+Incr. Binary + A/B/Z (RS-422) 8 to 30 VDC

SSxxB SSI+Incr. Binary+ A/B/Z (RS-422) 5 VDC

SHxxG SSI+Incr. Gray + A/B/Z (Push-Pull) 4.75 to 30 VDC

SRxxG SSI+Incr. Gray + A/B/Z (RS-422) 8 to 30 VDC

SSxxG SSI+Incr. Gray + A/B/Z (RS-422) 5 VDC

S401B SSI Binary w. Pushbuttons

S401G SSI Gray w. Pushbuttons

S3xxG SSI Gray+Incr. A/B/Z (RS-422)

S3xxB SSI Binary+Incr. A/B/Z (RS-422)

S5xxB SSI Binary+Incr. A/B/Z (RS-422)

S6xxB SSI Binary+Incr. A/B/Z (Push-Pull)

S5xxG SSI Gray+Incr. A/B/Z (RS-422)

S6xxG SSI Gray+Incr. A/B/Z (Push-Pull)

3 Revolution

00 Singleturn

04 Multiturn: 4 bit (16 rev)

08 Multiturn: 8 bit (256 rev)

12 Multiturn: 12 bit (4096 rev)

13 Multiturn: 13 bit (8192 rev)

14 Multiturn: 14 bit (16384 rev)

16 Multiturn: 16 bit (65536 rev)

20 Multiturn: 20 bit (1048576 rev)

PP Programmable, Default 12 bit (4096 rev)

4 Resolution

12 12 bit (4096 Steps / 0.088°)

13 13 bit (8192 Steps / 0.044°)

16 16 bit (65536 Steps / 0.005°)

PP Programmable, Default 13 bit (8192 Steps / 0.044°)

5 Mechanical Design and Protection Class

Blind Hollow Shaft (Page 36)

Synchro (Page 43)

Clamp (Page 50)

Through Hollow (Page 58)

Square (Page 59)

6 Connection Type

CAW Cable: Axial 1 m

2AW Cable: Axial 2 m

5AW Cable: Axial 5 m

AAW Cable: Axial 10 m

CRW Cable: Radial 1 m

2RW Cable: Radial 2 m

5RW Cable: Radial 5 m

ARW Cable: Radial 10 m

PAQ Connector: Axial M12, 8 pin

PAL Connector: Axial M23, 12 pin

PAP Connector: Axial M23, 16 pin

PRQ Connector: Radial M12, 8 pin

PRL Connector: Radial M23, 12 pin

PRP Connector: Radial M23, 16 pin

IXARC ROTARY ENCODERS

Product Overview – Fieldbus Encoders

		Max. Protection Class	Max. Revolutions (Turns)	Max. Resolution in bit	Accuracy / Linearity (±)	Flange Size in mm [in]	Clamp Flange	Synchro Flange	Hollow Flange	Square Flange	Supply Voltage in V	Cable Connector	Connection Cap	Shock / Vibration in g	Radial Shaft Load in N
	> Magnetic	IP69K	65536	16	0.09°	36 [1.42]	■	■	■		9–32	■	■	300	300
	> CANopen	IP68				42 [1.65]								30	
	> SAE J1939														
	> Magnetic	IP65	65536	16	0.09°	36 [1.42]	■	■	■	■	9–32	■	■	300	180
	> CANopen	IP66				58 [2.28]								30	
	> SAE J1939	IP67				(More p. 36)									
	> Magnetic	IP65	65536	16	0.09°	58 [2.28]	■	■	■	■	10–30		■	100	110
	> Profibus	IP66				63.5 [2.5]							■	10	
	> Up to 16 bit	IP67													
	> Optical	IP65	65536	16	0.09°	36 [1.42]	■	■	■	■	10–30	■	■	100	110
	> DeviceNet					58 [2.28]								10	
	> Up to 16 bit														
	> Optical	IP65	16384	16	0.022°	52.3 [2]	■	■	■	■	10–30	■	■	100	110
	> Profibus	IP66				58 [2.28]								10	
	> Up to 16 bit	IP67				63.5 [2.5]									
	> Optical	IP65	16384	16	0.022°	58 [2.28]	■	■	■	■	10–30	■	■	100	110
	> Interbus	IP66				63.5 [2.5]								10	
	> Up to 16 bit	IP67													
	> Optical	IP65	16384	16	0.022°	52.3 [2]	■	■	■	■	10–30	■	■	100	110
	> CANopen	IP66				58 [2.28]								10	
	> Up to 16 bit	IP67				63.5 [2.5]									

> Related Industries



> Find What You Need



Configure Your POSITAL Encoder Online

PRODUCT FINDER

IXARC ROTARY ENCODERS

Product Selection Guide – Fielbus Encoders



1 Accuracy (Technology)

U ≤ 0.09° (Magnetic)

O ≤ 0.022° (Optical)

2 Communication Interface

DPC1B Profibus (Optical, Magnetic)

CA01B CANopen (Magnetic)

CAA1B CANopen (Optical)

CTx1B CANopen+Incr. RS422 (TTL)

CHx1B CANopen+Incr. Push-Pull (HTL)

CL00B CANopen Lift (Magnetic)

C900B SAE J1939

D2B1B DeviceNet (Optical)

IBA1B Interbus (Optical)

3 Revolution

00 Singleturn

12 Multiturn: 12 bit (4096 rev)

13 Multiturn: 13 bit (8192 rev)

14 Multiturn: 14 bit (16384 rev)

15 Multiturn: 15 bit (32768 rev)

4 Resolution

12 12 bit (4096 Steps / 0.088°)

13 13 bit (8192 Steps / 0.044°)

16 16 bit (65536 Steps / 0.005°)

5 Mechanical Design and Protection Class

Blind Hollow Shaft (Page 36)

Synchro (Page 43)

Clamp (Page 50)

Through Hollow (Page 58)

Square (Page 59)

6 Connection Type

CAW Cable: Axial 1 m

2AW Cable: Axial 2 m

5AW Cable: Axial 5 m

AAW Cable: Axial 10 m

CRW Cable: Radial 1 m

2RW Cable: Radial 2 m

5RW Cable: Radial 5 m

ARW Cable: Radial 10 m

PAM Connector: Axial M12, 5 pin (CANopen, CANopen Lift)

PAV Connector: Axial M12, 5 pin, Status LED
(CANopen, CANopen Lift)

PAM Connector: Axial 3 x M13 (Profibus)

PAQ Connector: Axial M12, 8 pin (CAN+Incr.)

PRM Connector: Radial M12, 5 pin

PRV Connector: Radial M12, 5 pin, Status LED
(CANopen, CANopen Lift)

PRQ Connector: Radial M12, 8 pin (CAN+Incr.)

PR8 Connector: Radial 2xM12, 5pin + 8pin (CAN+Incr.)

PRI Connector: Radial 2 x M23, 9 pin (Interbus)

H3P Connection Cap: 3 Cable Glands

H1B Connection Cap: 1 x M12 Connector

H2B Connection Cap: 2 x M12 Connectors

H72 Connection Cap: 3 x M12 Connectors











H1C Connection Cap: 1 x M23 Connector (DeviceNet)

H2M Connection Cap: 2 x M20 Cable Glands

HCC Without Connection Cap

IXARC ROTARY ENCODERS

Product Overview – Ethernet Encoders

 		Max. Protection Class	Max. Revolutions (Turns)	Max. Resolution in bit	Accuracy / Linearity (±)	Flange Size in mm [in]	Clamp Flange	Synchro Flange	Hollow Flange	Square Flange	Supply Voltage in V	Cable Connector	Connection Cap	Shock / Vibration in g	Radial Shaft Load in N
 <ul style="list-style-type: none"> ➤ Magnetic ➤ Profinet ➤ Up to 16 bit 	IP65	65536	16	0.09°	58 [2.28]	■	■	■	■	10–30	■	■	100	110	
	IP66				63.5 [2.5]								10		
	IP67														
 <ul style="list-style-type: none"> ➤ Magnetic ➤ EtherCAT ➤ Up to 16 bit 	IP65	65536	16	0.09°	58 [2.28]	■	■	■	■	10–30	■	■	100	110	
	IP66				63.5 [2.5]								10		
	IP67														
 <ul style="list-style-type: none"> ➤ Magnetic ➤ Powerlink ➤ Up to 16 bit 	IP65	65536	16	0.09°	58 [2.28]	■	■	■	■	10–30	■	■	100	110	
	IP66				63.5 [2.5]								10		
	IP67														
 <ul style="list-style-type: none"> ➤ Optical ➤ Profinet ➤ Up to 16 bit 	IP65	16384	16	0.022°	58 [2.28]	■	■	■	■	10–30	■	■	100	110	
	IP66				63.5 [2.5]								10		
	IP67														
 <ul style="list-style-type: none"> ➤ Optical ➤ EtherNet/IP ➤ Up to 16 bit 	IP65	16384	16	0.022°	58 [2.28]	■	■	■	■	10–30	■	■	100	110	
	IP66				63.5 [2.5]								10		
	IP67														
 <ul style="list-style-type: none"> ➤ Optical ➤ EtherCAT ➤ Up to 16 bit 	IP65	16384	16	0.022°	58 [2.28]	■	■	■	■	10–30	■	■	100	110	
	IP66				63.5 [2.5]								10		
	IP67														
 <ul style="list-style-type: none"> ➤ Optical ➤ Powerlink ➤ Up to 16 bit 	IP65	65536	16	0.022°	58 [2.28]	■	■	■	■	10–30	■	■	100	110	
	IP66				63.5 [2.5]								10		
	IP67														
 <ul style="list-style-type: none"> ➤ Optical ➤ Modbus/TCP ➤ Up to 16 bit 	IP65	16384	16	0.022°	58 [2.28]	■	■	■	■	10–30	■	■	100	110	
	IP66				63.5 [2.5]								10		
	IP67														

➤ Related Industries

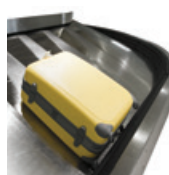

➤ Find What You Need

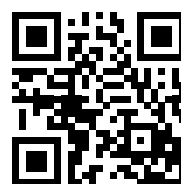

Configure Your POSITAL Encoder Online

PRODUCT
FINDER

IXARC ROTARY ENCODERS

Product Selection Guide – Ethernet Encoders



1 Accuracy (Technology)

U ≤ 0.09° (Magnetic)

O ≤ 0.022° (Optical)

2 Communication Interface

EIB1B Profinet

EEA1B EtherNet/IP

E2A2B Powerlink

EC00B EtherCAT

EM00B Modbus/TCP + TCP/IP

3 Revolution

00 Singleturn

12 Multiturn: 12 bit (4096 rev)

14 Multiturn: 14 bit (16384 rev)

4 Resolution

13 13 bit (8192 Steps / 0.044°)

16 16 bit (65536 Steps / 0.005°)

5 Mechanical Design and Protection Class

Blind Hollow Shaft (Page 36)

Synchro (Page 43)

Clamp (Page 50)

Square (Page 59)

6 Connection Type

PRM Connector: Radial 2 x M12 (Modbus)

PRM Connector: Radial 3 x M12

PAM Connector: Axial 3 x M12



> Rugged Connectors and Cables







- Reliable Electrical Connections
- M12 & M23 Data, Bus and Signal Connectors
- Straight and Angled Versions
- Variety of Cable Material and Lengths
- Shielded for Protection Against Noise and Interference

> Learn More



IXARC ROTARY ENCODERS

Product Overview – Ex-Proof Encoders ATEX/IECEX Certified

		Max. Protection Class	Max. Revolutions (Turns)	Max. Resolution in bit	Accuracy / Linearity (±)	Flange Size in mm [in]	Clamp Flange	Synchro Flange	Hollow Flange	Square Flange	Supply Voltage in V	Cable	Connector	Connection Cap	Shock / Vibration in g	Radial Shaft Load in N
	> Zone 1 & 21 (Mining)	IP67	16384	16	0.022°	78 [3.07]	■	■	■	■	10-30			■	100	50
	> Various Interfaces														10	
	> Optical															
	> Zone 1 & 21 (Oil+Gas)	IP67	16384	16	0.022°	78 [3.07]	■	■	■	■	10-30			■	100	50
	> Various Interfaces														10	
	> Optical															
	> Zone 1 & 21 (Mining)	IP67	16384	16	0.022°	78 [3.07]	■	■	■	■	4.5-30			■	100	50
	> Profinet														10	
	> Optical															
	> Zone 1 & 21 (Oil+Gas)	IP67	16384	16	0.022°	78 [3.07]	■	■	■	■	4.5-30			■	100	50
	> Profinet														10	
	> Optical															
	> Zone 2 & 22	IP67	16384	16	0.022°	58 [2.28]	■	■	■		4.5-30			■	100	110
	> All Interfaces														10	
	> Optical, Magnetic															

> Related Industries



> Find What You Need

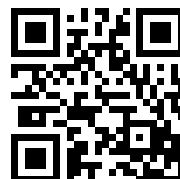

Configure Your POSITAL Encoder Online

PRODUCT FINDER

IXARC ROTARY ENCODERS

Product Selection Guide – Ex-Proof Encoders ATEX/IECEX Certified

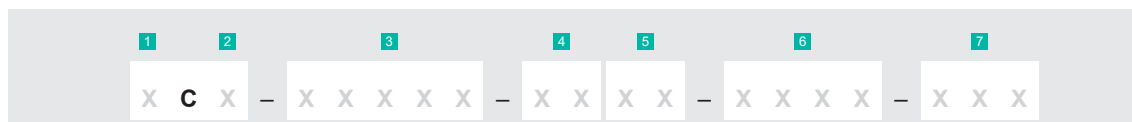

1 Accuracy (Technology)

U ≤ 0.09° (Magnetic)

O ≤ 0.022° (Optical)

2 Certificate

E Zone 1 & 21 (Oil+Gas)

M Zone 1 & 21 (Mining)

F Zone 2 & 22

3 Communication Interface

IPT00 Default RS422 (TTL) , Programmable HTL/TTL

IPH00 Default Push-Pull (HTL), Programmable HTL/TTL

S101B SSI Binary

S101G SSI Gray

AV001 Voltage: 0 to 5 V

AV002 Voltage: 0 to 10 V

AV003 Voltage: 0.5 to 4.5 V

AV004 Voltage: 0.5 to 9.5 V

AC005 Current: 4 to 20 mA

AC006 Current: 0 to 20 mA

DPC1B Profibus

CAA1B CANopen

D2B1B DeviceNet

EIB1B Profinet

EEA1B EtherNet/IP

E2A2B Powerlink

EC00B EtherCAT

4 Revolution

00 Singleturn

04 Multiturn: 4 bit (16 rev)

08 Multiturn: 8 bit (256 rev)

12 Multiturn: 12 bit (4096 rev)

14 Multiturn: 14 bit (16384 rev)

5 Resolution

12 12 bit (4096 Steps / 0.088°)

13 13 bit (8192 Steps / 0.044°)

16 16 bit (65536 Steps / 0.005°)

6 Mechanical Design and Protection Class

Blind Hollow Shaft (Page 36)

Synchro (Page 43)

Clamp (Page 50)

Through Hollow (Page 58)

Square (Page 59)

7 Connection Type

CAW Cable: Axial 1 m (Zone 1 & 21)

2AW Cable: Axial 2 m (Zone 1 & 21)

5AW Cable: Axial 5 m (Zone 1 & 21)

AAW Cable: Axial 10 m (Zone 1 & 21)

CRW Cable: Radial 1 m (Zone 1 & 21)

2RW Cable: Radial 2 m (Zone 1 & 21)

5RW Cable: Radial 5 m (Zone 1 & 21)

ARW Cable: Radial 10 m (Zone 1 & 21)

CAE Cable: Axial 1 m (Zone 2 & 22)

2AE Cable: Axial 2 m (Zone 2 & 22)

5AE Cable: Axial 5 m (Zone 2 & 22)

AAE Cable: Axial 10 m (Zone 2 & 22)

CRE Cable: Radial 1 m (Zone 2 & 22)

2RE Cable: Radial 2 m (Zone 2 & 22)

5RE Cable: Radial 5 m (Zone 2 & 22)

ARE Cable: Radial 10 m (Zone 2 & 22)

HFG Connection Cap: 2 x Axial Blind Plug

HFZ Connection Cap: 2 x Radial Blind Plug

HFE Connection Cap: 3 x Radial Blind Plug

H3E Connection Cap: 3 Cable Glands (Zone 2 & 22)

Sold & Serviced By:







Toll Free Phone (877) SERV098

www.electromate.com

sales@electromate.com

IXARC ROTARY ENCODERS

Product Overview – Encoders for Safety Applications

		Max. Protection Class	Max. Revolutions (Turns)	Max. Resolution in bit	Accuracy / Linearity (±)	Flange Size mm [in]	Clamp Flange	Synchro Flange	Hollow Flange	Square Flange	Supply Voltage in V	Cable	Connector	Connection Cap	Radial Shaft Load in N
	<ul style="list-style-type: none"> > Magnetic > ProfiSafe > SIL 2 	IP67	16384	16	0.2 %	58 [2.28]	■	■	■		9–36		■		250
	<ul style="list-style-type: none"> > Magnetic > CANopen Safety > SIL 2 	IP67	16384	16	0.2 %	58 [2.28]	■	■	■		9–36		■		250
	<ul style="list-style-type: none"> > Magnetic > CANopen > Singleturn 	IP67	16384	16	≤3.6°	58 [2.28]	■	■			9–35		■		25
	<ul style="list-style-type: none"> > Redundant > Optical > Magnetic 	IP67	16384	16	0.09°	58 [2.28]	■	■	■		10–30		■		110

> Related Industries



> Find What You Need



Configure Your POSITAL Encoder Online

**PRODUCT
FINDER**

IXARC ROTARY ENCODERS

Product Selection Guide – Encoders for Safety Applications



1 Technology

M ≤ 0.36° (Magnetic)

T ≤ 0.09° (Redundant: Optical+Magnetic)

2 Certificate

S SIL

R Redundant

3 Communication Interface

CAA1B CANopen (Redundant)

CSD1B CANopen Singleturn (SIL 2)

CSD2B CANopen Safety (SIL 2)

CSE2B Multiturn Optical (SIL 2)

EIDDB ProfiSafe non TIA (SIL2)

EIDTB ProfiSafe TIA (SIL2)

S101G SSI Gray (Redundant)

S101B SSI Binary (Redundant)

4 Revolution

00 Singleturn

12 Multiturn: 12 bit (4096 rev)

14 Multiturn: 14 bit (16384 rev)

5 Resolution

12 12 bit (4096 Steps / 0.088°)

13 13 bit (8192 Steps / 0.044°)

16 16 bit (65536 Steps / 0.005°)

6 Mechanical Design and Protection Class

Blind Hollow Shaft (Page 36)

Synchro (Page 43)

Clamp (Page 50)

Through Hollow (Page 58)

Square (Page 59)

7 Connection Type

CAW Cable: Axial 1 m

2AW Cable: Axial 2 m

5AW Cable: Axial 5 m

AAW Cable: Axial 10 m

PAM Connector: Axial M12, 5 pin

PRM Connector: Radial M12, 5 pin

PRN Connector: Radial 2 x M12, 5 pin



> Rugged Connectors and Cables

- Reliable Electrical Connections
- M12 & M23 Data, Bus and Signal Connectors
- Straight and Angled Versions
- Variety of Cable Material and Lengths
- Shielded for Protection Against Noise and Interference

> Learn More



IXARC ROTARY ENCODERS

Technical Drawings – Flange

> Flange Design: Blind Hollow Shaft

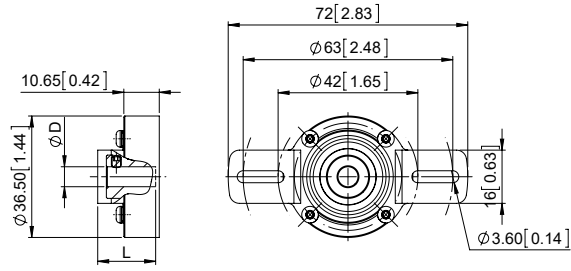
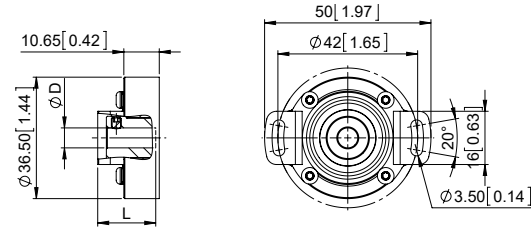
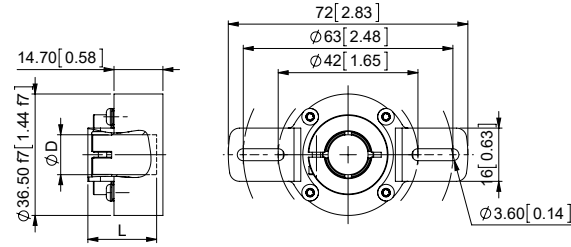
	Type Key	Shaft Diameter (D)	Shaft Depth (L)	Protection Class	Material	Flange Size Ø	Housing Compatibility
	A6B0	6 [0.24]	30 [1.18]	IP65	Al	36 [1.42]	36 [1.42]
	A8B0	8 [0.31]	30 [1.18]	IP65	Al	36 [1.42]	36 [1.42]
	AAB0	10 [0.39]	30 [1.18]	IP65	Al	36 [1.42]	36 [1.42]
	ABB0	11 [0.43]	30 [1.18]	IP65	Al	36 [1.42]	36 [1.42]
	ACB0	12 [0.47]	30 [1.18]	IP65	Al	36 [1.42]	36 [1.42]
	ARB0	6.35 [1/4]	30 [1.18]	IP65	Al	36 [1.42]	36 [1.42]
	ASB0	9.52 [3/8]	30 [1.18]	IP65	Al	36 [1.42]	36 [1.42]
	ATB0	12.7 [1/2]	30 [1.18]	IP65	Al	36 [1.42]	36 [1.42]
	A6S0	6 [0.24]	30 [1.18]	IP54	Al	36 [1.42]	36 [1.42]
	A8S0	8 [0.31]	30 [1.18]	IP54	Al	36 [1.42]	36 [1.42]
	AAS0	10 [0.39]	30 [1.18]	IP54	Al	36 [1.42]	36 [1.42]
	ABS0	11 [0.43]	30 [1.18]	IP54	Al	36 [1.42]	36 [1.42]
	ACS0	12 [0.47]	30 [1.18]	IP54	Al	36 [1.42]	36 [1.42]
	ARS0	6.35 [1/4]	30 [1.18]	IP54	Al	36 [1.42]	36 [1.42]
	ASS0	9.52 [3/8]	30 [1.18]	IP54	Al	36 [1.42]	36 [1.42]
	ATS0	12.7 [1/2]	30 [1.18]	IP54	Al	36 [1.42]	36 [1.42]
	K6BD	6 [0.24]	22 [0.87]	IP69K	Al	36 [1.42]	36 [1.42]
	K8BD	8 [0.31]	22 [0.87]	IP69K	Al	36 [1.42]	36 [1.42]
	KABD	10 [0.39]	22 [0.87]	IP69K	Al	36 [1.42]	36 [1.42]
	KBBD	11 [0.43]	22 [0.87]	IP69K	Al	36 [1.42]	36 [1.42]
	KCBD	12 [0.47]	22 [0.87]	IP69K	Al	36 [1.42]	36 [1.42]
	KRBD	6.35 [1/4]	22 [0.87]	IP69K	Al	36 [1.42]	36 [1.42]
	KSBD	9.52 [3/8]	22 [0.87]	IP69K	Al	36 [1.42]	36 [1.42]

All dimension in mm [inch]; Al: Aluminum; 303: Stainless Steel V2A (1.4305, 303); 316 L: Stainless Steel V4A (1.4404, 316 L)

IXARC ROTARY ENCODERS

Technical Drawings – Flange

> Flange Design: Blind Hollow Shaft

	Type Key	Shaft Diameter (D)	Shaft Depth (L)	Protection Class	Material	Flange Size Ø	Housing Compatibility
	K6BG	6 [0.24]	22 [0.87]	IP69K	316 L	36 [1.42]	36 [1.42]
	K8BG	8 [0.31]	22 [0.87]	IP69K	316 L	36 [1.42]	36 [1.42]
	KABG	10 [0.39]	22 [0.87]	IP69K	316 L	36 [1.42]	36 [1.42]
	KBBG	11 [0.43]	22 [0.87]	IP69K	316 L	36 [1.42]	36 [1.42]
	KCBG	12 [0.47]	22 [0.87]	IP69K	316 L	36 [1.42]	36 [1.42]
	KRBG	6.35 [1/4]	22 [0.87]	IP69K	316 L	36 [1.42]	36 [1.42]
	KSBG	9.52 [3/8]	22 [0.87]	IP69K	316 L	36 [1.42]	36 [1.42]
	V6B0	6 [0.24]	18 [0.71]	IP65	Al	36 [1.42]	36 [1.42]
	V8B0	8 [0.31]	18 [0.71]	IP65	Al	36 [1.42]	36 [1.42]
	VAB0	10 [0.39]	18 [0.71]	IP65	Al	36 [1.42]	36 [1.42]
	VBB0	11 [0.43]	18 [0.71]	IP65	Al	36 [1.42]	36 [1.42]
	VCB0	12 [0.47]	18 [0.71]	IP65	Al	36 [1.42]	36 [1.42]
	VRB0	6.35 [1/4]	18 [0.71]	IP65	Al	36 [1.42]	36 [1.42]
	VSB0	9.52 [3/8]	18 [0.71]	IP65	Al	36 [1.42]	36 [1.42]
VTB0	12.7 [1/2]	18 [0.71]	IP65	Al	36 [1.42]	36 [1.42]	
	V6S0	6 [0.24]	18 [0.71]	IP65	Al	36 [1.42]	36 [1.42]
	V8S0	8 [0.31]	18 [0.71]	IP65	Al	36 [1.42]	36 [1.42]
	VAS0	10 [0.39]	18 [0.71]	IP65	Al	36 [1.42]	36 [1.42]
	VBS0	11 [0.43]	18 [0.71]	IP65	Al	36 [1.42]	36 [1.42]
	VCS0	12 [0.47]	18 [0.71]	IP65	Al	36 [1.42]	36 [1.42]
	VRS0	6.35 [1/4]	18 [0.71]	IP65	Al	36 [1.42]	36 [1.42]
	VSS0	9.52 [3/8]	18 [0.71]	IP65	Al	36 [1.42]	36 [1.42]
VTS0	12.7 [1/2]	18 [0.71]	IP65	Al	36 [1.42]	36 [1.42]	

All dimension in mm [inch]; Al: Aluminum; 303: Stainless Steel V2A (1.4305, 303); 316 L: Stainless Steel V4A (1.4404, 316 L)

IXARC ROTARY ENCODERS

Technical Drawings – Flange

> Flange Design: Blind Hollow Shaft

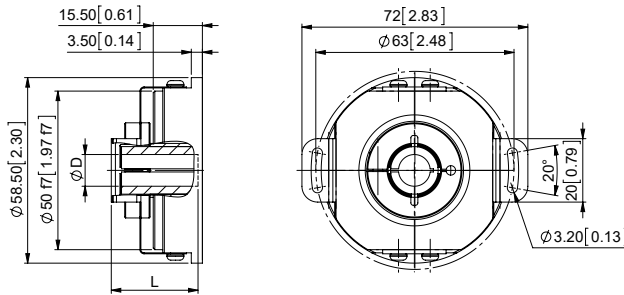
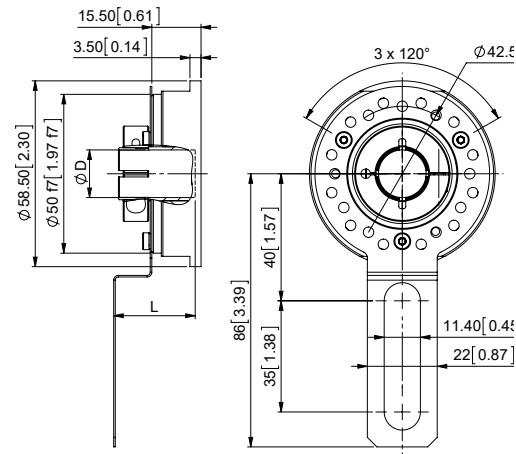
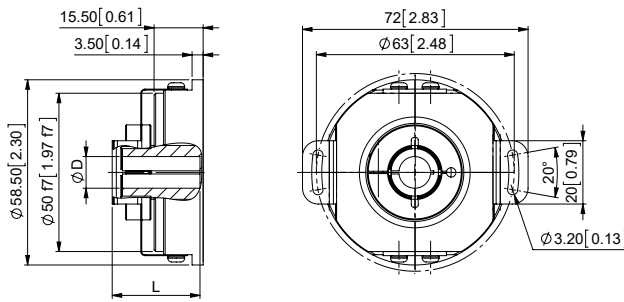

Type Key	Shaft Diameter (D)	Shaft Depth (L)	Protection Class	Material	Flange Size Ø	Housing Compatibility
B060	6 [0.24]	30 [1.18]	IP65	Al	58 [2.28]	58 [2.28]
BRS0	6.35 [1/4]	30 [1.18]	IP65	Al	58 [2.28]	58 [2.28]
B080	8 [0.31]	30 [1.18]	IP65	Al	58 [2.28]	58 [2.28]
BSS0	9.52 [3/8]	30 [1.18]	IP65	Al	58 [2.28]	58 [2.28]
B100	10 [0.39]	30 [1.18]	IP65	Al	58 [2.28]	58 [2.28]
B110	11 [0.43]	30 [1.18]	IP65	Al	58 [2.28]	58 [2.28]
B120	12 [0.47]	30 [1.18]	IP65	Al	58 [2.28]	58 [2.28]
BTS0	12.7 [1/2]	30 [1.18]	IP65	Al	58 [2.28]	58 [2.28]
B140	14 [0.55]	30 [1.18]	IP65	Al	58 [2.28]	58 [2.28]
BUS0	14.9 [5/8]	30 [1.18]	IP65	Al	58 [2.28]	58 [2.28]
B150	15 [0.59]	30 [1.18]	IP65	Al	58 [2.28]	58 [2.28]
B160	16 [0.63]	30 [1.18]	IP67	Al	58 [2.28]	58 [2.28]
B6Y0	6 [0.24]	30 [1.18]	IP65	Al	58 [2.28]	58 [2.28]
BRY0	6.35 [1/4]	30 [1.18]	IP65	Al	58 [2.28]	58 [2.28]
B8Y0	8 [0.31]	30 [1.18]	IP65	Al	58 [2.28]	58 [2.28]
BSY0	9.52 [3/8]	30 [1.18]	IP65	Al	58 [2.28]	58 [2.28]
BAY0	10 [0.39]	30 [1.18]	IP65	Al	58 [2.28]	58 [2.28]
BBY0	11 [0.43]	30 [1.18]	IP65	Al	58 [2.28]	58 [2.28]
BCY0	12 [0.47]	30 [1.18]	IP65	Al	58 [2.28]	58 [2.28]
BTY0	12.7 [1/2]	30 [1.18]	IP65	Al	58 [2.28]	58 [2.28]
BEY0	14 [0.55]	30 [1.18]	IP65	Al	58 [2.28]	58 [2.28]
BUY0	14.9 [5/8]	30 [1.18]	IP65	Al	58 [2.28]	58 [2.28]
BFY0	15 [0.59]	30 [1.18]	IP65	Al	58 [2.28]	58 [2.28]
BGY0	16 [0.63]	30 [1.18]	IP65	Al	58 [2.28]	58 [2.28]
B06H	6 [0.24]	30 [1.18]	IP67	Al	58 [2.28]	58 [2.28]
BRSH	6.35 [1/4]	30 [1.18]	IP67	Al	58 [2.28]	58 [2.28]
B08H	8 [0.31]	30 [1.18]	IP67	Al	58 [2.28]	58 [2.28]
BSSH	9.52 [3/8]	30 [1.18]	IP67	Al	58 [2.28]	58 [2.28]
B10H	10 [0.39]	30 [1.18]	IP67	Al	58 [2.28]	58 [2.28]
B11H	11 [0.43]	30 [1.18]	IP67	Al	58 [2.28]	58 [2.28]
B12H	12 [0.47]	30 [1.18]	IP67	Al	58 [2.28]	58 [2.28]
BTSH	12.7 [1/2]	30 [1.18]	IP67	Al	58 [2.28]	58 [2.28]
B14H	14 [0.55]	30 [1.18]	IP67	Al	58 [2.28]	58 [2.28]
BUSH	14.9 [5/8]	30 [1.18]	IP67	Al	58 [2.28]	58 [2.28]
B15H	15 [0.59]	30 [1.18]	IP67	Al	58 [2.28]	58 [2.28]
B16H	16 [0.63]	30 [1.18]	IP67	Al	58 [2.28]	58 [2.28]

All dimension in mm [inch]; Al: Aluminum; 303: Stainless Steel V2A (1.4305, 303); 316 L: Stainless Steel V4A (1.4404, 316 L)

IXARC ROTARY ENCODERS

Technical Drawings – Flange

> Flange Design: Blind Hollow Shaft

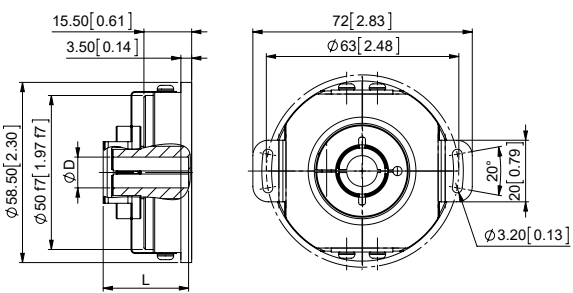
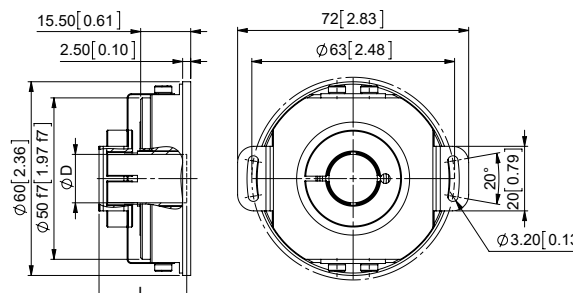
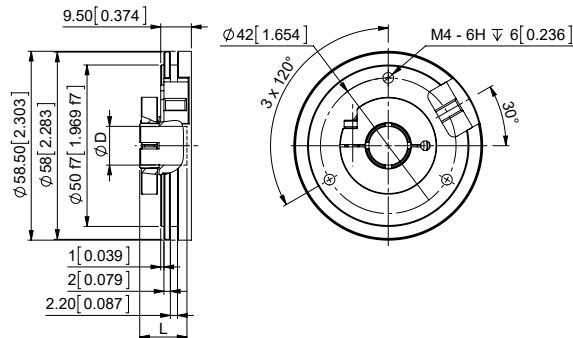
	Type Key	Shaft Diameter (D)	Shaft Depth (L)	Protection Class	Material	Flange Size Ø	Housing Compatibility
	B06S	6 [0.24]	30 [1.18]	IP67	Al	58 [2.28]	58 [2.28]
	BRSS	6.35 [1/4]	30 [1.18]	IP67	Al	58 [2.28]	58 [2.28]
	B08S	8 [0.31]	30 [1.18]	IP67	Al	58 [2.28]	58 [2.28]
	BSSS	9.52 [3/8]	30 [1.18]	IP67	Al	58 [2.28]	58 [2.28]
	B10S	10 [0.39]	30 [1.18]	IP67	Al	58 [2.28]	58 [2.28]
	B11S	11 [0.43]	30 [1.18]	IP67	Al	58 [2.28]	58 [2.28]
	B12S	12 [0.47]	30 [1.18]	IP67	Al	58 [2.28]	58 [2.28]
	BTSS	12.7 [1/2]	30 [1.18]	IP67	Al	58 [2.28]	58 [2.28]
	B14S	14 [0.55]	30 [1.18]	IP67	Al	58 [2.28]	58 [2.28]
	BUSS	14.9 [5/8]	30 [1.18]	IP67	Al	58 [2.28]	58 [2.28]
	B06V	6 [0.24]	30 [1.18]	IP67	303	58 [2.28]	58 [2.28]
	BRSV	6.35 [1/4]	30 [1.18]	IP67	303	58 [2.28]	58 [2.28]
	B08V	8 [0.31]	30 [1.18]	IP67	303	58 [2.28]	58 [2.28]
	BSSV	9.52 [3/8]	30 [1.18]	IP67	303	58 [2.28]	58 [2.28]
	B10V	10 [0.39]	30 [1.18]	IP67	303	58 [2.28]	58 [2.28]
	B11V	11 [0.43]	30 [1.18]	IP67	303	58 [2.28]	58 [2.28]
	B12V	12 [0.47]	30 [1.18]	IP67	303	58 [2.28]	58 [2.28]
	BTSV	12.7 [1/2]	30 [1.18]	IP67	303	58 [2.28]	58 [2.28]
	B14V	14 [0.55]	30 [1.18]	IP67	303	58 [2.28]	58 [2.28]
	BUSV	14.9 [5/8]	30 [1.18]	IP67	303	58 [2.28]	58 [2.28]
	H6B0	6 [0.24]	28 [1.10]	IP65	Al	58 [2.28]	58 [2.28]
	HRB0	6.35 [1/4]	28 [1.10]	IP65	Al	58 [2.28]	58 [2.28]
	H8B0	8 [0.31]	28 [1.10]	IP65	Al	58 [2.28]	58 [2.28]
	HSB0	9.52 [3/8]	28 [1.10]	IP65	Al	58 [2.28]	58 [2.28]
	HAB0	10 [0.39]	28 [1.10]	IP65	Al	58 [2.28]	58 [2.28]
	HBB0	11 [0.43]	28 [1.10]	IP65	Al	58 [2.28]	58 [2.28]
	HCB0	12 [0.47]	28 [1.10]	IP65	Al	58 [2.28]	58 [2.28]
	HTB0	12.7 [1/2]	28 [1.10]	IP65	Al	58 [2.28]	58 [2.28]
	HEB0	14 [0.55]	28 [1.10]	IP65	Al	58 [2.28]	58 [2.28]
	HUB0	14.9 [5/8]	28 [1.10]	IP65	Al	58 [2.28]	58 [2.28]
	HFB0	15 [0.59]	28 [1.10]	IP65	Al	58 [2.28]	58 [2.28]
	HGB0	16 [0.63]	28 [1.10]	IP67	Al	58 [2.28]	58 [2.28]

All dimension in mm [inch]; Al: Aluminum; 303: Stainless Steel V2A (1.4305, 303); 316 L: Stainless Steel V4A (1.4404, 316 L)

IXARC ROTARY ENCODERS

Technical Drawings – Flange

> Flange Design: Blind Hollow Shaft

	Type Key	Shaft Diameter (D)	Shaft Depth (L)	Protection Class	Material	Flange Size Ø	Housing Compatibility
	H6S0	6 [0.24]	28 [1.10]	IP65	Al	58 [2.28]	58 [2.28]
	HRS0	6.35 [1/4]	28 [1.10]	IP65	Al	58 [2.28]	58 [2.28]
	H8S0	8 [0.31]	28 [1.10]	IP65	Al	58 [2.28]	58 [2.28]
	HSS0	9.52 [3/8]	28 [1.10]	IP65	Al	58 [2.28]	58 [2.28]
	HAS0	10 [0.39]	28 [1.10]	IP65	Al	58 [2.28]	58 [2.28]
	HBS0	11 [0.43]	28 [1.10]	IP65	Al	58 [2.28]	58 [2.28]
	HCS0	12 [0.47]	28 [1.10]	IP65	Al	58 [2.28]	58 [2.28]
	HTS0	12.7 [1/2]	28 [1.10]	IP65	Al	58 [2.28]	58 [2.28]
	HES0	14 [0.55]	28 [1.10]	IP65	Al	58 [2.28]	58 [2.28]
	HUS0	14.9 [5/8]	28 [1.10]	IP65	Al	58 [2.28]	58 [2.28]
	HFS0	15 [0.59]	28 [1.10]	IP65	Al	58 [2.28]	58 [2.28]
	HGS0	16 [0.63]	28 [1.10]	IP65	Al	58 [2.28]	58 [2.28]
	H6Y0	6 [0.24]	28 [1.10]	IP65	Al	58 [2.28]	58 [2.28]
	HRY0	6.35 [1/4]	28 [1.10]	IP65	Al	58 [2.28]	58 [2.28]
	H8Y0	8 [0.31]	28 [1.10]	IP65	Al	58 [2.28]	58 [2.28]
	HSY0	9.52 [3/8]	28 [1.10]	IP65	Al	58 [2.28]	58 [2.28]
	HAY0	10 [0.39]	28 [1.10]	IP65	Al	58 [2.28]	58 [2.28]
	HBY0	11 [0.43]	28 [1.10]	IP65	Al	58 [2.28]	58 [2.28]
	HCY0	12 [0.47]	28 [1.10]	IP65	Al	58 [2.28]	58 [2.28]
	HTY0	12.7 [1/2]	28 [1.10]	IP65	Al	58 [2.28]	58 [2.28]
	HEY0	14 [0.55]	28 [1.10]	IP65	Al	58 [2.28]	58 [2.28]
	HUY0	14.9 [5/8]	28 [1.10]	IP65	Al	58 [2.28]	58 [2.28]
	HFY0	15 [0.59]	28 [1.10]	IP65	Al	58 [2.28]	58 [2.28]
	HGY0	16 [0.63]	28 [1.10]	IP65	Al	58 [2.28]	58 [2.28]
	H6SS	6 [0.24]	28 [1.10]	IP67	Al	58 [2.28]	58 [2.28]
	HRSS	6.35 [1/4]	28 [1.10]	IP67	Al	58 [2.28]	58 [2.28]
	H8SS	8 [0.31]	28 [1.10]	IP67	Al	58 [2.28]	58 [2.28]
	HSSS	9.52 [3/8]	28 [1.10]	IP67	Al	58 [2.28]	58 [2.28]
	HASS	10 [0.39]	28 [1.10]	IP67	Al	58 [2.28]	58 [2.28]
	HBSS	11 [0.43]	28 [1.10]	IP67	Al	58 [2.28]	58 [2.28]
	HCSS	12 [0.47]	28 [1.10]	IP67	Al	58 [2.28]	58 [2.28]
	HTSS	12.7 [1/2]	28 [1.10]	IP67	Al	58 [2.28]	58 [2.28]
	HESS	14 [0.55]	28 [1.10]	IP67	Al	58 [2.28]	58 [2.28]
	HUSS	14.9 [5/8]	28 [1.10]	IP67	Al	58 [2.28]	58 [2.28]
	HFSS	15 [0.59]	28 [1.10]	IP67	Al	58 [2.28]	58 [2.28]
	HGSS	16 [0.63]	28 [1.10]	IP67	Al	58 [2.28]	58 [2.28]

All dimension in mm [inch]; Al: Aluminum; 303: Stainless Steel V2A (1.4305, 303); 316 L: Stainless Steel V4A (1.4404, 316 L)

IXARC ROTARY ENCODERS

Technical Drawings – Flange

> Flange Design: Blind Hollow Shaft

	Type Key	Shaft Diameter (D)	Shaft Depth (L)	Protection Class	Material	Flange Size Ø	Housing Compatibility
	H6SV	6 [0.24]	28 [1.10]	IP67	303	58 [2.28]	58 [2.28]
	HRSV	6.35 [1/4]	28 [1.10]	IP67	303	58 [2.28]	58 [2.28]
	H8SV	8 [0.31]	28 [1.10]	IP67	303	58 [2.28]	58 [2.28]
	HSSV	9.52 [3/8]	28 [1.10]	IP67	303	58 [2.28]	58 [2.28]
	HASV	10 [0.39]	28 [1.10]	IP67	303	58 [2.28]	58 [2.28]
	HBSV	11 [0.43]	28 [1.10]	IP67	303	58 [2.28]	58 [2.28]
	HCSV	12 [0.47]	28 [1.10]	IP67	303	58 [2.28]	58 [2.28]
	HTSV	12.7 [1/2]	28 [1.10]	IP67	303	58 [2.28]	58 [2.28]
	HESV	14 [0.55]	28 [1.10]	IP67	303	58 [2.28]	58 [2.28]
	HUSV	14.9 [5/8]	28 [1.10]	IP67	303	58 [2.28]	58 [2.28]
	HFSV	15 [0.59]	28 [1.10]	IP67	303	58 [2.28]	58 [2.28]
	HGSV	16 [0.63]	28 [1.10]	IP67	303	58 [2.28]	58 [2.28]
	X6S0	6 [0.24]	28 [1.10]	IP65	Al	58 [2.28]	58 [2.28]
	XRS0	6.35 [1/4]	28 [1.10]	IP65	Al	58 [2.28]	58 [2.28]
	X8S0	8 [0.31]	28 [1.10]	IP65	Al	58 [2.28]	58 [2.28]
	XSS0	9.52 [3/8]	28 [1.10]	IP65	Al	58 [2.28]	58 [2.28]
	XAS0	10 [0.39]	28 [1.10]	IP65	Al	58 [2.28]	58 [2.28]
	XBS0	11 [0.43]	28 [1.10]	IP65	Al	58 [2.28]	58 [2.28]
	XCS0	12 [0.47]	28 [1.10]	IP65	Al	58 [2.28]	58 [2.28]
	XTS0	12.7 [1/2]	28 [1.10]	IP65	Al	58 [2.28]	58 [2.28]
	XES0	14 [0.55]	28 [1.10]	IP65	Al	58 [2.28]	58 [2.28]
	XUS0	14.9 [5/8]	28 [1.10]	IP65	Al	58 [2.28]	58 [2.28]
	XFS0	15 [0.59]	28 [1.10]	IP65	Al	58 [2.28]	58 [2.28]
	XGS0	16 [0.63]	28 [1.10]	IP65	Al	58 [2.28]	58 [2.28]
	1H2S	12 [0.47]	16 [0.63]	IP67	Al	58 [2.28]	58 [2.28]
	1H2V	12 [0.47]	16 [0.63]	IP67	303	58 [2.28]	58 [2.28]
	1H2W	12 [0.47]	16 [0.63]	IP67	316 L	58 [2.28]	58 [2.28]

All dimension in mm [inch]; Al: Aluminum; 303: Stainless Steel V2A (1.4305, 303); 316 L: Stainless Steel V4A (1.4404, 316 L)

IXARC ROTARY ENCODERS

Technical Drawings – Flange

> **Flange Design: Blind Hollow Shaft**

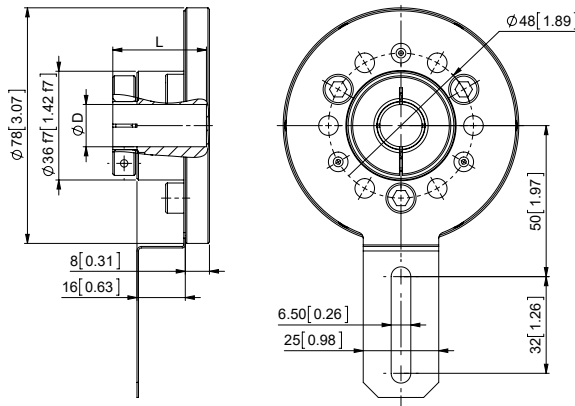

Type Key	Shaft Diameter (D)	Shaft Depth (L)	Protection Class	Material	Flange Size Ø	Housing Compatibility
E140	14 [0.55]	35 [1.38]	IP65	Al	78 [3.07]	78 [3.07]
E14S	14 [0.55]	35 [1.38]	IP67	Al	78 [3.07]	78 [3.07]
E14W	14 [0.55]	35 [1.38]	IP67	316 L	78 [3.07]	78 [3.07]

All dimension in mm [inch]; Al: Aluminum; 303: Stainless Steel V2A (1.4305, 303); 316 L: Stainless Steel V4A (1.4404, 316 L)

Sold & Serviced By:



Toll Free Phone (877) SERV098

www.electromate.com

sales@electromate.com

IXARC ROTARY ENCODERS

Technical Drawings – Flange

> Flange Design: Synchro

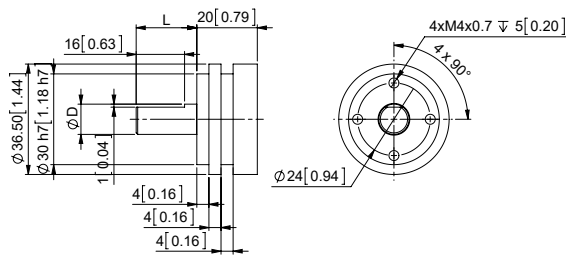
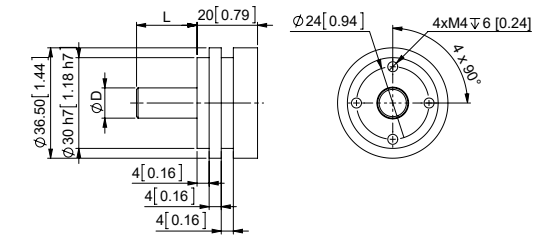
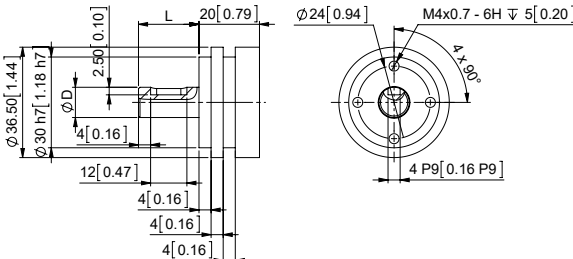
	Type Key	Shaft Diameter (D)	Shaft Length (L)	Protection Class	Material	Flange Size Ø	Housing Compatibility
	013D	10 [0.39]	20 [0.79]	IP69K	Al	36 [1.42]	36 [1.42]
	DRSD	6.35 [1/4]	12.7 [1/2]	IP69K	Al	36 [1.42]	36 [1.42]
	D06D	6 [0.24]	10 [0.39]	IP69K	Al	36 [1.42]	36 [1.42]
	D10D	10 [0.39]	20 [0.79]	IP69K	Al	36 [1.42]	36 [1.42]
	DA4D	10 [0.39]	20 [0.79]	IP69K	Al	36 [1.42]	36 [1.42]

All dimension in mm [inch]; Al: Aluminum; 303: Stainless Steel V2A (1.4305, 303); 316 L: Stainless Steel V4A (1.4404, 316 L)

IXARC ROTARY ENCODERS

Technical Drawings – Flange

➤ **Flange Design: Synchro**

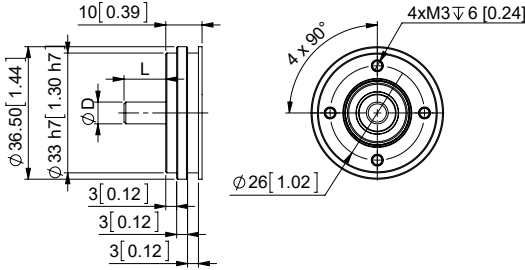
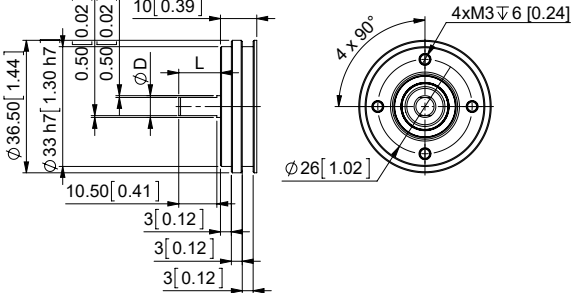
	Type Key	Shaft Diameter (D)	Shaft Length (L)	Protection Class	Material	Flange Size Ø	Housing Compatibility
	R060	6 [0.24]	11.5 [0.45]	IP65	Al	36 [1.42]	36 [1.42]
	R100	10 [0.39]	20 [0.79]	IP65	Al	36 [1.42]	36 [1.42]
	RA10	6 [0.24]	11.5 [0.45]	IP65	Al	36 [1.42]	36 [1.42]
	RAF0	10 [0.39]	15 [0.45]	IP65	Al	36 [1.42]	36 [1.42]

All dimension in mm [inch]; Al: Aluminum; 303: Stainless Steel V2A (1.4305, 303); 316 L: Stainless Steel V4A (1.4404, 316 L)

Sold & Serviced By:



Toll Free Phone (877) SERV098

www.electromate.com
sales@electromate.com

IXARC ROTARY ENCODERS

Technical Drawings – Flange

> Flange Design: Synchro

	Type Key	Shaft Diameter (D)	Shaft Length (L)	Protection Class	Material	Flange Size Ø	Housing Compatibility
	N060	6 [0.24]	10 [0.39]	IP65	Al	58 [2.28]	36 [1.42]
	N100	10 [0.39]	20 [0.79]	IP65	Al	58 [2.28]	36 [1.42]
	N120	12 [0.47]	20 [0.79]	IP65	Al	58 [2.28]	36 [1.42]
	NA10	6 [0.24]	10 [0.39]	IP65	Al	58 [2.28]	36 [1.42]
	NAF0	10 [0.39]	20 [0.79]	IP65	Al	58 [2.28]	36 [1.42]

All dimension in mm [inch]; Al: Aluminum; 303: Stainless Steel V2A (1.4305, 303); 316 L: Stainless Steel V4A (1.4404, 316 L)

IXARC ROTARY ENCODERS

Technical Drawings – Flange

> Flange Design: Synchro

	Type Key	Shaft Diameter (D)	Shaft Length (L)	Protection Class	Material	Flange Size Ø	Housing Compatibility
	S060	6 [0.24]	10 [0.39]	IP65	Al	58 [2.28]	58 [2.28]
	S100	10 [0.39]	20 [0.79]	IP65	Al	58 [2.28]	58 [2.28]
	S120	12 [0.47]	20 [0.79]	IP65	Al	58 [2.28]	58 [2.28]
	S06S	6 [0.24]	10 [0.39]	IP67	Al	58 [2.28]	58 [2.28]
	S10S	10 [0.39]	20 [0.79]	IP67	Al	58 [2.28]	58 [2.28]
	S12S	12 [0.47]	20 [0.79]	IP67	Al	58 [2.28]	58 [2.28]
	S06V	6 [0.24]	10 [0.39]	IP67	303	58 [2.28]	58 [2.28]
	S10V	10 [0.39]	20 [0.79]	IP67	303	58 [2.28]	58 [2.28]
	S12V	12 [0.47]	20 [0.79]	IP67	303	58 [2.28]	58 [2.28]
		SA10	6 [0.24]	10 [0.39]	IP65	Al	58 [2.28]
SA70		9.52 [3/8]	20 [0.79]	IP65	Al	58 [2.28]	58 [2.28]
	SB90	10 [0.39]	20 [0.79]	IP65	Al	58 [2.28]	58 [2.28]

All dimension in mm [inch]; Al: Aluminum; 303: Stainless Steel V2A (1.4305, 303); 316 L: Stainless Steel V4A (1.4404, 316 L)

IXARC ROTARY ENCODERS

Technical Drawings – Flange

> Flange Design: Synchro

	Type Key	Shaft Diameter (D)	Shaft Length (L)	Protection Class	Material	Flange Size Ø	Housing Compatibility	
	Y060	6 [0.24]	10 [0.39]	IP65	Al	58 [2.28]	58 [2.28]	
	Y100	10 [0.39]	20 [0.79]	IP65	Al	58 [2.28]	58 [2.28]	
	Y120	12 [0.47]	20 [0.79]	IP65	Al	58 [2.28]	58 [2.28]	
	YAFO	10 [0.39]	20 [0.79]	IP65	Al	58 [2.28]	58 [2.28]	
	Y06S	6 [0.24]	10 [0.39]	IP67	Al	58 [2.28]	58 [2.28]	
	Y10S	10 [0.39]	20 [0.79]	IP67	Al	58 [2.28]	58 [2.28]	
	Y12S	12 [0.47]	20 [0.79]	IP67	Al	58 [2.28]	58 [2.28]	
	Y06V	6 [0.24]	10 [0.39]	IP67	303	58 [2.28]	58 [2.28]	
	Y10V	10 [0.39]	20 [0.79]	IP67	303	58 [2.28]	58 [2.28]	
	Y12V	12 [0.47]	20 [0.79]	IP67	303	58 [2.28]	58 [2.28]	
		YA10	6 [0.24]	10 [0.39]	IP65	Al	58 [2.28]	58 [2.28]
		YA1S	6 [0.24]	10 [0.39]	IP67	Al	58 [2.28]	58 [2.28]
	YF10	10 [0.39]	20 [0.79]	IP65	Al	58 [2.28]	58 [2.28]	
	YF1S	10 [0.39]	20 [0.79]	IP67	Al	58 [2.28]	58 [2.28]	

All dimension in mm [inch]; Al: Aluminum; 303: Stainless Steel V2A (1.4305, 303); 316 L: Stainless Steel V4A (1.4404, 316 L)

IXARC ROTARY ENCODERS

Technical Drawings – Flange

> Flange Design: Synchro

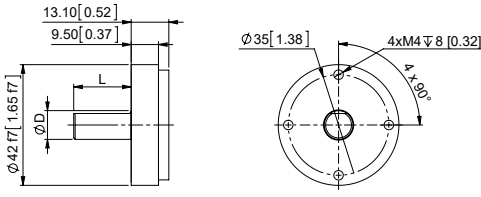
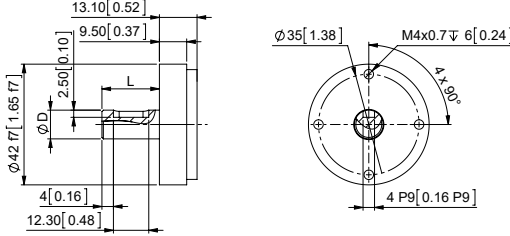
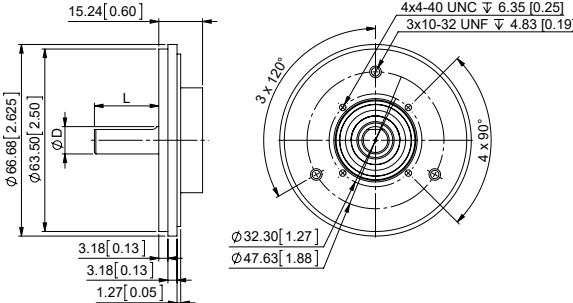
	Type Key	Shaft Diameter (D)	Shaft Length (L)	Protection Class	Material	Flange Size Ø	Housing Compatibility
	G10G	10 [0.39]	20 [0.79]	IP69K	316 L	42 [1.65]	42 [1.65]
	GA4G	10 [0.39]	20 [0.79]	IP69K	316 L	42 [1.65]	42 [1.65]
	A7W0	9.52 [3/8]	22.4 [0.88]	IP65	Al	66.7 [2.62]	36 [1.42]
	B4W0	6.35 [1/4]	22.4 [0.88]	IP65	Al	66.7 [2.62]	36 [1.42]

All dimension in mm [inch]; Al: Aluminum; 303: Stainless Steel V2A (1.4305, 303); 316 L: Stainless Steel V4A (1.4404, 316 L)

IXARC ROTARY ENCODERS

Technical Drawings – Flange

> Flange Design: Synchro

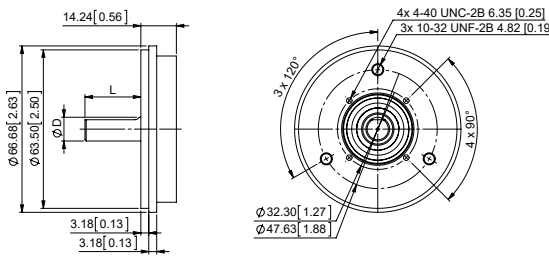
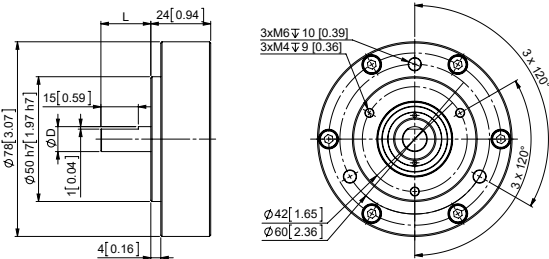
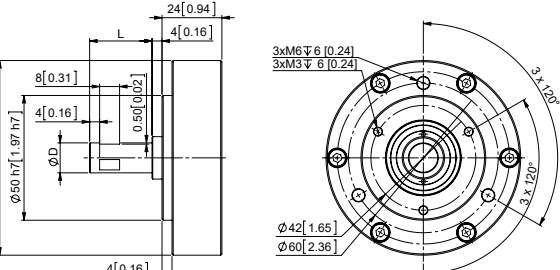
	Type Key	Shaft Diameter (D)	Shaft Length (L)	Protection Class	Material	Flange Size Ø	Housing Compatibility
	A7S0	9.52 [3/8]	22.4 [0.88]	IP65	Al	66.7 [2.62]	58 [2.28]
	B4S0	6.35 [1/4]	22.4 [0.88]	IP65	Al	66.7 [2.62]	58 [2.28]
	W100	10 [0.39]	20 [0.79]	IP65	Al	78 [3.07]	78 [3.07]
	W10S	10 [0.39]	20 [0.79]	IP67	Al	78 [3.07]	78 [3.07]
	W10W	10 [0.39]	20 [0.79]	IP67	316 L	78 [3.07]	78 [3.07]
	W120	12 [0.47]	20 [0.79]	IP65	Al	78 [3.07]	78 [3.07]
	W12S	12 [0.47]	20 [0.79]	IP67	Al	78 [3.07]	78 [3.07]
	W12W	12 [0.47]	20 [0.79]	IP67	316 L	78 [3.07]	78 [3.07]

All dimension in mm [inch]; Al: Aluminum; 303: Stainless Steel V2A (1.4305, 303); 316 L: Stainless Steel V4A (1.4404, 316 L)

IXARC ROTARY ENCODERS

Technical Drawings – Flange

> Flange Design: Clamp

	Type Key	Shaft Diameter (D)	Shaft Length (L)	Protection Class	Material	Flange Size Ø	Housing Compatibility
	F06S	6 [0.24]	15 [0.59]	IP65	Al	36 [1.42]	58 [2.28]
	01M0	6 [0.24]	12 [0.47]	IP65	Al	38 [1.5]	36 [1.42]
	02M0	6 [0.24]	15 [0.59]	IP65	Al	40 [1.57]	36 [1.42]

All dimension in mm [inch]; Al: Aluminum; 303: Stainless Steel V2A (1.4305, 303); 316 L: Stainless Steel V4A (1.4404, 316 L)

IXARC ROTARY ENCODERS

Technical Drawings – Flange

➤ Flange Design: Clamp

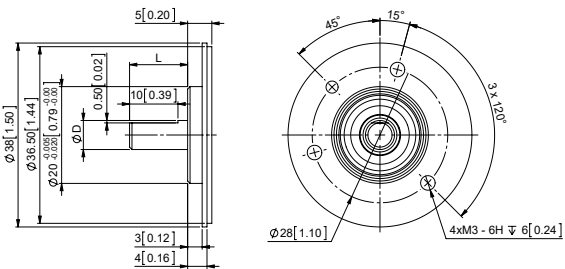
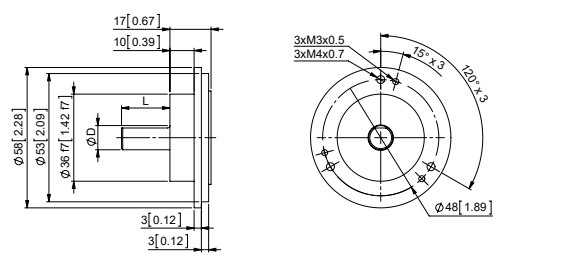
	Type Key	Shaft Diameter (D)	ShGACG	Protection Class	Material	Flange Size Ø	Housing Compatibility
 <p>Technical drawing of the 04M0 flange. The side view shows a total width of 5 [0.20] mm, a shaft diameter of 8 [0.31] mm, and a flange diameter of 36 [1.50] mm. The front view shows a 45° chamfered edge, a 15° chamfered edge, and four mounting holes of diameter 28 [1.10] mm. The mounting holes are spaced 3 x 3.02 mm apart.</p>	04M0	8 [0.31]	15 [0.59]	IP65	Al	40 [1.57]	36 [1.42]
 <p>Technical drawing of the GACG and DACD flanges. The side view shows a total width of 17 [0.67] mm, a shaft diameter of 10 [0.39] mm, and a flange diameter of 58 [2.28] mm. The front view shows a 15° chamfered edge, a 20° chamfered edge, and three mounting holes of diameter 48 [1.89] mm. The mounting holes are spaced 3 x 3 mm apart.</p>	GACG DACD	10 [0.39]	20 [0.79]	IP69K	316 L Al	58 [2.28]	42 [1.65] 36 [1.42]

All dimension in mm [inch]; Al: Aluminum; 303: Stainless Steel V2A (1.4305, 303); 316 L: Stainless Steel V4A (1.4404, 316 L)

IXARC ROTARY ENCODERS

Technical Drawings – Flange

> Flange Design: Clamp

	Type Key	Shaft Diameter (D)	Shaft Length (L)	Protection Class	Material	Flange Size Ø	Housing Compatibility
	03M0	6 [0.24]	15 [0.59]	IP65	Al	50 [1.97]	36 [1.42]
	05M0	8 [0.31]	15 [0.59]	IP65	Al	50 [1.97]	36 [1.42]
	C4M0	6.35 [1/4]	16 [0.62]	IP65	Al	50.8 [2]	36 [1.42]

All dimension in mm [inch]; Al: Aluminum; 303: Stainless Steel V2A (1.4305, 303); 316 L: Stainless Steel V4A (1.4404, 316 L)

IXARC ROTARY ENCODERS

Technical Drawings – Flange

> Flange Design: Clamp

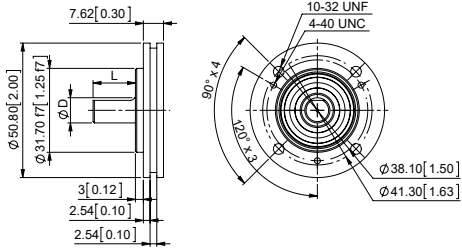
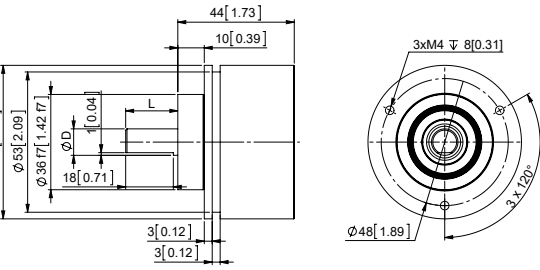
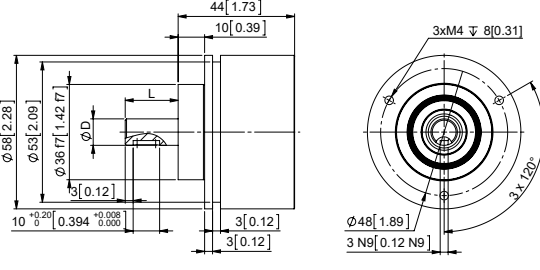
	Type Key	Shaft Diameter (D)	Shaft Length (L)	Protection Class	Material	Flange Size Ø	Housing Compatibility
	D1M0	9.52 [3/8]	16 [0.62]	IP65	Al	50.8 [2]	36 [1.42]
	A0LS A0LV A0LW	10 [0.39]	20 [0.79]	IP67	Al 303 316 L	58 [2.28]	58 [2.28]
	AKLS AKLV AKLW	10 [0.39]	20 [0.79]	IP67	Al 303 316 L	58 [2.28]	58 [2.28]

All dimension in mm [inch]; Al: Aluminum; 303: Stainless Steel V2A (1.4305, 303); 316 L: Stainless Steel V4A (1.4404, 316 L)

IXARC ROTARY ENCODERS

Technical Drawings – Flange

> Flange Design: Clamp

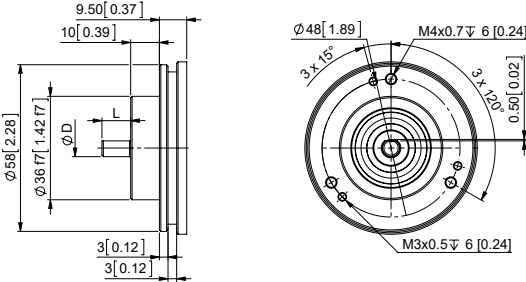
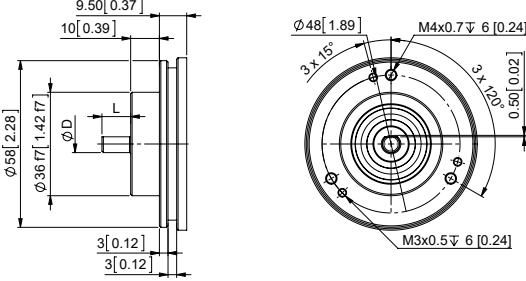
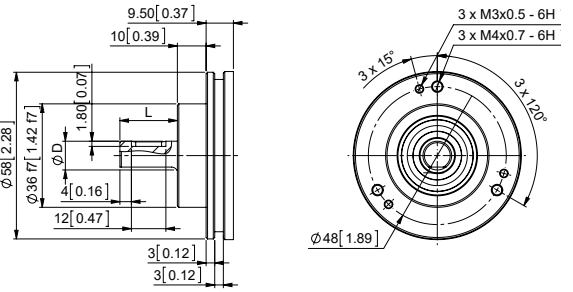
	Type Key	Shaft Diameter (D)	Shaft Length (L)	Protection Class	Material	Flange Size Ø	Housing Compatibility
	C060	6 [0.24]	10 [0.39]	IP65	Al	58 [2.28]	58 [2.28]
	C100	10 [0.39]	20 [0.79]	IP65	Al	58 [2.28]	58 [2.28]
	C120	12 [0.47]	20 [0.79]	IP65	Al	58 [2.28]	58 [2.28]
	C10H	10 [0.39]	20 [0.79]	IP67	Al	58 [2.28]	58 [2.28]
	C06S	6 [0.24]	10 [0.39]	IP67	Al	58 [2.28]	58 [2.28]
	C10S	10 [0.39]	20 [0.79]	IP67	Al	58 [2.28]	58 [2.28]
	C12S	12 [0.47]	20 [0.79]	IP67	Al	58 [2.28]	58 [2.28]
	C06V	6 [0.24]	10 [0.39]	IP67	303	58 [2.28]	58 [2.28]
	C10V	10 [0.39]	20 [0.79]	IP67	303	58 [2.28]	58 [2.28]
	C12V	12 [0.47]	20 [0.79]	IP67	303	58 [2.28]	58 [2.28]
	C10W	10 [0.39]	20 [0.79]	IP67	316 L	58 [2.28]	58 [2.28]
	CA7V	9.52 [3/8]	20 [0.79]	IP67	303	58 [2.28]	58 [2.28]
	CA30	10 [0.39]	20 [0.79]	IP65	Al	58 [2.28]	58 [2.28]

All dimension in mm [inch]; Al: Aluminum; 303: Stainless Steel V2A (1.4305, 303); 316 L: Stainless Steel V4A (1.4404, 316 L)

IXARC ROTARY ENCODERS

Technical Drawings – Flange

➤ Flange Design: Clamp

	Type Key	Shaft Diameter (D)	Shaft Length (L)	Protection Class	Material	Flange Size Ø	Housing Compatibility
<p>Side view dimensions: 9.50 [0.37], 10 [0.39], Ø58 [2.28], Ø36 f7 [1.42 f7], Ø4 G6 [0.16 G6], 12 [0.47], 3 [0.12], 3 [0.12]. Top view dimensions: 3 x M3x0.5 - 6H Ψ 6 [0.24], 3 x M4x0.7 - 6H Ψ 6 [0.24], 3 x 15°, 3 x 120°, Ø48 [1.89].</p>	CA80	10 [0.39]	20 [0.79]	IP65	Al	58 [2.28]	58 [2.28]
<p>Side view dimensions: 19.50 [0.77], 10 [0.39], Ø58 [2.28], Ø53 [2.09], Ø36 f7 [1.42 f7], ØD, L, 3 [0.12], 3 [0.12]. Top view dimensions: 3xM3 Ψ 6 [0.24], 3xM4 Ψ 6 [0.24], 15°, 3 x 120°, 2.50 [0.10], Ø48 [1.89].</p>	L060	6 [0.24]	10 [0.39]	IP65	Al	58 [2.28]	58 [2.28]
	L100	10 [0.39]	20 [0.79]	IP65	Al	58 [2.28]	58 [2.28]
	L120	12 [0.47]	20 [0.79]	IP65	Al	58 [2.28]	58 [2.28]
	LA30	10 [0.39]	20 [0.79]	IP67	Al	58 [2.28]	58 [2.28]
	LC40	12 [0.47]	20 [0.79]	IP65	Al	58 [2.28]	58 [2.28]
	L06S	6 [0.24]	10 [0.39]	IP67	Al	58 [2.28]	58 [2.28]
	L10S	10 [0.39]	20 [0.79]	IP67	Al	58 [2.28]	58 [2.28]
	L12S	12 [0.47]	20 [0.79]	IP67	Al	58 [2.28]	58 [2.28]
	L06V	6 [0.24]	10 [0.39]	IP67	303	58 [2.28]	58 [2.28]
	L10V	10 [0.39]	20 [0.79]	IP67	303	58 [2.28]	58 [2.28]
	L12V	12 [0.47]	20 [0.79]	IP67	303	58 [2.28]	58 [2.28]
	LD80	12 [0.47]	20 [0.79]	IP65	Al	58 [2.28]	58 [2.28]

All dimension in mm [inch]; Al: Aluminum; 303: Stainless Steel V2A (1.4305, 303); 316 L: Stainless Steel V4A (1.4404, 316 L)

Sold & Serviced By:



Toll Free Phone (877) SERV098

www.electromate.com
sales@electromate.com

IXARC ROTARY ENCODERS

Technical Drawings – Flange

➤ **Flange Design: Clamp**

	Type Key	Shaft Diameter (D)	Shaft Length (L)	Protection Class	Material	Flange Size Ø	Housing Compatibility
	B4F0	6.35 [1/4]	22.4 [0.88]	IP65	Al	63.5 [2.5]	36 [1.42]
	B4P0	6.35 [1/4]	22.4 [0.88]	IP65	Al	63.5 [2.5]	58 [2.28]
	C660	6 [0.24]	20 [0.79]	IP65	Al	65 [2.5]	58 [2.28]

All dimension in mm [inch]; Al: Aluminum; 303: Stainless Steel V2A (1.4305, 303); 316 L: Stainless Steel V4A (1.4404, 316 L)

Sold & Serviced By:



Toll Free Phone (877) SERV098

www.electromate.com

sales@electromate.com

IXARC ROTARY ENCODERS

Technical Drawings – Flange

> Flange Design: Through Hollow

	Type Key	Shaft Diameter (D)	Protection Class	Material	Flange Size Ø	Housing Compatibility
	H200	20 [0.78]	IP67	303	50 [1.97]	36 [1.42]
	T060 T080 T100 T120 T130	6 [0.24] 8 [0.31] 10 [0.39] 12 [0.47] 13 [0.51]	IP65	Al	58 [2.28]	58 [2.28]

All dimension in mm [inch]; Al: Aluminum; 303: Stainless Steel V2A (1.4305, 303); 316 L: Stainless Steel V4A (1.4404, 316 L)

IXARC ROTARY ENCODERS

Technical Drawings – Flange

> Flange Design: Square

	Type Key	Shaft Diameter (D)	Shaft Length (L)	Protection Class	Material	Flange Size □	Housing Compatibility
	3A70	9.52 [3/8]	16 [0.63]	IP65	Al	52.3 [2]	36 [1.42]
	3C40	6.35 [1/4]	16 [0.63]	IP65	Al	52.3 [2]	36 [1.42]
	3A7S	9.52 [3/8]	16 [0.63]	IP67	Al	52.3 [2]	36 [1.42]
	8R10	6.35 [1/4]	15 [0.59]	IP65	Al	52.3 [2]	36 [1.42]
	8S10	9.52 [3/8]	15 [0.59]	IP65	Al	52.3 [2]	36 [1.42]
	9A7V	9.52 [3/8]	20 [0.79]	IP67	303	63.5 [2.5]	58 [2.28]
	9A70	9.52 [3/8]	20 [0.79]	IP65	Al	63.5 [2.5]	58 [2.28]
	9A7S	9.52 [3/8]	20 [0.79]	P67	Al	63.5 [2.5]	58 [2.28]

All dimension in mm [inch]; Al: Aluminum; 303: Stainless Steel V2A (1.4305, 303); 316 L: Stainless Steel V4A (1.4404, 316 L)

IXARC ROTARY ENCODERS

Technical Drawings – Flange

> Flange Design: Square

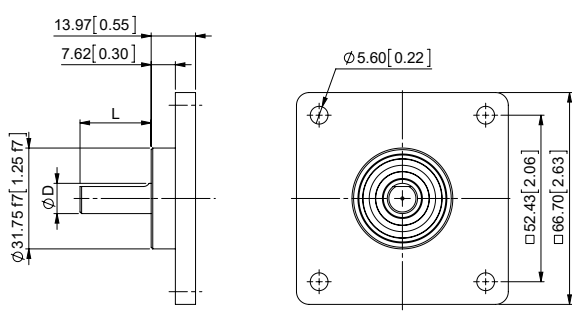
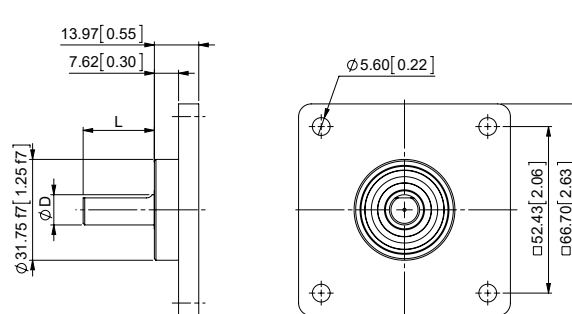
	Type Key	Shaft Diameter (D)	Shaft Length (L)	Protection Class	Material	Flange Size □	Housing Compatibility
	4A70	9.52 [3/8]	22.4 [0.88]	IP65	Al	63.5 [2.5]	36 [1.42]
	4B40	6.35 [1/4]	22.4 [0.88]	IP65	Al	63.5 [2.5]	36 [1.42]
	4A7S	9.52 [3/8]	22.4 [0.88]	IP67	Al	63.5 [2.5]	36 [1.42]
	5A70	9.52 [3/8]	22.4 [0.88]	IP65	Al	63.5 [2.5]	58 [2.28]
	5B40	6.35 [1/4]	22.4 [0.88]	IP65	Al	63.5 [2.5]	58 [2.28]
	5A7S	9.52 [3/8]	22.4 [0.88]	IP67	Al	63.5 [2.5]	58 [2.28]

All dimension in mm [inch]; Al: Aluminum; 303: Stainless Steel V2A (1.4305, 303); 316 L: Stainless Steel V4A (1.4404, 316 L)

Sold & Serviced By:



Toll Free Phone (877) SERV098

www.electromate.com

sales@electromate.com

IXARC ROTARY ENCODERS

Technical Drawings – Flange

> Flange Design: Square

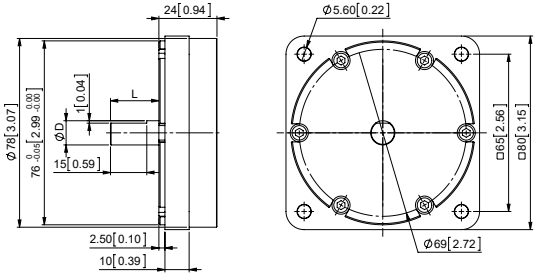
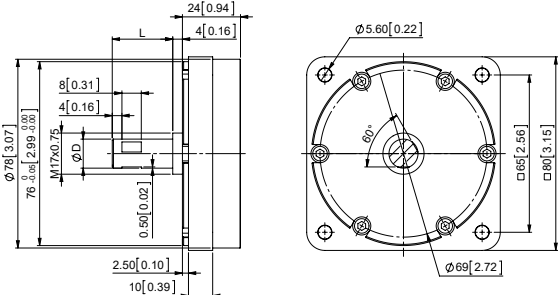
	Type Key	Shaft Diameter (D)	Shaft Length (L)	Protection Class	Material	Flange Size □	Housing Compatibility
	Z100	10 [0.39]	20 [0.79]	IP65	Al	80 [3.14]	78 [3.07]
	Z10S	10 [0.39]	20 [0.79]	IP67	Al	80 [3.14]	78 [3.07]
	Z10W	10 [0.39]	20 [0.79]	IP67	316 L	80 [3.14]	78 [3.07]
	Z120	12 [0.47]	20 [0.79]	IP65	Al	80 [3.14]	78 [3.07]
	Z12S	12 [0.47]	20 [0.79]	IP67	Al	80 [3.14]	78 [3.07]
	Z12W	12 [0.47]	20 [0.79]	IP67	316 L	80 [3.14]	78 [3.07]

All dimension in mm [inch]; Al: Aluminum; 303: Stainless Steel V2A (1.4305, 303); 316 L: Stainless Steel V4A (1.4404, 316 L)

IXARC ROTARY ENCODERS

Technical Drawings – Housing

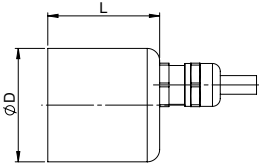
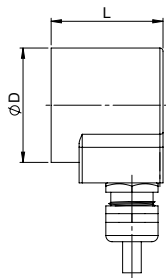
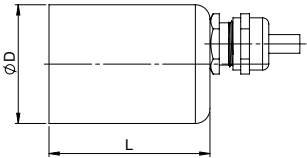
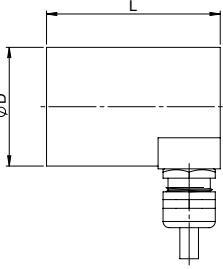
		Housing Compatibility (D)	Length (L)	Orientation of Connection	Material
		36 [1.42]	36 [1.42]	Axial	Steel
		36 [1.42]	32 [1.26]	Radial	Steel
		36 [1.42]	36 [1.42]	Radial	Steel
		36 [1.42]	40.5 [1.59]	Radial	Steel
		42 [1.65]	51.8 [2.04]	Axial	316 L
		42 [1.65]	55.9 [2.2]	Radial	316 L

All dimension in mm [inch]; Al: Aluminum; 303: Stainless Steel V2A (1.4305, 303); 316 L: Stainless Steel V4A (1.4404, 316 L)

IXARC ROTARY ENCODERS

Technical Drawings – Housing

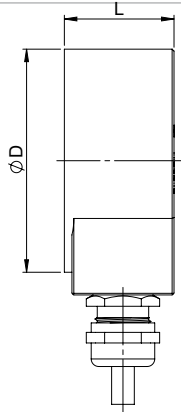
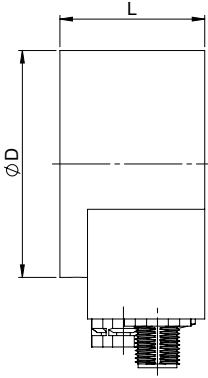
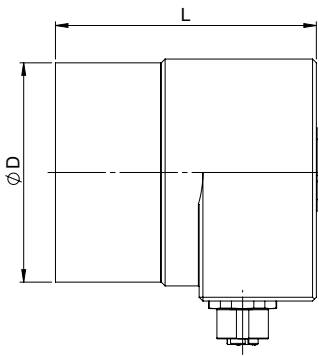
	Housing Compatibility (D)	Length (L)	Orientation of Connection	Material
	58 [2.28]	29 [1.14]	Radial	Al
	58 [2.28]	41.5 [1.63]	Radial	Al
	58 [2.28]	32 [1.26]	Radial	Al
	58 [2.28]	43.5 [1.71]	Radial	Al
	58 [2.28]	61 [2.4]	Radial	Al
	58 [2.28]	79 [3.11]	Radial	Al
	58 [2.28]	85 [3.35]	Radial	Al
	58 [2.28]	69 [2.72]	Radial	303

All dimension in mm [inch]; Al: Aluminum; 303: Stainless Steel V2A (1.4305, 303); 316 L: Stainless Steel V4A (1.4404, 316 L)

IXARC ROTARY ENCODERS

Technical Drawings – Housing

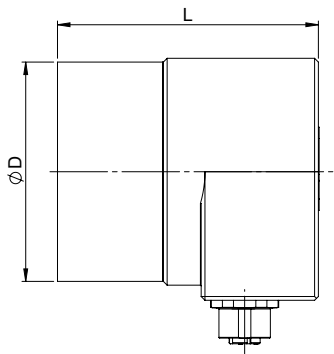
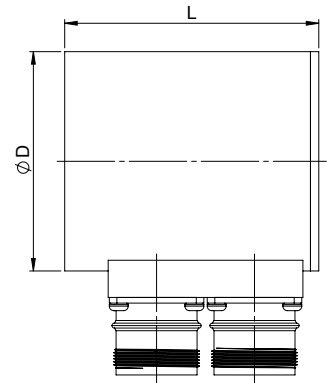
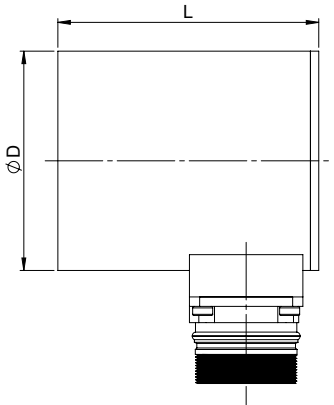
	Housing Compatibility (D)	Length (L)	Orientation of Connection	Material
	58 [2.28]	61 [2.4]	Radial	303
	58 [2.28]	65 [2.56]	Radial	303
	58 [2.28]	79 [3.11]	Radial	303
	58 [2.28]	85 [3.35]	Radial	303
	58 [2.28]	65 [2.56]	Radial	Brass
	58 [2.28]	69 [2.72]	Radial	Brass

All dimension in mm [inch]; Al: Aluminum; 303: Stainless Steel V2A (1.4305, 303); 316 L: Stainless Steel V4A (1.4404, 316 L)

IXARC ROTARY ENCODERS

Technical Drawings – Housing

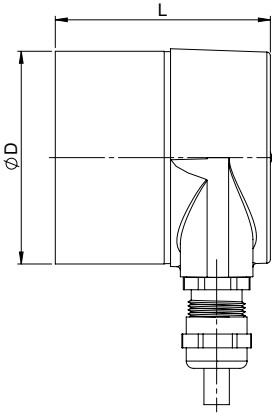
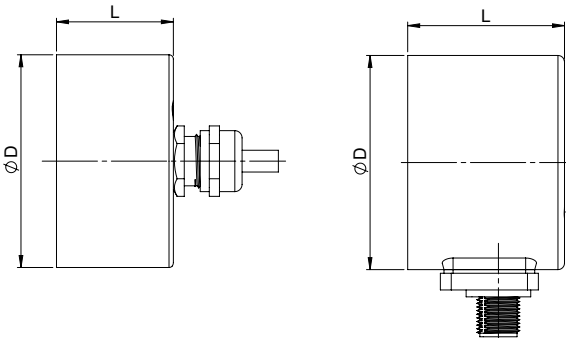
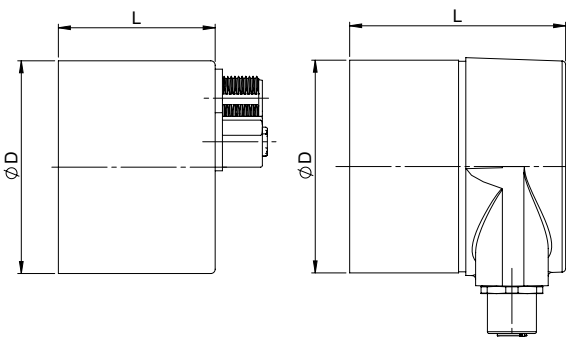
		Housing Compatibility (D)	Length (L)	Orientation of Connection	Material
		58 [2.28]	32 [1.26]	Radial	Steel
		58 [2.28]	43 [1.69]	Radial	Steel
		58 [2.28]	52.8 [2.08]	Radial	Steel
		58 [2.28]	32.2 [1.27]	Axial	Steel
		58 [2.28]	43 [1.69]	Axial	Steel
		58 [2.28]	43.2 [1.7]	Axial	Steel
		58 [2.28]	53 [2.09]	Axial	Steel
		58 [2.28]	53 [2.09]	Axial	Steel
		58 [2.28]	43.2 [1.7]	Radial	Steel
		58 [2.28]	43.2 [1.7]	Axial	Steel
		58 [2.28]	53 [2.09]	Axial	Steel
		58 [2.28]	59.5 [2.34]	Radial	Steel
		58 [2.28]	67.7 [2.67]	Radial	Steel
		58 [2.28]	70.5 [2.78]	Radial	Steel
		58 [2.28]	78.7 [3.1]	Radial	Steel

All dimension in mm [inch]; Al: Aluminum; 303: Stainless Steel V2A (1.4305, 303); 316 L: Stainless Steel V4A (1.4404, 316 L)

IXARC ROTARY ENCODERS

Technical Drawings – Housing

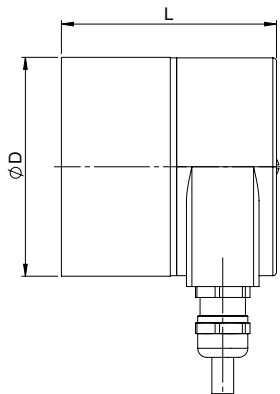
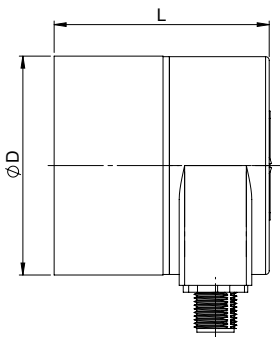
	Housing Compatibility (D)	Length (L)	Orientation of Connection	Material
	61 [2,4]	32 [1.26]	Radial	303
	61 [2,4]	43 [1.69]	Radial	303
	61 [2,4]	52.8 [2.08]	Radial	303
	61 [2,4]	59.5 [2.34]	Radial	303
	61 [2,4]	67.7 [2.67]	Radial	303
	61 [2,4]	70.5 [2.78]	Radial	303
	61 [2,4]	78.7 [3.1]	Radial	303
	61 [2,4]	70.5 [2.78]	Radial	303
	61 [2,4]	69 [2.72]	Radial	303

All dimension in mm [inch]; Al: Aluminum; 303: Stainless Steel V2A (1.4305, 303); 316 L: Stainless Steel V4A (1.4404, 316 L)

Sold & Serviced By:



Toll Free Phone (877) SERV098

www.electromate.com

sales@electromate.com

IXARC ROTARY ENCODERS

Technical Drawings – Housing

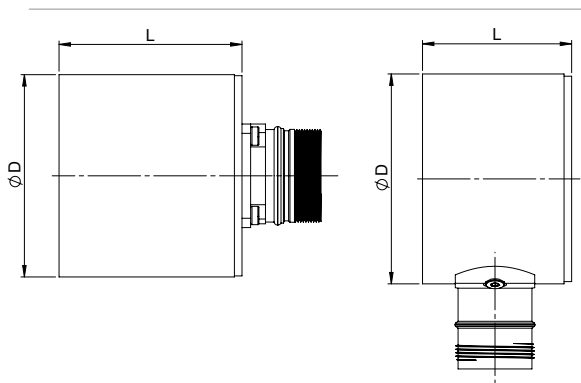
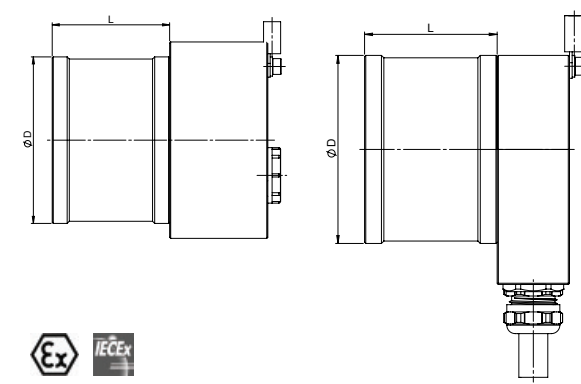
		Housing Compatibility (D)	Length (L)	Orientation of Connection	Material
		61 [2.4]	32,2 [1,27]	Axial	303
		61 [2.4]	43,2 [1,7]	Axial	303
		61 [2.4]	43,2 [1,7]	Axial	303
		61 [2.4]	53 [2,09]	Axial	303
		61 [2.4]	43,2 [1,7]	Radial	303
		78 [3.07]	55 [2.17]	Axial	Al
		78 [3.07]	55 [2.17]	Axial	303
		78 [3.07]	55 [2.17]	Radial	Al
		78 [3.07]	55 [2.17]	Radial	303
		78 [3.07]	64 [2.52]	Radial	Al
		78 [3.07]	64 [2.52]	Radial	303



All dimension in mm [inch]; Al: Aluminum; 303: Stainless Steel V2A (1.4305, 303); 316 L: Stainless Steel V4A (1.4404, 316 L)

IXARC ROTARY ENCODERS

Technical Drawings – Housing

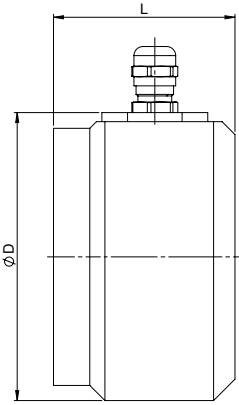
	Housing Compatibility (D)	Length (L)	Orientation of Connection	Material
	95 [3,74]	186.5 [7.34]	Radial	316 L
	95 [3,74]	60 [2.36]	Radial	316 L

All dimension in mm [inch]; Al: Aluminum; 303: Stainless Steel V2A (1.4305, 303); 316 L: Stainless Steel V4A (1.4404, 316 L)

Sold & Serviced By:
 **ELECTROMATE**
 Toll Free Phone (877) SERV098
www.electromate.com
sales@electromate.com

KIT ENCODERS

Fast.
Smart.
Efficient.



No Battery – Robust – Easy to Install

KIT ENCODERS

Easy Installation – No Maintenance



Innovative Technology

POSITAL's kit encoders offer a unique combination of accuracy, reliability and cost efficiency. Absolute measurement versions provide 17 bit electrical resolution and multiturn position measurements with a range of more than one million revolutions. A second version provides a combined incremental+UVW output with a resolution of up to 16384 PPR. Kit encoder components include an electronics package mounted on a compact 35 mm diameter PCB and a small permanent magnet, designed to be mounted on the end of the motor's shaft. The electronics package includes four Hall-effect sensors, a powerful 32-bit microprocessor and a rotation counter powered by POSITAL's Wiegand energy harvesting system.

Energy Harvesting – No Battery

The energy harvesting system is based on the Wiegand effect and eliminates the need for backup batteries or complex gear systems. At any rotational speed, even the slowest, the Wiegand system

generates short, powerful voltage pulses with each complete revolution. These pulses supply enough power to activate the rotation counter and related electronics so that the encoder will keep count of complete rotations at all times, even if these occur when the external power supply is unavailable. This principle, which has proven itself since 2005, ensures reliable, maintenance-free multiturn absolute position measurements.

Advantages

POSITAL's contact free measurement technology has no moving parts and is highly resistant to shock and vibration. POSITAL's kit encoders are available with several non-proprietary electrical interfaces including BISS and SSI for absolute measurements, UVW and ABZ for incremental signals. Additional protocols based on the RS485 interface can be implemented.

- **Absolute Multiturn & Incremental Interface**
- **No Battery – No Maintenance**
- **No Ball Bearings & Compact Design**
- **Insensitive to Dust and Moisture**
- **High Shock and Vibration Resistance**

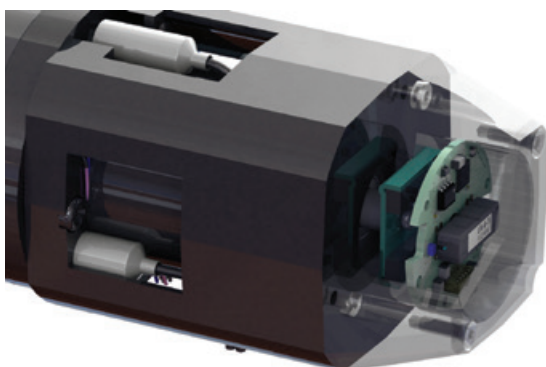

KIT ENCODERS

Absolute and Incremental – Robust and Programmable

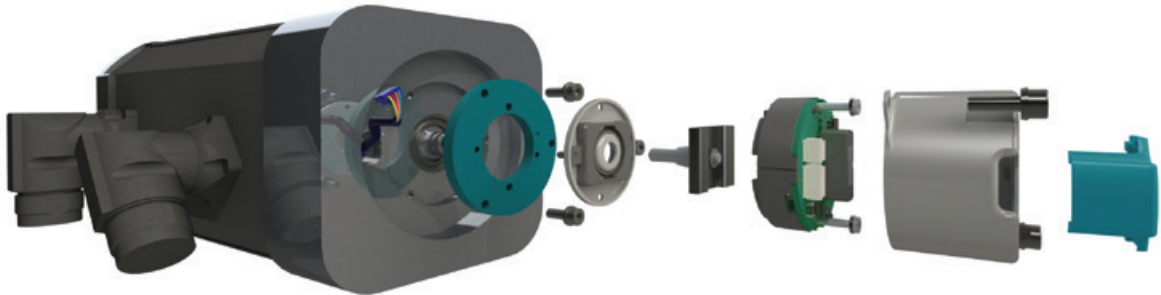

Plug and Play

While optical kit encoders typically require near clean-room assembly conditions, POSITAL's magnetic encoders are significantly less sensitive to dust and moisture and can be installed in normal factory settings. An integrated auto-calibration function eliminates the need for complex production equipment: during normal product testing, the encoder can be connected to a small Kit Control Box. As the shaft rotates, the auto-calibration system corrects for minor misalignment between the shaft and the electronics package. The Kit Control Box can also be used to program the encoder for important performance parameters such as the number of pulses generated per revolution, without requiring any changes to the mechanical or electrical components. This increases the versatility of the kit encoders.

The embedded software on the kit encoder will also monitor the health of the electronics package and provide diagnostic signals over the lifetime of the encoder. Compact and inexpensive shielding accessories are available to protect the electronic com-

ponents and Hall-effect sensors from external magnetic fields such as those generated by magnetic brakes.

Specifications

- > Electrical Resolution: Up to 17 Bit
- > Multiturn Range: Up to 32 Bit
- > Accuracy: 0.1°
- > Electrical Interface: BISS C, SSI, RS485, Incremental TTL up to 16384 PPR + UVW (2, 4, 6 or 8 poles)
- > Diameter: 36 mm
- > Height: 24.2 mm (Multiturn with Housing)
- > Temperature Range: -40 to +105°C
- > Rotational Speed: Up to 12000 RPM
- > Auto Calibration – No Complex Equipment
- > Cable Clip Ensures Proper Grounding and Easy Installation
- > Extensive Diagnostic Coverage
- > Various Programmable Parameters

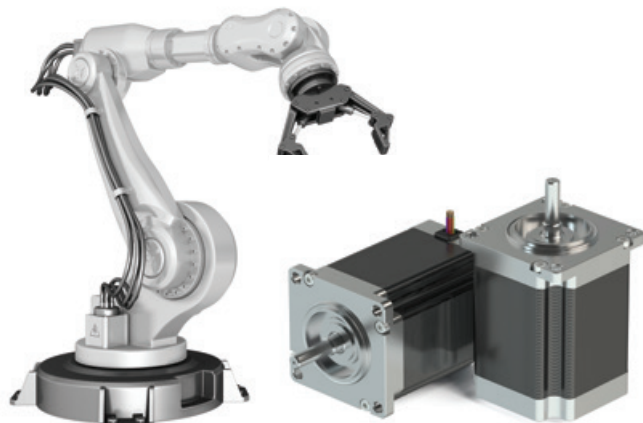

KIT ENCODERS

Technical Drawings

2 x Screw DIN 912 – M3 x 10 – 8.8
Tightening torque 1 ± 0.1 Nm

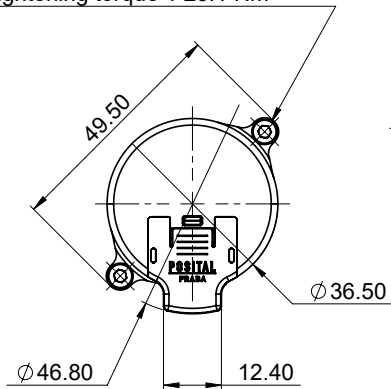

Centering pins
2 x $\phi 2.20$

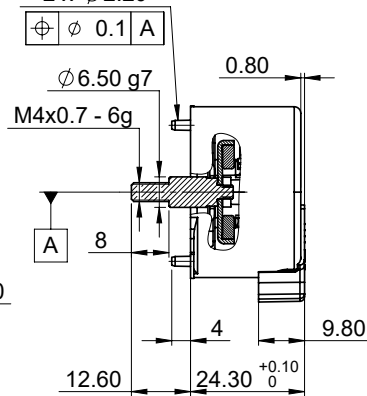

2 x Screw ISO 14580 – M2 x 8 – A4
Tightening torque 0.3 ± 0.1 Nm

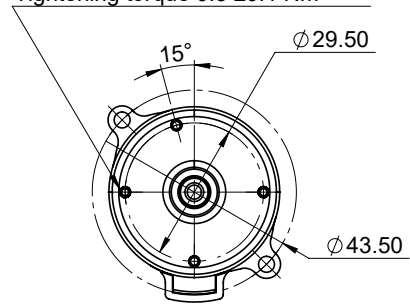

➤ No Battery – Robust – Easy to Install

- Absolute Multiturn & Incremental Interface
- No Battery – No Maintenance
- No Ball Bearings & Compact Design
- Insensitive to Dust and Moisture
- High Shock and Vibration Resistance

➤ Learn More



LINARIX LINEAR SENSORS



Robust Draw Wire Displacement Measurement

Sold & Serviced By:

 **ELECTROMATE**

Toll Free Phone (877) SERV098
www.electromate.com
sales@electromate.com

LINARIX LINEAR SENSORS

Repeatable Length Measurement



Technology

POSITAL's LINARIX draw wire sensors measure linear motion by displacing a stainless steel wire **A** wound around a wire drum **B** that actuates the rotary encoder **C** coupled to it via coupling **D**. A spring **E** is used to retract the wire in the housing. The encoder provides a proportional output. Measurements are highly accurate, reliable and the systems have very long lifetime.

The LINARIX line offers a wide range of measurement lengths ranging from 1 m to 30 m [3 to 98 ft] and position output in almost every available industrial interface both analog and digital as well as incremental and absolute. The line is featured with different mechanical options, housing materials and springs to enable you to always find the most suitable product for your application.

Compared to conventional linear pots and linear measurement systems using multiple gears and encoders LINARIX line are more durable and can be used to replace them directly avoiding common problems of slippage and wear. Draw wire sensors from POSITAL provide extremely precise measurements because of inherent accuracy of encoders while rugged construction ensures reliable performance even under extreme conditions.

POSITAL products listed below are classified according to interfaces and draw wire mechanics. Please use our online Product Finder to access entire data sheets.

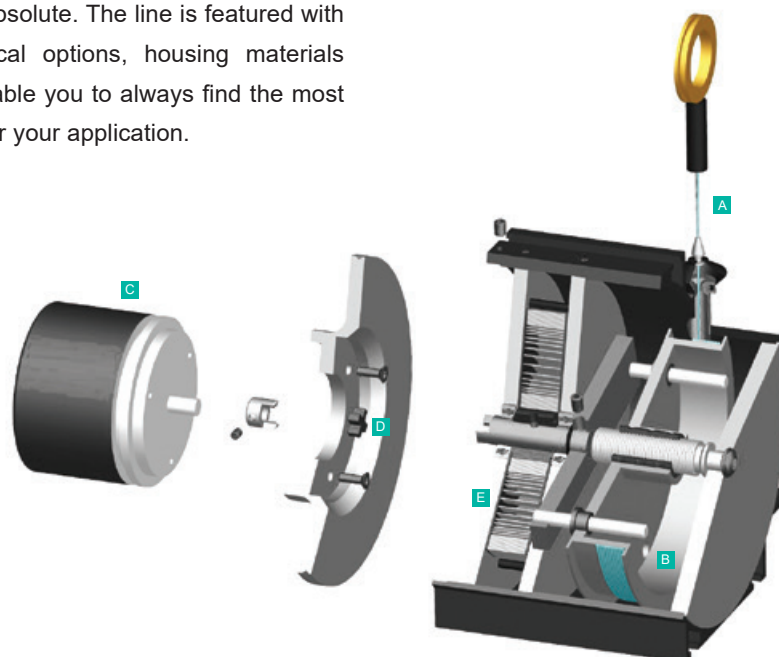

LINARIX LINEAR SENSORS

Product Overview – Linear Sensors

		Measuring Range in m [in]	Accuracy in [±%FSO]	Wire Diameter in mm [in]	Wire Material	Max. Extension Force in N	Min. Retraction Force in N	Linear Resolution in µm	Drum Circumference in mm [in]	Optical Encoder	Magnetic Encoder
	<ul style="list-style-type: none"> > Plastic > Compact Design > Enclosure: N 	1.25 [49]	0.05	0.36 [0.014]	Coated Polyamide Stainless Steel	1.50	1.00	31	125 [4.9]	■	■
	<ul style="list-style-type: none"> > Machined Metal > Cylindrical > Enclosure: P 	1.74 [69]	0.02	0.45 [0.017]	Coated Polyamide Stainless Steel	5.00	3.50	36	149 [5.9]	■	■
	<ul style="list-style-type: none"> > Machined Metal > Rectangular > Enclosure: C 	2.00 [79]	0.02	0.45 [0.017]	Plastic Coated Stainless Steel	2.00	1.20	24	100 [3.9]	■	■
	<ul style="list-style-type: none"> > Plastic > Compact Design > Enclosure: M 	2.10 [83]	0.05	0.45 [0.017]	Coated Polyamide Stainless Steel	5.00	3.50	52	215 [8.5]	■	■
	<ul style="list-style-type: none"> > Machined Metal > Rectangular > Enclosure: D 	3.00 [118]	0.01	0.87 [0.034]	Plastic Coated Stainless Steel	3.00	2.50	49	200 [7.9]	■	■
	<ul style="list-style-type: none"> > Extruded Metal > Compact Design > Enclosure: F 	3.00 [118]	0.02	0.80 [0.031]	Coated Polyamide Stainless Steel	10.0	5.0	63	260 [10.2]	■	■
	<ul style="list-style-type: none"> > Extruded Metal > Practical Mounting > Enclosure: G 	5.00 [197]	0.02	1.00 [0.039]	Nylon Coated Stainless Steel	16.0	4.0	77	315 [12.4]	■	■
	<ul style="list-style-type: none"> > Machined Metal > Rectangular > Enclosure: E 	6.00 [236]	0.01	0.54 [0.021]	Stainless Steel	8.00	3.0	40	200 [7.9]	■	■
	<ul style="list-style-type: none"> > Plastic > Compact Design > Enclosure: W 	7.50 [295]	0.05	0.45 [0.017]	Coated Polyamide Stainless Steel	13.00	7.0	81	333 [13.0]	■	■
	<ul style="list-style-type: none"> > Extruded Metal > Long Lifetime > Enclosure: H 	10.00 [394]	0.01	1.00 [0.039]	Nylon Coated Stainless Steel	21.0	8.0	77	315 [12.4]	■	■
	<ul style="list-style-type: none"> > Extruded Metal > Practical Mounting > Enclosure: R 	15.00 [591]	0.01	1.00 [0.039]	Nylon Coated Stainless Steel	21.0	25.0	77	315 [12.4]	■	■

LINARIX LINEAR SENSORS

Product Selection Guide – Incremental Linear Sensors



1 Technology

U ≤ 0.09° (Magnetic)

2 Communication Interface

IPT Programmable HTL/TTL, Default RS422 (TTL)

IPH Programmable HTL/TTL, Default Push-Pull (HTL)

3 Pulses per Revolution

XXXXX Programmable: Choose Any Pulse Count 1 to 16384

Default:

01000 1000 Pulses: Corresponds to 1 pulse per 100 µm

01250 1250 Pulses: Corresponds to 1 pulse per 100 µm

01500 1500 Pulses: Corresponds to 1 pulse per 100 µm

02000 2000 Pulses: Corresponds to 1 pulse per 100 µm

02150 2150 Pulses: Corresponds to 1 pulse per 100 µm

03333 3333 Pulses: Corresponds to 1 pulse per 100 µm

4 Draw Wire

Please See Technical Drawings on Page 81

5 Protection Class Encoder

A IP54

0 IP65

6 Connection Type

CAW Cable: Axial 1 m

2AW Cable: Axial 2 m

5AW Cable: Axial 5 m

AAW Cable: Axial 10 m

CRW Cable: Radial 1 m

2RW Cable: Radial 2 m

5RW Cable: Radial 5 m

ARW Cable: Radial 10 m

PAM Connector: Axial M12, 5 pin

PAL Connector: Axial M23, 12 pin

PRM Connector: Radial M12, 5 pin

PRQ Connector: Radial M12, 8 pin

PRL Connector: Radial M23, 12 pin

PRD Connector: Radial MIL MS14

PRE Connector: Radial MIL MS16

PRF Connector: Radial MIL MS18



> UBIFAST Configuration Tool

- Compact Housing with WLAN to Create Hotspot
- Connects to Smart Phone/ Tablets/ Notebooks
- Web Browser Based Simple Programming
- Configuration Data Sent Back to POSITAL via E-mail
- Parameters to Program: PPR, Resolution, Number of Turns, Direction

> Learn More



LINARIX LINEAR SENSORS

Product Selection Guide – Analog and Parallel Linear Sensors

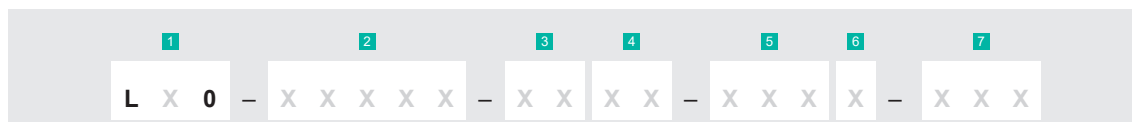

1 Accuracy (Technology)

U ≤ 0.09° (Magnetic)

D ≤ 0.022° (Optical)

2 Communication Interface

AV001 Analog Voltage: 0 to 5 V

AV002 Analog Voltage: 0 to 10 V

AV003 Analog Voltage: 0.5 to 4.5 V

AV004 Analog Voltage: 0.5 to 9.5 V

AC005 Analog Current: 4 to 20 mA

AC006 Analog Current: 0 to 20 mA

AVP01 Analog Voltage: 0 to 5 V w. Pushbuttons

AVP02 Analog Voltage: 0 to 10 V w. Pushbuttons

AVP03 Analog Voltage: 0.5 to 4.5 V w. Pushbuttons

AVP04 Analog Voltage: 0.5 to 9.5 V w. Pushbuttons

ACP05 Analog Current: 4 to 20 mA w. Pushbuttons

ACP06 Analog Current: 0 to 20 mA w. Pushbuttons

PPA1B Parallel Binary

P1A1B Parallel Preset Binary

PPA1G Parallel Gray

P1A1G Parallel Preset Gray

PP00E Parallel Excess Gray

P100E Parallel Preset Excess Gray

3 Revolution

00 Singleturn

04 Multiturn: 4 bit (16 rev)

07 Multiturn: 8 bit (128 rev)

08 Multiturn: 8 bit (256 rev)

12 Multiturn: 12 bit (4096 rev)

14 Multiturn: 14 bit (16384 rev)

4 Resolution

AA 9 bit (512 Steps / 0.7°) Parallel only

12 12 bit (4096 Steps / 0.088°)

13 13 bit (8192 Steps / 0.044°)

16 16 bit (65536 Steps / 0.005°)

5 Draw Wire

Please See Technical Drawings on Page 81

6 Protection Class

A IP54

0 IP64/IP65

7 Connection Type

CAW Cable: Axial 1 m

2AW Cable: Axial 2 m

5AW Cable: Axial 5 m

AAW Cable: Axial 10 m

CRW Cable: Radial 1 m

2RW Cable: Radial 2 m

5RW Cable: Radial 5 m

ARW Cable: Radial 10 m

PAM Connector: Axial M12, 5 pin (Analog)

PAP Connector: Axial M23, 16 pin (Parallel)

PAT Connector: Axial M27, 26 pin (Parallel)

PRM Connector: Radial M12, 5 pin (Analog)

PRP Connector: Radial M23, 16 pin (Parallel)

PRT Connector: Radial M27, 26 pin (Parallel)

Sold & Serviced By:



Toll Free Phone (877) SERV098

www.electromate.com

sales@electromate.com

LINARIX LINEAR SENSORS

Product Selection Guide – SSI/SSI+Incremental Linear Sensors

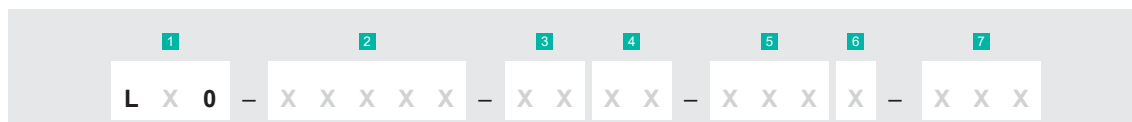

1 Accuracy (Technology)

U ≤ 0.09° (Magnetic)

D ≤ 0.022° (Optical)

2 Communication Interface

S101B SSI Binary

SLF1B SSI Binary Fast

S101G SSI Gray

S101E SSI Excess-Gray

SHPPP Programmable SSI+Incr. Push-Pull (HTL) 4.75 to 30 VDC

SRPPP Programmable SSI+Incr. RS422 (TTL) 8 to 30 VDC

SSPPP Programmable SSI+Incr. RS422 (TTL) 5 VDC

SHxxB SSI+Incr. Binary + A/B/Z (Push-Pull) 4.75 to 30 VDC

SRxxB SSI+Incr. Binary + A/B/Z (RS-422) 8 to 30 VDC

SSxxB SSI+Incr. Binary+ A/B/Z (RS-422) 5 VDC

SHxxG SSI+Incr. Gray + A/B/Z (Push-Pull) 4.75 to 30 VDC

SRxxG SSI+Incr. Gray + A/B/Z (RS-422) 8 to 30 VDC

SSxxG SSI+Incr. Gray + A/B/Z (RS-422) 5 VDC

S401B SSI Binary w. Pushbuttons

S401G SSI Gray w. Pushbuttons

S3xxG SSI Gray+Incr. A/B/Z (RS-422)

S3xxB SSI Binary+Incr. A/B/Z (RS-422)

S5xxB SSI Binary+Incr. A/B/Z (RS-422)

S6xxB SSI Binary+Incr. A/B/Z (Push-Pull)

S5xxG SSI Gray+Incr. A/B/Z (RS-422)

S6xxG SSI Gray+Incr. A/B/Z (Push-Pull)

3 Revolution

00 Singleturn

04 Multiturn: 4 bit (16 rev)

08 Multiturn: 8 bit (256 rev)

12 Multiturn: 12 bit (4096 rev)

13 Multiturn: 13 bit (8192 rev)

14 Multiturn: 14 bit (16384 rev)

16 Multiturn: 16 bit (65536 rev)

20 Multiturn: 20 bit (1048576 rev)

PP Programmable, Default 12 bit (4096 rev)

4 Resolution

12 12 bit (4096 Steps / 0.088°)

13 13 bit (8192 Steps / 0.044°)

16 16 bit (65536 Steps / 0.005°)

PP Programmable, Default 13 bit (8192 Steps / 0.044°)

5 Draw Wire

Please See Technical Drawings on Page 81

6 Protection Class

A IP54

0 IP64/IP65

7 Connection Type

CAW Cable: Axial 1 m

2AW Cable: Axial 2 m

5AW Cable: Axial 5 m

AAW Cable: Axial 10 m

CRW Cable: Radial 1 m

2RW Cable: Radial 2 m

5RW Cable: Radial 5 m

ARW Cable: Radial 10 m

PAQ Connector: Axial M12, 8 pin

PAL Connector: Axial M23, 12 pin

PAP Connector: Axial M23, 16 pin

PRQ Connector: Radial M12, 8 pin

PRL Connector: Radial M23, 12 pin

PRP Connector: Radial M23, 16 pin

LINARIX LINEAR SENSORS

Product Selection Guide – Bus-Interface Linear Sensors

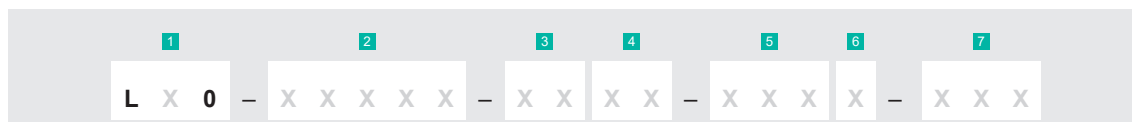

1 Accuracy (Technology)

- U** ≤ 0.09° (Magnetic)
- D** ≤ 0.022° (Optical)

6 Protection Class

- A** IP54
- 0** IP64/IP65

2 Communication Interface

- DPC1B** Profibus (Optical, Magnetic)
- CA01B** CANopen (Magnetic)
- CAA1B** CANopen (Optical)
- CTx1B** CANopen+Incr. RS422 (TTL)
- CHx1B** CANopen+Incr. Push-Pull (HTL)
- CL00B** CANopen Lift (Magnetic)
- C900B** SAE J1939
- D2B1B** DeviceNet (Optical)
- IBA1B** Interbus (Optical)

7 Connection Type

- CAW** Cable: Axial 1 m
- 2AW** Cable: Axial 2 m
- 5AW** Cable: Axial 5 m
- AAW** Cable: Axial 10 m
- CRW** Cable: Radial 1 m
- 2RW** Cable: Radial 2 m
- 5RW** Cable: Radial 5 m
- ARW** Cable: Radial 10 m
- PAM** Connector: Axial M12, 5 pin (CANopen, CANopen Lift)
- PAV** Connector: Axial M12, 5 pin, Status LED (CANopen, CANopen Lift)
- PAM** Connector: Axial 3 x M13 (Profibus)
- PRM** Connector: Radial M12, 5 pin
- PAQ** Connector: Axial M12, 8 pin (CAN+Incr.)
- PRV** Connector: Radial M12, 5 pin, Status LED (CANopen, CANopen Lift)
- PRQ** Connector: Radial M12, 8 pin (CAN+Incr.)
- PRI** Connector: Radial 2 x M23, 9 pin (Interbus)
- H3P** Connection Cap: 3 Cable Glands
- H1B** Connection Cap: 1 x M12 Connector
- H2B** Connection Cap: 2 x M12 Connectors
- H72** Connection Cap: 3 x M12 Connectors
- H1C** Connection Cap: 1 x M23 Connector (DeviceNet)
- H2M** Connection Cap: 2 x M20 Cable Glands
- HCC** Without Connection Cap

3 Revolution

- 00** Singleturn
- 12** Multiturn: 12 bit (4096 rev)
- 13** Multiturn: 13 bit (8192 rev)
- 14** Multiturn: 14 bit (16384 rev)
- 15** Multiturn: 15 bit (32768 rev)

4 Resolution

- 12** 12 bit (4096 Steps / 0.088°)
- 13** 13 bit (8192 Steps / 0.044°)
- 16** 16 bit (65536 Steps / 0.005°)

5 Draw Wire

Please See Technical Drawings on Page 81



> Rugged Connectors and Cables

- Reliable Electrical Connections
- M12 & M23 Data, Bus and Signal Connectors
- Straight and Angled Versions
- Variety of Cable Material and Lengths
- Shielded for Protection Against Noise and Interference

> Learn More



LINARIX LINEAR SENSORS

Product Selection Guide – Ethernet Linear Sensors

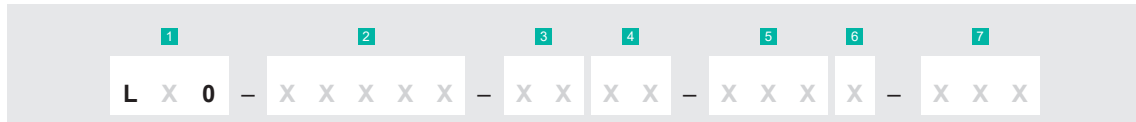

1 Accuracy (Technology)

U ≤ 0.09° (Magnetic)

D ≤ 0.022° (Optical)

4 Resolution

13 13 bit (8192 Steps / 0.044°)

16 16 bit (65536 Steps / 0.005°)

2 Communication Interface

EIB1B Profinet

EEA1B EtherNet/IP

E2A2B Powerlink

EC00B EtherCAT

EM00B Modbus/TCP + TCP/IP

5 Draw Wire

Please See Technical Drawings on Page 81

6 Protection Class

A IP54

0 IP64/IP65

3 Revolution

00 Singleturn

12 Multiturn: 12 bit (4096 rev)

14 Multiturn: 14 bit (16384 rev)

7 Connection Type

PRM Connector: Radial 2 x M12 (Modbus)

PRM Connector: Radial 3 x M12

PAM Connector: Axial 3 x M12

Sold & Serviced By:



Toll Free Phone (877) SERV098

www.electromate.com

sales@electromate.com

LINARIX LINEAR SENSORS

Technical Drawings

	Type Key	Encoder Connection Orientation	Max. Measurement Length m [in]	Enclosure Draw Wire
	1N0 1N3 1N6 1N9	0 3 6 9	1.25 [49] 1.25 [49] 1.25 [49] 1.25 [49]	Plastic Plastic Plastic Plastic
	2M0 2M3 2M6 2M9	0 3 6 9	2.10 [83] 2.10 [83] 2.10 [83] 2.10 [83]	Plastic Plastic Plastic Plastic
	7W0 7W3 7W6 7W9	0 3 6 9	7.50 [295] 7.50 [295] 7.50 [295] 7.50 [295]	Plastic Plastic Plastic Plastic

LINARIX LINEAR SENSORS

Technical Drawings

	Type Key	Encoder Connection Orientation	Max. Measurement Length m [in]	Enclosure Draw Wire
	<p>2P0</p> <p>2P2</p> <p>2P4</p> <p>2P6</p> <p>2P8</p> <p>2PA</p>	<p>0</p> <p>2</p> <p>4</p> <p>6</p> <p>8</p> <p>A</p>	<p>1.74 [69]</p> <p>1.74 [69]</p> <p>1.74 [69]</p> <p>1.74 [69]</p> <p>1.74 [69]</p> <p>1.74 [69]</p>	<p>Machined Metal</p> <p>Machined Metal</p> <p>Machined Metal</p> <p>Machined Metal</p> <p>Machined Metal</p> <p>Machined Metal</p>
	<p>2C0</p> <p>2C3</p> <p>2C6</p> <p>2C9</p>	<p>0</p> <p>3</p> <p>6</p> <p>9</p>	<p>2.00 [79]</p> <p>2.00 [79]</p> <p>2.00 [79]</p> <p>2.00 [79]</p>	<p>Machined Metal</p> <p>Machined Metal</p> <p>Machined Metal</p> <p>Machined Metal</p>
	<p>3D0</p> <p>3D3</p> <p>3D6</p> <p>3D9</p>	<p>0</p> <p>3</p> <p>6</p> <p>9</p>	<p>3.00 [118]</p> <p>3.00 [118]</p> <p>3.00 [118]</p> <p>3.00 [118]</p>	<p>Machined Metal</p> <p>Machined Metal</p> <p>Machined Metal</p> <p>Machined Metal</p>

LINARIX LINEAR SENSORS

Technical Drawings

		Type Key	Encoder Connection Orientation	Max. Measurement Length m [in]	Enclosure Draw Wire
<p>Front view dimensions: [3.346] 85, [1.634] 41.50, [4.921] 125</p> <p>Side view dimensions: [3.378] 85.80, [2.520] 64, [0.583] 14.80, [0.394] 10, [1.433] 36.40</p>	6E0	0	6.00 [236]	Machined Metal	
	6E3	3	6.00 [236]	Machined Metal	
	6E6	6	6.00 [236]	Machined Metal	
	6E9	9	6.00 [236]	Machined Metal	
<p>Front view dimensions: [3.78] 96, [2.06] 52, [3.78] 96</p> <p>Side view dimensions: [3.22] 81.70, [2.73] 69.30, [0.58] 14.80, [0.39] 10, [1.65] 42</p>	3F0	0	3.00 [118]	Extruded Metal	
	3F3	3	3.00 [118]	Extruded Metal	
	3F6	6	3.00 [118]	Extruded Metal	
	3F9	9	3.00 [118]	Extruded Metal	
<p>Front view dimensions: [4.53] 115, [2.73] 69.30</p> <p>Side view dimensions: [4.08] 103.7, [2.73] 69.30, [0.58] 14.80, [0.39] 10, [1.65] 42</p>	5G0	0	5.00 [197]	Extruded Metal	
	5G3	3	5.00 [197]	Extruded Metal	
	5G6	6	5.00 [197]	Extruded Metal	
	5G9	9	5.00 [197]	Extruded Metal	

LINARIX LINEAR SENSORS

Technical Drawings

	Type Key	Encoder Connection Orientation	Max. Measurement Length m [in]	Enclosure Draw Wire
	AH0 AH3 AH6 AH9	0 3 6 9	10.00 [394] 10.00 [394] 10.00 [394] 10.00 [394]	Extruded Metal Extruded Metal Extruded Metal Extruded Metal
	FR0 FR3 FR6 FR9	0 3 6 9	15.00 [591] 15.00 [591] 15.00 [591] 15.00 [591]	Extruded Metal Extruded Metal Extruded Metal Extruded Metal

TILTIX INCLINOMETER



Precise Tilt Measurement

TILTIX INCLINOMETERS

Industrial Inclinerometers



Static Inclinometer

POSITAL's inclinometers are equipped with dynamic MEMS (micro-electro-mechanical system) accelerometers that are used to measure inclination (tilt) by measuring gravitational force.

A 'micro mass' **A** is suspended in a flexible support structure **B**. Any movement will induce a displacement of the mass, resulting in a change of capacitance between the mass and the supporting structure. Changes of inclination are calculated from the changes in measured capacitance.

This proven method reaches accuracies of up to 0.1° over the measurement range of up to 360° . However, the measurement can be disturbed by external accelerations making the inclinometer capable of operating only in static applications.

Dynamic Inclinometer

POSITAL's acceleration compensated inclinometer use MEMS gyroscopes in addition to MEMS accelerometers. In contrast to accelerometers, gyroscopes are used to measure rotation rate. An algorithm combines signals of both sensors to identify external accelerations and ignore them. This feature dramatically reduces the influence of external accelerations, shocks and vibrations on the output signal.

The compensation of external acceleration forces is very critical for mobile machines and other applications that are constantly in dynamic movement.

POSITAL's dynamic inclinometer are featured with 3D sensors resulting in improved measurement range of the complete space (x-axis $\pm 180^\circ$ and y-axis $\pm 90^\circ$).

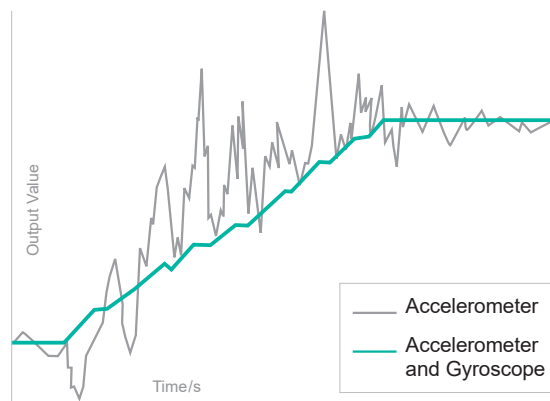
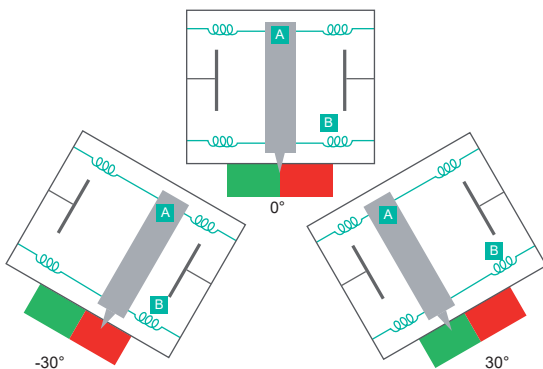

TILTIX INCLINOMETERS

Explosion Proof Certified Inclinerometers



Rugged and Reliable Certified Inclinometer

POSITAL has extended its TILTIX family of inclinometers (tilt sensors) to include explosion-proof models designed to operate safely in environments that contain potentially dangerous levels of explosive dust or gases. These devices have been certified in compliance with IECEx and ATEX directives and are suitable for use in mines, oil and gas facilities, agricultural applications, chemical plants, woodworking factories and milling operations.

Like other TILTIX inclinometers, the new models are available in single (0-360°) or dual-axis ($\pm 80^\circ$) versions and feature resolution as high as 0.01° and 0.1° accuracy. Available communications interfaces include DeviceNet, CANopen, Modbus RTU, SSI and analog output. Analog models can be programmed so that a predetermined range of mechanical motion is set span the full electrical output range. Rugged aluminum and 316 stainless steel housings are offered, with other materials available by special order.

Certified to the Following Atex Ratings

> Group I (Mining)

Ex I M2 Ex e mb I Mb

> Group II (Above Ground Operations)

EX II 2G Ex e mb IIc TX Gb (explosive gases)

EX II 2D Ex tb IIIB T80°C Db (flammable dust)





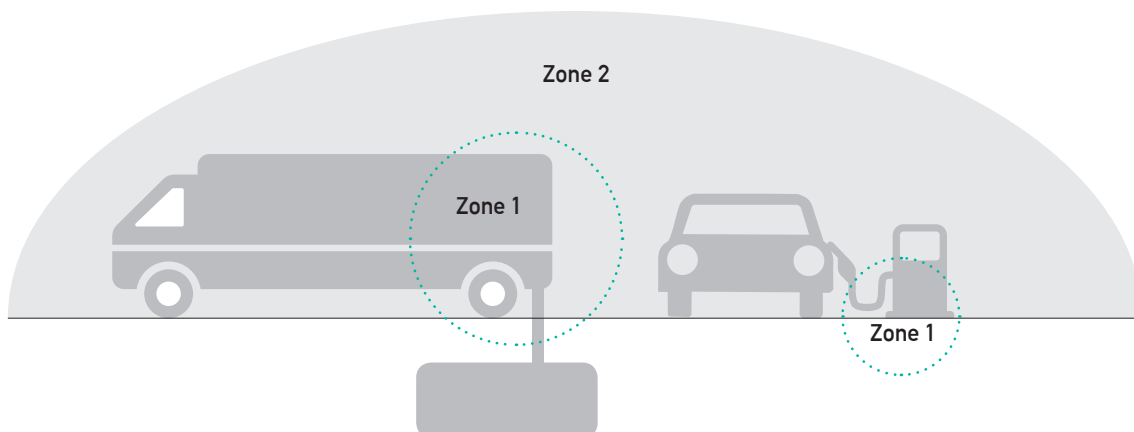

Advantages

- > ATEX and IECEx Certified
- > Zone 1/21 Mining or Oil and Gas
- > High Vibration and Shock Resistance
- > $\pm 80^\circ$ (Dual Axis) or 360° (Single Axis)
- > CANopen, DeviceNet, Analog, SSI, SAE J1939 and ModbusRTU
- > Rugged Aluminum and 316 Stainless Steel Housings
- > Usage in Gas (2G) and Dust (2D) Hazardous Locations
- > Accuracy 0.1° and resolution 0.044°



TILTIX INCLINOMETERS

Product Overview – Analog InclInometers

CE		Max. Protection Class	Communication Interface	1 Axis 0 to 360°	2 Axis ±80°	Resolution	Accuracy	Die Cast Aluminum Fibre-Reinforced	Supply Voltage in V	Cable	Connector	Terminal Block
	> Programmable	IP69K	4 – 20 mA	■	■	0.01°	0.1°	■	10-30	■	■	
	> Analog Current + RS232	IP68	0 – 20 mA									
	> Rugged Housing											
	> Programmable	IP69K	0.5 – 4.5 V	■	■	0.01°	0.1°	■	10-30	■	■	
	> Analog Voltage + RS232	IP68	0 – 5 V									
	> Rugged Housing		0 – 10 V									
	> Programmable	IP67	4 – 20 mA	■	■	0.01°	0.1°	■	10-30	■	■	
	> Analog Current + RS232		0 – 20 mA									
	> Compact Design											
	> Programmable	IP67	0.5 – 4.5 V	■	■	0.01°	0.1°	■	10-30	■	■	
	> Analog Voltage + RS232		0 – 5 V									
	> Compact Design		0 – 10 V									
	> Analog Current	IP67	4 – 20 mA	■	■	0.01°	0.5°	■	10-30	■	■	
	> Compact Design		0 – 20 mA									
	> Cost Effective Design											
	> Analog Voltage	IP67	0.5 – 4.5 V	■	■	0.01°	0.5°	■	10-30	■	■	
	> Compact Design		0 – 5 V									
	> Cost Effective Design		0 – 10 V									
	> ATEX Certified	IP67	Voltage	■	■	0.01°	0.1°	■	10-30	■	■	■
	> Rugged Housing		Current									
	> Compact Design		RS232									

> Related Industries



> Find What You Need

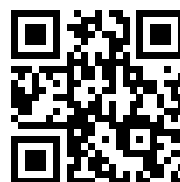

Configure Your POSITAL Encoder Online

**PRODUCT
FINDER**

TILTIX INCLINOMETERS

Product Selection Guide – Analog InclInometers

	1	2		3		4		5		6	7		8
A	X	X	-	X X X	-	X	-	X X X X	-	X	X X	-	X X

1 Technology

C MEMS, Accuracy 0.1°

D MEMS, Accuracy 0.5°

2 Certificate

S CE

M ATEX Zone 1 & 21 (Mining)

E ATEX Zone 1 & 21 (Oil+Gas)

3 Measurement Range

010 ±10°

020 ±20°

040 ±40°

060 ±60°

080 ±80°

090 90°

120 120°

180 180°

270 270°

360 360°

4 Number of Axis

1 Single Axis

2 Dual Axis

5 Communication Interface

SV00 Voltage 0.5 to 4.5 V + RS232

SV10 Voltage 0 to 5 V + RS232

SV20 Voltage 0 to 10 V + RS232

SV40 Voltage 0.5 to 9.5 V + RS232

SC00 Current 4 to 20 mA + RS232

AV00 Voltage 0.5 to 4.5 V

AV10 Voltage 0 to 5 V

AV20 Voltage 0 to 10 V

AV40 Voltage 0.5 to 9.5 V

AC00 Current 4 to 20 mA

6 Mounting

H Horizontal (Dual Axis)

V Vertical (Single Axis)

7 Housing Material

E2 Fibre-Reinforced Plastic

K2 Aluminum

8 Connection Type

CW Cable: 1m

2W Cable: 2 m

5W Cable: 5 m

AW Cable: 10 m

PM Connector: M12



> Versatile Digital Displays







- On-site Position or Speed Measurement
- Connect to Encoders, InclInometers or Linear Sensors
- Analog, SSI or Incremental Input
- Digital or Analog Output
- Easy Integration to More Complex Control Systems

> Learn More



TILTIX INCLINOMETERS

Product Overview – Digital Inclinerometers

CE		Max. Protection Class	Communication Interface	1 Axis 0 to 360°	2 Axis ±80°	Resolution	Accuracy	Die Cast Aluminum	Fibre-Reinforced	Supply Voltage in V	Cable	Connector	Terminal Block
	> Dynamic Applications	IP69K	CANopen	■	■	0.01°	0.3°	■		10-30	■	■	
	> Fieldbus Interface	IP68	SAE J1939										
	> Rugged Housing												
	> Static Applications	IP69K	CANopen	■	■	0.01°	0.1°	■		10-30	■	■	
	> Fieldbus Interface	IP68	DeviceNet										
	> Rugged Housing		SAE J1939										
	> Static Applications	IP67	CANopen	■	■	0.01°	0.1°		■	10-30	■	■	
	> Fieldbus Interface		DeviceNet										
	> Compact Design		ModbusRTU										
	> Static Applications	IP69K	CANopen	■	■	0.01°	0.1°		■	10-30	■	■	
	> Fieldbus Interface	IP68	DeviceNet										
	> Compact Design		ModbusRTU										
	> Static Applications	IP69K	SSI	■		0.04°	0.1°	■		5-30	■	■	
	> Serial Interface	IP68	RS232										
	> Rugged Housing												
	> Static Applications	IP67	SSI	■		0.04°	0.1°		■	5-30	■	■	
	> Serial Interface		RS232										
	> Compact Design												
	> ATEX Certified	IP67	CANopen	■	■	0.04°	0.1°		■	10-30	■	■	
	> All Available Interfaces		SAE J1939										
	> Rugged Housing		RS232										

> Related Industries



> Find What You Need

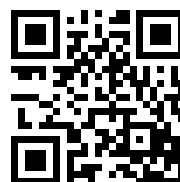

Configure Your POSITAL Encoder Online

**PRODUCT
FINDER**

TILTIX INCLINOMETERS

Product Selection Guide – Digital Inclinometers

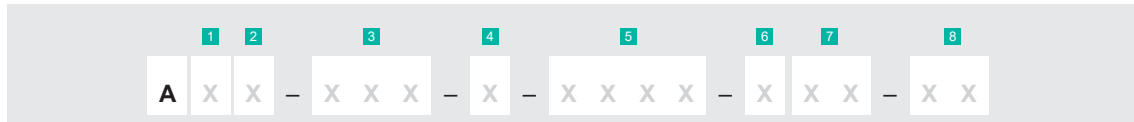

1 Technology

- C** Accuracy Static 0.1°
- K** Accuracy Static 0.3°, Dynamic 0.5°

2 Certificate

- S** CE
- M** ATEX Zone 1 & 21 (Mining)
- E** ATEX Zone 1 & 21 (Oil+Gas)

3 Measurement Range

- 080** ±80°
- 090** ±90°
- 360** 360°

4 Number of Axis

- 1** Single Axis
- 2** Dual Axis

5 Communication Interface

- SV00** RS232 (ACS)
- S101** SSI Binary (ACS)
- S301** SSI Gray (ACS)
- CA01** CANopen (ACS, AKS)
- C901** J1939 (ACS, AKS)
- M100** Modbus RTU (ACS)
- D101** DeviceNet (ACS)

6 Mounting

- H** Horizontal (Dual Axis)
- V** Vertical (Single Axis)

7 Housing Material

- E2** Fibre-Reinforced Plastic
- K2** Aluminum
- W2** Stainless Steel (ATEX)

8 Connection Type

- CW** Cable: 1m
- 2W** Cable: 2 m
- 5W** Cable: 5 m
- AW** Cable: 10 m
- PM** Connector: M12
- PL** Connector: 2 x M12 Male with Status LED
- PN** Connector: 1 x M12 Male & 1 x M12 Female



> Rugged Connectors and Cables

- Reliable Electrical Connections
- M12 & M23 Data, Bus and Signal Connectors
- Straight and Angled Versions
- Variety of Cable Material and Lengths
- Shielded for Protection Against Noise and Interference

> Learn More



TILTIX INCLINOMETERS

Technical Drawings

	7 8 Type Key	Housing Material	Connection Type	Protection Class
<p>Technical drawing of the K2-PM inclinometer. Dimensions (mm [inch]):</p> <ul style="list-style-type: none"> Side view: 10.50 [0.41] (length), 27 [1.06] (diameter) Top view: 59 [2.32] (width), 107 [4.21] (length) Mounting holes: 4x \varnothing 6.40 [0.25] Internal dimensions: 44 [1.73], 22 [0.87], 68 [2.68], 83 [3.27] 	K2-PM	Al	M12 Connector	IP68/IP69K
<p>Technical drawing of the K2-PN inclinometer. Dimensions (mm [inch]):</p> <ul style="list-style-type: none"> Side view: 10.50 [0.41] (length), 27 [1.06] (diameter) Top view: 59 [2.32] (width), 118.15 [4.65] (length) Mounting holes: 4x \varnothing 6.40 [0.25] Internal dimensions: 44 [1.73], 22 [0.87], 68 [2.68], 83 [3.27] 	K2-PN	Al	Male M12 & Female M12 Connector	IP68/IP69K

All dimension in mm [inch]; Al: Aluminum; 303: Stainless Steel V2A (1.4305, 303); 316 L: Stainless Steel V4A (1.4404, 316 L)

TILTIX INCLINOMETERS

Technical Drawings

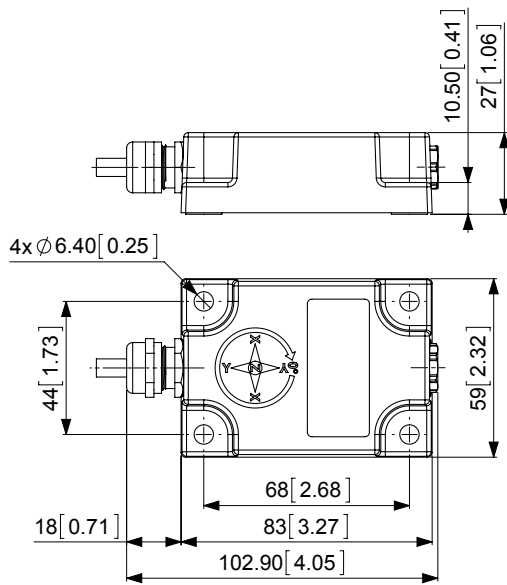

7 8 Type Key	Housing Material	Connection Type	Protection Class
K2-CW	Al	1 m Cable	IP68/IP69K
K2-2W	Al	2 m Cable	IP68/IP69K
K2-5W	Al	5 m Cable	IP68/IP69K
K2-AW	Al	10 m Cable	IP68/IP69K

All dimension in mm [inch]; Al: Aluminum; 303: Stainless Steel V2A (1.4305, 303); 316 L: Stainless Steel V4A (1.4404, 316 L)

Sold & Serviced By:



Toll Free Phone (877) SERV098

www.electromate.com

sales@electromate.com

TILTIX INCLINOMETERS

Technical Drawings

	7 8 Type Key	Housing Material	Connection Type	Protection Class
	E2-PM	Plastic	M12 Connector	IP67
	E2-CW E2-2W E2-5W E2-AW	Plastic	1 m Cable 2 m Cable 5 m Cable 10 m Cable	IP67 IP67 IP67 IP67

All dimension in mm [inch]; Al: Aluminum; 303: Stainless Steel V2A (1.4305, 303); 316 L: Stainless Steel V4A (1.4404, 316 L)

TILTIX INCLINOMETERS

Technical Drawings

	7 8 Type Key	Housing Material	Connection Type	Protection Class
	<p>K2-CW W2-CW</p>	<p>Al 316 L</p>	<p>Cable Gland Cable Gland</p>	<p>IP67 IP67</p>

All dimension in mm [inch]; Al: Aluminum; 303: Stainless Steel V2A (1.4305, 303); 316 L: Stainless Steel V4A (1.4404, 316 L)

TILTIX INCLINOMETERS

Inclinometers with Dynamic Load Compensation



Innovative Algorithm for Innovative Results

POSITAL has introduced new versions of its TILTIX inclinometers that can provide reliable tilt measurement for moving equipment. These new devices use a combination of electro-mechanical accelerometers and gyroscopes to provide accurate measurements, even if the instruments are subject to strong accelerations.

Specifications

- Resolution 0.01°
- Accuracy 0.3°
- Accuracy of 0.5° during Dynamic Movements
- Internal Cycle Time 5 ms
- Measurement Range $\pm 180^\circ$
- 2 Axes or 1 Axis Measurement
- Horizontal or Vertical Mounting



➤ Inclinometers with

Dynamic Load Compensation

- Compensation of External Accelerations
- Clean Measurement During Dynamic Movements
- Well Protected up to IP69K
- Compact and Robust Die-cast Housing with Integrated T-Coupler

➤ [Learn More](#)



ACCESSORIES



Wide Selection of Accessories

Sold & Serviced By:





Toll Free Phone (877) SERV098

www.electromate.com

sales@electromate.com

ACCESSORIES

Configuration Tools

		Compatibility	Features
	<ul style="list-style-type: none"> > UBIFAST Configuration Tool > Web Browser Based Simple Programming Tool 	IXARC Programmable Encoders	Programmable: <ul style="list-style-type: none"> ▪ Output Driver ▪ Resolution ▪ Revolution ▪ Data Code ▪ Counting Direction
			<ul style="list-style-type: none"> > SSI to USB Conversion Tool > Simple GUI to View SSI Functionality







- > **UBIFAST Configuration Tool**
- Compact Housing with WLAN to Create Hotspot
- Connects to Smart Phone/ Tablets/ Notebooks
- Web Browser Based Simple Programming
- Configuration Data Sent Back to POSITAL via E-mail
- Parameters to Program: PPR, Resolution, Number of Turns, Direction

> [Learn More](#)



ACCESSORIES

Display and Counters

	Compatibility	Features
 <p>> Di-Mod Counter</p>	Incremental	<ul style="list-style-type: none"> ▪ Incremental Input ▪ 2 Programmable Relay Outputs
 <p>> AP20 Counter</p>	Incremental	<ul style="list-style-type: none"> ▪ Incremental Input ▪ Programmable Digital and Analog Outputs
 <p>> AP21 Display</p>	SSI	<ul style="list-style-type: none"> ▪ Absolute SSI Input ▪ Programmable Digital and Analog Outputs
 <p>> AP 22 Display</p>	Analog	<ul style="list-style-type: none"> ▪ Analog Current and Voltage Input ▪ Programmable Digital Outputs



> Versatile Digital Displays





- On-site Position or Speed Measurement
- Connect to Encoders, Inclometers or Linear Sensors
- Analog, SSI or Incremental Input
- Digital or Analog Output
- Easy Integration to more Complex Control Systems

> Learn More



ACCESSORIES

Measuring Wheels

		Measurement Length in mm [in]	Compatibility	Suitable for Surfaces
	> Measuring Wheels with Knurled Alu Surface	200 500	Encoders with 10 mm Shaft	<ul style="list-style-type: none"> ▪ Cardboard ▪ Wood ▪ Textiles ▪ Rubber ▪ Soft Plastic
	> Measuring Wheels with Smooth PUR Surface	200 500	Encoders with 10 mm Shaft	<ul style="list-style-type: none"> ▪ Cardboard ▪ Wood & Textiles ▪ Greased Metals ▪ Steel Profiles ▪ Painted Surfaces ▪ Plastic & Paper ▪ Wire & Leather
	> Measuring Wheels with Studded PUR Surface	200 500	Encoders with 10 mm Shaft	<ul style="list-style-type: none"> ▪ Cardboard ▪ Wood ▪ Plastics ▪ Paper ▪ Wire ▪ Coarse Textiles & Carpet
	> Measuring Wheels with Corrugated PUR Surface	200 500	Encoders with 10 mm Shaft	<ul style="list-style-type: none"> ▪ Cardboard ▪ Wood ▪ Plastics ▪ Paper ▪ Ungreased Metal ▪ Flooring & Glass



Recommended to use with Mounting
Bracket Spring Loaded for Clamping Flanges
(Page 103)



> Turn a Rotary Encoder into Linear Position Sensor





- Ideal for Cut-to-Length and Continuous Measurements
- Options Available for Both Smooth and Textured Surfaces
- Incremental, Ethernet, Fieldbus or SSI Output Available
- Combine with a UBIFAST Incremental Encoder for Easy Customization in the Field

> [Learn More](#)



ACCESSORIES

Connectors and Cables

		Length in m	Numbers & Pins Connector Coding	Cable Material	Connector Material	Protection Class	Compatible with Connection Type*
	> Connector		4 pin A, 4 pin D		Metal	IP67	IXARC: PRM, PAM, PRQ, PAQ TILTIX: PM
	> M12		5 pin A, 5 pin B				
	> Male and Female		8 pin A				
	> Connector		9		Metal	IP67	IXARC: PRL, PAL, PRP, PAP, PRI
	> M23		12				
	> Female		16				
	> Connector		26		Metal	IP67	IXARC: PAT, PRT
	> M27						
	> Female						
	> Cable	2	4 pin A, 4 pin D	PUR	PBT	IP69K	IXARC: PRM, PAM, PRQ, PAQ TILTIX: PM
	> M12 Connector	5	5 pin A, 5 pin B	PVC	Metal		
	> Open Ends, RJ45	10	8 pin A				
	> Cable	2	9	PUR	Metal	IP67	IXARC: PRL, PAL, PRP, PAP, PAT, PRT, PRI
	> M23, M27 Connector	5	12	PVC			
	> Open Ends	10	16, 26				

Please check our website for the complete listing. All compatible accessories are linked to the product variety!



> **Rugged Connectors and Cables**





- Reliable Electrical Connections
- M12 & M23 Data, Bus and Signal Connectors
- Straight and Angled Versions
- Variety of Cable Material and Lengths
- Shielded for Protection Against Noise and Interference

> **Learn More**



ACCESSORIES

Mounting Fixtures

		Flange / Shaft Ø Dimensions in mm	Material	Compatible with Mechanical Design
	> Coupling	6 to 6, 6 to 8	Hub: Aluminum	All IXARC
	> Jaw Type	6 to 10, 8 to 10	Spider: PUR	Solid Shafts
	> 3 Part Coupling	10 to 10, 10 to 12		
	> Coupling	6 to 6, 6 to 8	Flange: Aluminum	All IXARC
	> Bellow Type	6 to 10, 8 to 10,	Membrane: Polyamide	Solid Shafts
	> Flexible Design	10 to 10		
	> Coupling	6 to 6, 6 to 10	Flange: Aluminum	All IXARC
	> Disc Type	10 to 10, 10 to 12	Membrane: Polyamide	Solid Shafts
	> High Speed Application			
	> Torque Support	36	Aluminum	All IXARC
	> Includes Tethers	58	Stainless Steel	Hub and Through
	> Includes Clamping Ring			Hollow Flanges
	> Reducing Adapter	15 to (6-14)	Stainless Steel	All IXARC
	> Used in Hub Shaft	12 to (8-11)	Brass	Hub & Through
	> Used in Through Hollow Shaft			Hollow Flanges



> **Easy Mounting for Various Shaft Types**







- Posital Accessories Minimize Wear and Tear on Encoders
- Couplings Are Used to Attach the Encoder Shaft to the Machine's Moving Shaft
- Torque Support Is Used to Anchor the Hollow Shaft Encoder

> **Learn More**



ACCESSORIES

Clamping Rings & Adapter Flanges

		Flange / Shaft Ø Dimensions in mm	Material	Compatible with Mechanical Design
	<ul style="list-style-type: none"> > Mounting Bracket > Adapt to Synchro and Clamp Flanges, Used in Solid Shaft 	58	Reinforced Fiberglass	All IXARC Clamp & Synchro Flanges 58 mm
	<ul style="list-style-type: none"> > Clamp Discs > Mount Encoder onto Surface > Clamp Flange 	36 58	Aluminum	All IXARC Clamp & Synchro Flanges
	<ul style="list-style-type: none"> > Flange Adapter > Used in Clamp Flange > Used in Synchro Flange 	58 to (63.5, 78, 80, 90, 100)	Aluminum	Selected IXARC Clamp & Synchro Flanges
	<ul style="list-style-type: none"> > Mounting Bracket > Spring Loaded > Use with Measuring Wheels 	58 mm Clamp Flange 10 mm Shaft	Aluminum	Use with Measuring Wheels
	<ul style="list-style-type: none"> > Mounting Bracket > Simple and Low Cost > Angled Mounting Bracket 	58	Aluminium	Clamping - Solid Shaft
	<ul style="list-style-type: none"> > Mounting Bracket > Thermal & Electrical Insulation > Includes Fixtures 	58	Reinforced Fiberglass	Clamping - Solid Shaft

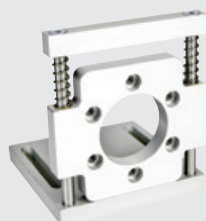







> Simplify Sensor Installation

- Clamping Rings Secure the Moving Shaft with the Encoder's Hollow Shaft
- Adapter Flanges Are Used with Posital Encoders to Exactly Fit into the Customer's Installation or Control Cabinet
- Clamp Discs Are Used to Secure the Clamp Flange of the Encoder to the Customers' Installation Cabinet

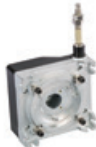

ACCESSORIES

Draw Wire Adapters

		Max. Measurement Length	Compatible Flange Size	Draw Wire Enclosure
	<ul style="list-style-type: none"> > WDS-1740 > Low Cost and Robust > Metal, Cylindrical Housing 	1.7 m	58 mm	<ul style="list-style-type: none"> ▪ Machined Metal ▪ Cylindrical Housing
	<ul style="list-style-type: none"> > SG21 > Compact Housing > Zinc Die-Cast, Rectangular Housing 	2 m	36 mm	<ul style="list-style-type: none"> ▪ Machined Metal ▪ Rectangular Housing
	<ul style="list-style-type: none"> > SG-31 > Robust and Versatile > Machined Metal, Rectangular Housing 	3 m	58 mm	<ul style="list-style-type: none"> ▪ Machined Metal ▪ Rectangular Housing
	<ul style="list-style-type: none"> > SG60 > Economical and Versatile > Plastic, Rectangular Housing 	3 to 6 m	58 mm	<ul style="list-style-type: none"> ▪ Machined Metal ▪ Rectangular Housing
	<ul style="list-style-type: none"> > WDS > Robust and versatile > Flexible Mounting Options 	2 m, 3 m, 5 m, 10 m, 15 m	58 mm	<ul style="list-style-type: none"> ▪ Extruded Metal
	<ul style="list-style-type: none"> > SL3002/GS80X1 > Robust and versatile > Aluminum, Rectangular Housing 	2 m, 3 m, 5 m, 10 m, 15 m	58 mm	<ul style="list-style-type: none"> ▪ Machined Metal ▪ Rectangular Housing

* ATEX versions available upon request



- > **Robust and Versatile Draw Wire Adapters**
 - Measurement Range from 1 to 30 m [3 to 98 ft]
 - Replacement to Linear Potentiometers
 - Stainless Steel Measuring Wire
 - Suitable for Heavy Duty or Industrial Environments
 - Easily Mounted Using 36mm & 58mm Synchro Flanges

> [Learn More](#)



ENCODERMATCH

Competitor Cross Reference Finder

ENCODERMATCH

▶ BY POSITAL

After many years of successfully replacing and re-fitting thousands encoders, POSITAL has created an easy-to-use cross reference finder. Encodermatch is based on a detailed database which provides information about the competitor product, the compatible POSITAL product and the degree of compatibility between the products. If products are not a 100% match, Encodermatch denotes which specific feature is responsible for the incompatibility.

Cross referencing a product in Encodermatch requires only a small amount of information from the user: The manufacture and the known product typekey. Encodermatch can replace more than 10 manufacturers and thousands of products.

Why POSITAL?

- Unique combination of high performance and rugged durability encoders
- Excellent dynamic response and compact size
- Powerful programming capabilities (PPR, resolution, number of turns, direction)
- Large variety of mechanical features and compatible accessories
- Fast delivery, standard products ship within 72h, expedited orders manufactured within 24h
- 36 month warranty period, counting from the date of shipping
- More than 50 years experience in rotary encoders

**WE'LL
MATCH
IT**

▶ Find a Replacement for your Encoder in 5 Easy Steps

- Choose the Name of the Manufacturer
- Type in the Encoder Name
- Click Search
- Fill in the Pulse Count
- Click on the Found Encoder to View the Detailed Data Sheet

▶ Learn More

