

Sold & Serviced By:



Toll Free Phone (877) SERV098

[www.electromate.com](http://www.electromate.com)

[sales@electromate.com](mailto:sales@electromate.com)



# TOPJOB® S Rail-Mount Terminal Block Systems

Edition 2020

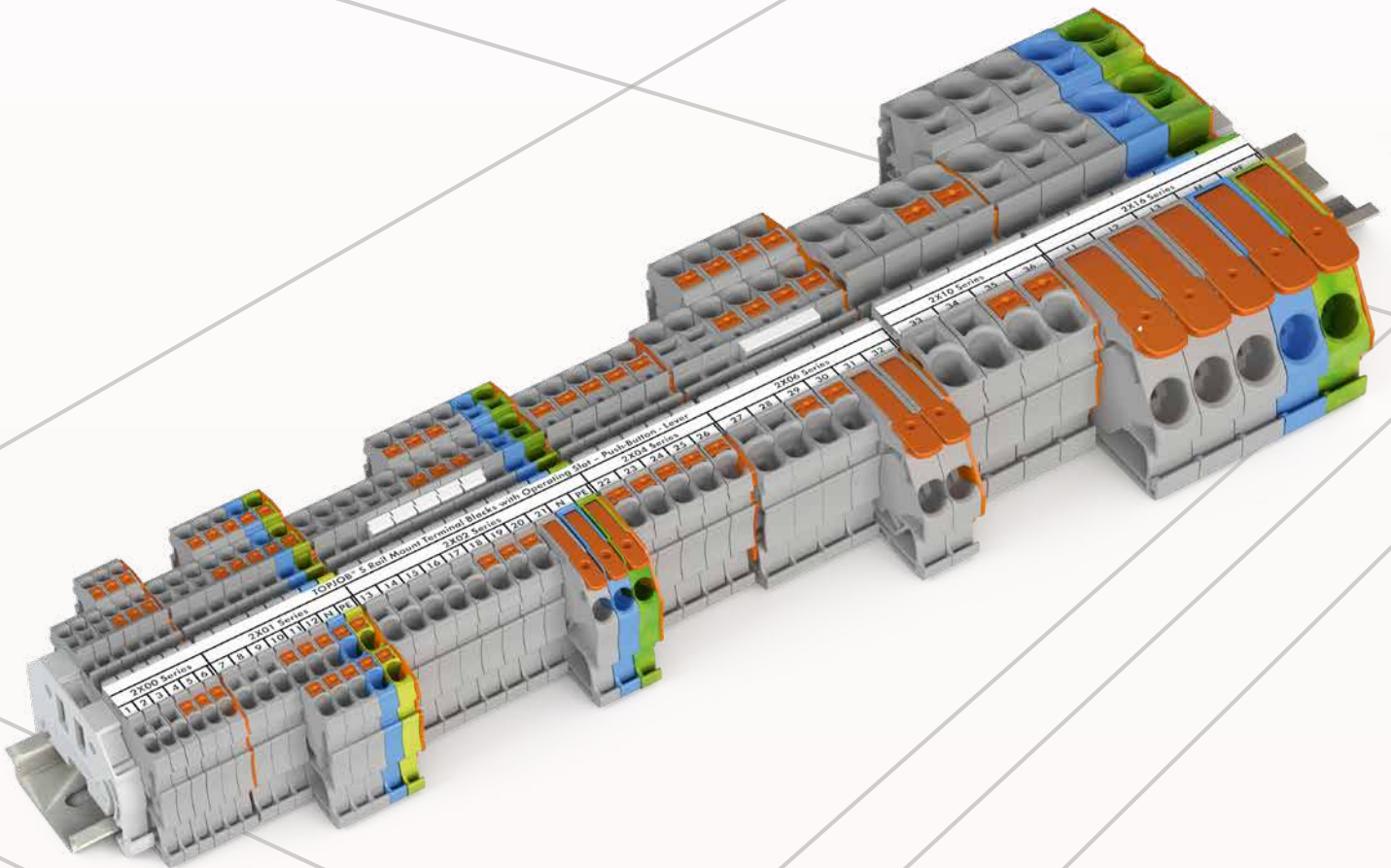





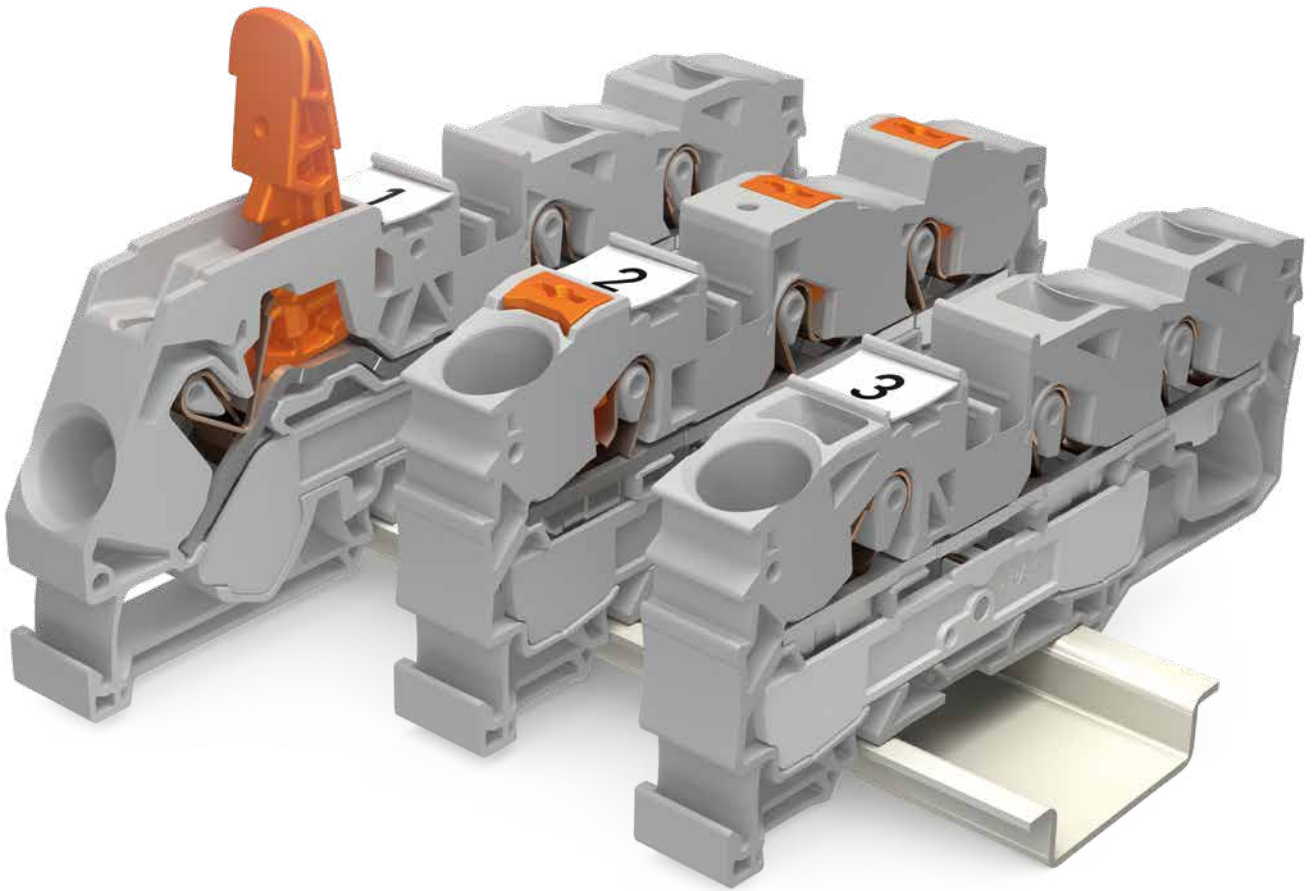













## WAGO Rail-Mount Terminal Blocks TOPJOB® S

			Page
	Through Terminal Blocks and Ground Conductor Terminal Blocks; with Levers and Push-in CAGE CLAMP®	2102/21062110//2116 Series	8
	Through Terminal Blocks and Ground Conductor Terminal Blocks; with Levers and Push-Buttons 0.25 ... 16 (25 "f-st") mm <sup>2</sup> (22 ... 4 AWG)	2102/2106/2110/2116 Series	12
	Through Terminal Blocks and Ground Conductor Terminal Blocks; with Push-Buttons 0.14 ... 16 (25 "f-st") mm <sup>2</sup> (24 ... 4 AWG)	2200 ... 2216 Series	16
	Through Terminal Blocks and Ground Conductor Terminal Blocks, Shield Conductor Terminal Blocks and Ex Terminal Blocks 0.14 ... 16 (25 "f-st") mm <sup>2</sup> (24 ... 4 AWG)	2000 ... 2016 Series	34
	Multilevel Rail-Mount Terminal Blocks; with and without Push-Buttons 1 (1.5) mm <sup>2</sup> (16 AWG) and 2.5 (4) mm <sup>2</sup> (12 AWG)	2202/2000/2002 Series	48
	Disconnect/Test Terminal Blocks, Fuse Terminal Blocks and Through Terminal Blocks; with Push-Buttons	2202 Series	76
	Disconnect/Test Terminal Blocks, Fuse Terminal Blocks and Through Terminal Blocks	2002/2006/2007 Series	88
	Double-Deck Disconnect/Test Terminal Blocks 0.25 ... 2.5 (4) mm <sup>2</sup> (22 ... 12 AWG)	2002 Series	144
	Fuse Plugs on Carrier Terminal Blocks	2004/2006 Series	116
	Sensor Terminal Blocks and Actuator Terminal Blocks 0.14 ... 1 (1.5) mm <sup>2</sup> (24 ... 16 AWG)	2000/2020 Series	122
	Diode Terminal Blocks and LED Terminal Blocks 0.25 ... 4 (6) mm <sup>2</sup> (22 ... 10 AWG)	2001/2002/2004 Series	130
	Multilevel Diode Terminal Blocks and LED Terminal Blocks 0.25 ... 2.5 (4) mm <sup>2</sup> (22 ... 12 AWG)	2002 Series	148
	Diode Modules, LED Modules and Empty Component Plugs Housing	2002 Series	136
	X-COM®S-SYSTEM-MINI Carrier Terminal Blocks	2020 Series	172
	Double-Deck Carrier Terminal Blocks 0.14 ... 1 (1.5) mm <sup>2</sup> (24 ... 16 AWG)		174
	1-Conductor Female Plugs and 2-Conductor Female Plugs	2020 Series	176
	1-Conductor Female Plugs and 2-Conductor Female Plugs for Self-Assembly		178
	1-Conductor Female Plugs and 2-Conductor Female Plugs with Lateral Locking Levers and Strain Relief Plates 0.14 ... 1 (1.5) mm <sup>2</sup> (24 ... 16 AWG)		184
	X-COM®S-SYSTEM Carrier Terminal Blocks	2022 Series	188
	Double-Deck Carrier Terminal Blocks 0.25 ... 2.5 (4) mm <sup>2</sup> (22 ... 12 AWG)		192
	1-Conductor Female Plugs	2022 Series	194
	1-Conductor Female Plugs for Self-Assembly		196
	1-Conductor Female Plugs with Lateral Locking Levers and Strain Relief Plates 0.25 ... 2.5 (4) mm <sup>2</sup> (22 ... 12 AWG)		200

			Page
	<b>X-COM®S-SYSTEM, for Ex ec Applications</b>	2022 Series	
	<b>Carrier Terminal Blocks</b>		202
	<b>Double-Deck Carrier Terminal Blocks</b>		204
	0.25 ... 2.5 (4) mm <sup>2</sup> (22 ... 12 AWG)		
	<b>1-Conductor Female Plugs</b>	2022 Series	206
	<b>Pre-Assembled 1-Conductor Female Plugs</b>		207
	0.25 ... 2.5 (4) mm <sup>2</sup> (22 ... 12 AWG)		
	<b>Multilevel Installation Terminal Blocks; with N-Disconnect Slide Links</b>	2003 Series	212
	<b>Multilevel Installation Terminal Blocks; with Internal N-Disconnection</b>		214
	<b>Double-Fuse Plugs on Carrier Terminal Blocks</b>		218
	0.25 ... 2.5 (4) mm <sup>2</sup> (22 ... 12 AWG)		
	<b>Multilevel Installation Terminal Blocks; with N-Disconnect Slide Links</b>	2005 Series	220
	0.5 ... 4 (6) mm <sup>2</sup> (20 ... 10 AWG)		
	<b>Supply Terminal Blocks for Distribution Boxes</b>	2016 Series	224
	0.5 ... 16 (25 "f-st") mm <sup>2</sup> (20 ... 4 AWG)		
	<b>Accessories for Rail-Mount Terminal Blocks TOPJOB® S</b>		154
	<b>Through Terminal Blocks and Ground Conductor Terminal Blocks</b>	285 Series	232
	6 ... 35 mm <sup>2</sup> (10 ... 2 AWG)		
	<b>Through Terminal Blocks and Ground Conductor Terminal Blocks</b>	285 Series	236
	<b>Through Terminal Blocks; with Mounting Flanges</b>		237
	10 ... 50 (70) mm <sup>2</sup> (8 ... 1/0 AWG)		
	<b>Through Terminal Blocks and Ground Conductor Terminal Blocks</b>	285 Series	238
	<b>Through Terminal Blocks; with Mounting Flanges</b>		239
	25 ... 95 mm <sup>2</sup> (4 ... 4/0 AWG)		
	<b>Through Terminal Blocks and Ground Conductor Terminal Blocks</b>	285 Series	240
	<b>Through Terminal Blocks; with Mounting Flanges</b>		241
	50 ... 185 mm <sup>2</sup> (1/0 AWG ... 350 kcmil)		
	<b>Marking Systems</b>		248
	<b>Carrier Rails, Collective Jumper Carriers and Rail-Mount Terminal Block Covers</b>		254
	<b>Tools</b>		260

# 3 WAYS TO WIRE = 1 FAMILY

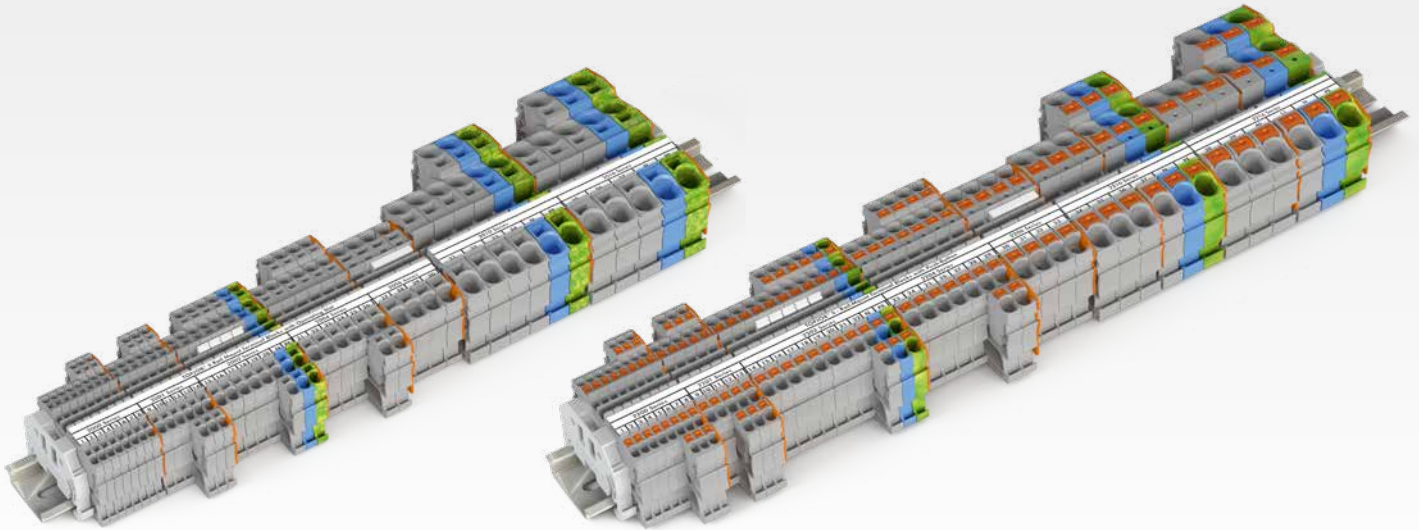

## Operating Slot

- The operating tool remains in the operating slot until termination is complete
- The clamping unit is marked by the inserted operating tool
- The conductor entry is held open for hands-free wiring

## Push-Button

- Use any common tool to open the clamping unit via the push-button
- Intuitive operation – orange color highlights the push-button

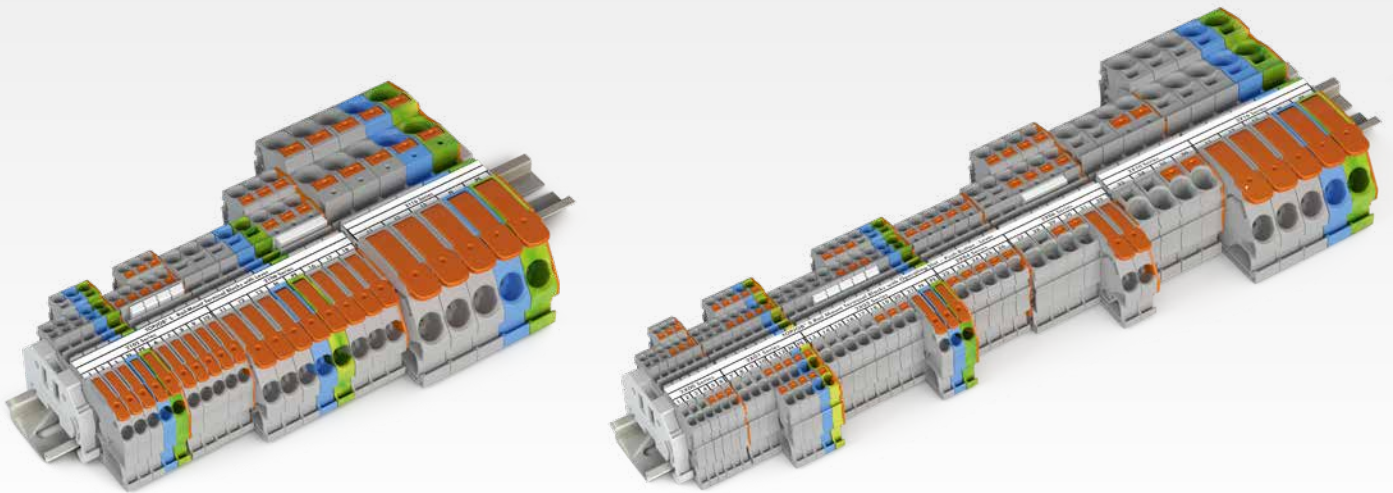

## Lever

- Simple and intuitive termination by hand
- Tool-free termination and removal of all conductor types
- The lever engages and keeps the clamping point open, freeing hands for wiring
- Lever position clearly indicates if the clamping point is open or closed
- Easy connection of difficult-to-bend conductors via side-entry conductor insertion

## One Range

- All three actuation variants can be combined with each other
- Push-in termination of solid, stranded and ferruled conductors for all variants
- Marking strips and WMB markers provide continuous marking possibilities
- One existing range of jumpers for all three variants
- Test options for all variants



# Rail-Mount Terminal Blocks TOPJOB® S; with Levers and Push-in CAGE CLAMP® 2102, 2106, 2110 and 2116 Series Description and Installation

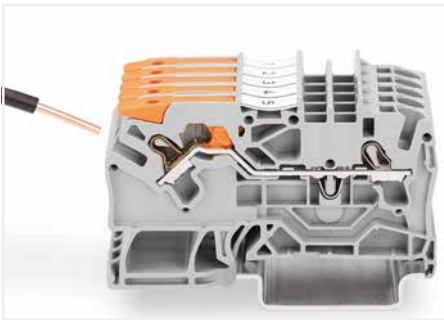

Push-in termination of solid conductors

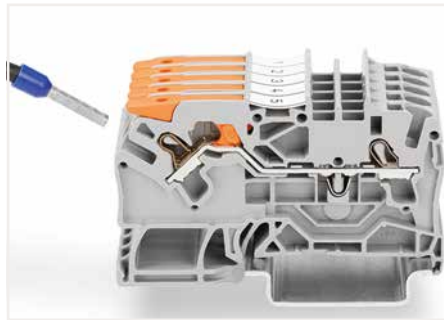

Push-in termination of fine-stranded conductors with ferrules

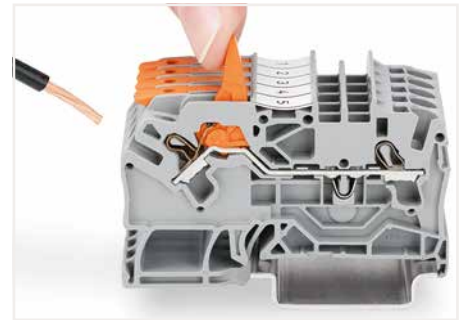

Pull the lever up until it stops, then connect the fine-stranded conductor.

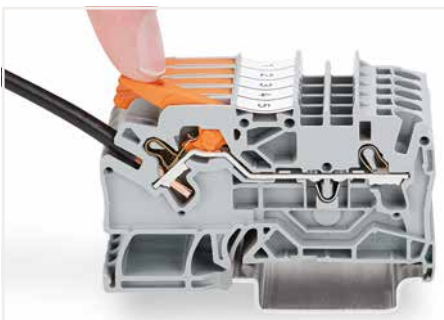

Push the lever back down – done!



Insert push-in type jumper bar and push down until it hits backstop.

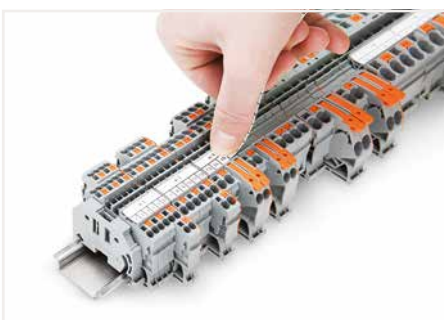
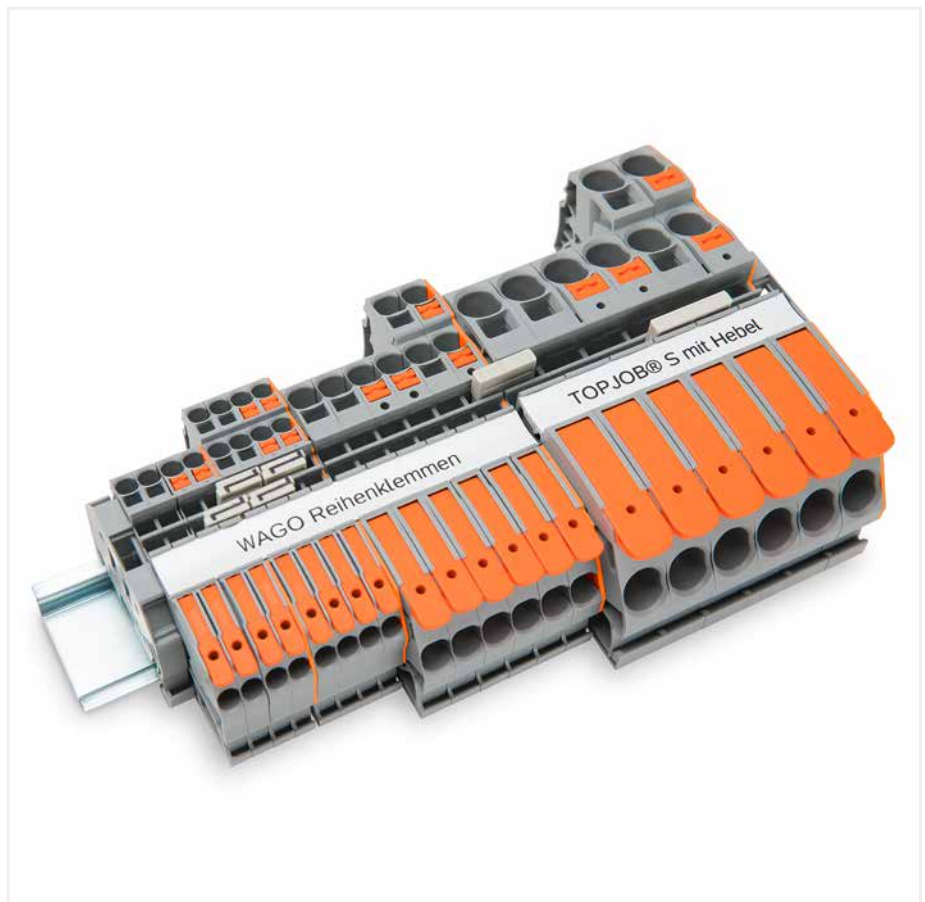

Snapping a marking strip into the marker slot.



Snapping a marking strip into the marker slot.

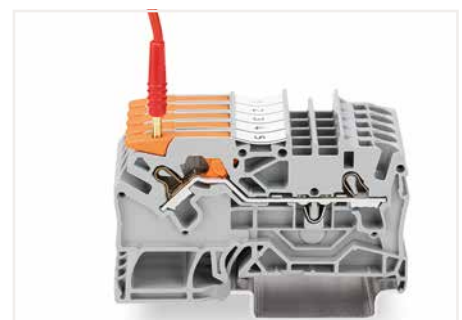

Testing with a 2 mm Ø test plug (max. 42 V).



Push-in CAGE CLAMP® terminates the following copper conductors:  
solid "s"



stranded "st"



fine-stranded "f-st", also with tinned single strands

**PUSH-IN CAGE CLAMP®**

# Rail-Mount Terminal Blocks TOPJOB® S; with Push-Buttons and Push-in CAGE CLAMP®

## 2200 to 2216 Series

### Description and Installation



Push-in termination of solid and ferruled conductors



Insert fine-stranded conductors via operating tool.



Removing all conductors via operating tool.

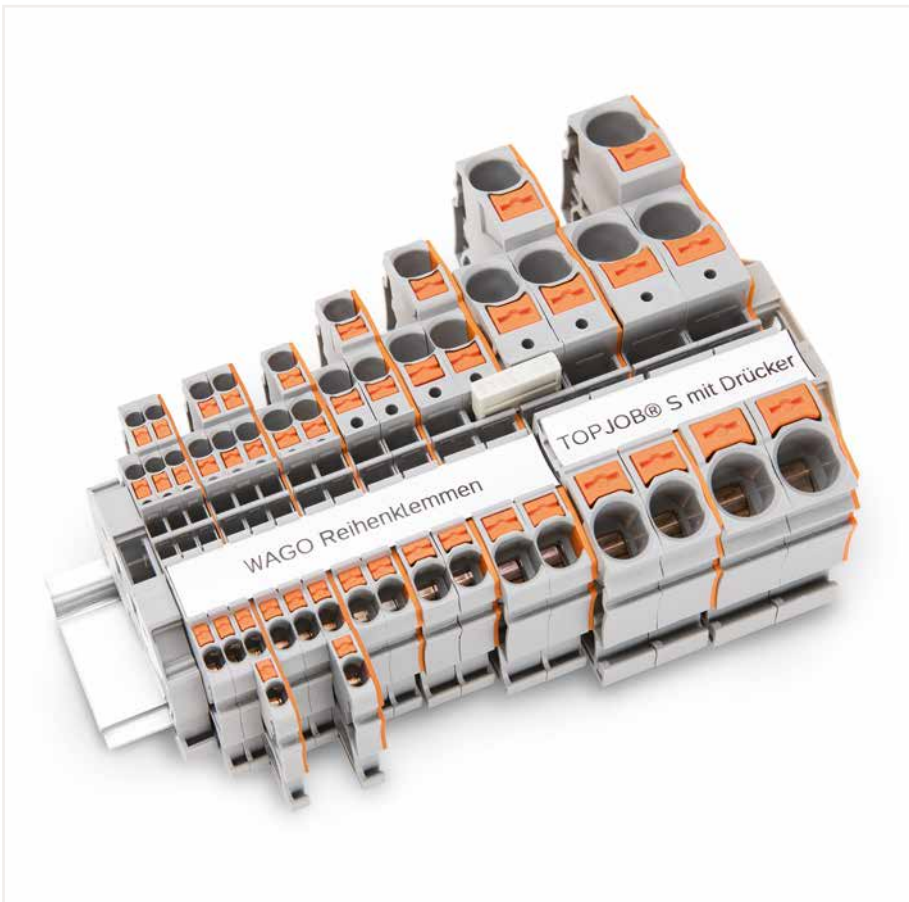

Insert push-in type jumper bar and push down until it hits backstop.



Commoning with step-down jumpers.

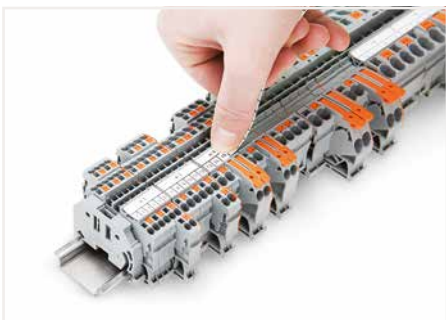

Snapping a marking strip into the marker slot.



Snapping a marking strip into the marker slot.



Testing with a 2 mm Ø test plug (max. 42 V).



fine-stranded, tip-bonded



fine-stranded, with ferrule (gastight crimped)





fine-stranded, with pin terminal (gastight crimped)





**PUSH-IN CAGE CLAMP®**

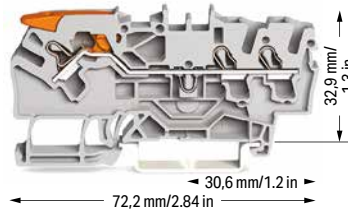
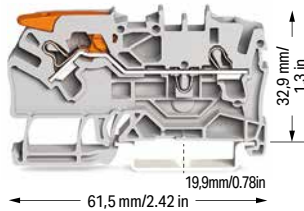

# Through Terminal Block, Ground Conductor Terminal Block TOPJOB® S; with Lever and Push-in CAGE CLAMP® 2.5 (4) mm<sup>2</sup>; 2102 Series

Technical Data	
0.25 ... 2.5 (4) mm <sup>2</sup> ①	22 ... 12 AWG
800 V/8 kV/3 ②	
I <sub>N</sub> 24 A (32 A)	
Terminal block width: 5.2 mm / 0.205 inch	
 10 ... 12 mm / 0.39 ... 0.47 inch	

Technical Data	
0.25 ... 2.5 (4) mm <sup>2</sup> ①	22 ... 12 AWG
800 V/8 kV/3 ②	
I <sub>N</sub> 24 A (30 A)	
Terminal block width: 5.2 mm / 0.205 inch	
 10 ... 12 mm / 0.39 ... 0.47 inch	







2-conductor through terminal block; with lever and Push-in CAGE CLAMP®		
Color	Item No.	Pack. Unit
 gray	2102-1201	50
 blue	2102-1204 ③	50

3-conductor through terminal block; with lever and Push-in CAGE CLAMP®		
Color	Item No.	Pack. Unit
 gray	2102-1301	50
 blue	2102-1304 ③	50

2-conductor ground terminal block; with lever and Push-in CAGE CLAMP®		
Color	Item No.	Pack. Unit
 green-yellow	2102-1207	50









3-conductor ground terminal block; with lever and Push-in CAGE CLAMP®		
Color	Item No.	Pack. Unit
 green-yellow	2102-1307	50

Accessories; item-specific			
End and intermediate plate; 0.8 mm thick			
 orange	2102-1292	100 (25)	
 gray	2102-1291	100 (25)	

Accessories; item-specific			
End and intermediate plate; 0.8 mm thick			
 orange	2102-1392	100 (25)	
 gray	2102-1391	100 (25)	

**Accessories; 2102 Series**  
Appropriate marking systems: WMB/WMB Inline/Marking strips



Insulation stop; 5 pcs/strip; 0.25 ... 0.5 mm <sup>2</sup>			
 light gray	2002-171	200 (25)	









Push-in type jumper bar; insulated; I <sub>N</sub> 25 A; light gray			
 1 to 3	2002-433	25	
 1 to 4	2002-434	25	
 1 to 5	2002-435	25	
 1 to 6	2002-436	25	
 1 to 7	2002-437	25	
 1 to 8	2002-438	25	
 1 to 9	2002-439	25	
 1 to 10	2002-440	25	

Insulation stop; 5 pcs/strip; 0.75 ... 1 mm <sup>2</sup>			
 dark gray	2002-172	200 (25)	

Adjacent jumper for continuous commoning; insulated; I <sub>N</sub> 25 A, light gray			
 2-way	2002-400	25	



Protective warning marker; with black high-voltage symbol; for 5 terminal blocks			
 yellow	2002-115	100 (25)	

Adjacent jumper for continuous commoning; insulated; I <sub>N</sub> 25 A; 1 to 3			
 light gray	2002-423	25	
 red	2002-423/000-005	25	
 blue	2002-423/000-006	25	

Push-in type jumper bar; insulated; I <sub>N</sub> 25 A; light gray			
 2-way	2002-402	25	
 3-way	2002-403	25	
 4-way	2002-404	25	
 5-way	2002-405	25	
 6-way	2002-406	25	
 7-way	2002-407	25	
 8-way	2002-408	25	
 9-way	2002-409	25	
 10-way	2002-410	25	

Adjacent jumper for continuous commoning; insulated; I <sub>N</sub> 25 A, light gray			
 5-way	2002-415	25	

Delta jumper; insulated; I <sub>N</sub> = I <sub>N</sub> terminal block; light gray			
 1-2 3-4 5-6	2002-406/020-000	25	

Push-in type wire jumper; insulated; 1.5 mm <sup>2</sup> conductor cross-section; I <sub>N</sub> 18 A			
 L = 60 mm	2009-412	100 (10)	
 L = 110 mm	2009-414	100 (10)	
 L = 250 mm	2009-416	100 (10)	

Star point jumper; insulated; I <sub>N</sub> = I <sub>N</sub> terminal block; light gray			
 1-3-5	2002-405/011-000	25	

① Conductor range: 0.25 ... 4 mm<sup>2</sup> "s+f-st"; Push-in termination: 1 ... 4 mm<sup>2</sup> "s" and 1 ... 2.5 mm<sup>2</sup> "insulated ferrules, 12 mm" Depending on the conductor characteristic, a conductor with a smaller cross section can also be inserted via push-in termination.











② 800 V = rated voltage  
8 kV = rated impulse voltage  
3 = pollution degree





③ Terminal blocks with a blue insulated housing are suitable for Ex i applications.

Please observe the application notes:  
Jumpers, from page 160  
Testing accessories, from page 154  
Marking, from page 246

Approvals and corresponding ratings, visit [www.wago.com](http://www.wago.com)

**Accessories; 2102 Series**  
Appropriate marking systems:  
WMB/WMB Inline/Marking strips

Staggered jumper; insulated; I <sub>N</sub> 25 A; light gray			
 2-way	2002-472	25	
 3-way	2002-473	25	
 4-way	2002-474	25	
 5-way	2002-475	25	
 6-way	2002-476	25	
 7-way	2002-477	25	
 8-way	2002-478	25	
 9-way	2002-479	25	
 10-way	2002-480	25	
 11-way	2002-481	25	
 12-way	2002-482	25	

Customized staggered jumper; insulated; with contact lugs broken off at the factory and circuit printing; I <sub>N</sub> 25 A; light gray			
 1-3	2002-473/011-000	25	
 1-3-5	2002-475/011-000	25	
 1-3-5-7	2002-477/011-000	25	
 1-3-5-7-9	2002-479/011-000	25	
 1-3-5-7-9-11	2002-481/011-000	25	

Modular connector; snaps together; for jumper contact slot			
 gray	2002-511	100 (25)	

L-type test plug module; snaps together			
 gray	2002-611	100 (25)	

WMB Inline, plain; 1,500 WMB markers (5 mm)/reel; 5 ... 5.2 mm stretchable			
 white	2009-115	1	

Marking strip; plain; 11 mm wide; 50 m reel			
 white	2009-110	1	

WMB marking card; white; 10 strips with 10 markers/card; 5 ... 5.2 mm stretchable			
 plain	793-5501	5	

# Through Terminal Block, Ground Conductor Terminal Block TOPJOB® S; with Lever and Push-in CAGE CLAMP®

## 6 (10) mm<sup>2</sup>; 2106 Series

### Technical Data

0.5 ... 6 (10) mm <sup>2</sup> ①	20 ... 8 AWG
800 V/8 kV/3 ②	
I <sub>N</sub> 41 A (55 A)	
Terminal block width: 7.5 mm / 0.295 inch	
 13 ... 15 mm / 0.51 ... 0.59 inch	



### 2-conductor through terminal block; with lever and Push-in CAGE CLAMP®

Color	Item No.	Pack. Unit
○ gray	2106-1201	25
● blue	2106-1204 ③	25

### 2-conductor ground terminal block; with lever and Push-in CAGE CLAMP®

● green-yellow	2106-1207	25
----------------	-----------	----

### Accessories; item-specific

#### End and intermediate plate; 1 mm thick

 orange	2106-1292	100 (25)
 gray	2106-1291	100 (25)



### Accessories; 2106 Series

Appropriate marking systems: WMB/WMB Inline/Marking strips

#### Push-in type jumper bar; insulated; I<sub>N</sub> 41 A; light gray

 2-way	2006-402	25
 3-way	2006-403	25
 4-way	2006-404	25
 5-way	2006-405	25

#### Push-in type jumper bar; insulated; I<sub>N</sub> 41 A; light gray

 1 to 3	2006-433	25
 1 to 4	2006-434	25
 1 to 5	2006-435	25

#### Star point jumper; insulated; I<sub>N</sub> = I<sub>N</sub> terminal block; light gray

 1-3-5	2006-405/011-000	25
---	------------------	----

#### Protective warning marker; with black high-voltage symbol; for 5 terminal blocks

 yellow	2006-115	100 (25)
--	----------	----------

### Technical Data

0.5 ... 6 (10) mm <sup>2</sup> ①	20 ... 8 AWG
800 V/8 kV/3 ②	
I <sub>N</sub> 41 A (55 A)	
Terminal block width: 7.5 mm / 0.295 inch	
 13 ... 15 mm / 0.51 ... 0.59 inch	

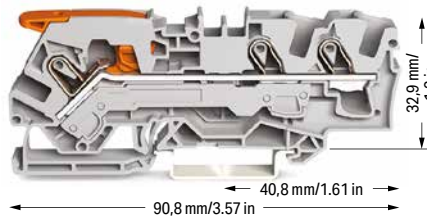

### 3-conductor through terminal block; with lever and Push-in CAGE CLAMP®

Color	Item No.	Pack. Unit
○ gray	2106-1301	25
● blue	2106-1304 ③	25

### 3-conductor ground terminal block; with lever and Push-in CAGE CLAMP®

● green-yellow	2106-1307	25
----------------	-----------	----

### Accessories; item-specific

#### End and intermediate plate; 1 mm thick

 orange	2106-1392	100 (25)
 gray	2106-1391	100 (25)

#### Lockout cap; for conductor entry and operating slot

 gray	2006-191	25
--	----------	----

#### Modular connector; snaps together; for jumper contact slot

 gray	2006-511	50 (25)
--	----------	---------

#### Test plug adapter; for 4 mm Ø test plug

 gray	2009-174	100 (25)
--	----------	----------

#### Marking strip; plain; 11 mm wide; 50 m reel

 white	2009-110	1
---	----------	---

#### WMB marking card; white; 10 strips with 10 markers/card; 5 ... 5.2 mm stretchable

 plain	793-5501	5
---	----------	---

① Conductor range: 0.5 ... 10 mm<sup>2</sup> "s+f-st"; Push-in termination: 2.5 ... 10 mm<sup>2</sup> "s" and 2.5 ... 6 mm<sup>2</sup> "insulated ferrules; 12 mm"  
Depending on the conductor characteristic, a conductor with a smaller cross section can also be inserted via push-in termination.

② 800 V = rated voltage  
8 kV = rated impulse voltage  
3 = pollution degree

③ Terminal blocks with a blue insulated housing are suitable for Ex i applications.

Please observe the application notes:  
Jumpers, from page 163  
Testing accessories, from page 156  
Marking, from page 246

Approvals and corresponding ratings, visit [www.wago.com](http://www.wago.com)

# Through Terminal Block, Ground Conductor Terminal Block TOPJOB® S; with Lever and Push-in CAGE CLAMP® 10 (16) mm<sup>2</sup>; 2110 Series

## Technical Data

0.5 ... 10 (16) mm<sup>2</sup> ① | 20 ... 6 AWG

800 V/8 kV/3 ②

I<sub>N</sub> 57 A

Terminal block width: 10 mm / 0.394 inch

 17 ... 19 mm / 0.67 ... 0.75 inch

## Technical Data

0.5 ... 10 (16) mm<sup>2</sup> ① | 20 ... 6 AWG

800 V/8 kV/3 ②

I<sub>N</sub> 57 A

Terminal block width: 10 mm / 0.394 inch

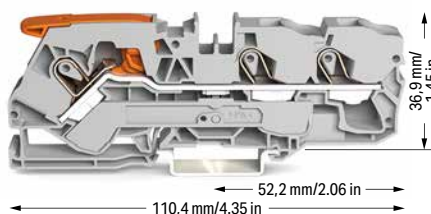
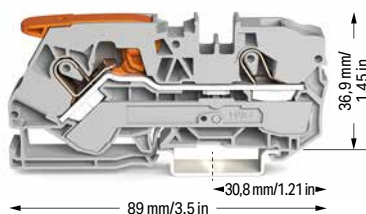
 17 ... 19 mm / 0.67 ... 0.75 inch

## 2-conductor through terminal block; with lever and Push-in CAGE CLAMP®

Color	Item No.	Pack. Unit
gray	2110-1201	25
blue	2110-1204 ③	25

## 3-conductor through terminal block; with lever and Push-in CAGE CLAMP®

Color	Item No.	Pack. Unit
gray	2110-1301	25
blue	2110-1304 ③	25

## 2-conductor ground terminal block; with lever and Push-in CAGE CLAMP®

green-yellow	2110-1207	25
--------------	-----------	----

## 3-conductor ground terminal block; with lever and Push-in CAGE CLAMP®

green-yellow	2110-1307	25
--------------	-----------	----

## Item-Specific Accessories

### End and intermediate plate; 1 mm thick

orange	2110-1292	100 (25)
gray	2110-1291	100 (25)

## Item-Specific Accessories

### End and intermediate plate; 1 mm thick

orange	2110-1392	100 (25)
gray	2110-1391	100 (25)

## Accessories; 2110 Series

Appropriate marking systems: WMB/WMB Inline/Marking strips

### Push-in type jumper bar; insulated; I<sub>N</sub> 57 A; light gray

2-way	2010-402	25
3-way	2010-403	25
4-way	2010-404	25
5-way	2010-405	25

### Push-in type jumper bar; insulated; I<sub>N</sub> 57 A; light gray

1 to 3	2010-433	25
1 to 4	2010-434	25
1 to 5	2010-435	25

### Star point jumper; insulated; I<sub>N</sub> = I<sub>N</sub> terminal block; light gray

1-3-5	2010-405/011-000	25
-------	------------------	----

### Protective warning marker; with black high-voltage symbol; for 5 terminal blocks

yellow	2010-115	100 (25)
--------	----------	----------

### Finger guard; touch-proof cover protects unused conductor entries

yellow	2010-100	100 (25)
--------	----------	----------

### Modular connector; snaps together; for jumper contact slot

gray	2010-511	50 (25)
------	----------	---------

### Test plug adapter; for 4 mm Ø test plug

gray	2009-174	100 (25)
------	----------	----------

### Marking strip; plain; 11 mm wide; 50 m reel

white	2009-110	1
-------	----------	---

### WMB marking card; white; 10 strips with 10 markers/card; 5 ... 5.2 mm stretchable

plain	793-5501	5
-------	----------	---

① Conductor range: 0.5 ... 16 mm<sup>2</sup> "s+f-st"  
Push-in termination: 4 ... 16 mm<sup>2</sup> "s" and 4 ... 10 mm<sup>2</sup> "insulated ferrules, 18 mm"  
Depending on the conductor characteristic, a conductor with a smaller cross section can also be inserted via push-in termination.

② 800 V = rated voltage  
8 kV = rated impulse voltage  
3 = pollution degree (see Full Line Catalog, Volume 1, Section 14)

③ Terminal blocks with a blue insulated housing are suitable for Ex i applications.

See application notes in our Full Line Catalog, Volume 1.  
Jumpers, from page 163  
Testing accessories, from page 156  
Marking, from page 246

Approvals and corresponding ratings, visit [www.wago.com](http://www.wago.com)

# Through Terminal Block, Ground Conductor Terminal Block TOPJOB® S; with Lever and Push-in CAGE CLAMP®

## 16 (25 "f-st") mm<sup>2</sup>; 2102 Series

### Technical Data

0.5 ... 16 (25 "f-st") mm<sup>2</sup> ① | 20 ... 4 AWG

800 V/8 kV/3 ②

I<sub>N</sub> 76 A (90 A)

Terminal block width: 12 mm / 0.472 inch

 18 ... 20 mm / 0.71 ... 0.79 inch

### Technical Data

0.5 ... 16 (25 "f-st") mm<sup>2</sup> ① | 20 ... 4 AWG

800 V/8 kV/3 ②

I<sub>N</sub> 76 A (90 A)

Terminal block width: 12 mm / 0.472 inch

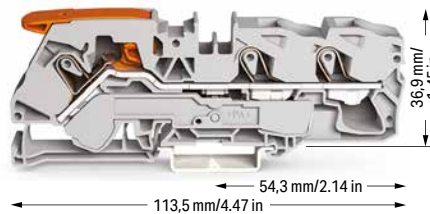
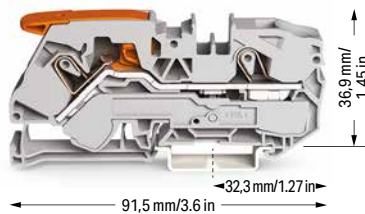
 18 ... 20 mm / 0.71 ... 0.79 inch

### 2-conductor through terminal block; with lever and Push-in CAGE CLAMP®

Color	Item No.	Pack. Unit
○ gray	2116-1201	20
● blue	2116-1204 ③	20

### 3-conductor through terminal block; with lever and Push-in CAGE CLAMP®

Color	Item No.	Pack. Unit
○ gray	2116-1301	20
● blue	2116-1304 ③	20

### 2-conductor ground terminal block; with lever and Push-in CAGE CLAMP®

15 mm high DIN-35 rails shall be used for a current load higher than 76 A!

● green-yellow	2116-1207	20
----------------	-----------	----

### 3-conductor ground terminal block; with lever and Push-in CAGE CLAMP®

15 mm high DIN-35 rails shall be used for a current load higher than 76 A!

● green-yellow	2116-1307	20
----------------	-----------	----



### Accessories; item-specific

#### End and intermediate plate; 1 mm thick

	orange	2116-1292	100 (25)
	gray	2116-1291	100 (25)

### Accessories; item-specific

#### End and intermediate plate; 1 mm thick

	orange	2116-1392	100 (25)
	gray	2116-1391	100 (25)

### Accessories; 2116 Series

Appropriate marking systems: WMB/WMB Inline/Marking strips

#### Push-in type jumper bar; insulated; I<sub>N</sub> 76 A; light gray

	2-way	2016-402	25
	3-way	2016-403	25
	4-way	2016-404	25
	5-way	2016-405	25

#### Finger guard; touch-proof cover protects unused conductor entries

	yellow	2016-100	100 (25)
---	--------	----------	----------

#### Push-in type jumper bar; insulated; I<sub>N</sub> 76 A; light gray

	1 to 3	2016-433	25
	1 to 4	2016-434	25
	1 to 5	2016-435	25

#### Modular connector; snaps together; for jumper contact slot

	gray	2016-511	50 (25)
---	------	----------	---------

#### Star point jumper; insulated; I<sub>N</sub> = I<sub>N</sub> terminal block; light gray

	1-3-5	2016-405/011-000	25
---	-------	------------------	----

#### Test plug adapter; for 4 mm Ø test plug

	gray	2009-174	100 (25)
---	------	----------	----------

#### Protective warning marker; with black high-voltage symbol; for 5 terminal blocks

	yellow	2016-115	100 (25)
---	--------	----------	----------

#### Marking strip; plain; 11 mm wide; 50 m reel

	white	2009-110	1
---	-------	----------	---

#### Three-phase set; with orange end plate; with a lever and Push-in CAGE CLAMP®

15 mm high DIN-35 rails shall be used for a current load higher than 76 A!

	2116-1201/605-038	1
---	-------------------	---

#### WMB marking card; white; 10 strips with 10 markers/card; 5 ... 5.2 mm stretchable

	plain	793-5501	5
---	-------	----------	---

① Conductor range: 0.5 ... 16 mm<sup>2</sup> "s+f-st", 25 mm<sup>2</sup> "f-st"; Push-in termination: 6 ... 16 mm<sup>2</sup> "s" and 6 ... 16 mm<sup>2</sup> "insulated ferrules; 18 mm"  
Depending on the conductor characteristic, a conductor with a smaller cross section can also be inserted via push-in termination.

② 800 V = rated voltage  
8 kV = rated impulse voltage  
3 = pollution degree

③ Terminal blocks with a blue insulated housing are suitable for Ex i applications.

Please observe the application notes:

Jumpers, from page 163

Testing accessories, from page 157

Marking, from page 246

Approvals and corresponding ratings, visit [www.wago.com](http://www.wago.com)



# Through Terminal Block, Ground Conductor Terminal Block TOPJOB® S; with Lever and Push-Button

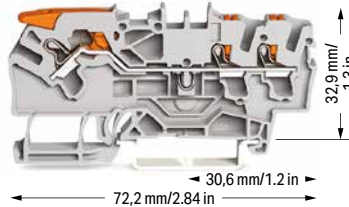
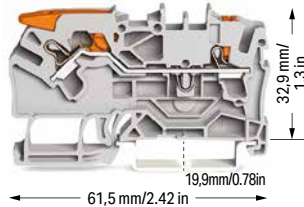

## 2.5 (4) mm<sup>2</sup>; 2102 Series

Technical Data	
0.25 ... 2.5 (4) mm <sup>2</sup> ①	22 ... 12 AWG
800 V/8 kV/3 ②	
I <sub>N</sub> 24 A (32 A)	
Terminal block width: 5.2 mm / 0.205 inch	
 10 ... 12 mm / 0.39 ... 0.47 inch	

Technical Data	
0.25 ... 2.5 (4) mm <sup>2</sup> ①	22 ... 12 AWG
800 V/8 kV/3 ②	
I <sub>N</sub> 24 A (30 A)	
Terminal block width: 5.2 mm / 0.205 inch	
 10 ... 12 mm / 0.39 ... 0.47 inch	







2-conductor through terminal block; with lever and push-button		
Color	Item No.	Pack. Unit
 gray	2102-5201	50
 blue	2102-5204 ③	50

3-conductor through terminal block; with lever and push-button		
Color	Item No.	Pack. Unit
 gray	2102-5301	50
 blue	2102-5304 ③	50

2-conductor ground terminal block; with lever and push-button		
Color	Item No.	Pack. Unit
 green-yellow	2102-5207	50

3-conductor ground terminal block; with lever and push-button		
Color	Item No.	Pack. Unit
 green-yellow	2102-5307	50

Accessories; item-specific			
End and intermediate plate; 0.8 mm thick			
	orange	2102-1292	100 (25)
	gray	2102-1291	100 (25)

Accessories; item-specific			
End and intermediate plate; 0.8 mm thick			
	orange	2102-1392	100 (25)
	gray	2102-1391	100 (25)









**Accessories; 2102 Series**  
Appropriate marking systems: WMB/WMB Inline/Marking strips



Insulation stop; 5 pcs/strip; 0.25 ... 0.5 mm <sup>2</sup>		
	light gray	2002-171 200 (25)









Star point jumper; insulated; I <sub>N</sub> = I <sub>N</sub> terminal block; light gray		
	1-3-5	2002-405/011-000 25

Insulation stop; 5 pcs/strip; 0.75 ... 1 mm <sup>2</sup>		
	dark gray	2002-172 200 (25)

Adjacent jumper for continuous commoning; insulated; I <sub>N</sub> 25 A, light gray		
	2-way	2002-400 25











Push-in type jumper bar; insulated; I <sub>N</sub> 25 A; light gray		
	2-way	2002-402 25
	3-way	2002-403 25
	4-way	2002-404 25
	5-way	2002-405 25
	6-way	2002-406 25
	7-way	2002-407 25
	8-way	2002-408 25
	9-way	2002-409 25
	10-way	2002-410 25

Adjacent jumper for continuous commoning; insulated; I <sub>N</sub> 25 A; 1 to 3		
	light gray	2002-423 25
	red	2002-423/000-005 25
	blue	2002-423/000-006 25

Push-in type jumper bar; insulated; I <sub>N</sub> 25 A; light gray		
	1 to 3	2002-433 25
	1 to 4	2002-434 25
	1 to 5	2002-435 25
	1 to 6	2002-436 25
	1 to 7	2002-437 25
	1 to 8	2002-438 25
	1 to 9	2002-439 25
	1 to 10	2002-440 25

Adjacent jumper for continuous commoning; insulated; I <sub>N</sub> 25 A, light gray		
	5-way	2002-415 25

Delta jumper; insulated; I <sub>N</sub> = I <sub>N</sub> terminal block; light gray		
	1-2 3-4 5-6	2002-406/020-000 25

Staggered jumper; insulated; I <sub>N</sub> 25 A; light gray		
	2-way	2002-472 25
	3-way	2002-473 25
	4-way	2002-474 25
	5-way	2002-475 25
	6-way	2002-476 25
	7-way	2002-477 25
	8-way	2002-478 25
	9-way	2002-479 25
	10-way	2002-480 25
	11-way	2002-481 25
	12-way	2002-482 25

- ① Conductor range: 0.25 ... 4 mm<sup>2</sup> "s+f-st"; Push-in termination: 1 ... 4 mm<sup>2</sup> "s" and 1 ... 2.5 mm<sup>2</sup> "insulated ferrules, 12 mm" Depending on the conductor characteristic, a conductor with a smaller cross section can also be inserted via push-in termination.
  - ② 800 V = rated voltage  
8 kV = rated impulse voltage  
3 = pollution degree
  - ③ Terminal blocks with a blue insulated housing are suitable for Ex i applications.
- Please observe the application notes:  
Jumpers, from page 160  
Testing accessories, from page 154  
Marking, from page 246
- Approvals and corresponding ratings, visit [www.wago.com](http://www.wago.com)

Accessories; 2102 Series			
Appropriate marking systems: WMB/WMB Inline/Marking strips			
	Customized staggered jumper; insulated; with contact lugs broken off at the factory and circuit printing; I <sub>N</sub> 25 A; light gray		
	1-3	2002-473/011-000	25
	1-3-5	2002-475/011-000	25
	1-3-5-7	2002-477/011-000	25
	1-3-5-7-9	2002-479/011-000	25
	1-3-5-7-9-11	2002-481/011-000	25

Push-in type wire jumper; insulated; 1.5 mm <sup>2</sup> conductor cross-section; I <sub>N</sub> 18 A			
	L = 60 mm	2009-412	100 (10)
	L = 110 mm	2009-414	100 (10)
	L = 250 mm	2009-416	100 (10)

Modular connector; snaps together; for jumper contact slot			
	gray	2002-511	100 (25)

Spacer module; snaps together; bridges commoned terminal blocks			
	gray	2002-549	100 (25)

End plate; for modular connector; 1.5 mm thick			
	gray	2002-541	100 (25)

WMB Inline, plain; 1,500 WMB markers (5 mm)/reel; 5 ... 5.2 mm stretchable			
	white	2009-115	1

Marking strip; plain; 11 mm wide; 50 m reel			
	white	2009-110	1



# Through Terminal Block, Ground Conductor Terminal Block TOPJOB® S; with Lever and Push-Button

## 6 (10) mm<sup>2</sup>; 2106 Series

### Technical Data

0.5 ... 6 (10) mm <sup>2</sup> ①	20 ... 8 AWG
800 V/8 kV/3 ②	
I <sub>N</sub> 41 A (55 A)	
Terminal block width: 7.5 mm / 0.295 inch	
 13 ... 15 mm / 0.51 ... 0.59 inch	



### 2-conductor through terminal block; with lever and push-button

Color	Item No.	Pack. Unit
○ gray	2106-5201	25
● blue	2106-5204 ③	25

### 2-conductor ground terminal block; with lever and push-button

● green-yellow	2106-5207	25
----------------	-----------	----

### Accessories; item-specific

#### End and intermediate plate; 1 mm thick

 orange	2106-1292	100 (25)
 gray	2106-1291	100 (25)



### Accessories; 2106 Series

Appropriate marking systems: WMB/WMB Inline/Marking strips

#### Push-in type jumper bar; insulated; I<sub>N</sub> 41 A; light gray

 2-way	2006-402	25
 3-way	2006-403	25
 4-way	2006-404	25
 5-way	2006-405	25

#### Push-in type jumper bar; insulated; I<sub>N</sub> 41 A; light gray

 1 to 3	2006-433	25
 1 to 4	2006-434	25
 1 to 5	2006-435	25

#### Star point jumper; insulated; I<sub>N</sub> = I<sub>N</sub> terminal block; light gray

 1-3-5	2006-405/011-000	25
---	------------------	----

### Technical Data

0.5 ... 6 (10) mm <sup>2</sup> ①	20 ... 8 AWG
800 V/8 kV/3 ②	
I <sub>N</sub> 41 A (55 A)	
Terminal block width: 7.5 mm / 0.295 inch	
 13 ... 15 mm / 0.51 ... 0.59 inch	

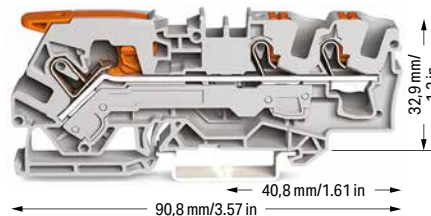

### 3-conductor through terminal block; with lever and push-button

Color	Item No.	Pack. Unit
○ gray	2106-5301	25
● blue	2106-5304 ③	25

### 3-conductor ground terminal block; with lever and push-button

● green-yellow	2106-5307	25
----------------	-----------	----

### Accessories; item-specific

#### End and intermediate plate; 1 mm thick

 orange	2106-1392	100 (25)
 gray	2106-1391	100 (25)

#### Lockout cap; for conductor entry and operating slot

 gray	2006-191	25
--	----------	----

#### Modular connector; snaps together; for jumper contact slot

 gray	2006-511	50 (25)
--	----------	---------

#### Test plug adapter; for 4 mm Ø test plug

 gray	2009-174	100 (25)
--	----------	----------

#### Marking strip; plain; 11 mm wide; 50 m reel

 white	2009-110	1
---	----------	---

#### WMB marking card; white; 10 strips with 10 markers/card; 5 ... 5.2 mm stretchable

 plain	793-5501	5
---	----------	---

① Conductor range: 0.5 ... 10 mm<sup>2</sup> "s+f-st"; Push-in termination: 2.5 ... 10 mm<sup>2</sup> "s" and 2.5 ... 6 mm<sup>2</sup> "insulated ferrules; 12 mm" Depending on the conductor characteristic, a conductor with a smaller cross section can also be inserted via push-in termination.

② 800 V = rated voltage  
8 kV = rated impulse voltage  
3 = pollution degree

③ Terminal blocks with a blue insulated housing are suitable for Ex i applications.

Please observe the application notes:  
Jumpers, from page 163  
Testing accessories, from page 156  
Marking, from page 246

Approvals and corresponding ratings, visit [www.wago.com](http://www.wago.com)

Sold & Serviced By:

 **ELECTROMATE**

Toll Free Phone (877) SERV098

[www.electromate.com](http://www.electromate.com)

[sales@electromate.com](mailto:sales@electromate.com)

# Through Terminal Block, Ground Conductor Terminal Block TOPJOB® S; with Lever and Push-Button

## 10 (16) mm<sup>2</sup>; 2110 Series

### Technical Data

0.5 ... 10 (16) mm<sup>2</sup> ① | 20 ... 6 AWG

800 V/8 kV/3 ②

I<sub>N</sub> 57 A

Terminal block width: 10 mm / 0.394 inch

 17 ... 19 mm / 0.67 ... 0.75 inch

### Technical Data

0.5 ... 10 (16) mm<sup>2</sup> ① | 20 ... 6 AWG

800 V/8 kV/3 ②

I<sub>N</sub> 57 A

Terminal block width: 10 mm / 0.394 inch

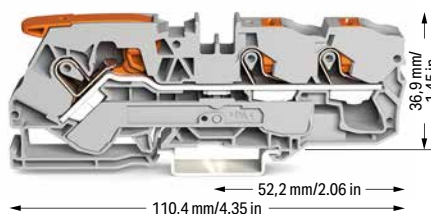
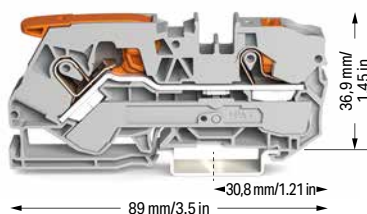
 17 ... 19 mm / 0.67 ... 0.75 inch

### 2-conductor through terminal block; with lever and push-button

Color	Item No.	Pack. Unit
○ gray	2110-5201	25
● blue	2110-5204 ③	25

### 3-conductor through terminal block; with lever and push-button

Color	Item No.	Pack. Unit
○ gray	2110-5301	25
● blue	2110-5304 ③	25

### 2-conductor ground terminal block; with lever and Push-in CAGE CLAMP®

● green-yellow	2110-5207	25
----------------	-----------	----

### 3-conductor ground terminal block; with lever and Push-in CAGE CLAMP®

● green-yellow	2110-5307	25
----------------	-----------	----

### Item-Specific Accessories

#### End and intermediate plate; 1 mm thick

 orange	2110-1292	100 (25)
 gray	2110-1291	100 (25)

### Item-Specific Accessories

#### End and intermediate plate; 1 mm thick

 orange	2110-1392	100 (25)
 gray	2110-1391	100 (25)

### Accessories; 2110 Series

Appropriate marking systems: WMB/WMB Inline/Marking strips

### Push-in type jumper bar; insulated; I<sub>N</sub> 57 A; light gray

 2-way	2010-402	25
 3-way	2010-403	25
 4-way	2010-404	25
 5-way	2010-405	25

### Push-in type jumper bar; insulated; I<sub>N</sub> 57 A; light gray

 1 to 3	2010-433	25
 1 to 4	2010-434	25
 1 to 5	2010-435	25

### Star point jumper; insulated; I<sub>N</sub> = I<sub>N</sub> terminal block; light gray

 1-3-5	2010-405/011-000	25
--	------------------	----

### Finger guard; touch-proof cover protects unused conductor entries

 yellow	2010-100	100 (25)
--	----------	----------

### Modular connector; snaps together; for jumper contact slot

 gray	2010-511	50 (25)
--	----------	---------

### Test plug adapter; for 4 mm Ø test plug

 gray	2009-174	100 (25)
--	----------	----------

### Marking strip; plain; 11 mm wide; 50 m reel

 white	2009-110	1
---	----------	---

### WMB marking card; white; 10 strips with 10 markers/card; 5 ... 5.2 mm stretchable

 plain	793-5501	5
---	----------	---

① Conductor range: 0.5 ... 16 mm<sup>2</sup> "s+f-st"  
Push-in termination: 4 ... 16 mm<sup>2</sup> "s" and 4 ... 10 mm<sup>2</sup> "insulated ferrules, 18 mm"  
Depending on the conductor characteristic, a conductor with a smaller cross section can also be inserted via push-in termination.

② 800 V = rated voltage  
8 kV = rated impulse voltage  
3 = pollution degree (see Full Line Catalog, Volume 1, Section 14)

③ Terminal blocks with a blue insulated housing are suitable for Ex i applications.

See application notes in our Full Line Catalog, Volume 1.  
Jumpers, from page 163  
Testing accessories, from page 156  
Marking, from page 246

Approvals and corresponding ratings, visit [www.wago.com](http://www.wago.com)



# Through Terminal Block, Ground Conductor Terminal Block TOPJOB® S; with Lever and Push-Button

## 16 (25 "f-st") mm<sup>2</sup>; 2102 Series

### Technical Data

0.5 ... 16 (25 "f-st") mm<sup>2</sup> ① | 20 ... 4 AWG

800 V/8 kV/3 ②

I<sub>N</sub> 76 A (90 A)

Terminal block width: 12 mm / 0.472 inch

 18 ... 20 mm / 0.71 ... 0.79 inch

### Technical Data

0.5 ... 16 (25 "f-st") mm<sup>2</sup> ① | 20 ... 4 AWG

800 V/8 kV/3 ②

I<sub>N</sub> 76 A (90 A)

Terminal block width: 12 mm / 0.472 inch

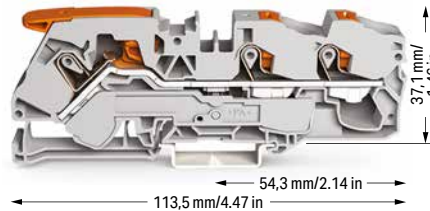
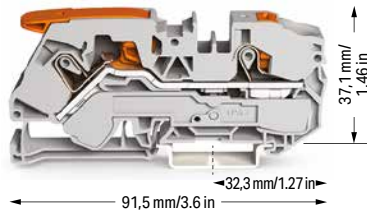
 18 ... 20 mm / 0.71 ... 0.79 inch

### 2-conductor through terminal block; with lever and push-button

Color	Item No.	Pack. Unit
○ gray	2116-5201	20
● blue	2116-5204 ③	20

### 3-conductor through terminal block; with lever and push-button

Color	Item No.	Pack. Unit
○ gray	2116-5301	20
● blue	2116-5304 ③	20

### 2-conductor ground terminal block; with lever and push-button

15 mm high DIN-35 rails shall be used for a current load higher than 76 A!

● green-yellow	2116-5207	20
----------------	-----------	----

### 3-conductor ground terminal block; with lever and push-button

15 mm high DIN-35 rails shall be used for a current load higher than 76 A!

● green-yellow	2116-5307	20
----------------	-----------	----

### Accessories; item-specific

#### End and intermediate plate; 1 mm thick

	orange	2116-1292	100 (25)
	gray	2116-1291	100 (25)

### Accessories; item-specific

#### End and intermediate plate; 1 mm thick

	orange	2116-1392	100 (25)
	gray	2116-1391	100 (25)

### Accessories; 2116 Series

Appropriate marking systems: WMB/WMB Inline/Marking strips

#### Push-in type jumper bar; insulated; I<sub>N</sub> 76 A; light gray

	2-way	2016-402	25
	3-way	2016-403	25
	4-way	2016-404	25
	5-way	2016-405	25

#### Push-in type jumper bar; insulated; I<sub>N</sub> 76 A; light gray

	1 to 3	2016-433	25
	1 to 4	2016-434	25
	1 to 5	2016-435	25

#### Star point jumper; insulated; I<sub>N</sub> = I<sub>N</sub> terminal block; light gray

	1-3-5	2016-405/011-000	25
---	-------	------------------	----

#### Finger guard; touch-proof cover protects unused conductor entries

	yellow	2016-100	100 (25)
---	--------	----------	----------

#### Modular connector; snaps together; for jumper contact slot

	gray	2016-511	50 (25)
---	------	----------	---------

#### Test plug adapter; for 4 mm Ø test plug

	gray	2009-174	100 (25)
---	------	----------	----------

#### Marking strip; plain; 11 mm wide; 50 m reel

	white	2009-110	1
---	-------	----------	---

#### WMB marking card; white; 10 strips with 10 markers/card; 5 ... 5.2 mm stretchable

	plain	793-5501	5
---	-------	----------	---

① Conductor range: 0.5 ... 16 mm<sup>2</sup> "s+f-st", 25 mm<sup>2</sup> "f-st"; Push-in termination: 6 ... 16 mm<sup>2</sup> "s" and 6 ... 16 mm<sup>2</sup> "insulated ferrules; 18 mm"  
Depending on the conductor characteristic, a conductor with a smaller cross section can also be inserted via push-in termination.

② 800 V = rated voltage  
8 kV = rated impulse voltage  
3 = pollution degree

③ Terminal blocks with a blue insulated housing are suitable for Ex i applications.

Please observe the application notes:

Jumpers, from page 163

Testing accessories, from page 157

Marking, from page 246

Approvals and corresponding ratings, visit [www.wago.com](http://www.wago.com)

# Through Terminal Block, Ground Conductor Terminal Block TOPJOB® S; with Push-Button 1 (1.5) mm<sup>2</sup>; 2200 Series

Technical Data	
0.14 ... 1 (1.5) mm <sup>2</sup> ①	24 ... 16 AWG
800 V/8 kV/3 ②	
I <sub>N</sub> 13.5 A (17.5 A)	
Terminal block width: 3.5 mm / 0.138 inch	
 9 ... 11 mm / 0.35 ... 0.43 inch	

Technical Data	
0.14 ... 1 (1.5) mm <sup>2</sup> ①	24 ... 16 AWG
800 V/8 kV/3 ②	
I <sub>N</sub> 13.5 A (17.5 A)	
Terminal block width: 3.5 mm / 0.138 inch	
 9 ... 11 mm / 0.35 ... 0.43 inch	

Technical Data	
0.14 ... 1 (1.5) mm <sup>2</sup> ①	24 ... 16 AWG
800 V/8 kV/3 ②	
I <sub>N</sub> 13.5 A (17.5 A)	
Terminal block width: 3.5 mm / 0.138 inch	
 9 ... 11 mm / 0.35 ... 0.43 inch	

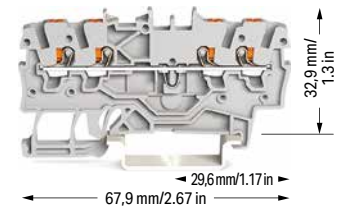
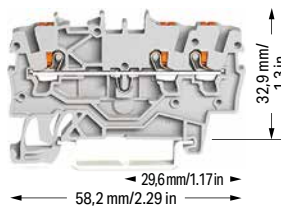
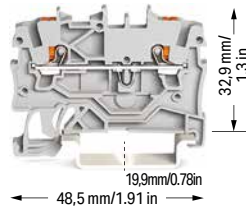

2-conductor through terminal block; with push-button		
Color	Item No.	Pack. Unit
○ gray	2200-1201	100
● blue	2200-1204 ③	100

3-conductor through terminal block; with push-button		
Color	Item No.	Pack. Unit
○ gray	2200-1301	100
● blue	2200-1304 ③	100

4-conductor through terminal block; with push-button		
Color	Item No.	Pack. Unit
○ gray	2200-1401	100
● blue	2200-1404 ③	100

2-conductor ground terminal block; with push-button		
● green-yellow	2200-1207	100

3-conductor ground terminal block; with push-button		
● green-yellow	2200-1307	100

4-conductor ground terminal block; with push-button		
● green-yellow	2200-1407	100

Accessories; item-specific			
End and intermediate plate; 0.7 mm thick			
	orange	2000-1292	100 (25)
	gray	2000-1291	100 (25)

Accessories; item-specific			
End and intermediate plate; 0.7 mm thick			
	orange	2000-1392	100 (25)
	gray	2000-1391	100 (25)

Accessories; item-specific			
End and intermediate plate; 0.7 mm thick			
	orange	2000-1492	100 (25)
	gray	2000-1491	100 (25)

## Accessories; 2200 Series

Appropriate marking systems: WMB/WMB Inline/Marking strips

Push-in type jumper bar; insulated; I <sub>N</sub> 14 A; light gray			
	2-way	2000-402	25
	3-way	2000-403	25
	4-way	2000-404	25
	5-way	2000-405	25
	6-way	2000-406	25
	7-way	2000-407	25
	8-way	2000-408	25
	9-way	2000-409	25
	10-way	2000-410	25

Modular connector; snaps together; for jumper contact slot			
Terminal block width: 5 mm / 0.197 inch			
	gray	2000-511	100 (25)

WMB Inline; plain; 2,300 WMB markers (3.5 mm)/reel			
	white	2009-113	1

Push-in type jumper bar; insulated; I <sub>N</sub> 14 A; light gray			
	1 to 3	2000-433	25
	1 to 4	2000-434	25
	1 to 5	2000-435	25
	1 to 6	2000-436	25
	1 to 7	2000-437	25
	1 to 8	2000-438	25
	1 to 9	2000-439	25
	1 to 10	2000-440	25

Modular connector; snaps together; for jumper contact slot			
	gray	2000-510	100 (25)

Marking strip; plain; 11 mm wide; 50 m reel			
	white	2009-110	1

Delta jumper; insulated; I <sub>N</sub> = I <sub>N</sub> terminal block; light gray			
	1-2 3-4 5-6	2000-406/020-000	25

Spacer module; snaps together; bridges commoned terminal blocks			
	gray	2000-549	100 (25)

WMB marking card; white; 10 strips with 10 markers/card; for 3.5 mm terminal block width			
	plain	793-3501	5

Star point jumper; insulated; I <sub>N</sub> = I <sub>N</sub> terminal block; light gray			
	1-3-5	2000-405/011-000	25

End plate; for modular connector; 1.5 mm thick			
	gray	2002-541	100 (25)

Test plug; with 500 mm cable; 2 mm Ø; max. 42 V			
	red	210-136	50 (1)

Push-in type wire jumper; insulated; 0.75 mm <sup>2</sup> conductor cross-section; I <sub>N</sub> 9 A			
	L = 60 mm	2009-402	100 (10)
	L = 110 mm	2009-404	100 (10)
	L = 250 mm	2009-406	100 (10)

Test plug; with 500 mm cable; 2.3 mm Ø; max. 42 V			
	yellow	210-137	50 (1)

① Conductor range: 0.14 ... 1.5 mm<sup>2</sup> "s+f-st";  
Push-in termination: 0.5 ... 1.5 mm<sup>2</sup> "s" and  
0.5 ... 0.75 mm<sup>2</sup> "insulated ferrules; 10 mm"  
Depending on the conductor characteristic, a conductor with a smaller cross section can also be inserted via push-in termination.

② 800 V = rated voltage  
8 kV = rated impulse voltage  
3 = pollution degree

③ Terminal blocks with a blue insulated housing are suitable for Ex i applications.

Please observe the application notes:  
Jumpers, from page 160  
Testing accessories, from page 154  
Marking, from page 246

Approvals and corresponding ratings,  
visit [www.wago.com](http://www.wago.com)

# Through Terminal Block, Ground Conductor Terminal Block, Double-Potential Terminal Block TOPJOB® S; with Push-Button 1.5 (2.5) mm<sup>2</sup>; 2201 Series

Technical Data	
0.25 ... 1.5 (2.5) mm <sup>2</sup> ①	22 ... 14 AWG
800 V/8 kV/3 ②	
I <sub>N</sub> 18 A (24 A)	
Terminal block width: 4.2 mm / 0.165 inch	
9 ... 11 mm / 0.35 ... 0.43 inch	

Technical Data	
0.25 ... 1.5 (2.5) mm <sup>2</sup> ①	22 ... 14 AWG
800 V/8 kV/3 ②	
I <sub>N</sub> 18 A (24 A)	
Terminal block width: 4.2 mm / 0.165 inch	
9 ... 11 mm / 0.35 ... 0.43 inch	

Technical Data	
0.25 ... 1.5 (2.5) mm <sup>2</sup> ①	22 ... 14 AWG
800 V/8 kV/3 ②	
I <sub>N</sub> 18 A (24 A)	
Terminal block width: 4.2 mm / 0.165 inch	
9 ... 11 mm / 0.35 ... 0.43 inch	

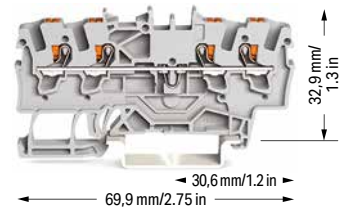
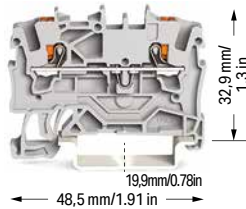

2-conductor through terminal block; with push-button		
Color	Item No.	Pack. Unit
gray	2201-1201	100
blue	2201-1204 ③	100
orange	2201-1202	100

3-conductor through terminal block; with push-button		
Color	Item No.	Pack. Unit
gray	2201-1301	100
blue	2201-1304 ③	100
orange	2201-1302	100

4-conductor through terminal block; with push-button		
Color	Item No.	Pack. Unit
gray	2201-1401	100
blue	2201-1404 ③	100
orange	2201-1402	100

2-conductor ground terminal block; with push-button		
green-yellow	2201-1207	100

3-conductor ground terminal block; with push-button		
green-yellow	2201-1307	100

4-conductor ground terminal block; with push-button		
green-yellow	2201-1407	100

Accessories; item-specific			
End and intermediate plate; 0.8 mm thick			
orange	2002-1292	100 (25)	
gray	2002-1291	100 (25)	

Accessories; item-specific			
End and intermediate plate; 0.8 mm thick			
orange	2002-1392	100 (25)	
gray	2002-1391	100 (25)	

Accessories; item-specific			
End and intermediate plate; 0.8 mm thick			
orange	2002-1492	100 (25)	
gray	2002-1491	100 (25)	

Separator; oversized; 2 mm thick			
orange	2002-1294	100 (25)	
gray	2002-1293	100 (25)	

Separator; oversized; 2 mm thick			
orange	2002-1394	100 (25)	
gray	2002-1393	100 (25)	

Separator; oversized; 2 mm thick			
orange	2002-1494	100 (25)	
gray	2002-1493	100 (25)	

Accessories; 2201 Series

Appropriate marking systems: WMB/WMB Inline/Marking strips

Insulation stop; 5 pcs/strip; 0.25 ... 0.5 mm <sup>2</sup>			
light gray	2001-171	200 (25)	

Delta jumper; insulated; I <sub>N</sub> = I <sub>N</sub> terminal block; light gray			
1-2 3-4 5-6	2001-406/020-000	25	

Test plug adapter; for 4 mm Ø test plug			
gray	2009-174	100 (25)	

Push-in type jumper bar; insulated; I <sub>N</sub> 18 A; light gray			
2-way	2001-402	25	
3-way	2001-403	25	
4-way	2001-404	25	
5-way	2001-405	25	
6-way	2001-406	25	
7-way	2001-407	25	
8-way	2001-408	25	
9-way	2001-409	25	
10-way	2001-410	25	

Star point jumper; insulated; I <sub>N</sub> = I <sub>N</sub> terminal block; light gray			
1-3-5	2001-405/011-000	25	

Banana plug; for 4 mm socket diameter; color mixed; 10 x orange, white, black, blue, yellow; max. 42 V			
	215-111	50	

Push-in type jumper bar; insulated; I <sub>N</sub> 18 A; light gray			
1 to 3	2001-433	25	
1 to 4	2001-434	25	
1 to 5	2001-435	25	
1 to 6	2001-436	25	
1 to 7	2001-437	25	
1 to 8	2001-438	25	
1 to 9	2001-439	25	
1 to 10	2001-440	25	

Push-in type wire jumper; insulated; 1.5 mm <sup>2</sup> conductor cross-section; I <sub>N</sub> 18 A			
L = 60 mm	2009-412	100 (10)	
L = 110 mm	2009-414	100 (10)	
L = 250 mm	2009-416	100 (10)	

Testing tap; for max. 2.5 mm <sup>2</sup>			
gray	2009-182	100 (25)	

Step-down jumper; insulated; commons 6/4 mm <sup>2</sup> (10/12 AWG) to 4/2.5/1.5 mm <sup>2</sup> (12/14/16 AWG); I <sub>N</sub> 32 A			
light gray	2006-499	25	

Modular connector; snaps together; for jumper contact slot			
gray	2001-511	100 (25)	

Test plug; with 500 mm cable; 2 mm Ø; max. 42 V			
red	210-136	50 (1)	

Spacer module; snaps together; bridges commoned terminal blocks			
gray	2001-549	100 (25)	

Test plug; with 500 mm cable; 2.3 mm Ø; max. 42 V			
yellow	210-137	50 (1)	

End plate; for modular connector; 1.5 mm thick			
gray	2002-541	100 (25)	

WMB Inline; plain; 2,000 WMB markers (4 mm)/reel; 4 ... 4.2 mm stretchable			
white	2009-114	1	

1 Conductor range: 0.25 ... 2.5 mm<sup>2</sup> "s+f-st";  
Push-in termination: 0.75 ... 2.5 mm<sup>2</sup> "s" and  
0.75 ... 1.5 mm<sup>2</sup> "insulated ferrules; 12 mm"  
Depending on the conductor characteristic, a conductor  
with a smaller cross section can also be inserted  
via push-in termination.

2 800 V = rated voltage  
8 kV = rated impulse voltage  
3 = pollution degree

3 Terminal blocks with a blue insulated housing are  
suitable for Ex i applications.

Please observe the application notes:  
Jumpers, from page 163  
Testing accessories, from page 154  
Marking, from page 246

Approvals and corresponding ratings,  
visit [www.wago.com](http://www.wago.com)



Step-down jumper (2006-499) commons 6/4 mm<sup>2</sup>  
(10/12 AWG) terminal blocks (2206/2204 Series) with  
4/2.5/1.5 mm<sup>2</sup> (AWG 12/14/16) terminal blocks  
(2204/2202/2201 Series).

#### Accessories; 2201 Series

Appropriate marking systems:  
WMB/WMB Inline/Marking strips

#### Marking strip; plain; 11 mm wide; 50 m reel

white	2009-110	1
-------	----------	---



#### WMB marking card; white; 10 strips with 10 markers/card; 4 ... 4.2 mm stretchable

plain	793-4501	5
-------	----------	---



#### WMB marking card; plain; 10 strips with 10 markers/card; 4 ... 4.2 mm stretchable

yellow	793-4501/000-002	5
red	793-4501/000-005	5
blue	793-4501/000-006	5
gray	793-4501/000-007	5
orange	793-4501/000-012	5
light green	793-4501/000-017	5
green	793-4501/000-023	5
violet	793-4501/000-024	5



#### Screwless end stop; for DIN-35 rail; 6 mm wide

gray	249-116	100 (25)
------	---------	----------



#### Screwless end stop; for DIN-35 rail; 10 mm wide

gray	249-117	50 (25)
------	---------	---------



# Through Terminal Block, Ground Conductor Terminal Block, Double-Potential Terminal Block TOPJOB® S; with Push-Button

## 2.5 (4) mm<sup>2</sup>; 2202 Series

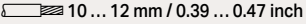
Technical Data	
0.25 ... 2.5 (4) mm <sup>2</sup> ①	22 ... 12 AWG
800 V/8 kV/3 ②	
I <sub>N</sub> 24 A (32 A)	
Terminal block width: 5.2 mm / 0.205 inch	
 10 ... 12 mm / 0.39 ... 0.47 inch	

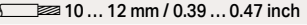
Technical Data	
0.25 ... 2.5 (4) mm <sup>2</sup> ①	22 ... 12 AWG
800 V/8 kV/3 ②	
I <sub>N</sub> 24 A (32 A)	
Terminal block width: 5.2 mm / 0.205 inch	
 10 ... 12 mm / 0.39 ... 0.47 inch	

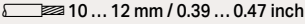
Technical Data	
0.25 ... 2.5 (4) mm <sup>2</sup> ①	22 ... 12 AWG
800 V/8 kV/3 ②	
I <sub>N</sub> 24 A (32 A)	
Terminal block width: 5.2 mm / 0.205 inch	
 10 ... 12 mm / 0.39 ... 0.47 inch	

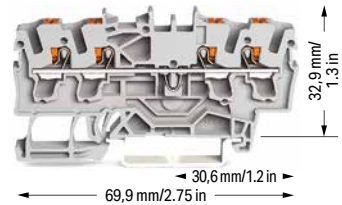
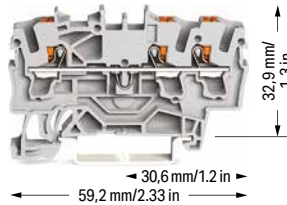
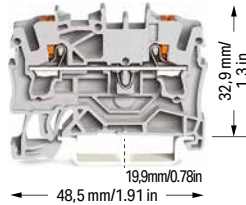

2-conductor through terminal block; with push-button		
Color	Item No.	Pack. Unit
○ gray	2202-1201	100
● blue	2202-1204 ③	100
● red	2202-1203	100
● black	2202-1205	100



3-conductor through terminal block; with push-button		
Color	Item No.	Pack. Unit
○ gray	2202-1301	100
● blue	2202-1304 ③	100



4-conductor through terminal block; with push-button		
Color	Item No.	Pack. Unit
○ gray	2202-1401	100
● blue	2202-1404 ③	100
● red	2202-1403	100
● black	2202-1405	100



2-conductor ground terminal block; with push-button		
● green-yellow	2202-1207	100



3-conductor ground terminal block; with push-button		
● green-yellow	2202-1307	100



4-conductor ground terminal block; with push-button		
● green-yellow	2202-1407	100



Accessories; item-specific			
End and intermediate plate; 0.8 mm thick			
	orange	2002-1292	100 (25)
	gray	2002-1291	100 (25)

Accessories; item-specific			
End and intermediate plate; 0.8 mm thick			
	orange	2002-1392	100 (25)
	gray	2002-1391	100 (25)

Accessories; item-specific			
End and intermediate plate; 0.8 mm thick			
	orange	2002-1492	100 (25)
	gray	2002-1491	100 (25)

Separator; oversized; 2 mm thick			
	orange	2002-1294	100 (25)
	gray	2002-1293	100 (25)









Separator; oversized; 2 mm thick			
	orange	2002-1394	100 (25)
	gray	2002-1393	100 (25)

Separator; oversized; 2 mm thick			
	orange	2002-1494	100 (25)
	gray	2002-1493	100 (25)

Accessories; 2202 Series

Appropriate marking systems: WMB/WMB Inline/Marking strips









Insulation stop; 5 pcs/strip; 0.25 ... 0.5 mm <sup>2</sup>			
	light gray	2002-171	200 (25)

Push-in type jumper bar; insulated; I <sub>N</sub> 25 A; light gray			
	1 to 3	2002-433	25
	1 to 4	2002-434	25
	1 to 5	2002-435	25
	1 to 6	2002-436	25
	1 to 7	2002-437	25
	1 to 8	2002-438	25
	1 to 9	2002-439	25
	1 to 10	2002-440	25











Adjacent jumper for continuous commoning; insulated; I <sub>N</sub> 25 A, light gray			
	5-way	2002-415	25

Insulation stop; 5 pcs/strip; 0.75 ... 1 mm <sup>2</sup>			
	dark gray	2002-172	200 (25)

Step-down jumper; insulated; commons 6/4 mm <sup>2</sup> (10/12 AWG) to 4/2.5/1.5 mm <sup>2</sup> (12/14/16 AWG); I <sub>N</sub> 32 A			
	light gray	2006-499	25



Push-in type jumper bar; insulated; I <sub>N</sub> 25 A; light gray			
	2-way	2002-402	25
	3-way	2002-403	25
	4-way	2002-404	25
	5-way	2002-405	25
	6-way	2002-406	25
	7-way	2002-407	25
	8-way	2002-408	25
	9-way	2002-409	25
	10-way	2002-410	25

Star point jumper; insulated; I <sub>N</sub> = I <sub>N</sub> terminal block; light gray			
	1-3-5	2002-405/011-000	25

Staggered jumper; insulated; I <sub>N</sub> 25 A; light gray			
	2-way	2002-472	25
	3-way	2002-473	25
	4-way	2002-474	25
	5-way	2002-475	25
	6-way	2002-476	25
	7-way	2002-477	25
	8-way	2002-478	25
	9-way	2002-479	25
	10-way	2002-480	25
	11-way	2002-481	25
	12-way	2002-482	25

Delta jumper; insulated; I <sub>N</sub> = I <sub>N</sub> terminal block; light gray			
	1-2-3-4-5-6	2002-406/020-000	25

Adjacent jumper for continuous commoning; insulated; I <sub>N</sub> 25 A, light gray			
	2-way	2002-400	25

Adjacent jumper for continuous commoning; insulated; I <sub>N</sub> 25 A; 1 to 3			
	light gray	2002-423	25
	red	2002-423/000-005	25
	blue	2002-423/000-006	25

1 Conductor range: 0.25 ... 4 mm<sup>2</sup> "s+f-st";  
Push-in termination: 1 ... 4 mm<sup>2</sup> "s" and 1 ... 2.5 mm<sup>2</sup>  
"insulated ferrules, 12 mm"  
Depending on the conductor characteristic, a conductor with a smaller cross section can also be inserted via push-in termination.

2 800 V = rated voltage  
8 kV = rated impulse voltage  
3 = pollution degree

3 Terminal blocks with a blue insulated housing are suitable for Ex i applications.

Please observe the application notes:

Jumpers, from page 160  
Testing accessories, from page 154  
Marking, from page 246

Approvals and corresponding ratings,  
visit [www.wago.com](http://www.wago.com)



Step-down jumper (2006-499) commons 6/4 mm<sup>2</sup> (10/12 AWG) terminal blocks (2206/2204 Series) with 4/2.5/1.5 mm<sup>2</sup> (AWG 12/14/16) terminal blocks (2204/2202/2201 Series).

#### Accessories; 2202 Series

Appropriate marking systems:  
WMB/WMB Inline/Marking strips

Customized staggered jumper; insulated; with contact lugs broken off at the factory and circuit printing; I<sub>N</sub> 25 A; light gray



1-3	2002-473/011-000	25
1-3-5	2002-475/011-000	25
1-3-5-7	2002-477/011-000	25
1-3-5-7-9	2002-479/011-000	25
1-3-5-7-9-11	2002-481/011-000	25

Push-in type wire jumper; insulated; 1.5 mm<sup>2</sup> conductor cross-section; I<sub>N</sub> 18 A



L = 60 mm	2009-412	100 (10)
L = 110 mm	2009-414	100 (10)
L = 250 mm	2009-416	100 (10)

Modular connector; snaps together; for jumper contact slot



gray	2002-511	100 (25)
------	----------	----------

Spacer module; snaps together; bridges commoned terminal blocks



gray	2002-549	100 (25)
------	----------	----------

End plate; for modular connector; 1.5 mm thick



gray	2002-541	100 (25)
------	----------	----------

WMB Inline, plain; 1,500 WMB markers (5 mm)/reel; 5 ... 5.2 mm stretchable



white	2009-115	1
-------	----------	---

Marking strip; plain; 11 mm wide; 50 m reel



white	2009-110	1
-------	----------	---

WMB marking card; white; 10 strips with 10 markers/card; 5 ... 5.2 mm stretchable



plain	793-5501	5
-------	----------	---



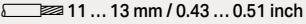

# Through Terminal Block, Ground Conductor Terminal Block TOPJOB® S; with Push-Button 4 (6) mm<sup>2</sup>; 2204 Series

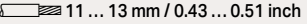

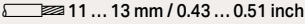
Technical Data	
0.5 ... 4 (6) mm <sup>2</sup> ①	20 ... 10 AWG
800 V/8 kV/3 ②	
I <sub>N</sub> 32 A (41 A)	
Terminal block width: 6.2 mm / 0.244 inch	
 11 ... 13 mm / 0.43 ... 0.51 inch	

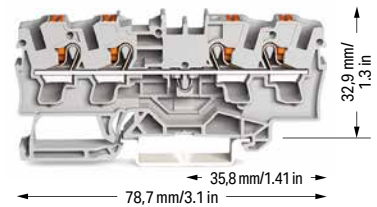
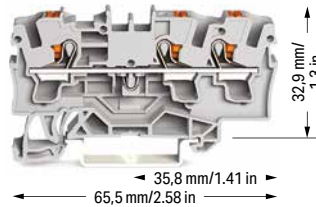
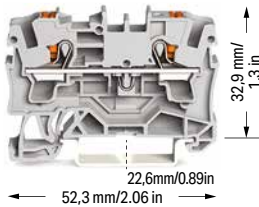

Technical Data	
0.5 ... 4 (6) mm <sup>2</sup> ①	20 ... 10 AWG
800 V/8 kV/3 ②	
I <sub>N</sub> 32 A (41 A)	
Terminal block width: 6.2 mm / 0.244 inch	
 11 ... 13 mm / 0.43 ... 0.51 inch	

Technical Data	
0.5 ... 4 (6) mm <sup>2</sup> ①	20 ... 10 AWG
800 V/8 kV/3 ②	
I <sub>N</sub> 32 A (41 A)	
Terminal block width: 6.2 mm / 0.244 inch	
 11 ... 13 mm / 0.43 ... 0.51 inch	





2-conductor through terminal block; with push-button		
Color	Item No.	Pack. Unit
 gray	2204-1201	50
 blue	2204-1204 ③	50



3-conductor through terminal block; with push-button		
Color	Item No.	Pack. Unit
 gray	2204-1301	50
 blue	2204-1304 ③	50



4-conductor through terminal block; with push-button		
Color	Item No.	Pack. Unit
 gray	2204-1401	50
 blue	2204-1404 ③	50



2-conductor ground terminal block; with push-button		
 green-yellow	2204-1207	50



3-conductor ground terminal block; with push-button		
 green-yellow	2204-1307	50



4-conductor ground terminal block; with push-button		
 green-yellow	2204-1407	50



Accessories; item-specific			
End and intermediate plate; 1 mm thick			
	orange	2004-1292	100 (25)
	gray	2004-1291	100 (25)

Accessories; item-specific			
End and intermediate plate; 1 mm thick			
	orange	2004-1392	100 (25)
	gray	2004-1391	100 (25)

Accessories; item-specific			
End and intermediate plate; 1 mm thick			
	orange	2004-1492	100 (25)
	gray	2004-1491	100 (25)

Separator; oversized; 2 mm thick			
	orange	2004-1294	100 (25)
	gray	2004-1293	100 (25)

Separator; oversized; 2 mm thick			
	orange	2004-1394	100 (25)
	gray	2004-1393	100 (25)

Separator; oversized; 2 mm thick			
	orange	2004-1494	100 (25)
	gray	2004-1493	100 (25)

**Accessories; 2204 Series**

Appropriate marking systems: WMB/WMB Inline/Marking strips

Insulation stop; 5 pcs/strip; 0.25 ... 0.5 mm <sup>2</sup>			
	light gray	2004-171	200 (25)









Star point jumper; insulated; I <sub>N</sub> = I <sub>N</sub> terminal block; light gray			
	1-3-5	2004-405/011-000	25

Test plug adapter; for 4 mm Ø test plug			
	gray	2009-174	100 (25)

Insulation stop; 5 pcs/strip; 0.75 ... 1 mm <sup>2</sup>			
	dark gray	2004-172	200 (25)









Delta jumper; insulated; I <sub>N</sub> = I <sub>N</sub> terminal block; light gray			
	1-2 3-4 5-6	2004-406/020-000	

Banana plug; for 4 mm socket diameter; color mixed; 10 x orange, white, black, blue, yellow; max. 42 V			
		215-111	50

Push-in type jumper bar; insulated; I <sub>N</sub> 32 A; light gray			
	2-way	2004-402	25
	3-way	2004-403	25
	4-way	2004-404	25
	5-way	2004-405	25
	6-way	2004-406	25
	7-way	2004-407	25
	8-way	2004-408	25
	9-way	2004-409	25
	10-way	2004-410	25

Step-down jumper; insulated; commons 6/4 mm <sup>2</sup> (10/12 AWG) to 4/2.5/1.5 mm <sup>2</sup> (12/14/16 AWG); I <sub>N</sub> 32 A			
	light gray	2006-499	25

Testing tap; for max. 2.5 mm <sup>2</sup>			
	gray	2009-182	100 (25)

Push-in type jumper bar; insulated; I <sub>N</sub> 32 A; light gray			
	1 to 3	2004-433	25
	1 to 4	2004-434	25
	1 to 5	2004-435	25
	1 to 6	2004-436	25
	1 to 7	2004-437	25
	1 to 8	2004-438	25
	1 to 9	2004-439	25
	1 to 10	2004-440	25

Modular connector; snaps together; for jumper contact slot			
	gray	2004-511	100 (25)

Marking strip; plain; 11 mm wide; 50 m reel			
	white	2009-110	1

Spacer module; snaps together; bridges commoned terminal blocks			
	gray	2004-549	100 (25)

WMB marking card; white; 10 strips with 10 markers/card; 5 ... 5.2 mm stretchable			
	plain	793-5501	5

End plate; for modular connector; 1.5 mm thick			
	gray	2004-541	100 (25)

Group marker carrier; snap-on type for jumper slot; 5 mm wide			
	gray	2009-191	50 (25)

① Conductor range: 0.5 ... 6 mm<sup>2</sup> "s+f-st";  
Push-in termination: 1.5 ... 6 mm<sup>2</sup> "s" and 1.5 ... 4 mm<sup>2</sup>  
"insulated ferrules; 12 mm"  
Depending on the conductor characteristic, a conductor with a smaller cross section can also be inserted via push-in termination.

② 800 V = rated voltage  
8 kV = rated impulse voltage  
3 = pollution degree

③ Terminal blocks with a blue insulated housing are suitable for Ex i applications.

Please observe the application notes:  
Jumpers, from page 163  
Testing accessories, from page 156  
Marking, from page 246

Approvals and corresponding ratings,  
visit [www.wago.com](http://www.wago.com)



Step-down jumper (2006-499) commons 6/4 mm<sup>2</sup>  
(10/12 AWG) terminal blocks (2206/2204 Series) with  
4/2.5/1.5 mm<sup>2</sup> (AWG 12/14/16) terminal blocks  
(2204/2202/2201 Series).

# Through Terminal Block, Ground Conductor Terminal Block TOPJOB® S; with Push-Button 6 (10) mm<sup>2</sup>; 2206 Series

Technical Data	
0.5 ... 6 (10) mm <sup>2</sup> ①	20 ... 8 AWG
800 V/8 kV/3 ②	
I <sub>N</sub> 41 A (57 A)	
Terminal block width: 7.5 mm / 0.295 inch	
 13 ... 15 mm / 0.51 ... 0.59 inch	

Technical Data	
0.5 ... 6 (10) mm <sup>2</sup> ①	20 ... 8 AWG
800 V/8 kV/3 ②	
I <sub>N</sub> 41 A (57 A)	
Terminal block width: 7.5 mm / 0.295 inch	
 13 ... 15 mm / 0.51 ... 0.59 inch	

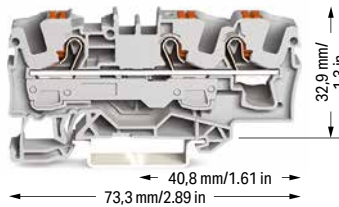



① Conductor range: 0.5 ... 10 mm<sup>2</sup> "s+f-st"; Push-in termination: 2.5 ... 10 mm<sup>2</sup> "s" and 2.5 ... 6 mm<sup>2</sup> "insulated ferrules; 12 mm" Depending on the conductor characteristic, a conductor with a smaller cross section can also be inserted via push-in termination.



② 800 V = rated voltage  
8 kV = rated impulse voltage  
3 = pollution degree

③ Terminal blocks with a blue insulated housing are suitable for Ex i applications.

Please observe the application notes:  
Jumpers, from page 163  
Testing accessories, from page 156  
Marking, from page 246



Approvals and corresponding ratings, visit [www.wago.com](http://www.wago.com)



2-conductor through terminal block; with push-button		
Color	Item No.	Pack. Unit
 gray	2206-1201	50
 blue	2206-1204 ③	50



3-conductor through terminal block; with push-button		
Color	Item No.	Pack. Unit
 gray	2206-1301	25
 blue	2206-1304 ③	25



2-conductor ground terminal block; with push-button		
 green-yellow	2206-1207	50

3-conductor ground terminal block; with push-button		
 green-yellow	2206-1307	25

Accessories; item-specific			
End and intermediate plate; 1 mm thick			
	orange	2006-1292	100 (25)
	gray	2006-1291	100 (25)

Accessories; item-specific			
End and intermediate plate; 1 mm thick			
	orange	2006-1392	100 (25)
	gray	2006-1391	100 (25)



Separator; oversized; 2 mm thick			
	orange	2006-1294	100 (25)
	gray	2006-1293	100 (25)

Separator; oversized; 2 mm thick			
	orange	2006-1394	100 (25)
	gray	2006-1393	100 (25)

Accessories; 2206 Series  
Appropriate marking systems: WMB/WMB Inline/Marking strips

Push-in type jumper bar; insulated; I <sub>N</sub> 41 A; light gray			
	2-way	2006-402	25
	3-way	2006-403	25
	4-way	2006-404	25
	5-way	2006-405	25

Modular connector; snaps together; for jumper contact slot			
	gray	2006-511	50 (25)

Push-in type jumper bar; insulated; I <sub>N</sub> 41 A; light gray			
	1 to 3	2006-433	25
	1 to 4	2006-434	25
	1 to 5	2006-435	25

Test plug adapter; for 4 mm Ø test plug			
	gray	2009-174	100 (25)

Star point jumper; insulated; I <sub>N</sub> = I <sub>N</sub> terminal block; light gray			
	1-3-5	2006-405/011-000	25

Marking strip; plain; 11 mm wide; 50 m reel			
	white	2009-110	1

Step-down jumper; insulated; commons 6/4 mm <sup>2</sup> (10/12 AWG) to 4/2.5/1.5 mm <sup>2</sup> (12/14/16 AWG); I <sub>N</sub> 32 A; light gray			
	light gray	2006-499	25

WMB marking card; white; 10 strips with 10 markers/card; 5 ... 5.2 mm stretchable			
	plain	793-5501	5



Step-down jumper (2006-499) commons 6/4 mm<sup>2</sup> (10/12 AWG) terminal blocks (2206/2204 Series) with 4/2.5/1.5 mm<sup>2</sup> (AWG 12/14/16) terminal blocks (2204/2202/2201 Series).

## Through Terminal Block, Ground Conductor Terminal Block TOPJOB® S; with Push-Button 10 (16) mm<sup>2</sup>; 2210 Series

### Technical Data

0,5 ... 10 (16) mm<sup>2</sup> ① | 20 ... 6 AWG

800 V/8 kV/3 ②

I<sub>N</sub> 57 A (76 A)

Terminal block width: 10 mm / 0.394 inch

 17 ... 19 mm / 0.67 ... 0.75 inch

### Technical Data

0,5 ... 10 (16) mm<sup>2</sup> ① | 20 ... 6 AWG

800 V/8 kV/3 ②

I<sub>N</sub> 57 A (76 A)

Terminal block width: 10 mm / 0.394 inch

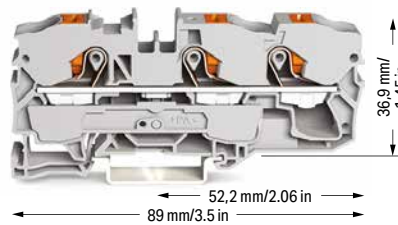
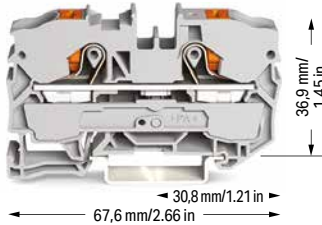
 17 ... 19 mm / 0.67 ... 0.75 inch

### 2-conductor through terminal block; with push-button

Color	Item No.	Pack. Unit
○ gray	2210-1201	25
● blue	2210-1204 ③	25

### 3-conductor through terminal block; with push-button

Color	Item No.	Pack. Unit
○ gray	2210-1301	25
● blue	2210-1304 ③	25

### 2-conductor ground terminal block; with push-button

● green-yellow	2210-1207	25
----------------	-----------	----

### 3-conductor ground terminal block; with push-button

● green-yellow	2210-1307	25
----------------	-----------	----

### Accessories; item-specific

#### End and intermediate plate; 1 mm thick

	orange	2010-1292	100 (25)
	gray	2010-1291	100 (25)

### Accessories; item-specific

#### End and intermediate plate; 1 mm thick

	orange	2010-1392	100 (25)
	gray	2010-1391	100 (25)

### Accessories; 2210 Series

Appropriate marking systems: WMB/WMB Inline/Marking strips

### Push-in type jumper bar; insulated; I<sub>N</sub> 57 A; light gray

	2-way	2010-402	25
	3-way	2010-403	25
	4-way	2010-404	25
	5-way	2010-405	25

### Push-in type jumper bar; insulated; I<sub>N</sub> 57 A; light gray

	1 to 3	2010-433	25
	1 to 4	2010-434	25
	1 to 5	2010-435	25

### Star point jumper; insulated; I<sub>N</sub> = I<sub>N</sub> terminal block; light gray

	1-3-5	2010-405/011-000	25
---	-------	------------------	----

### light gray

	light gray	2016-499	25
---	------------	----------	----

### Finger guard; touch-proof cover protects unused conductor entries

	yellow	2010-100	100 (25)
---	--------	----------	----------

### Modular connector; snaps together; for jumper contact slot

	gray	2010-511	50 (25)
---	------	----------	---------

### Test plug adapter; for 4 mm Ø test plug

	gray	2009-174	100 (25)
---	------	----------	----------

### Marking strip; plain; 11 mm wide; 50 m reel

	white	2009-110	1
---	-------	----------	---

### WMB marking card; white; 10 strips with 10 markers/card; 5 ... 5.2 mm stretchable

	plain	793-5501	5
---	-------	----------	---

① Conductor range: 0.5 ... 16 mm<sup>2</sup> "s+f-st";  
Push-in termination: 4 ... 16 mm<sup>2</sup> "s" and 4 ... 10 mm<sup>2</sup>  
"insulated ferrules; 18 mm"  
Depending on the conductor characteristic, a conductor with a smaller cross section can also be inserted via push-in termination.

② 800 V = rated voltage  
8 kV = rated impulse voltage  
3 = pollution degree

③ Terminal blocks with a blue insulated housing are suitable for Ex i applications.

Please observe the application notes:  
Jumpers, from page 163  
Testing accessories, from page 156  
Marking, from page 246

Approvals and corresponding ratings,  
visit [www.wago.com](http://www.wago.com)

## Through Terminal Block, Ground Conductor Terminal Block TOPJOB® S; with Push-Button 16 (25 "f-st") mm<sup>2</sup>; 2216 Series

### Technical Data

0.5 ... 16 (25 "f-st") mm<sup>2</sup> ① | 20 ... 4 AWG

800 V/8 kV/3 ②

I<sub>N</sub> 76 A (90 A)

Terminal block width: 12 mm / 0.472 inch

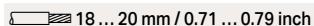
 18 ... 20 mm / 0.71 ... 0.79 inch

### Technical Data

0.5 ... 16 (25 "f-st") mm<sup>2</sup> ① | 20 ... 4 AWG

800 V/8 kV/3 ②

I<sub>N</sub> 76 A (90 A)

Terminal block width: 12 mm / 0.472 inch

 18 ... 20 mm / 0.71 ... 0.79 inch

### 2-conductor through terminal block; with push-button

Color	Item No.	Pack. Unit
gray	2216-1201	20
blue	2216-1204 ③	20

### 3-conductor through terminal block; with push-button

Color	Item No.	Pack. Unit
gray	2216-1301	20
blue	2216-1304 ③	20

2-conductor ground terminal block; with push-button  
15 mm high DIN-35 rails shall be used for a current load higher than 76 A!

green-yellow	2216-1207	50
--------------	-----------	----

3-conductor ground terminal block; with push-button  
15 mm high DIN-35 rails shall be used for a current load higher than 76 A!

green-yellow	2216-1307	20
--------------	-----------	----

### Accessories; item-specific

End and intermediate plate; 1 mm thick

 orange	2016-1292	100 (25)
 gray	2016-1291	100 (25)

### Accessories; item-specific

End and intermediate plate; 1 mm thick

 orange	2016-1392	100 (25)
 gray	2016-1391	100 (25)

### Accessories; 2216 Series

Appropriate marking systems: WMB/WMB Inline/Marking strips

### Push-in type jumper bar; insulated; I<sub>N</sub> 76 A; light gray

 2-way	2016-402	25
 3-way	2016-403	25
 4-way	2016-404	25
 5-way	2016-405	25

### Push-in type jumper bar; insulated; I<sub>N</sub> 76 A; light gray

 1 to 3	2016-433	25
 1 to 4	2016-434	25
 1 to 5	2016-435	25

### Star point jumper; insulated; I<sub>N</sub> = I<sub>N</sub> terminal block; light gray

 1-3-5	2016-405/011-000	25
--	------------------	----

 light gray	2016-499	25
---	----------	----

### Finger guard; touch-proof cover protects unused conductor entries

 yellow	2016-100	100 (25)
--	----------	----------

### Modular connector; snaps together; for jumper contact slot

 gray	2016-511	50 (25)
--	----------	---------

### Test plug adapter; for 4 mm Ø test plug

 gray	2009-174	100 (25)
--	----------	----------

### Marking strip; plain; 11 mm wide; 50 m reel

 white	2009-110	1
---	----------	---

### WMB marking card; white; 10 strips with 10 markers/card; 5 ... 5.2 mm stretchable

 plain	793-5501	5
---	----------	---

① Conductor range: 0.5 ... 16 mm<sup>2</sup> "s+f-st", 25 mm<sup>2</sup> "f-st";  
Push-in termination: 6 ... 16 mm<sup>2</sup> "s" and 6 ... 16 mm<sup>2</sup>  
"insulated ferrules; 18 mm"  
Depending on the conductor characteristic, a conductor  
with a smaller cross section can also be inserted  
via push-in termination.

② 800 V = rated voltage  
8 kV = rated impulse voltage  
3 = pollution degree

③ Terminal blocks with a blue insulated housing are  
suitable for Ex i applications.

Please observe the application notes:

Jumpers, from page 163

Testing accessories, from page 157

Marking, from page 246

Approvals and corresponding ratings,  
visit [www.wago.com](http://www.wago.com)





# THROUGH TERMINAL BLOCKS

## Single-Deck – Double-Deck – Triple-Deck

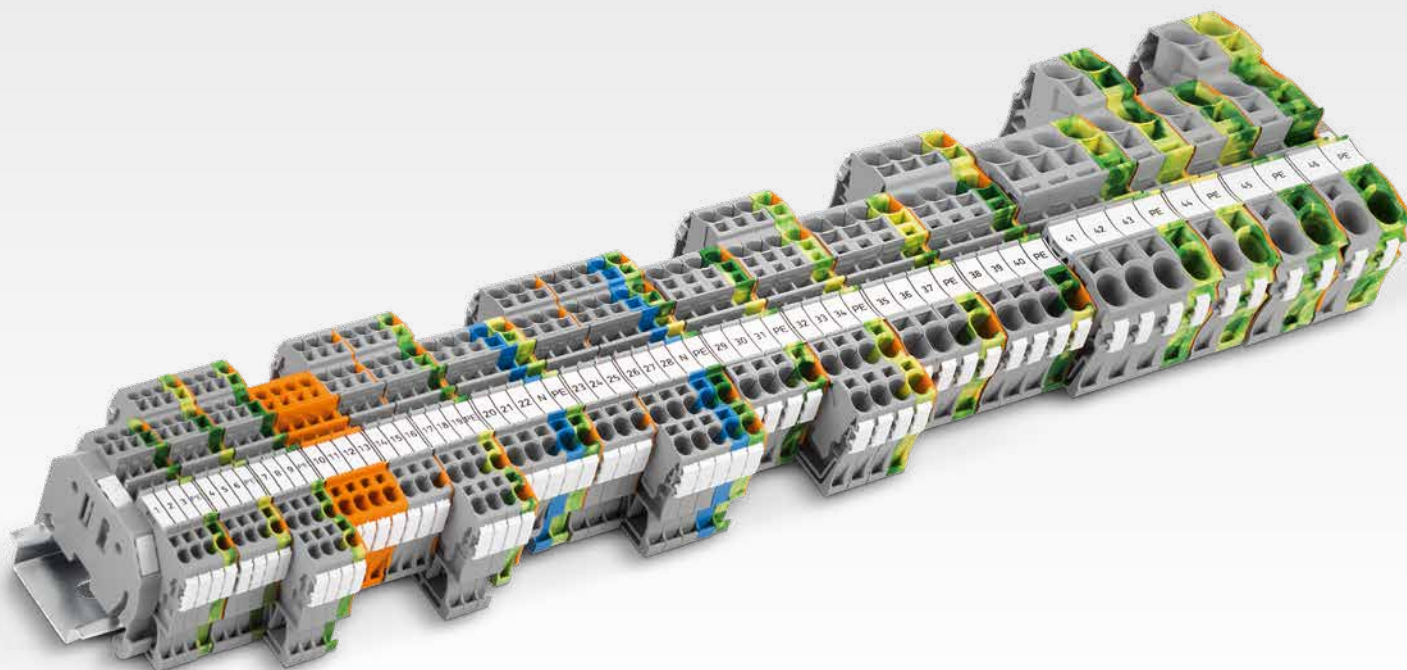

### Single-Deck Terminal Blocks

- Terminate conductors ranging from 0.14 to 25 mm<sup>2</sup> (24–4 AWG)
- Provide simple, push-in termination of solid, stranded and ferruled conductors
- Feature centered dual jumper slots that accommodate WAGO's extensive line of jumpers
- Benefit from clear and continuous labeling via a centered marking slot
- Cost-effective use of both marking strips and WMB markers on all Through Terminal Blocks TOPJOB® S

Sold & Serviced By:

 **ELECTROMATE**

Toll Free Phone (877) SERV098

[www.electromate.com](http://www.electromate.com)

[sales@electromate.com](mailto:sales@electromate.com)



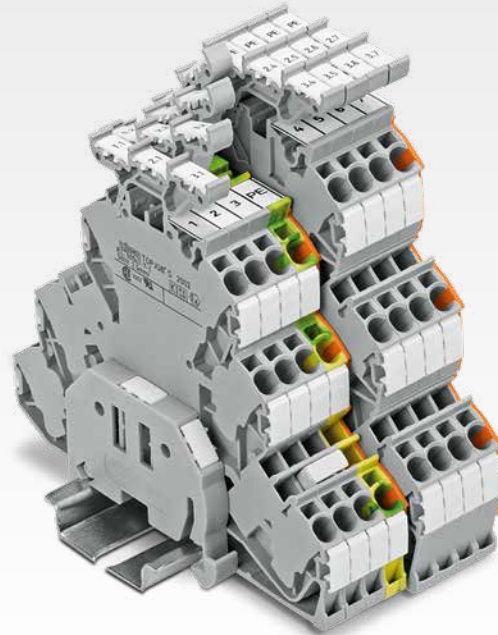
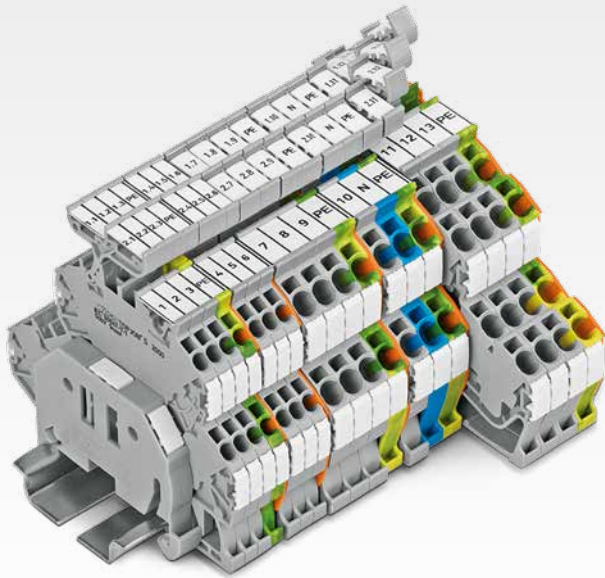

## Double-Deck Terminal Blocks

- Save space
- Just 3.5 mm wide to maximize space
- Rated for 800 V nominal voltage
- Pivoting marker carrier clearly identifies each clamping unit – even in the tightest areas
- Both decks can be commoned after wiring via pluggable vertical jumper

## Triple-Deck Terminal Blocks

- Three different potentials in a width of just 5.2 mm (0.205 inch)
- Pivoting marker carrier clearly identifies each connection point in space-restricted conditions
- Both decks can be commoned after wiring via pluggable vertical jumper
- Wire an electric motor with four potentials, including a ground conductor, with just a 5.2 mm rail-mount terminal block for electric motor wiring

# RANGE OF JUMPERS

## For Every Commoning Task

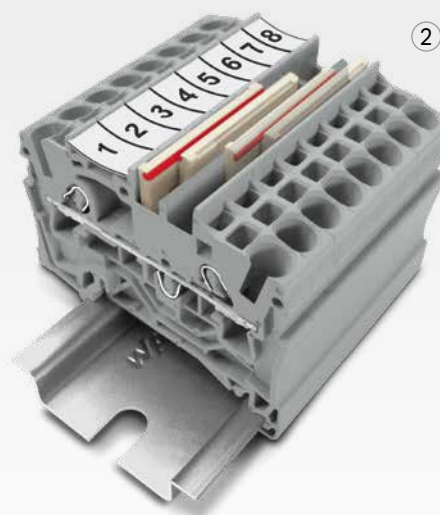
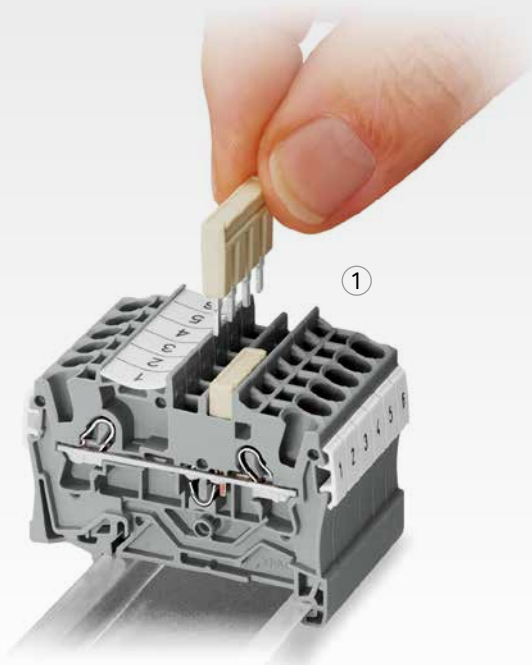

### ① Push-In Type Jumper Bars

- Simply insert push-in type jumper bars into one of the center jumper slots.
- Insert the operating tool between the jumper and partition wall of the dual jumper slots, then lift up the jumper.
- Place the operating tool in the center of jumpers for up to five contacts, or alternately on both sides for jumpers with more than five contacts.



### ② Staggered Jumpers

- Staggered jumpers allow 2002 and 2003 Series terminal blocks to accommodate two potentials in a single jumper slot alongside each other.
- Dual jumper slots allow four different potentials to be accommodated along side each other.
- Make sure that only one contact lug is inserted per contact.
- Insert the staggered jumpers so that the red lines of both jumpers are facing each other.



Standard jumpers offered by WAGO

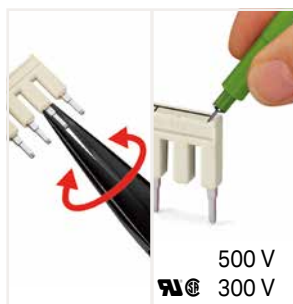

Custom push-in type jumper bars are created by breaking and removing jumper contacts (2000, 2001, 2002, 2004 Series).



Custom staggered jumpers are created by breaking off jumper contacts.

#### Note

Please note that:  
The total current of the outgoing circuits must not exceed the nominal current of the step-down jumper/push-in type jumper bar.

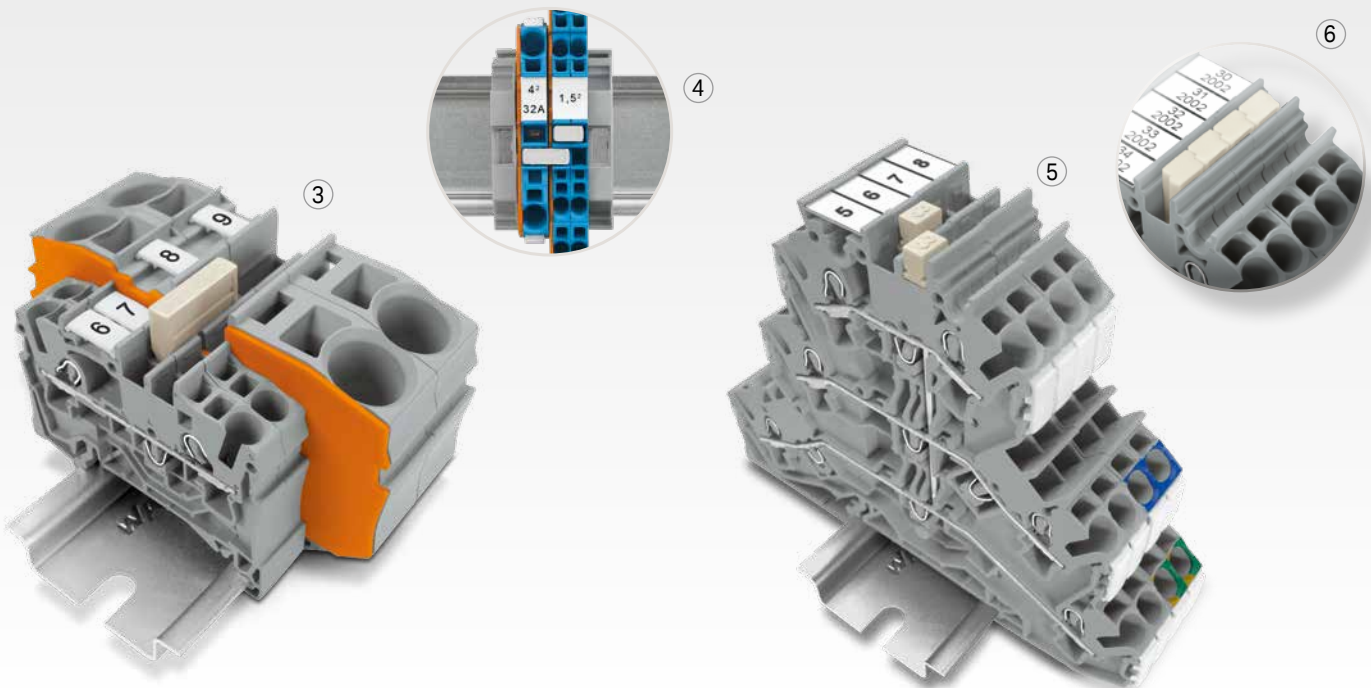

### ③ Commoning with Step-Down Jumpers

- 2016-499 Step-Down Jumpers common 16/10 mm<sup>2</sup> (16/8 AWG) terminal blocks (2016/2010 Series) with 10/6/4/2.5 mm<sup>2</sup> (8/10/12/14 AWG) terminal blocks (2010/2006/2004/2002 Series).
- 2006-499 Step-Down Jumpers common 6/4 mm<sup>2</sup> (10/12 AWG) terminal blocks (2006/2004 Series) with 4/2.5/1.5 mm<sup>2</sup> (AWG 12/14/16) terminal blocks (2004/2002/2001 Series).
- An end plate must be inserted between the terminal blocks to be commoned.

### ④ Commoning with Push-In Type Jumper Bars

- Commoning via open terminal side with end plate allows jumpering over two cross-section sizes for 16 mm<sup>2</sup>/6 AWG (2016 Series) and 10 mm<sup>2</sup>/8 AWG (2010 Series), e.g., from 16 mm<sup>2</sup>/6 AWG (2016 Series) to 6 mm<sup>2</sup>/10 AWG (2006 Series) or from 10 mm<sup>2</sup>/8 AWG (2010 Series) to 4 mm<sup>2</sup>/12 AWG (2004 Series).
- One cross-section size can be jumpered over when commoning 6 mm<sup>2</sup>/4 mm<sup>2</sup>/2.5 mm<sup>2</sup> (10/12/14 AWG) terminal blocks (2006/2004/2002 Series): from 6 mm<sup>2</sup>/10 AWG (2006 Series) to 4 mm<sup>2</sup>/12 AWG (2004 Series)
- Commoning via closed terminal side with end plate allows jumpering over two cross-section sizes, e.g., from 16 mm<sup>2</sup>/6 AWG (2016 Series) to 6 mm<sup>2</sup>/10 AWG (2006 Series) or from 6 mm<sup>2</sup>/10 AWG (2006 Series) to 2.5 mm<sup>2</sup>/14 AWG (2002 Series).

### ⑤ Vertical Jumpers

- Created for double- and triple-deck Terminal Blocks TOPJOB® S, the vertical jumpers can common two or three levels.

### ⑥ Adjacent Jumpers for Continuous Commoning

- Any number of 2002 Series Terminal Blocks can be commoned without a push-in type jumper bar (2- to 10-way).
- These jumpers are ideal for electric motor wiring or 4-conductor, double-deck rail-mount terminal blocks that only have one jumper slot per level. Connection is made by inserting each contact of two adjacent jumpers in a single slot.



# Rail-Mount Terminal Blocks TOPJOB® S; with Push-in CAGE CLAMP®

## 2000 to 2016 Series

### Description and Installation

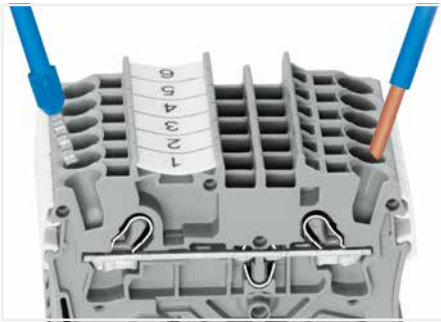

Push-in termination of solid and ferruled conductors

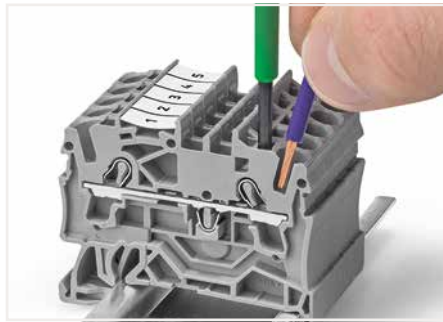

Insert fine-stranded conductors via operating tool.

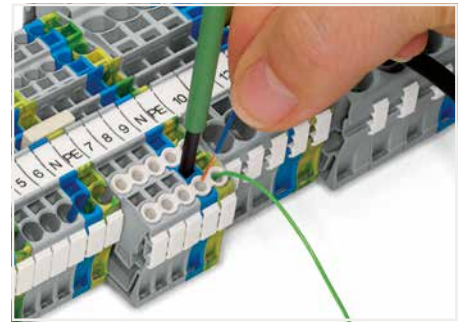

Conductor termination – insulation stop



Insert push-in type jumper bar and push down until it hits backstop.



Custom jumpers are created by breaking and removing jumper contacts (2000, 2001, 2002, 2004 Series).

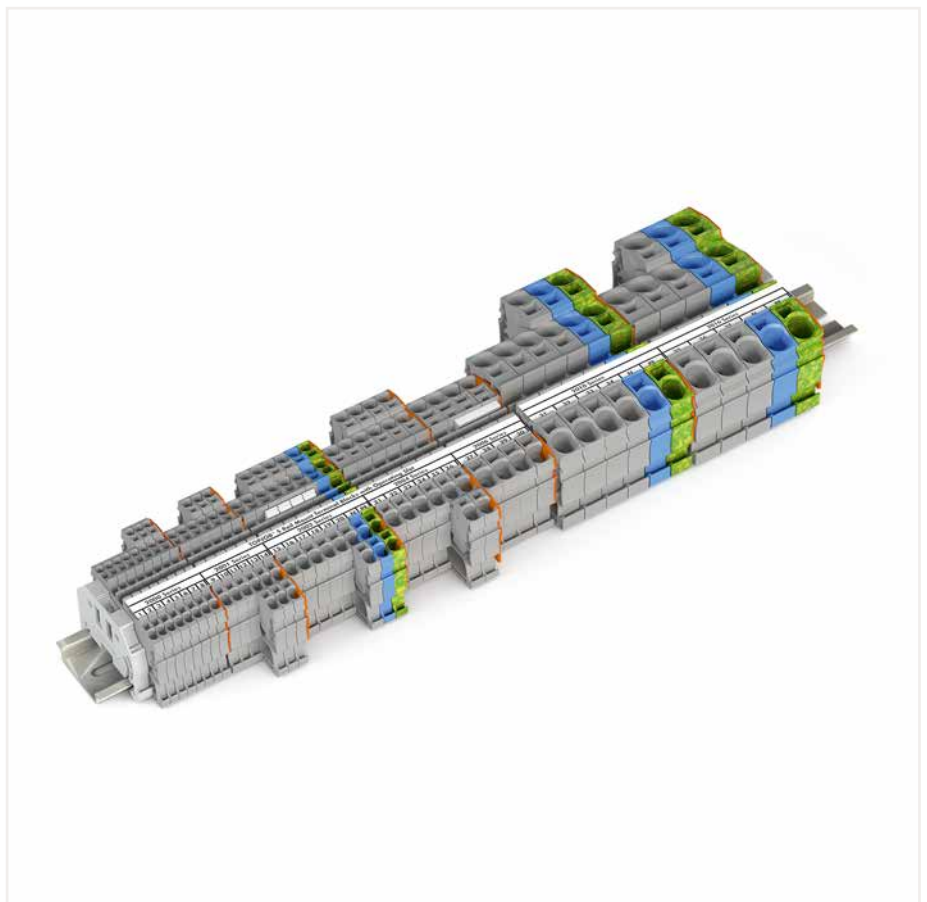

Push-in type jumper bar: Marking with a felt-tip pen.

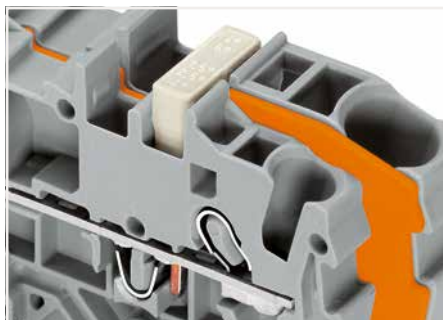

Commoning with step-down jumpers.



This star point jumper was specifically developed to create a "star point" and is used on motor terminal boards equipped with Rail-Mount Terminal Blocks TOPJOB® S.



Push-in CAGE CLAMP® terminates the following copper conductors:  
solid "s"



stranded "st"



fine-stranded "f-st", also with tinned single strands

**PUSH-IN CAGE CLAMP®**

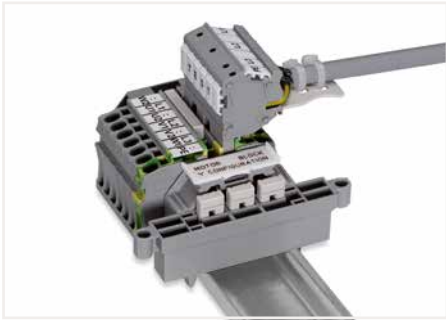

Rail-mount terminal block assembly for electric motor wiring



L-type test plug modules fitted in a triple-deck terminal block



Testing tap (2009-182) for tool-free connection of test cables up to 2.5 mm<sup>2</sup> (12 AWG) – compatible with 2000 to 2016 Series

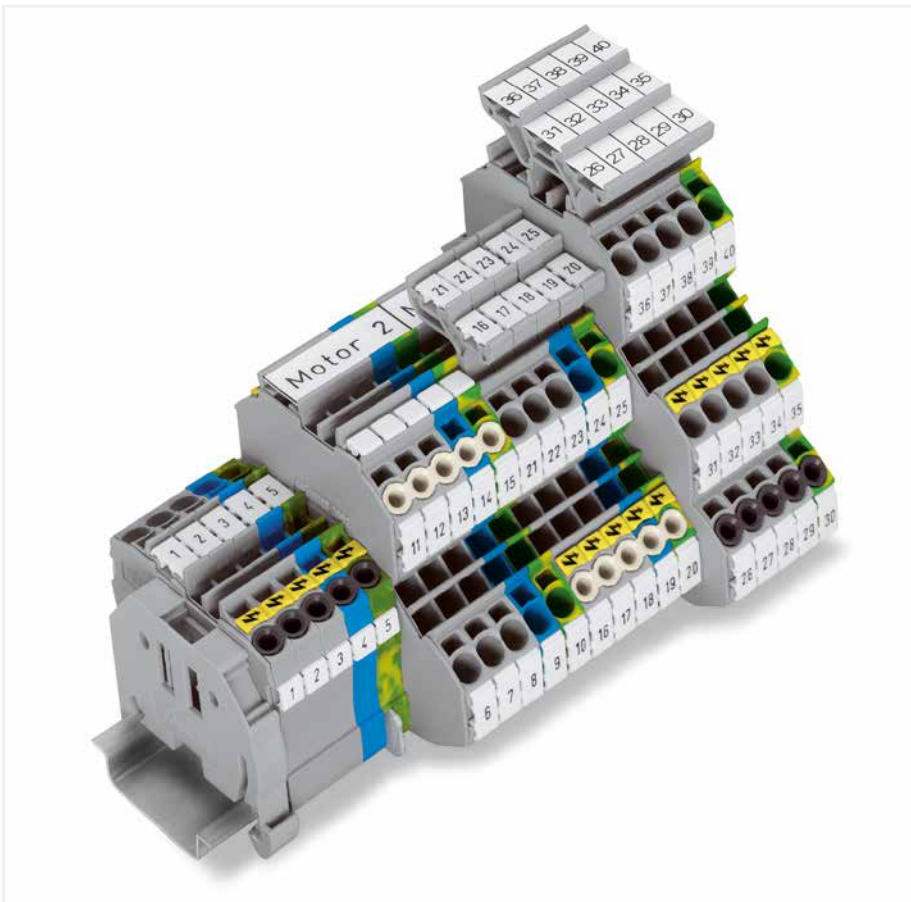

Test plug adapter (2009-174, CAT I) for 4 mm Ø plugs – compatible with 2000 to 2016 Series



Group marker carrier (2009-163) for marking strips (2009-110)

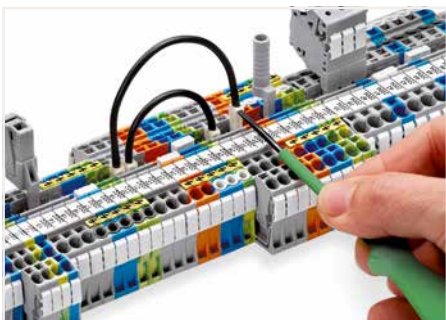

Push down the wire jumper until fully inserted. Lift the jumper with an operating tool for rewiring.

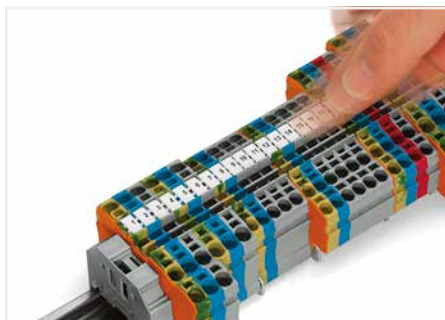

Snapping a marking strip into the marker slot.

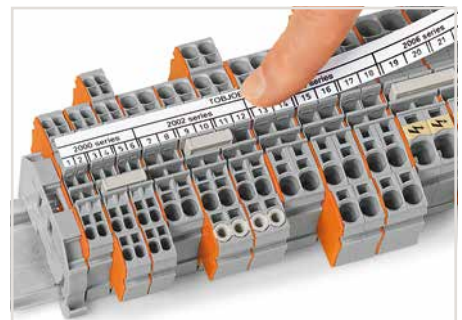

Snapping a marking strip into the marker slot.



fine-stranded, tip-bonded



fine-stranded, with ferrule (gastight crimped)



fine-stranded, with pin terminal (gastight crimped)

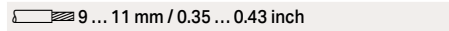

# Through Terminal Block, Ground Conductor Terminal Block, Double-Potential Terminal Block TOPJOB® S 1 (1.5) mm<sup>2</sup>; 2000 Series

Technical Data	
0.14 ... 1 (1.5) mm <sup>2</sup> ①	24 ... 16 AWG
800 V/8 kV/3 ②	600 V, 10 A ③
I <sub>N</sub> 13.5 A (17.5 A)	600 V, 10 A ④
Terminal block width: 3.5 mm / 0.138 inch	
 9 ... 11 mm / 0.35 ... 0.43 inch	

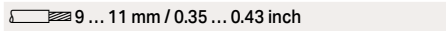
Technical Data	
0.14 ... 1 (1.5) mm <sup>2</sup> ①	24 ... 16 AWG
800 V/8 kV/3 ②	600 V, 10 A ③
I <sub>N</sub> 13.5 A (17.5 A)	600 V, 10 A ④
Terminal block width: 3.5 mm / 0.138 inch	
 9 ... 11 mm / 0.35 ... 0.43 inch	

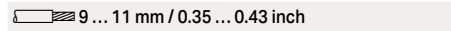
Technical Data	
0.14 ... 1 (1.5) mm <sup>2</sup> ①	24 ... 16 AWG
800 V/8 kV/3 ②	600 V, 10 A ③
I <sub>N</sub> 13.5 A (17.5 A)	600 V, 10 A ④
Terminal block width: 3.5 mm / 0.138 inch	
 9 ... 11 mm / 0.35 ... 0.43 inch	

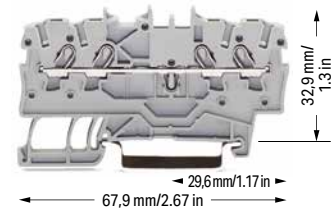
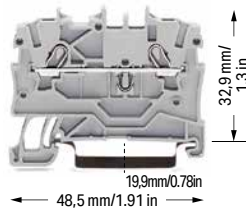

### 2-conductor through terminal block

Color	Item No.	Pack. Unit
gray ⑤	2000-1201 ④	100
blue ⑤	2000-1204 ③ ④	100
orange ⑤	2000-1202 ④	100
red ⑤	2000-1203 ④	100
black ⑤	2000-1205 ④	100
yellow ⑤	2000-1206 ④	100

### 3-conductor through terminal block

Color	Item No.	Pack. Unit
gray ⑤	2000-1301 ④	100
blue ⑤	2000-1304 ③ ④	100
orange ⑤	2000-1302 ④	100
red ⑤	2000-1303 ④	100
black ⑤	2000-1305 ④	100
yellow ⑤	2000-1306 ④	100

### 4-conductor through terminal block

Color	Item No.	Pack. Unit
gray ⑤	2000-1401 ④	100
blue ⑤	2000-1404 ③ ④	100
orange ⑤	2000-1402 ④	100
red ⑤	2000-1403 ④	100
black ⑤	2000-1405 ④	100
yellow ⑤	2000-1406 ④	100

### 2-conductor ground terminal block

green-yellow ⑤	2000-1207 ④	100
----------------	-------------	-----

### 3-conductor ground terminal block

green-yellow ⑤	2000-1307 ④	100
----------------	-------------	-----

### 4-conductor ground terminal block

green-yellow ⑤	2000-1407 ④	100
----------------	-------------	-----

### Accessories; item-specific

#### End and intermediate plate; 0.7 mm thick

orange	2000-1292	100 (25)
gray	2000-1291	100 (25)

### Accessories; item-specific

#### End and intermediate plate; 0.7 mm thick

orange	2000-1392	100 (25)
gray	2000-1391	100 (25)

### Accessories; item-specific

#### End and intermediate plate; 0.7 mm thick

orange	2000-1492	100 (25)
gray	2000-1491	100 (25)

### Ex e/Ex i separator; orange; 3 mm thick

90 mm	209-190	50 (25)
120 mm	209-191	50 (25)

### Ex e/Ex i separator; orange; 3 mm thick

120 mm	209-191	50 (25)
--------	---------	---------

### Ex e/Ex i separator; orange; 3 mm thick

120 mm	209-191	50 (25)
--------	---------	---------

### Accessories; 2000 Series

Appropriate marking systems: WMB/WMB Inline/Marking strips

### Push-in type jumper bar; insulated; I<sub>N</sub> 14 A; light gray

2-way	2000-402	25
3-way	2000-403	25
4-way	2000-404	25
5-way	2000-405	25
6-way	2000-406	25
7-way	2000-407	25
8-way	2000-408	25
9-way	2000-409	25
10-way	2000-410	25

### Delta jumper; insulated; I<sub>N</sub> = I<sub>N</sub> terminal block; light gray

1-2 3-4 5-6	2000-406/020-000	25
-------------	------------------	----

### Spacer module; snaps together; bridges commoned terminal blocks

gray	2000-549	100 (25)
------	----------	----------

### Push-in type jumper bar; insulated; I<sub>N</sub> 14 A; light gray

1 to 3	2000-433	25
1 to 4	2000-434	25
1 to 5	2000-435	25
1 to 6	2000-436	25
1 to 7	2000-437	25
1 to 8	2000-438	25
1 to 9	2000-439	25
1 to 10	2000-440	25

### Star point jumper; insulated; I<sub>N</sub> = I<sub>N</sub> terminal block; light gray

1-3-5	2000-405/011-000	25
-------	------------------	----

### End plate; for modular connector; 1.5 mm thick

gray	2002-541	100 (25)
------	----------	----------

### Push-in type wire jumper; insulated; 0.75 mm<sup>2</sup> conductor cross-section; I<sub>N</sub> 9 A

L = 60 mm	2009-402	100 (10)
L = 110 mm	2009-404	100 (10)
L = 250 mm	2009-406	100 (10)

### Test plug adapter; for 4 mm Ø test plug

gray	2009-174	100 (25)
------	----------	----------

### Modular connector; snaps together; for jumper contact slot

Terminal block width: 5 mm / 0.197 inch	gray	2000-511	100 (25)
---	------	----------	----------

### Banana plug; for 4 mm socket diameter; color mixed; 10 x orange, white, black, blue, yellow; max. 42 V

	215-111	50
--	---------	----

### Protective warning marker; with black high-voltage symbol; for 5 terminal blocks

yellow	2000-115	100 (25)
--------	----------	----------

### Modular connector; snaps together; for jumper contact slot

gray	2000-510	100 (25)
------	----------	----------

### Testing tap; for max. 2.5 mm<sup>2</sup>

gray	2009-182	100 (25)
------	----------	----------

**Technical Data**

0.14 ... 1 (1.5) mm <sup>2</sup> ①	24 ... 16 AWG
800 V/8 kV/3 ②	600 V, 10 A ③
I <sub>N</sub> 13.5 A (17.5 A)	600 V, 10 A ④
Terminal block width: 3.5 mm / 0.138 inch	
9 ... 11 mm / 0.35 ... 0.43 inch	

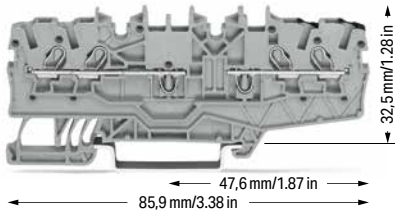

Double-potential terminal block; both potentials can be commoned

Color	Item No.	Pack. Unit
○ gray ⑤	2000-2141 ⑥	50

- Conductor range: 0.14 ... 1.5 mm<sup>2</sup> "s+f-st"; Push-in termination: 0.5 ... 1.5 mm<sup>2</sup> "s" and 0.5 ... 0.75 mm<sup>2</sup> "insulated ferrules; 10 mm" Depending on the conductor characteristic, a conductor with a smaller cross section can also be inserted via push-in termination.
- 800 V = rated voltage  
8 kV = rated impulse voltage  
3 = pollution degree
- Terminal blocks with a blue insulated housing are suitable for Ex i applications.
- Terminal blocks with an Ex mark are suitable for Ex e II applications.  
550 V; 13 A  
12 A jumper

Please observe the application notes:  
Separator for Ex e/Ex i applications, see page 43  
Jumpers, from page 160  
Testing accessories, from page 154  
Marking, from page 246

Approvals and corresponding ratings, visit [www.wago.com](http://www.wago.com)

**Accessories; item-specific**

**End and intermediate plate; 0.7 mm thick**

orange	2000-2196	100 (25)
gray	2000-2195	100 (25)

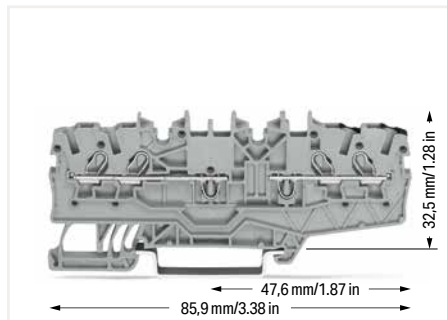

Front-entry double-potential terminal blocks are space savers. Two independent feedthrough circuits are placed in one insulated housing on one level in just 3.5 mm. This achieves a width of just 1.75 mm versus standard through terminal blocks. Input and output of a circuit are placed on the same side of the terminal block. Both circuits can be individually marked according to input and output.



**Standard and quick marking options:**  
Three marker slots are available for both individual markers and marking strips.

**Test plug; with 500 mm cable; 2 mm Ø; max. 42 V**

red	210-136	50 (1)
-----	---------	--------



**Test plug; with 500 mm cable; 2.3 mm Ø; max. 42 V**

yellow	210-137	50 (1)
--------	---------	--------



**WMB Inline; plain; 2,300 WMB markers (3.5 mm)/reel**

white	2009-113	1
-------	----------	---



**Marking strip; plain; 11 mm wide; 50 m reel**

white	2009-110	1
-------	----------	---



**WMB marking card; white; 10 strips with 10 markers/card; for 3.5 mm terminal block width**

plain	793-3501	5
-------	----------	---



2009-193 Group Marker Carrier (equipped with marking strips) for all 2001 to 2016 Series Rail-Mount Terminal Blocks TOPJOB® S  
Do not use on an end plate!

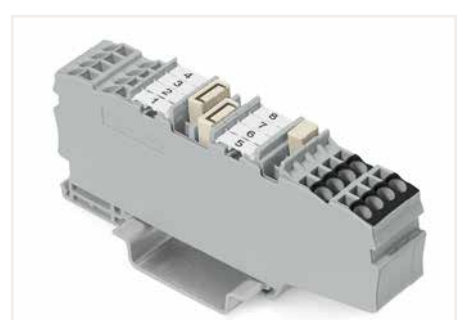



**Standard and quick marking options:**  
Four marker slots (double-potential terminal blocks) are available for both individual markers and marking strips.

# Through Terminal Block, Ground Conductor Terminal Block, Shield Conductor Terminal Block, Double-Potential Terminal Block TOPJOB® S

## 1.5 (2.5) mm<sup>2</sup>; 2001 Series

Technical Data	
0.25 ... 1.5 (2.5) mm <sup>2</sup> ①	22 ... 14 AWG
800 V/8 kV/3 ②	600 V, 15 A ③
I <sub>N</sub> 18 A (24 A)	600 V, 15 A ④
Terminal block width: 4.2 mm / 0.165 inch	
 9 ... 11 mm / 0.35 ... 0.43 inch	

Technical Data	
0.25 ... 1.5 (2.5) mm <sup>2</sup> ①	22 ... 14 AWG
800 V/8 kV/3 ②	600 V, 15 A ③
I <sub>N</sub> 18 A (24 A)	600 V, 15 A ④
Terminal block width: 4.2 mm / 0.165 inch	
 9 ... 11 mm / 0.35 ... 0.43 inch	

Technical Data	
0.25 ... 1.5 (2.5) mm <sup>2</sup> ①	22 ... 14 AWG
800 V/8 kV/3 ②	600 V, 15 A ③
I <sub>N</sub> 18 A (24 A)	600 V, 15 A ④
Terminal block width: 4.2 mm / 0.165 inch	
 9 ... 11 mm / 0.35 ... 0.43 inch	

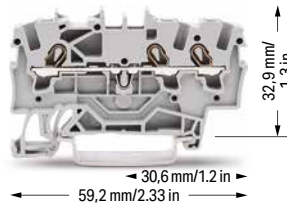
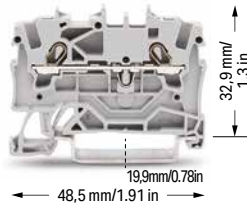

### 2-conductor through terminal block

Color	Item No.	Pack. Unit
gray ⑤	2001-1201 ④	100
blue ⑤	2001-1204 ③ ④	100
orange ⑤	2001-1202 ④	100
red ⑤	2001-1203 ④	100
black ⑤	2001-1205 ④	100
yellow ⑤	2001-1206 ④	100

### 3-conductor through terminal block

Color	Item No.	Pack. Unit
gray ⑤	2001-1301 ④	100
blue ⑤	2001-1304 ③ ④	100
orange ⑤	2001-1302 ④	100
red ⑤	2001-1303 ④	100
black ⑤	2001-1305 ④	100
yellow ⑤	2001-1306 ④	100

### 4-conductor through terminal block

Color	Item No.	Pack. Unit
gray ⑤	2001-1401 ④	100
blue ⑤	2001-1404 ③ ④	100
orange ⑤	2001-1402 ④	100
red ⑤	2001-1403 ④	100
black ⑤	2001-1405 ④	100
yellow ⑤	2001-1406 ④	100

### 2-conductor ground terminal block

green-yellow ⑤	2001-1207 ④	100
----------------	-------------	-----

### 3-conductor ground terminal block

green-yellow ⑤	2001-1307 ④	100
----------------	-------------	-----

### 4-conductor ground terminal block

green-yellow ⑤	2001-1407 ④	100
----------------	-------------	-----

### 2-conductor shield terminal block

white	2001-1208	100
-------	-----------	-----

### 3-conductor shield terminal block

white	2001-1308	100
-------	-----------	-----

### 4-conductor shield terminal block

white	2001-1408	100
-------	-----------	-----

### Other terminal blocks with the same profile:

Diode	2001-1211/1000-411	Page 130
-------	--------------------	----------

### Other terminal blocks with the same profile:

Diode	2001-1311/1000-411	Page 130
LED	2001-1321/1000-434	Page 130

### Other terminal blocks with the same profile:

Diode	2001-1411/1000-411	Page 130
LED	2001-1421/1000-434	Page 130

### Accessories; item-specific



End and intermediate plate; 0.8 mm thick			
	orange	2002-1292	100 (25)
	gray	2002-1291	100 (25)



### Accessories; item-specific



End and intermediate plate; 0.8 mm thick			
	orange	2002-1392	100 (25)
	gray	2002-1391	100 (25)



### Accessories; item-specific

End and intermediate plate; 0.8 mm thick			
	orange	2002-1492	100 (25)
	gray	2002-1491	100 (25)

Separator; oversized; 2 mm thick			
	orange	2002-1294	100 (25)
	gray	2002-1293	100 (25)

Separator; oversized; 2 mm thick			
	orange	2002-1394	100 (25)
	gray	2002-1393	100 (25)

Separator; oversized; 2 mm thick			
	orange	2002-1494	100 (25)
	gray	2002-1493	100 (25)

Ex e/Ex i separator; orange; 3 mm thick			
	90 mm	209-190	50 (25)
	120 mm	209-191	50 (25)









Ex e/Ex i separator; orange; 3 mm thick			
	120 mm	209-191	50 (25)









Ex e/Ex i separator; orange; 3 mm thick			
	120 mm	209-191	50 (25)

### Accessories; 2001 Series

Appropriate marking systems: WMB/WMB Inline/Marking strips

Insulation stop; 5 pcs/strip; 0.25 ... 0.5 mm <sup>2</sup>			
	light gray	2001-171	200 (25)

Push-in type jumper bar; insulated; I <sub>N</sub> 18 A; light gray			
	2-way	2001-402	25
	3-way	2001-403	25
	4-way	2001-404	25
	5-way	2001-405	25
	6-way	2001-406	25
	7-way	2001-407	25
	8-way	2001-408	25
	9-way	2001-409	25
	10-way	2001-410	25

Push-in type jumper bar; insulated; I <sub>N</sub> 18 A; light gray			
	1 to 3	2001-433	25
	1 to 4	2001-434	25
	1 to 5	2001-435	25
	1 to 6	2001-436	25
	1 to 7	2001-437	25
	1 to 8	2001-438	25
	1 to 9	2001-439	25
	1 to 10	2001-440	25

### Protective warning marker; with black high-voltage symbol; for 5 terminal blocks

	yellow	2001-115	100 (25)
---	--------	----------	----------

**PUSH-IN CAGE CLAMP®**

**Technical Data**

0.25 ... 1.5 (2.5) mm <sup>2</sup> ①	22 ... 14 AWG
800 V/8 kV/3 ②	600 V, 15 A ③
I <sub>N</sub> 18 A (24 A)	600 V, 15 A ④

Terminal block width: 4.2 mm / 0.165 inch

9 ... 11 mm / 0.35 ... 0.43 inch

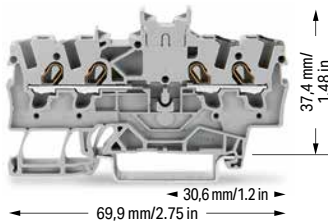

Double-potential terminal block; with push-button; with double, center marking slot  
 Notice: This double potential terminal block cannot be commoned with push-in type jumper bars!

Color	Item No.	Pack. Unit
gray ⑤	2001-1441 ⑥	100

① Conductor range: 0.25 ... 2.5 mm<sup>2</sup> "s+f-st"; Push-in termination: 0.75 ... 2.5 mm<sup>2</sup> "s" and 0.75 ... 1.5 mm<sup>2</sup> "insulated ferrules; 12 mm" Depending on the conductor characteristic, a conductor with a smaller cross section can also be inserted via push-in termination.

② 800 V = rated voltage  
 8 kV = rated impulse voltage  
 3 = pollution degree

③ Terminal blocks with a blue insulated housing are suitable for Ex i applications.

④ Terminal blocks with an Ex mark are suitable for Ex e II applications.  
 550 V; 17 A  
 16 A jumper

Please observe the application notes:  
 Separator for Ex e/Ex i applications, see page 43  
 Step-down jumpers, see page 47  
 Jumpers, from page 163  
 Testing accessories, from page 154  
 Marking, from page 246

Approvals and corresponding ratings, visit [www.wago.com](http://www.wago.com)

**Accessories; 2001 Series**

Appropriate marking systems:  
 WMB/WMB Inline/Marking strips

WMB Inline; plain; 2,000 WMB markers (4 mm)/reel; 4 ... 4.2 mm stretchable

white	2009-114	1
-------	----------	---

Marking strip; plain; 11 mm wide; 50 m reel

white	2009-110	1
-------	----------	---

WMB marking card; white; 10 strips with 10 markers/card; 4 ... 4.2 mm stretchable

plain	793-4501	5
-------	----------	---

WMB marking card; plain; 10 strips with 10 markers/card; 4 ... 4.2 mm stretchable

yellow	793-4501/000-002	5
red	793-4501/000-005	5
blue	793-4501/000-006	5
gray	793-4501/000-007	5
orange	793-4501/000-012	5
light green	793-4501/000-017	5
green	793-4501/000-023	5
violet	793-4501/000-024	5

**Accessories; 2001 Series**

Appropriate marking systems:  
 WMB/WMB Inline/Marking strips

Step-down jumper; insulated; commons 6/4 mm<sup>2</sup> (10/12 AWG) to 4/2.5/1.5 mm<sup>2</sup> (12/14/16 AWG); I<sub>N</sub> 32 A

light gray	2006-499	25
------------	----------	----

Push-in type wire jumper; insulated; 1.5 mm<sup>2</sup> conductor cross-section; I<sub>N</sub> 18 A

L = 60 mm	2009-412	100 (10)
L = 110 mm	2009-414	100 (10)
L = 250 mm	2009-416	100 (10)

Modular connector; snaps together; for jumper contact slot

gray	2001-511	100 (25)
------	----------	----------

Test plug adapter; for 4 mm Ø test plug

gray	2009-174	100 (25)
------	----------	----------

Banana plug; for 4 mm socket diameter; color mixed; 10 x orange, white, black, blue, yellow; max. 42 V

	215-111	50
--	---------	----

Testing tap; for max. 2.5 mm<sup>2</sup>

gray	2009-182	100 (25)
------	----------	----------

Test plug; with 500 mm cable; 2 mm Ø; max. 42 V

red	210-136	50 (1)
-----	---------	--------

Test plug; with 500 mm cable; 2.3 mm Ø; max. 42 V

yellow	210-137	50 (1)
--------	---------	--------

**Accessories; item-specific**

End and intermediate plate; 0.9 mm thick

orange	2002-1492	100 (25)
gray	2002-1491	100 (25)

Separator; oversized; 2 mm thick

orange	2002-1494	100 (25)
gray	2002-1493	100 (25)

Delta jumper; insulated; I<sub>N</sub> = I<sub>N</sub> terminal block; light gray

1-2 3-4 5-6	2001-406/020-000	25
-------------	------------------	----

Star point jumper; insulated; I<sub>N</sub> = I<sub>N</sub> terminal block; light gray

1-3-5	2001-405/011-000	25
-------	------------------	----

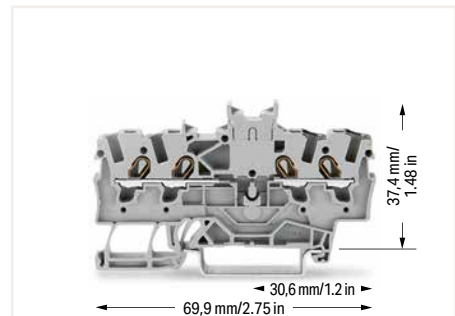

Notice: These double-potential terminal blocks cannot be commoned with push-in type jumper bars! Front-entry double-potential terminal blocks are space savers. Two independent feedthrough circuits are placed in one insulated housing on one level in just 4.2 mm. This achieves a width of just 2.1 mm versus standard through terminal blocks. Input and output of a circuit are placed on the same side of the terminal block. Both circuits can be individually marked according to input and output.

# Through Terminal Block, Ground Conductor Terminal Block, Shield Conductor Terminal Block, Double-Potential Terminal Block TOPJOB® S

## 2.5 (4) mm<sup>2</sup>; 2002 Series

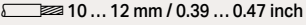
Technical Data	
0.25 ... 2.5 (4) mm <sup>2</sup> ①	22 ... 12 AWG
800 V/8 kV/3 ②	600 V, 20 A ③
I <sub>N</sub> 24 A (32 A)	600 V, 20 A ④
Terminal block width: 5.2 mm / 0.205 inch	
 10 ... 12 mm / 0.39 ... 0.47 inch	

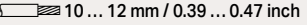
Technical Data	
0.25 ... 2.5 (4) mm <sup>2</sup> ①	22 ... 12 AWG
800 V/8 kV/3 ②	600 V, 20 A ③
I <sub>N</sub> 24 A (32 A)	600 V, 20 A ④
Terminal block width: 5.2 mm / 0.205 inch	
 10 ... 12 mm / 0.39 ... 0.47 inch	

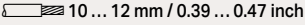
Technical Data	
0.25 ... 2.5 (4) mm <sup>2</sup> ①	22 ... 12 AWG
800 V/8 kV/3 ②	600 V, 20 A ③
I <sub>N</sub> 24 A (32 A)	600 V, 20 A ④
Terminal block width: 5.2 mm / 0.205 inch	
 10 ... 12 mm / 0.39 ... 0.47 inch	

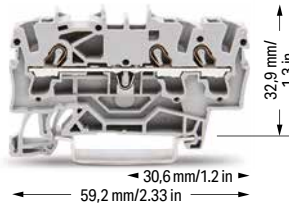
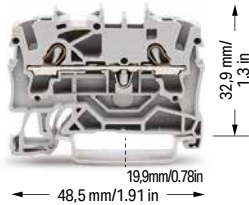

### 2-conductor through terminal block

Color	Item No.	Pack. Unit
gray ⑤	2002-1201 ④	100
blue ⑤	2002-1204 ③ ④	100
orange ⑤	2002-1202 ④	100
red ⑤	2002-1203 ④	100
black ⑤	2002-1205 ④	100
yellow ⑤	2002-1206 ④	100

### 3-conductor through terminal block

Color	Item No.	Pack. Unit
gray ⑤	2002-1301 ④	100
blue ⑤	2002-1304 ③ ④	100
orange ⑤	2002-1302 ④	100
red ⑤	2002-1303 ④	100
black ⑤	2002-1305 ④	100
yellow ⑤	2002-1306 ④	100

### 4-conductor through terminal block

Color	Item No.	Pack. Unit
gray ⑤	2002-1401 ④	100
blue ⑤	2002-1404 ③ ④	100
orange ⑤	2002-1402 ④	100
red ⑤	2002-1403 ④	100
black ⑤	2002-1405 ④	100
yellow ⑤	2002-1406 ④	100

### 2-conductor ground terminal block

green-yellow ⑤	2002-1207 ④	100
----------------	-------------	-----

### 3-conductor ground terminal block

green-yellow ⑤	2002-1307 ④	100
----------------	-------------	-----

### 4-conductor ground terminal block

green-yellow ⑤	2002-1407 ④	100
----------------	-------------	-----

### 2-conductor shield terminal block

white	2002-1208	100
-------	-----------	-----

### 3-conductor shield terminal block

white	2002-1308	100
-------	-----------	-----

### 4-conductor shield terminal block

white	2002-1408	100
-------	-----------	-----

### Other terminal blocks with the same profile:

Diode	2002-1211/1000-411	Page 132
-------	--------------------	----------

### Other terminal blocks with the same profile:

Diode	2002-1311/1000-411	Page 132
LED	2002-1321/1000-434	Page 132

### Other terminal blocks with the same profile:

Diode	2002-1411/1000-411	Page 132
LED	2002-1421/1000-434	Page 132

### Accessories; item-specific

#### End and intermediate plate; 0.8 mm thick

orange	2002-1292	100 (25)
gray	2002-1291	100 (25)

### Accessories; item-specific

#### End and intermediate plate; 0.8 mm thick

orange	2002-1392	100 (25)
gray	2002-1391	100 (25)

### Accessories; item-specific

#### End and intermediate plate; 0.8 mm thick

orange	2002-1492	100 (25)
gray	2002-1491	100 (25)

### Separator; oversized; 2 mm thick

orange	2002-1294	100 (25)
gray	2002-1293	100 (25)

### Separator; oversized; 2 mm thick

orange	2002-1394	100 (25)
gray	2002-1393	100 (25)

### Separator; oversized; 2 mm thick

orange	2002-1494	100 (25)
gray	2002-1493	100 (25)

### Ex e/Ex i separator; orange; 3 mm thick

90 mm	209-190	50 (25)
120 mm	209-191	50 (25)

### Ex e/Ex i separator; orange; 3 mm thick

120 mm	209-191	50 (25)
--------	---------	---------

### Ex e/Ex i separator; orange; 3 mm thick

120 mm	209-191	50 (25)
--------	---------	---------

### Accessories; 2002 Series

Appropriate marking systems: WMB/WMB Inline/Marking strips

### Insulation stop; 5 pcs/strip; 0.25 ... 0.5 mm<sup>2</sup>

light gray	2002-171	200 (25)
------------	----------	----------

### Push-in type jumper bar; insulated; I<sub>N</sub> 25 A; light gray

2-way	2002-402	25
3-way	2002-403	25
4-way	2002-404	25
5-way	2002-405	25
6-way	2002-406	25
7-way	2002-407	25
8-way	2002-408	25
9-way	2002-409	25
10-way	2002-410	25

### Push-in type jumper bar; insulated; I<sub>N</sub> 25 A; light gray

1 to 3	2002-433	25
1 to 4	2002-434	25
1 to 5	2002-435	25
1 to 6	2002-436	25
1 to 7	2002-437	25
1 to 8	2002-438	25
1 to 9	2002-439	25
1 to 10	2002-440	25

### Insulation stop; 5 pcs/strip; 0.75 ... 1 mm<sup>2</sup>

dark gray	2002-172	200 (25)
-----------	----------	----------



**PUSH-IN CAGE CLAMP®**

**Technical Data**

0.25 ... 2.5 (4) mm <sup>2</sup> ①	22 ... 12 AWG
800 V/8 kV/3 ②	600 V, 20 A ③
I <sub>N</sub> 24 A (32 A)	600 V, 20 A ④

Terminal block width: 5.2 mm / 0.205 inch

10 ... 12 mm / 0.39 ... 0.47 inch

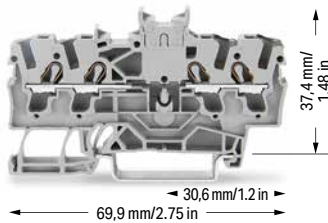

Double-potential terminal block; with double, center marking slot  
 Notice: This double potential terminal block cannot be commoned with push-in type jumper bars!

Color	Item No.	Pack. Unit
gray ⑤	2002-1441 ④	100

① Conductor range: 0.25 ... 4 mm<sup>2</sup> "s+f-st";  
 Push-in termination: 1 ... 4 mm<sup>2</sup> "s" and 1 ... 2.5 mm<sup>2</sup> "insulated ferrules, 12 mm"  
 Depending on the conductor characteristic, a conductor with a smaller cross section can also be inserted via push-in termination.

② 800 V = rated voltage  
 8 kV = rated impulse voltage  
 3 = pollution degree

③ Terminal blocks with a blue insulated housing are suitable for Ex i applications.

④ Terminal blocks with an Ex mark are suitable for Ex e II applications.  
 550 V; 22 A  
 20 A jumper

Please observe the application notes:  
 Separator for Ex e/Ex i applications, see page 43  
 Step-down jumpers, see page 47  
 Jumpers, from page 160  
 Testing accessories, from page 154  
 Marking, from page 246

Approvals and corresponding ratings, visit [www.wago.com](http://www.wago.com)

**Accessories; 2002 Series**

Appropriate marking systems:  
 WMB/WMB Inline/Marking strips

**Staggered jumper; insulated; I<sub>N</sub> 25 A; light gray**



2-way	2002-472	25
3-way	2002-473	25
4-way	2002-474	25
5-way	2002-475	25
6-way	2002-476	25
7-way	2002-477	25
8-way	2002-478	25
9-way	2002-479	25
10-way	2002-480	25
11-way	2002-481	25
12-way	2002-482	25

**Customized staggered jumper; insulated; with contact lugs broken off at the factory and circuit printing; I<sub>N</sub> 25 A; light gray**



1-3	2002-473/011-000	25
1-3-5	2002-475/011-000	25
1-3-5-7	2002-477/011-000	25
1-3-5-7-9	2002-479/011-000	25
1-3-5-7-9-11	2002-481/011-000	25

**Adjacent jumper for continuous commoning; insulated; I<sub>N</sub> 25 A, light gray**



2-way	2002-400	25
-------	----------	----

**Adjacent jumper for continuous commoning; insulated; I<sub>N</sub> 25 A; 1 to 3**



light gray	2002-423	25
red	2002-423/000-005	25
blue	2002-423/000-006	25

**Adjacent jumper for continuous commoning; insulated; I<sub>N</sub> 25 A, light gray**



5-way	2002-415	25
-------	----------	----

**Protective warning marker; with black high-voltage symbol; for 5 terminal blocks**



yellow	2002-115	100 (25)
--------	----------	----------

**Accessories; 2002 Series**

Appropriate marking systems:  
 WMB/WMB Inline/Marking strips

**Step-down jumper; insulated; commons 6/4 mm<sup>2</sup> (10/12 AWG) to 4/2.5/1.5 mm<sup>2</sup> (12/14/16 AWG); I<sub>N</sub> 32 A**



light gray	2006-499	25
------------	----------	----

**Push-in type wire jumper; insulated; 1.5 mm<sup>2</sup> conductor cross-section; I<sub>N</sub> 18 A**



L = 60 mm	2009-412	100 (10)
L = 110 mm	2009-414	100 (10)
L = 250 mm	2009-416	100 (10)

**Modular connector; snaps together; for jumper contact slot**



gray	2002-511	100 (25)
------	----------	----------

**L-type test plug module; snaps together**



gray	2002-611	100 (25)
------	----------	----------

**WMB Inline, plain; 1,500 WMB markers (5 mm)/reel; 5 ... 5.2 mm stretchable**



white	2009-115	1
-------	----------	---

**Marking strip; plain; 11 mm wide; 50 m reel**



white	2009-110	1
-------	----------	---

**WMB marking card; white; 10 strips with 10 markers/card; 5 ... 5.2 mm stretchable**



plain	793-5501	5
-------	----------	---

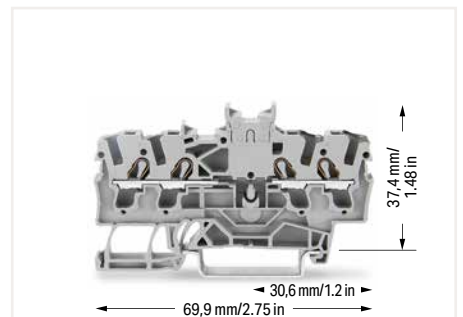

Notice: These double-potential terminal blocks cannot be commoned with push-in type jumper bars! Front-entry double-potential terminal blocks are space savers. Two independent feedthrough circuits are placed in one insulated housing on one level in just 5.2 mm. This achieves a width of just 2.6 mm versus standard through terminal blocks. Input and output of a circuit are placed on the same side of the terminal block. Both circuits can be individually marked according to input and output.

# Through Terminal Block, Ground Conductor Terminal Block, Shield Conductor Terminal Block, TOPJOB® S

## 2.5 (4) mm<sup>2</sup>; 2002 Series

### Technical Data

0.25 ... 2.5 (4) mm<sup>2</sup> ① 22 ... 12 AWG

800 V/8 kV/3 ② 600 V, 20 A ③

I<sub>N</sub> 24 A (32 A) 600 V, 20 A ④

Terminal block width: 5.2 mm / 0.205 inch

10 ... 12 mm / 0.39 ... 0.47 inch

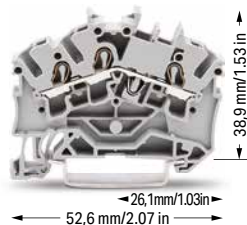

### 3-conductor through terminal block

Color	Item No.	Pack. Unit
gray ⑤	2002-6301 ④	100
blue ⑤	2002-6304 ③ ④	100
orange ⑤	2002-6302 ④	100
red ⑤	2002-6303 ④	100
black ⑤	2002-6305 ④	100
yellow ⑤	2002-6306 ④	100

### 3-conductor ground terminal block

green-yellow ⑤	2002-6307 ④	100
----------------	-------------	-----

### 3-conductor shield terminal block

white	2002-6308	100
-------	-----------	-----

### Accessories; 2002 Series

Appropriate marking systems:  
WMB/WMB Inline/Marking strips

### End and intermediate plate; 0.8 mm thick

orange	2002-6392	100 (25)
gray	2002-6391	100 (25)

### Ex e/Ex i separator; orange; 3 mm thick

120 mm	209-191	50 (25)
--------	---------	---------

### Insulation stop; 5 pcs/strip; 0.25 ... 0.5 mm<sup>2</sup>

light gray	2002-171	200 (25)
------------	----------	----------

### Insulation stop; 5 pcs/strip; 0.75 ... 1 mm<sup>2</sup>

dark gray	2002-172	200 (25)
-----------	----------	----------

### Protective warning marker; with black high-voltage symbol; for 5 terminal blocks

yellow	2002-115	100 (25)
--------	----------	----------

### Push-in type jumper bar; insulated; I<sub>N</sub> 25 A; light gray

2-way	2002-402	25
3-way	2002-403	25
4-way	2002-404	25
5-way	2002-405	25
6-way	2002-406	25
7-way	2002-407	25
8-way	2002-408	25
9-way	2002-409	25
10-way	2002-410	25

① Conductor range: 0.25 ... 4 mm<sup>2</sup> "s+f-st";  
Push-in termination: 1 ... 4 mm<sup>2</sup> "s" and 1 ... 2.5 mm<sup>2</sup> "insulated ferrules, 12 mm"  
Depending on the conductor characteristic, a conductor with a smaller cross section can also be inserted via push-in termination.

② 800 V = rated voltage  
8 kV = rated impulse voltage  
3 = pollution degree

③ Terminal blocks with a blue insulated housing are suitable for Ex i applications.

④ Terminal blocks with an Ex mark are suitable for Ex e II applications.  
550 V; 22 A  
20 A jumper

Please observe the application notes:  
Separator for Ex e/Ex i applications, see page 43  
Jumpers, from page 160  
Testing accessories, from page 154  
Marking, from page 246

Approvals and corresponding ratings,  
visit [www.wago.com](http://www.wago.com)

### Accessories; 2002 Series

Appropriate marking systems:  
WMB/WMB Inline/Marking strips

### Push-in type jumper bar; insulated; I<sub>N</sub> 25 A; light gray

1 to 3	2002-433	25
1 to 4	2002-434	25
1 to 5	2002-435	25
1 to 6	2002-436	25
1 to 7	2002-437	25
1 to 8	2002-438	25
1 to 9	2002-439	25
1 to 10	2002-440	25

### Delta jumper; insulated; I<sub>N</sub> = I<sub>N</sub> terminal block; light gray

1-2 3-4 5-6	2002-406/020-000	25
-------------	------------------	----

### Star point jumper; insulated; I<sub>N</sub> = I<sub>N</sub> terminal block; light gray

1-3-5	2002-405/011-000	25
-------	------------------	----

### Staggered jumper; insulated; I<sub>N</sub> 25 A; light gray

2-way	2002-472	25
3-way	2002-473	25
4-way	2002-474	25
5-way	2002-475	25
6-way	2002-476	25
7-way	2002-477	25
8-way	2002-478	25
9-way	2002-479	25
10-way	2002-480	25
11-way	2002-481	25
12-way	2002-482	25

### Customized staggered jumper; insulated; with contact lugs broken off at the factory and circuit printing; I<sub>N</sub> 25 A; light gray

1-3	2002-473/011-000	25
1-3-5	2002-475/011-000	25
1-3-5-7	2002-477/011-000	25
1-3-5-7-9	2002-479/011-000	25
1-3-5-7-9-11	2002-481/011-000	25

### Adjacent jumper for continuous commoning; insulated; I<sub>N</sub> 25 A; light gray

2-way	2002-400	25
-------	----------	----

### Accessories; 2002 Series

Appropriate marking systems:  
WMB/WMB Inline/Marking strips

### Adjacent jumper for continuous commoning; insulated; I<sub>N</sub> 25 A; 1 to 3

light gray	2002-423	25
red	2002-423/000-005	25
blue	2002-423/000-006	25

### Adjacent jumper for continuous commoning; insulated; I<sub>N</sub> 25 A; light gray

5-way	2002-415	25
-------	----------	----

### Push-in type wire jumper; insulated; 1.5 mm<sup>2</sup> conductor cross-section; I<sub>N</sub> 18 A

L = 60 mm	2009-412	100 (10)
L = 110 mm	2009-414	100 (10)
L = 250 mm	2009-416	100 (10)

### Modular connector; snaps together; for jumper contact slot

gray	2002-511	100 (25)
------	----------	----------

### Spacer module; snaps together; bridges commoned terminal blocks

gray	2002-549	100 (25)
------	----------	----------

### End plate; for modular connector; 1.5 mm thick

gray	2002-541	100 (25)
------	----------	----------

### L-type test plug module; snaps together

gray	2002-611	100 (25)
------	----------	----------

### L-type spacer module; snaps together; bridges commoned terminal blocks

gray	2002-649	100 (25)
------	----------	----------

### End plate; for modular test plug module; 1.5 mm thick

gray	2002-641	100 (25)
------	----------	----------

### WMB Inline, plain; 1,500 WMB markers (5 mm)/reel; 5 ... 5.2 mm stretchable

white	2009-115	1
-------	----------	---

### Marking strip; plain; 11 mm wide; 50 m reel

white	2009-110	1
-------	----------	---

### WMB marking card; white; 10 strips with 10 markers/card; 5 ... 5.2 mm stretchable

plain	793-5501	5
-------	----------	---

## Through Terminal Block, Ground Conductor Terminal Block TOPJOB® S 2.5 (4) mm<sup>2</sup>; 2002 Series

### Technical Data

0.25 ... 2.5 (4) mm <sup>2</sup> ①	22 ... 12 AWG
800 V/8 kV/3 ①	600 V, 20 A ②
I <sub>N</sub> 24 A (32 A)	600 V, 20 A ②
Terminal block width: 5.2 mm / 0.205 inch	
 10 ... 12 mm / 0.39 ... 0.47 inch	



### 4-conductor through terminal block

Notice: This terminal block cannot be commoned with push-in type jumper bars!

Color	Item No.	Pack. Unit
gray ③	2002-6401 ④	100
blue ③	2002-6404 ④	100
orange ③	2002-6402 ④	100
red ③	2002-6403 ④	100
black ③	2002-6405 ④	100
yellow ③	2002-6406 ④	100

### 4-conductor ground terminal block

green-yellow ③	2002-6407 ④	100
----------------	-------------	-----

### Accessories; 2002 Series

Appropriate marking systems:  
WMB/WMB Inline/Marking strips

### End and intermediate plate; 0.8 mm thick

orange	2002-6392	100 (25)
gray	2002-6391	100 (25)

### Ex e/Ex i separator; orange; 3 mm thick

120 mm	209-191	50 (25)
--------	---------	---------

### Insulation strip; 5 pcs/strip; 0.25 ... 0.5 mm<sup>2</sup>

light gray	2002-171	200 (25)
------------	----------	----------

### Insulation strip; 5 pcs/strip; 0.75 ... 1 mm<sup>2</sup>

dark gray	2002-172	200 (25)
-----------	----------	----------

### Protective warning marker; with black high-voltage symbol; for 5 terminal blocks

yellow	2002-115	100 (25)
--------	----------	----------

### WMB Inline, plain; 1,500 WMB markers (5 mm)/reel; 5 ... 5.2 mm stretchable

white	2009-115	1
-------	----------	---

### Marking strip; plain; 11 mm wide; 50 m reel

white	2009-110	1
-------	----------	---

- Conductor range: 0.25 ... 4 mm<sup>2</sup> "s+f-st";  
Push-in termination: 1 ... 4 mm<sup>2</sup> "s" and 1 ... 2.5 mm<sup>2</sup> "insulated ferrules, 12 mm"  
Depending on the conductor characteristic, a conductor with a smaller cross section can also be inserted via push-in termination.
- 800 V = rated voltage  
8 kV = rated impulse voltage  
3 = pollution degree
- Terminal blocks with a blue insulated housing are suitable for Ex i applications.
- Terminal blocks with an Ex mark are suitable for Ex e II applications.  
550 V; 22 A  
20 A jumper

Please observe the application notes:  
Separator for Ex e/Ex i applications, see page 43  
Marking, from page 246

Approvals and corresponding ratings,  
visit [www.wago.com](http://www.wago.com)

### Accessories; 2002 Series

Appropriate marking systems:  
WMB/WMB Inline/Marking strips

### WMB marking card; white; 10 strips with 10 markers/card; 5 ... 5.2 mm stretchable

plain	793-5501	5
-------	----------	---

### WMB marking card; plain; 10 strips with 10 markers/card; 5 ... 5.2 mm stretchable

yellow	793-5501/000-002	5
red	793-5501/000-005	5
blue	793-5501/000-006	5
gray	793-5501/000-007	5
orange	793-5501/000-012	5
light green	793-5501/000-017	5
green	793-5501/000-023	5
violet	793-5501/000-024	5

### Screwless end stop; for DIN-35 rail; 6 mm wide

gray	249-116	100 (25)
------	---------	----------

### Screwless end stop; for DIN-35 rail; 10 mm wide

gray	249-117	50 (25)
------	---------	---------

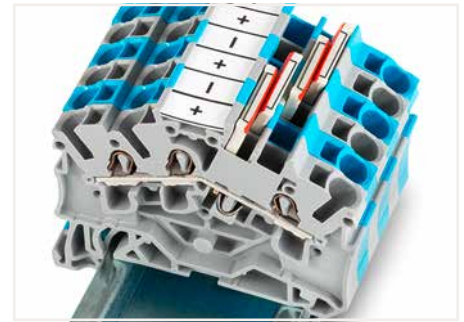

**3- and 4-conductor terminal blocks (angled type):**  
WAGO's Rail-Mount Terminal Blocks TOPJOB® S have a 35-degree conductor entry angle permitting a very small bend radius and an extremely short wiring distance to the cable duct. These are space- and cost-saving solutions for switchgear and control cabinet applications that use the LSC wiring system from Lütze. The design allows cable duct to be placed very close to the terminal blocks, keeping its height relatively low.

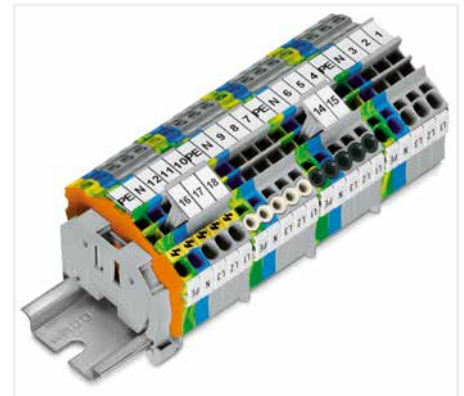

### Product features:

- Push-in CAGE CLAMP® connection for all conductor types, with the additional benefit of solid, stranded and fine-stranded conductors with ferrules being simply pushed in
- Vibration-proof, fast, maintenance-free
- 3-conductor through and ground conductor terminal blocks equipped with a dual jumper slot
- 4-conductor terminal blocks permit potential multiplication – no additional jumpers or terminal blocks needed
- 3- and 4-conductor terminal blocks have the same dimensions.
- An end plate must be applied when changing from a 3-conductor terminal block to a 4-conductor terminal block and vice versa.

Sold & Serviced By:

 **ELECTROMATE**

Toll Free Phone (877) SERV098  
[www.electromate.com](http://www.electromate.com)  
[sales@electromate.com](mailto:sales@electromate.com)

# Through Terminal Block, Ground Conductor Terminal Block, Shield Conductor Terminal Block TOPJOB® S 4 (6) mm<sup>2</sup>; 2004 Series

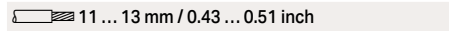
Technical Data	
0.5 ... 4 (6) mm <sup>2</sup> ①	20 ... 10 AWG
800 V/8 kV/3 ②	600 V, 30 A ③
I <sub>N</sub> 32 A (41 A)	600 V, 30 A ④
Terminal block width: 6.2 mm / 0.244 inch	
 11 ... 13 mm / 0.43 ... 0.51 inch	

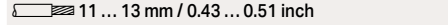
Technical Data	
0.5 ... 4 (6) mm <sup>2</sup> ①	20 ... 10 AWG
800 V/8 kV/3 ②	600 V, 30 A ③
I <sub>N</sub> 32 A (41 A)	600 V, 30 A ④
Terminal block width: 6.2 mm / 0.244 inch	
 11 ... 13 mm / 0.43 ... 0.51 inch	

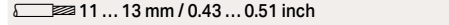
Technical Data	
0.5 ... 4 (6) mm <sup>2</sup> ①	20 ... 10 AWG
800 V/8 kV/3 ②	600 V, 30 A ③
I <sub>N</sub> 32 A (41 A)	600 V, 30 A ④
Terminal block width: 6.2 mm / 0.244 inch	
 11 ... 13 mm / 0.43 ... 0.51 inch	

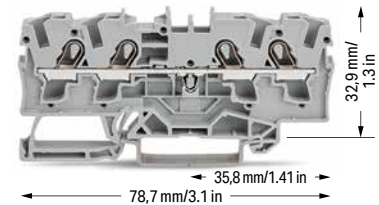
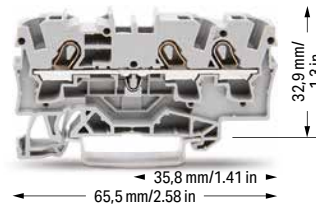

2-conductor through terminal block		
Color	Item No.	Pack. Unit
gray ⑤	2004-1201 ④	50
blue ⑤	2004-1204 ③ ④	50
orange ⑤	2004-1202 ④	50
red ⑤	2004-1203 ④	50
black ⑤	2004-1205 ④	50
yellow ⑤	2004-1206 ④	50

3-conductor through terminal block		
Color	Item No.	Pack. Unit
gray ⑤	2004-1301 ④	50
blue ⑤	2004-1304 ③ ④	50
orange ⑤	2004-1302 ④	50
red ⑤	2004-1303 ④	50
black ⑤	2004-1305 ④	50
yellow ⑤	2004-1306 ④	50

4-conductor through terminal block		
Color	Item No.	Pack. Unit
gray ⑤	2004-1401 ④	50
blue ⑤	2004-1404 ③ ④	50
orange ⑤	2004-1402 ④	50
red ⑤	2004-1403 ④	50
black ⑤	2004-1405 ④	50
yellow ⑤	2004-1406 ④	50

2-conductor ground terminal block		
green-yellow ⑤	2004-1207 ④	50

3-conductor ground terminal block		
green-yellow ⑤	2004-1307 ④	50



4-conductor ground terminal block		
green-yellow ⑤	2004-1407 ④	50



4-conductor shield terminal block		
white ⑤	2004-1408	50



Other terminal blocks with the same profile:		
Diode	2004-1211/1000-401	Page 134



Other terminal blocks with the same profile:		
Diode	2004-1311/1000-401	Page 134



Other terminal blocks with the same profile:		
Diode	2004-1411/1000-401	Page 134



Accessories; item-specific			
End and intermediate plate; 1 mm thick			
orange	2004-1292	100 (25)	
gray	2004-1291	100 (25)	



Accessories; item-specific			
End and intermediate plate; 1 mm thick			
orange	2004-1392	100 (25)	
gray	2004-1391	100 (25)	

Accessories; item-specific			
End and intermediate plate; 1 mm thick			
orange	2004-1492	100 (25)	
gray	2004-1491	100 (25)	

Separator; oversized; 2 mm thick			
orange	2004-1294	100 (25)	
gray	2004-1293	100 (25)	

Separator; oversized; 2 mm thick			
orange	2004-1394	100 (25)	
gray	2004-1393	100 (25)	

Separator; oversized; 2 mm thick			
orange	2004-1494	100 (25)	
gray	2004-1493	100 (25)	

Ex e/Ex i separator; orange; 3 mm thick			
90 mm	209-190	50 (25)	
120 mm	209-191	50 (25)	









Ex e/Ex i separator; orange; 3 mm thick			
120 mm	209-191	50 (25)	









Ex e/Ex i separator; orange; 3 mm thick			
120 mm	209-191	50 (25)	

Accessories; 2004 Series

Appropriate marking systems: WMB/WMB Inline/Marking strips

Insulation stop; 5 pcs/strip; 0.25 ... 0.5 mm <sup>2</sup>			
light gray	2004-171	200 (25)	

Push-in type jumper bar; insulated; I <sub>N</sub> 32 A; light gray			
2-way	2004-402	25	
3-way	2004-403	25	
4-way	2004-404	25	
5-way	2004-405	25	
6-way	2004-406	25	
7-way	2004-407	25	
8-way	2004-408	25	
9-way	2004-409	25	
10-way	2004-410	25	

Push-in type jumper bar; insulated; I <sub>N</sub> 32 A; light gray			
1 to 3	2004-433	25	
1 to 4	2004-434	25	
1 to 5	2004-435	25	
1 to 6	2004-436	25	
1 to 7	2004-437	25	
1 to 8	2004-438	25	
1 to 9	2004-439	25	
1 to 10	2004-440	25	

Insulation stop; 5 pcs/strip; 0.75 ... 1 mm <sup>2</sup>			
dark gray	2004-172	200 (25)	

Step-down jumper; insulated; commons 6/4 mm <sup>2</sup> (10/12 AWG) to 4/2.5/1.5 mm <sup>2</sup> (12/14/16 AWG); I <sub>N</sub> 32 A			
light gray	2006-499	25	

Protective warning marker; with black high-voltage symbol; for 5 terminal blocks			
yellow	2004-115	100 (25)	

Delta jumper; insulated; I <sub>N</sub> = I <sub>N</sub> terminal block; light gray			
1-2 3-4 5-6	2004-406/020-000	25	



**PUSH-IN CAGE CLAMP®**

- ❶ Conductor range: 0.5 ... 6 mm<sup>2</sup> "s+f-st";  
Push-in termination: 1.5 ... 6 mm<sup>2</sup> "s" and 1.5 ... 4 mm<sup>2</sup> "insulated ferrules; 12 mm"  
Depending on the conductor characteristic, a conductor with a smaller cross section can also be inserted via push-in termination.
- ❷ 800 V = rated voltage  
8 kV = rated impulse voltage  
3 = pollution degree
- ❸ Terminal blocks with a blue insulated housing are suitable for Ex i applications.
- ❹ Terminal blocks with an Ex mark are suitable for Ex e II applications.  
550 V; 30 A

Please observe the application notes:  
Separator for Ex e/Ex i applications, see page 43  
Step-down jumpers, see page 47  
Jumpers, from page 163  
Testing accessories, from page 156  
Marking, from page 246

Approvals and corresponding ratings, visit [www.wago.com](http://www.wago.com)

**Accessories; 2004 Series**

Appropriate marking systems:  
WMB/WMB Inline/Marking strips

Modular connector; snaps together; for jumper contact slot

	gray	2004-511	100 (25)
---	------	----------	----------

Spacer module; snaps together; bridges commoned terminal blocks

	gray	2004-549	100 (25)
---	------	----------	----------

End plate; for modular connector; 1.5 mm thick

	gray	2004-541	100 (25)
---	------	----------	----------

Test plug adapter; for 4 mm Ø test plug

	gray	2009-174	100 (25)
---	------	----------	----------

Banana plug; for 4 mm socket diameter; color mixed; 10 x orange, white, black, blue, yellow; max. 42 V

		215-111	50
---	--	---------	----

Testing tap; for max. 2.5 mm<sup>2</sup>

	gray	2009-182	100 (25)
---	------	----------	----------

Marking strip; plain; 11 mm wide; 50 m reel

	white	2009-110	1
---	-------	----------	---

WMB marking card; white; 10 strips with 10 markers/card; 5 ... 5.2 mm stretchable

	plain	793-5501	5
---	-------	----------	---

Group marker carrier; snap-on type for jumper slot; 5 mm wide

	gray	2009-191	50 (25)
---	------	----------	---------

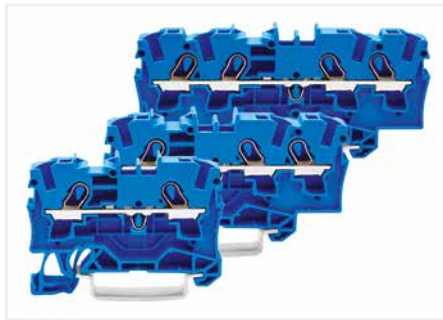

Through terminal blocks with a blue insulated housing are suitable for Ex i applications.



All through and ground conductor terminal blocks are suitable for Ex e II applications.

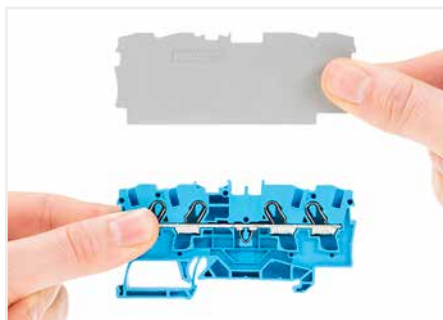

**Separator for Ex e/Ex i applications:**  
An end plate must be applied to the terminal block located directly behind an Ex e/Ex i separator plate.



**Ex e II/Ex i terminal strip**  
**Notice:**  
The movable feet of terminal blocks and separator plates must face the same direction.

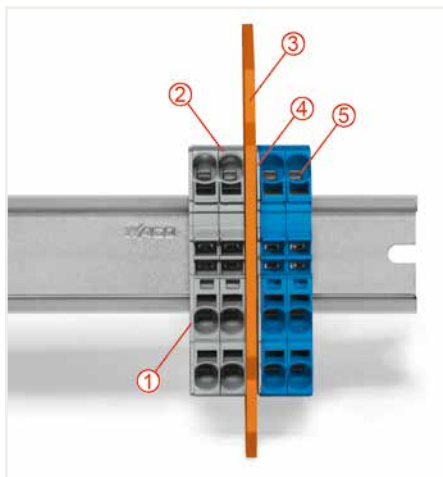

Separator located between Ex e II and Ex i terminal strip  
 ❶ End plate  
 ❷ Ex e II terminal blocks  
 ❸ Separator for Ex e/Ex i applications  
 ❹ End plate  
 ❺ Ex i terminal blocks



**Example of marking (rear):**  
The embossed details on the terminal blocks show the manufacturer's name, the series no., the type of protection Ex e II, the approval no., the approval data and the name of the testing authority.



# Through Terminal Block, Ground Conductor Terminal Block, Shield Conductor Terminal Block

## TOPJOB® S

### 6 (10) mm<sup>2</sup>; 2006 Series

#### Technical Data

0.5 ... 6 (10) mm <sup>2</sup> ①	20 ... 8 AWG
800 V/8 kV/3 ②	600 V, 50 A ③
I <sub>N</sub> 41 A (57 A)	600 V, 50 A ④
Terminal block width: 7.5 mm / 0.295 inch	
 13 ... 15 mm / 0.51 ... 0.59 inch	



#### Technical Data

0.5 ... 6 (10) mm <sup>2</sup> ①	20 ... 8 AWG
800 V/8 kV/3 ②	600 V, 50 A ③
I <sub>N</sub> 41 A (57 A)	600 V, 50 A ④
Terminal block width: 7.5 mm / 0.295 inch	
 13 ... 15 mm / 0.51 ... 0.59 inch	



#### 2-conductor through terminal block

Color	Item No.	Pack. Unit
gray ⑤	2006-1201 ④	50
blue ⑤	2006-1204 ③ ④	50
orange ⑤	2006-1202 ④	50

#### 3-conductor through terminal block

Color	Item No.	Pack. Unit
gray ⑤	2006-1301 ④	25
blue ⑤	2006-1304 ③ ④	25
orange ⑤	2006-1302 ④	25
black ⑤	2006-1305 ④	25

#### 2-conductor ground terminal block

green-yellow ⑤	2006-1207 ④	50
----------------	-------------	----

#### 3-conductor ground terminal block

green-yellow ⑤	2006-1307 ④	25
----------------	-------------	----

#### 2-conductor shield terminal block

white	2006-1208	50
-------	-----------	----

#### Accessories; item-specific

##### End and intermediate plate; 1 mm thick

orange	2006-1292	100 (25)
gray	2006-1291	100 (25)

#### Accessories; item-specific

##### End and intermediate plate; 1 mm thick

orange	2006-1392	100 (25)
gray	2006-1391	100 (25)

#### Separator; oversized; 2 mm thick

orange	2006-1294	100 (25)
gray	2006-1293	100 (25)

#### Separator; oversized; 2 mm thick

orange	2006-1394	100 (25)
gray	2006-1393	100 (25)

#### Accessories; 2006 Series

Appropriate marking systems: WMB/WMB Inline/Marking strips

#### Ex e/Ex i separator; orange; 3 mm thick

120 mm	209-191	50 (25)
--------	---------	---------

#### Protective warning marker; with black high-voltage symbol; for 5 terminal blocks

yellow	2006-115	100 (25)
--------	----------	----------

#### Push-in type jumper bar; insulated; I<sub>N</sub> 41 A; light gray

2-way	2006-402	25
3-way	2006-403	25
4-way	2006-404	25
5-way	2006-405	25

#### Lockout cap; for conductor entry and operating slot

gray	2006-191	25
------	----------	----

#### Push-in type jumper bar; insulated; I<sub>N</sub> 41 A; light gray

1 to 3	2006-433	25
1 to 4	2006-434	25
1 to 5	2006-435	25

#### Modular connector; snaps together; for jumper contact slot

gray	2006-511	50 (25)
------	----------	---------

#### Star point jumper; insulated; I<sub>N</sub> = I<sub>N</sub> terminal block; light gray

1-3-5	2006-405/011-000	25
-------	------------------	----

#### Test plug adapter; for 4 mm Ø test plug

gray	2009-174	100 (25)
------	----------	----------

#### Step-down jumper; insulated; commons 6/4 mm<sup>2</sup> (10/12 AWG) to 4/2.5/1.5 mm<sup>2</sup> (12/14/16 AWG); I<sub>N</sub> 32 A

light gray	2006-499	25
------------	----------	----

#### Marking strip; plain; 11 mm wide; 50 m reel

white	2009-110	1
-------	----------	---

① Conductor range: 0.5 ... 10 mm<sup>2</sup> "s+f-st"; Push-in termination: 2.5 ... 10 mm<sup>2</sup> "s" and 2.5 ... 6 mm<sup>2</sup> "insulated ferrules; 12 mm"  
Depending on the conductor characteristic, a conductor with a smaller cross section can also be inserted via push-in termination.

② 800 V = rated voltage  
8 kV = rated impulse voltage  
3 = pollution degree

③ Terminal blocks with a blue insulated housing are suitable for Ex i applications.

④ Terminal blocks with an Ex mark are suitable for Ex e II applications.  
550 V; 38 A; for 2-conductor terminal blocks  
550 V; 36 A; for 3-conductor terminal blocks  
33 A jumper

Please observe the application notes:  
Separator for Ex e/Ex i applications, see page 43  
Step-down jumpers, see page 47  
Jumpers, from page 163  
Testing accessories, from page 156  
Marking, from page 246

Approvals and corresponding ratings, visit [www.wago.com](http://www.wago.com)



Cover (2006-191) seals unused conductor entry.



Commoning with step-down jumpers.

# Through Terminal Block, Ground Conductor Terminal Block, Shield Conductor Terminal Block TOPJOB® S 10 (16) mm<sup>2</sup>; 2010 Series

## Technical Data

0.5 ... 10 (16) mm <sup>2</sup> ①	20 ... 6 AWG
800 V/8 kV/3 ②	600 V, 65 A ③
I <sub>N</sub> 57 A (76 A)	600 V, 65 A ④
Terminal block width: 10 mm / 0.394 inch	
 17 ... 19 mm / 0.67 ... 0.75 inch	

## Technical Data

0.5 ... 10 (16) mm <sup>2</sup> ①	20 ... 6 AWG
800 V/8 kV/3 ②	600 V, 65 A ③
I <sub>N</sub> 57 A (76 A)	600 V, 65 A ④
Terminal block width: 10 mm / 0.394 inch	
 17 ... 19 mm / 0.67 ... 0.75 inch	

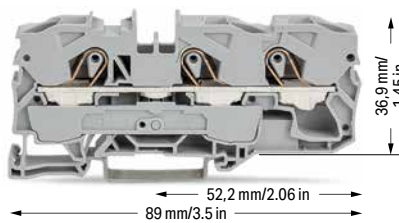
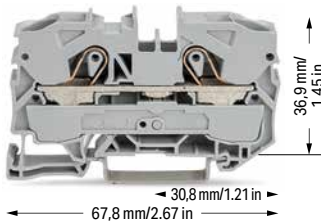

## 2-conductor through terminal block

Color	Item No.	Pack. Unit
gray ⑤	2010-1201 ④	25
blue ⑤	2010-1204 ③ ④	25
orange ⑤	2010-1202 ④	25
black ⑤	2010-1205 ④	25

## 3-conductor through terminal block

Color	Item No.	Pack. Unit
gray ⑤	2010-1301 ④	25
blue ⑤	2010-1304 ③ ④	25
orange ⑤	2010-1302 ④	25
black ⑤	2010-1305 ④	25

## 2-conductor ground terminal block

green-yellow ⑤	2010-1207 ④	25
----------------	-------------	----

## 3-conductor ground terminal block

green-yellow ⑤	2010-1307 ④	25
----------------	-------------	----

## 2-conductor shield terminal block

white	2010-1208	25
-------	-----------	----

## Accessories; item-specific

### End and intermediate plate; 1 mm thick

orange	2010-1292	100 (25)
gray	2010-1291	100 (25)

## Accessories; item-specific

### End and intermediate plate; 1 mm thick

orange	2010-1392	100 (25)
gray	2010-1391	100 (25)

## Ex e/Ex i separator; orange; 3 mm thick

120 mm	209-191	50 (25)
--------	---------	---------

## Accessories; 2010 Series

Appropriate marking systems: WMB/WMB Inline/Marking strips

## Push-in type jumper bar; insulated; I<sub>N</sub> 57 A; light gray

	2-way	2010-402	25
	3-way	2010-403	25
	4-way	2010-404	25
	5-way	2010-405	25

## Push-in type jumper bar; insulated; I<sub>N</sub> 57 A; light gray

	1 to 3	2010-433	25
	1 to 4	2010-434	25
	1 to 5	2010-435	25

## Star point jumper; insulated; I<sub>N</sub> = I<sub>N</sub> terminal block; light gray

	1-3-5	2010-405/011-000	25
---	-------	------------------	----

## Step-down jumper; insulated; commons 16/10 mm<sup>2</sup> (8/10 AWG) to 10/6/4/2.5 mm<sup>2</sup> (8/10/12/14 AWG); I<sub>N</sub> 57 A

	light gray	2016-499	25
---	------------	----------	----

## Protective warning marker; with black high-voltage symbol; for 5 terminal blocks

	yellow	2010-115	100 (25)
---	--------	----------	----------

## Finger guard; touch-proof cover protects unused conductor entries

	yellow	2010-100	100 (25)
---	--------	----------	----------

## Modular connector; snaps together; for jumper contact slot

	gray	2010-511	50 (25)
---	------	----------	---------

## Test plug adapter; for 4 mm Ø test plug

	gray	2009-174	100 (25)
---	------	----------	----------

## Marking strip; plain; 11 mm wide; 50 m reel

	white	2009-110	1
---	-------	----------	---

## WMB marking card; white; 10 strips with 10 markers/card; 5 ... 5.2 mm stretchable

	plain	793-5501	5
---	-------	----------	---

① Conductor range: 0.5 ... 16 mm<sup>2</sup> "s+f-st"; Push-in termination: 4 ... 16 mm<sup>2</sup> "s" and 4 ... 10 mm<sup>2</sup> "insulated ferrules; 18 mm"  
Depending on the conductor characteristic, a conductor with a smaller cross section can also be inserted via push-in termination.

② 800 V = rated voltage  
8 kV = rated impulse voltage  
3 = pollution degree

③ Terminal blocks with a blue insulated housing are suitable for Ex i applications.

④ Terminal blocks with an Ex mark are suitable for Ex e II applications.  
550 V; 51 A; for 2-conductor terminal blocks  
550 V; 50 A; for 3-conductor terminal blocks

Please observe the application notes:

Separator for Ex e/Ex i applications, see page 43

Step-down jumpers, see page 47

Jumpers, from page 163

Testing accessories, from page 156

Marking, from page 246

Approvals and corresponding ratings, visit [www.wago.com](http://www.wago.com)

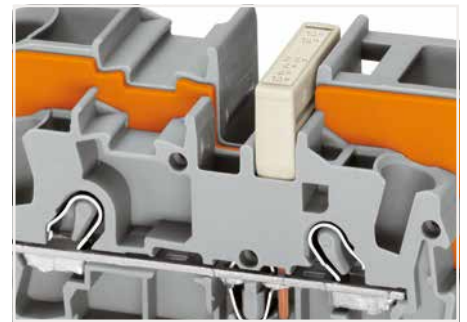

Commoning with step-down jumpers.

# Through Terminal Block, Ground Conductor Terminal Block, Shield Conductor Terminal Block

## TOPJOB® S

### 16 (25 "f-st") mm<sup>2</sup>; 2016 Series

Technical Data	
0.5 ... 16 (25 "f-st") mm <sup>2</sup> ①	20 ... 4 AWG
800 V/8 kV/3 ②	600 V, 85 A ③
I <sub>N</sub> 76 A (90 A)	600 V, 80 A ④
Terminal block width: 12 mm / 0.472 inch	
18 ... 20 mm / 0.71 ... 0.79 inch	

Technical Data	
0.5 ... 16 (25 "f-st") mm <sup>2</sup> ①	20 ... 4 AWG
800 V/8 kV/3 ②	600 V, 85 A ③
I <sub>N</sub> 76 A (90 A)	600 V, 80 A ④
Terminal block width: 12 mm / 0.472 inch	
18 ... 20 mm / 0.71 ... 0.79 inch	

① Conductor range: 0.5 ... 16 mm<sup>2</sup> "s+f-st", 25 mm<sup>2</sup> "f-st";  
Push-in termination: 6 ... 16 mm<sup>2</sup> "s" and 6 ... 16 mm<sup>2</sup> "insulated ferrules; 18 mm"  
Depending on the conductor characteristic, a conductor with a smaller cross section can also be inserted via push-in termination.

② 800 V = rated voltage  
8 kV = rated impulse voltage  
3 = pollution degree

③ Terminal blocks with a blue insulated housing are suitable for Ex i applications.

④ Terminal blocks with an Ex mark are suitable for Ex e II applications.  
550 V; 70 A; for 2-conductor terminal blocks  
550 V; 67 A; for 3-conductor terminal blocks  
65 A jumper

Please observe the application notes:  
Separator for Ex e/Ex i applications, see page 43  
Step-down jumpers, see page 47  
Jumpers, from page 163  
Testing accessories, from page 157  
Marking, from page 246

Approvals and corresponding ratings, visit [www.wago.com](http://www.wago.com)

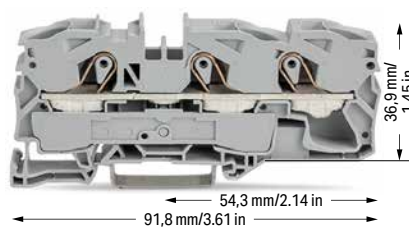
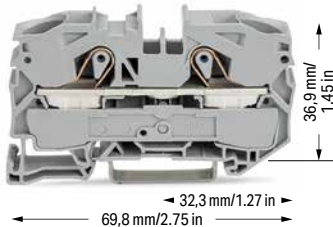

2-conductor through terminal block		
Color	Item No.	Pack. Unit
gray ⑤	2016-1201 ④	20
blue ⑤	2016-1204 ③ ④	20
orange ⑤	2016-1202 ④	20
red ⑤	2016-1203 ④	20

3-conductor through terminal block		
Color	Item No.	Pack. Unit
gray ⑤	2016-1301 ④	20
blue ⑤	2016-1304 ③ ④	20
orange ⑤	2016-1302 ④	20
red ⑤	2016-1303 ④	20
black ⑤	2016-1305 ④	20
yellow ⑤	2016-1306 ④	20

2-conductor ground terminal block		
15 mm high DIN-35 rails shall be used for a current load higher than 76 A!		
green-yellow ⑤	2016-1207 ④	20

3-conductor ground terminal block		
15 mm high DIN-35 rails shall be used for a current load higher than 76 A!		
green-yellow ⑤	2016-1307 ④	20

2-conductor shield terminal block		
15 mm high DIN-35 rails shall be used for a current load higher than 76 A!		
white	2016-1208	20



Finger guard seals an unused conductor entry.

Accessories; item-specific			
End and intermediate plate; 1 mm thick			
orange	2016-1292	100 (25)	
gray	2016-1291	100 (25)	

Accessories; item-specific			
End and intermediate plate; 1 mm thick			
orange	2016-1392	100 (25)	
gray	2016-1391	100 (25)	

Ex e/Ex i separator; orange; 3 mm thick			
120 mm	209-191	50 (25)	

Accessories; 2016 Series  
Appropriate marking systems: WMB/WMB Inline/Marking strips

Push-in type jumper bar; insulated; I <sub>N</sub> 76 A; light gray			
2-way	2016-402	25	
3-way	2016-403	25	
4-way	2016-404	25	
5-way	2016-405	25	

Protective warning marker; with black high-voltage symbol; for 5 terminal blocks			
yellow	2016-115	100 (25)	

Push-in type jumper bar; insulated; I <sub>N</sub> 76 A; light gray			
1 to 3	2016-433	25	
1 to 4	2016-434	25	
1 to 5	2016-435	25	

Finger guard; touch-proof cover protects unused conductor entries			
yellow	2016-100	100 (25)	

Star point jumper; insulated; I <sub>N</sub> = I <sub>N</sub> terminal block; light gray			
1-3-5	2016-405/011-000	25	

Modular connector; snaps together; for jumper contact slot			
gray	2016-511	50 (25)	

Step-down jumper; insulated; commons 16/10 mm <sup>2</sup> (8/10 AWG) to 10/6/4/2.5 mm <sup>2</sup> (8/10/12/14 AWG); I <sub>N</sub> 57 A			
light gray	2016-499	25	

Test plug adapter; for 4 mm Ø test plug			
gray	2009-174	100 (25)	

## Step-Down Jumpers TOPJOB® S Installation



Step-down jumpers (2006-499 and 2016-499)

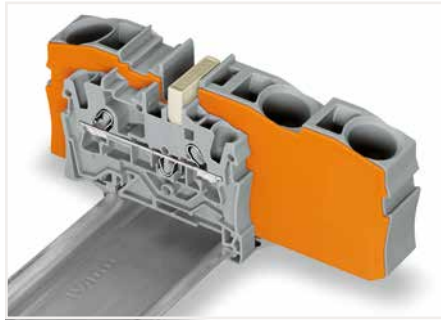

Step-down jumpers common terminal blocks of different sizes, without losing a conductor clamping point. This can be beneficial on long conductor runs where voltage drop can be a problem. A large conductor can be easily connected to smaller conductors at the distribution point. Commoning may be made in either direction using the special thin end plate to cover the open side. Additional through terminal blocks having a smaller cross-section may be commoned using push-in type jumper bars.



Using step-down jumpers, an end plate must be inserted between the terminal blocks to be commoned.

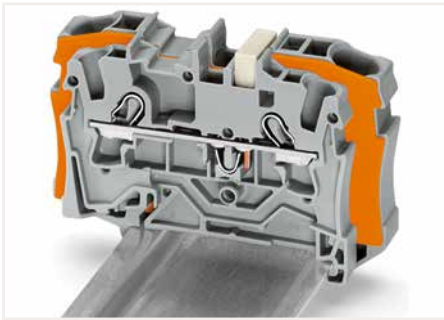

Step-down jumper (2006-499) commons 6/4 mm<sup>2</sup> (10/12 AWG) terminal blocks (2006/2004 Series) with 4/2.5/1.5 mm<sup>2</sup> (AWG 12/14/16) terminal blocks (2004/2002/2001 Series).

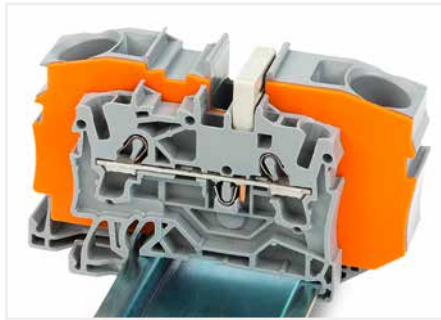

Step-down jumper (2016-499) commons 16/10 mm<sup>2</sup> (16/8 AWG) terminal blocks (2016/2010 Series) with 10/6/4/2.5 mm<sup>2</sup> (8/10/12/14 AWG) terminal blocks (2010/2006/2004/2002 Series).



**Stepping down via push-in type jumper bar:** Commoning via open terminal side with end plate allows jumpering over two cross-section sizes for 16 mm<sup>2</sup> (6 AWG) and 10 mm<sup>2</sup> (8 AWG) and one cross-section size for 6/4/2.5 mm<sup>2</sup> (10/12/14 AWG). An example: from 16 mm<sup>2</sup> (6 AWG) to 6 mm<sup>2</sup> (10 AWG) (see illustration above) or from 10 mm<sup>2</sup> (8 AWG) to 4 mm<sup>2</sup> (12 AWG).

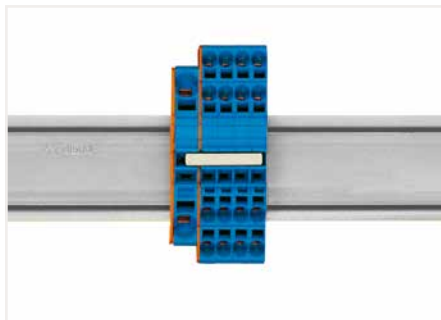

**Stepping down via push-in type jumper bar:** Commoning via closed terminal side with end plate allows jumpering over two cross-section sizes, e.g., from 16 mm<sup>2</sup> (6 AWG) to 6 mm<sup>2</sup> (10 AWG) or from 6 mm<sup>2</sup> (10 AWG) to 2.5 mm<sup>2</sup> (14 AWG) (see illustration above).



**Note:** The total current of the outgoing circuits must not exceed the nominal current of the step-down jumper/push-in type jumper bar.



## Double-Deck Terminal Block TOPJOB® S; with Push-Button; with Vertical Conductor Entry 2.5 (4) mm<sup>2</sup>; 2202 Series

### Technical Data

0.25 ... 2.5 (4) mm<sup>2</sup> ① | 22 ... 12 AWG

800 V/8 kV/3 ②

I<sub>N</sub> 24 A

Terminal block width: 5.2 mm / 0.205 inch

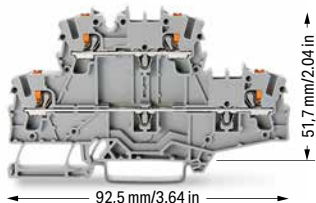
 10 ... 12 mm / 0.39 ... 0.47 inch

### Technical Data

0.25 ... 2.5 (4) mm<sup>2</sup> ① | 22 ... 12 AWG

800 V/8 kV/3 ②

I<sub>N</sub> 24 A

Terminal block width: 5.2 mm / 0.205 inch

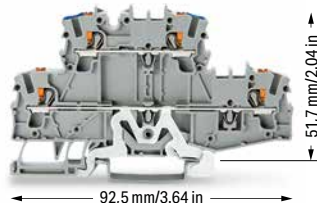
 10 ... 12 mm / 0.39 ... 0.47 inch

Double-deck terminal block; with push-button; Through/through terminal block; with vertical conductor entry; without marker carrier; gray

	Item No.	Pack. Unit
○ L/L	2202-2701	50
○ N/L	2202-2702	50
○ L/N	2202-2703	50

Double-deck terminal block; with push-button; Through/through terminal block; with vertical conductor entry; without marker carrier; blue

● N/N	2202-2704 ③	50
-------	-------------	----

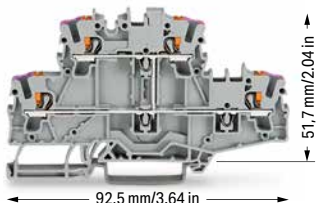

Double-deck terminal block; with push-button; 4-conductor through terminal block; with vertical conductor entry; without marker carrier; Internally commoned; violet conductor entry; gray

	Item No.	Pack. Unit
○ L	2202-2708	50

Double-deck terminal block; with push-button; 4-conductor through terminal block; with vertical conductor entry; without marker carrier; Internally commoned; violet conductor entry; blue

● N	2202-2709 ③	50
-----	-------------	----

Double-deck terminal block; with push-button; Ground conductor/through terminal block; with vertical conductor entry; without marker carrier; gray

	Item No.	Pack. Unit
○ GND/N	2202-2717	50
○ GND/L	2202-2727	50

Double-deck terminal block; with push-button; 4-conductor ground terminal block; with vertical conductor entry; without marker carrier; Internally commoned; green-yellow

● GND	2202-2707	50
-------	-----------	----



① Conductor range: 0.25 ... 4 mm<sup>2</sup> "s+f-st"  
Push-in termination: 1 ... 4 mm<sup>2</sup> "s" and 1 ... 2.5 mm<sup>2</sup> "insulated ferrules, 12 mm"  
Depending on the conductor characteristic, a conductor with a smaller cross section can also be inserted via push-in termination.

② 800 V = rated voltage  
8 kV = rated impulse voltage  
3 = pollution degree

③ Terminal blocks with a blue insulated housing are suitable for Ex i applications.

Please observe the application notes:



Jumpers, from page 160  
Testing accessories, page 159  
Marking, from page 246

Approvals and corresponding ratings, visit [www.wago.com](http://www.wago.com)

### Accessories; 2202 Series

Appropriate marking systems:  
WMB/WMB Inline/Marking strips

### End and intermediate plate; 0.8 mm thick

	orange	2002-2792	100 (25)
	gray	2002-2791	100 (25)

### Double-deck marker carrier; pivoting

	gray	2002-121	50 (25)
--	------	----------	---------









### Insulation stop; 5 pcs/strip; 0.25 ... 0.5 mm<sup>2</sup>

	light gray	2002-171	200 (25)
---	------------	----------	----------

### Insulation stop; 5 pcs/strip; 0.75 ... 1 mm<sup>2</sup>

	dark gray	2002-172	200 (25)
---	-----------	----------	----------



### Push-in type jumper bar; insulated; I<sub>N</sub> 25 A; light gray

	2-way	2002-402	25
	3-way	2002-403	25
	4-way	2002-404	25
	5-way	2002-405	25
	6-way	2002-406	25
	7-way	2002-407	25
	8-way	2002-408	25
	9-way	2002-409	25
	10-way	2002-410	25

### Push-in type jumper bar; insulated; I<sub>N</sub> 25 A; light gray

	1 to 3	2002-433	25
	1 to 4	2002-434	25
	1 to 5	2002-435	25
	1 to 6	2002-436	25
	1 to 7	2002-437	25
	1 to 8	2002-438	25
	1 to 9	2002-439	25
	1 to 10	2002-440	25

### Double-deck vertical jumper; insulated; I<sub>N</sub> 24 A

	light gray	2002-492	100 (25)
	orange	2002-492/000-012	100 (25)





## Double-Deck Terminal Block TOPJOB® S

### 1 (1.5) mm<sup>2</sup>; 2000 Series

#### Technical Data

0.14 ... 1 (1.5) mm <sup>2</sup> ①	24 ... 16 AWG
500 V/6 kV/3 ②	600 V, 10 A ③
I <sub>N</sub> 13.5 A (16 A)	
Terminal block width: 3.5 mm / 0.138 inch	
9 ... 11 mm / 0.35 ... 0.43 inch	

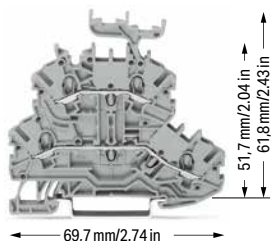

Double-deck terminal block; through/through terminal block; with marker carrier; gray

	Item No.	Pack. Unit
○ L/L	2000-2231	50
○ N/L	2000-2232	50
○ L/N	2000-2233	50

Double-deck terminal block; through/through terminal block; without marker carrier; gray

○ L/L	2000-2201	50
○ N/L	2000-2202	50
○ L/N	2000-2203	50

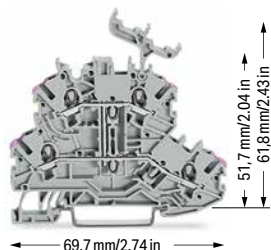

Double-deck terminal block; 4-conductor through terminal block; with marker carrier; internally commoded; violet conductor entry; gray

	Item No.	Pack. Unit
○ L	2000-2238	50

Double-deck terminal block; 4-conductor through terminal block; without marker carrier; internally commoded; violet conductor entry; gray

○ L	2000-2208	50
-----	-----------	----

#### Technical Data

0.14 ... 1 (1.5) mm <sup>2</sup> ①	24 ... 16 AWG
500 V/6 kV/3 ②	600 V, 10 A ③
I <sub>N</sub> 13.5 A (16 A)	
Terminal block width: 3.5 mm / 0.138 inch	
9 ... 11 mm / 0.35 ... 0.43 inch	

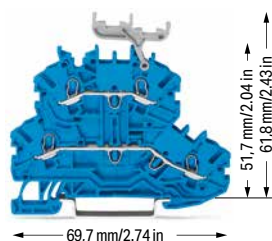

Double-deck terminal block; through/through terminal block; with marker carrier; blue

● N/N	2000-2234 ④	50
-------	-------------	----

Double-deck terminal block; through/through terminal block; without marker carrier; blue

● N/N	2000-2204 ④	50
-------	-------------	----

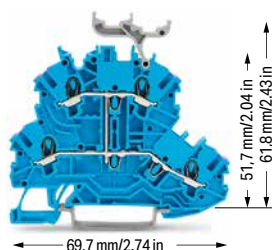

Double-deck terminal block; 4-conductor through terminal block; with marker carrier; internally commoded; violet conductor entry; blue

● N	2000-2239 ④	50
-----	-------------	----

Double-deck terminal block; 4-conductor through terminal block; without marker carrier; internally commoded; violet conductor entry; blue

● N	2000-2209 ④	50
-----	-------------	----

#### Technical Data

0.14 ... 1 (1.5) mm <sup>2</sup> ①	24 ... 16 AWG
500 V/6 kV/3 ②	600 V, 10 A ③
I <sub>N</sub> 13.5 A (16 A)	
Terminal block width: 3.5 mm / 0.138 inch	
9 ... 11 mm / 0.35 ... 0.43 inch	

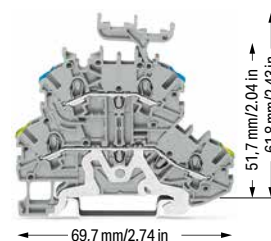

Double-deck terminal block; ground conductor/through terminal block; with marker carrier; blue

	Item No.	Pack. Unit
○ PE/N	2000-2247	50
○ PE/L	2000-2257	50

Double-deck terminal block; ground conductor/through terminal block; without marker carrier; gray

○ PE/N	2000-2217	50
○ PE/L	2000-2227	50

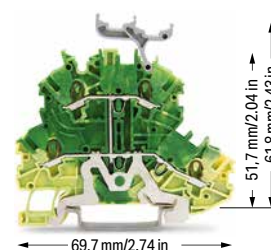

Double-deck terminal block; 4-conductor ground terminal block; with marker carrier; internally commoded; green-yellow

● PE	2000-2237	50
------	-----------	----

Double-deck terminal block; 4-conductor ground terminal block; without marker carrier; internally commoded; green-yellow

● PE	2000-2207	50
------	-----------	----

**Technical Data**

0.14 ... 1 (1.5) mm <sup>2</sup> ①	24 ... 16 AWG
500 V/6 kV/3 ②	600 V, 10 A ③
I <sub>N</sub> 13.5 A (16 A)	
Terminal block width: 3.5 mm / 0.138 inch	
9 ... 11 mm / 0.35 ... 0.43 inch	

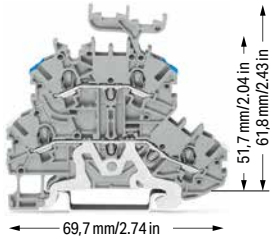

**Double-deck terminal block; shield/through terminal block; with marker carrier; gray**

	Item No.	Pack. Unit
○ Shield/N	2000-2248	50
○ Shield/L	2000-2258	50

**Double-deck terminal block; shield/through terminal block; without marker carrier; gray**

○ Shield/N	2000-2218	50
○ Shield/L	2000-2228	50

① Conductor range: 0.14 ... 1.5 mm<sup>2</sup> "s+f-st";  
Push-in termination: 0.5 ... 1.5 mm<sup>2</sup> "s" and  
0.5 ... 0.75 mm<sup>2</sup> "insulated ferrules; 10 mm"  
Depending on the conductor characteristic, a conductor  
with a smaller cross section can also be inserted  
via push-in termination.

② 800 V = rated voltage  
8 kV = rated impulse voltage  
3 = pollution degree

③ Terminal blocks with a blue insulated housing are  
suitable for Ex i applications.

Please observe the application notes:  
Jumpers, from page 160  
Testing accessories, page 159  
Marking, from page 246

Approvals and corresponding ratings,  
visit [www.wago.com](http://www.wago.com)

**Accessories; 2000 Series**

Appropriate marking systems:  
WMB/WMB Inline/Marking strips

**End and intermediate plate; 0.7 mm thick**

orange	2000-2292	25
gray	2000-2291	25

**Push-in type jumper bar; insulated; I<sub>N</sub> 14 A; light gray**

2-way	2000-402	25
3-way	2000-403	25
4-way	2000-404	25
5-way	2000-405	25
6-way	2000-406	25
7-way	2000-407	25
8-way	2000-408	25
9-way	2000-409	25
10-way	2000-410	25

**Push-in type jumper bar; insulated; I<sub>N</sub> 14 A; light gray**

1 to 3	2000-433	25
1 to 4	2000-434	25
1 to 5	2000-435	25
1 to 6	2000-436	25
1 to 7	2000-437	25
1 to 8	2000-438	25
1 to 9	2000-439	25
1 to 10	2000-440	25

**Double-deck vertical jumper; insulated; I<sub>N</sub> 13.5 A**

light gray	2000-492	100 (25)
------------	----------	----------

**Protective warning marker; with black high-voltage  
symbol; for 5 terminal blocks**

yellow	2000-115	100 (25)
--------	----------	----------

**Test plug adapter; for 4 mm Ø test plug**

gray	2009-174	100 (25)
------	----------	----------

**Banana plug; for 4 mm socket diameter; color mixed; 10 x  
orange, white, black, blue, yellow; max. 42 V**

215-111	50
---------	----

**Testing tap; for max. 2.5 mm<sup>2</sup>**

gray	2009-182	100 (25)
------	----------	----------

**Accessories; 2000 Series**

Appropriate marking systems:  
WMB/WMB Inline/Marking strips

**WMB Inline; plain; 2,300 WMB markers (3.5 mm)/reel**

white	2009-113	1
-------	----------	---

**WMB marking card; white; 10 strips with 10 markers/card;  
for 3.5 mm terminal block width**

plain	793-3501	5
-------	----------	---

**Marking strip; plain; 11 mm wide; 50 m reel**

white	2009-110	1
-------	----------	---

**Double-deck marker carrier; pivoting**

gray	2000-121	50 (25)
------	----------	---------



**Double-deck terminal blocks:**  
A double-deck marker carrier (2000-121) can be retrofitted  
to double-deck terminal blocks without a marker carrier.

# Double-Deck Terminal Block TOPJOB® S; with End Plate; 800 V 1 (1.5) mm<sup>2</sup>; 2000 Series

Technical Data	
0.14 ... 1 (1.5) mm <sup>2</sup> ①	24 ... 16 AWG
800 V/8 kV/3 ②	600 V, 10 A ③
I <sub>N</sub> 13.5 A (16 A)	
Terminal block width: 4.2 mm / 0.165 inch	
9 ... 11 mm / 0.35 ... 0.43 inch	

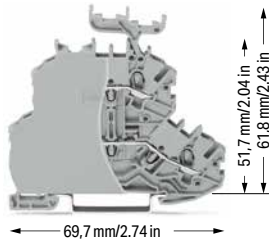

Double-deck terminal block; through/through terminal block; with end plate; with marker carrier; gray

	Item No.	Pack. Unit
○ L/L	2000-2231/099-000	50
○ N/L	2000-2232/099-000	50
○ L/N	2000-2233/099-000	50

Double-deck terminal block; through/through terminal block; with end plate; without marker carrier; gray

○ L/L	2000-2201/099-000	50
○ N/L	2000-2202/099-000	50
○ L/N	2000-2203/099-000	50

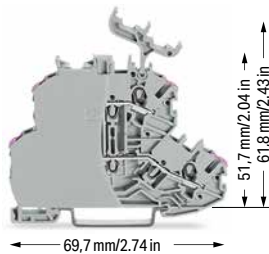

Double-deck terminal block; 4-conductor through terminal block; with end plate; with marker carrier; internally commoned; violet conductor entry; gray

	Item No.	Pack. Unit
○ L	2000-2238/099-000	50

Double-deck terminal block; 4-conductor through terminal block; with end plate; without marker carrier; internally commoned; violet conductor entry; gray

○ L	2000-2208/099-000	50
-----	-------------------	----

Technical Data	
0.14 ... 1 (1.5) mm <sup>2</sup> ①	24 ... 16 AWG
800 V/8 kV/3 ②	600 V, 10 A ③
I <sub>N</sub> 13.5 A (16 A)	
Terminal block width: 4.2 mm / 0.165 inch	
9 ... 11 mm / 0.35 ... 0.43 inch	

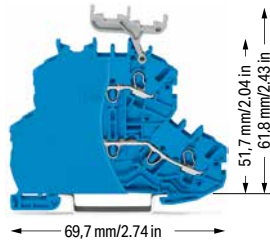

Double-deck terminal block; through/through terminal block; with end plate; with marker carrier; blue

● N/N	2000-2234/099-000 ③	50
-------	---------------------	----

Double-deck terminal block; through/through terminal block; with end plate; without marker carrier; blue

● N/N	2000-2204/099-000 ③	50
-------	---------------------	----

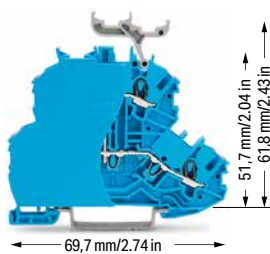

Double-deck terminal block; 4-conductor through terminal block; with end plate; with marker carrier; internally commoned; violet conductor entry; blue

● N	2000-2239/099-000 ③	50
-----	---------------------	----

Double-deck terminal block; 4-conductor through terminal block; with end plate; without marker carrier; internally commoned; violet conductor entry; blue

● N	2000-2209/099-000 ③	50
-----	---------------------	----

Technical Data	
0.14 ... 1 (1.5) mm <sup>2</sup> ①	24 ... 16 AWG
800 V/8 kV/3 ②	600 V, 10 A ③
I <sub>N</sub> 13.5 A (16 A)	
Terminal block width: 4.2 mm / 0.165 inch	
9 ... 11 mm / 0.35 ... 0.43 inch	

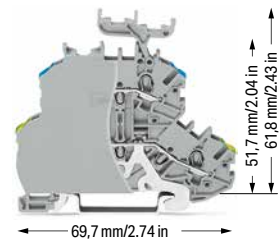

Double-deck terminal block; ground conductor/through terminal block; with end plate; with marker carrier; gray

	Item No.	Pack. Unit
○ PE/N	2000-2247/099-000	50
○ PE/L	2000-2257/099-000	50

Double-deck terminal block; ground conductor/through terminal block; with end plate; without marker carrier; gray

○ PE/N	2000-2217/099-000	50
○ PE/L	2000-2227/099-000	50

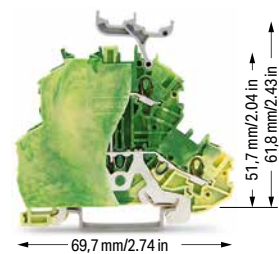

Double-deck terminal block; 4-conductor ground terminal block; with end plate; with marker carrier; internally commoned; green-yellow

● PE	2000-2237/099-000	50
------	-------------------	----

Double-deck terminal block; 4-conductor ground terminal block; with end plate; without marker carrier; internally commoned; green-yellow

● PE	2000-2207/099-000	50
------	-------------------	----

Sold & Serviced By:



Toll Free Phone (877) SERV098  
www.electromate.com  
sales@electromate.com

## Technical Data

0.14 ... 1 (1.5) mm<sup>2</sup> ① | 24 ... 16 AWG

800 V/8 kV/3 ② | 600 V, 10 A ③

I<sub>N</sub> 13.5 A (16 A)

Terminal block width: 4.2 mm / 0.165 inch

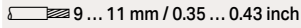
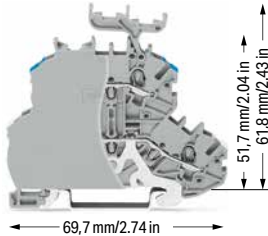
 9 ... 11 mm / 0.35 ... 0.43 inch

Double-deck terminal block; shield/through terminal block; with end plate; with marker carrier; gray

	Item No.	Pack. Unit
○ Shield/N	2000-2248/099-000	50
○ Shield/L	2000-2258/099-000	50

Double-deck terminal block; shield/through terminal block; with end plate; without marker carrier; gray

	Item No.	Pack. Unit
○ Shield/N	2000-2218/099-000	50
○ Shield/L	2000-2228/099-000	50

① Conductor range: 0.14 ... 1.5 mm<sup>2</sup> "s+f-st";  
Push-in termination: 0.5 ... 1.5 mm<sup>2</sup> "s" and  
0.5 ... 0.75 mm<sup>2</sup> "insulated ferrules; 10 mm"  
Depending on the conductor characteristic, a conductor  
with a smaller cross section can also be inserted  
via push-in termination.

② 800 V = rated voltage  
8 kV = rated impulse voltage  
3 = pollution degree

③ Terminal blocks with a blue insulated housing are  
suitable for Ex i applications.

Please observe the application notes:  
Jumpers, from page 165  
Testing accessories, page 159  
Marking, from page 246

Approvals and corresponding ratings,  
visit [www.wago.com](http://www.wago.com)

## Accessories; 2000 Series

Appropriate marking systems:  
WMB/WMB Inline/Marking strips

## End and intermediate plate; 0.7 mm thick

orange	2000-2292	25
gray	2000-2291	25

Push-in type jumper bar; insulated; I<sub>N</sub> 18 A; light gray

2-way	2001-402	25
3-way	2001-403	25
4-way	2001-404	25
5-way	2001-405	25
6-way	2001-406	25
7-way	2001-407	25
8-way	2001-408	25
9-way	2001-409	25
10-way	2001-410	25

Push-in type jumper bar; insulated; I<sub>N</sub> 18 A; light gray

1 to 3	2001-433	25
1 to 4	2001-434	25
1 to 5	2001-435	25
1 to 6	2001-436	25
1 to 7	2001-437	25
1 to 8	2001-438	25
1 to 9	2001-439	25
1 to 10	2001-440	25

Double-deck vertical jumper; insulated; I<sub>N</sub> 13.5 A

light gray	2000-492	100 (25)
------------	----------	----------

Protective warning marker; with black high-voltage  
symbol; for 5 terminal blocks

yellow	2001-115	100 (25)
--------	----------	----------

## Test plug adapter; for 4 mm Ø test plug

gray	2009-174	100 (25)
------	----------	----------

Banana plug; for 4 mm socket diameter; color mixed; 10 x  
orange, white, black, blue, yellow; max. 42 V

	215-111	50
--	---------	----

Testing tap; for max. 2.5 mm<sup>2</sup>

gray	2009-182	100 (25)
------	----------	----------

## Accessories; 2000 Series

Appropriate marking systems:  
WMB/WMB Inline/Marking strips

WMB Inline; plain; 2,000 WMB markers (4 mm)/reel;  
4 ... 4.2 mm stretchable

white	2009-114	1
-------	----------	---

WMB marking card; white; 10 strips with 10 markers/card;  
4 ... 4.2 mm stretchable

plain	793-4501	5
-------	----------	---

WMB marking card; plain; 10 strips with 10 markers/card;  
4 ... 4.2 mm stretchable

yellow	793-4501/000-002	5
red	793-4501/000-005	5
blue	793-4501/000-006	5
gray	793-4501/000-007	5
orange	793-4501/000-012	5
light green	793-4501/000-017	5
green	793-4501/000-023	5
violet	793-4501/000-024	5

## Marking strip; plain; 11 mm wide; 50 m reel

white	2009-110	1
-------	----------	---

## Double-deck marker carrier; pivoting

gray	2000-121	50 (25)
------	----------	---------



## Double-deck terminal blocks:

A double-deck marker carrier (2000-121) can be retrofitted  
to double-deck terminal blocks without a marker carrier.



## Double-Deck Terminal Block TOPJOB® S

### 2.5 (4) mm<sup>2</sup>; 2002 Series

#### Technical Data

0.25 ... 2.5 (4) mm<sup>2</sup> ① 22 ... 12 AWG

500 V/6 kV/3 ② 600 V, 20 A ③

I<sub>N</sub> 24 A (28 A) 600 V, 20 A ④

Terminal block width: 5.2 mm / 0.205 inch

 10 ... 12 mm / 0.39 ... 0.47 inch

#### Technical Data

0.25 ... 2.5 (4) mm<sup>2</sup> ① 22 ... 12 AWG

500 V/6 kV/3 ② 600 V, 20 A ③

I<sub>N</sub> 24 A (28 A) 600 V, 20 A ④

Terminal block width: 5.2 mm / 0.205 inch

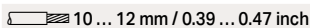
 10 ... 12 mm / 0.39 ... 0.47 inch

#### Technical Data

0.25 ... 2.5 (4) mm<sup>2</sup> ① 22 ... 12 AWG

500 V/6 kV/3 ② 600 V, 20 A ③

I<sub>N</sub> 24 A (28 A) 600 V, 20 A ④

Terminal block width: 5.2 mm / 0.205 inch

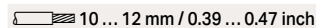
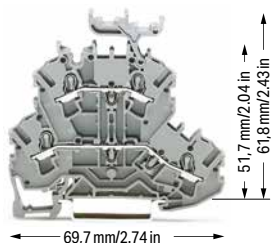
 10 ... 12 mm / 0.39 ... 0.47 inch

Double-deck terminal block; through/through terminal block; with marker carrier; gray

	Item No.	Pack. Unit
○ L/L ⑤	2002-2231 ④	50
○ N/L ⑤	2002-2232 ④	50
○ L/N ⑤	2002-2233 ④	50

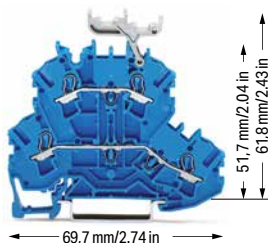

Double-deck terminal block; through/through terminal block; with marker carrier; blue

	Item No.	Pack. Unit
● N/N ⑤	2002-2234 ③ ④	50

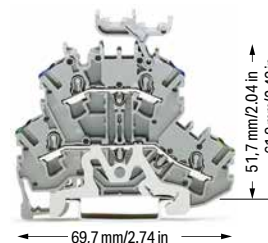

Double-deck terminal block; ground conductor/through terminal block; with marker carrier; blue

	Item No.	Pack. Unit
○ PE/N ⑤	2002-2247 ④	50
○ PE/L ⑤	2002-2257 ④	50

Double-deck terminal block; through/through terminal block; without marker carrier; gray

○ L/L ⑤	2002-2201 ④	50
○ N/L ⑤	2002-2202 ④	50
○ L/N ⑤	2002-2203 ④	50

Double-deck terminal block; through/through terminal block; without marker carrier; blue

● N/N ⑤	2002-2204 ③ ④	50
---------	---------------	----

Double-deck terminal block; ground conductor/through terminal block; without marker carrier; gray

○ PE/N ⑤	2002-2217 ④	50
○ PE/L ⑤	2002-2227 ④	50

#### Other terminal blocks with the same profile:

Diode 2002-2211/1000-410 Page 148

LED 2002-2221/1000-434 Page 148

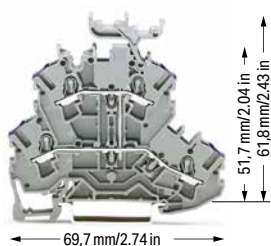

Double-deck terminal block; 4-conductor through terminal block; with marker carrier; internally commoned; violet conductor entry; gray

	Item No.	Pack. Unit
○ L ⑤	2002-2238 ④	50

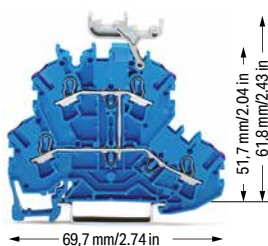

Double-deck terminal block; 4-conductor through terminal block; with marker carrier; internally commoned; violet conductor entry; blue

	Item No.	Pack. Unit
● N ⑤	2002-2239 ③ ④	50

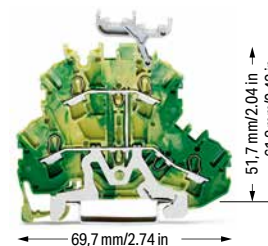

Double-deck terminal block; 4-conductor ground terminal block; with marker carrier; internally commoned; green-yellow

	Item No.	Pack. Unit
● PE ⑤	2002-2237 ④	50

Double-deck terminal block; 4-conductor through terminal block; without marker carrier; internally commoned; violet conductor entry; gray

○ L ⑤	2002-2208 ④	50
-------	-------------	----

Double-deck terminal block; 4-conductor through terminal block; without marker carrier; internally commoned; violet conductor entry; blue

● N ⑤	2002-2209 ③ ④	50
-------	---------------	----

Double-deck terminal block; 4-conductor ground terminal block; without marker carrier; internally commoned; green-yellow

● PE ⑤	2002-2207 ④	50
--------	-------------	----

**Technical Data**

0.25 ... 2.5 (4) mm <sup>2</sup> ①	22 ... 12 AWG
500 V/6 kV/3 ②	600 V, 20 A ③
I <sub>N</sub> 24 A (28 A)	600 V, 20 A ④
Terminal block width: 5.2 mm / 0.205 inch	
 10 ... 12 mm / 0.39 ... 0.47 inch	

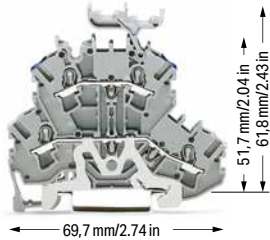

Double-deck terminal block; shield/through terminal block; with marker carrier; gray

	Item No.	Pack. Unit
○ Shield/N	2002-2248	50
○ Shield/L	2002-2258	50

Double-deck terminal block; shield/through terminal block; without marker carrier; gray

○ Shield/N	2002-2218	50
○ Shield/L	2002-2228	50

- Conductor range: 0.25 ... 4 mm<sup>2</sup> "s+f-st"; Push-in termination: 1 ... 4 mm<sup>2</sup> "s" and 1 ... 2.5 mm<sup>2</sup> "insulated ferrules, 12 mm" Depending on the conductor characteristic, a conductor with a smaller cross section can also be inserted via push-in termination.
- 500 V = rated voltage  
6 kV = rated impulse voltage  
3 = pollution degree
- Terminal blocks with a blue insulated housing are suitable for Ex i applications.
- Terminal blocks with an Ex mark are suitable for Ex e II applications.  
440 V; 20 A  
18 A jumper

Please observe the application notes:  
Jumpers, from page 160  
Testing accessories, page 159  
Marking, from page 246

Approvals and corresponding ratings, visit [www.wago.com](http://www.wago.com)

**Accessories; 2002 Series**

Appropriate marking systems:  
WMB/WMB Inline/Marking strips

**End and intermediate plate; 0.8 mm thick**

orange	2002-2292	100 (25)
gray	2002-2291	100 (25)

**Ex e/Ex i separator; orange; 3 mm thick**

125.5 mm	209-192	50 (25)
----------	---------	---------

**Separator plate; oversized upper deck; snap-on type; 2 mm thick**

orange	2002-2296	100 (25)
gray	2002-2295	100 (25)

**Insulation stop; 5 pcs/strip; 0.25 ... 0.5 mm<sup>2</sup>**

light gray	2002-171	200 (25)
------------	----------	----------

**Insulation stop; 5 pcs/strip; 0.75 ... 1 mm<sup>2</sup>**

dark gray	2002-172	200 (25)
-----------	----------	----------

**Push-in type jumper bar; insulated; I<sub>N</sub> 25 A; light gray**

2-way	2002-402	25
3-way	2002-403	25
4-way	2002-404	25
5-way	2002-405	25
6-way	2002-406	25
7-way	2002-407	25
8-way	2002-408	25
9-way	2002-409	25
10-way	2002-410	25

**Push-in type jumper bar; insulated; I<sub>N</sub> 25 A; light gray**

1 to 3	2002-433	25
1 to 4	2002-434	25
1 to 5	2002-435	25
1 to 6	2002-436	25
1 to 7	2002-437	25
1 to 8	2002-438	25
1 to 9	2002-439	25
1 to 10	2002-440	25

**Accessories; 2002 Series**

Appropriate marking systems:  
WMB/WMB Inline/Marking strips

**Double-deck vertical jumper; insulated; I<sub>N</sub> 24 A**

light gray	2002-492	100 (25)
orange	2002-492/000-012	100 (25)

**Double-deck marker carrier; pivoting**

gray	2002-121	50 (25)
------	----------	---------

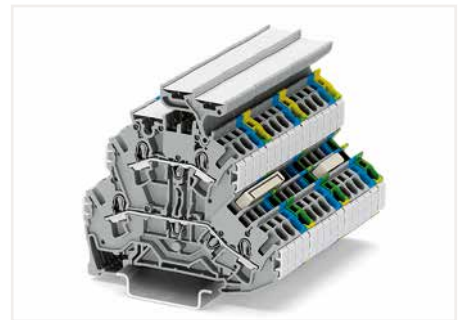

Double-deck terminal block assembly

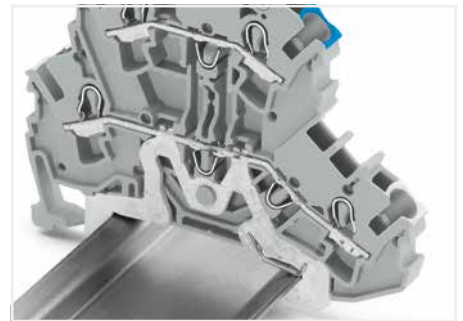

Both ground and shield conductor terminal blocks have a contact foot in the bottom level, automatically establishing direct contact to the DIN-rail or busbar. The flexible double-deck marker carrier, which is placed above the wiring level, can be pushed aside during wiring. The carrier has two staggered levels for WMB markers that perfectly align with the terminal block decks. With a terminal block width of just 5.2 mm, an effective width of just 2.6 mm for terminal blocks of same or different potentials can be realized for conductors ranging 0.25 mm<sup>2</sup> ... 4 mm<sup>2</sup> (22 ... 12 AWG). Shielded control cables are becoming an increasingly common solution to external signal interference. Front-entry shield conductor terminal blocks are ideal for connecting braided cables. Like front-entry ground conductor terminal blocks, they are equipped with a grounding foot for direct electrical connection to the rail, however they differ significantly by their white insulated housing. Shield conductor terminal blocks for front-entry wiring can be directly mounted beside signal-conductor terminal blocks, providing excellent deflection of interfering signals.

## Double-Deck Terminal Block TOPJOB® S; with End Plate; 800 V 2.5 (4) mm<sup>2</sup>; 2002 Series

### Technical Data

0.25 ... 2.5 (4) mm <sup>2</sup> ①	22 ... 12 AWG
800 V/8 kV/3 ②	600 V, 20 A ③
I <sub>N</sub> 24 A	600 V, 20 A ④

Terminal block width: 6.2 mm / 0.244 inch

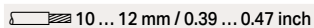
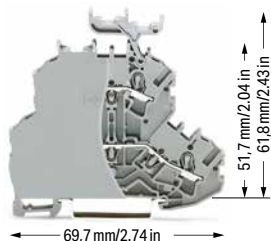
 10 ... 12 mm / 0.39 ... 0.47 inch

Double-deck terminal block; through/through terminal block; with end plate; with marker carrier; gray

	Item No.	Pack. Unit
<input type="radio"/> L/L	2002-2231/099-000	50
<input type="radio"/> N/L	2002-2232/099-000	50
<input type="radio"/> L/N	2002-2233/099-000	50

Double-deck terminal block; through/through terminal block; with end plate; without marker carrier; gray

<input type="radio"/> L/L	2002-2201/099-000	50
<input type="radio"/> N/L	2002-2202/099-000	50
<input type="radio"/> L/N	2002-2203/099-000	50

### Other terminal blocks with the same profile:

Diode	2002-2211/1000-410	Page 148
LED	2002-2221/1000-434	Page 148

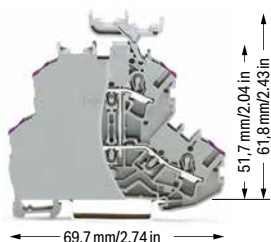

Double-deck terminal block; 4-conductor through terminal block; with end plate; with marker carrier; internally commoned; violet conductor entry; gray

	Item No.	Pack. Unit
<input type="radio"/> L	2002-2238/099-000	50

Double-deck terminal block; 4-conductor through terminal block; with end plate; without marker carrier; internally commoned; violet conductor entry; gray

<input type="radio"/> L	2002-2208/099-000	50
-------------------------	-------------------	----

### Technical Data

0.25 ... 2.5 (4) mm <sup>2</sup> ①	22 ... 12 AWG
800 V/8 kV/3 ②	600 V, 20 A ③
I <sub>N</sub> 24 A	600 V, 20 A ④

Terminal block width: 6.2 mm / 0.244 inch

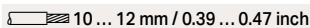
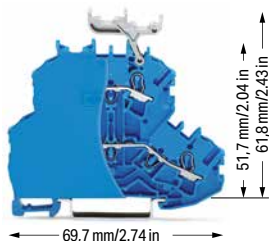
 10 ... 12 mm / 0.39 ... 0.47 inch

Double-deck terminal block; through/through terminal block; with end plate; with marker carrier; blue

<input checked="" type="radio"/> N/N	2002-2234/099-000 ⑤	50
--------------------------------------	---------------------	----

Double-deck terminal block; through/through terminal block; with end plate; without marker carrier; blue

<input checked="" type="radio"/> N/N	2002-2204/099-000 ⑤	50
--------------------------------------	---------------------	----

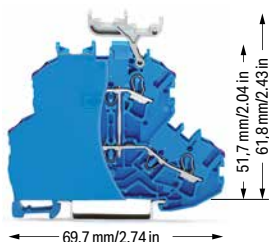

Double-deck terminal block; 4-conductor through terminal block; with end plate; with marker carrier; internally commoned; violet conductor entry; blue

	Item No.	Pack. Unit
<input checked="" type="radio"/> N	2002-2239/099-000 ⑤	50

Double-deck terminal block; 4-conductor through terminal block; with end plate; without marker carrier; internally commoned; violet conductor entry; blue

<input checked="" type="radio"/> N	2002-2209/099-000 ①	50
------------------------------------	---------------------	----

### Technical Data

0.25 ... 2.5 (4) mm <sup>2</sup> ①	22 ... 12 AWG
800 V/8 kV/3 ②	600 V, 20 A ③
I <sub>N</sub> 24 A	600 V, 20 A ④

Terminal block width: 6.2 mm / 0.244 inch

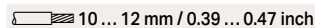
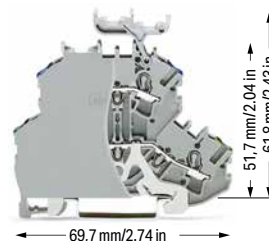
 10 ... 12 mm / 0.39 ... 0.47 inch

Double-deck terminal block; ground conductor/through terminal block; with end plate; with marker carrier; gray

	Item No.	Pack. Unit
<input type="radio"/> PE/N	2002-2247/099-000	50
<input type="radio"/> PE/L	2002-2257/099-000	50

Double-deck terminal block; ground conductor/through terminal block; with end plate; without marker carrier; gray

<input type="radio"/> PE/N	2002-2217/099-000	50
<input type="radio"/> PE/L	2002-2227/099-000	50

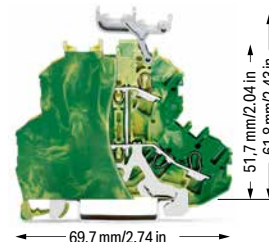

Double-deck terminal block; 4-conductor ground terminal block; with end plate; with marker carrier; internally commoned; green-yellow

	Item No.	Pack. Unit
<input checked="" type="radio"/> PE	2002-2237/099-000	50

Double-deck terminal block; 4-conductor ground terminal block; with end plate; without marker carrier; internally commoned; green-yellow

<input checked="" type="radio"/> PE	2002-2207/099-000	50
-------------------------------------	-------------------	----

## Technical Data

0.25 ... 2.5 (4) mm <sup>2</sup> ①	22 ... 12 AWG
800 V/8 kV/3 ②	600 V, 20 A ③
I <sub>N</sub> 24 A	600 V, 20 A ③
Terminal block width: 6.2 mm / 0.244 inch	
 10 ... 12 mm / 0.39 ... 0.47 inch	

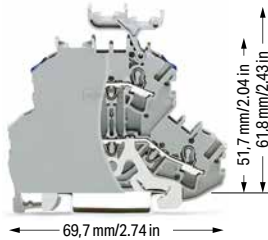

Double-deck terminal block; shield/through terminal block; with end plate; with marker carrier; gray

	Item No.	Pack. Unit
○ Shield/N	2002-2248/099-000	50
○ Shield/L	2002-2258/099-000	50

Double-deck terminal block; shield/through terminal block; with end plate; without marker carrier; gray

○ Shield/N	2002-2218/099-000	50
○ Shield/L	2002-2228/099-000	50

① Conductor range: 0.25 ... 4 mm<sup>2</sup> "s+f-st";  
Push-in termination: 1 ... 4 mm<sup>2</sup> "s" and 1 ... 2.5 mm<sup>2</sup> "insulated ferrules, 12 mm"  
Depending on the conductor characteristic, a conductor with a smaller cross section can also be inserted via push-in termination.

② 800 V = rated voltage  
8 kV = rated impulse voltage  
3 = pollution degree

③ Terminal blocks with a blue insulated housing are suitable for Ex i applications.

Please observe the application notes:  
Jumpers, from page 165  
Testing accessories, page 159  
Marking, from page 246

A protective warning marker and an insulation stop must be applied individually. Due to the 6.2 mm width of double-deck terminal blocks with end plates, 2004 Series Push-In Type Jumper Bars must be used.

Approvals and corresponding ratings, visit [www.wago.com](http://www.wago.com)

## Accessories; 2002 Series

Appropriate marking systems:  
WMB/Marking strips

## End and intermediate plate; 0.8 mm thick

 orange	2002-2292	100 (25)
 gray	2002-2291	100 (25)

Insulation stop; 5 pcs/strip; 0.25 ... 0.5 mm<sup>2</sup>

 light gray	2002-171	200 (25)
--	----------	----------

Insulation stop; 5 pcs/strip; 0.75 ... 1 mm<sup>2</sup>

 dark gray	2002-172	200 (25)
---	----------	----------

Push-in type jumper bar; insulated; I<sub>N</sub> 32 A; light gray

 2-way	2004-402	25
3-way	2004-403	25
4-way	2004-404	25
5-way	2004-405	25
6-way	2004-406	25
7-way	2004-407	25
8-way	2004-408	25
9-way	2004-409	25
10-way	2004-410	25

Push-in type jumper bar; insulated; I<sub>N</sub> 32 A; light gray

 1 to 3	2004-433	25
1 to 4	2004-434	25
1 to 5	2004-435	25
1 to 6	2004-436	25
1 to 7	2004-437	25
1 to 8	2004-438	25
1 to 9	2004-439	25
1 to 10	2004-440	25

Double-deck vertical jumper; insulated; I<sub>N</sub> 24 A

 light gray	2002-492	100 (25)
orange	2002-492/000-012	100 (25)

## Protective warning marker; with black high-voltage symbol; for 5 terminal blocks

 yellow	2002-115	100 (25)
--	----------	----------

## Accessories; 2002 Series

Appropriate marking systems:  
WMB/Marking strips

## Test plug adapter; for 4 mm Ø test plug

 gray	2009-174	100 (25)
--	----------	----------

Banana plug; for 4 mm socket diameter; color mixed; 10 x orange, white, black, blue, yellow; max. 42 V

	215-111	50
---	---------	----

WMB marking card; white; 10 strips with 10 markers/card; 5 ... 5.2 mm stretchable

 plain	793-5501	5
---	----------	---

WMB marking card; plain; 10 strips with 10 markers/card; 5 ... 5.2 mm stretchable

 yellow	793-5501/000-002	5
red	793-5501/000-005	5
blue	793-5501/000-006	5
gray	793-5501/000-007	5
orange	793-5501/000-012	5
light green	793-5501/000-017	5
green	793-5501/000-023	5
violet	793-5501/000-024	5

## Marking strip; plain; 11 mm wide; 50 m reel

 white	2009-110	1
---	----------	---

## Double-deck marker carrier; pivoting

 gray	2002-121	50 (25)
--	----------	---------

## Double-Deck Terminal Block TOPJOB® S

### 2.5 (4) mm<sup>2</sup>; 2002 Series

#### Technical Data

0.25 ... 2.5 (4) mm<sup>2</sup> ① | 22 ... 12 AWG

1000 VAC/DC / 1500 VDC / 12 kV / 3 ②

I<sub>N</sub> 24 A

Terminal block width: 7.2 mm / 0.283 inch

 10 ... 12 mm / 0.39 ... 0.47 inch

#### Technical Data

0.25 ... 2.5 (4) mm<sup>2</sup> ① | 22 ... 12 AWG

1000 VAC/DC / 1500 VDC / 12 kV / 3 ②

I<sub>N</sub> 24 A

Terminal block width: 7.2 mm / 0.283 inch

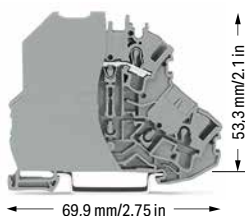
 10 ... 12 mm / 0.39 ... 0.47 inch

Double-deck terminal block; contact insert only on upper deck; gray separator plate; oversized; gray

	Item No.	Pack. Unit
○ L	2002-2201/097-000	50

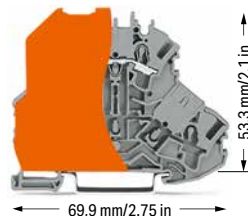

Double-deck terminal block; contact insert only on upper deck; orange separator plate; oversized; gray

	Item No.	Pack. Unit
○ L	2002-2201/098-000	50

#### Accessories; 2002 Series

Appropriate marking systems: WMB/Marking strips

Insulation stop; 5 pcs/strip; 0.25 ... 0.5 mm<sup>2</sup>

light gray 2002-171 200 (25)

Insulation stop; 5 pcs/strip; 0.75 ... 1 mm<sup>2</sup>

dark gray 2002-172 200 (25)



Protective warning marker; with black high-voltage symbol; for 5 terminal blocks

yellow 2002-115 100 (25)



Test plug adapter; for 4 mm Ø test plug

gray 2009-174 100 (25)



Banana plug; for 4 mm socket diameter; color mixed; 10 x orange, white, black, blue, yellow; max. 42 V

215-111 50

Testing tap; for max. 2.5 mm<sup>2</sup>

gray 2009-182 100 (25)



WMB marking card; white; 10 strips with 10 markers/card; 5 ... 5.2 mm stretchable

plain 793-5501 5



WMB marking card; plain; 10 strips with 10 markers/card; 5 ... 5.2 mm stretchable

yellow 793-5501/000-002 5

red 793-5501/000-005 5

blue 793-5501/000-006 5

gray 793-5501/000-007 5

orange 793-5501/000-012 5

light green 793-5501/000-017 5

green 793-5501/000-023 5

violet 793-5501/000-024 5

Marking strip; plain; 11 mm wide; 50 m reel

white 2009-110 1



Double-deck marker carrier; pivoting

gray 2002-121 50 (25)



① Conductor range: 0.25 ... 4 mm<sup>2</sup> "s+f-st";  
Push-in termination: 1 ... 4 mm<sup>2</sup> "s" and 1 ... 2.5 mm<sup>2</sup> "insulated ferrules, 12 mm"  
Depending on the conductor characteristic, a conductor with a smaller cross section can also be inserted via push-in termination.

② 1000 VAC/DC = rated voltage  
1500 VDC  
12 kV = rated impulse voltage  
3 = pollution degree

Please observe the application notes:  
Testing accessories, page 159  
Marking, from page 246

A protective warning marker and an insulation stop must be applied individually.

Approvals and corresponding ratings,  
visit [www.wago.com](http://www.wago.com)



## Double-Deck Terminal Block TOPJOB® S; with Vertical Conductor Entry 2.5 (4) mm<sup>2</sup>; 2002 Series

### Technical Data

0.25 ... 2.5 (4) mm<sup>2</sup> ① | 22 ... 12 AWG

800 V/8 kV/3 ②

I<sub>N</sub> 24 A (28 A)

Terminal block width: 5.2 mm / 0.205 inch

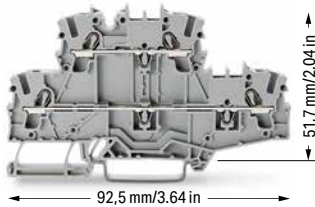
 10 ... 12 mm / 0.39 ... 0.47 inch

Double-deck terminal block; through/through terminal block; with vertical conductor entry; without marker carrier; gray

	Item No.	Pack. Unit
○ L/L ③	2002-2701 ④	50
○ N/L ③	2002-2702 ④	50
○ L/N ③	2002-2703 ④	50

Double-deck terminal block; through/through terminal block; with vertical conductor entry; without marker carrier; blue

● N/N ③	2002-2704 ④ ⑤	50
---------	---------------	----

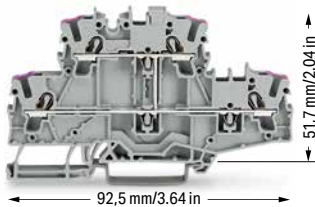

Double-deck terminal block; 4-conductor through terminal block; with vertical conductor entry; without marker carrier; internally commoned; violet conductor entry; gray

	Item No.	Pack. Unit
○ L ③	2002-2708 ④	50

Double-deck terminal block; 4-conductor through terminal block; with vertical conductor entry; without marker carrier; internally commoned; violet conductor entry; blue

● N ③	2002-2709 ④ ⑤	50
-------	---------------	----

### Technical Data

0.25 ... 2.5 (4) mm<sup>2</sup> ① | 22 ... 12 AWG

800 V/8 kV/3 ②

I<sub>N</sub> 24 A (28 A)

Terminal block width: 5.2 mm / 0.205 inch

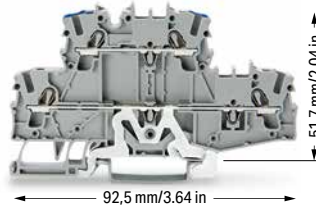
 10 ... 12 mm / 0.39 ... 0.47 inch

Double-deck terminal block; ground conductor/through terminal block; with vertical conductor entry; without marker carrier; gray

	Item No.	Pack. Unit
○ PE/N ③	2002-2717 ④	50
○ PE/L ③	2002-2727 ④	50

Double-deck terminal block; 4-conductor ground terminal block; with vertical conductor entry; without marker carrier; internally commoned; green-yellow

	Item No.	Pack. Unit
● PE	2002-2707	50
● PE ③	2002-2707/999-950 ④	50

① Conductor range: 0.25 ... 4 mm<sup>2</sup> "s+f-st"; Push-in termination: 1 ... 4 mm<sup>2</sup> "s" and 1 ... 2.5 mm<sup>2</sup> "insulated ferrules, 12 mm"  
Depending on the conductor characteristic, a conductor with a smaller cross section can also be inserted via push-in termination.

② 800 V = rated voltage  
8 kV = rated impulse voltage  
3 = pollution degree

③ Terminal blocks with a blue insulated housing are suitable for Ex i applications.

④ Terminal blocks with an Ex mark are suitable for Ex e II applications.  
440 V; 20 A  
18 A jumper



Please observe the application notes:  
Jumpers, from page 160  
Testing accessories, page 159  
Marking, from page 246

Approvals and corresponding ratings, visit [www.wago.com](http://www.wago.com)

### Accessories; 2002 Series

Appropriate marking systems:  
WMB/WMB Inline/Marking strips

#### End and intermediate plate; 0.8 mm thick

	orange	2002-2792	100 (25)
	gray	2002-2791	100 (25)

#### Double-deck marker carrier; pivoting

	gray	2002-121	50 (25)
---	------	----------	---------

#### Insulation stop; 5 pcs/strip; 0.25 ... 0.5 mm<sup>2</sup>

	light gray	2002-171	200 (25)
---	------------	----------	----------

#### Insulation stop; 5 pcs/strip; 0.75 ... 1 mm<sup>2</sup>

	dark gray	2002-172	200 (25)
---	-----------	----------	----------

#### Push-in type jumper bar; insulated; I<sub>N</sub> 25 A; light gray

	2-way	2002-402	25
	3-way	2002-403	25
	4-way	2002-404	25
	5-way	2002-405	25
	6-way	2002-406	25
	7-way	2002-407	25
	8-way	2002-408	25
	9-way	2002-409	25
	10-way	2002-410	25

#### Push-in type jumper bar; insulated; I<sub>N</sub> 25 A; light gray

	1 to 3	2002-433	25
	1 to 4	2002-434	25
	1 to 5	2002-435	25
	1 to 6	2002-436	25
	1 to 7	2002-437	25
	1 to 8	2002-438	25
	1 to 9	2002-439	25
	1 to 10	2002-440	25

#### Double-deck vertical jumper; insulated; I<sub>N</sub> 24 A

	light gray	2002-492	100 (25)
	orange	2002-492/000-012	100 (25)

# 4-Conductor Double-Deck Terminal Block TOPJOB® S

## 2.5 (4) mm<sup>2</sup>; 2002 Series

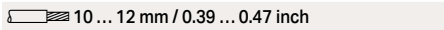
Technical Data	
0.25 ... 2.5 (4) mm <sup>2</sup> ①	22 ... 12 AWG
800 V/8 kV/3 ②	600 V, 20 A ③
I <sub>N</sub> 24 A (28 A)	600 V, 20 A ④
Terminal block width: 5.2 mm / 0.205 inch	
 10 ... 12 mm / 0.39 ... 0.47 inch	

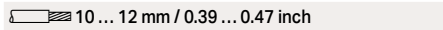
Technical Data	
0.25 ... 2.5 (4) mm <sup>2</sup> ①	22 ... 12 AWG
800 V/8 kV/3 ②	600 V, 20 A ③
I <sub>N</sub> 24 A (28 A)	600 V, 20 A ④
Terminal block width: 5.2 mm / 0.205 inch	
 10 ... 12 mm / 0.39 ... 0.47 inch	

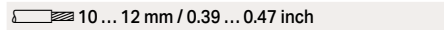
Technical Data	
0.25 ... 2.5 (4) mm <sup>2</sup> ①	22 ... 12 AWG
800 V/8 kV/3 ②	600 V, 20 A ③
I <sub>N</sub> 24 A (28 A)	600 V, 20 A ④
Terminal block width: 5.2 mm / 0.205 inch	
 10 ... 12 mm / 0.39 ... 0.47 inch	

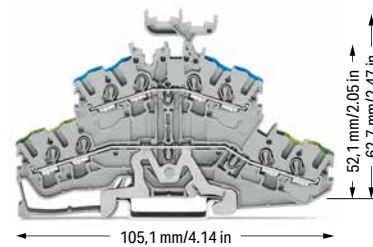
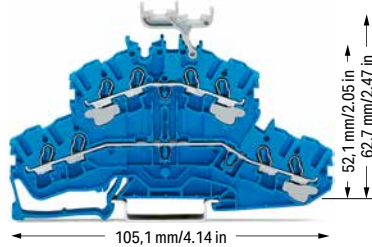
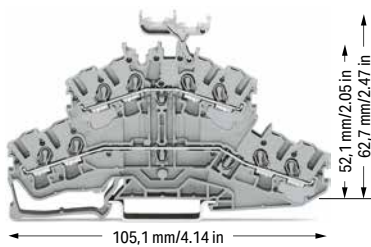

4-conductor double-deck terminal block; through/through terminal block; with marker carrier; gray

	Item No.	Pack. Unit
○ L/L ⑤	2002-2431 ④	50
○ N/L ⑤	2002-2432 ④	50
○ L/N ⑤	2002-2433 ④	50

4-conductor double-deck terminal block; through/through terminal block; with marker carrier; blue

	Item No.	Pack. Unit
● N/N ⑤	2002-2434 ③ ④	50

4-conductor double-deck terminal block; ground conductor/through terminal block; with marker carrier; gray

	Item No.	Pack. Unit
○ PE/N ⑤	2002-2447 ④	50
○ PE/L ⑤	2002-2457 ④	50

4-conductor double-deck terminal block; through/through terminal block; without marker carrier; gray

○ L/L ⑤	2002-2401 ④	50
○ N/L ⑤	2002-2402 ④	50
○ L/N ⑤	2002-2403 ④	50

4-conductor double-deck terminal block; through/through terminal block; without marker carrier; blue

● N/N ⑤	2002-2404 ③ ④	50
---------	---------------	----

4-conductor double-deck terminal block; ground conductor/through terminal block; without marker carrier; gray

○ PE/N ⑤	2002-2417 ④	50
○ PE/L ⑤	2002-2427 ④	50

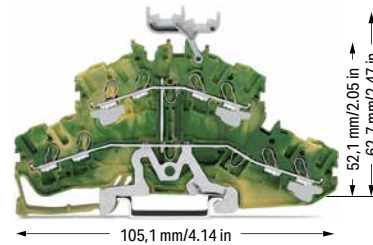
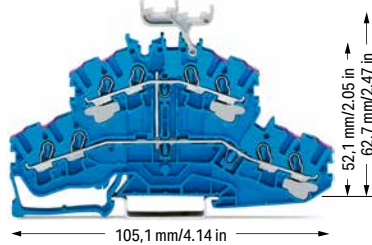
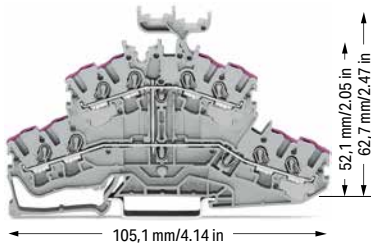

4-conductor double-deck terminal block; 8-conductor through terminal block; with marker carrier; internally commoned; violet conductor entry; gray

	Item No.	Pack. Unit
○ L ⑤	2002-2438 ④	50

4-conductor double-deck terminal block; 8-conductor through terminal block; with marker carrier; internally commoned; violet conductor entry; blue

	Item No.	Pack. Unit
● N ⑤	2002-2439 ③ ④	50

4-conductor double-deck terminal block; 8-conductor ground terminal block; with marker carrier; internally commoned; green-yellow

	Item No.	Pack. Unit
● PE ⑤	2002-2437 ④	50

4-conductor double-deck terminal block; 8-conductor through terminal block; without marker carrier; internally commoned; violet conductor entry; gray

○ L ⑤	2002-2408 ④	50
-------	-------------	----

4-conductor double-deck terminal block; 8-conductor through terminal block; without marker carrier; internally commoned; violet conductor entry; blue

● N ⑤	2002-2409 ③ ④	50
-------	---------------	----

4-conductor double-deck terminal block; 8-conductor ground terminal block; without marker carrier; internally commoned; green-yellow

● PE ⑤	2002-2407 ④	50
--------	-------------	----

## Technical Data

0.25 ... 2.5 (4) mm <sup>2</sup> ①	22 ... 12 AWG
800 V/8 kV/3 ②	600 V, 20 A ③
I <sub>N</sub> 24 A (28 A)	600 V, 20 A ④
Terminal block width: 5.2 mm / 0.205 inch	
 10 ... 12 mm / 0.39 ... 0.47 inch	

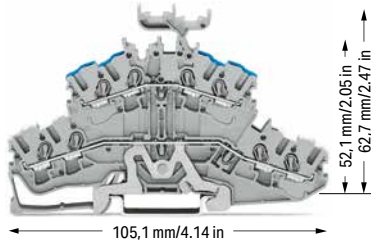

4-conductor double-deck terminal block; shield/through terminal block; with marker carrier; gray

	Item No.	Pack. Unit
○ Shield/N	2002-2448	50
○ Shield/L	2002-2458	50

4-conductor double-deck terminal block; shield/through terminal block; without marker carrier; gray

	Item No.	Pack. Unit
○ Shield/N	2002-2418	50
○ Shield/L	2002-2428	50

- Conductor range: 0.25 ... 4 mm<sup>2</sup> "s+f-st"; Push-in termination: 1 ... 4 mm<sup>2</sup> "s" and 1 ... 2.5 mm<sup>2</sup> "insulated ferrules, 12 mm" Depending on the conductor characteristic, a conductor with a smaller cross section can also be inserted via push-in termination.
- 800 V = rated voltage  
8 kV = rated impulse voltage  
3 = pollution degree
- Terminal blocks with a blue insulated housing are suitable for Ex i applications.
- Terminal blocks with an Ex mark are suitable for Ex e II applications.  
550 V; 21 A  
17 A jumper  
16 A staggered jumper

Please observe the application notes:  
Jumpers, from page 160  
Testing accessories, page 159  
Marking, from page 246

Approvals and corresponding ratings, visit [www.wago.com](http://www.wago.com)

## Accessories; 2002 Series

Appropriate marking systems:  
WMB/WMB Inline/Marking strips

## End and intermediate plate; 0.8 mm thick

orange	2002-2492	100 (25)
gray	2002-2491	100 (25)

Insulation stop; 5 pcs/strip; 0.25 ... 0.5 mm<sup>2</sup>

light gray	2002-171	200 (25)
------------	----------	----------

Insulation stop; 5 pcs/strip; 0.75 ... 1 mm<sup>2</sup>

dark gray	2002-172	200 (25)
-----------	----------	----------

Push-in type jumper bar; insulated; I<sub>N</sub> 25 A; light gray

2-way	2002-402	25
3-way	2002-403	25
4-way	2002-404	25
5-way	2002-405	25
6-way	2002-406	25
7-way	2002-407	25
8-way	2002-408	25
9-way	2002-409	25
10-way	2002-410	25

Push-in type jumper bar; insulated; I<sub>N</sub> 25 A; light gray

1 to 3	2002-433	25
1 to 4	2002-434	25
1 to 5	2002-435	25
1 to 6	2002-436	25
1 to 7	2002-437	25
1 to 8	2002-438	25
1 to 9	2002-439	25
1 to 10	2002-440	25

Double-deck vertical jumper; insulated; I<sub>N</sub> 24 A

light gray	2002-492	100 (25)
orange	2002-492/000-012	100 (25)

Adjacent jumper for continuous commoning; insulated; I<sub>N</sub> 25 A, light gray

2-way	2002-400	25
-------	----------	----

## Accessories; 2002 Series

Appropriate marking systems:  
WMB/WMB Inline/Marking strips

Adjacent jumper for continuous commoning; insulated; I<sub>N</sub> 25 A; 1 to 3

light gray	2002-423	25
red	2002-423/000-005	25
blue	2002-423/000-006	25

## Protective warning marker; with black high-voltage symbol; for 5 terminal blocks

yellow	2002-115	100 (25)
--------	----------	----------

## Test plug adapter; for 4 mm Ø test plug

gray	2009-174	100 (25)
------	----------	----------

## Banana plug; for 4 mm socket diameter; color mixed; 10 x orange, white, black, blue, yellow; max. 42 V

	215-111	50
--	---------	----

Testing tap; for max. 2.5 mm<sup>2</sup>

gray	2009-182	100 (25)
------	----------	----------

## WMB Inline, plain; 1,500 WMB markers (5 mm)/reel; 5 ... 5.2 mm stretchable

white	2009-115	1
-------	----------	---

## Marking strip; plain; 11 mm wide; 50 m reel

white	2009-110	1
-------	----------	---

## WMB marking card; white; 10 strips with 10 markers/card; 5 ... 5.2 mm stretchable

plain	793-5501	5
-------	----------	---

## Double-deck marker carrier; pivoting

gray	2002-121	50 (25)
------	----------	---------

## Group marker carrier; snap-on type for jumper slot; 5 mm wide

gray	2009-191	50 (25)
------	----------	---------

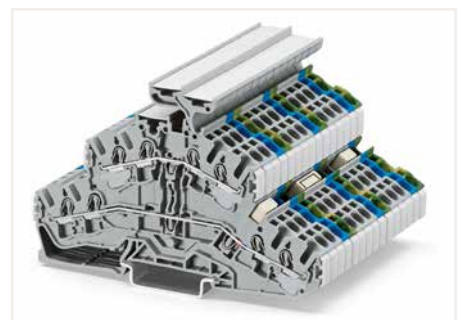

Double-deck terminal block assembly

# Double-Deck Terminal Block TOPJOB® S

## 2.5 (4) mm<sup>2</sup>; 2002 Series

Technical Data	
0.25 ... 2.5 (4) mm <sup>2</sup> ①	22 ... 12 AWG
500 V/6 kV/3 ②	300 V, 20 A ③
I <sub>N</sub> 24 A (28 A)	
Terminal block width: 5.2 mm / 0.205 inch	
10 ... 12 mm / 0.39 ... 0.47 inch	

Technical Data	
0.25 ... 2.5 (4) mm <sup>2</sup> ①	22 ... 12 AWG
500 V/6 kV/3 ②	300 V, 20 A ③
I <sub>N</sub> 24 A (28 A)	
Terminal block width: 5.2 mm / 0.205 inch	
10 ... 12 mm / 0.39 ... 0.47 inch	

Technical Data	
0.25 ... 2.5 (4) mm <sup>2</sup> ①	22 ... 12 AWG
500 V/6 kV/3 ②	300 V, 20 A ③
I <sub>N</sub> 24 A (28 A)	
Terminal block width: 5.2 mm / 0.205 inch	
10 ... 12 mm / 0.39 ... 0.47 inch	

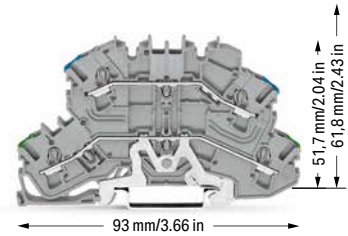
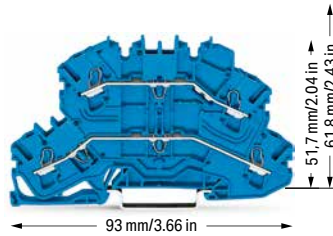
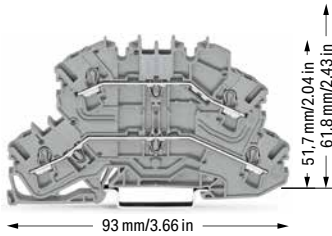

Double-deck terminal block; through/through terminal block; same profile as double-deck disconnect terminal block; without marker carrier; gray

	Item No.	Pack. Unit
○ L/L ④	2002-2601 ④	50
○ N/L ④	2002-2602 ④	50
○ L/N ④	2002-2603 ④	50

Double-deck terminal block; through/through terminal block; same profile as double-deck disconnect terminal block; without marker carrier; blue

	Item No.	Pack. Unit
● N/N ④	2002-2604 ③ ④	50

Double-deck terminal block; ground conductor/through terminal block; same profile as double-deck disconnect terminal block; without marker carrier; gray

	Item No.	Pack. Unit
○ PE/N ④	2002-2647 ④	50
○ PE/L ④	2002-2657 ④	50

Other terminal blocks with the same profile:

Carrier	2002-2661	Page 64
Disconnect	2002-2671	Page 64
Fuse	2002-2611	Page 65

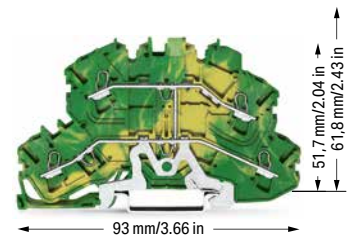
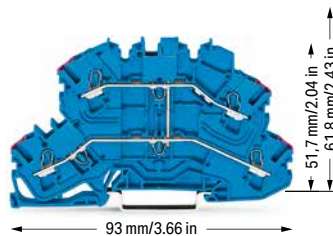
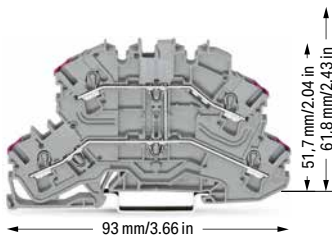

Double-deck terminal block; 4-conductor through terminal block; same profile as double-deck disconnect terminal block; without marker carrier; internally commoned; violet conductor entry; gray

	Item No.	Pack. Unit
○ L ④	2002-2608 ④	50

Double-deck terminal block; 4-conductor through terminal block; same profile as double-deck disconnect terminal block; without marker carrier; internally commoned; violet conductor entry; blue

	Item No.	Pack. Unit
● N ④	2002-2609 ③ ④	50

Double-deck terminal block; 4-conductor ground terminal block; same profile as double-deck disconnect terminal block; without marker carrier; internally commoned; green-yellow

	Item No.	Pack. Unit
● PE ④	2002-2607 ④	50



❶ Conductor range: 0.25 ... 4 mm<sup>2</sup> "s+f-st";  
Push-in termination: 1 ... 4 mm<sup>2</sup> "s" and 1 ... 2.5 mm<sup>2</sup>  
"insulated ferrules, 12 mm"  
Depending on the conductor characteristic, a conductor with a smaller cross section can also be inserted via push-in termination.

❷ 500 V = rated voltage  
6 kV = rated impulse voltage  
3 = pollution degree

❸ Terminal blocks with a blue insulated housing are suitable for Ex i applications.

❹ Terminal blocks with an Ex mark are suitable for Ex ec IIc applications.

Please observe the application notes:  
Jumpers, from page 160  
Testing accessories, page 159  
Marking, from page 246

Approvals and corresponding ratings,  
visit [www.wago.com](http://www.wago.com)

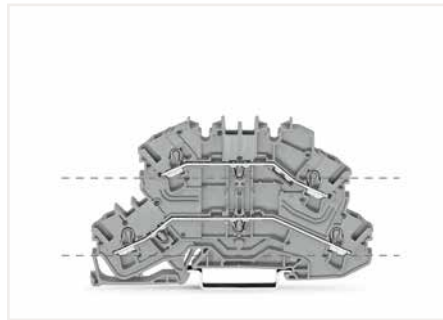

Through terminal blocks (2002-2601) feature two independent current bars on both lower and upper deck, sharing the same profile as disconnect terminal blocks. These terminal blocks can be commoned via double-deck vertical jumpers (2002-492).

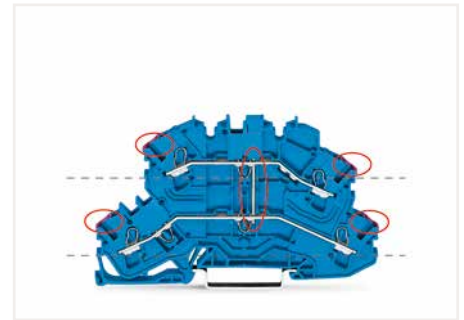

4-conductor through terminal blocks (2002-2609) with internal commoning can be immediately identified via violet conductor entry.

#### Accessories; 2002 Series

Appropriate marking systems:  
WMB/WMB Inline/Marking strips

#### End and intermediate plate; 1 mm thick

	orange	2002-2692	100 (25)
	gray	2002-2691	100 (25)

#### Double-deck marker carrier; pivoting

	gray	2002-121	50 (25)
---	------	----------	---------

#### Insulation stop; 5 pcs/strip; 0.25 ... 0.5 mm<sup>2</sup>

	light gray	2002-171	200 (25)
---	------------	----------	----------

#### Insulation stop; 5 pcs/strip; 0.75 ... 1 mm<sup>2</sup>

	dark gray	2002-172	200 (25)
---	-----------	----------	----------

#### Push-in type jumper bar; insulated; I<sub>N</sub> 25 A; light gray

	2-way	2002-402	25
	3-way	2002-403	25
	4-way	2002-404	25
	5-way	2002-405	25
	6-way	2002-406	25
	7-way	2002-407	25
	8-way	2002-408	25
	9-way	2002-409	25
	10-way	2002-410	25

#### Push-in type jumper bar; insulated; I<sub>N</sub> 25 A; light gray

	1 to 3	2002-433	25
	1 to 4	2002-434	25
	1 to 5	2002-435	25
	1 to 6	2002-436	25
	1 to 7	2002-437	25
	1 to 8	2002-438	25
	1 to 9	2002-439	25
	1 to 10	2002-440	25

#### Double-deck vertical jumper; insulated; I<sub>N</sub> 24 A

	light gray	2002-492	100 (25)
	orange	2002-492/000-012	100 (25)

#### Adjacent jumper for continuous commoning; insulated; I<sub>N</sub> 25 A, light gray

	2-way	2002-400	25
---	-------	----------	----



Double-deck disconnect terminal blocks with a pivoting knife disconnect (2002-2671) can be used as through terminal blocks on the lower deck and as disconnect terminal blocks on the upper deck. Besides disconnection and measurement, double-deck carrier terminal blocks (2002-2667) also provide ground conductor functionality.

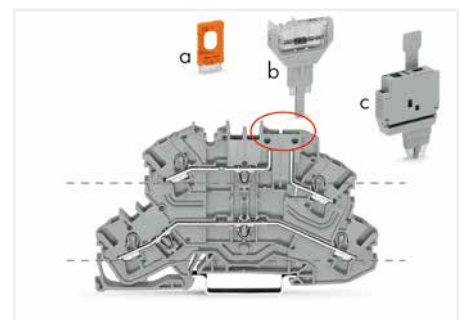

Carrier terminal blocks (2002-2661) have the same design as disconnect terminal blocks. The following components may be used:  
- Disconnect plugs (a: 2002-401)  
- Pluggable diode (b: 2002-800/1000-411)  
- LED module (2002-800/1000-541, no illustration)  
- Fuse plug (c: 2004-911)



Double-deck fuse disconnect terminal blocks with a pivoting fuse holder (2002-2611, gray) are compatible with disconnect, carrier, through and ground conductor terminal blocks. The fuse holder is also available with a blown fuse LED indicator (e.g., 2002-2611/1000-541 for 12-30 V).

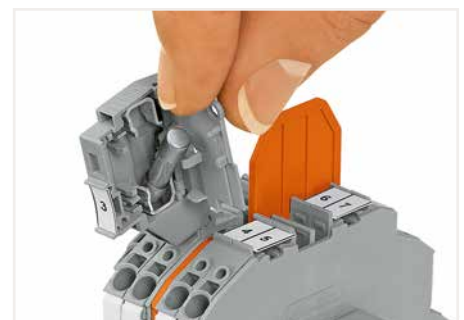

An end plate for fuse disconnect terminal blocks (shown in orange, 2002-1092) is used for additional protection, preventing the fuse holder from being opened. The fuse cannot be replaced until disconnecting the fuse holder from the power supply.

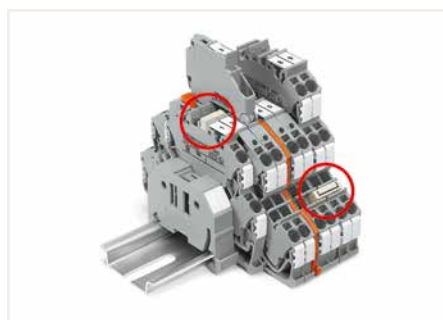

The same profile allows for commoning with double-deck terminal blocks (upper deck) and with triple-deck terminal blocks (lower deck).

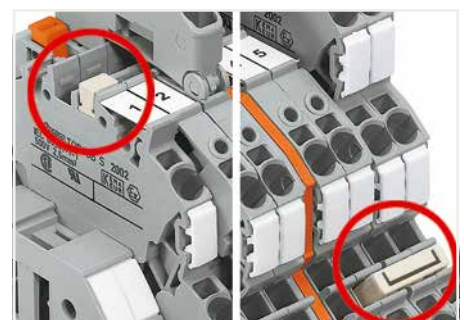

Left picture – Vertical jumper (2002-492)  
Right picture – Push-in type jumper bar (2002 Series)

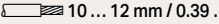

# Double-Deck Disconnect Terminal Block, Double-Deck Carrier Terminal Block TOPJOB® S 2.5 (4) mm<sup>2</sup>; 2002 Series

Technical Data	
0.25 ... 2.5 (4) mm <sup>2</sup> ①	22 ... 12 AWG
400 V/6 kV/3 ②	300 V, 20 A ③
I <sub>N</sub> 16 A	
Terminal block width: 5.2 mm / 0.205 inch	
 10 ... 12 mm / 0.39 ... 0.47 inch	

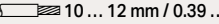
Technical Data	
0.25 ... 2.5 (4) mm <sup>2</sup> ①	22 ... 12 AWG
400 V/6 kV/3 ②	300 V, 20 A ③
I <sub>N</sub> 16 A	
Terminal block width: 5.2 mm / 0.205 inch	
 10 ... 12 mm / 0.39 ... 0.47 inch	

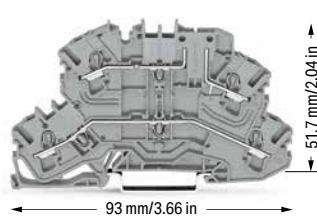
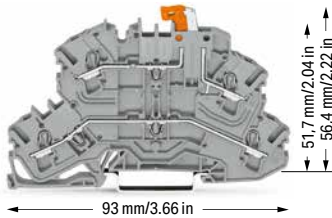

Double-deck disconnect terminal block; with a pivoting knife disconnect; gray

	Item No.	Pack. Unit
○ L/L ④	2002-2671 ⑤	50
○ N/L ④	2002-2672 ⑤	50

Double-deck carrier terminal block; upper-deck base; gray

	Item No.	Pack. Unit
○ L/L ④	2002-2661 ⑤	50
○ N/L ④	2002-2662 ⑤	50

Other terminal blocks with the same profile:		
Through	2002-2601	Page 62
Fuse	2002-2611	Page 65

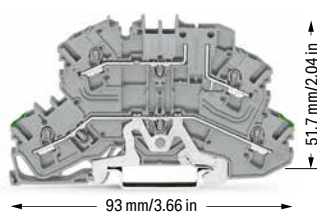
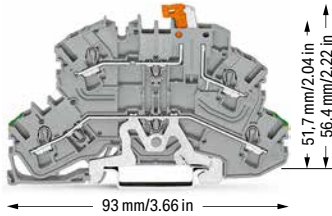

Double-deck disconnect terminal block; with a pivoting knife disconnect; gray

	Item No.	Pack. Unit
○ Shield/L ④	2002-2678 ⑤	50

Double-deck carrier terminal block; upper-deck base; gray

	Item No.	Pack. Unit
○ PE/L ④	2002-2667 ⑤	50

① Conductor range: 0.25 ... 4 mm<sup>2</sup> "s+f-st"; Push-in termination: 1 ... 4 mm<sup>2</sup> "s" and 1 ... 2.5 mm<sup>2</sup> "insulated ferrules, 12 mm"  
Depending on the conductor characteristic, a conductor with a smaller cross section can also be inserted via push-in termination.

② 400 V = rated voltage  
6 kV = rated impulse voltage  
3 = pollution degree

③ Terminal blocks with an Ex mark are suitable for Ex ec IIc applications.

Please observe the application notes:  
Jumpers, from page 160  
Testing accessories, page 159  
Marking, from page 246

Approvals and corresponding ratings, visit [www.wago.com](http://www.wago.com)

### Accessories; 2002 Series

Appropriate marking systems:  
WMB/WMB Inline/Marking strips

### End and intermediate plate; 1 mm thick

 orange	2002-2692	100 (25)
 gray	2002-2691	100 (25)

### Double-deck marker carrier; pivoting

 gray	2002-121	50 (25)
---	----------	---------









### Insulation stop; 5 pcs/strip; 0.25 ... 0.5 mm<sup>2</sup>

 light gray	2002-171	200 (25)
--	----------	----------

### Insulation stop; 5 pcs/strip; 0.75 ... 1 mm<sup>2</sup>

 dark gray	2002-172	200 (25)
---	----------	----------

### Push-in type jumper bar; insulated; I<sub>N</sub> 25 A; light gray

 2-way	2002-402	25
 3-way	2002-403	25
 4-way	2002-404	25
 5-way	2002-405	25
 6-way	2002-406	25
 7-way	2002-407	25
 8-way	2002-408	25
 9-way	2002-409	25
 10-way	2002-410	25

### Push-in type jumper bar; insulated; I<sub>N</sub> 25 A; light gray

 1 to 3	2002-433	25
 1 to 4	2002-434	25
 1 to 5	2002-435	25
 1 to 6	2002-436	25
 1 to 7	2002-437	25
 1 to 8	2002-438	25
 1 to 9	2002-439	25
 1 to 10	2002-440	25

### Double-deck vertical jumper; insulated; I<sub>N</sub> 24 A

 light gray	2002-492	100 (25)
 orange	2002-492/000-012	100 (25)

### Adjacent jumper for continuous commoning; insulated; I<sub>N</sub> 25 A, light gray

 2-way	2002-400	25
---	----------	----

# Double-Deck Fuse Terminal Block TOPJOB® S

## 2.5 (4) mm<sup>2</sup>; 2002 Series

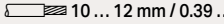
Technical Data	
0.25 ... 2.5 (4) mm <sup>2</sup> ①	22 ... 12 AWG
250 V/6 kV/3 ②	300 V, 6.3 A <sub>N</sub>
I <sub>N</sub> 6.3 A	
Terminal block width: 6.2 mm / 0.244 inch	
 10 ... 12 mm / 0.39 ... 0.47 inch	

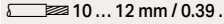
Technical Data	
0.25 ... 2.5 (4) mm <sup>2</sup> ①	22 ... 12 AWG
250 V/6 kV/3 ②	300 V, 6.3 A <sub>N</sub>
I <sub>N</sub> 6.3 A	
Terminal block width: 6.2 mm / 0.244 inch	
 10 ... 12 mm / 0.39 ... 0.47 inch	

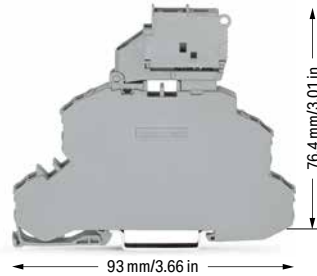

Double-deck fuse disconnect terminal block with a pivoting fuse holder; through/fuse terminal block; for 5 x 20 mm glass cartridge fuse; without blown fuse indication; gray  
Electrical ratings are given by the fuse.

Double-deck fuse disconnect terminal block with a pivoting fuse holder; through/fuse terminal block; for 5 x 20 mm glass cartridge fuse; with blown fuse indication by LED; gray  
Electrical ratings are given by the fuse and blown fuse indication. Leakage current in case of a blown fuse: LED 2 mA

	Item No.	Pack. Unit
○ L/L ③	2002-2611 ③	25
○ N/L ③	2002-2612 ③	25

	Item No.	Pack. Unit
○ 12 ... 30 V ④	2002-2611/1000-541 ④	25
○ 30 ... 65 V ④	2002-2611/1000-542 ④	25
○ 230 V ④	2002-2611/1000-836 ④	25
○ 120 V ④	2002-2611/1000-867 ④	25

Other terminal blocks with the same profile:  
Through 2002-2601 Page 62

**Accessories; 2002 Series**

Appropriate marking systems: WMB/Marking strips

**End and intermediate plate; 1 mm thick**

 orange	2002-2692	100 (25)
 gray	2002-2691	100 (25)

**Insulation stop; 5 pcs/strip; 0.25 ... 0.5 mm<sup>2</sup>**

 light gray	2002-171	200 (25)
--	----------	----------









**End plate for fuse terminal blocks; 2 mm thick**

 orange	2002-1092	100 (25)
 gray	2002-1091	100 (25)

**Insulation stop; 5 pcs/strip; 0.75 ... 1 mm<sup>2</sup>**

 dark gray	2002-172	200 (25)
---	----------	----------







**Push-in type jumper bar; insulated; I<sub>N</sub> 32 A; light gray**

 2-way	2004-402	25
 3-way	2004-403	25
 4-way	2004-404	25
 5-way	2004-405	25
 6-way	2004-406	25
 7-way	2004-407	25
 8-way	2004-408	25
 9-way	2004-409	25
 10-way	2004-410	25

**Protective warning marker; with black high-voltage symbol; for 5 terminal blocks**

 yellow	2002-115	100 (25)
--	----------	----------

**Push-in type jumper bar; insulated; I<sub>N</sub> 32 A; light gray**

 1 to 3	2004-433	25
 1 to 4	2004-434	25
 1 to 5	2004-435	25
 1 to 6	2004-436	25
 1 to 7	2004-437	25
 1 to 8	2004-438	25
 1 to 9	2004-439	25
 1 to 10	2004-440	25

**Test plug; with 500 mm cable; 2 mm Ø; max. 42 V**

 red	210-136	50 (1)
---	---------	--------

**Test plug; with 500 mm cable; 2.3 mm Ø; max. 42 V**

 yellow	210-137	50 (1)
--	---------	--------

**Marking strip; plain; 11 mm wide; 50 m reel**

 white	2009-110	1
---	----------	---

**WMB marking card; white; 10 strips with 10 markers/card; 5 ... 5.2 mm stretchable**

 plain	793-5501	5
---	----------	---

**Double-deck vertical jumper; insulated; I<sub>N</sub> 24 A**

 light gray	2002-492	100 (25)
 orange	2002-492/000-012	100 (25)

① Conductor range: 0.25 ... 4 mm<sup>2</sup> "s+f-st"; Push-in termination: 1 ... 4 mm<sup>2</sup> "s" and 1 ... 2.5 mm<sup>2</sup> "insulated ferrules, 12 mm"  
Depending on the conductor characteristic, a conductor with a smaller cross section can also be inserted via push-in termination.

② 250 V = rated voltage  
6 kV = rated impulse voltage  
3 = pollution degree

③ Terminal blocks with an Ex mark are suitable for Ex ec IIc applications.

Please observe the application notes:

Jumpers, from page 165  
Marking, from page 246

A protective warning marker and an insulation stop must be applied individually. Due to the 6.2 mm width of double-deck terminal blocks with end plates, 2004 Series Push-In Type Jumper Bars must be used.

Approvals and corresponding ratings, visit [www.wago.com](http://www.wago.com)

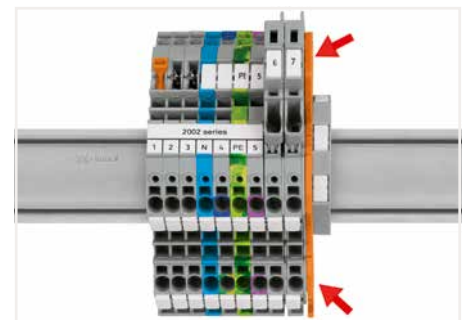

Additionally, an end plate for fuse terminal blocks (e.g., 2002-1092, orange) must be used at the end of an assembly or if there is no adjacent fuse terminal block.

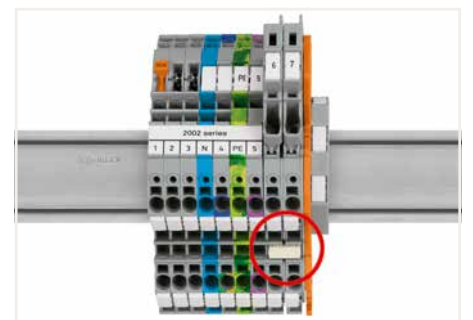

An intermediate plate is supplied with all 6.2 mm wide fused disconnect terminal blocks. Due to the 6.2 mm width of fuse disconnect terminal blocks with a pivoting fuse holder, 2004 Series Push-In Type Jumper Bars must be used.

## Triple-Deck Terminal Block TOPJOB® S

### 2.5 (4) mm<sup>2</sup>; 2002 Series

#### Technical Data

0.25 ... 2.5 (4) mm<sup>2</sup> ① 22 ... 12 AWG

500 V/6 kV/3 ② 600 V, 20 A ③

I<sub>N</sub> 24 A (28 A) 600 V, 20 A ④

Terminal block width: 5.2 mm / 0.205 inch

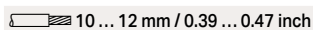
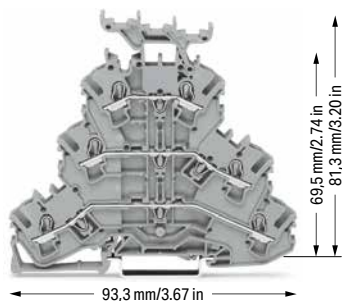
 10 ... 12 mm / 0.39 ... 0.47 inch

93,3 mm/3.67 in

69,5 mm/2.74 in  
81,3 mm/3.20 in

Triple-deck terminal block; through/through/through terminal block; with marker carrier; gray

	Item No.	Pack. Unit
○ L/L/L ⑤	2002-3231 ④	50
○ L/L/N ⑤	2002-3233 ④	50

#### Technical Data

0.25 ... 2.5 (4) mm<sup>2</sup> ① 22 ... 12 AWG

500 V/6 kV/3 ② 600 V, 20 A ③

I<sub>N</sub> 24 A (28 A) 600 V, 20 A ④

Terminal block width: 5.2 mm / 0.205 inch

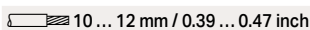
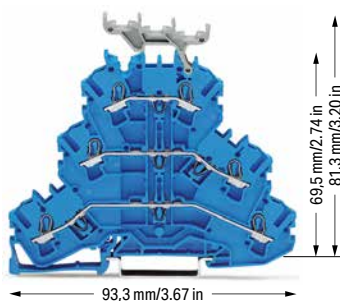
 10 ... 12 mm / 0.39 ... 0.47 inch

93,3 mm/3.67 in

69,5 mm/2.74 in  
81,3 mm/3.20 in

Triple-deck terminal block; through/through/through terminal block; with marker carrier; blue

	Item No.	Pack. Unit
● N/N/N ⑤	2002-3234 ③ ④	50

#### Technical Data

0.25 ... 2.5 (4) mm<sup>2</sup> ① 22 ... 12 AWG

500 V/6 kV/3 ② 600 V, 20 A ③

I<sub>N</sub> 24 A (28 A) 600 V, 20 A ④

Terminal block width: 5.2 mm / 0.205 inch

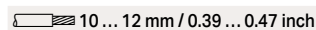
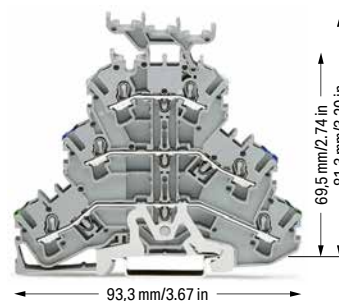
 10 ... 12 mm / 0.39 ... 0.47 inch

93,3 mm/3.67 in

69,5 mm/2.74 in  
81,3 mm/3.20 in

Triple-deck terminal block; ground conductor/through/through terminal block; with marker carrier; gray

	Item No.	Pack. Unit
○ PE/N/L ⑤	2002-3247 ④	50
○ PE/L/L ⑤	2002-3257 ④	50

Triple-deck terminal block; through/through/through terminal block; without marker carrier; gray

○ L/L/L ⑤	2002-3201 ④	50
○ L/L/N ⑤	2002-3203 ④	50

Triple-deck terminal block; through/through/through terminal block; without marker carrier; blue

● N/N/N ⑤	2002-3204 ③ ④	50
-----------	---------------	----

Triple-deck terminal block; ground conductor/through/through terminal block; without marker carrier; gray

○ PE/N/L ⑤	2002-3217 ④	50
○ PE/L/L ⑤	2002-3227 ④	50

#### Other terminal blocks with the same profile:

Diode	2002-3211/1000-410	Page 150
LED	2002-3221/1000-434	Page 150

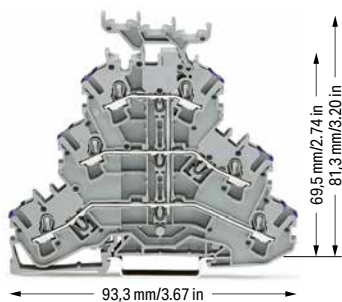

93,3 mm/3.67 in

69,5 mm/2.74 in  
81,3 mm/3.20 in

Triple-deck terminal block; 6-conductor through terminal block; with marker carrier; internally commoned; violet conductor entry; gray

	Item No.	Pack. Unit
○ L ⑤	2002-3238 ④	50

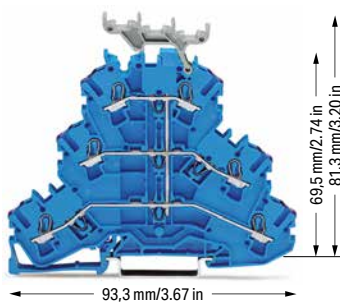

93,3 mm/3.67 in

69,5 mm/2.74 in  
81,3 mm/3.20 in

Triple-deck terminal block; 6-conductor through terminal block; with marker carrier; internally commoned; violet conductor entry; blue

	Item No.	Pack. Unit
● N ⑤	2002-3239 ③ ④	50

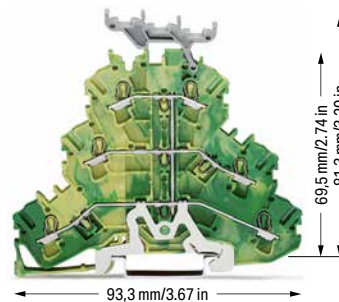

93,3 mm/3.67 in

69,5 mm/2.74 in  
81,3 mm/3.20 in

Triple-deck terminal block; 6-conductor ground terminal block; with marker carrier; internally commoned; green-yellow

	Item No.	Pack. Unit
● PE ⑤	2002-3237 ④	50

Triple-deck terminal block; 6-conductor through terminal block; without marker carrier; internally commoned; violet conductor entry; gray

○ L ⑤	2002-3208 ④	50
-------	-------------	----

Triple-deck terminal block; 6-conductor through terminal block; without marker carrier; internally commoned; violet conductor entry; blue

● N ⑤	2002-3209 ③ ④	50
-------	---------------	----

Triple-deck terminal block; 6-conductor ground terminal block; without marker carrier; internally commoned; green-yellow

● PE ⑤	2002-3207 ④	50
--------	-------------	----

Sold &amp; Serviced By:



Toll Free Phone (877) SERV098  
www.electromate.com  
sales@electromate.com

## Technical Data

0.25 ... 2.5 (4) mm<sup>2</sup> ① | 22 ... 12 AWG

500 V/6 kV/3 ② | 600 V, 20 A ③

I<sub>N</sub> 24 A (28 A) | 600 V, 20 A ④

Terminal block width: 5.2 mm / 0.205 inch

10 ... 12 mm / 0.39 ... 0.47 inch

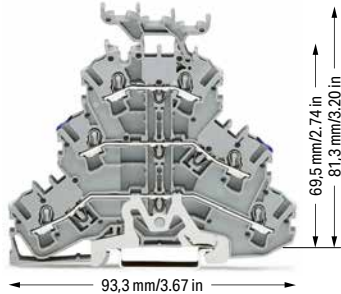

Triple-deck terminal block; shield/through/through terminal block; with marker carrier; gray

	Item No.	Pack. Unit
○ Shield/N/L	2002-3248	50
○ Shield/L/L	2002-3258	50

Triple-deck terminal block; shield/through/through terminal block; without marker carrier; gray

○ Shield/N/L	2002-3218	50
○ Shield/L/L	2002-3228	50

① Conductor range: 0.25 ... 4 mm<sup>2</sup> "s+f-st";  
Push-in termination: 1 ... 4 mm<sup>2</sup> "s" and 1 ... 2.5 mm<sup>2</sup> "insulated ferrules, 12 mm"  
Depending on the conductor characteristic, a conductor with a smaller cross section can also be inserted via push-in termination.

② 500 V = rated voltage  
6 kV = rated impulse voltage  
3 = pollution degree

③ Terminal blocks with a blue insulated housing are suitable for Ex i applications.

④ Terminal blocks with an Ex mark are suitable for Ex e II applications.  
440 V, 19 A  
17 A jumper

Please observe the application notes:  
Jumpers, from page 160  
Testing accessories, page 159  
Marking, from page 246

Approvals and corresponding ratings, visit [www.wago.com](http://www.wago.com)

## Accessories; 2002 Series

Appropriate marking systems:  
WMB/WMB Inline/Marking strips

## End and intermediate plate; 0.8 mm thick

	orange	2002-3292	100 (25)
	gray	2002-3291	100 (25)

## Triple-deck marker carrier; pivoting

	gray	2002-131	50 (25)
---	------	----------	---------

Insulation stop; 5 pcs/strip; 0.25 ... 0.5 mm<sup>2</sup>

	light gray	2002-171	200 (25)
---	------------	----------	----------

Insulation stop; 5 pcs/strip; 0.75 ... 1 mm<sup>2</sup>

	dark gray	2002-172	200 (25)
---	-----------	----------	----------

Push-in type jumper bar; insulated; I<sub>N</sub> 25 A; light gray

	2-way	2002-402	25
	3-way	2002-403	25
	4-way	2002-404	25
	5-way	2002-405	25
	6-way	2002-406	25
	7-way	2002-407	25
	8-way	2002-408	25
	9-way	2002-409	25
	10-way	2002-410	25

Push-in type jumper bar; insulated; I<sub>N</sub> 25 A; light gray

	1 to 3	2002-433	25
	1 to 4	2002-434	25
	1 to 5	2002-435	25
	1 to 6	2002-436	25
	1 to 7	2002-437	25
	1 to 8	2002-438	25
	1 to 9	2002-439	25
	1 to 10	2002-440	25

Double-deck vertical jumper; insulated; I<sub>N</sub> 24 A

	light gray	2002-492	100 (25)
	orange	2002-492/000-012	100 (25)

Triple-deck vertical jumper; insulated; I<sub>N</sub> 24 A

	light gray	2002-493	100 (25)
---	------------	----------	----------



Triple-deck vertical jumpers (2002-493) common the three levels of triple-deck terminal blocks.

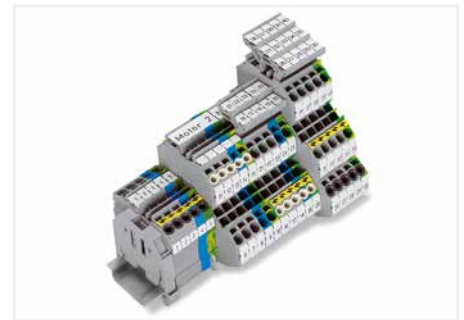

Combination of multilevel terminal blocks



# Quadruple-Deck Rail-Mount Terminal Block for Wiring of Electric Motors TOPJOB® S

## 2.5 (4) mm<sup>2</sup>; 2002 Series

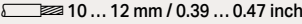
Technical Data	
0.25 ... 2.5 (4) mm <sup>2</sup> ①	22 ... 12 AWG
800 V/8 kV/3 ②	600 V, 20 A: $I_N$
$I_N$ 20 A (25 A)	
Terminal block width: 5.2 mm / 0.205 inch	
 10 ... 12 mm / 0.39 ... 0.47 inch	

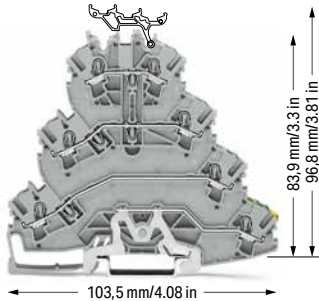

Quadruple-deck rail-mount terminal block; electric motor wiring rail-mount terminal block; without marker carrier; gray

Item No.	Pack. Unit
L1 - L2 - L3 - PE ③ 2002-4127 ④	25

Item No.	Pack. Unit
L1 - L2 - L3 - PE ③ 2002-4157 ④	25

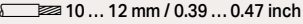
Technical Data	
0.25 ... 2.5 (4) mm <sup>2</sup> ①	22 ... 12 AWG
800 V/8 kV/3 ②	600 V, 20 A: $I_N$
$I_N$ 20 A (25 A)	
Terminal block width: 5.2 mm / 0.205 inch	
 10 ... 12 mm / 0.39 ... 0.47 inch	

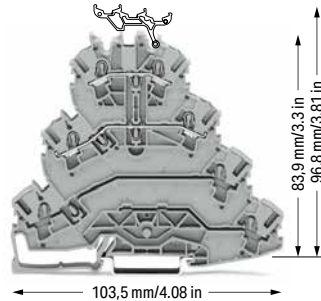

Quadruple-deck rail-mount terminal block; electric motor wiring rail-mount terminal block; without marker carrier; gray

Item No.	Pack. Unit
L1 - L2 ③ 2002-4111 ④	25

Item No.	Pack. Unit
L1 - L2 ③ 2002-4141 ④	25

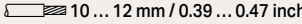
Technical Data	
0.25 ... 2.5 (4) mm <sup>2</sup> ①	22 ... 12 AWG
800 V/8 kV/3 ②	600 V, 20 A: $I_N$
$I_N$ 20 A (25 A)	
Terminal block width: 5.2 mm / 0.205 inch	
 10 ... 12 mm / 0.39 ... 0.47 inch	

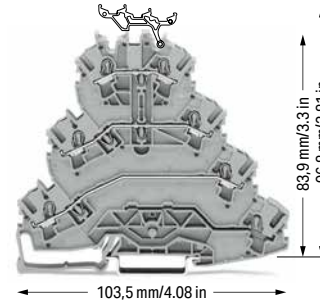

Quadruple-deck rail-mount terminal block; electric motor wiring rail-mount terminal block; without marker carrier; gray

Item No.	Pack. Unit
L1 - L2 - L3 ③ 2002-4101 ④	25

Item No.	Pack. Unit
L1 - L2 - L3 ③ 2002-4131 ④	25

### Accessories; 2002 Series

Appropriate marking systems: WMB/WMB Inline/Marking strips

End and intermediate plate; 1 mm thick			
	orange	2002-4192	100 (25)
	gray	2002-4191	100 (25)

Insulation stop; 5 pcs/strip; 0.25 ... 0.5 mm <sup>2</sup>			
	light gray	2002-171	200 (25)

Insulation stop; 5 pcs/strip; 0.75 ... 1 mm <sup>2</sup>			
	dark gray	2002-172	200 (25)

Protective warning marker; with black high-voltage symbol; for 5 terminal blocks			
	yellow	2002-115	100 (25)

Lockout cap; for conductor entry and operating slot			
	orange	2002-192	25
	gray	2002-191	25
	blue	2002-194	25

Push-in type jumper bar; insulated; $I_N$ 25 A; light gray			
	2-way	2002-402	25
	3-way	2002-403	25
	4-way	2002-404	25
	5-way	2002-405	25
	6-way	2002-406	25
	7-way	2002-407	25
	8-way	2002-408	25
	9-way	2002-409	25
	10-way	2002-410	25

Adjacent jumper for continuous commoning; insulated; $I_N$ 25 A, light gray			
	2-way	2002-415	25

Push-in type jumper bar; insulated; $I_N$ 25 A; light gray			
	1 to 3	2002-433	25
	1 to 4	2002-434	25
	1 to 5	2002-435	25
	1 to 6	2002-436	25
	1 to 7	2002-437	25
	1 to 8	2002-438	25
	1 to 9	2002-439	25
	1 to 10	2002-440	25

Delta jumper; insulated; $I_N = I_N$ terminal block; light gray			
	1-2 3-4 5-6	2002-406/020-000	25

Star point jumper; insulated; $I_N = I_N$ terminal block; light gray			
	1-3-5	2002-405/011-000	25

Staggered jumper; insulated; $I_N$ 25 A; light gray			
	2-way	2002-472	25
	3-way	2002-473	25
	4-way	2002-474	25
	5-way	2002-475	25
	6-way	2002-476	25
	7-way	2002-477	25
	8-way	2002-478	25
	9-way	2002-479	25
	10-way	2002-480	25
	11-way	2002-481	25
	12-way	2002-482	25

Adjacent jumper for continuous commoning; insulated; $I_N$ 25 A, light gray			
	5-way	2002-400	25

Adjacent jumper for continuous commoning; insulated; $I_N$ 25 A; 1 to 3			
	light gray	2002-423	25
	red	2002-423/000-005	25
	blue	2002-423/000-006	25

Push-in type wire jumper; insulated; 1.5 mm <sup>2</sup> conductor cross-section; $I_N$ 18 A			
	L = 60 mm	2009-412	100 (10)
	L = 110 mm	2009-414	100 (10)
	L = 250 mm	2009-416	100 (10)

WMB Inline, plain; 1,500 WMB markers (5 mm)/reel; 5 ... 5.2 mm stretchable			
	white	2009-115	1

Marking strip; plain; 11 mm wide; 50 m reel			
	white	2009-110	1

WMB marking card; white; 10 strips with 10 markers/card; 5 ... 5.2 mm stretchable			
	plain	793-5501	5

Triple-deck marker carrier; pivoting			
	gray	2002-131	50 (25)



❶ Conductor range: 0.25 ... 4 mm<sup>2</sup> "s+f-st";  
Push-in termination: 1 ... 4 mm<sup>2</sup> "s" and 1 ... 2.5 mm<sup>2</sup>  
"insulated ferrules, 12 mm"  
Depending on the conductor characteristic, a conductor with a smaller cross section can also be inserted via push-in termination.

❷ 800 V = rated voltage  
8 kV = rated impulse voltage  
3 = pollution degree

❸ Terminal blocks with an Ex mark are suitable for Ex e II applications.  
440 V, 19 A  
17 A jumper

Please observe the application notes:  
Jumpers, from page 160  
Testing accessories, page 159  
Marking, from page 246

Approvals and corresponding ratings,  
visit [www.wago.com](http://www.wago.com)



Creating spacer housings for electric motor wiring rail-mount terminal blocks via lockout caps (2002-192) for conductor entry and operating slot.

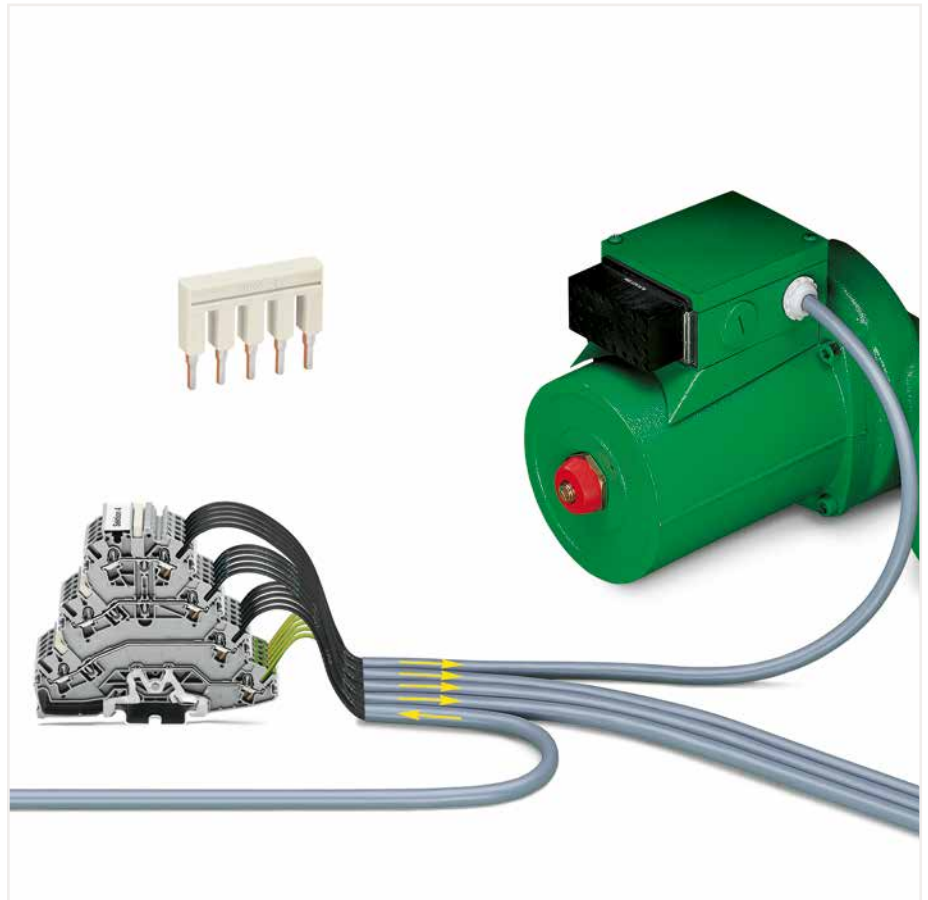

In addition to rail-mount terminal blocks for electric motor wiring, special versions are also available.

- Version without ground contact and only two potentials:  
These terminal blocks were custom designed to support additional functions, such as engine brakes or temperature sensors. Sharing a common profile, this terminal block version can be put next to the appropriate electric motor wiring terminal block without using intermediate plates. That makes the rail assembly easier to understand and wire. This also prevents wiring errors as no conductor entry is unused.
- Version without ground contact and with three potentials:  
Clearly designated clamping units are the primary advantage to this terminal block design. When using devices with protective insulation, for example, there are no open ground clamping units that could create confusion.



Testing with voltage tester.



Marking clamping points via WMB Multi Marking System.  
Group marking via marking strips (Item No. 709-177).

# DISCONNECT/TEST TERMINAL BLOCKS

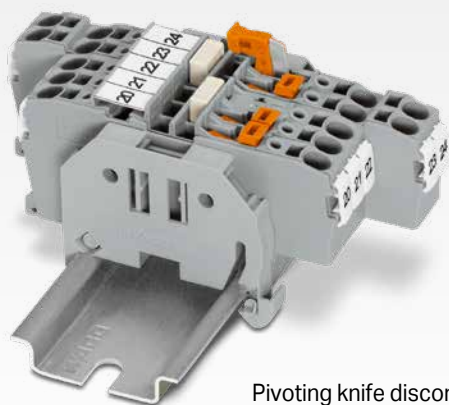

Pivoting knife disconnects clearly indicate the circuit state.

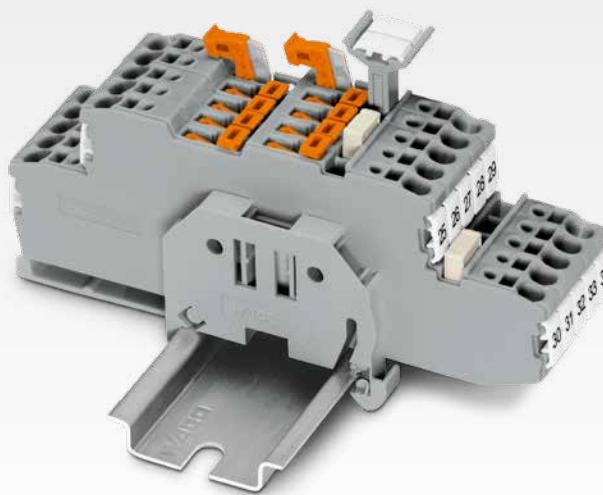

## 2-, 3- and 4-Conductor Disconnect Terminal Blocks

- Three alternative disconnection options are available: via pivoting knife disconnect and additional mechanical interlock or via disconnect plug.
- Thanks to the same shape as corresponding through terminal blocks, these terminal blocks maintain uniformity in the cabinet and provide clear sightlines.

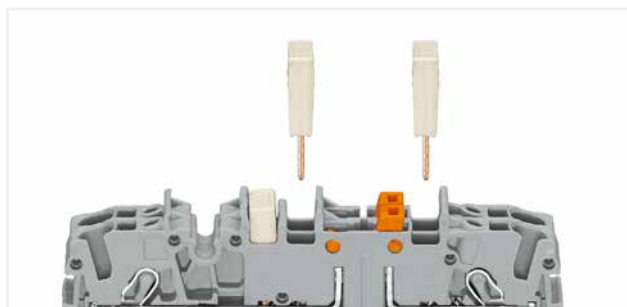

An additional jumper slot is located behind the knife disconnect: commoning options in front of or behind the knife disconnect, depending on the power supply direction.

## Double-Deck, Double-Disconnect Terminal Blocks

- Two potential-free disconnect terminal blocks are housed on two levels.
- Save space without compromising usability.
- The knife disconnects are located between the conductors, always making them visible to the operator.



Pivoting marker carriers provide an additional marking location.

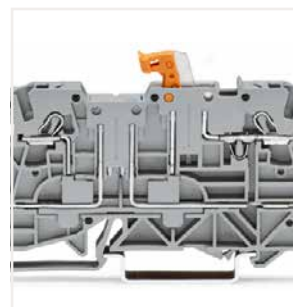

Variant: One disconnect and one through terminal block are accommodated on two levels in a terminal block that is just 5.2 mm (0.205 inch) wide.

# FUSE TERMINAL BLOCKS

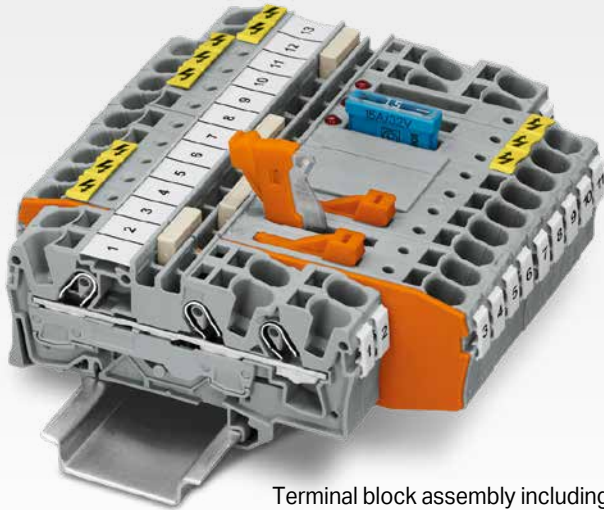

Terminal block assembly including 6 mm<sup>2</sup> (10 AWG) through and disconnect terminal blocks

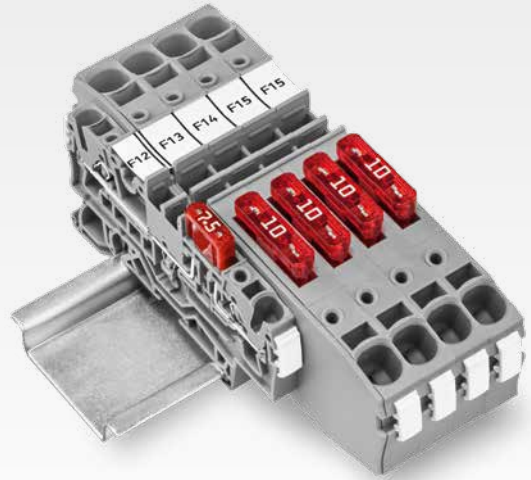

Fuse terminal blocks for DIN 72581-3f blade-style fuses

## Disconnect/Ground Conductor Disconnect Terminal Blocks

- Perfect for high-voltage or renewable energy applications
- Ground conductor disconnect terminal blocks provide service-friendly testing for potential ground faults
- Both terminal blocks are available for conductors ranging in size from 0.5 mm<sup>2</sup> to 10 mm<sup>2</sup> (20–8 AWG).

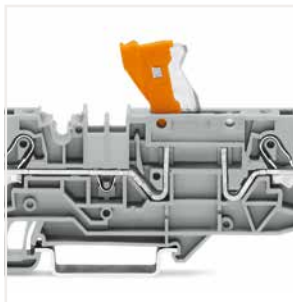

Test position – grounding: slide link open, auxiliary circuit not grounded, red LED/neon lamp lights

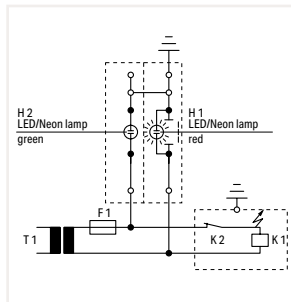

Ground conductor disconnect terminal block – top view

## Fuse Terminal Blocks

- Protect electrical circuits against short-circuiting
- Suitable for miniature metric fuses or blade-style fuses
- Can be assembled into strips and easily replaced if required

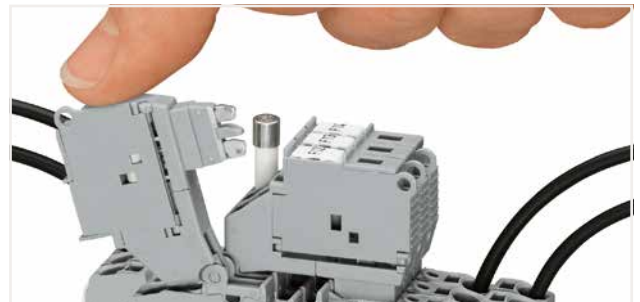

Pivot the fuse holder into the locked open position. Fuse terminal blocks for miniature metric fuses are rated at 2.5 mm<sup>2</sup> (12 AWG) and 6 mm<sup>2</sup> (8 AWG).

# DIODE AND LED TERMINAL BLOCKS

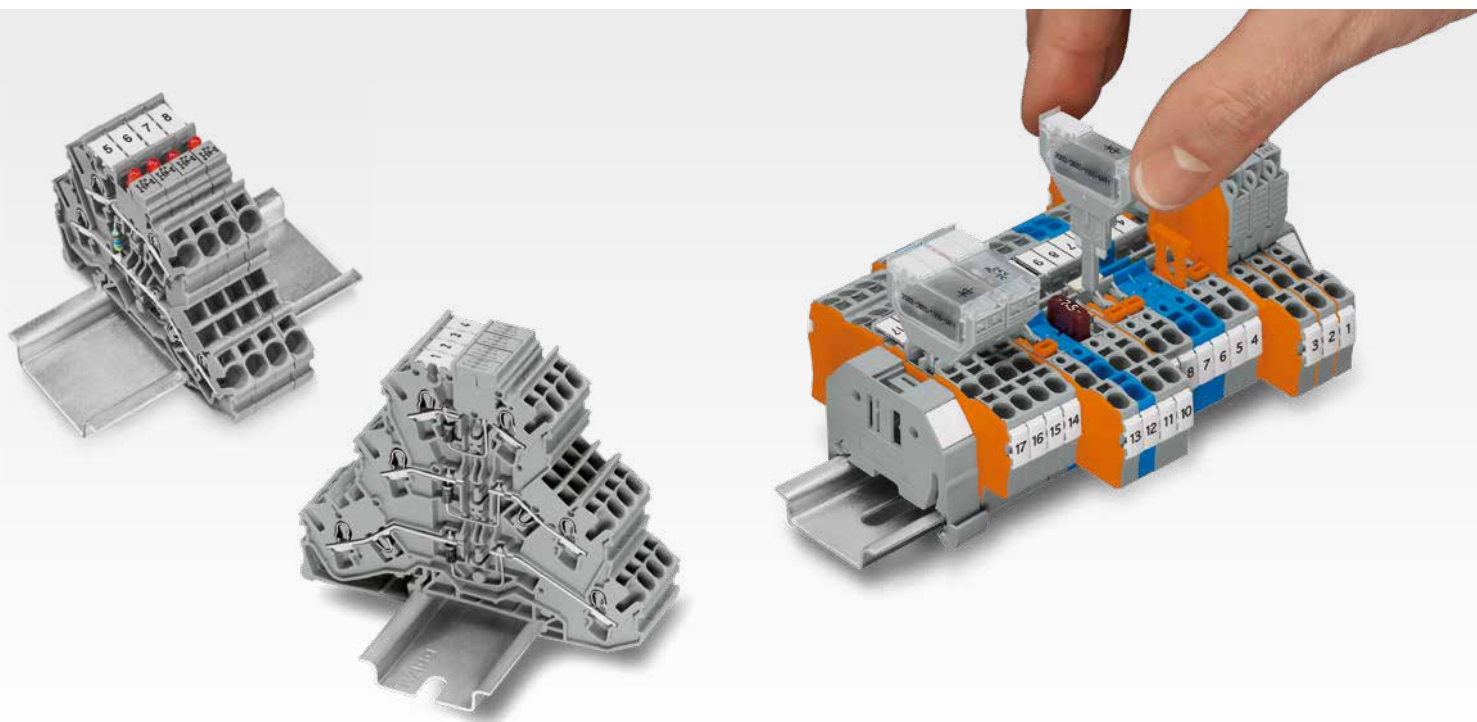

## Double- and Triple-Deck LED and Diode Terminal Blocks

- Design monitoring units (e.g., for control and operating circuits) via LED terminal blocks
- Design custom diode circuits (e.g., lamp test and collective fault signal circuits) using LED terminal blocks
- Design custom circuits via push-in type jumper bars

## Pluggable Diode and LED Modules

- Component plugs can either be pre-assembled, or the components (e.g., diodes, resistors) can be assembled by the user via solder-free connection
- Available in 5.2 mm or 10.4 mm width for carrier terminal blocks or for use in a jumper slot



LED terminal blocks with a red LED



Labeling via WMB Multi markers and marking strips



Test option available



# CURRENT TRANSFORMER AND MOTOR WIRING TERMINAL BLOCKS

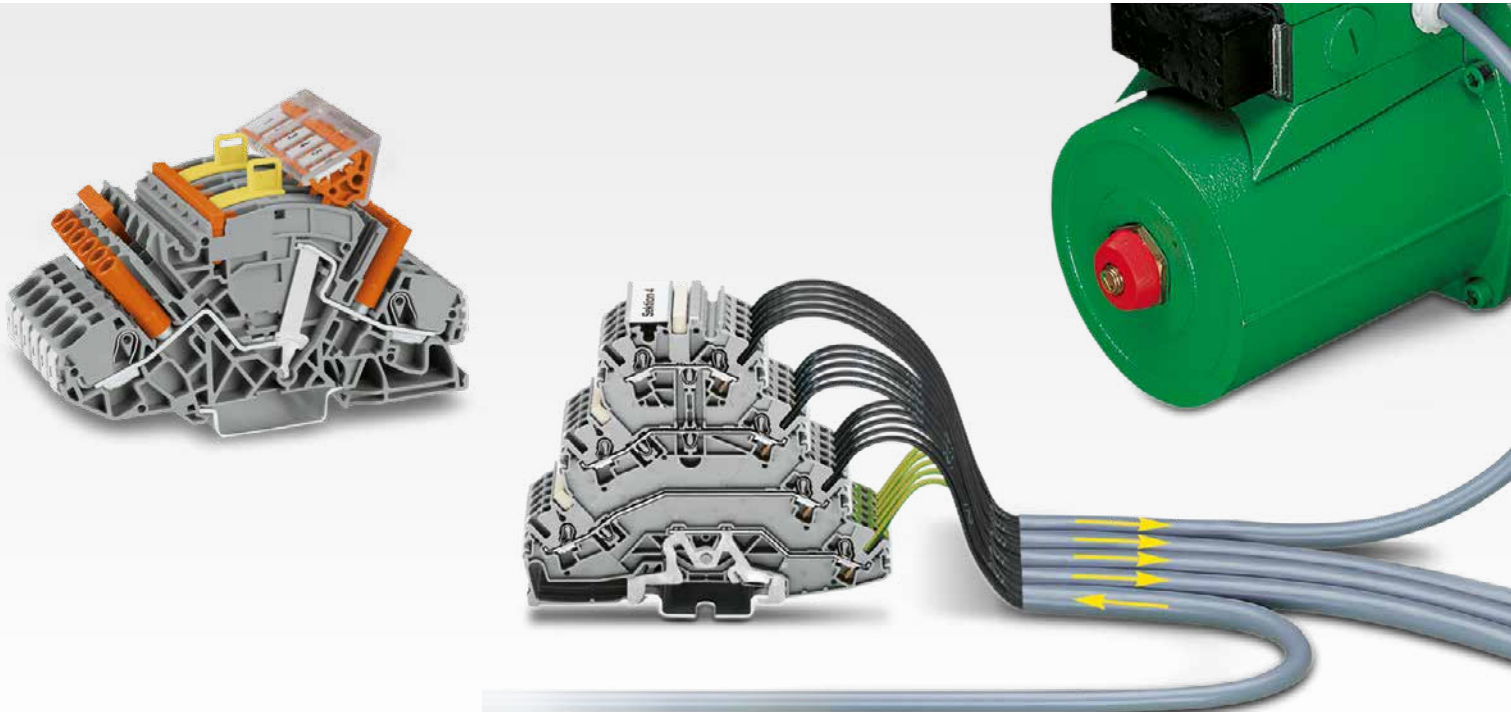

## Current Transformer Terminal Blocks

- Safe, automatic short-circuiting
- Easily test current transformer circuits
- Intuitive orange disconnect links simplify operation
- Directly identify the circuit state via an open, touch-proof design
- Can be clearly labeled



Additional commoning option on the transformer side

## Rail-Mount Terminal Blocks for Electric Motor Wiring

- Quadruple-deck, rail-mount terminal blocks for electric motor wiring
- Compact design: three phases and one ground conductor in a single terminal block
- Specialty versions featuring two or three potentials without a ground contact are also available



Identify clamping units via WMB markers and groups via marking strips



# SENSOR/ACTUATOR TERMINAL BLOCKS

## Send the Right Signals

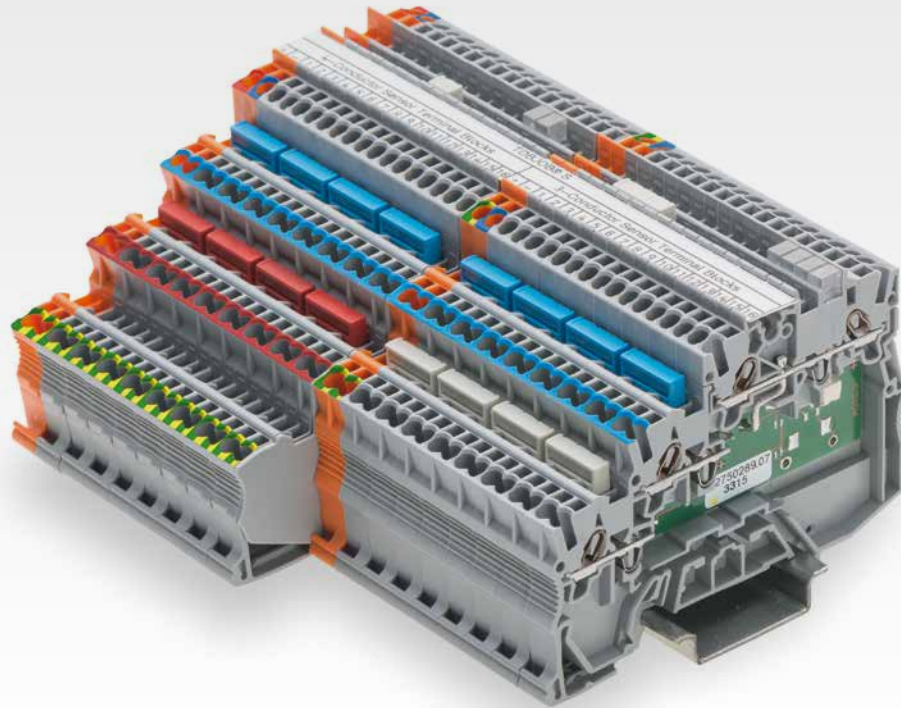

### Maximum Signal Density

- Pack several sensors into the smallest possible space using only 3.5 mm per sensor on the DIN-rail
- Ideal for small terminal boxes within a system's decentralized periphery, as well as for centralized installation in the control cabinet

### Pluggable Diode and LED Modules

- Commoning with standard jumpers – no pole number limitation
- Color-coded jumpers simplify potential assignment



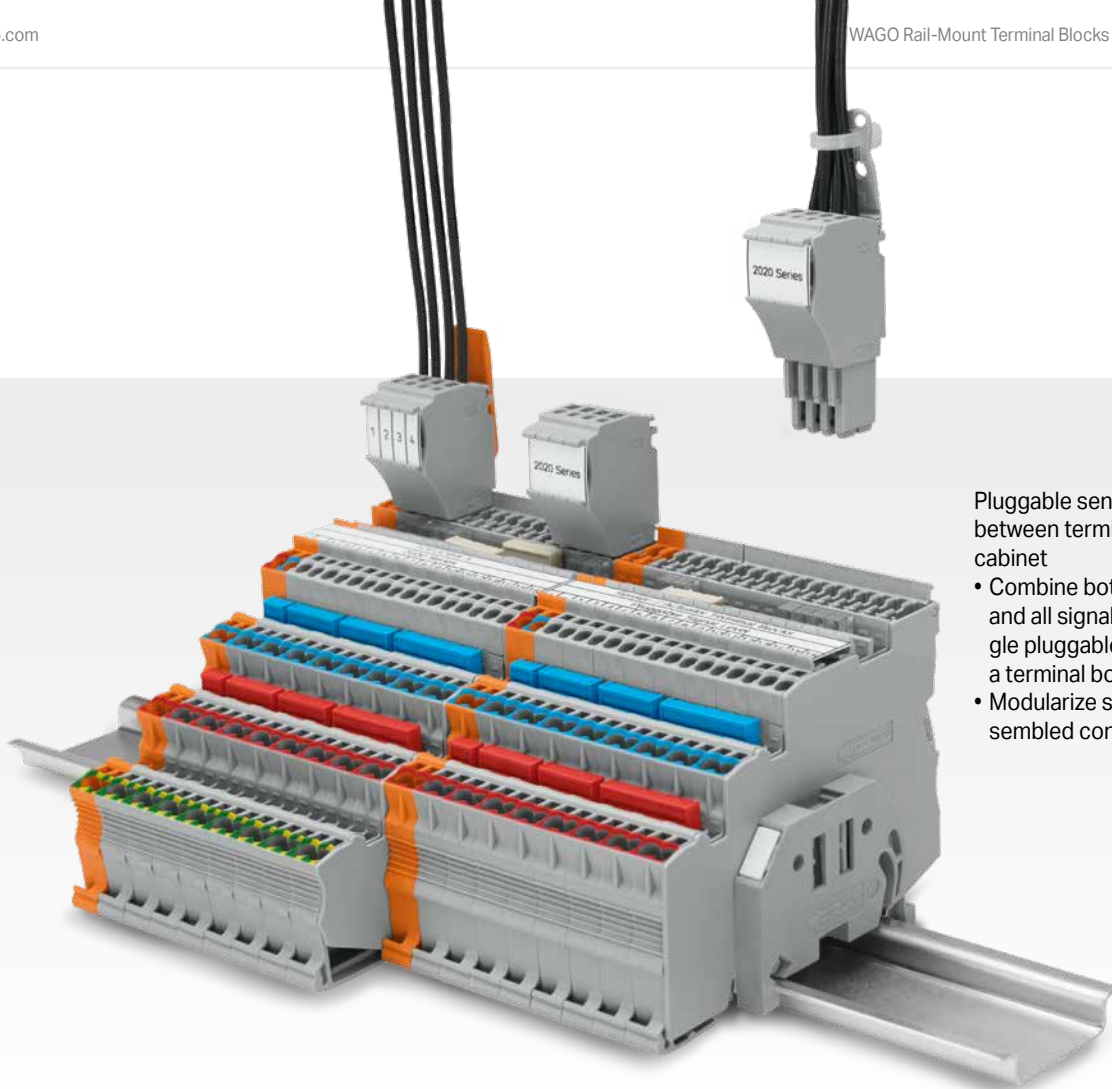

Pluggable sensor/actuator wiring between terminal box and control cabinet

- Combine both power supply and all signal paths into one single pluggable connector within a terminal box
- Modularize systems via pre-assembled connectors

## Fastest Marking System

- Clear identification thanks to multi-line marking strips that don't cover the jumper slot
- Easy to read from any angle thanks to two marker slots on the top and side of the terminal strip



## LED, Wiring and Marking in Plain View

- LEDs, jumpers and markers are always visible – even when wired
- Streamlined terminal block design provides quick wiring overview and a simplified control layout



# Disconnect/Test Terminal Block, Fuse Terminal Block, Carrier Terminal Block, Through Terminal Block TOPJOB® S; with Push-Button 2.5 (4) mm<sup>2</sup>; 2202 Series

Technical Data	
0.25 ... 2.5 (4) mm <sup>2</sup> ①	22 ... 12 AWG
400 V/6 kV/3 ②	
I <sub>N</sub> 16 A	
Terminal block width: 5.2 mm / 0.205 inch	
10 ... 12 mm / 0.39 ... 0.47 inch	

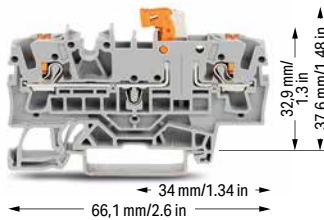

2-conductor disconnect/test terminal block; with push-button; with test point; orange disconnect link

Color	Item No.	VPE
○ gray	2202-1671	50
● blue	2202-1674	50
● orange	2202-1672	50

Technical Data	
0.25 ... 2.5 (4) mm <sup>2</sup> ①	22 ... 12 AWG
400 V/6 kV/3 ②	
I <sub>N</sub> 10 A ③	
Terminal block width: 5.2 mm / 0.205 inch	
10 ... 12 mm / 0.39 ... 0.47 inch	

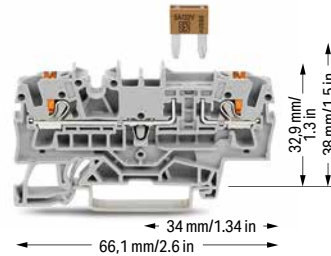

2-conductor fuse terminal block; with push-button; for mini-automotive blade-style fuse; with test point

Color	Item No.	VPE
○ gray	2202-1681	50

Technical Data	
0.25 ... 2.5 (4) mm <sup>2</sup> ①	22 ... 12 AWG
400 V/6 kV/3 ②	
I <sub>N</sub> 16 A	
Terminal block width: 5.2 mm / 0.205 inch	
10 ... 12 mm / 0.39 ... 0.47 inch	

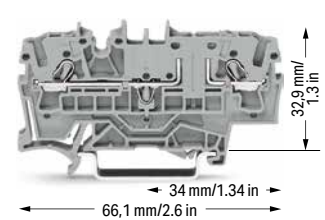

2-conductor carrier terminal block; with push-button; with test point

Color	Item No.	VPE
○ gray	2202-1661	50

**Accessories; item-specific**  
Disconnect plug for carrier terminal blocks; suitable when using a carrier terminal block as disconnect terminal block

	orange	2002-401	100 (25)
---	--------	----------	----------

**Accessories; 2202 Series** Appropriate marking systems: WMB/WMB Inline/Marking strips

End and intermediate plate; 1 mm thick		
	orange	2002-1692 100 (25)
	gray	2002-1691 100 (25)

Insulation stop; 5 pcs/strip; 0.25 ... 0.5 mm <sup>2</sup>		
	light gray	2002-171 200 (25)

Insulation stop; 5 pcs/strip; 0.75 ... 1 mm <sup>2</sup>		
	dark gray	2002-172 200 (25)

Push-in type jumper bar; insulated; I <sub>N</sub> 25 A; light gray		
	2-way	2002-402 25
	3-way	2002-403 25
	4-way	2002-404 25
	5-way	2002-405 25
	6-way	2002-406 25
	7-way	2002-407 25
	8-way	2002-408 25
	9-way	2002-409 25
	10-way	2002-410 25

Push-in type jumper bar; insulated; I <sub>N</sub> 25 A; light gray		
	1 to 3	2002-433 25
	1 to 4	2002-434 25
	1 to 5	2002-435 25
	1 to 6	2002-436 25
	1 to 7	2002-437 25
	1 to 8	2002-438 25
	1 to 9	2002-439 25
	1 to 10	2002-440 25

Delta jumper; insulated; I <sub>N</sub> = I <sub>N</sub> terminal block; light gray		
	1-2 3-4 5-6	2002-406/020-000 25

Star point jumper; insulated; I <sub>N</sub> = I <sub>N</sub> terminal block; light gray		
	1-3-5	2002-405/011-000 25

Staggered jumper; insulated; I <sub>N</sub> 25 A; light gray		
	2-way	2002-472 25
	3-way	2002-473 25
	4-way	2002-474 25
	5-way	2002-475 25
	6-way	2002-476 25
	7-way	2002-477 25
	8-way	2002-478 25
	9-way	2002-479 25
	10-way	2002-480 25
	11-way	2002-481 25
	12-way	2002-482 25

Customized staggered jumper; insulated; with contact lugs broken off at the factory and circuit printing; I <sub>N</sub> 25 A; light gray		
	1-3	2002-473/011-000 25
	1-3-5	2002-475/011-000 25
	1-3-5-7	2002-477/011-000 25
	1-3-5-7-9	2002-479/011-000 25
	1-3-5-7-9-11	2002-481/011-000 25

Adjacent jumper for continuous commoning; insulated; I <sub>N</sub> 25 A; light gray		
	2-way	2002-400 25

Adjacent jumper for continuous commoning; insulated; I <sub>N</sub> 25 A; 1 to 3		
	light gray	2002-423 25
	red	2002-423/000-005 25
	blue	2002-423/000-006 25

Adjacent jumper for continuous commoning; insulated; I <sub>N</sub> 25 A; light gray		
	5-way	2002-415 25

Push-in type wire jumper; insulated; 1.5 mm <sup>2</sup> conductor cross-section; I <sub>N</sub> 18 A		
	L = 60 mm	2009-412 100 (10)
	L = 110 mm	2009-414 100 (10)
	L = 250 mm	2009-416 100 (10)

**Technical Data**

0.25 ... 2.5 (4) mm<sup>2</sup> ① | 22 ... 12 AWG  
 400 V/6 kV/3 ②  
 I<sub>N</sub> 16 A  
 Terminal block width: 5.2 mm / 0.205 inch  
 10 ... 12 mm / 0.39 ... 0.47 inch

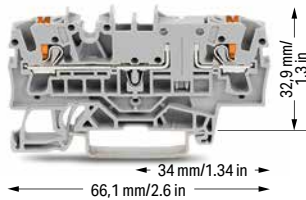

2-conductor through terminal block; with push-button; with test point; same profile as 2-conductor disconnect terminal block

Color	Item No.	VPE
○ gray	2202-1601	50
● blue	2202-1604	50
● orange	2202-1602	50

Other terminal blocks with the same profile:  
 Fuse 2202-1611 Page 86

Modular connector; snaps together; for jumper contact slot

	gray	2002-511	100 (25)
---	------	----------	----------

Spacer module; snaps together; bridges commoned terminal blocks

	gray	2002-549	100 (25)
---	------	----------	----------

End plate; for modular connector; 1.5 mm thick

	gray	2002-541	100 (25)
---	------	----------	----------

① Conductor range: 0.25 ... 4 mm<sup>2</sup> "s+f-st";  
 Push-in termination: 1 ... 4 mm<sup>2</sup> "s" and 1 ... 2.5 mm<sup>2</sup> "insulated ferrules, 12 mm"  
 Depending on the conductor characteristic, a conductor with a smaller cross section can also be inserted via push-in termination.

② 400 V = rated voltage  
 6 kV = rated impulse voltage  
 3 = pollution degree

③ Observe touch-proof protection for 42 V and higher voltages!  
 • 10 A (individual arrangement)  
 • 5 A (block arrangement)

Blade-style fuses are not offered by WAGO.

Please observe the application notes:  
 Jumpers, from page 160  
 Testing accessories, from page 154  
 Marking, from page 246

Approvals and corresponding ratings, visit [www.wago.com](http://www.wago.com)

**Accessories; 2202 Series**

Appropriate marking systems:  
 WMB/WMB Inline/Marking strips

WMB Inline; plain; 1,500 WMB markers (5 mm)/reel; stretchable 5 ... 5.2 mm

	white	2009-115	1
---	-------	----------	---

Marking strip; plain; 11 mm wide; 50 m reel

	white	2009-110	1
---	-------	----------	---

WMB marker card; white; 10 strips with 10 markers/card; stretchable 5 ... 5.2 mm

	plain	793-5501	5
---	-------	----------	---

Sold & Serviced By:



Toll Free Phone (877) SERV098  
[www.electromate.com](http://www.electromate.com)  
[sales@electromate.com](mailto:sales@electromate.com)



# Disconnect/Test Terminal Block, Fuse Terminal Block, Carrier Terminal Block, Through Terminal Block, Ground Conductor Terminal Block TOPJOB® S; with Push-Button

## 2.5 (4) mm<sup>2</sup>; 2202 Series

Technical Data	
0.25 ... 2.5 (4) mm <sup>2</sup> ①	22 ... 12 AWG
400 V/6 kV/3 ②	
I <sub>N</sub> 16 A	
Terminal block width: 5.2 mm / 0.205 inch	
10 ... 12 mm / 0.39 ... 0.47 inch	

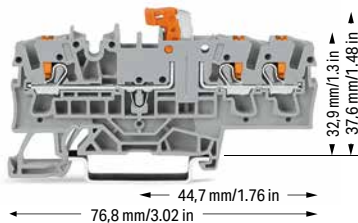

3-conductor disconnect/test terminal block; with push-button; with test point; orange disconnect link

Color	Item No.	VPE
○ gray	2202-1771	50
● blue	2202-1774	50
● orange	2202-1772	50

Technical Data	
0.25 ... 2.5 (4) mm <sup>2</sup> ①	22 ... 12 AWG
400 V/6 kV/3 ②	
I <sub>N</sub> 10 A ③	
Terminal block width: 5.2 mm / 0.205 inch	
10 ... 12 mm / 0.39 ... 0.47 inch	

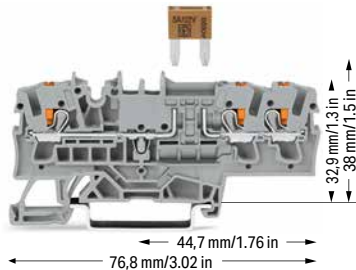

3-conductor fuse terminal block; with push-button; for mini-automotive blade-style fuse; with test point

Color	Item No.	VPE
○ gray	2202-1781	50

Technical Data	
0.25 ... 2.5 (4) mm <sup>2</sup> ①	22 ... 12 AWG
400 V/6 kV/3 ②	
I <sub>N</sub> 16 A	
Terminal block width: 5.2 mm / 0.205 inch	
10 ... 12 mm / 0.39 ... 0.47 inch	

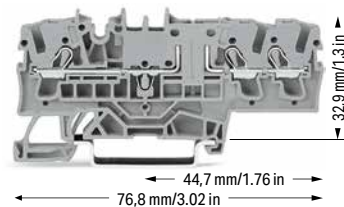

3-conductor carrier terminal block; with push-button; with test point

Color	Item No.	VPE
○ gray	2202-1761	50

**Accessories; item-specific**  
Disconnect plug for carrier terminal blocks; suitable when using a carrier terminal block as disconnect terminal block

	orange	2002-401	100 (25)
--	--------	----------	----------

### Accessories; 2202 Series

Appropriate marking systems: WMB/WMB Inline/Marking strips

End and intermediate plate; 1 mm thick			
	orange	2002-1792	100 (25)
	gray	2002-1791	100 (25)

Insulation stop; 5 pcs/strip; 0.25 ... 0.5 mm <sup>2</sup>			
	light gray	2002-171	200 (25)

Insulation stop; 5 pcs/strip; 0.75 ... 1 mm <sup>2</sup>			
	dark gray	2002-172	200 (25)

Push-in type jumper bar; insulated; I <sub>N</sub> 25 A; light gray			
	2-way	2002-402	25
	3-way	2002-403	25
	4-way	2002-404	25
	5-way	2002-405	25
	6-way	2002-406	25
	7-way	2002-407	25
	8-way	2002-408	25
	9-way	2002-409	25
	10-way	2002-410	25

Delta jumper; insulated; I <sub>N</sub> = I <sub>N</sub> terminal block; light gray			
	1-2 3-4 5-6	2002-406/020-000	25

Push-in type jumper bar; insulated; I <sub>N</sub> 25 A; light gray			
	1 to 3	2002-433	25
	1 to 4	2002-434	25
	1 to 5	2002-435	25
	1 to 6	2002-436	25
	1 to 7	2002-437	25
	1 to 8	2002-438	25
	1 to 9	2002-439	25
	1 to 10	2002-440	25

Star point jumper; insulated; I <sub>N</sub> = I <sub>N</sub> terminal block; light gray			
	1-3-5	2002-405/011-000	25

Staggered jumper; insulated; I <sub>N</sub> 25 A; light gray			
	2-way	2002-472	25
	3-way	2002-473	25
	4-way	2002-474	25
	5-way	2002-475	25
	6-way	2002-476	25
	7-way	2002-477	25
	8-way	2002-478	25
	9-way	2002-479	25
	10-way	2002-480	25
	11-way	2002-481	25
	12-way	2002-482	25

Customized staggered jumper; insulated; with contact lugs broken off at the factory and circuit printing; I <sub>N</sub> 25 A; light gray			
	1-3	2002-473/011-000	25
	1-3-5	2002-475/011-000	25
	1-3-5-7	2002-477/011-000	25
	1-3-5-7-9	2002-479/011-000	25
	1-3-5-7-9-11	2002-481/011-000	25

Adjacent jumper for continuous commoning; insulated; I <sub>N</sub> 25 A; light gray			
	2-way	2002-400	25

Adjacent jumper for continuous commoning; insulated; I <sub>N</sub> 25 A; 1 to 3			
	light gray	2002-423	25
	red	2002-423/000-005	25
	blue	2002-423/000-006	25

Adjacent jumper for continuous commoning; insulated; I <sub>N</sub> 25 A; light gray			
	5-way	2002-415	25

Push-in type wire jumper; insulated; 1.5 mm <sup>2</sup> conductor cross-section; I <sub>N</sub> 18 A			
	L = 60 mm	2009-412	100 (10)
	L = 110 mm	2009-414	100 (10)
	L = 250 mm	2009-416	100 (10)



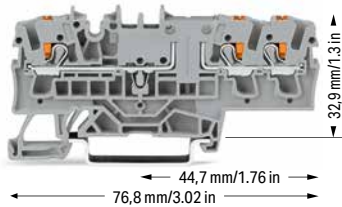

**Technical Data**

0.25 ... 2.5 (4) mm <sup>2</sup> ①	22 ... 12 AWG
400 V/6 kV/3 ②	
I <sub>N</sub> 16 A	
Terminal block width: 5.2 mm / 0.205 inch	
 10 ... 12 mm / 0.39 ... 0.47 inch	



3-conductor through terminal block; with push-button; with test point; same profile as 3-conductor disconnect terminal block

Color	Item No.	VPE
 gray	2202-1701	50
 blue	2202-1704	50
 orange	2202-1702	50

3-conductor ground terminal block; with push-button; with test point

 green-yellow	2202-1707	50
--	-----------	----

Other terminal blocks with the same profile:

Fuse	2202-1711	Page 86
------	-----------	---------

① Conductor range: 0.25 ... 4 mm<sup>2</sup> "s+f-st"; Push-in termination: 1 ... 4 mm<sup>2</sup> "s" and 1 ... 2.5 mm<sup>2</sup> "insulated ferrules, 12 mm" Depending on the conductor characteristic, a conductor with a smaller cross section can also be inserted via push-in termination.

② 400 V = rated voltage  
6 kV = rated impulse voltage  
3 = pollution degree

③ Observe touch-proof protection for 42 V and higher voltages!  
• 10 A (individual arrangement)  
• 5 A (block arrangement)

Blade-style fuses are not offered by WAGO.

Please observe the application notes:  
Jumpers, from page 160  
Testing accessories, from page 154  
Marking, from page 246

Approvals and corresponding ratings, visit [www.wago.com](http://www.wago.com)

**Accessories; 2202 Series**

Appropriate marking systems:  
WMB/WMB Inline/Marking strips

WMB Inline; plain; 1,500 WMB markers (5 mm)/reel; stretchable 5 ... 5.2 mm

white	2009-115	1
-------	----------	---

Marking strip; plain; 11 mm wide; 50 m reel

white	2009-110	1
-------	----------	---

WMB marker card; white; 10 strips with 10 markers/card; stretchable 5 ... 5.2 mm

plain	793-5501	5
-------	----------	---

Modular connector; snaps together; for jumper contact slot

	gray	2002-511	100 (25)
---	------	----------	----------

Spacer module; snaps together; bridges commoned terminal blocks

	gray	2002-549	100 (25)
---	------	----------	----------

End plate; for modular connector; 1.5 mm thick

	gray	2002-541	100 (25)
---	------	----------	----------

# Disconnect/Test Terminal Block, Fuse Terminal Block, Carrier Terminal Block, Through Terminal Block TOPJOB® S; with Push-Button 2.5 (4) mm<sup>2</sup>; 2202 Series

Technical Data	
0.25 ... 2.5 (4) mm <sup>2</sup> ①	22 ... 12 AWG
400 V/6 kV/3 ②	
I <sub>N</sub> 16 A	
Terminal block width: 5.2 mm / 0.205 inch	
 10 ... 12 mm / 0.39 ... 0.47 inch	

Technical Data	
0.25 ... 2.5 (4) mm <sup>2</sup> ①	22 ... 12 AWG
400 V/6 kV/3 ②	
I <sub>N</sub> 10 A ③	
Terminal block width: 5.2 mm / 0.205 inch	
 10 ... 12 mm / 0.39 ... 0.47 inch	

Technical Data	
0.25 ... 2.5 (4) mm <sup>2</sup> ①	22 ... 12 AWG
400 V/6 kV/3 ②	
I <sub>N</sub> 16 A	
Terminal block width: 5.2 mm / 0.205 inch	
 10 ... 12 mm / 0.39 ... 0.47 inch	

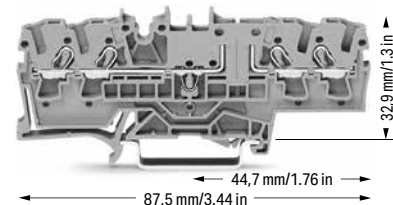
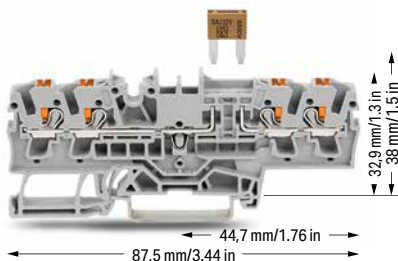
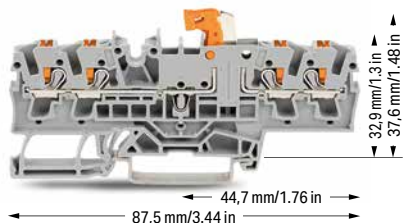

4-conductor disconnect/test terminal block; with push-button; with test point; orange disconnect link

4-conductor fuse terminal block; with push-button; for mini-automotive blade-style fuse; with test point

4-conductor carrier terminal block; with push-button; with test point

Color	Item No.	VPE
○ gray	2202-1871	50
● blue	2202-1874	50
● orange	2202-1872	50

Color	Item No.	VPE
○ gray	2202-1881	50

Color	Item No.	VPE
○ gray	2202-1861	50

### Accessories; item-specific

Disconnect plug for carrier terminal blocks; suitable when using a carrier terminal block as disconnect terminal block

	orange	2002-401	100 (25)
---	--------	----------	----------

### Accessories; 2202 Series

Appropriate marking systems: WMB/WMB Inline/Marking strips

End and intermediate plate; 1 mm thick		
	orange	2002-1892 100 (25)
	gray	2002-1891 100 (25)

Insulation stop; 5 pcs/strip; 0.25 ... 0.5 mm <sup>2</sup>		
	light gray	2002-171 200 (25)

Insulation stop; 5 pcs/strip; 0.75 ... 1 mm <sup>2</sup>		
	dark gray	2002-172 200 (25)

Push-in type jumper bar; insulated; I <sub>N</sub> 25 A; light gray		
	2-way	2002-402 25
	3-way	2002-403 25
	4-way	2002-404 25
	5-way	2002-405 25
	6-way	2002-406 25
	7-way	2002-407 25
	8-way	2002-408 25
	9-way	2002-409 25
	10-way	2002-410 25

Push-in type jumper bar; insulated; I <sub>N</sub> 25 A; light gray		
	1 to 3	2002-433 25
	1 to 4	2002-434 25
	1 to 5	2002-435 25
	1 to 6	2002-436 25
	1 to 7	2002-437 25
	1 to 8	2002-438 25
	1 to 9	2002-439 25
	1 to 10	2002-440 25

Delta jumper; insulated; I <sub>N</sub> = I <sub>N</sub> terminal block; light gray		
	1-2 3-4 5-6	2002-406/020-000 25

Star point jumper; insulated; I <sub>N</sub> = I <sub>N</sub> terminal block; light gray		
	1-3-5	2002-405/011-000 25

Staggered jumper; insulated; I <sub>N</sub> 25 A; light gray		
	2-way	2002-472 25
	3-way	2002-473 25
	4-way	2002-474 25
	5-way	2002-475 25
	6-way	2002-476 25
	7-way	2002-477 25
	8-way	2002-478 25
	9-way	2002-479 25
	10-way	2002-480 25
	11-way	2002-481 25
	12-way	2002-482 25

Customized staggered jumper; insulated; with contact lugs broken off at the factory and circuit printing; I<sub>N</sub> 25 A; light gray

	1-3	2002-473/011-000 25
	1-3-5	2002-475/011-000 25
	1-3-5-7	2002-477/011-000 25
	1-3-5-7-9	2002-479/011-000 25
	1-3-5-7-9-11	2002-481/011-000 25

Adjacent jumper for continuous commoning; insulated; I <sub>N</sub> 25 A; light gray		
	2-way	2002-400 25

Adjacent jumper for continuous commoning; insulated; I <sub>N</sub> 25 A; 1 to 3		
	light gray	2002-423 25
	red	2002-423/000-005 25
	blue	2002-423/000-006 25

Adjacent jumper for continuous commoning; insulated; I <sub>N</sub> 25 A; light gray		
	5-way	2002-415 25

Push-in type wire jumper; insulated; 1.5 mm<sup>2</sup> conductor cross-section; I<sub>N</sub> 18 A



	L = 60 mm	2009-412 100 (10)
	L = 110 mm	2009-414 100 (10)
	L = 250 mm	2009-416 100 (10)

**Technical Data**

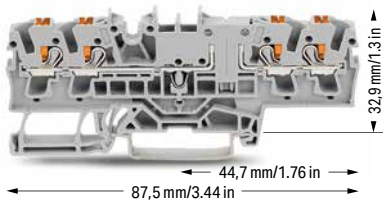
0.25 ... 2.5 (4) mm <sup>2</sup> ①	22 ... 12 AWG
400 V/6 kV/3 ②	
I <sub>N</sub> 16 A	
Terminal block width: 5.2 mm / 0.205 inch	
 10 ... 12 mm / 0.39 ... 0.47 inch	



4-conductor through terminal block; with push-button; with test point; same profile as 4-conductor disconnect terminal block

Color	Item No.	VPE
 gray	2202-1801	50
 blue	2202-1804	50
 orange	2202-1802	50

Other terminal blocks with the same profile:		
Fuse	2202-1811	Page 87

① Conductor range: 0.25 ... 4 mm<sup>2</sup> "s+f-st";  
Push-in termination: 1 ... 4 mm<sup>2</sup> "s" and 1 ... 2.5 mm<sup>2</sup> "insulated ferrules, 12 mm"  
Depending on the conductor characteristic, a conductor with a smaller cross section can also be inserted via push-in termination.

② 400 V = rated voltage  
6 kV = rated impulse voltage  
3 = pollution degree

③ Observe touch-proof protection for 42 V and higher voltages!  
• 10 A (individual arrangement)  
• 5 A (block arrangement)

Blade-style fuses are not offered by WAGO.

Please observe the application notes:  
Jumpers, from page 160  
Testing accessories, from page 154  
Marking, from page 246

Approvals and corresponding ratings, visit [www.wago.com](http://www.wago.com)

**Accessories; 2202 Series**  
Appropriate marking systems:  
WMB/WMB Inline/Marking strips

WMB Inline; plain; 1,500 WMB markers (5 mm)/reel; stretchable 5 ... 5.2 mm

white	2009-115	1
-------	----------	---

Marking strip; plain; 11 mm wide; 50 m reel

white	2009-110	1
-------	----------	---

WMB marker card; white; 10 strips with 10 markers/card; stretchable 5 ... 5.2 mm

plain	793-5501	5
-------	----------	---

Modular connector; snaps together; for jumper contact slot

	gray	2002-511	100 (25)
---	------	----------	----------

Spacer module; snaps together; bridges commoned terminal blocks

	gray	2002-549	100 (25)
---	------	----------	----------

End plate; for modular connector; 1.5 mm thick

	gray	2002-541	100 (25)
---	------	----------	----------

# Disconnect/Test Terminal Block, Fuse Terminal Block, Carrier Terminal Block, Through Terminal Block, Ground Conductor Terminal Block TOPJOB® S; with Push-Button; with Additional Jumper Slot 2.5 (4) mm<sup>2</sup>; 2202 Series

Technical Data	
0.25 ... 2.5 (4) mm <sup>2</sup> ①	22 ... 12 AWG
400 V/6 kV/3 ②	
I <sub>N</sub> 16 A	
Terminal block width: 5.2 mm / 0.205 inch	
10 ... 12 mm / 0.39 ... 0.47 inch	

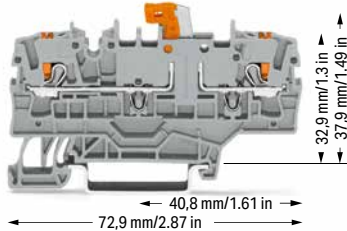

2-conductor disconnect/test terminal block; with push-button; with test point; orange disconnect link; with additional jumper slot

Color	Item No.	VPE
○ gray	2202-1971	50
● blue	2202-1974	50
● orange	2202-1972	50

Technical Data	
0.25 ... 2.5 (4) mm <sup>2</sup> ①	22 ... 12 AWG
400 V/6 kV/3 ②	
I <sub>N</sub> 10 A ③	
Terminal block width: 5.2 mm / 0.205 inch	
10 ... 12 mm / 0.39 ... 0.47 inch	

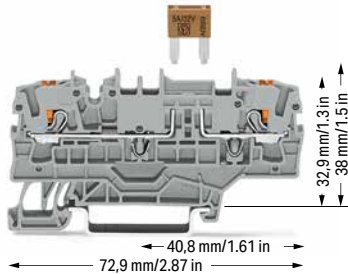

2-conductor fuse terminal block; with push-button; for mini-automotive blade-style fuse; with test point; without blown fuse indication; with additional jumper slot  
Electrical ratings are given by the fuse. Blade-style fuses: Observe touch-proof protection for 42 V and higher voltages!

Color	Item No.	VPE
○ gray	2202-1981	50

Technical Data	
0.25 ... 2.5 (4) mm <sup>2</sup> ①	22 ... 12 AWG
400 V/6 kV/3 ②	
I <sub>N</sub> 16 A	
Terminal block width: 5.2 mm / 0.205 inch	
10 ... 12 mm / 0.39 ... 0.47 inch	

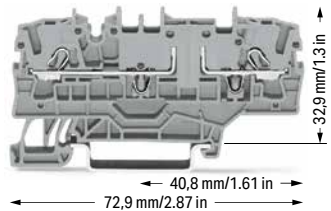

2-conductor carrier terminal block; with push-button; with test point; with additional jumper slot

Color	Item No.	VPE
○ gray	2202-1961	50



### Accessories; item-specific

Disconnect plug for carrier terminal blocks; suitable when using a carrier terminal block as disconnect terminal block

	orange	2002-401	100 (25)
---	--------	----------	----------









### Accessories; 2202 Series









Appropriate marking systems: WMB/WMB Inline/Marking strips

End and intermediate plate; 1 mm thick			
	orange	2002-1992	100 (25)
	gray	2002-1991	100 (25)

Insulation stop; 5 pcs/strip; 0.25 ... 0.5 mm <sup>2</sup>			
	light gray	2002-171	200 (25)

Insulation stop; 5 pcs/strip; 0.75 ... 1 mm <sup>2</sup>			
	dark gray	2002-172	200 (25)











Push-in type jumper bar; insulated; I <sub>N</sub> 25 A; light gray			
	2-way	2002-402	25
	3-way	2002-403	25
	4-way	2002-404	25
	5-way	2002-405	25
	6-way	2002-406	25
	7-way	2002-407	25
	8-way	2002-408	25
	9-way	2002-409	25
	10-way	2002-410	25





Push-in type jumper bar; insulated; I <sub>N</sub> 25 A; light gray			
	1 to 3	2002-433	25
	1 to 4	2002-434	25
	1 to 5	2002-435	25
	1 to 6	2002-436	25
	1 to 7	2002-437	25
	1 to 8	2002-438	25
	1 to 9	2002-439	25
	1 to 10	2002-440	25

Delta jumper; insulated; I <sub>N</sub> = I <sub>N</sub> terminal block; light gray			
	1-2 3-4 5-6	2002-406/020-000	25

Star point jumper; insulated; I <sub>N</sub> = I <sub>N</sub> terminal block; light gray			
	1-3-5	2002-405/011-000	25

Adjacent jumper for continuous commoning; insulated; I <sub>N</sub> 25 A; light gray			
	2-way	2002-400	25

Staggered jumper; insulated; I <sub>N</sub> 25 A; light gray			
	2-way	2002-472	25
	3-way	2002-473	25
	4-way	2002-474	25
	5-way	2002-475	25
	6-way	2002-476	25
	7-way	2002-477	25
	8-way	2002-478	25
	9-way	2002-479	25
	10-way	2002-480	25
	11-way	2002-481	25
	12-way	2002-482	25

Customized staggered jumper; insulated; with contact lugs broken off at the factory and circuit printing; I <sub>N</sub> 25 A; light gray			
	1-3	2002-473/011-000	25
	1-3-5	2002-475/011-000	25
	1-3-5-7	2002-477/011-000	25
	1-3-5-7-9	2002-479/011-000	25
	1-3-5-7-9-11	2002-481/011-000	25

**Technical Data**

0.25 ... 2.5 (4) mm<sup>2</sup> ① | 22 ... 12 AWG  
 400 V/6 kV/3 ②  
 I<sub>N</sub> 16 A  
 Terminal block width: 5.2 mm / 0.205 inch  
 10 ... 12 mm / 0.39 ... 0.47 inch

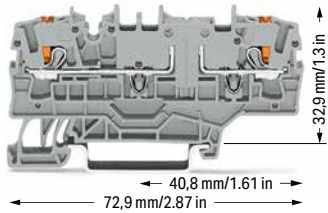

2-conductor through terminal block; with push-button; with test point; with additional jumper slot; same profile as 2-conductor disconnect terminal block

Color	Item No.	VPE
gray	2202-1901	50
blue	2202-1904	50
orange	2202-1902	50



2-conductor ground terminal block; with push-button; with test point; with additional jumper slot

green-yellow	2202-1907	50
--------------	-----------	----

Other terminal blocks with the same profile:

Fuse	2202-1911	Page 86
------	-----------	---------

Adjacent jumper for continuous commoning; insulated; I<sub>N</sub> 25 A; 1 to 3

	light gray	2002-423	25
	red	2002-423/000-005	25
	blue	2002-423/000-006	25

Adjacent jumper for continuous commoning; insulated; I<sub>N</sub> 25 A, light gray

	5-way	2002-415	25
---	-------	----------	----

Push-in type wire jumper; insulated; 1.5 mm<sup>2</sup> conductor cross-section; I<sub>N</sub> 18 A

	L = 60 mm	2009-412	100 (10)
	L = 110 mm	2009-414	100 (10)
	L = 250 mm	2009-416	100 (10)

Modular connector; snaps together; for jumper contact slot

	gray	2002-511	100 (25)
---	------	----------	----------

① Conductor range: 0.25 ... 4 mm<sup>2</sup> "s+f-st"; Push-in termination: 1 ... 4 mm<sup>2</sup> "s" and 1 ... 2.5 mm<sup>2</sup> "insulated ferrules, 12 mm" Depending on the conductor characteristic, a conductor with a smaller cross section can also be inserted via push-in termination.

② 400 V = rated voltage  
 6 kV = rated impulse voltage  
 3 = pollution degree

③ Observe touch-proof protection for 42 V and higher voltages!  
 • 10 A (individual arrangement)  
 • 5 A (block arrangement)

Blade-style fuses are not offered by WAGO.

Please observe the application notes:  
 Jumpers, from page 160  
 Testing accessories, from page 154  
 Marking, from page 246

Approvals and corresponding ratings, visit [www.wago.com](http://www.wago.com)

**Accessories; 2202 Series**

Appropriate marking systems:  
 WMB/WMB Inline/Marking strips

Spacer module; snaps together; bridges commoned terminal blocks

	gray	2002-549	100 (25)
---	------	----------	----------

End plate; for modular connector; 1.5 mm thick

	gray	2002-541	100 (25)
---	------	----------	----------

WMB Inline; plain; 1,500 WMB markers (5 mm)/reel; stretchable 5 ... 5.2 mm

	white	2009-115	1
---	-------	----------	---

Marking strip; plain; 11 mm wide; 50 m reel

	white	2009-110	1
---	-------	----------	---

WMB marker card; white; 10 strips with 10 markers/card; stretchable 5 ... 5.2 mm

	plain	793-5501	5
---	-------	----------	---

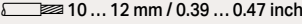

# Fuse Terminal Block TOPJOB® S; with Push-Button; for Mini-Automotive Blade-Style Fuse; with Additional Jumper Slot 2.5 (4) mm<sup>2</sup>; 2202 Series

Technical Data	
0.25 ... 2.5 (4) mm <sup>2</sup> ①	22 ... 12 AWG
400 V/6 kV/3 ②	
I <sub>N</sub> 10 A ③	
Terminal block width: 5.2 mm / 0.205 inch	
 10 ... 12 mm / 0.39 ... 0.47 inch	

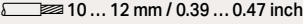
Technical Data	
0.25 ... 2.5 (4) mm <sup>2</sup> ①	22 ... 12 AWG
400 V/6 kV/3 ②	
I <sub>N</sub> 10 A ③	
Terminal block width: 5.2 mm / 0.205 inch	
 10 ... 12 mm / 0.39 ... 0.47 inch	

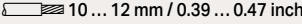
Technical Data	
0.25 ... 2.5 (4) mm <sup>2</sup> ①	22 ... 12 AWG
400 V/6 kV/3 ②	
I <sub>N</sub> 10 A ③	
Terminal block width: 5.2 mm / 0.205 inch	
 10 ... 12 mm / 0.39 ... 0.47 inch	

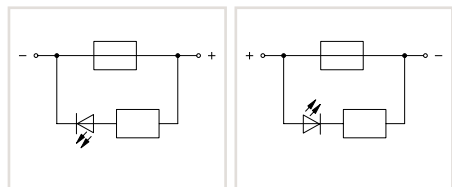
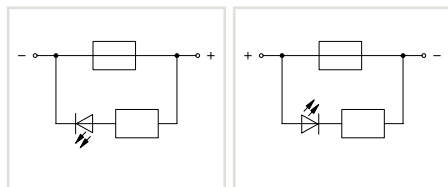
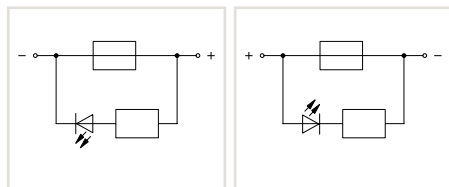
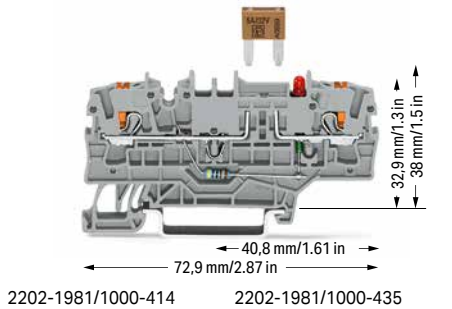
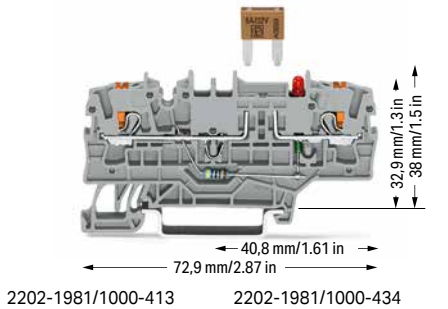
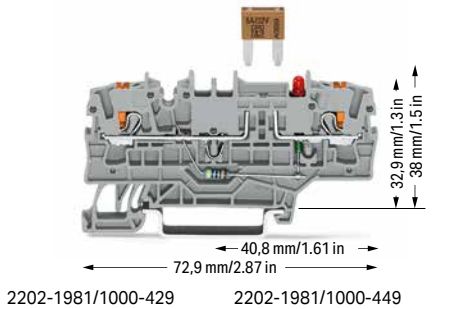

2-conductor fuse terminal block; with push-button; for mini-automotive blade-style fuse; with test point; 12 V; with blown fuse indication by LED; LED power consumption: 4.8 mA; with additional jumper slot  
Electrical ratings are given by the fuse and blown fuse indication. Blade-style fuses: Observe touch-proof protection for 42 V and higher voltages!

2-conductor fuse terminal block; with push-button; for mini-automotive blade-style fuse; with test point; 24 V; with blown fuse indication by LED; LED power consumption: 4.8 mA; with additional jumper slot  
Electrical ratings are given by the fuse and blown fuse indication. Blade-style fuses: Observe touch-proof protection for 42 V and higher voltages!

2-conductor fuse terminal block; with push-button; for mini-automotive blade-style fuse; with test point; 48 V; with blown fuse indication by LED; LED power consumption: 4.8 mA; with additional jumper slot  
Electrical ratings are given by the fuse and blown fuse indication. Blade-style fuses: Observe touch-proof protection for 42 V and higher voltages!

Color	Item No.	Pack. Unit
○ gray	2202-1981/1000-429	50
○ gray	2202-1981/1000-449	50

Color	Item No.	Pack. Unit
○ gray	2202-1981/1000-413	50
○ gray	2202-1981/1000-434	50

Color	Item No.	Pack. Unit
○ gray	2202-1981/1000-414	50
○ gray	2202-1981/1000-435	50

Other terminal blocks with the same profile  
Through [2202-1901](#) [Page 83](#)



## Accessories; 2202 Series









Appropriate marking systems: WMB/WMB Inline/Marking strips









End and intermediate plate; 1 mm thick			
	orange	2002-1992	100 (25)
	gray	2002-1991	100 (25)











Insulation stop; 5 pcs/strip; 0.25 ... 0.5 mm <sup>2</sup>			
	light gray	2002-171	200 (25)

Insulation stop; 5 pcs/strip; 0.75 ... 1 mm <sup>2</sup>			
	dark gray	2002-172	200 (25)



Push-in type wire jumper; insulated; 1.5 mm <sup>2</sup> conductor cross-section; I <sub>N</sub> 18 A			
	L = 60 mm	2009-412	100 (10)
	L = 110 mm	2009-414	100 (10)
	L = 250 mm	2009-416	100 (10)

Push-in type jumper bar; insulated; I <sub>N</sub> 25 A; light gray			
	2-way	2002-402	25
	3-way	2002-403	25
	4-way	2002-404	25
	5-way	2002-405	25
	6-way	2002-406	25
	7-way	2002-407	25
	8-way	2002-408	25
	9-way	2002-409	25
	10-way	2002-410	25

Push-in type jumper bar; insulated; I <sub>N</sub> 25 A; light gray			
	1 to 3	2002-433	25
	1 to 4	2002-434	25
	1 to 5	2002-435	25
	1 to 6	2002-436	25
	1 to 7	2002-437	25
	1 to 8	2002-438	25
	1 to 9	2002-439	25
	1 to 10	2002-440	25

Staggered jumper; insulated; I <sub>N</sub> 25 A; light gray			
	2-way	2002-472	25
	3-way	2002-473	25
	4-way	2002-474	25
	5-way	2002-475	25
	6-way	2002-476	25
	7-way	2002-477	25
	8-way	2002-478	25
	9-way	2002-479	25
	10-way	2002-480	25
	11-way	2002-481	25
	12-way	2002-482	25

Adjacent jumper for continuous commoning; insulated; I <sub>N</sub> 25 A; light gray			
	2-way	2002-400	25

Adjacent jumper for continuous commoning; insulated; I <sub>N</sub> 25 A; 1 to 3			
	light gray	2002-423	25
	red	2002-423/000-005	25
	blue	2002-423/000-006	25

Adjacent jumper for continuous commoning; insulated; I <sub>N</sub> 25 A; light gray			
	5-way	2002-415	25

## Technical Data

0.25 ... 2.5 (4) mm<sup>2</sup> ① | 22 ... 12 AWG

400 V/6 kV/3 ②

I<sub>N</sub> 10 A ③

Terminal block width: 5.2 mm / 0.205 inch

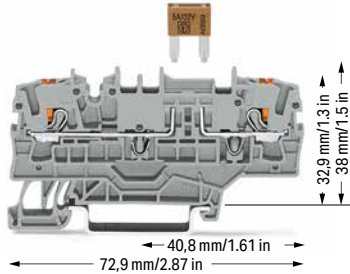
 10 ... 12 mm / 0.39 ... 0.47 inch

① Conductor range: 0.25 ... 2.5 mm<sup>2</sup> "s+f-st" and 0.25 ... 4 mm<sup>2</sup> "s";  
Push-in termination: 1 ... 4 mm<sup>2</sup> "s" and 1 ... 2.5 mm<sup>2</sup> "insulated ferrules, 12 mm"  
Depending on the conductor characteristic, a conductor with a smaller cross section can also be inserted via push-in termination.

② 400 V = rated voltage  
6 kV = rated impulse voltage  
3 = pollution degree

③ Observe touch-proof protection for 42 V and higher voltages!  
• 10 A (individual arrangement)  
• 5 A (block arrangement)

Blade-style fuses are not offered by WAGO.

Please observe the application notes:  
Jumpers, from page 160  
Testing accessories, from page 154  
Marking, from page 246

Approvals and corresponding ratings,  
visit [www.wago.com](http://www.wago.com)

2-conductor fuse terminal block; with push-button; for mini-automotive blade-style fuse; with test point; without blown fuse indication; with additional jumper slot  
Electrical ratings are given by the fuse. Blade-style fuses: Observe touch-proof protection for 42 V and higher voltages!

Color	Item No.	Pack. Unit
○ gray	2202-1981	50

WMB Inline; plain; 1,500 WMB markers (5 mm)/reel; stretchable 5 ... 5.2 mm

white	2009-115	1
-------	----------	---

Marking strip; plain; 11 mm wide; 50 m reel

white	2009-110	1
-------	----------	---

WMB marker card; white; 10 strips with 10 markers/card; stretchable 5 ... 5.2 mm

plain	793-5501	5
-------	----------	---

Double-deck marker carrier; pivoting

gray	2002-121	50 (25)
------	----------	---------

# Fused Disconnect Terminal Block with a Pivoting Fuse Holder TOPJOB® S; with Push-Button; for (5 x 20) mm Glass Cartridge Fuse 2.5 (4) mm<sup>2</sup>; 2202 Series

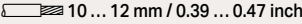
Technical Data	
0.25 ... 2.5 (4) mm <sup>2</sup> ①	22 ... 12 AWG
250 V/6 kV/3 ②	
I <sub>N</sub> 6.3 A	
Terminal block width: 6.2 mm / 0.244 inch	
 10 ... 12 mm / 0.39 ... 0.47 inch	

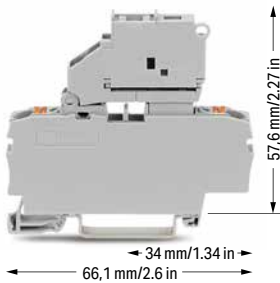

2-conductor fused disconnect terminal block with a pivoting fuse holder; with push-button; for (5 x 20) mm glass cartridge fuse; without blown fuse indication  
Electrical ratings are given by the fuse.

	Item No.	Pack. Unit
○ gray	2202-1611	50

2-conductor fused disconnect terminal block with a pivoting fuse holder; with push-button; for (5 x 20) mm glass cartridge fuse; with blown fuse indication by LED; gray  
Electrical ratings are given by the fuse and blown fuse indication. Leakage current in case of a blown fuse: LED 2 mA

○ 12 ... 30 V	2202-1611/1000-541	50
○ 30 ... 65 V	2202-1611/1000-542	50
○ 120 V	2202-1611/1000-867	50
○ 230 V	2202-1611/1000-836	50

Other terminal blocks with the same profile:		
Through	2202-1601	Page 77

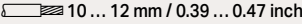
Technical Data	
0.25 ... 2.5 (4) mm <sup>2</sup> ①	22 ... 12 AWG
250 V/6 kV/3 ②	
I <sub>N</sub> 6.3 A	
Terminal block width: 6.2 mm / 0.244 inch	
 10 ... 12 mm / 0.39 ... 0.47 inch	

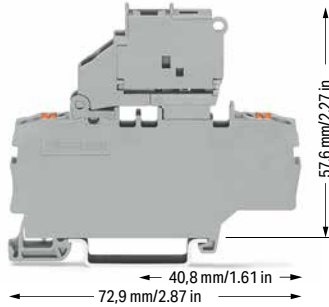

2-conductor fused disconnect terminal block with a pivoting fuse holder; with push-button; with additional jumper slot; for (5 x 20) mm glass cartridge fuse; without blown fuse indication  
Electrical ratings are given by the fuse.

	Item No.	Pack. Unit
○ gray	2202-1911	50

2-conductor fused disconnect terminal block with a pivoting fuse holder; with push-button; with additional jumper slot; for (5 x 20) mm glass cartridge fuse; with blown fuse indication; gray  
Electrical ratings are given by the fuse and blown fuse indication. Leakage current in case of a blown fuse: LED 2 mA

○ 12 ... 30 V	2202-1911/1000-541	50
○ 30 ... 65 V	2202-1911/1000-542	50
○ 120 V	2202-1911/1000-867	50
○ 230 V	2202-1911/1000-836	50

Other terminal blocks with the same profile:		
Through	2202-1901	Page 83

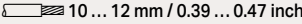
Technical Data	
0.25 ... 2.5 (4) mm <sup>2</sup> ①	22 ... 12 AWG
250 V/6 kV/3 ②	
I <sub>N</sub> 6.3 A	
Terminal block width: 6.2 mm / 0.244 inch	
 10 ... 12 mm / 0.39 ... 0.47 inch	



3-conductor fused disconnect terminal block with a pivoting fuse holder; with push-button; for (5 x 20) mm glass cartridge fuse; without blown fuse indication  
Electrical ratings are given by the fuse.

	Item No.	Pack. Unit
○ gray	2202-1711	50

3-conductor fused disconnect terminal block with a pivoting fuse holder; with push-button; for (5 x 20) mm glass cartridge fuse; with blown fuse indication by LED; gray  
Electrical ratings are given by the fuse and blown fuse indication. Leakage current in case of a blown fuse: LED 2 mA

○ 12 ... 30 V	2202-1711/1000-541	50
○ 30 ... 65 V	2202-1711/1000-542	50
○ 120 V	2202-1711/1000-867	50
○ 230 V	2202-1711/1000-836	50

Other terminal blocks with the same profile:		
Through	2202-1701	Page 79

## Accessories; 2202 Series

Appropriate marking systems: WMB/WMB Inline/Marking strips

End plate for fuse terminal blocks; 2 mm thick			
	orange	2002-992	100 (25)
	gray	2002-991	100 (25)

Insulation stop; 5 pcs/strip; 0.25 ... 0.5 mm <sup>2</sup>			
	light gray	2002-171	200 (25)

Insulation stop; 5 pcs/strip; 0.75 ... 1 mm <sup>2</sup>			
	dark gray	2002-172	200 (25)

Push-in type wire jumper; insulated; 1.5 mm <sup>2</sup> conductor cross section; I <sub>N</sub> 18 A			
	L = 60 mm	2009-412	100 (10)
	L = 110 mm	2009-414	100 (10)
	L = 250 mm	2009-416	100 (10)

Push-in type jumper bar; insulated; I <sub>N</sub> 32 A; light gray			
	2-way	2004-402	25
	3-way	2004-403	25
	4-way	2004-404	25
	5-way	2004-405	25
	6-way	2004-406	25
	7-way	2004-407	25
	8-way	2004-408	25
	9-way	2004-409	25
	10-way	2004-410	25

Push-in type jumper bar; insulated; I <sub>N</sub> 32 A; light gray			
	1 to 3	2004-433	25
	1 to 4	2004-434	25
	1 to 5	2004-435	25
	1 to 6	2004-436	25
	1 to 7	2004-437	25
	1 to 8	2004-438	25
	1 to 9	2004-439	25
	1 to 10	2004-440	25

## Technical Data

0.25 ... 2.5 (4) mm<sup>2</sup> ① | 22 ... 12 AWG

250 V/6 kV/3 ②

I<sub>N</sub> 6.3 A

Terminal block width: 6.2 mm / 0.244 inch

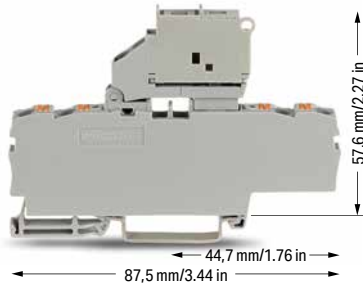
 10 ... 12 mm / 0.39 ... 0.47 inch

4-conductor fused disconnect terminal block with a pivoting fuse holder; with push-button; for (5 x 20) mm glass cartridge fuse; without blown fuse indication  
Electrical ratings are given by the fuse.

	Item No.	Pack. Unit
<input type="radio"/> gray	2202-1811	50

4-conductor fused disconnect terminal block with a pivoting fuse holder; with push-button; for (5 x 20) mm glass cartridge fuse; with blown fuse indication by LED; gray  
Electrical ratings are given by the fuse and blown fuse indication. Leakage current in case of a blown fuse: LED 2 mA

<input type="radio"/> 12 ... 30 V	2202-1811/1000-541	50
<input type="radio"/> 30 ... 65 V	2202-1811/1000-542	50
<input type="radio"/> 120 V	2202-1811/1000-867	50
<input type="radio"/> 230 V	2202-1811/1000-836	50

## Other terminal blocks with the same profile:

Through	2202-1801	Page 81
---------	-----------	---------

① Conductor range: 0.25 ... 2.5 mm<sup>2</sup> "s+f-st" and 0.25 ... 4 mm<sup>2</sup> "s";  
Push-in termination: 1 ... 4 mm<sup>2</sup> "s" and 1 ... 2.5 mm<sup>2</sup> "insulated ferrules, 12 mm"  
Depending on the conductor characteristic, a conductor with a smaller cross section can also be inserted via push-in termination.

② 250 V = rated voltage  
6 kV = rated impulse voltage  
3 = pollution degree

Please observe the application notes:  
Jumpers, page 164  
Marking, from page 246

A protective warning marker and an insulation stop must be applied individually. Due to the 6.2 mm width of double-deck terminal blocks with end plates, 2004 Series Push-In Type Jumper Bars must be used.

Approvals and corresponding ratings,  
visit [www.wago.com](http://www.wago.com)

## Miniature fuses 5 x 20

Series Item No.	Overload and short circuit protection		Short circuit protection only	
	Individual argmt.	Group argmt.	Individual argmt.	Group argmt.
Fuse terminal blocks				
2202-1611				
2202-1711	1.6 W	1.6 W	2.5 W	2.5 W
2202-1811				
2202-1611/.....				
2202-1711/.....	1.6 W	1.6 W	2.5 W	2.5 W
2202-1811/.....				

When selecting glass cartridge fuses, make sure that the maximum power loss listed below is not exceeded. The power loss is determined according to IEC or EN 60947-7-3/VDE 0611-6 at 23°C. The temperature rise of the terminal block must be checked according to their application and mounting. Higher ambient temperatures represent an additional impact on miniature fuses. Therefore, in such applications, the rated current must be reduced if necessary. More details are available from the manufacturers.

## Miniature fuses 5 x 20

Series Item No.	Overload and short circuit protection		Short circuit protection only	
	Individual argmt.	Group argmt.	Individual argmt.	Group argmt.
Fuse terminal blocks				
2202-1911	1.6 W	1.6 W	2.5 W	2.5 W
2202-1911/.....	1.6 W	1.6 W	2.5 W	2.5 W

When selecting glass cartridge fuses, make sure that the maximum power loss listed below is not exceeded. The power loss is determined according to IEC or EN 60947-7-3/VDE 0611-6 at 23°C. The temperature rise of the terminal block must be checked according to their application and mounting. Higher ambient temperatures represent an additional impact on miniature fuses. Therefore, in such applications, the rated current must be reduced if necessary. More details are available from the manufacturers.

# Disconnect/Test Terminal Block, Fuse Terminal Block, Carrier Terminal Block, Through Terminal Block TOPJOB® S

## 2.5 (4) mm<sup>2</sup>; 2002 Series

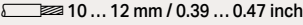
Technical Data	
0.25 ... 2.5 (4) mm <sup>2</sup> ①	22 ... 12 AWG
400 V/6 kV/3 ②	300 V, 15 A ③
I <sub>N</sub> 16 A	300 V, 10 A ④
Terminal block width: 5.2 mm / 0.205 inch	
 10 ... 12 mm / 0.39 ... 0.47 inch	

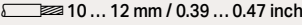
Technical Data	
0.25 ... 2.5 (4) mm <sup>2</sup> ①	22 ... 12 AWG
400 V/6 kV/3 ②	300 V, 15 A ③
I <sub>N</sub> 16 A	300 V, 10 A ④
Terminal block width: 5.2 mm / 0.205 inch	
 10 ... 12 mm / 0.39 ... 0.47 inch	

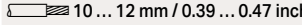
Technical Data	
0.25 ... 2.5 (4) mm <sup>2</sup> ①	22 ... 12 AWG
400 V/6 kV/3 ②	300 V, 10 A ③
I <sub>N</sub> 10 A ⑤	300 V, 10 A ④
Terminal block width: 5.2 mm / 0.205 inch	
 10 ... 12 mm / 0.39 ... 0.47 inch	

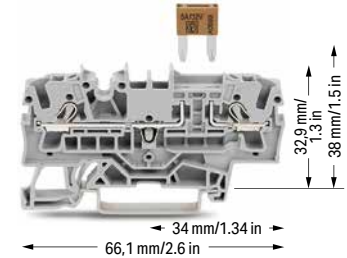
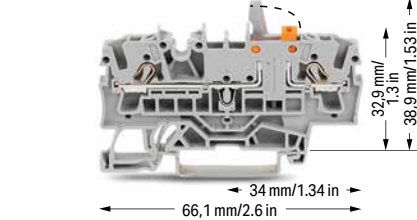
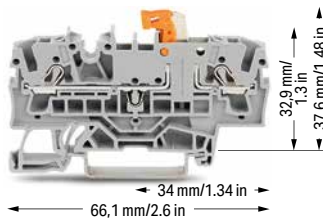

2-conductor disconnect/test terminal block; with test point; orange disconnect link

Color	Item No.	VPE
gray ⑥	2002-1671 ④	50
blue ⑥	2002-1674 ④	50
orange ⑥	2002-1672 ④	50

2-conductor disconnect/test terminal block; with mechanical interlock; with test point; orange disconnect link















Color	Item No.	VPE
gray ⑥	2002-1671/401-000 ④	50
blue ⑥	2002-1674/401-000 ④	50
orange ⑥	2002-1672/401-000 ④	50



















2-conductor fuse terminal block; for mini-automotive blade-style fuse; with test point



Color	Item No.	VPE
gray ⑥	2002-1681 ④	50

### Accessories; 2002 Series

Appropriate marking systems: WMB/WMB Inline/Marking strips

End and intermediate plate; 1 mm thick			
	orange	2002-1692	100 (25)
	gray	2002-1691	100 (25)
Insulation stop; 5 pcs/strip; 0.25 ... 0.5 mm <sup>2</sup>			
	light gray	2002-171	200 (25)
Insulation stop; 5 pcs/strip; 0.75 ... 1 mm <sup>2</sup>			
	dark gray	2002-172	200 (25)
Protective warning marker; with black high-voltage symbol; for 5 terminal blocks			
	yellow	2002-115	100 (25)
Push-in type jumper bar; insulated; I <sub>N</sub> 25 A; light gray			
	2-way	2002-402	25
	3-way	2002-403	25
	4-way	2002-404	25
	5-way	2002-405	25
	6-way	2002-406	25
	7-way	2002-407	25
	8-way	2002-408	25
	9-way	2002-409	25
	10-way	2002-410	25

Push-in type jumper bar; insulated; I <sub>N</sub> 25 A; light gray			
	1 to 3	2002-433	25
	1 to 4	2002-434	25
	1 to 5	2002-435	25
	1 to 6	2002-436	25
	1 to 7	2002-437	25
	1 to 8	2002-438	25
	1 to 9	2002-439	25
	1 to 10	2002-440	25
Delta jumper; insulated; I <sub>N</sub> = I <sub>N</sub> terminal block; light gray			
	1-2 3-4 5-6	2002-406/020-000	25
Star point jumper; insulated; I <sub>N</sub> = I <sub>N</sub> terminal block; light gray			
	1-3-5	2002-405/011-000	25
Staggered jumper; insulated; I <sub>N</sub> 25 A; light gray			
	2-way	2002-472	25
	3-way	2002-473	25
	4-way	2002-474	25
	5-way	2002-475	25
	6-way	2002-476	25
	7-way	2002-477	25
	8-way	2002-478	25
	9-way	2002-479	25
	10-way	2002-480	25
	11-way	2002-481	25
	12-way	2002-482	25

Customized staggered jumper; insulated; with contact lugs broken off at the factory and circuit printing; I <sub>N</sub> 25 A; light gray			
	1-3	2002-473/011-000	25
	1-3-5	2002-475/011-000	25
	1-3-5-7	2002-477/011-000	25
	1-3-5-7-9	2002-479/011-000	25
	1-3-5-7-9-11	2002-481/011-000	25
Adjacent jumper for continuous commoning; insulated; I <sub>N</sub> 25 A; light gray			
	2-way	2002-400	25
Adjacent jumper for continuous commoning; insulated; I <sub>N</sub> 25 A; 1 to 3			
	light gray	2002-423	25
	red	2002-423/000-005	25
	blue	2002-423/000-006	25
Adjacent jumper for continuous commoning; insulated; I <sub>N</sub> 25 A, light gray			
	5-way	2002-415	25
Push-in type wire jumper; insulated; 1.5 mm <sup>2</sup> conductor cross-section; I <sub>N</sub> 18 A			
	L = 60 mm	2009-412	100 (10)
	L = 110 mm	2009-414	100 (10)
	L = 250 mm	2009-416	100 (10)



**PUSH-IN CAGE CLAMP®**

Technical Data	
0.25 ... 2.5 (4) mm² ①	22 ... 12 AWG
400 V/6 kV/3 ②	300 V, 15 A ③
I <sub>N</sub> 16 A	300 V, 10 A ④
Terminal block width: 5.2 mm / 0.205 inch	
 10 ... 12 mm / 0.39 ... 0.47 inch	

Technical Data	
0.25 ... 2.5 (4) mm² ①	22 ... 12 AWG
400 V/6 kV/3 ②	300 V, 15 A ③
I <sub>N</sub> 16 A	300 V, 10 A ④
Terminal block width: 5.2 mm / 0.205 inch	
 10 ... 12 mm / 0.39 ... 0.47 inch	

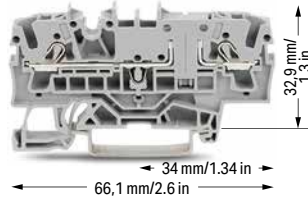
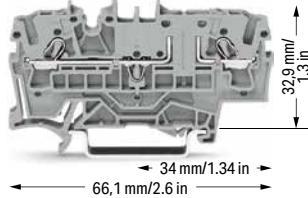

2-conductor carrier terminal block; with test point

Color	Item No.	VPE
 gray ⑤	2002-1661 ④	50

2-conductor through terminal block; with test point; same profile as 2-conductor disconnect terminal block

Color	Item No.	VPE
 gray ⑤	2002-1601 ④	50
 blue ⑤	2002-1604 ④	50
 orange ⑤	2002-1602 ④	50

Other terminal blocks with the same profile:

Fuse	2002-1611	Page 98
------	-----------	---------

**Accessories; item-specific**  
Disconnect plug for carrier terminal blocks; suitable when using a carrier terminal block as disconnect terminal block

	orange	2002-401	100 (25)
---	--------	----------	----------

Modular connector; snaps together; for jumper contact slot

	gray	2002-511	100 (25)
---	------	----------	----------

Spacer module; snaps together; bridges commoned terminal blocks

	gray	2002-549	100 (25)
---	------	----------	----------

End plate; for modular connector; 1.5 mm thick

	gray	2002-541	100 (25)
---	------	----------	----------

WMB Inline; plain; 1,500 WMB markers (5 mm)/reel; stretchable 5 ... 5.2 mm

	white	2009-115	1
---	-------	----------	---

Marking strip; plain; 11 mm wide; 50 m reel

	white	2009-110	1
---	-------	----------	---

WMB marker card; white; 10 strips with 10 markers/card; stretchable 5 ... 5.2 mm

	plain	793-5501	5
---	-------	----------	---

- Conductor range: 0.25 ... 4 mm² "s+f-st"; Push-in termination: 1 ... 4 mm² "s" and 1 ... 2.5 mm² "insulated ferrules, 12 mm" Depending on the conductor characteristic, a conductor with a smaller cross section can also be inserted via push-in termination.
  - 400 V = rated voltage  
6 kV = rated impulse voltage  
3 = pollution degree
  - Observe touch-proof protection for 42 V and higher voltages!  
• 10 A (individual arrangement)  
• 5 A (block arrangement)
  - Terminal blocks with an Ex mark are suitable for Ex ec IIc applications.  
440 V; 17 A
- Blade-style fuses are not offered by WAGO.
- Please observe the application notes:  
Jumpers, from page 160  
Testing accessories, from page 154  
Marking, from page 246
- Approvals and corresponding ratings, visit [www.wago.com](http://www.wago.com)

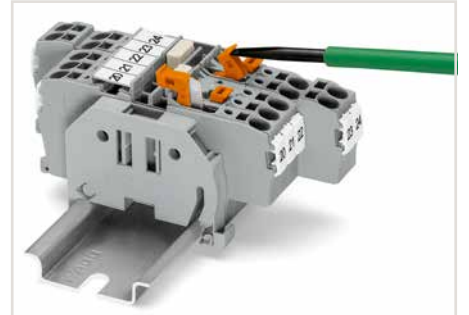

Disconnect/test terminal block with pivoting knife disconnect – opening a knife disconnect.



Disconnect/test terminal block with pivoting knife disconnect – closing the knife disconnect.



Disconnect/test terminal block with pivoting knife disconnect – testing with voltage tester.

# Disconnect/Test Terminal Block, Fuse Terminal Block, Carrier Terminal Block, Through Terminal Block, Ground Conductor Terminal Block TOPJOB® S

## 2.5 (4) mm<sup>2</sup>; 2002 Series

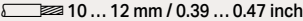
Technical Data	
0.25 ... 2.5 (4) mm <sup>2</sup> ①	22 ... 12 AWG
400 V/6 kV/3 ②	300 V, 15 A ③
I <sub>N</sub> 16 A	300 V, 10 A ④
Terminal block width: 5.2 mm / 0.205 inch	
 10 ... 12 mm / 0.39 ... 0.47 inch	

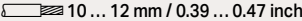
Technical Data	
0.25 ... 2.5 (4) mm <sup>2</sup> ①	22 ... 12 AWG
400 V/6 kV/3 ②	300 V, 15 A ③
I <sub>N</sub> 16 A	300 V, 10 A ④
Terminal block width: 5.2 mm / 0.205 inch	
 10 ... 12 mm / 0.39 ... 0.47 inch	

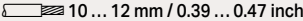
Technical Data	
0.25 ... 2.5 (4) mm <sup>2</sup> ①	22 ... 12 AWG
400 V/6 kV/3 ②	300 V, 10 A ③
I <sub>N</sub> 10 A ⑤	300 V, 10 A ④
Terminal block width: 5.2 mm / 0.205 inch	
 10 ... 12 mm / 0.39 ... 0.47 inch	

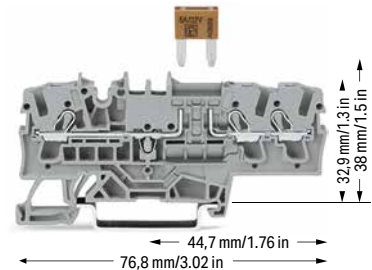
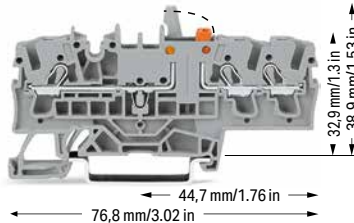
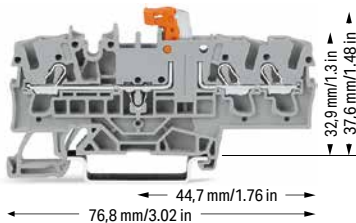

3-conductor disconnect/test terminal block; with test point; orange disconnect link

Color	Item No.	VPE
gray ⑥	2002-1771 ④	50
blue ⑥	2002-1774 ④	50
orange ⑥	2002-1772 ④	50

3-conductor disconnect/test terminal block; with mechanical interlock; with test point; orange disconnect link

Color	Item No.	VPE
gray ⑥	2002-1771/401-000 ④	50
blue ⑥	2002-1774/401-000 ④	50
orange ⑥	2002-1772/401-000 ④	50

3-conductor fuse terminal block; for mini-automotive blade-style fuse; with test point

Color	Item No.	VPE
gray ⑥	2002-1781 ④	50

### Accessories; 2002 Series

Appropriate marking systems: WMB/WMB Inline/Marking strips

End and intermediate plate; 1 mm thick

orange	2002-1792	100 (25)
gray	2002-1791	100 (25)

Insulation stop; 5 pcs/strip; 0.25 ... 0.5 mm<sup>2</sup>

light gray	2002-171	200 (25)
------------	----------	----------

Insulation stop; 5 pcs/strip; 0.75 ... 1 mm<sup>2</sup>

dark gray	2002-172	200 (25)
-----------	----------	----------

Protective warning marker; with black high-voltage symbol; for 5 terminal blocks

yellow	2002-115	100 (25)
--------	----------	----------

Push-in type jumper bar; insulated; I<sub>N</sub> 25 A; light gray

2-way	2002-402	25
3-way	2002-403	25
4-way	2002-404	25
5-way	2002-405	25
6-way	2002-406	25
7-way	2002-407	25
8-way	2002-408	25
9-way	2002-409	25
10-way	2002-410	25

Push-in type jumper bar; insulated; I<sub>N</sub> 25 A; light gray

1 to 3	2002-433	25
1 to 4	2002-434	25
1 to 5	2002-435	25
1 to 6	2002-436	25
1 to 7	2002-437	25
1 to 8	2002-438	25
1 to 9	2002-439	25
1 to 10	2002-440	25

Delta jumper; insulated; I<sub>N</sub> = I<sub>N</sub> terminal block; light gray

1-2 3-4 5-6	2002-406/020-000	25
-------------	------------------	----

Star point jumper; insulated; I<sub>N</sub> = I<sub>N</sub> terminal block; light gray

1-3-5	2002-405/011-000	25
-------	------------------	----

Adjacent jumper for continuous commoning; insulated; I<sub>N</sub> 25 A; light gray

2-way	2002-400	25
-------	----------	----

Adjacent jumper for continuous commoning; insulated; I<sub>N</sub> 25 A; 1 to 3

light gray	2002-423	25
red	2002-423/000-005	25
blue	2002-423/000-006	25

Staggered jumper; insulated; I<sub>N</sub> 25 A; light gray

2-way	2002-472	25
3-way	2002-473	25
4-way	2002-474	25
5-way	2002-475	25
6-way	2002-476	25
7-way	2002-477	25
8-way	2002-478	25
9-way	2002-479	25
10-way	2002-480	25
11-way	2002-481	25
12-way	2002-482	25

Customized staggered jumper; insulated; with contact lugs broken off at the factory and circuit printing; I<sub>N</sub> 25 A; light gray

1-3	2002-473/011-000	25
1-3-5	2002-475/011-000	25
1-3-5-7	2002-477/011-000	25
1-3-5-7-9	2002-479/011-000	25
1-3-5-7-9-11	2002-481/011-000	25

Adjacent jumper for continuous commoning; insulated; I<sub>N</sub> 25 A; light gray

5-way	2002-415	25
-------	----------	----

## Technical Data

0.25 ... 2.5 (4) mm <sup>2</sup> ①	22 ... 12 AWG
400 V/6 kV/3 ②	300 V, 15 A ③
I <sub>N</sub> 16 A	300 V, 10 A ④
Terminal block width: 5.2 mm / 0.205 inch	
 10 ... 12 mm / 0.39 ... 0.47 inch	

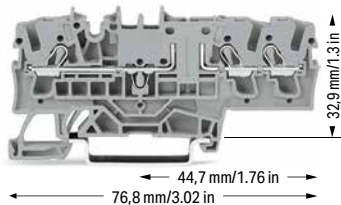

3-conductor carrier terminal block; with test point

Color	Item No.	VPE
 gray ⑤	2002-1761 ④	50

## Technical Data

0.25 ... 2.5 (4) mm <sup>2</sup> ①	22 ... 12 AWG
400 V/6 kV/3 ②	300 V, 15 A ③
I <sub>N</sub> 16 A	300 V, 10 A ④
Terminal block width: 5.2 mm / 0.205 inch	
 10 ... 12 mm / 0.39 ... 0.47 inch	

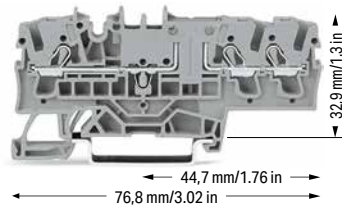

3-conductor through terminal block; with test point; same profile as 3-conductor disconnect terminal block

Color	Item No.	VPE
 gray ⑤	2002-1701 ④	50
 blue ⑤	2002-1704 ④	50
 orange ⑤	2002-1702 ④	50

## 3-conductor ground terminal block; mit Prüfmöglichkeit

 green-yellow ⑤	2002-1707 ④	50
---	-------------	----

## Other terminal blocks with the same profile:

Fuse	2002-1711	Page 98
------	-----------	---------

## Accessories; item-specific

Disconnect plug for carrier terminal blocks; suitable when using a carrier terminal block as disconnect terminal block

	orange	2002-401	100 (25)
---	--------	----------	----------

Push-in type wire jumper; insulated; 1.5 mm<sup>2</sup> conductor cross-section; I<sub>N</sub> 18 A

	L = 60 mm	2009-412	100 (10)
	L = 110 mm	2009-414	100 (10)
	L = 250 mm	2009-416	100 (10)

## Modular connector; snaps together; for jumper contact slot

	gray	2002-511	100 (25)
---	------	----------	----------

## Spacer module; snaps together; bridges commoned terminal blocks

	gray	2002-549	100 (25)
---	------	----------	----------

## End plate; for modular connector; 1.5 mm thick

	gray	2002-541	100 (25)
---	------	----------	----------

## WMB Inline; plain; 1,500 WMB markers (5 mm)/reel; stretchable 5 ... 5.2 mm

	white	2009-115	1
---	-------	----------	---

## Marking strip; plain; 11 mm wide; 50 m reel

	white	2009-110	1
---	-------	----------	---

## WMB marker card; white; 10 strips with 10 markers/card; stretchable 5 ... 5.2 mm

	plain	793-5501	5
---	-------	----------	---

① Conductor range: 0.25 ... 4 mm<sup>2</sup> "s+f-st"; Push-in termination: 1 ... 4 mm<sup>2</sup> "s" and 1 ... 2.5 mm<sup>2</sup> "insulated ferrules, 12 mm"  
Depending on the conductor characteristic, a conductor with a smaller cross section can also be inserted via push-in termination.

② 400 V = rated voltage  
6 kV = rated impulse voltage  
3 = pollution degree

③ Observe touch-proof protection for 42 V and higher voltages!  
• 10 A (individual arrangement)  
• 5 A (block arrangement)

④ Terminal blocks with an Ex mark are suitable for Ex ec IIc applications.  
440 V; 17 A

Blade-style fuses are not offered by WAGO.

Please observe the application notes:  
Jumpers, from page 160  
Testing accessories, from page 154  
Marking, from page 246

Approvals and corresponding ratings, visit [www.wago.com](http://www.wago.com)



Disconnect/test terminal block with pivoting knife disconnect and mechanical interlock – knife disconnect in open position

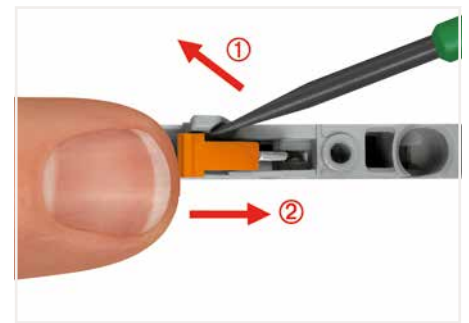

Disconnect/test terminal block with pivoting knife disconnect and mechanical interlock – closing the knife disconnect.

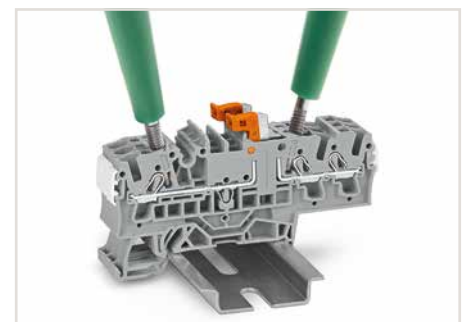

Disconnect/test terminal block with pivoting knife disconnect – testing with voltage tester.

# Disconnect/Test Terminal Block, Fuse Terminal Block, Carrier Terminal Block, Through Terminal Block TOPJOB® S

## 2.5 (4) mm<sup>2</sup>; 2002 Series

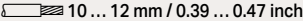
Technical Data	
0.25 ... 2.5 (4) mm <sup>2</sup> ①	22 ... 12 AWG
400 V/6 kV/3 ②	300 V, 15 A ③
I <sub>N</sub> 16 A	300 V, 10 A ④
Terminal block width: 5.2 mm / 0.205 inch	
 10 ... 12 mm / 0.39 ... 0.47 inch	

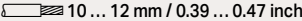
Technical Data	
0.25 ... 2.5 (4) mm <sup>2</sup> ①	22 ... 12 AWG
400 V/6 kV/3 ②	300 V, 15 A ③
I <sub>N</sub> 16 A	300 V, 10 A ④
Terminal block width: 5.2 mm / 0.205 inch	
 10 ... 12 mm / 0.39 ... 0.47 inch	

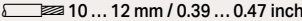
Technical Data	
0.25 ... 2.5 (4) mm <sup>2</sup> ①	22 ... 12 AWG
400 V/6 kV/3 ②	300 V, 10 A ③
I <sub>N</sub> 10 A ⑤	300 V, 10 A ④
Terminal block width: 5.2 mm / 0.205 inch	
 10 ... 12 mm / 0.39 ... 0.47 inch	

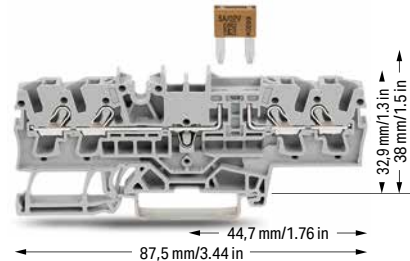
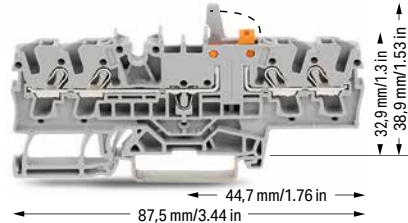
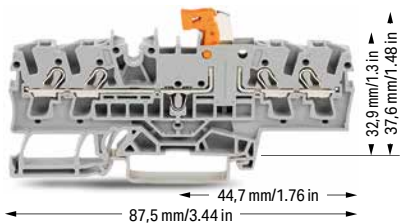

4-conductor disconnect/test terminal block; with test point; orange disconnect link

Color	Item No.	VPE
gray ⑥	2002-1871 ④	50
blue ⑥	2002-1874 ④	50
orange ⑥	2002-1872 ④	50

4-conductor disconnect/test terminal block; with mechanical interlock; with test point; orange disconnect link

Color	Item No.	VPE
gray ⑥	2002-1871/401-000 ④	50
blue ⑥	2002-1874/401-000 ④	50
orange ⑥	2002-1872/401-000 ④	50

4-conductor fuse terminal block; for mini-automotive blade-style fuse; with test point

Color	Item No.	VPE
gray ⑥	2002-1881 ④	50

### Accessories; 2002 Series

Appropriate marking systems: WMB/WMB Inline/Marking strips

End and intermediate plate; 1 mm thick		
orange	2002-1892	100 (25)
gray	2002-1891	100 (25)

Insulation stop; 5 pcs/strip; 0.25 ... 0.5 mm <sup>2</sup>		
light gray	2002-171	200 (25)

Insulation stop; 5 pcs/strip; 0.75 ... 1 mm <sup>2</sup>		
dark gray	2002-172	200 (25)

Protective warning marker; with black high-voltage symbol; for 5 terminal blocks		
yellow	2002-115	100 (25)

Push-in type jumper bar; insulated; I <sub>N</sub> 25 A; light gray		
2-way	2002-402	25
3-way	2002-403	25
4-way	2002-404	25
5-way	2002-405	25
6-way	2002-406	25
7-way	2002-407	25
8-way	2002-408	25
9-way	2002-409	25
10-way	2002-410	25

Push-in type jumper bar; insulated; I <sub>N</sub> 25 A; light gray		
1 to 3	2002-433	25
1 to 4	2002-434	25
1 to 5	2002-435	25
1 to 6	2002-436	25
1 to 7	2002-437	25
1 to 8	2002-438	25
1 to 9	2002-439	25
1 to 10	2002-440	25

Delta jumper; insulated; I <sub>N</sub> = I <sub>N</sub> terminal block; light gray		
1-2 3-4 5-6	2002-406/020-000	25

Star point jumper; insulated; I <sub>N</sub> = I <sub>N</sub> terminal block; light gray		
1-3-5	2002-405/011-000	25

Staggered jumper; insulated; I <sub>N</sub> 25 A; light gray		
2-way	2002-472	25
3-way	2002-473	25
4-way	2002-474	25
5-way	2002-475	25
6-way	2002-476	25
7-way	2002-477	25
8-way	2002-478	25
9-way	2002-479	25
10-way	2002-480	25
11-way	2002-481	25
12-way	2002-482	25

Customized staggered jumper; insulated; with contact lugs broken off at the factory and circuit printing; I <sub>N</sub> 25 A; light gray		
1-3	2002-473/011-000	25
1-3-5	2002-475/011-000	25
1-3-5-7	2002-477/011-000	25
1-3-5-7-9	2002-479/011-000	25
1-3-5-7-9-11	2002-481/011-000	25

Adjacent jumper for continuous commoning; insulated; I <sub>N</sub> 25 A; light gray		
2-way	2002-400	25

Adjacent jumper for continuous commoning; insulated; I <sub>N</sub> 25 A; 1 to 3		
light gray	2002-423	25
red	2002-423/000-005	25
blue	2002-423/000-006	25

Adjacent jumper for continuous commoning; insulated; I <sub>N</sub> 25 A, light gray		
5-way	2002-415	25

Push-in type wire jumper; insulated; 1.5 mm <sup>2</sup> conductor cross-section; I <sub>N</sub> 18 A		
L = 60 mm	2009-412	100 (10)
L = 110 mm	2009-414	100 (10)
L = 250 mm	2009-416	100 (10)

**Technical Data**

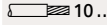
0.25 ... 2.5 (4) mm² ①	22 ... 12 AWG
400 V/6 kV/3 ②	300 V, 15 A ③
I <sub>N</sub> 16 A	300 V, 10 A ④
Terminal block width: 5.2 mm / 0.205 inch	
 10 ... 12 mm / 0.39 ... 0.47 inch	

**Technical Data**

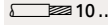
0.25 ... 2.5 (4) mm² ①	22 ... 12 AWG
400 V/6 kV/3 ②	300 V, 15 A ③
I <sub>N</sub> 16 A	300 V, 10 A ④
Terminal block width: 5.2 mm / 0.205 inch	
 10 ... 12 mm / 0.39 ... 0.47 inch	

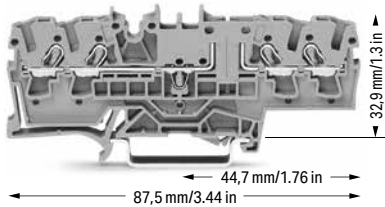

4-conductor carrier terminal block; with test point

Color	Item No.	VPE
 gray ⑤	2002-1861 ④	50

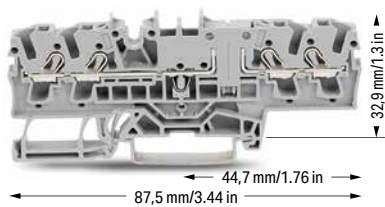

4-conductor through terminal block; with test point; same profile as 4-conductor disconnect terminal block

Color	Item No.	VPE
 gray ⑤	2002-1801 ④	50
 blue ⑤	2002-1804 ④	50
 orange ⑤	2002-1802 ④	50

Other terminal blocks with the same profile:

Fuse	2002-1811	Page 99
------	-----------	---------

**Accessories; item-specific**

Disconnect plug for carrier terminal blocks; suitable when using a carrier terminal block as disconnect terminal block

	orange	2002-401	100 (25)
---	--------	----------	----------

Modular connector; snaps together; for jumper contact slot

	gray	2002-511	100 (25)
---	------	----------	----------

Spacer module; snaps together; bridges commoned terminal blocks

	gray	2002-549	100 (25)
---	------	----------	----------

End plate; for modular connector; 1.5 mm thick

	gray	2002-541	100 (25)
---	------	----------	----------

WMB Inline; plain; 1,500 WMB markers (5 mm)/reel; stretchable 5 ... 5.2 mm

	white	2009-115	1
---	-------	----------	---

Marking strip; plain; 11 mm wide; 50 m reel

	white	2009-110	1
---	-------	----------	---

WMB marker card; white; 10 strips with 10 markers/card; stretchable 5 ... 5.2 mm

	plain	793-5501	5
---	-------	----------	---

① Conductor range: 0.25 ... 4 mm² "s+f-st"; Push-in termination: 1 ... 4 mm² "s" and 1 ... 2.5 mm² "insulated ferrules, 12 mm" Depending on the conductor characteristic, a conductor with a smaller cross section can also be inserted via push-in termination.

② 400 V = rated voltage  
6 kV = rated impulse voltage  
3 = pollution degree

③ Observe touch-proof protection for 42 V and higher voltages!  
• 10 A (individual arrangement)  
• 5 A (block arrangement)

④ Terminal blocks with an Ex mark are suitable for Ex ec IIc applications.  
440 V, 17 A

Blade-style fuses are not offered by WAGO.

Please observe the application notes:  
Jumpers, from page 160  
Testing accessories, from page 154  
Marking, from page 246

Approvals and corresponding ratings, visit [www.wago.com](http://www.wago.com)



Disconnect/test terminal block with pivoting knife disconnect and mechanical interlock – top view

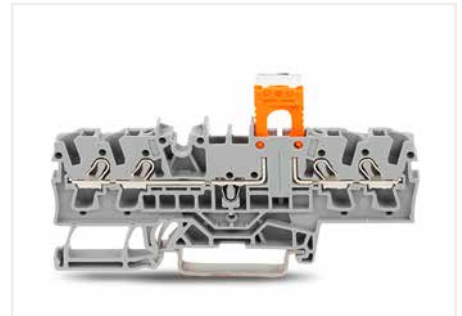

Carrier terminal block (2002-1861) with disconnect plug (2002-401) in parked position

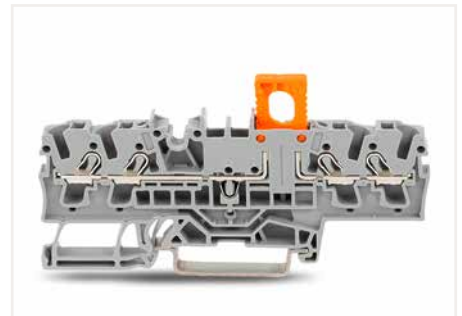

Carrier terminal block (2002-1861) with disconnect plug (2002-401) in operating position



# Disconnect/Test Terminal Block, Fuse Terminal Block, Carrier Terminal Block, Through Terminal Block, Ground Conductor Terminal Block TOPJOB® S; with Additional Jumper Slot 2.5 (4) mm<sup>2</sup>; 2002 Series

Technical Data	
0.25 ... 2.5 (4) mm <sup>2</sup> ①	22 ... 12 AWG
400 V/6 kV/3 ②	300 V, 15 A ③
I <sub>N</sub> 16 A	300 V, 10 A ④
Terminal block width: 5.2 mm / 0.205 inch	
10 ... 12 mm / 0.39 ... 0.47 inch	

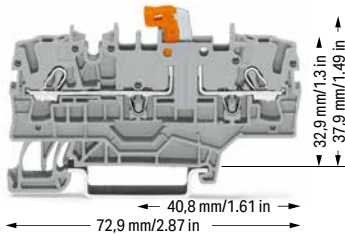

2-conductor disconnect/test terminal block; with test point; orange disconnect link; with additional jumper slot

Color	Item No.	VPE
gray ⑤	2002-1971 ④	50
blue ⑤	2002-1974 ④	50
orange ⑤	2002-1972 ④	50

Technical Data	
0.25 ... 2.5 (4) mm <sup>2</sup> ①	22 ... 12 AWG
400 V/6 kV/3 ②	300 V, 15 A ③
I <sub>N</sub> 16 A	300 V, 10 A ④
Terminal block width: 5.2 mm / 0.205 inch	
10 ... 12 mm / 0.39 ... 0.47 inch	

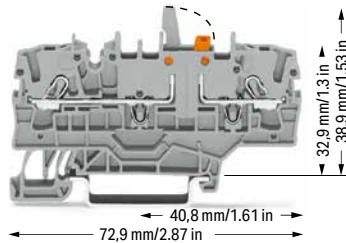

2-conductor disconnect/test terminal block; with mechanical interlock; with test point; orange disconnect link; with additional jumper slot

Color	Item No.	VPE
gray ⑤	2002-1971/401-000 ④	50
blue ⑤	2002-1974/401-000 ④	50
orange ⑤	2002-1972/401-000 ④	50

Technical Data	
0.25 ... 2.5 (4) mm <sup>2</sup> ①	22 ... 12 AWG
400 V/6 kV/3 ②	250 V, 10 A ③
I <sub>N</sub> 10 A ④	
Terminal block width: 5.2 mm / 0.205 inch	
10 ... 12 mm / 0.39 ... 0.47 inch	

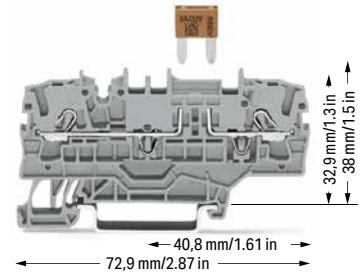

2-conductor fuse terminal block; for mini-automotive blade-style fuse; with test point; without blown fuse indication; with additional jumper slot  
Electrical ratings are given by the fuse. Blade-style fuses: Observe touch-proof protection for 42 V and higher voltages!

Color	Item No.	VPE
gray ⑤	2002-1981 ④	50

## Accessories; 2002 Series

Appropriate marking systems: WMB/WMB Inline/Marking strips

### End and intermediate plate; 1 mm thick

orange	2002-1992	100 (25)
gray	2002-1991	100 (25)

### Insulation stop; 5 pcs/strip; 0.25 ... 0.5 mm<sup>2</sup>

light gray	2002-171	200 (25)
------------	----------	----------

### Insulation stop; 5 pcs/strip; 0.75 ... 1 mm<sup>2</sup>

dark gray	2002-172	200 (25)
-----------	----------	----------

### Protective warning marker; with black high-voltage symbol; for 5 terminal blocks

yellow	2002-115	100 (25)
--------	----------	----------

### Delta jumper; insulated; I<sub>N</sub> = I<sub>N</sub> terminal block; light gray

1-2 3-4 5-6	2002-406/020-000	25
-------------	------------------	----

### Push-in type jumper bar; insulated; I<sub>N</sub> 25 A; light gray

2-way	2002-402	25
3-way	2002-403	25
4-way	2002-404	25
5-way	2002-405	25
6-way	2002-406	25
7-way	2002-407	25
8-way	2002-408	25
9-way	2002-409	25
10-way	2002-410	25

### Push-in type jumper bar; insulated; I<sub>N</sub> 25 A; light gray

1 to 3	2002-433	25
1 to 4	2002-434	25
1 to 5	2002-435	25
1 to 6	2002-436	25
1 to 7	2002-437	25
1 to 8	2002-438	25
1 to 9	2002-439	25
1 to 10	2002-440	25

### Staggered jumper; insulated; I<sub>N</sub> 25 A; light gray

2-way	2002-472	25
3-way	2002-473	25
4-way	2002-474	25
5-way	2002-475	25
6-way	2002-476	25
7-way	2002-477	25
8-way	2002-478	25
9-way	2002-479	25
10-way	2002-480	25
11-way	2002-481	25
12-way	2002-482	25

### Customized staggered jumper; insulated; with contact lugs broken off at the factory and circuit printing; I<sub>N</sub> 25 A; light gray

1-3	2002-473/011-000	25
1-3-5	2002-475/011-000	25
1-3-5-7	2002-477/011-000	25
1-3-5-7-9	2002-479/011-000	25
1-3-5-7-9-11	2002-481/011-000	25

**PUSH-IN CAGE CLAMP®**

**Technical Data**

0.25 ... 2.5 (4) mm <sup>2</sup> ①	22 ... 12 AWG
400 V/6 kV/3 ②	300 V, 15 A ③
I <sub>N</sub> 16 A	300 V, 10 A ④
Terminal block width: 5.2 mm / 0.205 inch	
 10 ... 12 mm / 0.39 ... 0.47 inch	

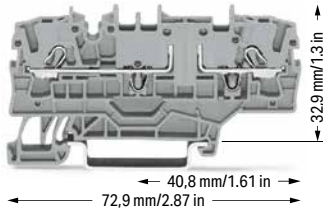

2-conductor carrier terminal block; with test point; with additional jumper slot

Color	Item No.	VPE
 gray ⑤	2002-1961 ④	50

**Technical Data**

0.25 ... 2.5 (4) mm <sup>2</sup> ①	22 ... 12 AWG
400 V/6 kV/3 ②	300 V, 15 A ③
I <sub>N</sub> 16 A	300 V, 10 A ④
Terminal block width: 5.2 mm / 0.205 inch	
 10 ... 12 mm / 0.39 ... 0.47 inch	

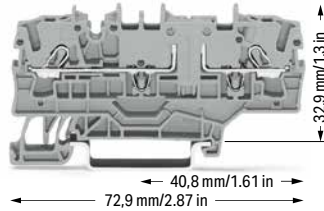

2-Leiter-Durchgangsklemme; mit Prüfmöglichkeit; mit additional jumper slot; konturengleich zu 2-Leiter-Trennklemme  
2-conductor through terminal block; with test point; same profile as 2-conductor disconnect terminal block

Color	Item No.	VPE
 gray ⑤	2002-1901 ④	50
 blue ⑤	2002-1904 ④	50
 orange ⑤	2002-1902 ④	50

2-conductor ground terminal block; mit Prüfmöglichkeit; with additional jumper slot

 green-yellow ⑤	2002-1907 ④	50
--	-------------	----

Other terminal blocks with the same profile:

Fuse	2002-1911	Page 98
------	-----------	---------

**Accessories; item-specific**

Disconnect plug for carrier terminal blocks; suitable when using a carrier terminal block as disconnect terminal block

	orange	2002-401	100 (25)
---	--------	----------	----------

Star point jumper; insulated; I<sub>N</sub> = I<sub>N</sub> terminal block; light gray

	1-3-5	2002-405/011-000	25
---	-------	------------------	----

Adjacent jumper for continuous commoning; insulated; I<sub>N</sub> 25 A; light gray

	2-way	2002-400	25
---	-------	----------	----

Adjacent jumper for continuous commoning; insulated; I<sub>N</sub> 25 A; 1 to 3

	light gray	2002-423	25
	red	2002-423/000-005	25
	blue	2002-423/000-006	25

Adjacent jumper for continuous commoning; insulated; I<sub>N</sub> 25 A, light gray

	5-way	2002-415	25
---	-------	----------	----

Push-in type wire jumper; insulated; 1.5 mm<sup>2</sup> conductor cross-section; I<sub>N</sub> 18 A

	L = 60 mm	2009-412	100 (10)
	L = 110 mm	2009-414	100 (10)
	L = 250 mm	2009-416	100 (10)

Modular connector; snaps together; for jumper contact slot

	gray	2002-511	100 (25)
---	------	----------	----------

WMB Inline; plain; 1,500 WMB markers (5 mm)/reel; stretchable 5 ... 5.2 mm

	white	2009-115	1
---	-------	----------	---

Marking strip; plain; 11 mm wide; 50 m reel

	white	2009-110	1
---	-------	----------	---

WMB marker card; white; 10 strips with 10 markers/card; stretchable 5 ... 5.2 mm

	plain	793-5501	5
---	-------	----------	---

① Conductor range: 0.25 ... 4 mm<sup>2</sup> "s+f-st"; Push-in termination: 1 ... 4 mm<sup>2</sup> "s" and 1 ... 2.5 mm<sup>2</sup> "insulated ferrules, 12 mm" Depending on the conductor characteristic, a conductor with a smaller cross section can also be inserted via push-in termination.

② 400 V = rated voltage  
6 kV = rated impulse voltage  
3 = pollution degree

③ Observe touch-proof protection for 42 V and higher voltages!  
• 10 A (individual arrangement)  
• 5 A (block arrangement)

④ Terminal blocks with an Ex mark are suitable for Ex ec llc applications.  
440 V, 17 A

Blade-style fuses are not offered by WAGO.

Please observe the application notes:  
Jumpers, from page 160  
Testing accessories, from page 154  
Marking, from page 246

Approvals and corresponding ratings, visit [www.wago.com](http://www.wago.com)

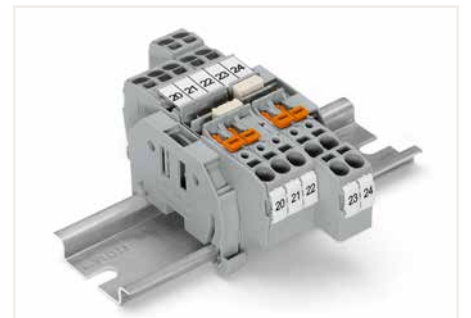

Through Terminal Blocks and Disconnect/Test Terminal Blocks

- One center and two side marker slots for WMB markers or marking strips
- Dual jumper slots in the same location as other 2002 Series terminal blocks
- Commoning options in front of or behind the knife disconnect, depending on the power supply direction

Sold & Serviced By:  
  
Toll Free Phone (877) SERV098  
[www.electromate.com](http://www.electromate.com)  
[sales@electromate.com](mailto:sales@electromate.com)

# Fuse Terminal Block TOPJOB® S; for Mini-Automotive Blade-Style Fuse; with Additional Jumper Slot

## 2.5 (4) mm<sup>2</sup>; 2002 Series

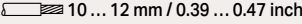
Technical Data	
0.25 ... 2.5 (4) mm <sup>2</sup> ①	22 ... 12 AWG
400 V/6 kV/3 ②	12 V, 10 A ③
I <sub>N</sub> 10 A ③	
Terminal block width: 5.2 mm / 0.205 inch	
 10 ... 12 mm / 0.39 ... 0.47 inch	

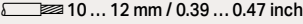
Technical Data	
0.25 ... 2.5 (4) mm <sup>2</sup> ①	22 ... 12 AWG
400 V/6 kV/3 ②	24 V, 10 A ③
I <sub>N</sub> 10 A ③	
Terminal block width: 5.2 mm / 0.205 inch	
 10 ... 12 mm / 0.39 ... 0.47 inch	

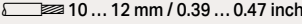
Technical Data	
0.25 ... 2.5 (4) mm <sup>2</sup> ①	22 ... 12 AWG
400 V/6 kV/3 ②	48 V, 10 A ③
I <sub>N</sub> 10 A ③	
Terminal block width: 5.2 mm / 0.205 inch	
 10 ... 12 mm / 0.39 ... 0.47 inch	

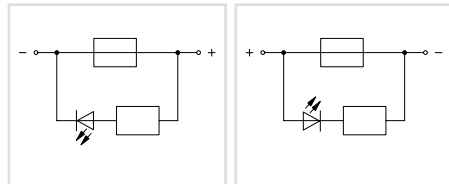
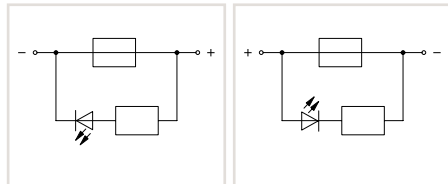
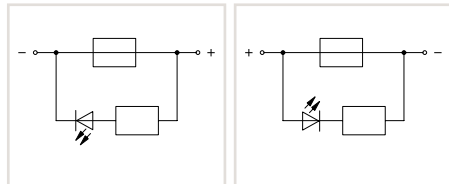
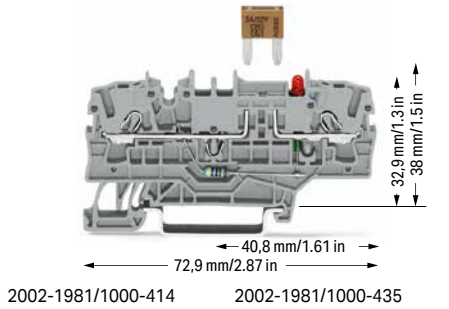
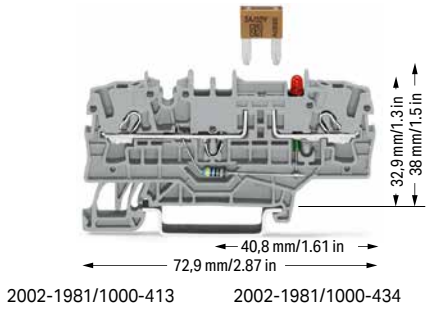
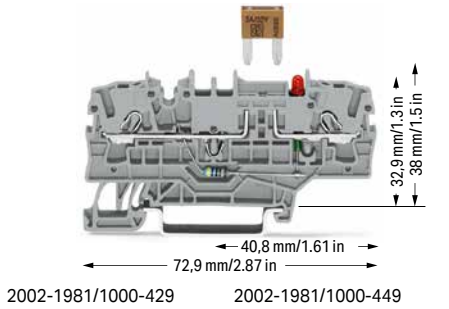

2-conductor fuse terminal block; for mini-automotive blade-style fuse; with test point; 12 V; with blown fuse indication by LED; LED power consumption: 4.8 mA Electrical ratings are given by the fuse and blown fuse indication. Blade-style fuses: Observe touch-proof protection for 42 V and higher voltages!

2-conductor fuse terminal block; for mini-automotive blade-style fuse; with test point; 24 V; with blown fuse indication by LED; LED power consumption: 4.8 mA Electrical ratings are given by the fuse and blown fuse indication. Blade-style fuses: Observe touch-proof protection for 42 V and higher voltages!

2-conductor fuse terminal block; for mini-automotive blade-style fuse; with test point; 48 V; with blown fuse indication by LED; LED power consumption: 4.8 mA Electrical ratings are given by the fuse and blown fuse indication. Blade-style fuses: Observe touch-proof protection for 42 V and higher voltages!

Color	Item No.	Pack. Unit
○ gray ⑤	2002-1981/1000-429 ④	50
○ gray ⑤	2002-1981/1000-449 ④	50

Color	Item No.	Pack. Unit
○ gray ⑤	2002-1981/1000-413 ④	50
○ gray ⑤	2002-1981/1000-434 ④	50

Color	Item No.	Pack. Unit
○ gray ⑤	2002-1981/1000-414 ④	50
○ gray ⑤	2002-1981/1000-435 ④	50

Other terminal blocks with the same profile:		
Through	2002-1901	Page 95

### Accessories; 2002 Series

Appropriate marking systems: WMB/WMB Inline/Marking strips

End and intermediate plate; 1 mm thick		
orange	2002-1992	100 (25)
gray	2002-1991	100 (25)

Insulation stop; 5 pcs/strip; 0.25 ... 0.5 mm <sup>2</sup>		
light gray	2002-171	200 (25)

Insulation stop; 5 pcs/strip; 0.75 ... 1 mm <sup>2</sup>		
dark gray	2002-172	200 (25)

Protective warning marker; with black high-voltage symbol; for 5 terminal blocks		
yellow	2002-115	100 (25)

Push-in type wire jumper; insulated; 1.5 mm <sup>2</sup> conductor cross-section; I <sub>N</sub> 18 A		
L = 60 mm	2009-412	100 (10)
L = 110 mm	2009-414	100 (10)
L = 250 mm	2009-416	100 (10)

Push-in type jumper bar; insulated; I <sub>N</sub> 25 A; light gray		
2-way	2002-402	25
3-way	2002-403	25
4-way	2002-404	25
5-way	2002-405	25
6-way	2002-406	25
7-way	2002-407	25
8-way	2002-408	25
9-way	2002-409	25
10-way	2002-410	25

Push-in type jumper bar; insulated; I <sub>N</sub> 25 A; light gray		
1 to 3	2002-433	25
1 to 4	2002-434	25
1 to 5	2002-435	25
1 to 6	2002-436	25
1 to 7	2002-437	25
1 to 8	2002-438	25
1 to 9	2002-439	25
1 to 10	2002-440	25

Staggered jumper; insulated; I <sub>N</sub> 25 A; light gray		
2-way	2002-472	25
3-way	2002-473	25
4-way	2002-474	25
5-way	2002-475	25
6-way	2002-476	25
7-way	2002-477	25
8-way	2002-478	25
9-way	2002-479	25
10-way	2002-480	25
11-way	2002-481	25
12-way	2002-482	25

Adjacent jumper for continuous commoning; insulated; I <sub>N</sub> 25 A; light gray		
2-way	2002-400	25

Adjacent jumper for continuous commoning; insulated; I <sub>N</sub> 25 A; 1 to 3		
light gray	2002-423	25
red	2002-423/000-005	25
blue	2002-423/000-006	25

Adjacent jumper for continuous commoning; insulated; I <sub>N</sub> 25 A; light gray		
5-way	2002-415	25

## Technical Data

0.25 ... 2.5 (4) mm<sup>2</sup> ① | 22 ... 12 AWG

400 V/6 kV/3 ② | 250 V, 10 A ③

I<sub>N</sub> 10 A ④

Terminal block width: 5.2 mm / 0.205 inch

10 ... 12 mm / 0.39 ... 0.47 inch

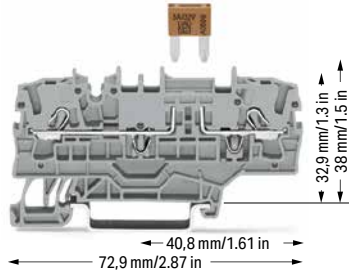

① Conductor range: 0.25 ... 4 mm<sup>2</sup> "s+f-st";  
Push-in termination: 1 ... 4 mm<sup>2</sup> "s" and 1 ... 2.5 mm<sup>2</sup> "insulated ferrules, 12 mm"  
Depending on the conductor characteristic, a conductor with a smaller cross section can also be inserted via push-in termination.

② 400 V = rated voltage  
6 kV = rated impulse voltage  
3 = pollution degree

③ Observe touch-proof protection for 42 V and higher voltages!  
• 10 A (individual arrangement)  
• 5 A (block arrangement)

④ Terminal blocks with an Ex mark are suitable for Ex ec llc applications.  
440 V; 17 A

Blade-style fuses are not offered by WAGO.

Please observe the application notes:  
Jumpers, from page 160  
Testing accessories, from page 154  
Marking, from page 246

Approvals and corresponding ratings,  
visit [www.wago.com](http://www.wago.com)

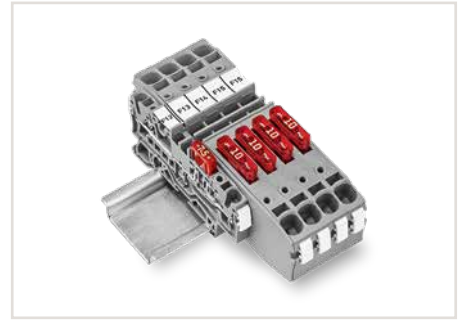

Selecting the correct fuse cartridge is important for product safety within applications, as well as for fuse cartridge service life and reliability. Fuse cartridges can operate perfectly as protection (break-off point) if they are properly selected and used according to manufacturer specifications.

Nominal current ratings for fuse cartridges are defined differently in international standards.

This is why the recommended continuous current-carrying capacity of the fuses is a max. 80% of their nominal current according to DIN 72581/Part 3 (for a surrounding air temperature of 23°C).

With regard to product safety, fuse cartridges must generally be tested both under normal and faulty operating conditions within your application.

2-conductor fuse terminal block; for mini-automotive blade-style fuse; with test point; without blown fuse indication; with additional jumper slot  
Electrical ratings are given by the fuse. Blade-style fuses: Observe touch-proof protection for 42 V and higher voltages!

Color	Item No.	Pack. Unit
○ gray ⑤	2002-1981 ④	50

WMB Inline; plain; 1,500 WMB markers (5 mm)/reel; stretchable 5 ... 5.2 mm

white	2009-115	1
-------	----------	---

Marking strip; plain; 11 mm wide; 50 m reel

white	2009-110	1
-------	----------	---

WMB marker card; white; 10 strips with 10 markers/card; stretchable 5 ... 5.2 mm

plain	793-5501	5
-------	----------	---

Double-deck marker carrier; pivoting

gray	2002-121	50 (25)
------	----------	---------

# Fused Disconnect Terminal Block with Pivoting Fuse Holder TOPJOB® S; for 5 x 20 mm Glass Cartridge Fuse

## 2.5 (4) mm<sup>2</sup>; 2002 Series

Technical Data	
0.25 ... 2.5 (4) mm <sup>2</sup> ①	22 ... 12 AWG
250 V/6 kV/3 ②	250 V, 6,3 A <sup>Ⓝ</sup>
I <sub>N</sub> 6,3 A	300 V, 10 A <sup>Ⓞ</sup>
Klemmenbreite 6,2 mm / 0.244 inch	
10 ... 12 mm / 0.39 ... 0.47 inch	

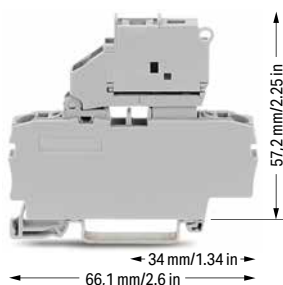

2-conductor fused disconnect terminal block with a pivoting fuse holder; for 5 x 20 mm glass cartridge fuse; without blown fuse indication  
Electrical ratings are given by the fuse.

	Item No.	VPE
○ gray ⑤	2002-1611 ⑥	50

Technical Data	
0.25 ... 2.5 (4) mm <sup>2</sup> ①	22 ... 12 AWG
250 V/6 kV/3 ②	250 V, 6,3 A <sup>Ⓝ</sup>
I <sub>N</sub> 6,3 A	300 V, 10 A <sup>Ⓞ</sup>
Klemmenbreite 6,2 mm / 0.244 inch	
10 ... 12 mm / 0.39 ... 0.47 inch	

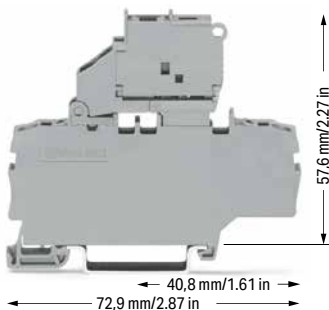

2-conductor fused disconnect terminal block with a pivoting fuse holder; with additional jumper slot; for 5 x 20 mm glass cartridge fuse; without blown fuse indication  
Electrical ratings are given by the fuse.

	Item No.	VPE
○ gray ⑤	2002-1911 ⑥	50

Technical Data	
0.25 ... 2.5 (4) mm <sup>2</sup> ①	22 ... 12 AWG
250 V/6 kV/3 ②	250 V, 6,3 A <sup>Ⓝ</sup>
I <sub>N</sub> 6,3 A	300 V, 10 A <sup>Ⓞ</sup>
Klemmenbreite 6,2 mm / 0.244 inch	
10 ... 12 mm / 0.39 ... 0.47 inch	

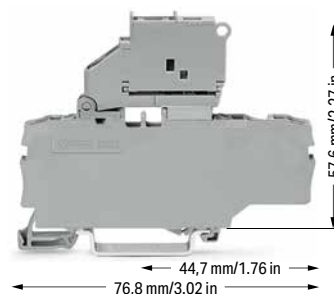

3-conductor fused disconnect terminal block with a pivoting fuse holder; for 5 x 20 mm glass cartridge fuse; without blown fuse indication  
Electrical ratings are given by the fuse.

	Item No.	VPE
○ gray ⑤	2002-1711 ⑥	50

2-conductor fused disconnect terminal block with a pivoting fuse holder; for 5 x 20 mm glass cartridge fuse; with blown fuse indication by LED; gray  
Electrical ratings are given by the fuse and blown fuse indication. Leakage current in case of a blown fuse: LED 2 mA

○ 12 ... 30 V ⑤	2002-1611/1000-541 ⑥	50
○ 30 ... 65 V ⑤	2002-1611/1000-542 ⑥	50
○ 120 V ⑤	2002-1611/1000-867 ⑥	50
○ 230 V ⑤	2002-1611/1000-836 ⑥	50

2-conductor fused disconnect terminal block with a pivoting fuse holder; with additional jumper slot; for 5 x 20 mm glass cartridge fuse; with blown fuse indication by LED; gray  
Electrical ratings are given by the fuse and blown fuse indication. Leakage current in case of a blown fuse: LED 2 mA

○ 12 ... 30 V ⑤	2002-1911/1000-541 ⑥	50
○ 30 ... 65 V ⑤	2002-1911/1000-542 ⑥	50
○ 120 V ⑤	2002-1911/1000-867 ⑥	50
○ 230 V ⑤	2002-1911/1000-836 ⑥	50

3-conductor fused disconnect terminal block with a pivoting fuse holder; for 5 x 20 mm glass cartridge fuse; with blown fuse indication by LED; gray  
Electrical ratings are given by the fuse and blown fuse indication. Leakage current in case of a blown fuse: LED 2 mA

○ 12 ... 30 V ⑤	2002-1711/1000-541 ⑥	50
○ 30 ... 65 V ⑤	2002-1711/1000-542 ⑥	50
○ 120 V ⑤	2002-1711/1000-867 ⑥	50
○ 230 V ⑤	2002-1711/1000-836 ⑥	50

Other terminal blocks with the same profile:		
Through	2002-1601	Page

Other terminal blocks with the same profile:		
Through	2002-1901	Page

Other terminal blocks with the same profile:		
Through	2002-1701	Page

### Accessories; 2002 Series

Appropriate marking systems: WMB/WMB Inline/Marking strips

#### End plate for fuse terminal blocks; 2 mm thick

	orange	2002-992	100 (25)
	gray	2002-991	100 (25)

#### Insulation stop; 5 pcs/strip; 0.25 ... 0.5 mm<sup>2</sup>

	light gray	2002-171	200 (25)
--	------------	----------	----------

#### Insulation stop; 5 pcs/strip; 0.75 ... 1 mm<sup>2</sup>

	dark gray	2002-172	200 (25)
--	-----------	----------	----------

#### Protective warning marker; with black high-voltage symbol; for 5 terminal blocks

	yellow	2002-115	100 (25)
--	--------	----------	----------

#### Push-in type wire jumper; insulated; 1.5 mm<sup>2</sup> conductor cross-section; I<sub>N</sub> 18 A

	L = 60 mm	2009-412	100 (10)
	L = 110 mm	2009-414	100 (10)
	L = 250 mm	2009-416	100 (10)

#### Push-in type jumper bar; insulated; I<sub>N</sub> 32 A; light gray

	2-way	2004-402	25
	3-way	2004-403	25
	4-way	2004-404	25
	5-way	2004-405	25
	6-way	2004-406	25
	7-way	2004-407	25
	8-way	2004-408	25
	9-way	2004-409	25
	10-way	2004-410	25

#### Push-in type jumper bar; insulated; I<sub>N</sub> 32 A; light gray

	1 to 3	2004-433	25
	1 to 4	2004-434	25
	1 to 5	2004-435	25
	1 to 6	2004-436	25
	1 to 7	2004-437	25
	1 to 8	2004-438	25
	1 to 9	2004-439	25
	1 to 10	2004-440	25



**Technical Data**

0.25 ... 2.5 (4) mm <sup>2</sup> ①	22 ... 12 AWG
250 V/6 kV/3 ②	250 V, 6.3 A <sup>Ⓝ</sup>
I <sub>N</sub> 6.3 A	300 V, 10 A <sup>Ⓝ</sup>
Klemmenbreite 6,2 mm / 0.244 inch	
10 ... 12 mm / 0.39 ... 0.47 inch	



4-conductor fused disconnect terminal block with a pivoting fuse holder; for 5 x 20 mm glass cartridge fuse; without blown fuse indication  
Electrical ratings are given by the fuse.

	Item No.	VPE
○ gray ④	2002-1811 ④	50

4-conductor fused disconnect terminal block with a pivoting fuse holder; for 5 x 20 mm glass cartridge fuse; with blown fuse indication by LED; gray  
Electrical ratings are given by the fuse and blown fuse indication. Leakage current in case of a blown fuse: LED 2 mA

○ 12 ... 30 V ⑤	2002-1811/1000-541 ⑤	50
○ 30 ... 65 V ⑤	2002-1811/1000-542 ⑤	50
○ 120 V ⑤	2002-1811/1000-867 ⑤	50
○ 230 V ⑤	2002-1811/1000-836 ⑤	50

**Other terminal blocks with the same profile:**

Through	2002-1801	Page
---------	-----------	------

① Conductor range: 0.25 ... 4 mm<sup>2</sup> "s+f-st";  
Push-in termination: 1 ... 4 mm<sup>2</sup> "s" and 1 ... 2.5 mm<sup>2</sup> "insulated ferrules, 12 mm"  
Depending on the conductor characteristic, a conductor with a smaller cross section can also be inserted via push-in termination.

② 250 V = rated voltage  
6 kV = rated impulse voltage  
3 = pollution degree

③ Terminal blocks with an Ex mark are suitable for Ex ec Ilc applications.  
250 V; 6.3 A

Please observe the application notes:  
Jumpers, page 164  
Marking, from page 246

A protective warning marker and an insulation stop must be applied individually. Due to the 6.2 mm width of fused disconnect terminal blocks with end plates, 2004 Series Push-In Type Jumper Bars must be used.

Approvals and corresponding ratings, visit [www.wago.com](http://www.wago.com)



Fuse terminal blocks with a width of 6.2 mm can be assembled adjacently. If there is no adjacent fuse terminal block at the end of the assembly, an end plate must be used.

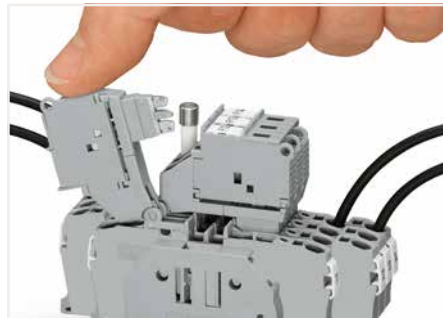

Fused disconnect terminal block with a pivoting fuse holder – pivoting the fuse holder into the locked open position.

**Glass cartridge fuse 5 x 20**

Series Item No.	Overload and short circuit protection		Short circuit protection only	
	Individual argmt.	Group argmt.	Individual argmt.	Group argmt.
Fuse terminal blocks				
2002-1611				
2002-1711	1.6 W	1.6 W	2.5 W	2.5 W
2002-1811				
2002-1611/.....				
2002-1711/.....	1.6 W	1.6 W	2.5 W	2.5 W
2002-1811/.....				

When selecting glass cartridge fuses, make sure that the maximum power loss listed below is not exceeded. The power loss is determined according to IEC or EN 60947-7-3/VDE 0611-6 at 23°C. The temperature rise of the terminal blocks must be checked according to their application and mounting. Higher ambient temperatures represent an additional impact on fuse cartridges. Therefore, in such applications, the rated current must be reduced if necessary. More details are available from the manufacturers.



Fused disconnect terminal block with a pivoting fuse holder – fuse replacement: Open the cover to replace the fuse.

**Glass cartridge fuses 5 x 20**

Series Item No.	Overload and short circuit protection		Short circuit protection only	
	Individual argmt.	Group argmt.	Individual argmt.	Group argmt.
Fuse terminal blocks				
2002-1911	1.6 W	1.6 W	2.5 W	2.5 W
2002-1911/.....	1.6 W	1.6 W	2.5 W	2.5 W

When selecting glass cartridge fuses, make sure that the maximum power loss listed below is not exceeded. The power loss is determined according to IEC or EN 60947-7-3/VDE 0611-6 at 23°C. The temperature rise of the terminal blocks must be checked according to their application and mounting. Higher ambient temperatures represent an additional impact on fuse cartridges. Therefore, in such applications, the rated current must be reduced if necessary. More details are available from the manufacturers.

# Disconnect Terminal Block, Ground Conductor Disconnect Terminal Block, Carrier Terminal Block, Through Terminal Block TOPJOB® S

## 6 (10) mm<sup>2</sup>; 2006 Series

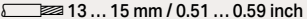
Technical Data	
0.5 ... 6 (10) mm <sup>2</sup> ①	20 ... 8 AWG
800 V/8 kV/3 ②	600 V, 30 A ③
I <sub>N</sub> 30 A	600 V, 30 A ④
Terminal block width: 7.5 mm / 0.295 inch	
 13 ... 15 mm / 0.51 ... 0.59 inch	

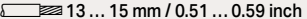
Technical Data	
0.5 ... 6 (10) mm <sup>2</sup> ①	20 ... 8 AWG
Terminal block width: 7.5 mm / 0.295 inch	
 13 ... 15 mm / 0.51 ... 0.59 inch	

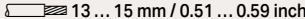
Technical Data	
0.5 ... 6 (10) mm <sup>2</sup> ①	20 ... 8 AWG
800 V/8 kV/3 ②	600 V, 30 A ③
I <sub>N</sub> 30 A	600 V, 30 A ④
Terminal block width: 7.5 mm / 0.295 inch	
 13 ... 15 mm / 0.51 ... 0.59 inch	

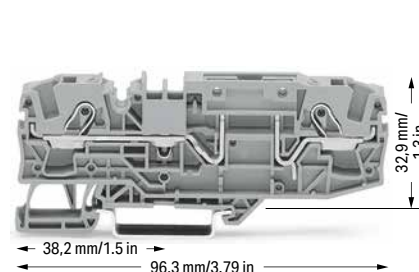
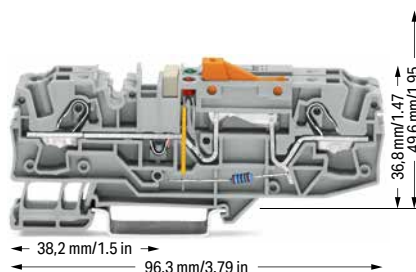
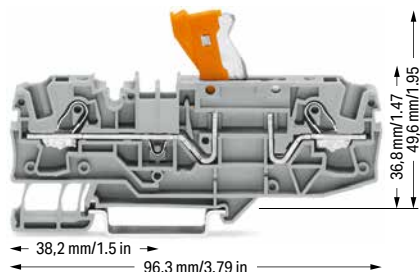

2-conductor disconnect terminal block; with test point; orange disconnect link

Color	Item No.	Pack. Unit
○ gray	2006-1671	25
● blue	2006-1674	25

Ground conductor disconnect terminal block; with test point; orange disconnect link; gray

	Item No.	Pack. Unit
○ 24 V	2006-1671/1000-848	12
○ 48 V	2006-1671/1000-849	12
○ 120 V	2006-1671/1000-850	12
○ 230 V	2006-1671/1000-851	12

2-conductor carrier terminal block; with test point

Color	Item No.	Pack. Unit
○ gray	2006-1661	25
● blue	2006-1664	25

Other terminal blocks with the same profile:

Through	2006-1601	Page 101
---------	-----------	----------





Other terminal blocks with the same profile:



Through	2006-1601	Page 101
---------	-----------	----------

Other terminal blocks with the same profile:

Through	2006-1601	Page 101
---------	-----------	----------

Accessories; item-specific

Push-in type jumper bar; insulated; I <sub>N</sub> 41 A; light gray			
	2-way	2006-402	25
	3-way	2006-403	25
	4-way	2006-404	25
	5-way	2006-405	25





Push-in type jumper bar; insulated; I <sub>N</sub> 41 A; light gray			
	1 to 3	2006-433	25
	1 to 4	2006-434	25
	1 to 5	2006-435	25



Star point jumper; insulated; I <sub>N</sub> = I <sub>N</sub> terminal block; light gray			
	1-3-5	2006-405/011-000	25

Accessories; item-specific

Push-in type jumper bar; insulated; I <sub>N</sub> 41 A; light gray			
	2-way	2006-402	25

Accessories; item-specific

Push-in type jumper bar; insulated; I <sub>N</sub> 41 A; light gray			
	2-way	2006-402	25
	3-way	2006-403	25
	4-way	2006-404	25
	5-way	2006-405	25

Push-in type jumper bar; insulated; I <sub>N</sub> 41 A; light gray			
	1 to 3	2006-433	25
	1 to 4	2006-434	25
	1 to 5	2006-435	25

Star point jumper; insulated; I <sub>N</sub> = I <sub>N</sub> terminal block; light gray			
	1-3-5	2006-405/011-000	25

Disconnect plug for carrier terminal blocks; suitable when using a carrier terminal block as disconnect terminal block



	orange	2006-401	100 (25)
---	--------	----------	----------

Blind plug for carrier terminal block; indicates a disconnection

	red	2006-451	100 (25)
---	-----	----------	----------

Accessories; 2006 Series

Appropriate marking systems: WMB/Marking strips



End and intermediate plate; 1 mm thick			
	orange	2006-1692	100 (25)
	gray	2006-1691	100 (25)

Double-deck marker carrier; pivoting			
	gray	2002-121	50 (25)

Protective warning marker; with black high-voltage symbol; for 5 terminal blocks			
	yellow	2006-115	100 (25)

**PUSH-IN CAGE CLAMP®**

**Technical Data**

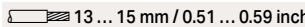
0.5 ... 6 (10) mm <sup>2</sup> ①	20 ... 8 AWG
800 V/8 kV/3 ②	600 V, 30 A 
I <sub>N</sub> 30 A	600 V, 30 A 
Terminal block width: 15 mm / 0.591 inch	
 13 ... 15 mm / 0.51 ... 0.59 inch	

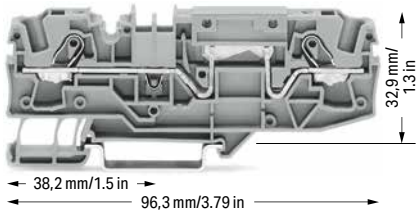

2-conductor through terminal block; with test point; same profile as 2-conductor disconnect terminal block

Color	Item No.	Pack. Unit
○ gray	2006-1601	25
● blue	2006-1604	25

**Other terminal blocks with the same profile:**

Carrier	2006-1661	Page 100
Fuse	2006-1681	Page 102
Disconnect	2006-1671	Page 100

**Accessories; item-specific**

Push-in type jumper bar; insulated; I<sub>N</sub> 41 A; light gray

	2-way	2006-402	25
	3-way	2006-403	25
	4-way	2006-404	25
	5-way	2006-405	25

Push-in type jumper bar; insulated; I<sub>N</sub> 41 A; light gray

	1 to 3	2006-433	25
	1 to 4	2006-434	25
	1 to 5	2006-435	25

Star point jumper; insulated; I<sub>N</sub> = I<sub>N</sub> terminal block; light gray

	1-3-5	2006-405/011-000	25
---	-------	------------------	----

① Conductor range: 0.5 ... 10 mm<sup>2</sup> "s+f-st"; Push-in termination: 2.5 ... 10 mm<sup>2</sup> "s" and 2.5 ... 6 mm<sup>2</sup> "insulated ferrules; 12 mm"  
Depending on the conductor characteristic, a conductor with a smaller cross section can also be inserted via push-in termination.

② 800 V = rated voltage  
8 kV = rated impulse voltage  
3 = pollution degree

Please observe the application notes:  
Jumpers, from page 163  
Marking, from page 246

Approvals and corresponding ratings, visit [www.wago.com](http://www.wago.com)

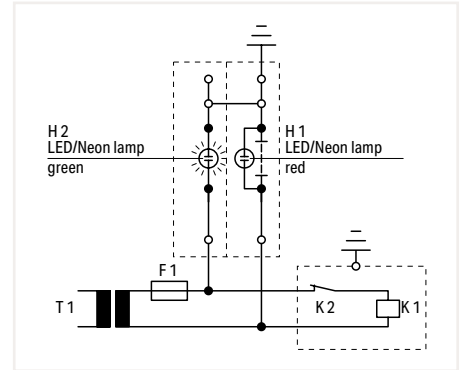

**Operating condition**  
Slide link closed, auxiliary circuit grounded, green LED/neon lamp illuminates.

IEC 60204/DIN VDE 0113 "Safety of machinery – Electrical equipment of machines – Part 1: General requirements," Section 9.4.3.1:

Ground faults on control circuits must not cause unintentional starting, hazardous movements, or prevent stopping of the machine.

In order to fulfill this requirement, a connection to the protective bonding circuit must be provided in accordance with Section 8.2 and the devices must be connected as described in Section 9.1.4. Control circuits fed from a transformer and not connected to the protective bonding circuit must be provided with an insulation monitoring device (e.g., residual current device), which either indicates a ground fault or interrupts the circuit automatically after a ground fault.

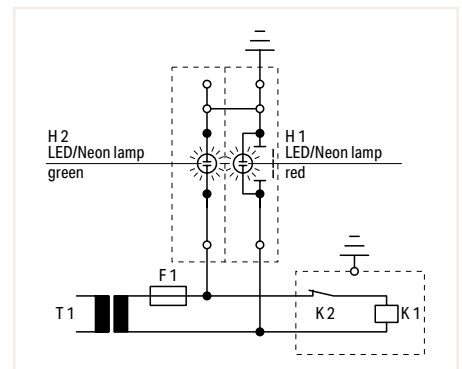

**Test condition – no grounding**  
Slide link open, auxiliary circuit not grounded.

In the case of electronic circuits, the connection of one side of the control circuit to the protective bonding circuit in accordance with Section 9.1.4 can prevent unintentional operation. When this does not help, or if due to other reasons that electronic circuits cannot be connected to the protective bonding circuit, other measures must be taken to achieve the same level of safety.

Multipole control switches that interrupt all live conductors must be used where the control circuit is directly connected between the phase conductors of the supply or between a phase conductor and a neutral conductor, which is either not grounded or grounded through a high impedance. This is required for starting or stopping machine functions, which can cause a hazardous situation including: damaging the machine or halting work in progress in the event of unintentional starting or failure to stop.

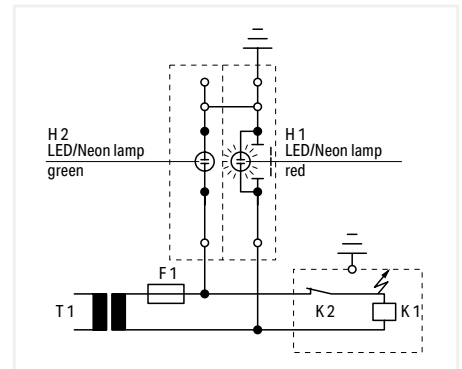

**Test condition – grounding**  
Slide link open, auxiliary circuit not grounded, red LED/neon lamp illuminates.



Ground conductor disconnect terminal block – top view

# Fuse Terminal Block for Automotive Blade-Style Fuse TOPJOB® S 6 (10) mm<sup>2</sup>; 2006 Series

Technical Data	
0.5 ... 6 (10) mm <sup>2</sup> ①	20 ... 8 AWG
500 V/6 kV/3 ②	12 V, 15 A
I <sub>N</sub> 25 A (30 A) ③	12 V, 30 A
Terminal block width: 7.5 mm / 0.295 inch	
13 ... 15 mm / 0.51 ... 0.59 inch	

Technical Data	
0.5 ... 6 (10) mm <sup>2</sup> ①	20 ... 8 AWG
500 V/6 kV/3 ②	24 V, 15 A
I <sub>N</sub> 25 A (30 A) ③	24 V, 30 A
Terminal block width: 7.5 mm / 0.295 inch	
13 ... 15 mm / 0.51 ... 0.59 inch	

Technical Data	
0.5 ... 6 (10) mm <sup>2</sup> ①	20 ... 8 AWG
500 V/6 kV/3 ②	48 V, 30 A
I <sub>N</sub> 25 A (30 A) ③	48 V, 30 A
Terminal block width: 7.5 mm / 0.295 inch	
13 ... 15 mm / 0.51 ... 0.59 inch	

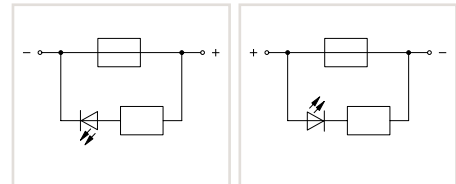
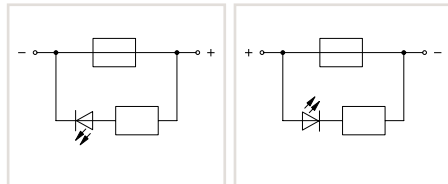
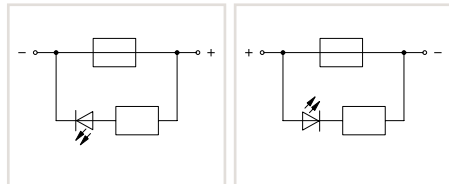
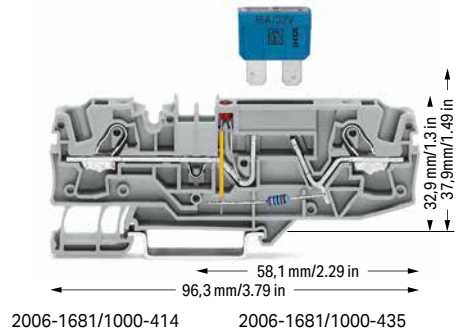
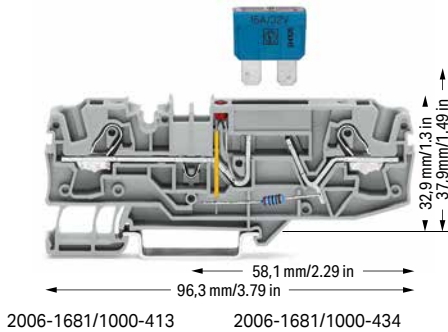
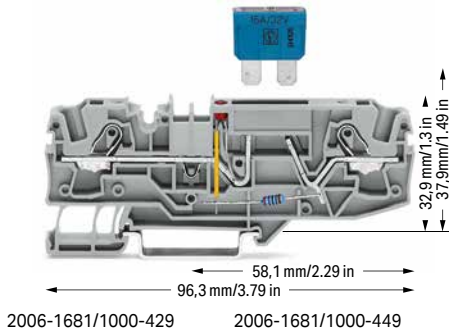

2-conductor fuse terminal block for automotive blade-style fuse; with test point; 12 V; with blown fuse indication by LED; LED power consumption: 4.8 mA  
Electrical ratings are given by the fuse and blown fuse indication. Blade-style fuses: Observe touch-proof protection for 42 V and higher voltages!

2-conductor fuse terminal block for automotive blade-style fuse; with test point; 24 V; with blown fuse indication by LED; LED power consumption: 4.8 mA  
Electrical ratings are given by the fuse and blown fuse indication. Blade-style fuses: Observe touch-proof protection for 42 V and higher voltages!

2-conductor fuse terminal block for automotive blade-style fuse; with test point; 48 V; with blown fuse indication by LED; LED power consumption: 4.8 mA  
Electrical ratings are given by the fuse and blown fuse indication. Blade-style fuses: Observe touch-proof protection for 42 V and higher voltages!

Color	Item No.	Pack. Unit
gray	2006-1681/1000-429	25
gray	2006-1681/1000-449	25

Color	Item No.	Pack. Unit
gray	2006-1681/1000-413	25
gray	2006-1681/1000-434	25

Color	Item No.	Pack. Unit
gray	2006-1681/1000-414	25
gray	2006-1681/1000-435	25

Other terminal blocks with the same profile:		
Through	2006-1601	Page 101

## Accessories; 2006 Series

End and intermediate plate; 1 mm thick			
	orange	2006-1692	100 (25)
	gray	2006-1691	100 (25)

Push-in type jumper bar; insulated; I <sub>N</sub> 41 A; light gray			
	2-way	2006-402	25
	3-way	2006-403	25
	4-way	2006-404	25
	5-way	2006-405	25

Push-in type jumper bar; insulated; I <sub>N</sub> 41 A; light gray			
	1 to 3	2006-433	25
	1 to 4	2006-434	25
	1 to 5	2006-435	25

Protective warning marker; with black high-voltage symbol; for 5 terminal blocks			
	yellow	2006-115	100 (25)

## Appropriate marking systems: WMB/Marking strips

Marking strip; plain; 11 mm wide; 50 m reel			
	white	2009-110	1

WMB marking card; white; 10 strips with 10 markers/card; 5 ... 5.2 mm stretchable			
	plain	793-5501	5

Double-deck marker carrier; pivoting			
	gray	2002-121	50 (25)

**Technical Data**

0.5 ... 6 (10) mm <sup>2</sup> ①	20 ... 8 AWG
500 V/6 kV/3 ②	600 V, 15 A ③
I <sub>N</sub> 25 A (30 A)	600 V, 30 A ④
Terminal block width: 7.5 mm / 0.295 inch	
13 ... 15 mm / 0.51 ... 0.59 inch	

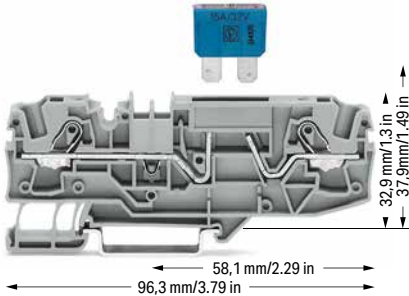

- ① Conductor range: 0.5 ... 10 mm<sup>2</sup> "s+f-st"; Push-in termination: 2.5 ... 10 mm<sup>2</sup> "s" and 2.5 ... 6 mm<sup>2</sup> "insulated ferrules; 12 mm" Depending on the conductor characteristic, a conductor with a smaller cross section can also be inserted via push-in termination.
  - ② 500 V = rated voltage  
6 kV = rated impulse voltage  
3 = pollution degree
  - ③ LED power consumption: 4.8 mA
- Blade-style fuses are not offered by WAGO. Thermal automotive circuit breakers are not offered by WAGO. WAGO recommends automotive circuit breakers from ETA.
- Please observe the application notes: Marking, from page 246
- Approvals and corresponding ratings, visit [www.wago.com](http://www.wago.com)

2-conductor fuse terminal block for automotive blade-style fuse; with test point; without blown fuse indication; Electrical ratings are given by the fuse. Blade-style fuses: Observe touch-proof protection for 42 V and higher voltages!

Color	Item No.	Pack. Unit
○ gray	2006-1681	25

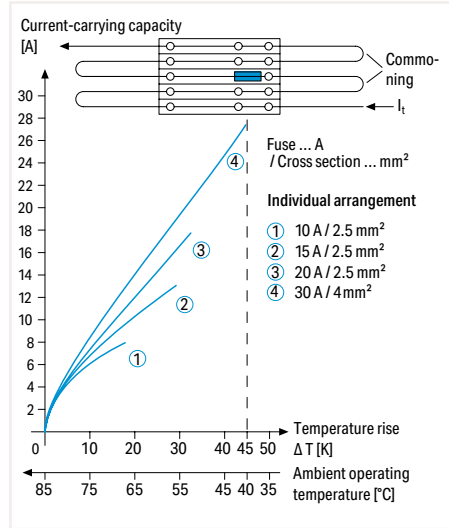

**Application Notes on Fuse Terminal Blocks**  
Diagram: Individual arrangement

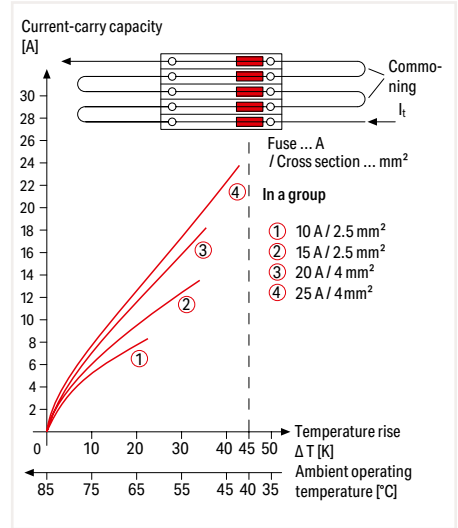

**Application Notes on Fuse Terminal Blocks**  
Diagram: Block arrangement

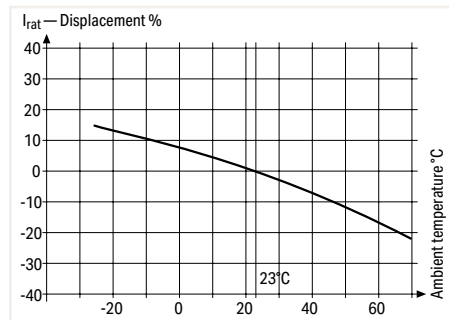

**Application Notes on Fuse Terminal Blocks**  
Nominal current ratings for fuse cartridges are defined differently in international standards. This is why the recommended continuous current-carrying capacity of the fuses is a max. 80% of their nominal current according to DIN 72581/Part 3 (for an surrounding air temperature of 23°C).  
Selecting the correct fuse cartridge is important for product safety within applications, as well as for fuse cartridge service life and reliability. Fuse cartridges will only operate perfectly as protection components (break-off point) if they are properly selected and used as intended (i.e., according to the state of the technology and valid specifications, as well as data sheet characteristics), according to basic safety requirements (i.e., persons, animals and property must be protected against hazards).

**Information from the mini-automotive, blade-type fuse manufacturers**

Derating T <sub>amb</sub> / °C	%	F <sub>T</sub>
-25	14	0.877
-20	13	0.885
-15	12	0.893
-10	11	0.901
- 5	10	0.909
0	9	0.917
5	8	0.926
10	6	0.943
15	4	0.962
20	2	0.980
23	0	1.000
30	- 2	1.020
35	- 4	1.042
40	- 6	1.064
45	- 8	1.087
50	-10	1.111
55	-13	1.149
60	-16	1.190
65	-19	1.235
70	-22	1.282

With regard to product safety, fuse cartridges must generally be tested both under normal and faulty operating conditions within your application.



## Fused Disconnect Terminal Block with Pivoting Fuse Holder TOPJOB® S; for 5 x 20 mm, 5 x 30 mm and ¼" x 1¼" Glass Cartridge Fuse 6 (10) mm<sup>2</sup>; 2006 Series

### Technical Data

0.5 ... 6 (10) mm <sup>2</sup> ①	20 ... 8 AWG
800 V/8 kV/3 ②	600 V, 15 A ③
I <sub>N</sub> 10 A	600 V, 15 A ③
Terminal block width: 7.5 mm / 0.295 inch	
13 ... 15 mm / 0.51 ... 0.59 inch	

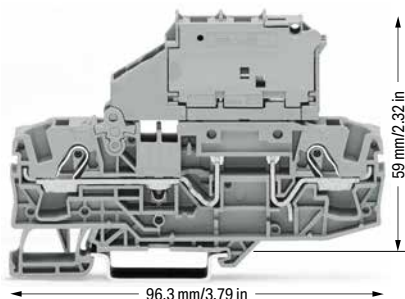

2-conductor fused disconnect terminal block with a pivoting fuse holder; without blown fuse indication  
Electrical ratings are given by the fuse.

for 5 x 20 mm glass cartridge fuse

Color	Item No.	Pack. Unit
○ gray	2006-1611	25

for 5 x 30 mm glass cartridge fuse

○ gray	2006-1621	25
--------	-----------	----

for ¼" x 1¼" glass cartridge fuse

○ gray	2006-1631	25
--------	-----------	----

Other terminal blocks with the same profile:

Through	2006-1601	Page 101
---------	-----------	----------

### Technical Data

0.5 ... 6 (10) mm <sup>2</sup> ①	20 ... 8 AWG
800 V/8 kV/3 ②	30 V, 15 A ③
I <sub>N</sub> 10 A	30 V, 15 A ③
Terminal block width: 7.5 mm / 0.295 inch	
13 ... 15 mm / 0.51 ... 0.59 inch	

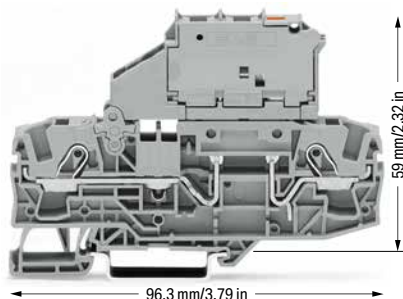

2-conductor fused disconnect terminal block with a pivoting fuse holder; gray; with blown fuse indication by LED  
Electrical ratings are given by the fuse and blown fuse indication. Leakage current in case of a blown fuse: LED 2 mA

for 5 x 20 mm glass cartridge fuse

	Item No.	Pack. Unit
○ 12 ... 30 V	2006-1611/1000-541	25
○ 30 ... 65 V	2006-1611/1000-542	25
○ 120 V	2006-1611/1000-867	25
○ 230 V	2006-1611/1000-836	25

for 5 x 30 mm glass cartridge fuse

○ 12 ... 30 V	2006-1621/1000-541	25
○ 30 ... 65 V	2006-1621/1000-542	25
○ 230 V	2006-1621/1000-836	25
○ 380 ... 500 V	2006-1621/1000-859	25

for ¼" x 1¼" glass cartridge fuse

○ 12 ... 30 V	2006-1631/1000-541	25
○ 30 ... 65 V	2006-1631/1000-542	25
○ 120 V	2006-1631/1000-867	25
○ 230 V	2006-1631/1000-836	25
○ 380 ... 500 V	2006-1631/1000-859	25

Other terminal blocks with the same profile:

Through	2006-1601	Page 101
---------	-----------	----------

### Accessories; 2006 Series

Appropriate marking systems: WMB/Marking strips

End and intermediate plate; 1 mm thick

orange	2006-1692	100 (25)
gray	2006-1691	100 (25)

End plate for fuse terminal blocks; 2 mm thick

orange	2006-992	100 (25)
gray	2006-991	100 (25)

Push-in type jumper bar; insulated; I<sub>N</sub> 41 A; light gray

2-way	2006-402	25
3-way	2006-403	25
4-way	2006-404	25
5-way	2006-405	25

Push-in type jumper bar; insulated; I<sub>N</sub> 41 A; light gray

1 to 3	2006-433	25
1 to 4	2006-434	25
1 to 5	2006-435	25

Star point jumper; insulated; I<sub>N</sub> = I<sub>N</sub> terminal block; light gray

1-3-5	2006-405/011-000	25
-------	------------------	----

Protective warning marker; with black high-voltage symbol; for 5 terminal blocks

yellow	2006-115	100 (25)
--------	----------	----------

Test plug; with 500 mm cable; 2 mm Ø; max. 42 V

red	210-136	50 (1)
-----	---------	--------

WMB marking card; white; 10 strips with 10 markers/card; 5 ... 5.2 mm stretchable

plain	793-5501	5
-------	----------	---

① Conductor range: 0.5 ... 10 mm<sup>2</sup> "s+f-st";  
Push-in termination: 2.5 ... 10 mm<sup>2</sup> "s" and  
2.5 ... 6 mm<sup>2</sup> "insulated ferrules; 12 mm"  
Depending on the conductor characteristic, a conductor  
with a smaller cross section can also be inserted  
via push-in termination.

② 800 V = rated voltage  
8 kV = rated impulse voltage  
3 = pollution degree

Please observe the application notes:  
Jumpers, from page 163  
Marking, from page 246

Approvals and corresponding ratings,  
visit [www.wago.com](http://www.wago.com)



Fused disconnect terminal block with a pivoting fuse holder - pivoting the fuse holder into the locked open position.

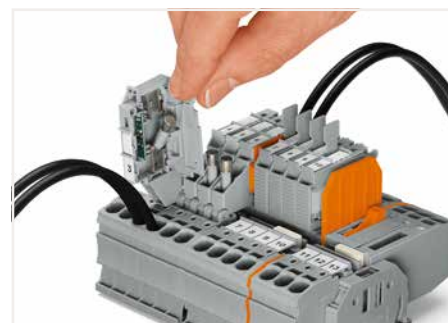

Fused disconnect terminal block with a pivoting fuse holder - fuse replacement: Open the cover to replace the fuse.

# Fused Disconnect Terminal Block with Pivoting Fuse Holder TOPJOB® S; for ¼" x 1¼" Glass Cartridge Fuse

## 6 (10) mm<sup>2</sup>; 2006 Series

### Technical Data

0.5 ... 6 (10) mm <sup>2</sup> ①	20 ... 8 AWG
800 V/8 kV/3 ②	600 V, 15 A ③
I <sub>N</sub> 10 A	600 V, 15 A ③
Terminal block width: 10.4 mm / 0.409 inch	
13 ... 15 mm / 0.51 ... 0.59 inch	

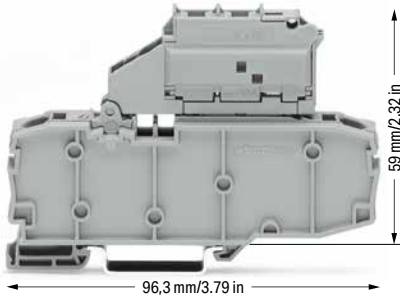

Fused disconnect terminal block with a pivoting fuse holder and end plate; without blown fuse indication  
Electrical ratings are given by the fuse.

for ¼" x 1¼" glass cartridge fuse

Color	Item No.	Pack. Unit
○ gray	2006-1631/099-000	25

### Technical Data

0.5 ... 6 (10) mm <sup>2</sup> ①	20 ... 8 AWG
800 V/8 kV/3 ②	30 V, 15 A ③
I <sub>N</sub> 10 A	30 V, 15 A ③
Terminal block width: 10.4 mm / 0.409 inch	
13 ... 15 mm / 0.51 ... 0.59 inch	



Fused disconnect terminal block with a pivoting fuse holder and end plate; gray; with blown fuse indication by LED  
Electrical ratings are given by the fuse and blown fuse indication. Leakage current in case of a blown fuse: LED 2 mA

for ¼" x 1¼" glass cartridge fuse

	Item No.	Pack. Unit
○ 12 ... 30 V	2006-1631/1099-541	25
○ 30 ... 65 V	2006-1631/1099-542	25
○ 120 V	2006-1631/1099-867	25
○ 230 V	2006-1631/1099-836	25
○ 380 ... 500 V	2006-1631/1099-859	25

① Conductor range: 0.5 ... 10 mm<sup>2</sup> "s+f-st";  
Push-in termination: 2.5 ... 10 mm<sup>2</sup> "s" and  
2.5 ... 6 mm<sup>2</sup> "insulated ferrules; 12 mm"  
Depending on the conductor characteristic, a conductor  
with a smaller cross section can also be inserted  
via push-in termination.

② 800 V = rated voltage  
8 kV = rated impulse voltage  
3 = pollution degree

Please observe the application notes:  
Jumpers, from page 163  
Marking, from page 246

Approvals and corresponding ratings,  
visit [www.wago.com](http://www.wago.com)



Pivoting fuse holder with spare fuse holder

### Other terminal blocks with the same profile:

Through	2006-1601	Page 101
---------	-----------	----------

### Other terminal blocks with the same profile:

Through	2006-1601	Page 101
---------	-----------	----------

### Accessories; 2006 Series

Appropriate marking systems: WMB/Marking strips

#### End plate for fuse terminal blocks; 2 mm thick

	orange	2006-992	100 (25)
	gray	2006-991	100 (25)

#### Push-in type jumper bar; insulated; I<sub>N</sub> 25 A; light gray

	1 to 3	2002-433	25
	1 to 5	2002-435	25
	1 to 7	2002-437	25
	1 to 9	2002-439	25

#### Star point jumper; insulated; I<sub>N</sub> = I<sub>N</sub> terminal block; light gray

	1-3-5	2002-405/011-000	25
---	-------	------------------	----

#### Protective warning marker; with black high-voltage symbol; for 5 terminal blocks

	yellow	2006-115	100 (25)
---	--------	----------	----------

#### Test plug; with 500 mm cable; 2 mm Ø; max. 42 V

	red	210-136	50 (1)
---	-----	---------	--------

#### WMB marking card; white; 10 strips with 10 markers/card; 5 ... 5.2 mm stretchable

	plain	793-5501	5
---	-------	----------	---

### Glass cartridge fuses

Series Item No.	Overload and short circuit protection		Short circuit protection only	
	Individual argmt.	Group argmt.	Individual argmt.	Group argmt.
Fused disconnect terminal blocks				
2006-1611	7.5	1.6 W	1.6 W	2.5 W
2006-1621	7.5	1.6 W	1.6 W	2.5 W
2006-1631	7.5	1.6 W	1.6 W	2.5 W
2006-1631 /099-...	10.4	2.5 W	2.5 W	2.5 W
2006-1631 /1099-...	10.4	2.5 W	2.5 W	2.5 W

When selecting glass cartridge fuses, make sure that the maximum power loss listed below is not exceeded. The power loss is determined according to IEC or EN 60947-7-3/VDE 0611-6 at 23°C. The temperature rise of the terminal blocks must be checked according to their application and mounting. Higher ambient temperatures represent an additional impact on fuse cartridges. Therefore, in such applications, the rated current must be reduced if necessary. More details are available from the manufacturers.

## Disconnect/Test Terminal Block, Carrier Terminal Block, Through Terminal Block TOPJOB® S 6 (10) mm<sup>2</sup>; 2006 Series

### Technical Data

0.5 ... 6 (10) mm<sup>2</sup> ① | 20 ... 8 AWG

1000 VAC/DC / 1500 VDC / 12 kV / 3 ②

I<sub>N</sub> 30 A 600 V, 30 A<sup>VA</sup>; 1000 V, 30 A<sup>VE</sup>

Terminal block width: 15 mm / 0.591 inch

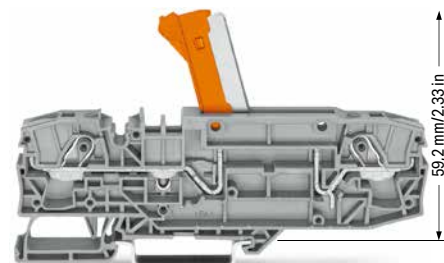
 13 ... 15 mm / 0.51 ... 0.59 inch

106,9 mm/4.21 in

2-conductor disconnect/test terminal block; with test point; orange disconnect link

Color	Item No.	Pack. Unit
○ gray	2006-8671	12
● blue	2006-8674	12

### Technical Data

0.5 ... 6 (10) mm<sup>2</sup> ① | 20 ... 8 AWG

1000 VAC/DC / 1500 VDC / 12 kV / 3 ②

I<sub>N</sub> 30 A 600 V, 30 A<sup>VA</sup>; 1000 V, 30 A<sup>VE</sup>

Terminal block width: 15 mm / 0.591 inch

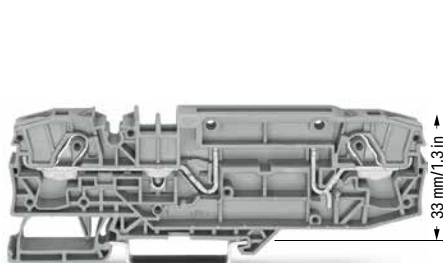
 13 ... 15 mm / 0.51 ... 0.59 inch

106,9 mm/4.21 in

2-conductor carrier terminal block; with test point

Color	Item No.	Pack. Unit
○ gray	2006-8661	12
● blue	2006-8664	12

### Accessories; item-specific

Disconnect plug for carrier terminal blocks; suitable when using a carrier terminal block as disconnect terminal block



orange 2006-8401 48 (12)

### Technical Data

0.5 ... 6 (10) mm<sup>2</sup> ① | 20 ... 8 AWG

1000 VAC/DC / 1500 VDC / 12 kV / 3 ②

I<sub>N</sub> 30 A 600 V, 30 A<sup>VA</sup>; 1000 V, 30 A<sup>VE</sup>

Terminal block width: 15 mm / 0.591 inch

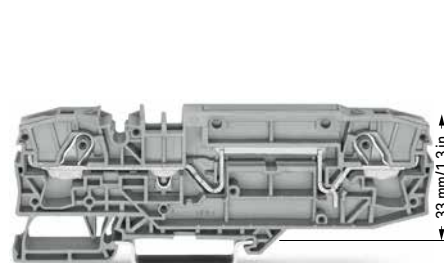
 13 ... 15 mm / 0.51 ... 0.59 inch

106,9 mm/4.21 in

2-conductor through terminal block; with test point; same profile as 2-conductor disconnect terminal block

Color	Item No.	Pack. Unit
○ gray	2006-8601	12
● blue	2006-8604	12

### Accessories; 2006 Series

#### End and intermediate plate; 1 mm thick

orange 2006-8692 48 (12)

 gray 2006-8691 48 (12)

#### Protective warning marker; with black high-voltage symbol; for 5 terminal blocks

yellow 2006-115 100 (25)



#### Push-in type jumper bar; insulated; I<sub>N</sub> 41 A; light gray

1 to 3 2006-433 25

 1 to 5 2006-435 25

#### Lockout cap; for conductor entry and operating slot

gray 2006-191 25



#### Appropriate marking systems: WMB/Marking strips

#### WMB Inline, plain; 1,500 WMB markers (5 mm)/reel; 5 ... 5.2 mm stretchable

white 2009-115 1



#### Marking strip; plain; 11 mm wide; 50 m reel

white 2009-110 1



#### WMB marking card; white; 10 strips with 10 markers/card; 5 ... 5.2 mm stretchable

plain 793-5501 5



#### WMB marking card; plain; 10 strips with 10 markers/card; 5 ... 5.2 mm stretchable

yellow 793-5501/000-002 5

red 793-5501/000-005 5

blue 793-5501/000-006 5

gray 793-5501/000-007 5

orange 793-5501/000-012 5

light green 793-5501/000-017 5

green 793-5501/000-023 5

violet 793-5501/000-024 5



❶ Conductor range: 0.5 ... 10 mm<sup>2</sup> "s+f-st";  
Push-in termination: 2.5 ... 10 mm<sup>2</sup> "s" and  
2.5 ... 6 mm<sup>2</sup> "insulated ferrules; 12 mm"  
Depending on the conductor characteristic, a conductor  
with a smaller cross section can also be inserted  
via push-in termination.

❷ 1000 VAC/DC = rated voltage  
1500 VDC  
12 kV = rated impulse voltage  
3 = pollution degree  
(see Section 14)

Please observe the application notes:  
Marking, from page 246

Protective warning markers must be applied individually.

Approvals and corresponding ratings,  
visit [www.wago.com](http://www.wago.com)

Both 2006-8671 and 2006-8661 Disconnect Terminal  
Blocks are specially designed for use in photovoltaic and  
wind power systems, where voltages exceeding 1,000 V  
(IEC) and 600 V (UL) occur (e.g., generator junction boxes).

- Ideal for high voltages in renewable energy applications
- **Disconnect terminal blocks with two alternative disconnect options:**
  - with orange knife disconnect (2006-8671)
  - with orange disconnect plug (2006-8661)
- These 2006 Series terminal blocks are approved for 1,500 VDC (IEC) or 1,000 VDC (UL) and 30 A.
- With a terminal block width of 15 mm, the maximum cross-section for solid and fine-stranded conductors is 10 mm<sup>2</sup> (AWG 8) and 6 mm<sup>2</sup> (AWG 10) for ferruled conductors.
- Equipped with two test slots
- Compatible with through terminal blocks of the same profile and all other terminal blocks TOPJOB® S

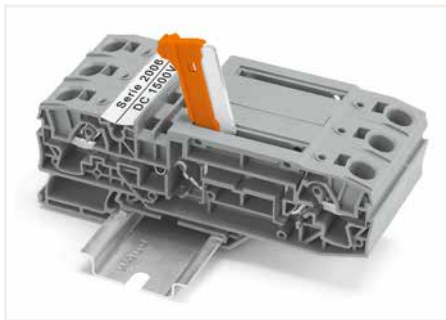

Disconnect/test terminal block with knife disconnect (2006-8671) in disconnect position

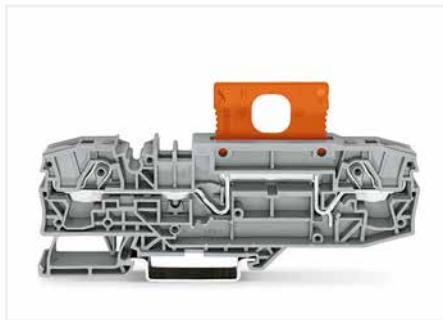

Carrier terminal block with disconnect plug (2006-8401) in operating position



Carrier terminal block with disconnect plug (2006-8401) in parked position



Commoning a 15 mm-wide terminal block via push-in type jumper bars: 1 to 3 (2006-433) and 1 to 5 (2006-435).

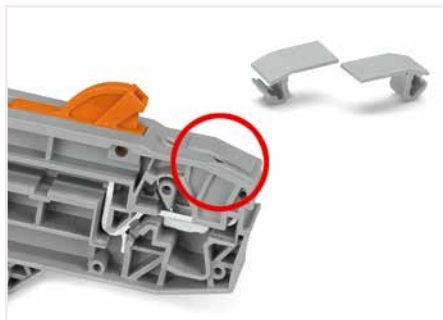

Cover (2006-191) seals unused conductor entry.

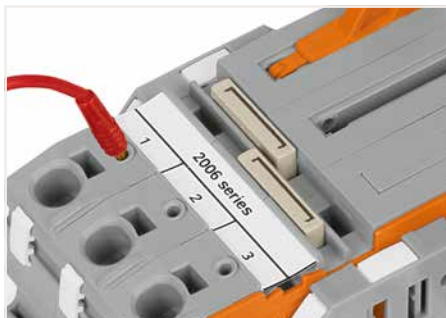

Test slots on both terminal block sides allow for direct measurement.



Test slots on both terminal block sides allow for direct measurement.



Alternatively, measurement can also be performed using Connector (2006-511) from terminal block 1 to 2. Spacer modules (2006-549) must be used to compensate for the 15 mm terminal block width.



## Current Transformer Terminal Blocks TOPJOB® S, 2007-8821 (Orange Disconnect Link)

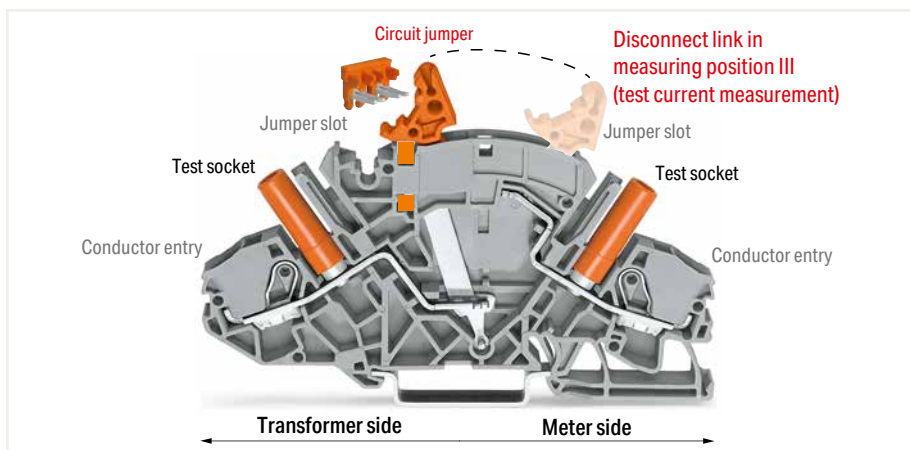
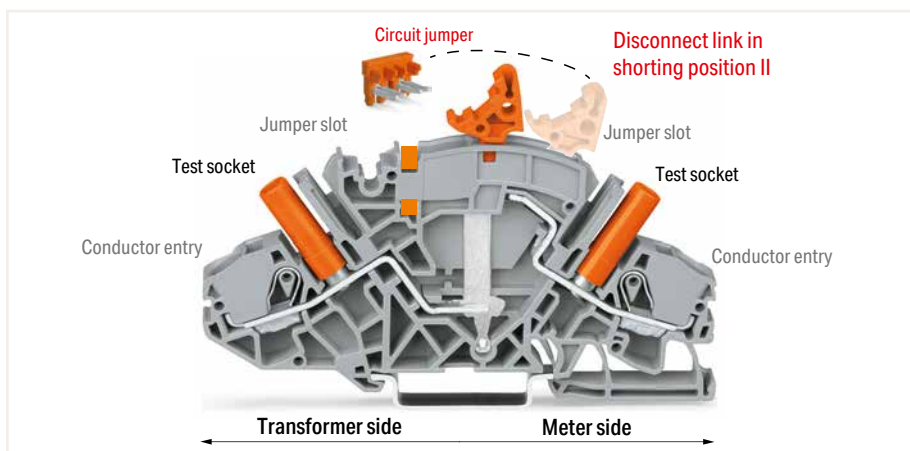
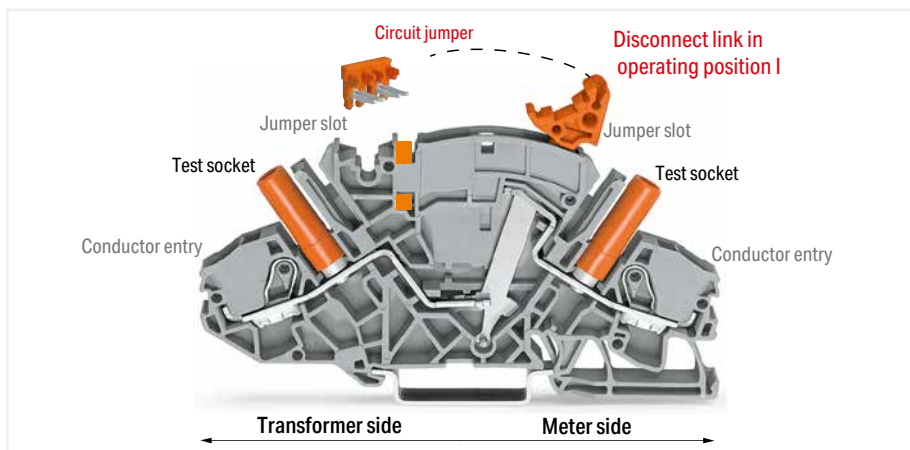

Current Transformer (Disconnect/Test) Terminal Block (2007-8821) is designed for current transformer circuits.

First, the current transformer is shorted via disconnect link and circuit jumper (insert jumper, move disconnect link from operating position I to shorting position II, activate shorting path). Connecting a measurement device via test socket on the meter side can only be performed once circuit disconnection is complete (disconnect link in measuring position III).

### Advantages:

- Top-of-unit circuit jumper slot for shorting path activation
- Disconnect link provides intuitive and easy operation, as well as exact switching status indication.
- Combines high functionality with compact design (99.6 mm long and 8 mm wide).
- All 2007 Series terminal blocks are rated at 30 A/500 V (IEC) and 300 V (UL).
- With a terminal block width of 8 mm, the maximum cross-section for solid and fine-stranded conductors is 10 mm<sup>2</sup> (8 AWG) and 6 mm<sup>2</sup> (10 AWG) for ferruled conductors.
- Touch-proof test sockets for 4 mm Ø test plugs on transformer and meter side.
- Compatible with through and ground conductor terminal blocks having the same profile.



Preparing shorting path for the current transformer circuits.



Insert insulated, touch-proof circuit jumpers into jumper slot.



Using locking covers or profiles for adjacent terminal blocks allows disconnect links to be operated simultaneously.



# Implementing a Current and Voltage Transformer Circuit TOPJOB® S



**Disconnect link in operating position I**  
Terminal blocks required:  
2 x disconnect/test terminal block (2007-8821)  
1 x circuit jumper, orange (2007-8442)  
Locking covers or interlocking links (option)

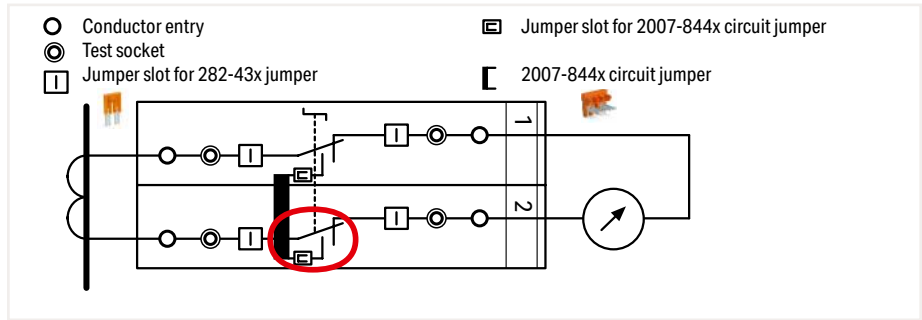

In the operating position, the measurement device is connected to the transformer, the circuit jumper is inserted and the disconnect link is in position I.



**Disconnect link in shorting position II**

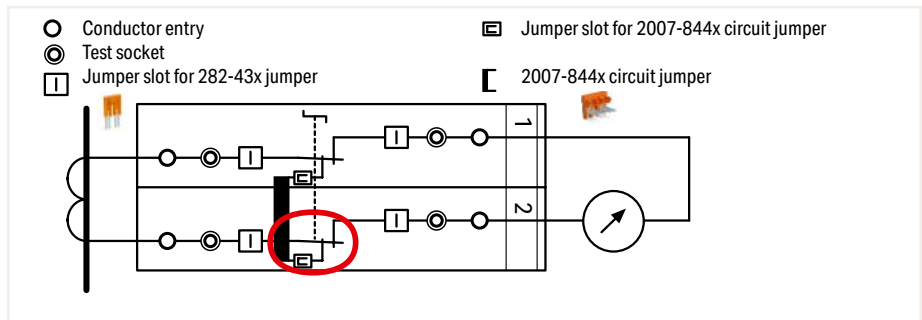

The transformer is not disconnected from the measuring device yet, the shorting path is activated by moving the disconnect link into shorting position II and the transformer is safely shorted.



**Test current measurement: Disconnect link in measuring position III**

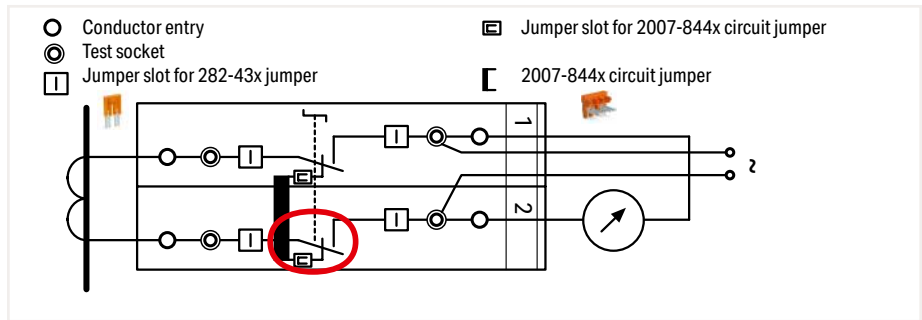

The measuring device is electrically disconnected from the transformer. If required, an external voltage can be applied to the measuring device via the test socket.



**Measurement testing (using both test sockets)**  
Terminal block 1: Disconnect link in operating position I  
Terminal block 2: Disconnect link in measuring position III

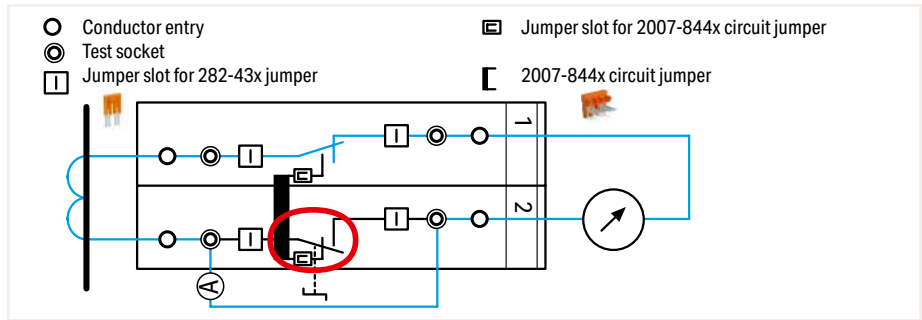

Measurement testing: First insert the reference current meter (A) into the test socket, then move the disconnect link into measurement point III (test current measurement).

## Examples for Current Transformer Circuits TOPJOB® S



Measuring set for a three-phase current transformer  
Terminal blocks required:

- 6 x disconnect/test terminal block (2007-8821)
- 3 x circuit jumper, orange (2007-8442)
- In addition: interlocking link, locking cover, lock-out

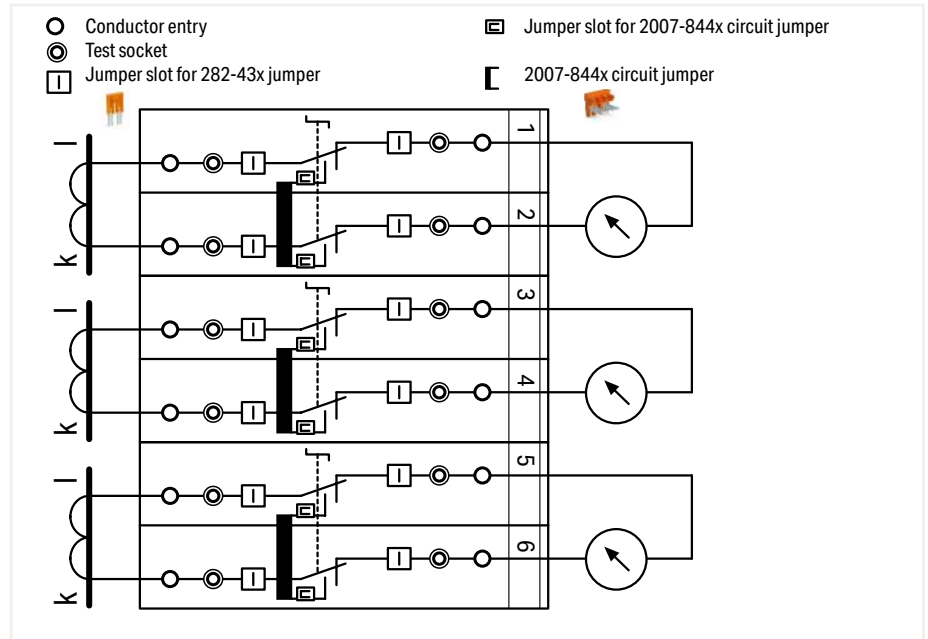

Pairs of disconnect links are interconnected via locking cover or interlocking link. Measurement testing is performed after the interlocking is released.



Measuring set for a three-phase current transformer  
with 'Y' point

Terminal blocks required:

- 6 x disconnect/test terminal block (2007-8821)
- 1 x circuit jumper, orange (2007-8446)
- 1 x jumper, orange (282-433)
- In addition: interlocking link, locking cover, lock-out

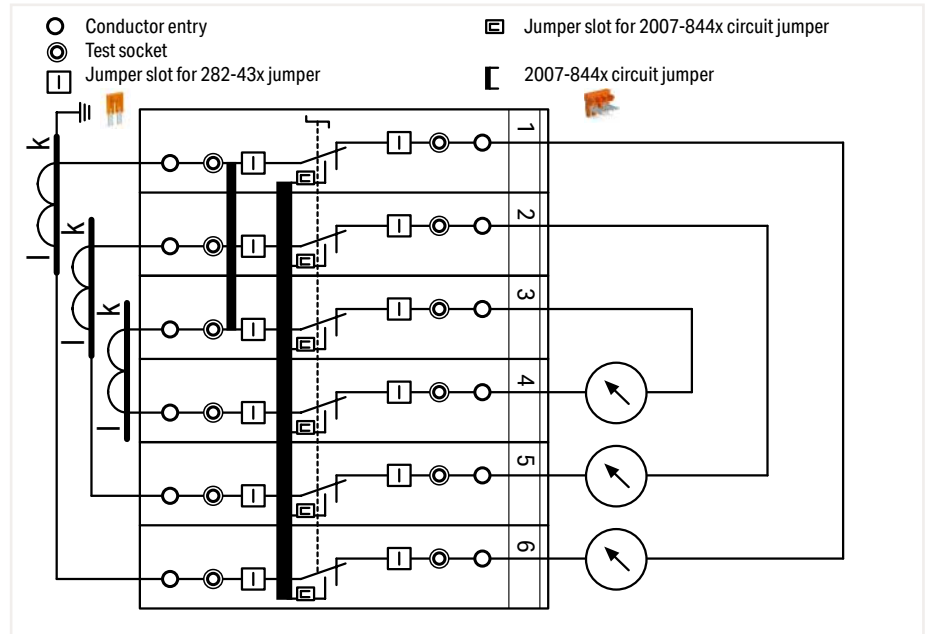

All six disconnect links are interconnected via locking cover or interlocking link.

# Voltage Transformer Terminal Blocks TOPJOB® S, 2007-8811 (Light Gray Disconnect Link)

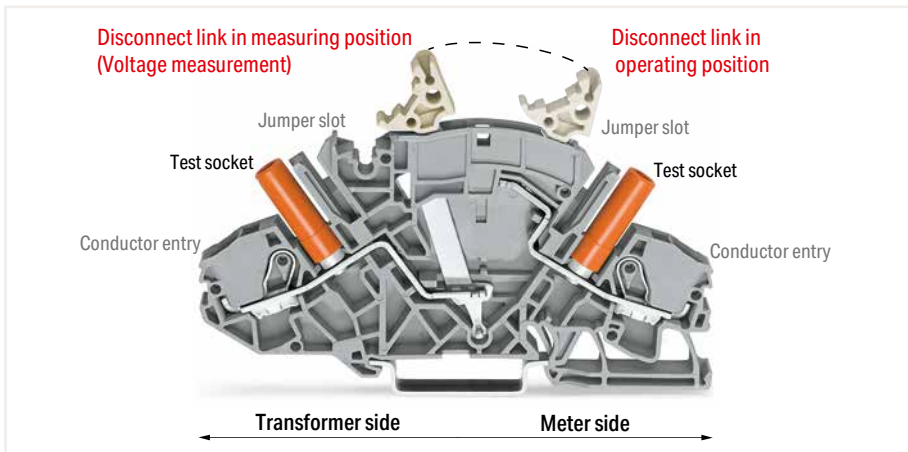

Voltage Transformer (Disconnect/Test) Terminal Block (2007-8811) is designed for current transformer circuits.

First, disconnect the voltage transformer from the circuit (move disconnect link from operating position to measurement position). Connecting a measurement device via test socket on the meter side can only be performed after disconnection is complete (measuring position).

**Advantages:**

- For voltage transformer circuits (no circuit jumper slot required as for 2007-8821 Current Transformer Terminal Block)
- Disconnect link provides intuitive and easy operation, as well as exact switching status indication.
- Combines high functionality with compact design (99.6 mm long and 8 mm wide).
- All 2007 Series terminal blocks are rated at 30 A/500 V (IEC) and 300 V (UL).
- With a terminal block width of 8 mm, the maximum cross-section for solid and fine-stranded conductors is 10 mm<sup>2</sup> (8 AWG) and 6 mm<sup>2</sup> (10 AWG) for ferruled conductors.
- Touch-proof test sockets for 4 mm Ø test plugs on transformer and meter side.
- Compatible with through and ground conductor terminal blocks having the same profile.



**Example for voltage transformer testing:**  
Measuring set for single-phase voltage transformer testing

Terminal blocks required:

- 1 x disconnect/test terminal block (2007-8811)
- 1 x through terminal block (2007-8801)
- 1 x end plate, orange (2007-8892)
- In addition: locking cover, lock-out

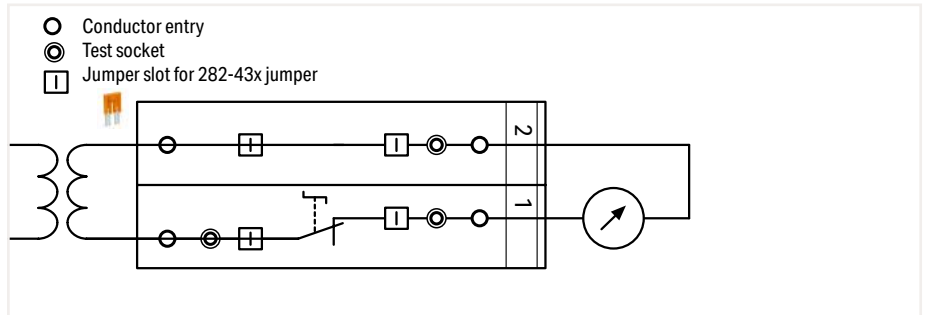

Disconnecting the voltage transformer from the circuit: Move disconnect link from operating position to measurement position.

Voltage measurement: Connecting a measurement device via test socket on the meter side can only be performed after disconnection is complete (measuring point).



Marking via WMB Multi markers or marking strips.



Additional commoning option on the transformer side



Multipole switching via snap-on type, transparent (locking) cover for disconnect links.

# Disconnect/Test Terminal Block, Through Terminal Block, Ground Conductor Terminal Block TOPJOB® S; for Current and Voltage Transformer Circuits 6 mm<sup>2</sup>; 2007 Series

Technical Data	
0.5 ... 6 (10) mm <sup>2</sup> ①	20 ... 8 AWG
500 V/6 kV/3 ②	300 V, 30 A ③
I <sub>N</sub> 30 A	
Terminal block width: 8 mm / 0.315 inch	
13 ... 15 mm / 0.51 ... 0.59 inch	

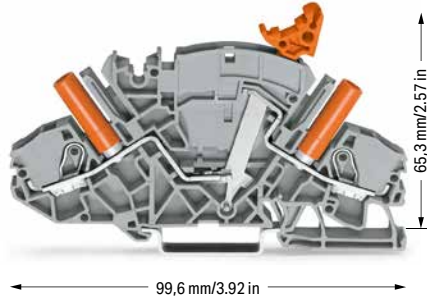

2-conductor disconnect/test terminal block; e.g., current transformer circuits; with circuit jumper slot; with touch-proof test sockets; for 4 mm Ø test plugs

Color	Item No.	Pack. Unit
○ gray	2007-8821	20

Technical Data	
0.5 ... 6 (10) mm <sup>2</sup> ①	20 ... 8 AWG
500 V/6 kV/3 ②	300 V, 30 A ③
I <sub>N</sub> 30 A	
Terminal block width: 8 mm / 0.315 inch	
13 ... 15 mm / 0.51 ... 0.59 inch	

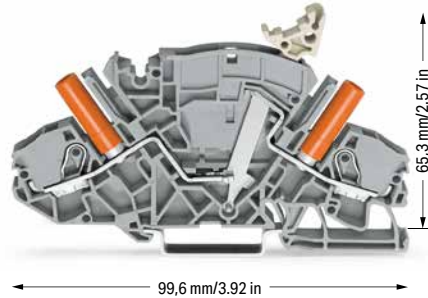

Disconnect/test terminal block; e.g., for voltage transformer circuits; with touch-proof test sockets; for 4 mm Ø test plugs

Color	Item No.	Pack. Unit
○ gray	2007-8811	20

Technical Data	
0.5 ... 6 (10) mm <sup>2</sup> ①	20 ... 8 AWG
500 V/6 kV/3 ②	300 V, 30 A ③
I <sub>N</sub> 30 A	
Terminal block width: 8 mm / 0.315 inch	
13 ... 15 mm / 0.51 ... 0.59 inch	

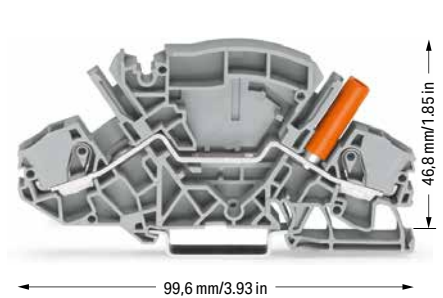

2-conductor through terminal block; with touch-proof test socket; for 4 mm Ø test plugs

Color	Item No.	Pack. Unit
○ gray	2007-8801	20
● blue	2007-8804	20

### Accessories; item-specific

Ajacent jumper for switching lever; insulated; I<sub>N</sub> 30 A; orange

	2-way	2007-8442	50 (10)
	3-way	2007-8443	50 (10)
	4-way	2007-8444	50 (10)
	5-way	2007-8445	50 (10)
	6-way	2007-8446	50 (10)
	7-way	2007-8447	50 (10)
	8-way	2007-8448	50 (10)

### Accessories; 2007 Series

End and separator plate; 1.5 mm thick; without lock-out seal option

	orange	2007-8892	50 (10)
	gray	2007-8891	50 (10)

End and separator plate; 1.5 mm thick; with lock-out seal option

	orange	2007-8894	50 (10)
	gray	2007-8893	50 (10)

Lock-out device; for disconnect link

	yellow	2007-8899	100 (20)
--	--------	-----------	----------

Locking cover; mechanically locks multiple links; transparent

	1-pole	282-881	50 (10)
	2-pole	282-882	50 (10)
	3-pole	282-883	50 (10)
	4-pole	282-884	50 (10)
	5-pole	282-885	50 (10)
	6-pole	282-886	50 (10)
	7-pole	282-887	50 (10)
	8-pole	282-888	50 (10)

### Appropriate marking systems: WMB/Marking strips

Jumper; insulated; I<sub>N</sub> 30 A; orange

	2-way	282-432	50 (10)
	3-way	282-433	50 (10)
	4-way	282-434	50 (10)
	5-way	282-435	50 (10)
	6-way	282-436	50 (10)
	7-way	282-437	50 (10)
	8-way	282-438	50 (10)
	9-way	282-439	50 (10)
	10-way	282-440	50 (10)

Jumper with safety lid; insulated; I<sub>N</sub> 30 A; orange

	2-way	282-432/100-000	50 (10)
	3-way	282-433/100-000	50 (10)
	4-way	282-434/100-000	50 (10)

Interlocking link; mechanically locks multiple links; 1 m long

	transparent	210-254	1
---	-------------	---------	---

Jumper; insulated; I<sub>N</sub> 30 A; orange

	1-3	282-433/011-000	50 (10)
	1-3-5	282-435/011-000	50 (10)
	1-4-5	282-435/301-000	50 (10)
	1-3-4-5	282-435/300-000	50 (10)
	1-2-4-6	282-436/301-000	50 (10)
	1-4-6	282-436/304-000	50 (10)
	1-3-5-7	282-437/011-000	50 (10)
	1-4-7	282-437/012-000	50 (10)
	1-2-5-8	282-438/300-000	50 (10)
	1-4-7-8	282-438/301-000	50 (10)
	1-3-5-7-9	282-439/011-000	50 (10)

Protective warning marker; with black high-voltage symbol; for 5 terminal blocks

	yellow	2006-115	100 (25)
---	--------	----------	----------

WMB marking card; white; 10 strips with 10 markers/card; stretchable 5 ... 5.2 mm

	plain	793-5501	5
---	-------	----------	---

Marking strip; plain; 11 mm wide; 50 m reel

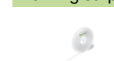
	white	2009-110	1
---	-------	----------	---



**PUSH-IN CAGE CLAMP®**

**Technical Data**

0.5 ... 6 (10) mm<sup>2</sup> ① | 20 ... 8 AWG

Terminal block width: 8 mm / 0.315 inch

13 ... 15 mm / 0.51 ... 0.59 inch



46,8 mm/1.85 in

99,6 mm/3.93 in

2-conductor ground terminal block; with touch-proof test socket; for 4 mm Ø test plugs

Color	Item No.	Pack. Unit
● green-yellow	2007-8807	20

① Conductor range: 0.5 ... 10 mm<sup>2</sup> "s+f-st"; Push-in termination: 2.5 ... 10 mm<sup>2</sup> "s" and 2.5 ... 6 mm<sup>2</sup> "insulated ferrules; 12 mm" Depending on the conductor characteristic, a conductor with a smaller cross section can also be inserted via push-in termination.

② 500 V = rated voltage  
6 kV = rated impulse voltage  
3 = pollution degree (see Section 14)

Please observe the application notes: Marking, from page 246

Approvals and corresponding ratings, visit [www.wago.com](http://www.wago.com)



Marking via WMB Multi markers or marking strips.

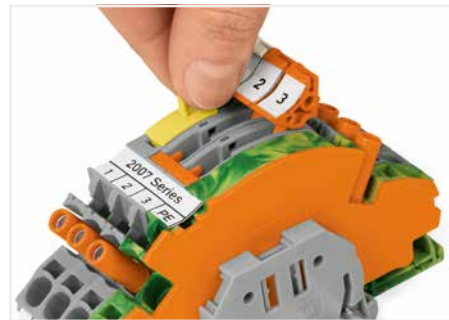

Lock-out prevents accidental operation of disconnect link.



Lock-out snaps into one of two notched positions.

WMB marking card; 10 strips with 10 markers/card; stretchable 5 ... 5.2 mm; yellow

	k/I (50x)	794-5553/000-002	5
--	-----------	------------------	---

WMB marking card; 10 strips with 10 markers/card; stretchable 5 ... 5.2 mm; blue

	U/V (50x)	794-5554/000-006	5
--	-----------	------------------	---



Interlocking link mechanically locks multiple links for multi-pole switching applications.



A lock-out seal can be used on the disconnect link in operating position I in combination with an end and separator plate (2007-8893 or 2007-8894).



## Terminal Block Assembly TOPJOB® S; for Current and Voltage Transformers

### 6 (10) mm<sup>2</sup>; 2007 Series

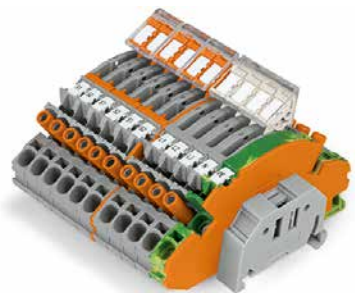

Item No. for 2007-8873	Quantity
<b>Designation</b>	
249-117	2
Screwless end stop; 10 mm wide	
282-882	3
Locking cover; mechanically locks multiple links, 2-pole	
282-884	1
Locking cover; mechanically locks multiple links, 4-pole	
2007-8442	3
Circuit jumper; insulated; 2-way	
2007-8807	1
2-conductor ground terminal block; with touch-proof test socket; for 4 mm Ø test plugs	
2007-8811	4
2-conductor disconnect/test terminal block; with touch-proof test sockets; for 4 mm Ø test plugs	
2007-8821	6
2-conductor disconnect/test terminal block; with touch-proof test sockets; for 4 mm Ø test plugs	
2007-8892	2
End and separator plate; 1.5 mm thick; without lock-out seal option	
2009-115	21
WMB Inline, plain; 1,500 WMB markers (5 mm)/reel; 5 ... 5.2 mm stretchable	markers
282-435/011-000	1
Jumper; insulated; 1-3-5	
Assembly width incl. end stop: 11.2 cm	

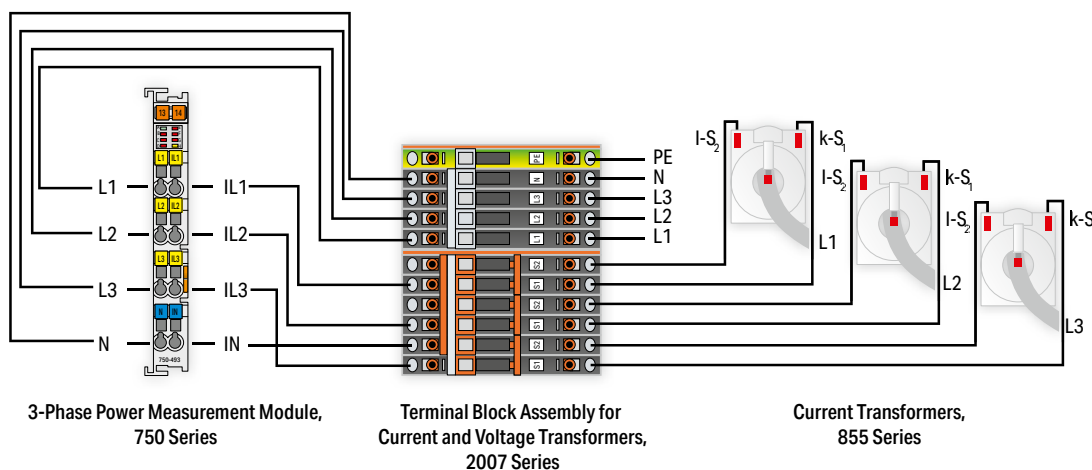



Item No. for 2007-8876	Quantity
Designation	
249-117	2
Screwless end stop; 10 mm wide	
282-369	1
Collective jumper carrier; for DIN-35 rail; compatible with jumpers for transverse switching terminal block (282-811) and longitudinal switching disconnect terminal block (282-821)	
282-882	3
Locking cover; mechanically locks multiple links, 2-pole	
2007-8442	3
Circuit jumper; insulated; 2-way	
2007-8821	6
2-conductor disconnect/test terminal block; with touch-proof test sockets; for 4 mm Ø test plugs	
2007-8892	1
End and separator plate; 1.5 mm thick; without lock-out seal option	
2009-115	12
WMB Inline, plain; 1,500 WMB markers (5 mm)/reel; 5 ... 5.2 mm stretchable	markers
282-435/011-000	1
Jumper; insulated; 1-3-5	
Assembly width incl. end stop: 8.5 cm	

## Fuse Plug TOPJOB® S on Carrier Terminal Block 2.5 (4) mm<sup>2</sup> 2004 Series

### Technical Data

250 V / I<sub>N</sub> 6.3 A

Plug width: 6.1 mm / 0.24 inch

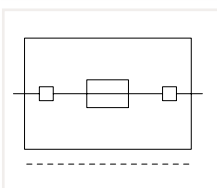

Fuse plug with pull-tab; for 5 x 20 mm glass cartridge fuses  
Electrical ratings are given by the fuse.

Color	Item No.	Pack. Unit
○ gray	2004-911	50

### Technical Data

250 V / I<sub>N</sub> 6.3 A

Plug width: 6.1 mm / 0.24 inch

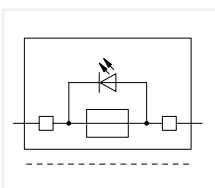

Fuse plug with pull-tab; for 5 x 20 mm glass cartridge fuses; with LED, gray  
Electrical ratings are given by the fuse and blown fuse indication. Leakage current in case of a blown fuse: LED 2 mA

	Item No.	Pack. Unit
○ 12 ... 30 V	2004-911/1000-541	50
○ 30 ... 65 V	2004-911/1000-542	50
○ 120 V	2004-911/1000-867	50
○ 230 V	2004-911/1000-836	50

Approvals and corresponding ratings, visit [www.wago.com](http://www.wago.com)

### Accessories; for fuse plugs

Appropriate marking systems:  
WMB/Marking strips

### End plate for fuse terminal blocks; 2 mm thick

	orange	2002-992	100 (25)
	gray	2002-991	100 (25)

Shorting link; 5 x 20 mm; allows the fuse plug to be used as a disconnect plug

	I <sub>N</sub> 6.3 A	281-503	250 (25)
---	----------------------	---------	----------

WMB marking card; white; 10 strips with 10 markers/card; 5 ... 5.2 mm stretchable

	plain	793-5501	5
---	-------	----------	---

WMB marking card; plain; 10 strips with 10 markers/card; 5 ... 5.2 mm stretchable

	yellow	793-5501/000-002	5
	red	793-5501/000-005	5
	blue	793-5501/000-006	5
	gray	793-5501/000-007	5
	orange	793-5501/000-012	5
	light green	793-5501/000-017	5
	green	793-5501/000-023	5
	violet	793-5501/000-024	5

### Accessories; for fuse plugs

Appropriate marking systems: WMB/Marking strips

2-conductor carrier terminal block;  
0.25 ... 2.5 (4) mm<sup>2</sup> / 22 ... 12 AWG  
Terminal block width: 5.2 mm / 0.205 inch

gray	2002-1661	50
------	-----------	----



2-conductor carrier terminal block;  
0.25 ... 2.5 (4) mm<sup>2</sup> / 22 ... 12 AWG  
Terminal block width: 5.2 mm / 0.205 inch

gray	2002-1961	50
------	-----------	----



End and intermediate plate; 1 mm thick

orange	2002-1692	100 (25)
gray	2002-1691	100 (25)



End and intermediate plate; 1 mm thick

orange	2002-1992	100 (25)
gray	2002-1991	100 (25)



3-conductor carrier terminal block;  
0.25 ... 2.5 (4) mm<sup>2</sup> / 22 ... 12 AWG  
Terminal block width: 5.2 mm / 0.205 inch

gray	2002-1761	50
------	-----------	----



Double-deck carrier terminal block;  
0.25 ... 2.5 (4) mm<sup>2</sup> / 22 ... 12 AWG  
Terminal block width: 5.2 mm / 0.205 inch

L/L	2002-2961	50
-----	-----------	----



End and intermediate plate; 1 mm thick

orange	2002-1792	100 (25)
gray	2002-1791	100 (25)



Double-deck carrier terminal block;  
0.25 ... 2.5 (4) mm<sup>2</sup> / 22 ... 12 AWG  
Terminal block width: 5.2 mm / 0.205 inch

L/N	2002-2963	50
-----	-----------	----



4-conductor carrier terminal block;  
0.25 ... 2.5 (4) mm<sup>2</sup> / 22 ... 12 AWG  
Terminal block width: 5.2 mm / 0.205 inch

gray	2002-1861	50
------	-----------	----



End and intermediate plate; 1 mm thick

orange	2002-2992	100 (25)
gray	2002-2991	100 (25)



End and intermediate plate; 1 mm thick

orange	2002-1892	100 (25)
gray	2002-1891	100 (25)



Sold & Serviced By:

 **ELECTROMATE**

Toll Free Phone (877) SERV098  
[www.electromate.com](http://www.electromate.com)  
[sales@electromate.com](mailto:sales@electromate.com)

## Fuse Plugs TOPJOB® S on Carrier Terminal Blocks 2.5 (4) mm<sup>2</sup>

### Technical Information

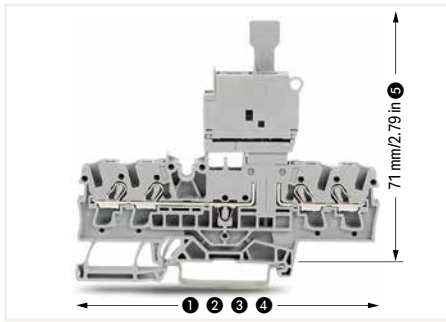

#### Fuse plug dimensions:

- ① 66.1 mm / 2.62 inch for 2002-1661
- ② 76.8 mm / 3.02 inch for 2002-1761
- ③ 87.5 mm / 3.45 inch for 2002-1861
- ④ 72.9 mm / 2.87 inch for 2002-1961
- ⑤ with inserted fuse plug

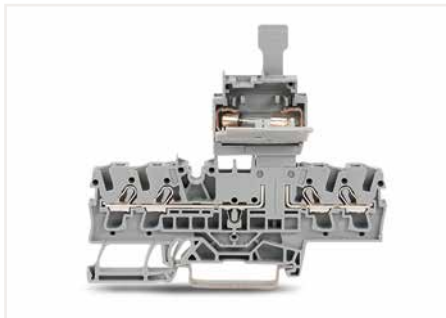

Using fuse plugs with rail-mount terminal blocks for control circuit protection is highly advantageous because the function and wiring levels are separated:

- No additional cost for assembly and wiring
- No risk of accidental contact with live parts when disconnecting the fuse plug
- The fuse plug is completely separated from the carrier terminal block when replacing a fuse – away from current carrying parts
- The fuse plug can be removed by service personnel
- No unintentional reclosing of the circuit by another person
- Quickly exchange a fuse by using a prepared "stand-by plug"

#### Fuse plug features for quick and safe applications:

- Optional LED indicates blown fuse
- Top-of-unit marking slot provides clear carrier terminal block identification
- Two test slots with touch contacts
- Terminal blocks/plugs provide high-density wiring in a width of just 5.2/6.1 mm
- May be used as a disconnect plug in combination with a shorting link

#### Glass cartridge fuses 5 x 20

Series Item No.	Overload and short circuit protection		Short circuit protection only	
	Individual argmt.	Group argmt.	Individual argmt.	Group argmt.
Fuse terminal blocks				
2004-911				
2004-911/.....	1.6 W	1.6 W	2.5 W	2.5 W

When selecting glass cartridge fuses, make sure that the maximum power loss listed below is not exceeded. The power loss is determined according to IEC or EN 60947-7-3/VDE 0611-6 at 23°C. The temperature rise of the terminal blocks must be checked according to their application and mounting. Higher ambient temperatures represent an additional impact on fuse cartridges. Therefore, in such applications, the rated current must be reduced if necessary. More details are available from the manufacturers.

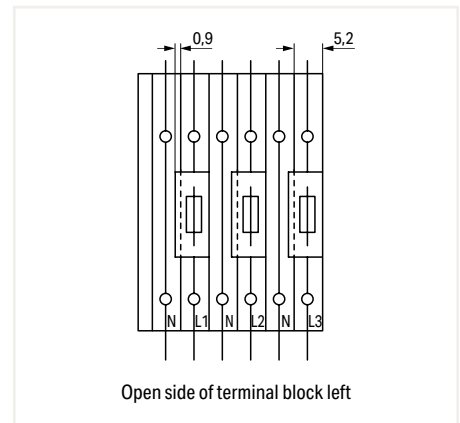

#### Please note:

The extra width of the plug (6.1 mm compared to 5.2 mm for carrier terminal blocks) must be compensated for with intermediate plates (1 mm) when building an assembly of carrier terminal blocks equipped with fuse plugs.

# Fuse Plug TOPJOB® S on Carrier Terminal Block 6 (10) mm<sup>2</sup> 2006 Series

**Technical Data**

800 V / I<sub>N</sub> 10 A  
Plug width: 7.4 mm / 0.291 inch

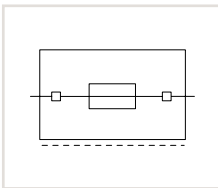

Fuse plug with pull-tab  
Electrical ratings are given by the fuse.

for 5 x 20 mm glass cartridge fuse

Color	Item No.	Pack. Unit
○ gray	2006-911	25

**Technical Data**

800 V / I<sub>N</sub> 10 A  
Plug width: 7.4 mm / 0.291 inch

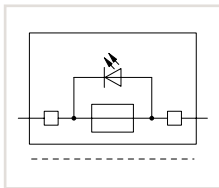

Fuse plug with pull-tab; with LED; gray  
Electrical ratings are given by the fuse and blown fuse indication. Leakage current in case of a blown fuse: LED 2 mA

for 5 x 20 mm glass cartridge fuse

	Item No.	Pack. Unit
○ 12 ... 30 V	2006-911/1000-541	25
○ 30 ... 65 V	2006-911/1000-542	25
○ 230 V	2006-911/1000-836	25

**Technical Data**

800 V / I<sub>N</sub> 10 A  
Plug width: 10.4 mm / 0.409 inch

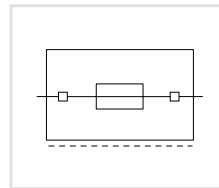

Fuse plug with pull-tab  
Electrical ratings are given by the fuse.

for 1/4" x 1/4" glass cartridge fuse

Color	Item No.	Pack. Unit
○ gray	2006-931/099-000	25

for 5 x 30 mm glass cartridge fuse

○ gray	2006-921	25
--------	----------	----

for 5 x 30 mm glass cartridge fuse

○ 12 ... 30 V	2006-921/1000-541	25
○ 30 ... 65 V	2006-921/1000-542	25
○ 230 V	2006-921/1000-836	25
○ 380 ... 500 V	2006-921/1000-859	25

for 1/4" x 1/4" glass cartridge fuse

○ gray	2006-931	25
--------	----------	----

for 1/4" x 1/4" glass cartridge fuse

○ 12 ... 30 V	2006-931/1000-541	25
○ 120 V	2006-931/1000-867	25
○ 230 V	2006-931/1000-836	25
○ 380 ... 500 V	2006-931/1000-859	25

**Accessories; item-specific**

End and intermediate plate; 1 mm thick

orange	2006-1692	100 (25)
gray	2006-1691	100 (25)



**Accessories; item-specific**

End and intermediate plate; 1 mm thick

orange	2006-1692	100 (25)
gray	2006-1691	100 (25)



**Accessories; item-specific**

Intermediate plate; 2.9 mm thick

orange	2006-1696	100 (25)
gray	2006-1695	100 (25)



**Accessories; for fuse plugs**

Appropriate marking systems: WMB/Marking strips

End plate for fuse terminal blocks; 2 mm thick

orange	2006-992	100 (25)
gray	2006-991	100 (25)



Shorting link; 5 x 20 mm; allows the fuse plug to be used as a disconnect plug

I <sub>N</sub> 6.3 A	281-503	250 (25)
----------------------	---------	----------



Screwless end stop; for DIN-35 rail; 6 mm wide

gray	249-116	100 (25)
------	---------	----------



2-conductor carrier terminal block;  
0.5 ... 6 (10) mm<sup>2</sup> / 20 ... 8 AWG  
Terminal block width: 7.5 mm / 0.295 inch

gray	2006-1661	25
blue	2006-1664	25



WMB marking card; white; 10 strips with 10 markers/card; 5 ... 5.2 mm stretchable

plain	793-5501	5
-------	----------	---



Screwless end stop; for DIN-35 rail; 10 mm wide

gray	249-117	50 (25)
------	---------	---------





**Technical Data**

800 V / I<sub>n</sub> 10 A

Plug width: 10.4 mm / 0.409 inch

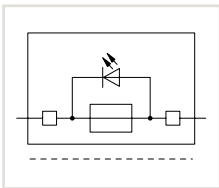

Fuse plug with pull-tab; with LED; gray  
Electrical ratings are given by the fuse and blown fuse indication. Leakage current in case of a blown fuse: LED 2 mA  
for ¼" x 1¼" glass cartridge fuse

	Item No.	Pack. Unit
○ 12 ... 30 V	2006-931/1099-541	25
○ 30 ... 65 V	2006-931/1099-542	25
○ 230 V	2006-931/1099-836	25
○ 380 ... 500 V	2006-931/1099-859	25

Approvals and corresponding ratings, visit [www.wago.com](http://www.wago.com)

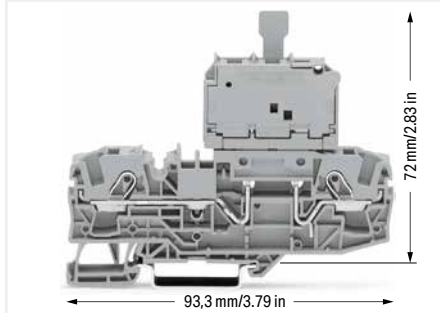

Using fuse plugs with rail-mount terminal blocks for control circuit protection is highly advantageous because the function and wiring levels are separated:

- No additional cost for assembly and wiring
- No risk of accidental contact with live parts when disconnecting the fuse plug
- The fuse plug is completely separated from the carrier terminal block when replacing a fuse – away from current carrying parts
- The fuse plug can be removed by service personnel
- No unintentional reclosing of the circuit by another person
- Quickly exchange a fuse by using a prepared "stand-by plug"

Fuse plug features for quick and safe applications:

- Optional LED indicates blown fuse
- Top-of-unit marking slot provides clear carrier terminal block identification
- Two test slots with touch contacts
- Terminal blocks/plugs provide high-density wiring in a width of just 7.5/7.4 (10.4) mm
- May be used as a disconnect plug in combination with a shorting link

**Glass cartridge fuses**

Series Item No.	Overload and short circuit protection		Short circuit protection only	
	Individual argmt.	Group argmt.	Individual argmt.	Group argmt.
Fused disconnect terminal blocks				
2006-911	7.5	1.6 W	1.6 W	2.5 W
2006-921	7.5	1.6 W	1.6 W	2.5 W
2006-931	7.5	1.6 W	1.6 W	2.5 W
2006-931 /099...	10.4	2.5 W	2.5 W	2.5 W
2006-931 /1099...	10.4	2.5 W	2.5 W	2.5 W

When selecting glass cartridge fuses, make sure that the maximum power loss listed below is not exceeded. The power loss is determined according to IEC or EN 60947-7-3/VDE 0611-6 at 23°C. The temperature rise of the terminal blocks must be checked according to their application and mounting. Higher ambient temperatures represent an additional impact on fuse cartridges. Therefore, in such applications, the rated current must be reduced if necessary. More details are available from the manufacturers.

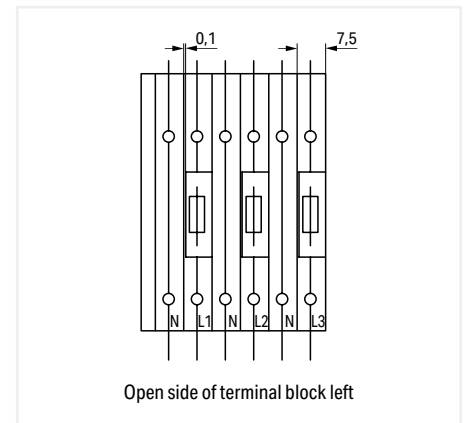

Open side of terminal block left

When using 10.4 mm wide plugs, please note: The extra width of the plug (10.4 mm compared to 7.5 mm for carrier terminal blocks) must be compensated for with intermediate plates (2.9 mm) when building an assembly of carrier terminal blocks equipped with fuse plugs.

**Accessories; item-specific**

Intermediate plate; 2.9 mm thick

	orange	2006-1696	100 (25)
	gray	2006-1695	100 (25)

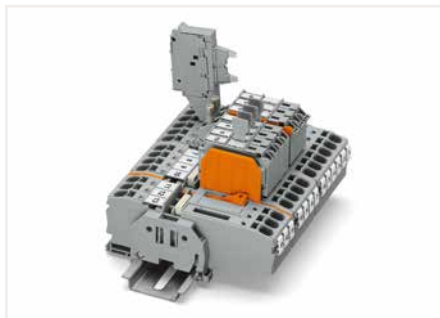

Pivoting fuse holder with spare fuse holder

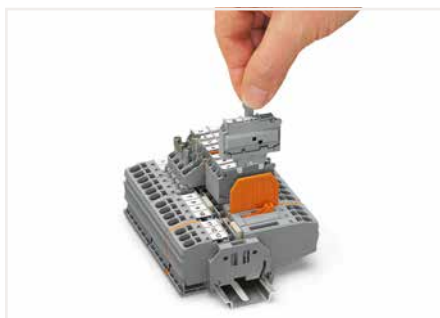

The end plate ensures that the fuse can only be removed when the fuse plug is pulled out.

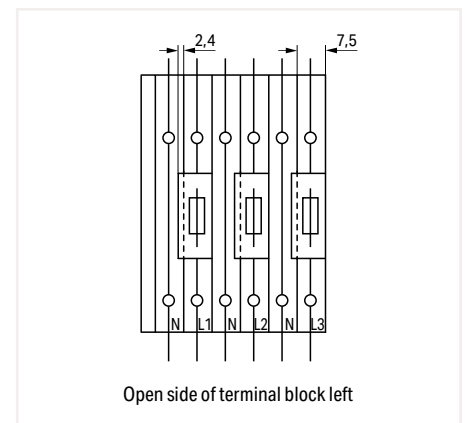

Open side of terminal block left

When using 10.4 mm wide plugs, please note: The extra width of the plug (10.4 mm compared to 7.5 mm for carrier terminal blocks) must be compensated for with intermediate plates (2.9 mm) when building an assembly of carrier terminal blocks equipped with fuse plugs.

# Sensor Terminal Blocks and Actuator Terminal Blocks TOPJOB® S

## 2000 Series

### Description and Installation



**Commoning (signal level):**  
Commoning the signal level with push-in type jumper bars (2000 Series). Models with an LED can only be commoned in one jumper slot.  
Test Plug Adapters can be used in all jumper slots.



**Upper level: two independent signal pathways**



**Commoning (potential level):**  
Commoning potential levels via push-in type jumper bars (2000 Series).



**Power supply:**  
Orange supply terminal block of same profile from both the cabinet and sensor sides

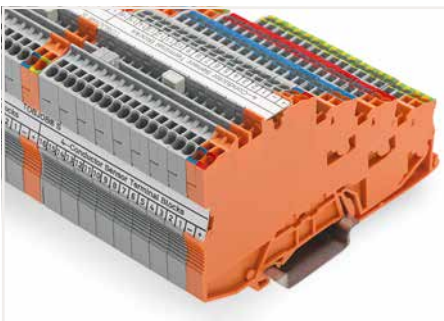

**Marking:**  
Marking strips (2009-110) – from the top or the side

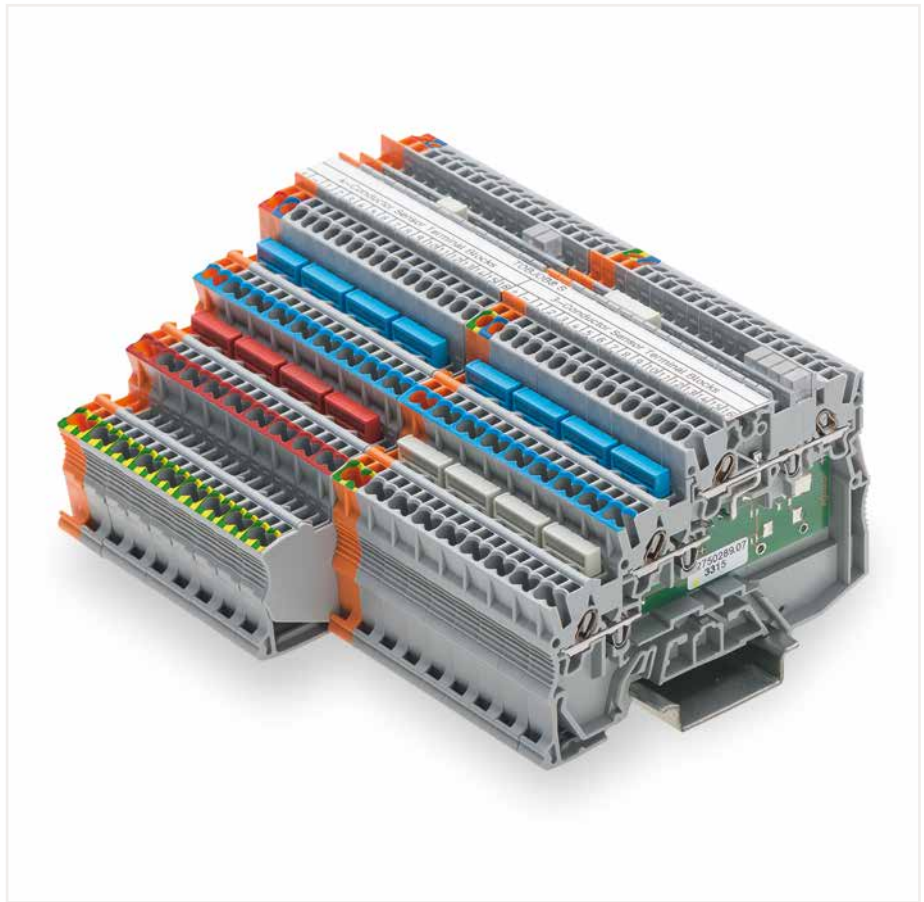

Terminal block assembly with 4-conductor sensor terminal blocks and 3-conductor actuator terminal blocks

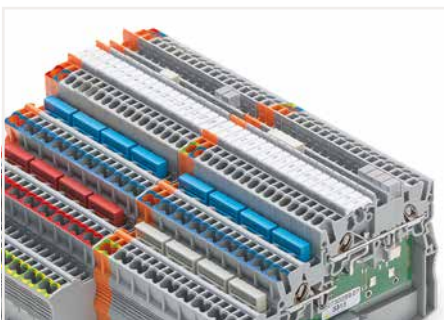

**Marking:**  
3.5 mm WMB markers (793-35xx) from the top or the side – additional marking option via marker carrier

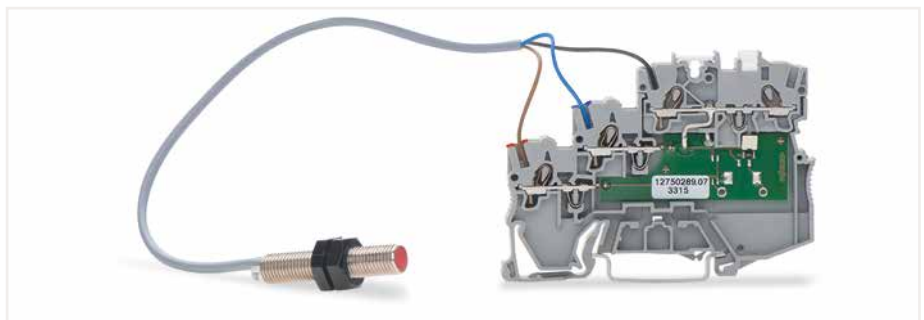

3-conductor sensor LED terminal block with a connected sensor

**PUSH-IN CAGE CLAMP®**



**Commoning (potential level):**  
Continuous commoning in the potential levels via push-in type jumper bars for even pole numbers (2000 Series)



**Potential levels:** two adjacent commoning options on a current bar

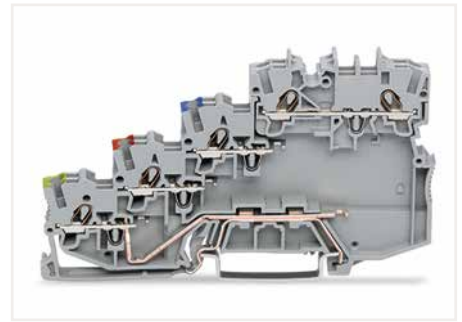

4-conductor sensor terminal block with ground contact

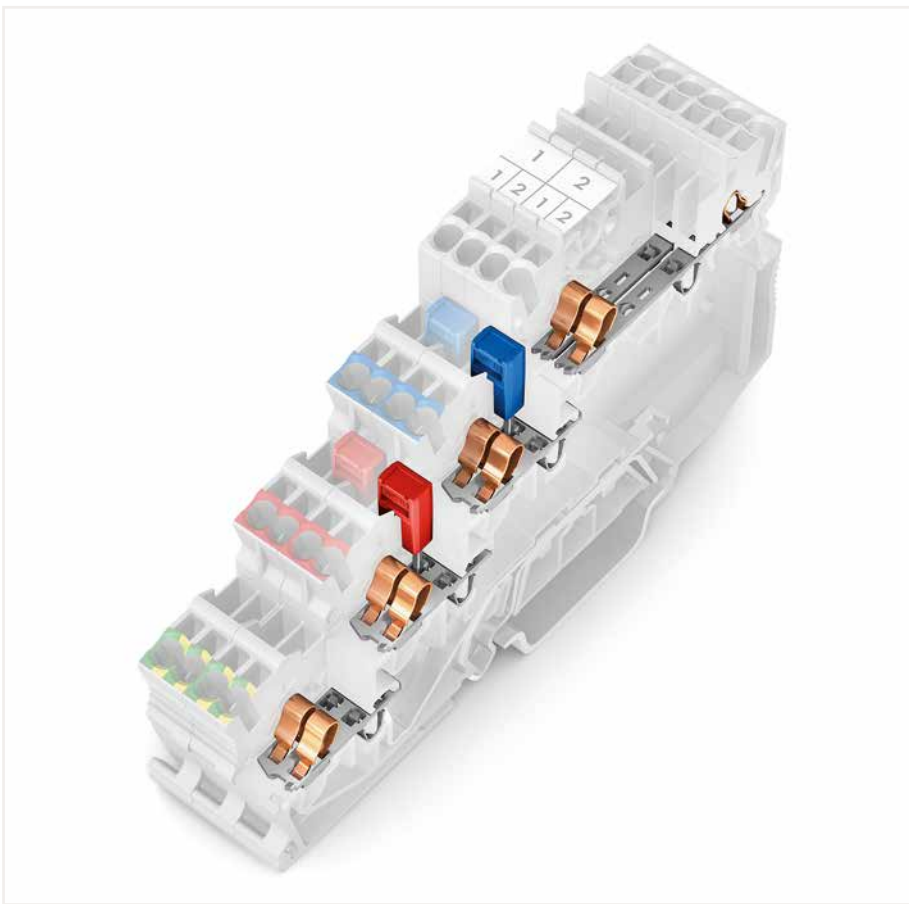

Upper level: two independent signal pathways, in 3.5 mm spacing per pole, with a dual jumper slot  
Lower levels: two interconnected potential clamping units, with a single jumper slot, can be commoned in both directions



**Ground commoning:**  
For sensor and actuator terminal blocks without ground connection to the DIN-rail, the ground connection can be performed by commoning to the terminal block with a ground foot.

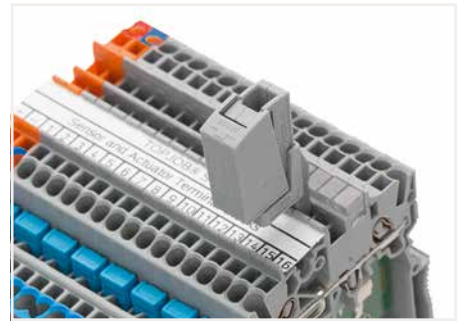

Testing via testing tap (2009-182) (up to max. 42 V).

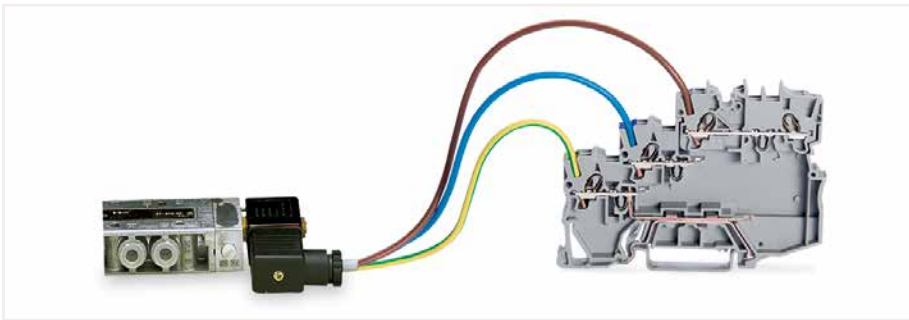

3-conductor actuator LED terminal block with a connected actuator

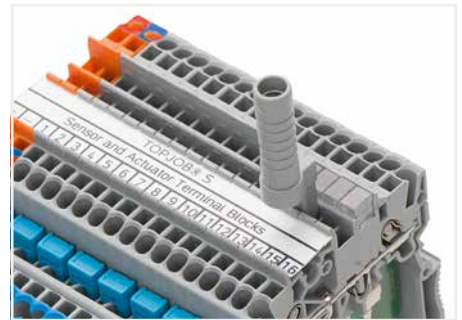

Testing via test plug adapter (2009-174) (up to max. 42 V).



# 3-Conductor Sensor Terminal Block TOPJOB® S

## 1 (1.5) mm<sup>2</sup>; 2000 Series

Technical Data	
0.14 ... 1 (1.5) mm <sup>2</sup> ①	24 ... 16 AWG
250 V/4 kV/3 ②	300 V, 10 A
I <sub>N</sub> 13.5 A	
Terminal block width: 7 mm / 0.276 inch ③	
9 ... 11 mm / 0.35 ... 0.43 inch	

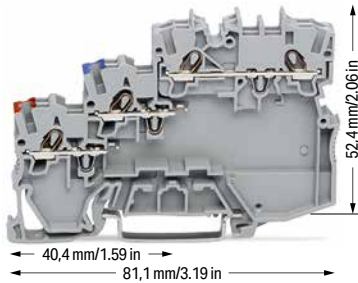

2000-5311

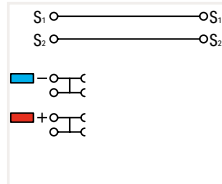

3-conductor sensor terminal block

Color	Item No.	Pack. Unit
gray	2000-5311	50

Technical Data	
0.14 ... 1 (1.5) mm <sup>2</sup> ①	24 ... 16 AWG
24 VDC	24 VDC
I <sub>N</sub> 13.5 A	
Terminal block width: 7 mm / 0.276 inch ③	
9 ... 11 mm / 0.35 ... 0.43 inch	

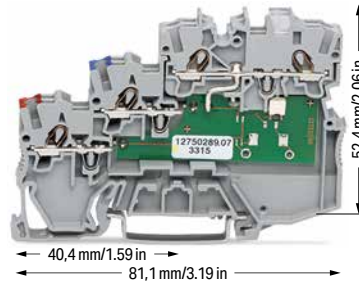

2000-5311/1102-950

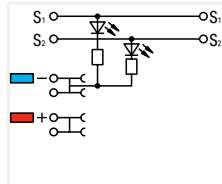

3-conductor sensor terminal block; yellow LED; for PNP (high-side) switching sensors

Color	Item No.	Pack. Unit
gray	2000-5311/1102-950	50

3-conductor sensor terminal block; yellow LED; for NPN (low-side) switching sensors

gray	2000-5311/1101-951	50
------	--------------------	----

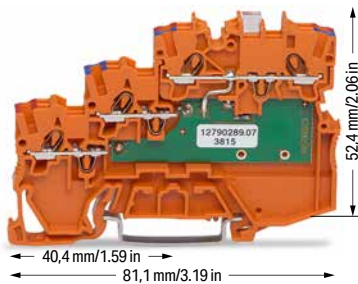

2000-5372/1102-953

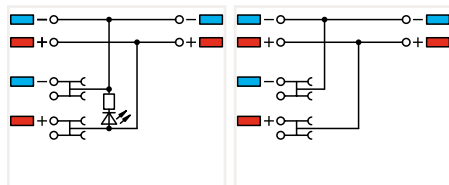

3-conductor sensor LED supply terminal block; green LED; 24 VDC

Color	Item No.	Pack. Unit
orange	2000-5372/1102-953	15

3-conductor sensor supply terminal block; max. 250 V; internally commoned

orange	2000-5372	15
--------	-----------	----

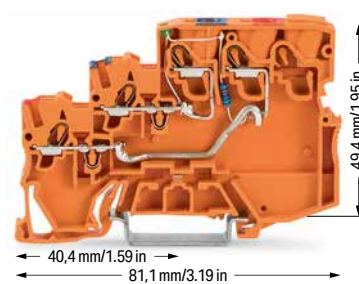

2000-5352/1102-953

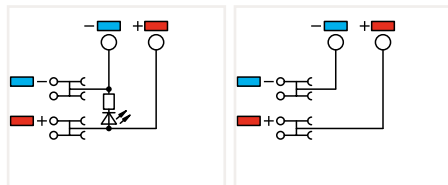

3-conductor sensor LED supply terminal block; green LED; 24 VDC control panel side: 2.5 (4) mm<sup>2</sup>; max. 28 A

Color	Item No.	Pack. Unit
orange	2000-5352/1102-953	50

3-conductor sensor supply terminal block; max. 250 V; control panel side: 2.5 (4) mm<sup>2</sup>; max. 28 A

orange	2000-5352	50
--------	-----------	----

① Conductor range: 0.14 ... 1.5 mm<sup>2</sup> "s+f-st"; Push-in termination: 0.5 ... 1.5 mm<sup>2</sup> "s" and 0.5 ... 0.75 mm<sup>2</sup> "insulated ferrules; 10 mm" Depending on the conductor characteristic, a conductor with a smaller cross section can also be inserted via push-in termination.

② 250 V = rated voltage  
4 kV = rated impulse voltage  
3 = pollution degree (see Section 14)

③ 3.5 mm spacing per signal (2 x 3.5 mm = 7 mm)  
**Note:**  
The double spacing per pole of this terminal block series maximizes connectivity. For example, ten sensors may be connected using only five sensor terminal blocks plus a power supply terminal block.

Please observe the application notes: Jumpers, from page 160

Approvals and corresponding ratings, visit [www.wago.com](http://www.wago.com)

**Accessories; for 3-conductor terminal blocks**

Appropriate marking systems:  
WMB/WMB Inline/Marking strips

**End and intermediate plate; 1 mm thick; for 3-conductor terminal blocks**

gray	2000-5391	100 (25)
------	-----------	----------

**Push-in type jumper bar; insulated; I<sub>N</sub> 14 A; light gray**

2-way	2000-402	25
3-way	2000-403	25
4-way	2000-404	25
5-way	2000-405	25
6-way	2000-406	25
7-way	2000-407	25
8-way	2000-408	25
9-way	2000-409	25
10-way	2000-410	25

**Colored push-in type jumper bar**

- red .../000-005
- blue .../000-006

**Push-in type jumper bar; insulated; I<sub>N</sub> 14 A; light gray**

1 to 3	2000-433	25
1 to 4	2000-434	25
1 to 5	2000-435	25
1 to 6	2000-436	25
1 to 7	2000-437	25
1 to 8	2000-438	25
1 to 9	2000-439	25
1 to 10	2000-440	25

**Double-deck marker carrier; pivoting**

gray	2000-121	50 (25)
------	----------	---------

**Marking strip; plain; 11 mm wide; 50 m reel**

white	2009-110	1
-------	----------	---

**WMB marking card; white; 10 strips with 10 markers/card; for 3.5 mm terminal block width**

plain	793-3501	5
-------	----------	---

**Operating tool with a partially insulated shaft; type 1; (2.5 x 0.4) mm blade**

	210-719	1
--	---------	---

# 4-Conductor Sensor Terminal Block TOPJOB® S

## 1 (1.5) mm<sup>2</sup>; 2000 Series

Technical Data	
0.14 ... 1 (1.5) mm <sup>2</sup> ①	24 ... 16 AWG
250 V/4 kV/3 ②	300 V, 10 A
I <sub>N</sub> 13.5 A	
Terminal block width: 7 mm / 0.276 inch ③	
9 ... 11 mm / 0.35 ... 0.43 inch	

Technical Data	
0.14 ... 1 (1.5) mm <sup>2</sup> ①	24 ... 16 AWG
24 VDC	24 VDC
I <sub>N</sub> 13.5 A	
Terminal block width: 7 mm / 0.276 inch ③	
9 ... 11 mm / 0.35 ... 0.43 inch	

- ① Conductor range: 0.14 ... 1.5 mm<sup>2</sup> "s+f-st"; Push-in termination: 0.5 ... 1.5 mm<sup>2</sup> "s" and 0.5 ... 0.75 mm<sup>2</sup> "insulated ferrules; 10 mm" Depending on the conductor characteristic, a conductor with a smaller cross section can also be inserted via push-in termination.
  - ② 250 V = rated voltage  
4 kV = rated impulse voltage  
3 = pollution degree (see Section 14)
  - ③ 3.5 mm spacing per signal (2 x 3.5 mm = 7 mm)  
**Note:**  
The double spacing per pole of this terminal block series maximizes connectivity. For example, ten sensors may be connected using only five sensor terminal blocks plus a power supply terminal block.
- Please observe the application notes: Jumpers, from page 160
- Approvals and corresponding ratings, visit [www.wago.com](http://www.wago.com)

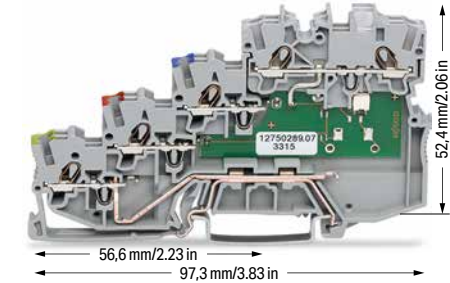
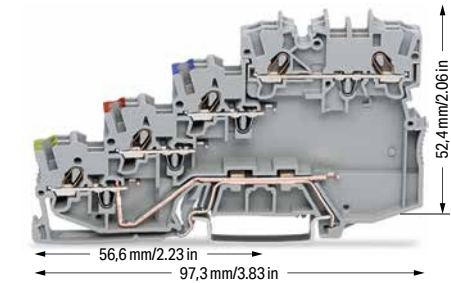

2000-5417

2000-5417/1102-950

2000-5417/1101-951

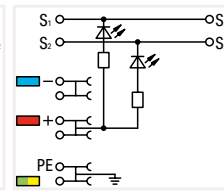
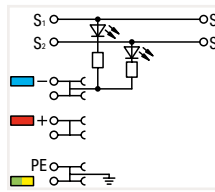
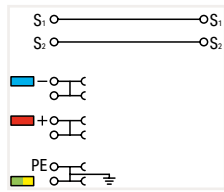

4-conductor sensor terminal block; with ground connection

4-conductor sensor LED terminal block; yellow LED; for PNP (high-side) switching sensors; with ground connection

Color	Item No.	Pack. Unit
gray	2000-5417	50

Color	Item No.	Pack. Unit
gray	2000-5417/1102-950	50

4-conductor sensor terminal block; yellow LED; for NPN (low-side) switching sensors; with ground connection

Color	Item No.	Pack. Unit
gray	2000-5417/1101-951	50

**Accessories; for 4-conductor terminal blocks**  
Appropriate marking systems:  
WMB/WMB Inline/Marking strips

End and intermediate plate; 1 mm thick; for 4-conductor terminal blocks

gray	2000-5491	100 (25)
------	-----------	----------

Push-in type jumper bar; insulated; I<sub>N</sub> 14 A; light gray

2-way	2000-402	25
3-way	2000-403	25
4-way	2000-404	25
5-way	2000-405	25
6-way	2000-406	25
7-way	2000-407	25
8-way	2000-408	25
9-way	2000-409	25
10-way	2000-410	25

Colored push-in type jumper bar

red	.../000-005
blue	.../000-006
yellow-green	.../000-018

Push-in type jumper bar; insulated; I<sub>N</sub> 14 A; light gray

1 to 3	2000-433	25
1 to 4	2000-434	25
1 to 5	2000-435	25
1 to 6	2000-436	25
1 to 7	2000-437	25
1 to 8	2000-438	25
1 to 9	2000-439	25
1 to 10	2000-440	25

Double-deck marker carrier; pivoting

gray	2000-121	50 (25)
------	----------	---------

Marking strip; plain; 11 mm wide; 50 m reel

white	2009-110	1
-------	----------	---

WMB marking card; white; 10 strips with 10 markers/card; for 3.5 mm terminal block width

plain	793-3501	5
-------	----------	---

Operating tool with a partially insulated shaft; type 1; (2.5 x 0.4) mm blade

	210-719	1
--	---------	---

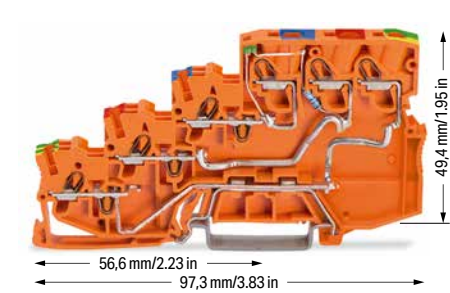
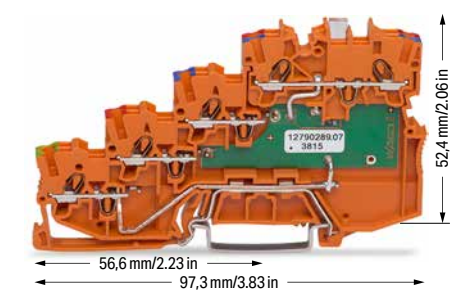

2000-5477/1102-953

2000-5477

2000-5457/1102-953

2000-5457

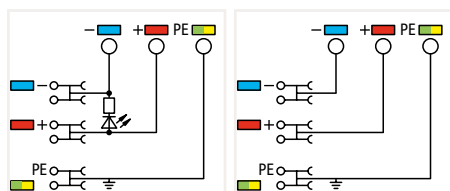
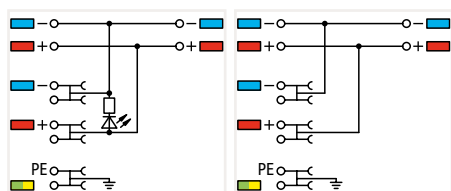

4-conductor sensor LED supply terminal block; green LED; 24 VDC; with ground connection

3-conductor sensor LED supply terminal block; green LED; 24 VDC control panel side: 2.5 (4) mm<sup>2</sup>; max. 28 A

Color	Item No.	Pack. Unit
orange	2000-5477/1102-953	15

Color	Item No.	Pack. Unit
orange	2000-5457/1102-953	15

4-conductor sensor supply terminal block; max. 250 V; internally commoned; with ground connection

4-conductor sensor supply terminal block; max. 250 V; with ground connection; control panel side: 2.5 (4) mm<sup>2</sup>; max. 28 A

Color	Item No.	Pack. Unit
orange	2000-5477	15

Color	Item No.	Pack. Unit
orange	2000-5457	15



# 3-Conductor Actuator Terminal Block TOPJOB® S

## 1 (1.5) mm<sup>2</sup>; 2000 Series

Technical Data	
0.14 ... 1 (1.5) mm <sup>2</sup> ①	24 ... 16 AWG
250 V/4 kV/3 ②	300 V, 10 A
I <sub>N</sub> 13.5 A	
Terminal block width: 7 mm / 0.276 inch ③	
9 ... 11 mm / 0.35 ... 0.43 inch	

Technical Data	
0.14 ... 1 (1.5) mm <sup>2</sup> ①	24 ... 16 AWG
24 VDC	24 VDC
I <sub>N</sub> 13.5 A	
Terminal block width: 7 mm / 0.276 inch ③	
9 ... 11 mm / 0.35 ... 0.43 inch	

① Conductor range: 0.14 ... 1.5 mm<sup>2</sup> "s+f-st"; Push-in termination: 0.5 ... 1.5 mm<sup>2</sup> "s" and 0.5 ... 0.75 mm<sup>2</sup> "insulated ferrules; 10 mm"  
Depending on the conductor characteristic, a conductor with a smaller cross section can also be inserted via push-in termination.

② 250 V = rated voltage  
4 kV = rated impulse voltage  
3 = pollution degree (see Section 14)

③ 3.5 mm spacing per signal (2 x 3.5 mm = 7 mm)  
**Note:**  
The double spacing per pole of this terminal block series maximizes connectivity. For example, ten sensors may be connected using only five sensor terminal blocks plus a power supply terminal block.

Please observe the application notes:  
Jumpers, from page 160

Approvals and corresponding ratings, visit [www.wago.com](http://www.wago.com)

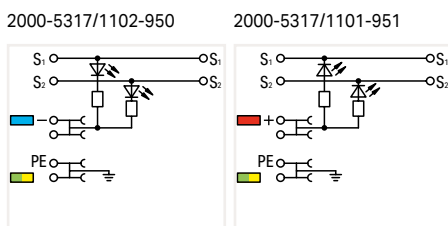
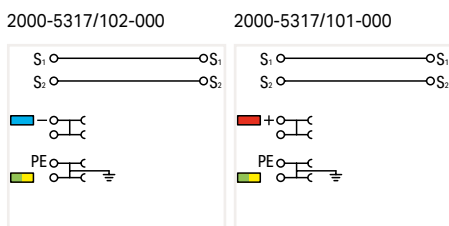
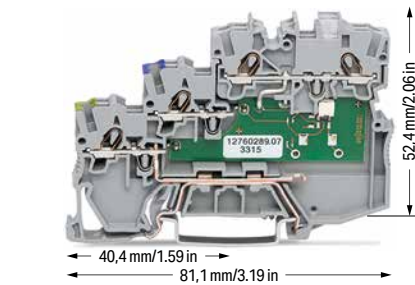
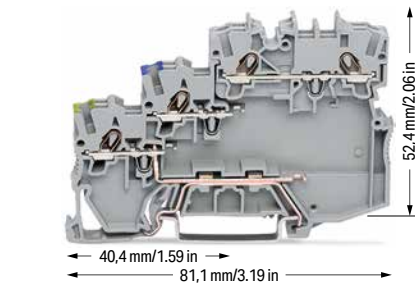

3-conductor actuator terminal block; for PNP (high-side) switching actuators; with ground connection

Color	Item No.	Pack. Unit
gray	2000-5317/102-000	50

3-conductor actuator terminal block; yellow LED; for PNP (high-side) switching actuators; with ground connection

Color	Item No.	Pack. Unit
gray	2000-5317/1102-950	50

3-conductor actuator terminal block; for NPN (low-side) switching actuators; with ground connection

Color	Item No.	Pack. Unit
gray	2000-5317/101-000	50

3-conductor actuator terminal block; yellow LED; for NPN (low-side) switching actuators; with ground connection

Color	Item No.	Pack. Unit
gray	2000-5317/1101-951	50

**Accessories; for 3-conductor terminal blocks**

Appropriate marking systems:  
WMB/WMB Inline/Marking strips

End and intermediate plate; 1 mm thick; for 3-conductor terminal blocks

gray	2000-5391	100 (25)
------	-----------	----------

**Push-in type jumper bar; insulated; I<sub>N</sub> 14 A; light gray**

2-way	2000-402	25
3-way	2000-403	25
4-way	2000-404	25
5-way	2000-405	25
6-way	2000-406	25
7-way	2000-407	25
8-way	2000-408	25
9-way	2000-409	25
10-way	2000-410	25

**Colored push-in type jumper bar**

red	.../000-005
blue	.../000-006
yellow-green	.../000-018

**Push-in type jumper bar; insulated; I<sub>N</sub> 14 A; light gray**

1 to 3	2000-433	25
1 to 4	2000-434	25
1 to 5	2000-435	25
1 to 6	2000-436	25
1 to 7	2000-437	25
1 to 8	2000-438	25
1 to 9	2000-439	25
1 to 10	2000-440	25

**Double-deck marker carrier; pivoting**

gray	2000-121	50 (25)
------	----------	---------

**Marking strip; plain; 11 mm wide; 50 m reel**

white	2009-110	1
-------	----------	---

WMB marking card; white; 10 strips with 10 markers/card; for 3.5 mm terminal block width

plain	793-3501	5
-------	----------	---

Operating tool with a partially insulated shaft; type 1; (2.5 x 0.4) mm blade

	210-719	1
--	---------	---

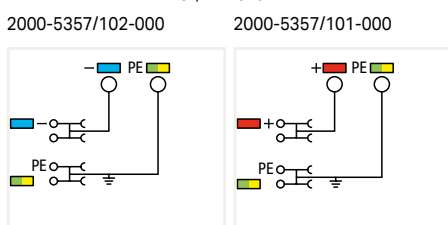
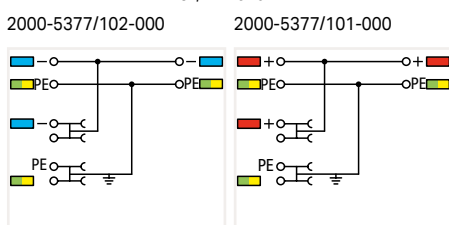
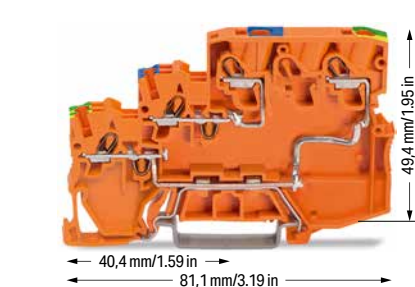
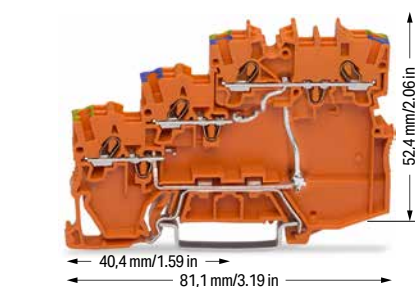

3-conductor actuator supply terminal block; max. 250 V; for PNP (high-side) switching actuators; with ground connection; internally commoned

Color	Item No.	Pack. Unit
orange	2000-5377/102-000	15

3-conductor actuator supply terminal block; max. 250 V; control panel side: 2.5 (4) mm<sup>2</sup>; max. 28 A; for PNP (high-side) switching actuators; with ground connection

Color	Item No.	Pack. Unit
orange	2000-5357/102-000	15

3-conductor actuator supply terminal block; max. 250 V; for NPN (low-side) switching actuators; with ground connection

Color	Item No.	Pack. Unit
orange	2000-5377/101-000	15

3-conductor actuator supply terminal block; max. 250 V; control panel side: 2.5 (4) mm<sup>2</sup>; max. 28 A; for NPN (low-side) switching actuators; with ground connection

Color	Item No.	Pack. Unit
orange	2000-5357/101-000	15

# 4-Conductor Sensor Terminal Block and 3-Conductor Actuator Terminal Block TOPJOB® S 1 (1.5) mm<sup>2</sup>; 2000 Series

Technical Data	
0.14 ... 1 (1.5) mm <sup>2</sup> ①	24 ... 16 AWG
250 V/4 kV/3 ②	300 V, 10 A
I <sub>N</sub> 13.5 A	
Terminal block width: 7 mm / 0.276 inch ③	
9 ... 11 mm / 0.35 ... 0.43 inch	



2000-5410

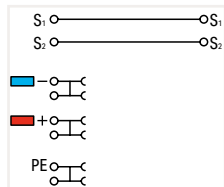

4-conductor sensor terminal block; with ground via push-in type jumper bar

Color	Item No.	Pack. Unit
○ gray	2000-5410	50

Technical Data	
0.14 ... 1 (1.5) mm <sup>2</sup> ①	24 ... 16 AWG
24 VDC	24 VDC
I <sub>N</sub> 13.5 A	
Terminal block width: 7 mm / 0.276 inch ③	
9 ... 11 mm / 0.35 ... 0.43 inch	

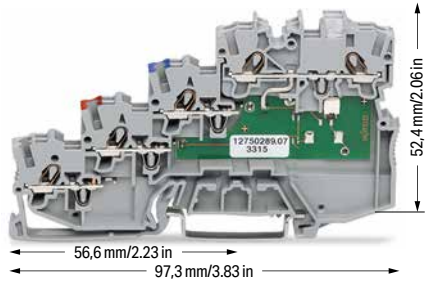

2000-5410/1102-950    2000-5410/1101-951

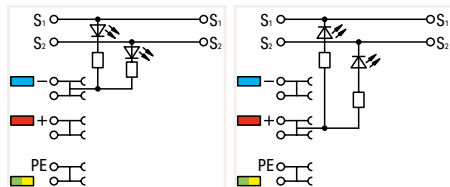

4-conductor sensor LED terminal block; yellow LED; for PNP (high-side) switching sensors; with ground via push-in type jumper bar

Color	Item No.	Pack. Unit
○ gray	2000-5410/1102-950	50

4-conductor sensor LED terminal block; yellow LED; for NPN (low-side) switching sensors; with ground via push-in type jumper bar

Color	Item No.	Pack. Unit
○ gray	2000-5410/1101-951	50

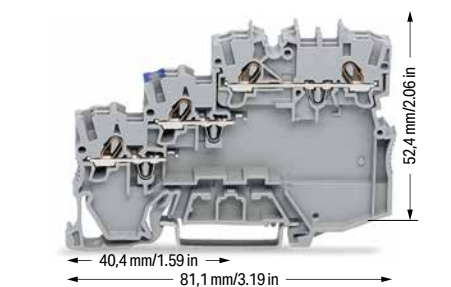

2000-5310/102-000    2000-5310/101-000

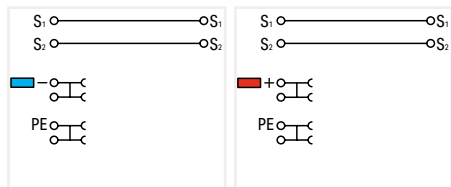

3-conductor actuator terminal block; for PNP (high-side) switching actuators; with ground via push-in type jumper bar

Color	Item No.	Pack. Unit
○ gray	2000-5310/102-000	50

3-conductor actuator terminal block; for NPN (low-side) switching actuators; with ground via push-in type jumper bar

Color	Item No.	Pack. Unit
○ gray	2000-5310/101-000	50

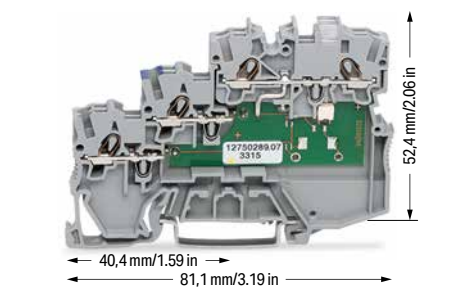

2000-5310/1102-950    2000-5310/1101-951

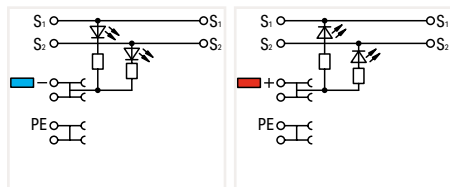

3-conductor actuator terminal block; yellow LED; for PNP (high-side) switching actuators; with ground via push-in type jumper bar

Color	Item No.	Pack. Unit
○ gray	2000-5310/1102-950	50

3-conductor actuator terminal block; yellow LED; for NPN (low-side) switching actuators; with ground via push-in type jumper bar

Color	Item No.	Pack. Unit
○ gray	2000-5310/1101-951	50

① Conductor range: 0.14 ... 1.5 mm<sup>2</sup> "s-ft-st"; Push-in termination: 0.5 ... 1.5 mm<sup>2</sup> "s" and 0.5 ... 0.75 mm<sup>2</sup> "insulated ferrules; 10 mm" Depending on the conductor characteristic, a conductor with a smaller cross section can also be inserted via push-in termination.

② 250 V = rated voltage  
4 kV = rated impulse voltage  
3 = pollution degree (see Section 14)

③ 3.5 mm spacing per signal (2 x 3.5 mm = 7 mm)  
**Note:**  
The double spacing per pole of this terminal block series maximizes connectivity. For example, ten sensors may be connected using only five sensor terminal blocks plus a power supply terminal block.

Please observe the application notes: Jumpers, from page 160

Approvals and corresponding ratings, visit [www.wago.com](http://www.wago.com)

**Accessories; for 4-conductor terminal blocks**

Appropriate marking systems:  
WMB/WMB Inline/Marking strips

End and intermediate plate; 1 mm thick; for 4-conductor terminal blocks

	gray	2000-5491	100 (25)
--	------	-----------	----------

Push-in type jumper bar; insulated; I<sub>N</sub> 14 A; light gray

	2-way	2000-402	25
	3-way	2000-403	25
	4-way	2000-404	25
	5-way	2000-405	25
	6-way	2000-406	25
	7-way	2000-407	25
	8-way	2000-408	25
	9-way	2000-409	25
	10-way	2000-410	25

Colored push-in type jumper bar

- red .../000-005
- blue .../000-006
- yellow-green .../000-018

Push-in type jumper bar; insulated; I<sub>N</sub> 14 A; light gray

	1 to 3	2000-433	25
	1 to 4	2000-434	25
	1 to 5	2000-435	25
	1 to 6	2000-436	25
	1 to 7	2000-437	25
	1 to 8	2000-438	25
	1 to 9	2000-439	25
	1 to 10	2000-440	25

Double-deck marker carrier; pivoting

	gray	2000-121	50 (25)
--	------	----------	---------

Marking strip; plain; 11 mm wide; 50 m reel

	white	2009-110	1
--	-------	----------	---

WMB marking card; white; 10 strips with 10 markers/card; for 3.5 mm terminal block width

	plain	793-3501	5
--	-------	----------	---

Operating tool with a partially insulated shaft; type 1; (2.5 x 0.4) mm blade

		210-719	1
--	--	---------	---

PUSH-IN CAGE CLAMP®

# Sensor Terminal Blocks and Actuator Terminal Blocks TOPJOB® S; with Pluggable Signal Level 2020 Series

## Description and Installation

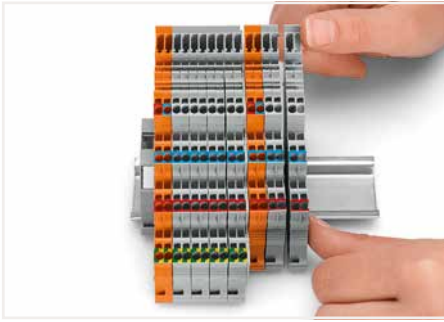

Snap individual terminal blocks onto the DIN-rail and slide together.



Separate terminal block assembly and slide individual terminal blocks laterally using an operating tool.

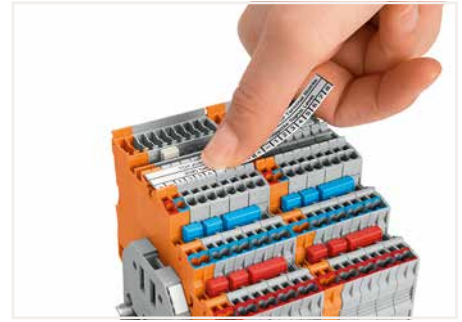

Labeling terminal blocks via marking strips (2009-110) or 3.5 mm wide WMB markers (793-35xx) – from the top or the side.

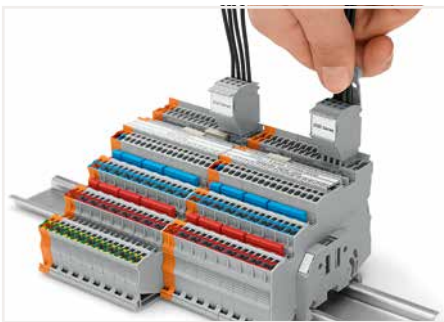

Removing a female plug via conductor bundle provided with strain relief plate.

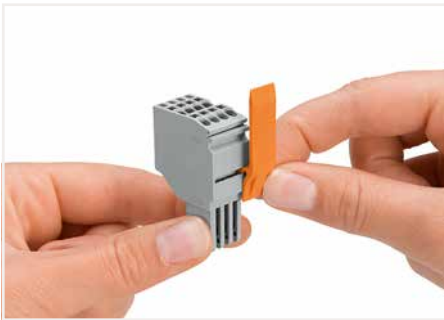

Slide the locking lever into position.



Testing via testing tap (2009-182) or test plug adapter (2009-174) (up to max. 42 V).



Insert coding pin into the corresponding slot and twist it off.



Remove the coding finger using a cutting tool.



# 3-Conductor Sensor Terminal Block TOPJOB® S; with Pluggable Signal Level 1 (1.5) mm<sup>2</sup>; 2020 Series

Technical Data	
0.14 ... 1 (1.5) mm <sup>2</sup> ①	24 ... 16 AWG
250 V/4 kV/3 ②	300 V, 10 A
I <sub>N</sub> 13.5 A	
Terminal block width: 7 mm / 0.276 inch ③	
9 ... 11 mm / 0.35 ... 0.43 inch	

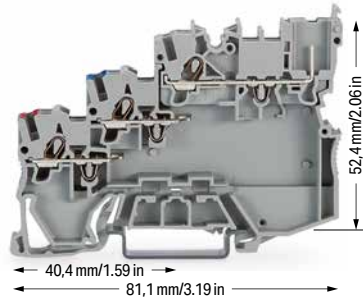

2020-5311

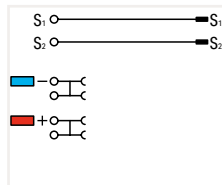

3-conductor sensor terminal block; with pluggable signal level

Color	Item No.	Pack. Unit
gray	2020-5311	50

**Note:**

According to EN 61984, pluggable connectors without a current interrupting capacity must not be mated or unmated when live or under load. An appropriate end plate must be applied to the carrier terminal blocks after each female plug.

Technical Data	
0.14 ... 1 (1.5) mm <sup>2</sup> ①	24 ... 16 AWG
24 VDC	24 VDC
I <sub>N</sub> 13.5 A	
Terminal block width: 7 mm / 0.276 inch ③	
9 ... 11 mm / 0.35 ... 0.43 inch	

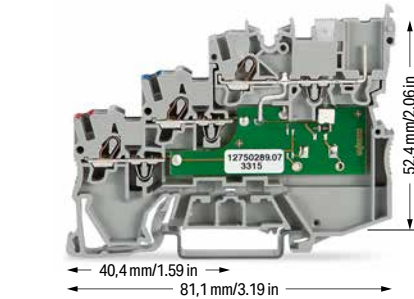

2020-5311/1102-950

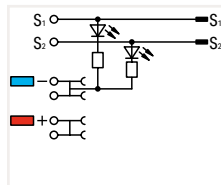

3-conductor sensor terminal block; yellow LED; for PNP (high-side) switching sensors; with pluggable signal level

Color	Item No.	Pack. Unit
gray	2020-5311/1102-950	50

- ① Conductor range: 0.14 ... 1.5 mm<sup>2</sup> "s+f-st"; Push-in termination: 0.5 ... 1.5 mm<sup>2</sup> "s" and 0.5 ... 0.75 mm<sup>2</sup> "insulated ferrules; 10 mm" Depending on the conductor characteristic, a conductor with a smaller cross section can also be inserted via push-in termination.
  - ② 250 V = rated voltage  
4 kV = rated impulse voltage  
3 = pollution degree (see Section 14)
  - ③ 3.5 mm spacing per signal (2 x 3.5 mm = 7 mm)  
**Note:**  
The double spacing per pole of this terminal block series maximizes connectivity. For example, ten sensors may be connected using only five sensor terminal blocks plus a power supply terminal block.
- Please observe the application notes:  
Jumpers, from page 160
- Approvals and corresponding ratings, visit [www.wago.com](http://www.wago.com)

**Accessories; for 3-conductor terminal blocks**  
Appropriate marking systems:  
WMB/WMB Inline/Marking strips

End and intermediate plate; 1 mm thick; for 3-conductor terminal blocks

	gray	2020-5391	100 (25)
--	------	-----------	----------

Push-in type jumper bar; insulated; I<sub>N</sub> 14 A; light gray

	2-way	2000-402	25
	3-way	2000-403	25
	4-way	2000-404	25
	5-way	2000-405	25
	6-way	2000-406	25
	7-way	2000-407	25
	8-way	2000-408	25
	9-way	2000-409	25
	10-way	2000-410	25

Colored push-in type jumper bar

- red .../000-005
- blue .../000-006

Push-in type jumper bar; insulated; I<sub>N</sub> 14 A; light gray

	1 to 3	2000-433	25
	1 to 4	2000-434	25
	1 to 5	2000-435	25
	1 to 6	2000-436	25
	1 to 7	2000-437	25
	1 to 8	2000-438	25
	1 to 9	2000-439	25
	1 to 10	2000-440	25

Carrier with 6 coding pins; for coding female plugs

	orange	2020-100	100 (25)
--	--------	----------	----------

1-conductor female plug

	gray	2020-102	100
--	------	----------	-----

2-conductor female plug

	gray	2020-202	100
--	------	----------	-----

Test plug adapter; for 4 mm Ø test plug

	gray	2009-174	100 (25)
--	------	----------	----------

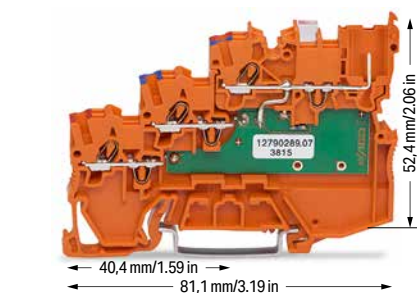

2020-5372/1102-953

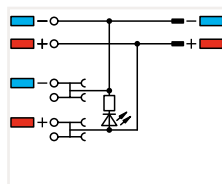

3-conductor sensor LED supply terminal block; green LED; 24 VDC; with pluggable signal level

Color	Item No.	Pack. Unit
orange	2020-5372/1102-953	15

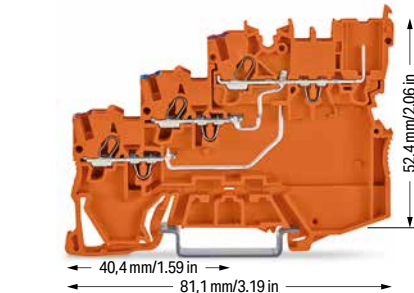

2020-5372

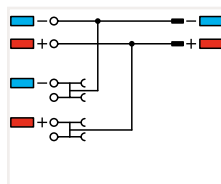

3-conductor sensor supply terminal block; max. 250 V; internally commoned; with pluggable signal level

Color	Item No.	Pack. Unit
orange	2020-5372	50

# 4-Conductor Sensor Terminal Block TOPJOB® S; with Pluggable Signal Level 1 (1.5) mm<sup>2</sup>; 2020 Series

Technical Data	
0.14 ... 1 (1.5) mm <sup>2</sup> ①	24 ... 16 AWG
250 V/4 kV/3 ②	300 V, 10 A
I <sub>N</sub> 13.5 A	
Terminal block width: 7 mm / 0.276 inch ③	
9 ... 11 mm / 0.35 ... 0.43 inch	



2020-5417

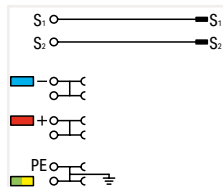

4-conductor sensor terminal block; with ground connection; with pluggable signal level

Color	Item No.	Pack. Unit
gray	2020-5417	50

**Note:**

According to EN 61984, pluggable connectors without a current interrupting capacity must not be mated or unmated when live or under load. An appropriate end plate must be applied to the carrier terminal blocks after each female plug.

Technical Data	
0.14 ... 1 (1.5) mm <sup>2</sup> ①	24 ... 16 AWG
24 VDC	24 VDC
I <sub>N</sub> 13.5 A	
Terminal block width: 7 mm / 0.276 inch ③	
9 ... 11 mm / 0.35 ... 0.43 inch	

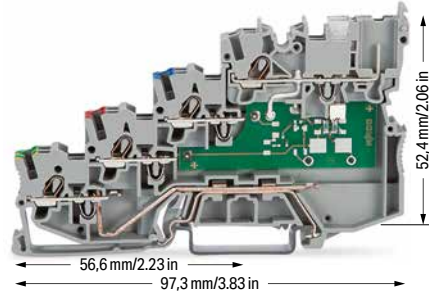

2020-5417/1102-950

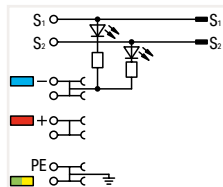

4-conductor sensor terminal block; yellow LED; for PNP (high-side) switching sensors; with ground connection; with pluggable signal level

Color	Item No.	Pack. Unit
gray	2020-5417/1102-950	50

① Conductor range: 0.14 ... 1.5 mm<sup>2</sup> "s+f-st"; Push-in termination: 0.5 ... 1.5 mm<sup>2</sup> "s" and 0.5 ... 0.75 mm<sup>2</sup> "insulated ferrules; 10 mm" Depending on the conductor characteristic, a conductor with a smaller cross section can also be inserted via push-in termination.

② 250 V = rated voltage  
4 kV = rated impulse voltage  
3 = pollution degree (see Section 14)

③ 3.5 mm spacing per signal (2 x 3.5 mm = 7 mm)  
**Note:**  
The double spacing per pole of this terminal block series maximizes connectivity. For example, ten sensors may be connected using only five sensor terminal blocks plus a power supply terminal block.

Please observe the application notes: Jumpers, from page 160

Approvals and corresponding ratings, visit [www.wago.com](http://www.wago.com)

**Accessories; for 4-conductor terminal blocks**

Appropriate marking systems:  
WMB/WMB Inline/Marking strips

**End and intermediate plate; 1 mm thick; for 4-conductor terminal blocks**

gray	2020-5491	100 (25)
------	-----------	----------

**Push-in type jumper bar; insulated; I<sub>N</sub> 14 A; light gray**

2-way	2000-402	25
3-way	2000-403	25
4-way	2000-404	25
5-way	2000-405	25
6-way	2000-406	25
7-way	2000-407	25
8-way	2000-408	25
9-way	2000-409	25
10-way	2000-410	25

**Colored push-in type jumper bar**

- red .../000-005
- blue .../000-006
- yellow-green .../000-018

**Push-in type jumper bar; insulated; I<sub>N</sub> 14 A; light gray**

1 to 3	2000-433	25
1 to 4	2000-434	25
1 to 5	2000-435	25
1 to 6	2000-436	25
1 to 7	2000-437	25
1 to 8	2000-438	25
1 to 9	2000-439	25
1 to 10	2000-440	25

**Carrier with 6 coding pins; for coding female plugs**

orange	2020-100	100 (25)
--------	----------	----------

**1-conductor female plug**

gray	2020-102	100
------	----------	-----

**2-conductor female plug**

gray	2020-202	100
------	----------	-----

**Test plug adapter; for 4 mm Ø test plug**

gray	2009-174	100 (25)
------	----------	----------

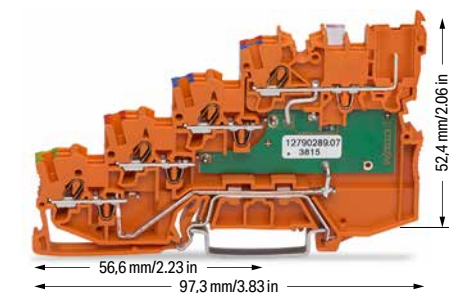

2020-5477/1102-953

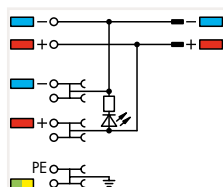

4-conductor sensor LED supply terminal block; green LED; 24 VDC; with ground connection; with pluggable signal level

Color	Item No.	Pack. Unit
orange	2020-5477/1102-953	15

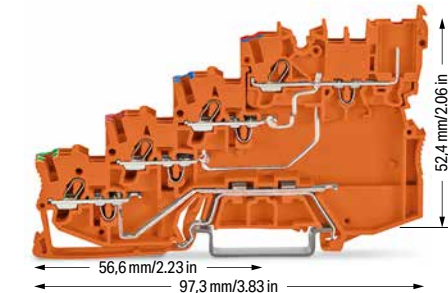

2020-5477

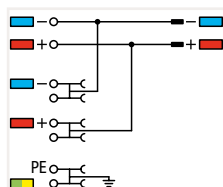

4-conductor sensor supply terminal block; max. 250 V; internally commoned; with ground connection; with pluggable signal level

Color	Item No.	Pack. Unit
orange	2020-5477	50



### 3-Conductor Actuator Terminal Block TOPJOB® S; with Pluggable Signal Level 1 (1.5) mm<sup>2</sup>; 2020 Series

Technical Data	
0.14 ... 1 (1.5) mm <sup>2</sup> ①	24 ... 16 AWG
250 V/4 kV/3 ②	300 V, 10 A
I <sub>N</sub> 13.5 A	
Terminal block width: 7 mm / 0.276 inch ③	
9 ... 11 mm / 0.35 ... 0.43 inch	

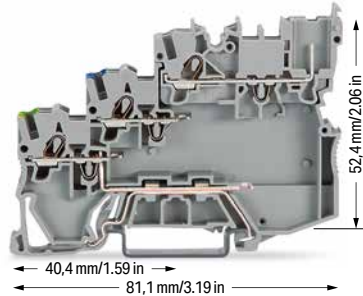

2020-5317/102-000

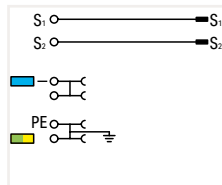

3-conductor actuator terminal block; for PNP (high-side) switching actuators; with ground connection; with pluggable signal level

Color	Item No.	Pack. Unit
gray	2020-5317/102-000	50

**Note:**

According to EN 61984, pluggable connectors without a current interrupting capacity must not be mated or unmated when live or under load. An appropriate end plate must be applied to the carrier terminal blocks after each female plug.

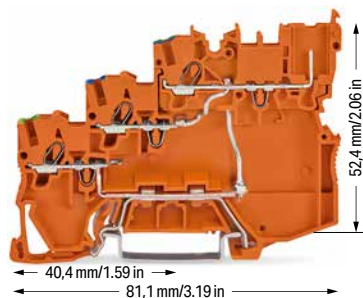

2020-5377/102-000

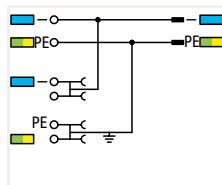

3-conductor actuator supply terminal block; for PNP (high-side) switching actuators; with ground connection; internally commoned; with pluggable signal level

Color	Item No.	Pack. Unit
orange	2020-5377/102-000	15

Technical Data	
0.14 ... 1 (1.5) mm <sup>2</sup> ①	24 ... 16 AWG
24 VDC	24 VDC
I <sub>N</sub> 13.5 A	
Terminal block width: 7 mm / 0.276 inch ③	
9 ... 11 mm / 0.35 ... 0.43 inch	

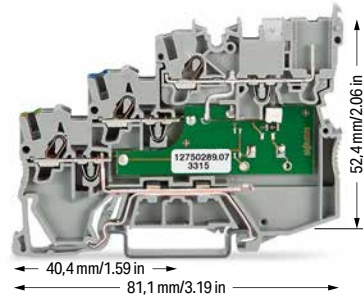

2020-5317/1102-950

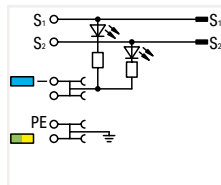

3-conductor actuator terminal block; yellow LED; for PNP (high-side) switching actuators; with ground connection; with pluggable signal level

Color	Item No.	Pack. Unit
gray	2020-5317/1102-950	50

① Conductor range: 0.14 ... 1.5 mm<sup>2</sup> "s-ft-st"; Push-in termination: 0.5 ... 1.5 mm<sup>2</sup> "s" and 0.5 ... 0.75 mm<sup>2</sup> "insulated ferrules; 10 mm" Depending on the conductor characteristic, a conductor with a smaller cross section can also be inserted via push-in termination.

② 250 V = rated voltage  
4 kV = rated impulse voltage  
3 = pollution degree (see Section 14)

③ 3.5 mm spacing per signal (2 x 3.5 mm = 7 mm)  
**Note:**  
The double spacing per pole of this terminal block series maximizes connectivity. For example, ten sensors may be connected using only five sensor terminal blocks plus a power supply terminal block.

Please observe the application notes: Jumpers, from page 160

Approvals and corresponding ratings, visit [www.wago.com](http://www.wago.com)

**Accessories; for 3-conductor terminal blocks**

Appropriate marking systems:  
WMB/WMB Inline/Marking strips

**End and intermediate plate; 1 mm thick; for 3-conductor terminal blocks**

	gray	2020-5391	100 (25)
--	------	-----------	----------

**Push-in type jumper bar; insulated; I<sub>N</sub> 14 A; light gray**

	2-way	2000-402	25
	3-way	2000-403	25
	4-way	2000-404	25
	5-way	2000-405	25
	6-way	2000-406	25
	7-way	2000-407	25
	8-way	2000-408	25
	9-way	2000-409	25
	10-way	2000-410	25

**Colored push-in type jumper bar**

- red .../000-005
- blue .../000-006
- yellow-green .../000-018

**Push-in type jumper bar; insulated; I<sub>N</sub> 14 A; light gray**

	1 to 3	2000-433	25
	1 to 4	2000-434	25
	1 to 5	2000-435	25
	1 to 6	2000-436	25
	1 to 7	2000-437	25
	1 to 8	2000-438	25
	1 to 9	2000-439	25
	1 to 10	2000-440	25

**Carrier with 6 coding pins; for coding female plugs**

	orange	2020-100	100 (25)
--	--------	----------	----------

**1-conductor female plug**

	gray	2020-102	100
--	------	----------	-----

**2-conductor female plug**

	gray	2020-202	100
--	------	----------	-----

**Test plug adapter; for 4 mm Ø test plug**

	gray	2009-174	100 (25)
--	------	----------	----------

# Diode Terminal Block, LED Terminal Block TOPJOB® S

## 1.5 (2.5) mm<sup>2</sup>; 2001 Series

Technical Data	
0.25 ... 1.5 (2.5) mm <sup>2</sup> ①	22 ... 14 AWG
U <sub>N</sub> 250 V; U <sub>RM</sub> 1000 V	
1N4007 - 0.5 A continuous current	
Terminal block width: 4.2 mm / 0.165 inch	
9 ... 11 mm / 0.35 ... 0.43 inch	

Technical Data	
0.25 ... 1.5 (2.5) mm <sup>2</sup> ①	22 ... 14 AWG
U <sub>N</sub> 250 V; U <sub>RM</sub> 1000 V	
1N4007 - 0.5 A continuous current	
Terminal block width: 4.2 mm / 0.165 inch	
9 ... 11 mm / 0.35 ... 0.43 inch	

Technical Data	
0.25 ... 1.5 (2.5) mm <sup>2</sup> ①	22 ... 14 AWG
24 VDC	
I <sub>F</sub> 0.025 A max.	
Terminal block width: 4.2 mm / 0.165 inch	
9 ... 11 mm / 0.35 ... 0.43 inch	

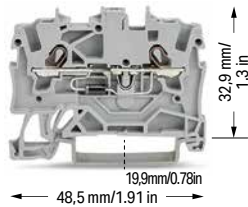

2001-1211/1000-411      2001-1211/1000-410

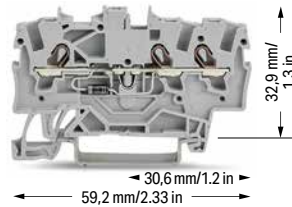

2001-1311/1000-411      2001-1311/1000-410

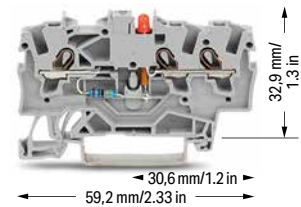

2001-1321/1000-434      2001-1321/1000-413

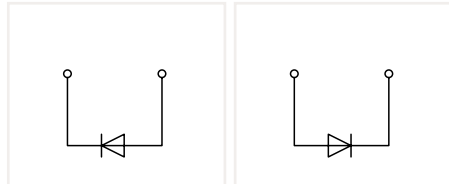

2-conductor diode terminal block; with 1N4007 diode

Color	Item No.	Pack. Unit
○ gray	2001-1211/1000-411	100
○ gray	2001-1211/1000-410	100

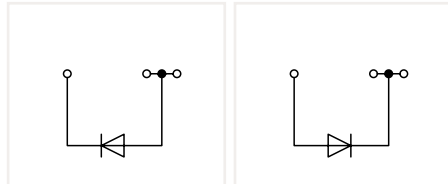

3-conductor diode terminal block; with 1N4007 diode

Color	Item No.	Pack. Unit
○ gray	2001-1311/1000-411	100
○ gray	2001-1311/1000-410	100

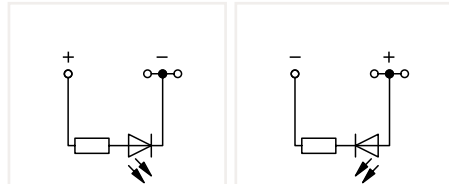

3-conductor LED terminal block; with red LED  
Notice: This LED terminal block cannot be commoned with push-in type jumper bars.

Color	Item No.	Pack. Unit
○ gray	2001-1321/1000-434	100
○ gray	2001-1321/1000-413	100

Other terminal blocks with the same profile:		
Through	2001-1201	Page 36

Other terminal blocks with the same profile:		
Through	2001-1301	Page 36

Other terminal blocks with the same profile:		
Through	2001-1301	Page 36

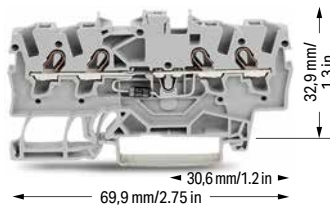

2001-1411/1000-411      2001-1411/1000-410

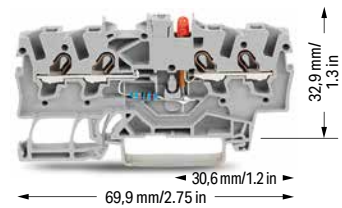

2001-1411/1000-434      2001-1411/1000-413

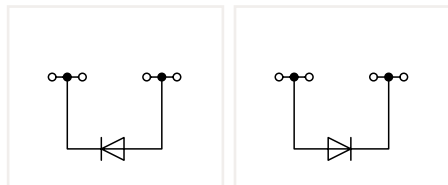

4-conductor diode terminal block; with 1N4007 diode

Color	Item No.	Pack. Unit
○ gray	2001-1411/1000-411	100
○ gray	2001-1411/1000-410	100

Other terminal blocks with the same profile:		
Through	2001-1401	Page 36

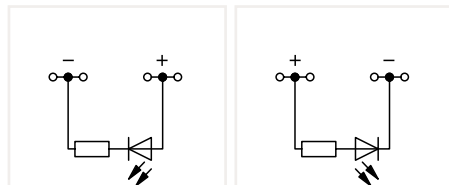

4-conductor LED terminal block; with red LED  
Notice: This LED terminal block cannot be commoned with push-in type jumper bars.

Color	Item No.	Pack. Unit
○ gray	2001-1421/1000-434	100
○ gray	2001-1421/1000-413	100

Other terminal blocks with the same profile:		
Through	2001-1401	Page 36

# Diode Terminal Blocks and LED Terminal Blocks TOPJOB® S Circuit Configuration Examples

❶ Conductor range: 0.25 ... 2.5 mm<sup>2</sup> "s+f-st";  
Push-in termination: 0.75 ... 2.5 mm<sup>2</sup> "s" and  
0.75 ... 1.5 mm<sup>2</sup> "insulated ferrules; 12 mm"  
Depending on the conductor characteristic, a conductor  
with a smaller cross section can also be inserted  
via push-in termination.

Approvals and corresponding ratings,  
visit [www.wago.com](http://www.wago.com)

**Accessories; 2001 Series**

Appropriate marking systems:  
WMB/WMB Inline/Marking strips

**Insulation stop; 5 pcs/strip; 0.25 ... 0.5 mm<sup>2</sup>**

light gray 2001-171 200 (25)



**Push-in type jumper bar; insulated; I<sub>n</sub> 18 A; light gray**



2-way	2001-402	25
3-way	2001-403	25
4-way	2001-404	25
5-way	2001-405	25
6-way	2001-406	25
7-way	2001-407	25
8-way	2001-408	25
9-way	2001-409	25
10-way	2001-410	25

**Push-in type jumper bar; insulated; I<sub>n</sub> 18 A; light gray**



1 to 3	2001-433	25
1 to 4	2001-434	25
1 to 5	2001-435	25
1 to 6	2001-436	25
1 to 7	2001-437	25
1 to 8	2001-438	25
1 to 9	2001-439	25
1 to 10	2001-440	25

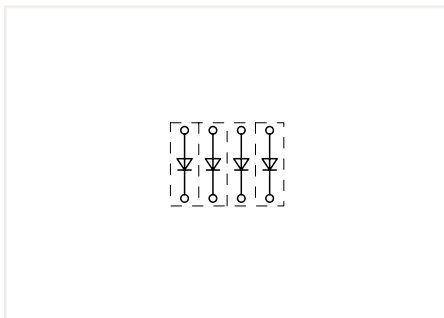

Open diode gates can be created using the following terminal blocks:  
2001-1211/1000-410 or 2001-1211/1000-411



These diode terminal blocks have been specially developed for custom diode circuits, such as lamp test and collective fault signal circuits.

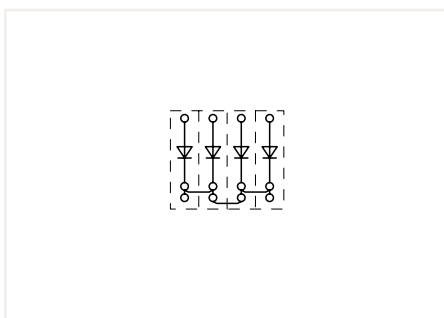

Polarized diode gates with a common cathode can be created using the following terminal blocks:  
2001-1311/1000-410 or 2001-1311/1000-411

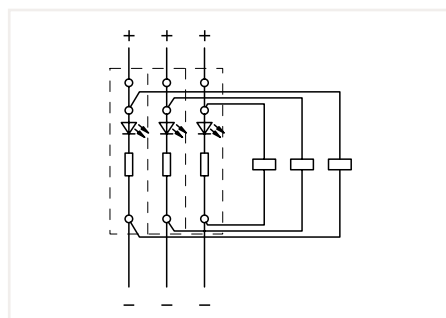

Circuit-related voltage indications can be created using the following terminal blocks:  
2001-1321/1000-434 or 2001-1321/1000-413

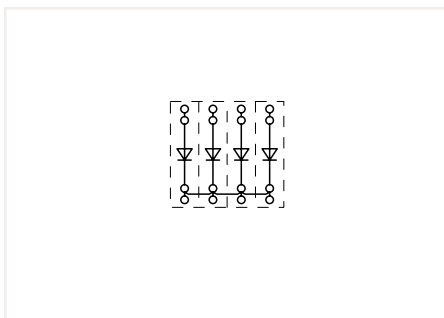

Polarized diode gates with a common cathode can be created using the following terminal blocks:  
2001-1411/1000-410 or 2001-1411/1000-411

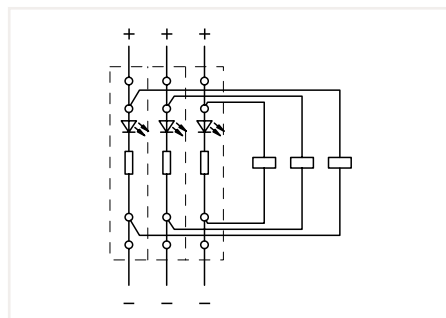

Circuit-related voltage indications can be created using the following terminal blocks:  
2001-1421/1000-434 or 2001-1421/1000-413

Sold & Serviced By:



Toll Free Phone (877) SERV098  
[www.electromate.com](http://www.electromate.com)  
[sales@electromate.com](mailto:sales@electromate.com)

# Diode Terminal Block, LED Terminal Block TOPJOB® S

## 2.5 (4) mm<sup>2</sup>; 2002 Series

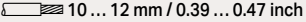
Technical Data	
0.25 ... 2.5 (4) mm <sup>2</sup> ①	22 ... 12 AWG
U <sub>N</sub> 250 V; U <sub>RM</sub> 1000 V	
1N4007 - 0.5 A continuous current	
Terminal block width: 5.2 mm / 0.205 inch	
 10 ... 12 mm / 0.39 ... 0.47 inch	

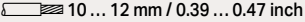
Technical Data	
0.25 ... 2.5 (4) mm <sup>2</sup> ①	22 ... 12 AWG
U <sub>N</sub> 250 V; U <sub>RM</sub> 1000 V	
1N4007 - 0.5 A continuous current	
Terminal block width: 5.2 mm / 0.205 inch	
 10 ... 12 mm / 0.39 ... 0.47 inch	

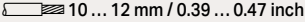
Technical Data	
0.25 ... 2.5 (4) mm <sup>2</sup> ①	22 ... 12 AWG
24 VDC	
I <sub>F</sub> 0.025 A max.	
Terminal block width: 5.2 mm / 0.205 inch	
 10 ... 12 mm / 0.39 ... 0.47 inch	

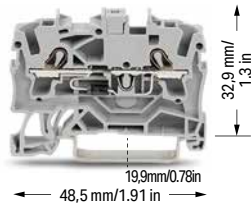

2002-1211/1000-411      2002-1211/1000-410

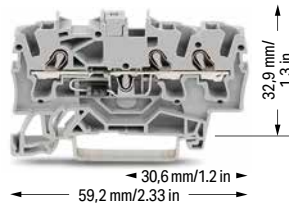

2002-1311/1000-411      2002-1311/1000-410

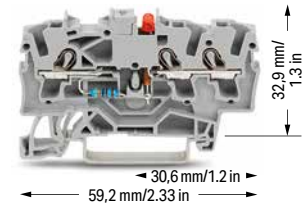

2002-1321/1000-434      2002-1321/1000-413

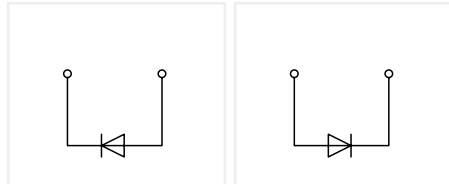

2-conductor diode terminal block; with 1N4007 diode

Color	Item No.	Pack. Unit
○ gray	2002-1211/1000-411	100
○ gray	2002-1211/1000-410	100

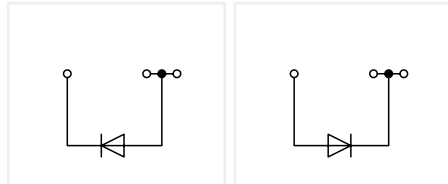

3-conductor diode terminal block; with 1N4007 diode

Color	Item No.	Pack. Unit
○ gray	2002-1311/1000-411	100
○ gray	2002-1311/1000-410	100

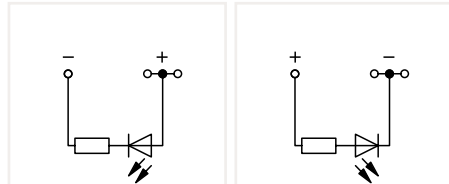

3-conductor LED terminal block; with red LED  
Notice: This LED terminal block cannot be commoned with push-in type jumper bars.

Color	Item No.	Pack. Unit
○ gray	2002-1321/1000-434	100
○ gray	2002-1321/1000-413	100

Other terminal blocks with the same profile:		
Through	2002-1201	Page 38

Other terminal blocks with the same profile:		
Through	2002-1301	Page 38

Other terminal blocks with the same profile:		
Through	2002-1301	Page 38



2002-1411/1000-411      2002-1411/1000-410

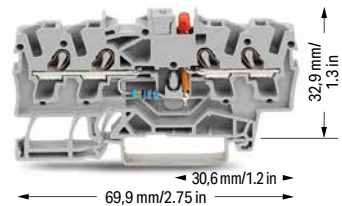

2002-1411/1000-434      2002-1411/1000-413

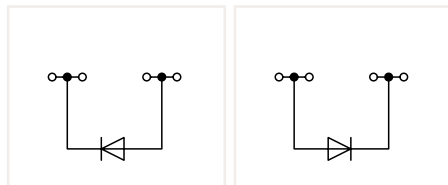

4-conductor diode terminal block; with 1N4007 diode

Color	Item No.	Pack. Unit
○ gray	2002-1411/1000-411	100
○ gray	2002-1411/1000-410	100

Other terminal blocks with the same profile:		
Through	2002-1401	Page 38

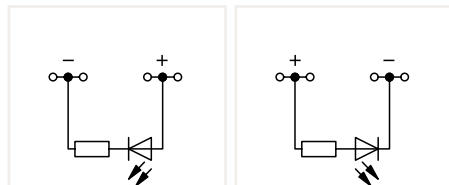

4-conductor LED terminal block; with red LED  
Notice: This LED terminal block cannot be commoned with push-in type jumper bars.

Color	Item No.	Pack. Unit
○ gray	2002-1421/1000-434	100
○ gray	2002-1421/1000-413	100

Other terminal blocks with the same profile:		
Through	2002-1401	Page 38

# Diode Terminal Blocks and LED Terminal Blocks TOPJOB® S Circuit Configuration Examples

① Conductor range: 0.25 ... 4 mm<sup>2</sup> "s+f-st";  
Push-in termination: 1 ... 4 mm<sup>2</sup> "s" and 1 ... 2.5 mm<sup>2</sup>  
"insulated ferrules, 12 mm"  
Depending on the conductor characteristic, a conductor with a smaller cross section can also be inserted via push-in termination.

Approvals and corresponding ratings, visit [www.wago.com](http://www.wago.com)

**Accessories; 2002 Series**  
Appropriate marking systems:  
WMB/WMB Inline/Marking strips

**Insulation stop; 5 pcs/strip; 0.25 ... 0.5 mm<sup>2</sup>**

light gray	2002-171	200 (25)
------------	----------	----------

**Insulation stop; 5 pcs/strip; 0.75 ... 1 mm<sup>2</sup>**

dark gray	2002-172	200 (25)
-----------	----------	----------

**Push-in type jumper bar; insulated; I<sub>n</sub> 25 A; light gray**

2-way	2002-402	25
3-way	2002-403	25
4-way	2002-404	25
5-way	2002-405	25
6-way	2002-406	25
7-way	2002-407	25
8-way	2002-408	25
9-way	2002-409	25
10-way	2002-410	25

**Push-in type jumper bar; insulated; I<sub>n</sub> 25 A; light gray**

1 to 3	2002-433	25
1 to 4	2002-434	25
1 to 5	2002-435	25
1 to 6	2002-436	25
1 to 7	2002-437	25
1 to 8	2002-438	25
1 to 9	2002-439	25
1 to 10	2002-440	25

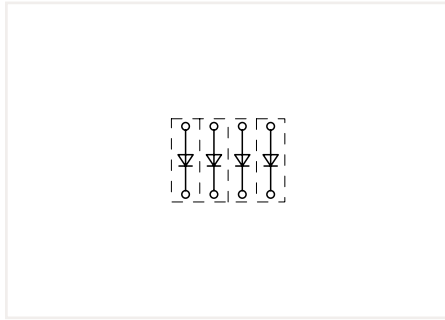

Open diode gates can be created using the following terminal blocks:  
2002-1211/1000-410 or 2002-1211/1000-411

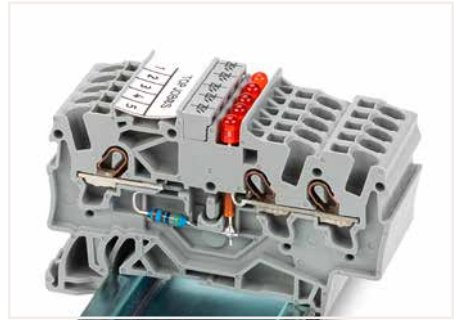

Using LED terminal blocks, monitoring units can be designed, e.g., for control and operating circuits.

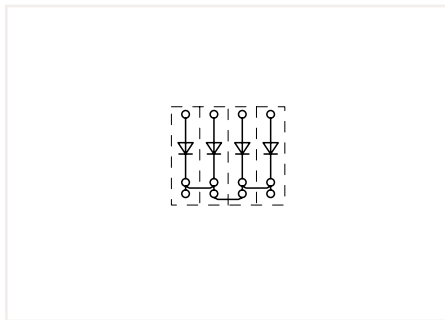

Polarized diode gates with a common cathode can be created using the following terminal blocks:  
2002-1311/1000-410 or 2002-1311/1000-411

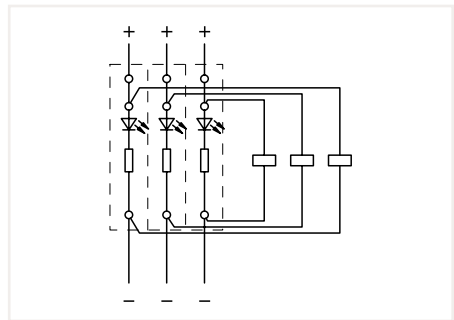

Circuit-related voltage indications can be created using the following terminal blocks:  
2002-1321/1000-434 or 2002-1321/1000-413

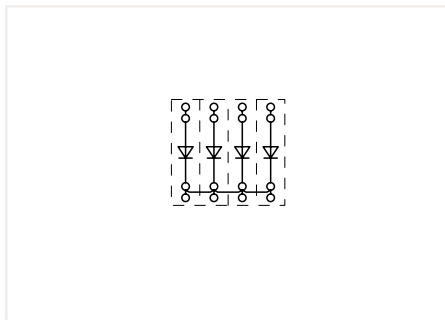

Polarized diode gates with a common cathode can be created using the following terminal blocks:  
2002-1411/1000-410 or 2002-1411/1000-411

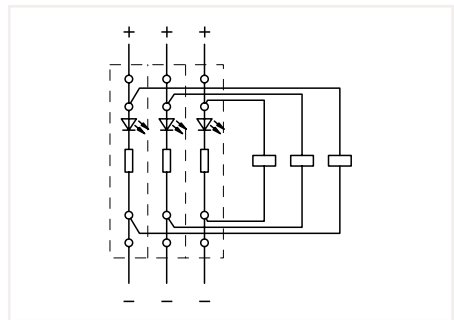



Circuit-related voltage indications can be created using the following terminal blocks:  
2002-1421/1000-434 or 2002-1421/1000-413



# Diode Terminal Block TOPJOB® S

## 4 (6) mm<sup>2</sup>; 2004 Series

Technical Data	
0.5 ... 4 (6) mm <sup>2</sup> ①	20 ... 10 AWG
U <sub>N</sub> 250 V; U <sub>RM</sub> 1000 V	
1N5408 - 1.5 A continuous current	
Terminal block width: 6.2 mm / 0.244 inch	
 11 ... 13 mm / 0.43 ... 0.51 inch	

Technical Data	
0.5 ... 4 (6) mm <sup>2</sup> ①	20 ... 10 AWG
U <sub>N</sub> 250 V; U <sub>RM</sub> 1000 V	
1N5408 - 1.5 A continuous current	
Terminal block width: 6.2 mm / 0.244 inch	
 11 ... 13 mm / 0.43 ... 0.51 inch	

Technical Data	
0.5 ... 4 (6) mm <sup>2</sup> ①	20 ... 10 AWG
U <sub>N</sub> 250 V; U <sub>RM</sub> 1000 V	
1N5408 - 1.5 A continuous current	
Terminal block width: 6.2 mm / 0.244 inch	
 11 ... 13 mm / 0.43 ... 0.51 inch	

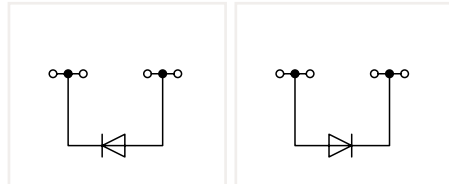
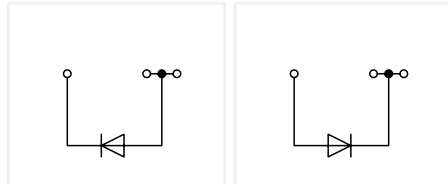
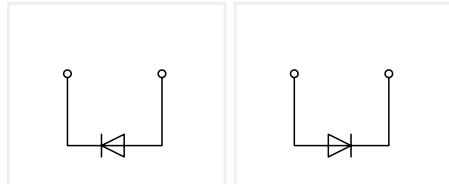
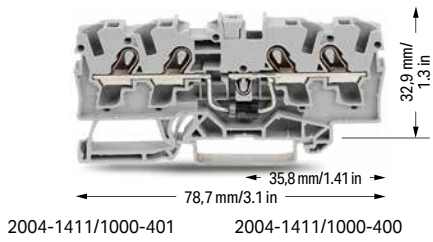
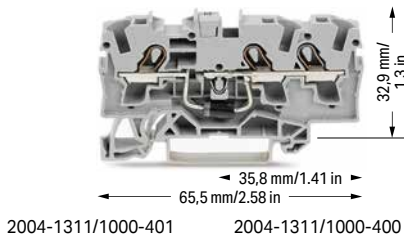
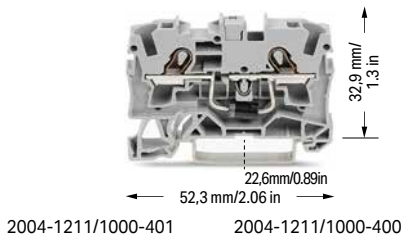

2-conductor diode terminal block; with 1N5408 diode		
Color	Item No.	Pack. Unit
○ gray	2004-1211/1000-401	50
○ gray	2004-1211/1000-400	50

3-conductor diode terminal block; with 1N5408 diode		
Color	Item No.	Pack. Unit
○ gray	2004-1311/1000-401	50
○ gray	2004-1311/1000-400	50

4-conductor diode terminal block; with 1N5408 diode		
Color	Item No.	Pack. Unit
○ gray	2004-1411/1000-401	50
○ gray	2004-1411/1000-400	50

Other terminal blocks with the same profile:		
Through	2004-1201	Page 42

Other terminal blocks with the same profile:		
Through	2004-1301	Page 42

Other terminal blocks with the same profile:		
Through	2004-1401	Page 42

# Diode Terminal Blocks TOPJOB® S

## Circuit Configuration Examples

① Conductor range: 0.5 ... 6 mm<sup>2</sup> "s+f-st";  
 Push-in termination: 1.5 ... 6 mm<sup>2</sup> "s" and 1.5 ... 4 mm<sup>2</sup> "insulated ferrules; 12 mm"  
 Depending on the conductor characteristic, a conductor with a smaller cross section can also be inserted via push-in termination.

Approvals and corresponding ratings, visit [www.wago.com](http://www.wago.com)

**Accessories; 2004 Series**  
 Appropriate marking systems:  
 WMB/WMB Inline/Marking strips

**Insulation stop; 5 pcs/strip; 0.25 ... 0.5 mm<sup>2</sup>**

light gray	2004-171	200 (25)
------------	----------	----------

**Insulation stop; 5 pcs/strip; 0.75 ... 1 mm<sup>2</sup>**

dark gray	2004-172	200 (25)
-----------	----------	----------

**Push-in type jumper bar; insulated; I<sub>N</sub> 32 A; light gray**

2-way	2004-402	25
3-way	2004-403	25
4-way	2004-404	25
5-way	2004-405	25
6-way	2004-406	25
7-way	2004-407	25
8-way	2004-408	25
9-way	2004-409	25
10-way	2004-410	25

**Push-in type jumper bar; insulated; I<sub>N</sub> 32 A; light gray**

1 to 3	2004-433	25
1 to 4	2004-434	25
1 to 5	2004-435	25
1 to 6	2004-436	25
1 to 7	2004-437	25
1 to 8	2004-438	25
1 to 9	2004-439	25
1 to 10	2004-440	25

**Wire commoning chain; 50 connections; insulated; I<sub>N</sub> 8 A**

black	210-103	5
-------	---------	---

**Wire commoning chain; 50 connections; insulated; I<sub>N</sub> 8 A**

blue	210-123	5
------	---------	---

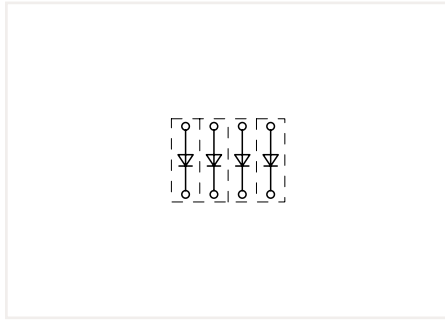

Open diode gates can be created using the following terminal blocks:  
 2004-1211/1000-400 or 2004-1211/1000-401



These diode terminal blocks have been specially developed for custom diode circuits, such as lamp test and collective fault signal circuits.

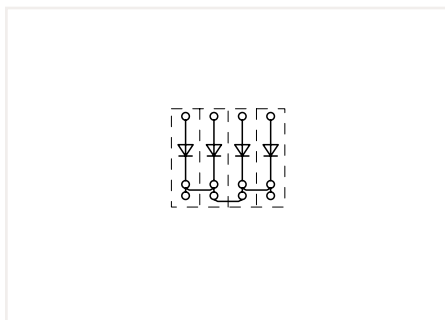

Polarized diode gates with a common cathode can be created using the following terminal blocks:  
 2004-1311/1000-400 or 2004-1311/1000-401

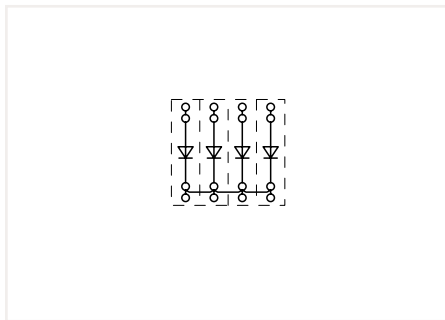

Polarized diode gates with a common cathode can be created using the following terminal blocks:  
 2004-1411/1000-400 or 2004-1411/1000-401

# Pluggable Diode Module TOPJOB® S on Carrier Terminal Block 2.5 (4) mm<sup>2</sup> 2002 Series

### Technical Data

$U_N$  250 V;  $U_{RM}$  1000 V

$I_N$  0.5 A

Plug width: 5.2 mm / 0.205 inch



2002-800/1000-411

2002-800/1000-410

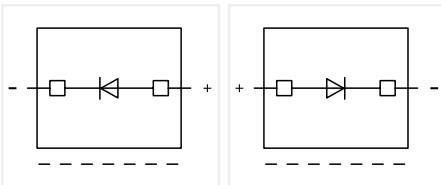

Diode module; with 1N4007 diode; max. operating temperature: 85°C; 5.2 mm wide

Color	Item No.	Pack. Unit
○ gray	2002-800/1000-411	100
○ gray	2002-800/1000-410	100

### Accessories for Carrier Terminal Blocks

Appropriate marking systems:  
WMB/Marking strips

2-conductor carrier terminal block;  
0.25 ... 2.5 (4) mm<sup>2</sup> / 22 ... 12 AWG  
Terminal block width: 5.2 mm / 0.205 inch

gray	2002-1661	50
------	-----------	----

### End and intermediate plate; 1 mm thick

orange	2002-1692	100 (25)
gray	2002-1691	100 (25)

3-conductor carrier terminal block;  
0.25 ... 2.5 (4) mm<sup>2</sup> / 22 ... 12 AWG  
Terminal block width: 5.2 mm / 0.205 inch

gray	2002-1761	50
------	-----------	----

### End and intermediate plate; 1 mm thick

orange	2002-1792	100 (25)
gray	2002-1791	100 (25)

4-conductor carrier terminal block;  
0.25 ... 2.5 (4) mm<sup>2</sup> / 22 ... 12 AWG  
Terminal block width: 5.2 mm / 0.205 inch

gray	2002-1861	50
------	-----------	----

### End and intermediate plate; 1 mm thick

orange	2002-1892	100 (25)
gray	2002-1891	100 (25)

Please observe the application notes:  
Jumpers, from page 160  
Marking, from page 246

Approvals and corresponding ratings,  
visit [www.wago.com](http://www.wago.com)

### Accessories for Carrier Terminal Blocks

Appropriate marking systems:  
WMB/Marking strips

2-conductor carrier terminal block;  
0.25 ... 2.5 (4) mm<sup>2</sup> / 22 ... 12 AWG  
Terminal block width: 5.2 mm / 0.205 inch

gray	2002-1961	50
------	-----------	----



### End and intermediate plate; 1 mm thick

orange	2002-1992	100 (25)
gray	2002-1991	100 (25)



Push-in type wire jumper; insulated; 1.5 mm<sup>2</sup> conductor  
cross-section;  $I_N$  18 A



L = 60 mm	2009-412	100 (10)
L = 110 mm	2009-414	100 (10)
L = 250 mm	2009-416	100 (10)

Push-in type jumper bar; insulated;  $I_N$  25 A; light gray



2-way	2002-402	25
3-way	2002-403	25
4-way	2002-404	25
5-way	2002-405	25
6-way	2002-406	25
7-way	2002-407	25
8-way	2002-408	25
9-way	2002-409	25
10-way	2002-410	25

Push-in type jumper bar; insulated;  $I_N$  25 A; light gray



1 to 3	2002-433	25
1 to 4	2002-434	25
1 to 5	2002-435	25
1 to 6	2002-436	25
1 to 7	2002-437	25
1 to 8	2002-438	25
1 to 9	2002-439	25
1 to 10	2002-440	25

Staggered jumper; insulated;  $I_N$  25 A; light gray



2-way	2002-472	25
3-way	2002-473	25
4-way	2002-474	25
5-way	2002-475	25
6-way	2002-476	25
7-way	2002-477	25
8-way	2002-478	25
9-way	2002-479	25
10-way	2002-480	25
11-way	2002-481	25
12-way	2002-482	25

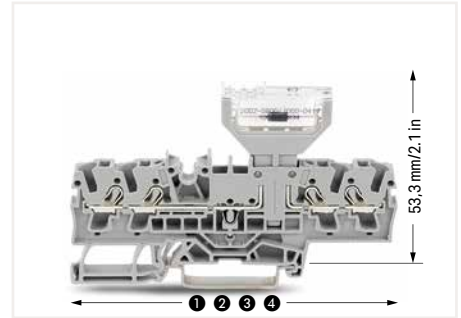

Lengths of carrier terminal blocks with a pluggable diode module:

- ① 66.1 mm / 2.62 inch for 2002-1661
- ② 76.8 mm / 3.02 inch for 2002-1761
- ③ 87.5 mm / 3.45 inch for 2002-1861
- ④ 72.9 mm / 2.87 inch for 2002-1961

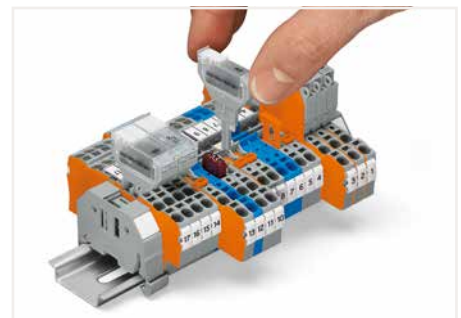

These diode modules are ideal for custom diode circuits (e.g., lamp test and collective fault signal circuits) and offer the following advantages:

- Separation into functional and wiring levels
- Polarized switching direction
- Quick and easy module replacement
- Terminal blocks/modules provide high-density wiring in a width of just 5.2 mm

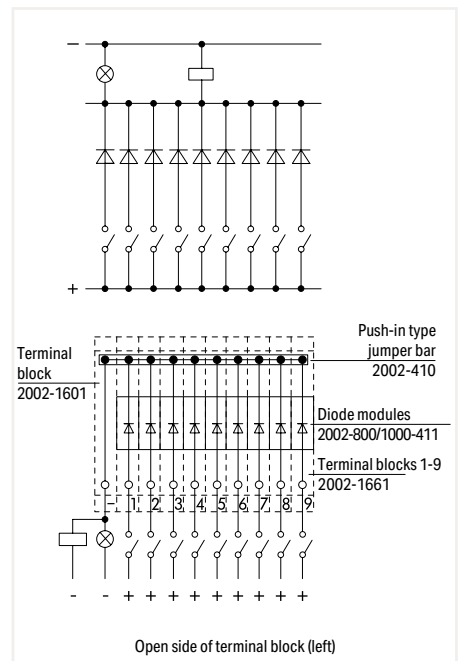

Diode module (2002-800/1000-411)  
Diode gate for collective fault indication

# Pluggable Diode Module, Empty Component Plug Housing TOPJOB® S on Through Terminal Block 2.5 (4) mm<sup>2</sup> 2002 Series

**Technical Data**

U<sub>N</sub> 250 V; U<sub>RM</sub> 1000 V

I<sub>N</sub> 0.5 A

Plug width: 10.4 mm / 0.409 inch



2002-880/1000-411

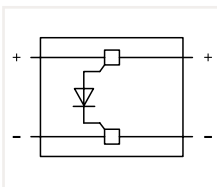

Diode module; with 1N4007 recovery diode; max. operating temperature: 85°C; 10.4 mm wide

Color	Item No.	Pack. Unit
○ gray	2002-880/1000-411	50

Empty component plug housing; type 4; 10.4 mm wide

○ gray	2002-880	50
--------	----------	----

**Accessories for Through Terminal Blocks**

Appropriate marking systems:  
WMB/Marking strips

2-conductor through terminal block;  
0.25 ... 2.5 (4) mm<sup>2</sup> / 22 ... 12 AWG  
Terminal block width: 5.2 mm / 0.205 inch

gray	2002-1201	100
------	-----------	-----

End and intermediate plate; 0.8 mm thick

orange	2002-1292	100 (25)
gray	2002-1291	100 (25)

3-conductor through terminal block;  
0.25 ... 2.5 (4) mm<sup>2</sup> / 22 ... 12 AWG  
Terminal block width: 5.2 mm / 0.205 inch

gray	2002-1301	100
------	-----------	-----

End and intermediate plate; 0.8 mm thick

orange	2002-1392	100 (25)
gray	2002-1391	100 (25)

4-conductor through terminal block;  
0.25 ... 2.5 (4) mm<sup>2</sup> / 22 ... 12 AWG  
Terminal block width: 5.2 mm / 0.205 inch

gray	2002-1401	100
------	-----------	-----

End and intermediate plate; 0.8 mm thick

orange	2002-1492	100 (25)
gray	2002-1491	100 (25)

Please observe the application notes:  
Jumpers, from page 160  
Marking, from page 246

Approvals and corresponding ratings,  
visit [www.wago.com](http://www.wago.com)

**Accessories for Through Terminal Blocks**

Appropriate marking systems:  
WMB/Marking strips

Insulation stop; 5 pcs/strip; 0.25 ... 0.5 mm<sup>2</sup>

light gray	2002-171	200 (25)
------------	----------	----------

Insulation stop; 5 pcs/strip; 0.75 ... 1 mm<sup>2</sup>

dark gray	2002-172	200 (25)
-----------	----------	----------

Protective warning marker; with black high-voltage symbol; for 5 terminal blocks

yellow	2002-115	100 (25)
--------	----------	----------

Push-in type wire jumper; insulated; 1.5 mm<sup>2</sup> conductor cross-section; I<sub>N</sub> 18 A

L = 60 mm	2009-412	100 (10)
L = 110 mm	2009-414	100 (10)
L = 250 mm	2009-416	100 (10)

Push-in type jumper bar; insulated; I<sub>N</sub> 25 A; light gray

2-way	2002-402	25
3-way	2002-403	25
4-way	2002-404	25
5-way	2002-405	25
6-way	2002-406	25
7-way	2002-407	25
8-way	2002-408	25
9-way	2002-409	25
10-way	2002-410	25

Push-in type jumper bar; insulated; I<sub>N</sub> 25 A; light gray

1 to 3	2002-433	25
1 to 4	2002-434	25
1 to 5	2002-435	25
1 to 6	2002-436	25
1 to 7	2002-437	25
1 to 8	2002-438	25
1 to 9	2002-439	25
1 to 10	2002-440	25

Staggered jumper; insulated; I<sub>N</sub> 25 A; light gray

2-way	2002-472	25
3-way	2002-473	25
4-way	2002-474	25
5-way	2002-475	25
6-way	2002-476	25
7-way	2002-477	25
8-way	2002-478	25
9-way	2002-479	25
10-way	2002-480	25
11-way	2002-481	25
12-way	2002-482	25

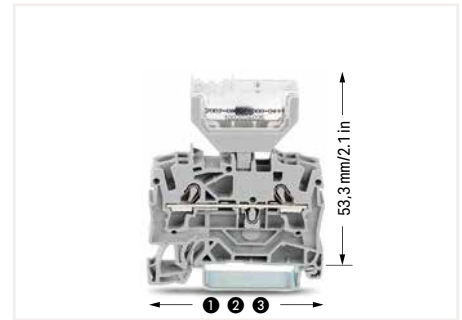

Lengths of through terminal blocks with a pluggable diode module:

- ① 48.5 mm / 1.91 inch for 2002-1201
- ② 59.2 mm / 2.33 inch for 2002-1301
- ③ 69.9 mm / 2.75 inch for 2002-1401

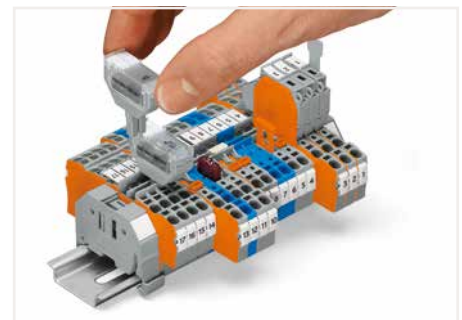

Similar to push-in type jumpers, these diode modules are simply pushed into the current bar's contact slots of two adjacent through terminal blocks, providing the following advantages:

- Compatible with all 2001 to 2006 Series Through Terminal Blocks equipped with jumper slots (note the module's width)
- Easy retrofits for existing systems
- Separation into functional and wiring levels
- Fast replacement of other functional units
- solder-free assembly of diodes, resistors, etc.



Opening the cover via operating tool (2.5 mm blade).

# Pluggable LED Module TOPJOB® S on Carrier Terminal Block 2.5 (4) mm<sup>2</sup> 2002 Series

### Technical Data

$U_N$  250 V;  $U_{RM}$  1000 V

$I_N \leq 3$  mA

Plug width: 5.2 mm / 0.205 inch

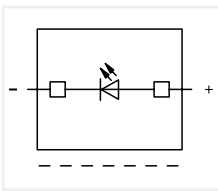

LED module; with red LED; max. operating temperature: 85°C; 5.2 mm wide

	Item No.	Pack. Unit
○ 12 ... 30 V	2002-800/1000-541	100
○ 30 ... 65 V	2002-800/1000-542	100
○ 230 V	2002-800/1000-836	100

### Accessories for Carrier Terminal Blocks

Appropriate marking systems:  
WMB/Marking strips

2-conductor carrier terminal block;

0.25 ... 2.5 (4) mm<sup>2</sup> / 22 ... 12 AWG

Terminal block width: 5.2 mm / 0.205 inch

gray	2002-1661	50
------	-----------	----

End and intermediate plate; 1 mm thick

orange	2002-1692	100 (25)
gray	2002-1691	100 (25)

3-conductor carrier terminal block;

0.25 ... 2.5 (4) mm<sup>2</sup> / 22 ... 12 AWG

Terminal block width: 5.2 mm / 0.205 inch

gray	2002-1761	50
------	-----------	----

End and intermediate plate; 1 mm thick

orange	2002-1792	100 (25)
gray	2002-1791	100 (25)

4-conductor carrier terminal block;

0.25 ... 2.5 (4) mm<sup>2</sup> / 22 ... 12 AWG

Terminal block width: 5.2 mm / 0.205 inch

gray	2002-1861	50
------	-----------	----

End and intermediate plate; 1 mm thick

orange	2002-1892	100 (25)
gray	2002-1891	100 (25)

Please observe the application notes:

Jumpers, from page 160

Marking, from page 246

Approvals and corresponding ratings, visit [www.wago.com](http://www.wago.com)

### Accessories for Carrier Terminal Blocks

Appropriate marking systems:  
WMB/Marking strips

2-conductor carrier terminal block;

0.25 ... 2.5 (4) mm<sup>2</sup> / 22 ... 12 AWG

Terminal block width: 5.2 mm / 0.205 inch

gray	2002-1961	50
------	-----------	----

End and intermediate plate; 1 mm thick

orange	2002-1992	100 (25)
gray	2002-1991	100 (25)

Push-in type wire jumper; insulated; 1.5 mm<sup>2</sup> conductor cross-section;  $I_N$  18 A

L = 60 mm	2009-412	100 (10)
L = 110 mm	2009-414	100 (10)
L = 250 mm	2009-416	100 (10)

Push-in type jumper bar; insulated;  $I_N$  25 A; light gray

2-way	2002-402	25
3-way	2002-403	25
4-way	2002-404	25
5-way	2002-405	25
6-way	2002-406	25
7-way	2002-407	25
8-way	2002-408	25
9-way	2002-409	25
10-way	2002-410	25

Push-in type jumper bar; insulated;  $I_N$  25 A; light gray

1 to 3	2002-433	25
1 to 4	2002-434	25
1 to 5	2002-435	25
1 to 6	2002-436	25
1 to 7	2002-437	25
1 to 8	2002-438	25
1 to 9	2002-439	25
1 to 10	2002-440	25

Staggered jumper; insulated;  $I_N$  25 A; light gray

2-way	2002-472	25
3-way	2002-473	25
4-way	2002-474	25
5-way	2002-475	25
6-way	2002-476	25
7-way	2002-477	25
8-way	2002-478	25
9-way	2002-479	25
10-way	2002-480	25
11-way	2002-481	25
12-way	2002-482	25



Lengths of carrier terminal blocks with a pluggable LED module:

- ① 66.1 mm / 2.62 inch for 2002-1661
- ② 76.8 mm / 3.02 inch for 2002-1761
- ③ 87.5 mm / 3.45 inch for 2002-1861
- ④ 72.9 mm / 2.87 inch for 2002-1961



The monitoring of control and operating current circuits with LED modules on rail-mount terminal blocks provides several advantages:

- No additional cost for assembly and wiring
- Separation into functional and wiring levels
- Modules can be replaced quickly by other types of modules
- Polarized switching direction
- Terminal blocks/modules provide high-density wiring in a width of just 5.2 mm

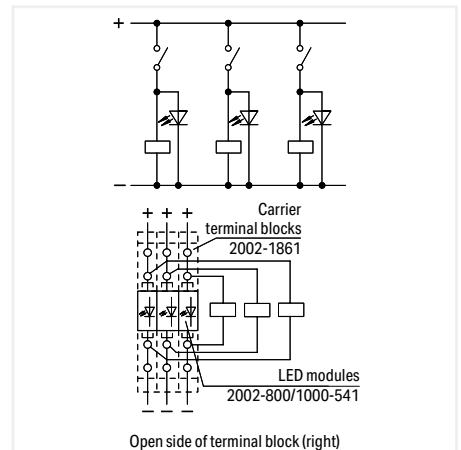

LED module (2002-800/1000-541)  
Voltage control assigned to current circuits



# Pluggable LED Module TOPJOB® S on Through Terminal Block 2.5 (4) mm<sup>2</sup> 2002 Series

**Technical Data**

$I_N \leq 3 \text{ mA}$

Plug width: 10.4 mm / 0.409 inch



Please observe the application notes:  
Marking, from page 246

Approvals and corresponding ratings,  
visit [www.wago.com](http://www.wago.com)



Dimensions of through terminal blocks with a pluggable LED module:

- ① 48.5 mm / 1.91 inch for 2002-1201
- ② 59.2 mm / 2.33 inch for 2002-1301
- ③ 69.9 mm / 2.75 inch for 2002-1401

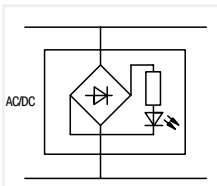

LED module; with red LED; max. operating temperature:  
85°C; 10.4 mm wide

	Item No.	Pack. Unit
○ 12 ... 30 V	2002-880/1000-541	50
○ 30 ... 65 V	2002-880/1000-542	50
○ 230 V	2002-880/1000-836	50



Labeling via WMB Multi markers and marking strips



Testing via 2-pole test plugs.

**Accessories for Through Terminal Blocks**

Appropriate marking systems:  
WMB/Marking strips

2-conductor through terminal block;  
0.25 ... 2.5 (4) mm<sup>2</sup> / 22 ... 12 AWG  
Terminal block width: 5.2 mm / 0.205 inch

gray	2002-1201	100
------	-----------	-----



End and intermediate plate; 0.8 mm thick

orange	2002-1292	100 (25)
gray	2002-1291	100 (25)



3-conductor through terminal block;  
0.25 ... 2.5 (4) mm<sup>2</sup> / 22 ... 12 AWG  
Terminal block width: 5.2 mm / 0.205 inch

gray	2002-1301	100
------	-----------	-----



End and intermediate plate; 0.8 mm thick

orange	2002-1392	100 (25)
gray	2002-1391	100 (25)



4-conductor through terminal block;  
0.25 ... 2.5 (4) mm<sup>2</sup> / 22 ... 12 AWG  
Terminal block width: 5.2 mm / 0.205 inch

gray	2002-1401	100
------	-----------	-----



End and intermediate plate; 0.8 mm thick

orange	2002-1492	100 (25)
gray	2002-1491	100 (25)

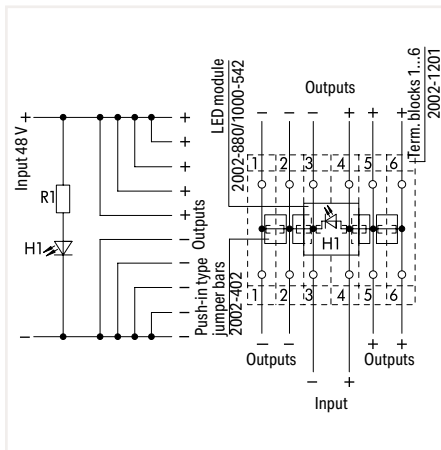

LED module (2002-880/1000-541)  
Multiple outputs with indicator lamp

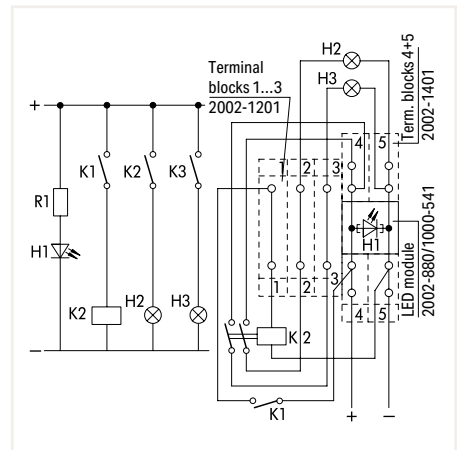

LED module (2002-880/1000-541)  
Control unit

## Empty Component Plug Housing TOPJOB® S on Carrier Terminal Block 2.5 (4) mm<sup>2</sup> 2002 Series

### Technical Data

Plug width: 5.2 mm / 0.205 inch



Empty component plug housing; type 1; 2-pole; 5.2 mm wide

Color	Item No.	Pack. Unit
○ gray	2002-800	100

### Technical Data

Plug width: 10.4 mm / 0.409 inch



Empty component plug housing; type 2; 2-pole; 10.4 mm wide

Color	Item No.	Pack. Unit
○ gray	2002-810	50

Empty component plug housing; type 3; 4-pole; 10.4 mm wide

○ gray	2002-820	50
--------	----------	----

Please observe the application notes:  
Jumpers, from page 160  
Marking, from page 246

Approvals and corresponding ratings,  
visit [www.wago.com](http://www.wago.com)

### Accessories for Carrier Terminal Blocks

Appropriate marking systems:  
WMB/WMB Inline/Marking strips

WMB marking card; white; 10 strips with 10 markers/card;  
5 ... 5.2 mm stretchable

	plain	793-5501	5
--	-------	----------	---

WMB marking card; plain; 10 strips with 10 markers/card;  
5 ... 5.2 mm stretchable

	yellow	793-5501/000-002	5
	red	793-5501/000-005	5
	blue	793-5501/000-006	5
	gray	793-5501/000-007	5
	orange	793-5501/000-012	5
	light green	793-5501/000-017	5
	green	793-5501/000-023	5
	violet	793-5501/000-024	5

### Accessories for Carrier Terminal Blocks

Appropriate marking systems: WMB/Marking strips

2-conductor carrier terminal block;  
0.25 ... 2.5 (4) mm<sup>2</sup> / 22 ... 12 AWG  
Terminal block width: 5.2 mm / 0.205 inch

	gray	2002-1661	50
--	------	-----------	----

End and intermediate plate; 1 mm thick

	orange	2002-1692	100 (25)
	gray	2002-1691	100 (25)

3-conductor carrier terminal block;  
0.25 ... 2.5 (4) mm<sup>2</sup> / 22 ... 12 AWG  
Terminal block width: 5.2 mm / 0.205 inch

	gray	2002-1761	50
--	------	-----------	----

End and intermediate plate; 1 mm thick

	orange	2002-1792	100 (25)
	gray	2002-1791	100 (25)

4-conductor carrier terminal block;  
0.25 ... 2.5 (4) mm<sup>2</sup> / 22 ... 12 AWG  
Terminal block width: 5.2 mm / 0.205 inch

	gray	2002-1861	50
--	------	-----------	----

End and intermediate plate; 1 mm thick

	orange	2002-1892	100 (25)
	gray	2002-1891	100 (25)

2-conductor carrier terminal block;  
0.25 ... 2.5 (4) mm<sup>2</sup> / 22 ... 12 AWG  
Terminal block width: 5.2 mm / 0.205 inch

	gray	2002-1961	50
--	------	-----------	----

End and intermediate plate; 1 mm thick

	orange	2002-1992	100 (25)
	gray	2002-1991	100 (25)

Protective warning marker; with black high-voltage  
symbol; for 5 terminal blocks

	yellow	2002-115	100 (25)
--	--------	----------	----------

Push-in type wire jumper; insulated; 1.5 mm<sup>2</sup> conductor  
cross-section; I<sub>N</sub> 18 A

	L = 60 mm	2009-412	100 (10)
	L = 110 mm	2009-414	100 (10)
	L = 250 mm	2009-416	100 (10)

Push-in type jumper bar; insulated; I<sub>N</sub> 25 A; light gray

	2-way	2002-402	25
	3-way	2002-403	25
	4-way	2002-404	25
	5-way	2002-405	25
	6-way	2002-406	25
	7-way	2002-407	25
	8-way	2002-408	25
	9-way	2002-409	25
	10-way	2002-410	25

Push-in type jumper bar; insulated; I<sub>N</sub> 25 A; light gray

	1 to 3	2002-433	25
	1 to 4	2002-434	25
	1 to 5	2002-435	25
	1 to 6	2002-436	25
	1 to 7	2002-437	25
	1 to 8	2002-438	25
	1 to 9	2002-439	25
	1 to 10	2002-440	25

Staggered jumper; insulated; I<sub>N</sub> 25 A; light gray

	2-way	2002-472	25
	3-way	2002-473	25
	4-way	2002-474	25
	5-way	2002-475	25
	6-way	2002-476	25
	7-way	2002-477	25
	8-way	2002-478	25
	9-way	2002-479	25
	10-way	2002-480	25
	11-way	2002-481	25
	12-way	2002-482	25

Multi-purpose operating tool; for component plugs

		2002-116	5
--	--	----------	---

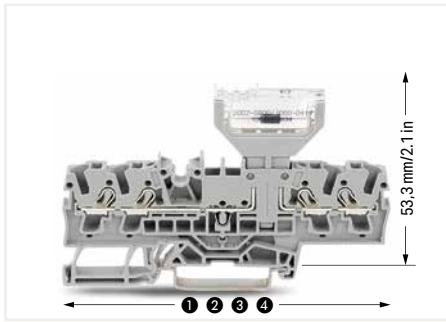

Lengths of carrier terminal blocks with a pluggable diode module:

- ❶ 66.1 mm / 2.62 inch for 2002-1661
- ❷ 76.8 mm / 3.02 inch for 2002-1761
- ❸ 87.5 mm / 3.45 inch for 2002-1861
- ❹ 72.9 mm / 2.87 inch for 2002-1961



Cutting component to the proper length.



Pressing component into plug contact via operating tool.

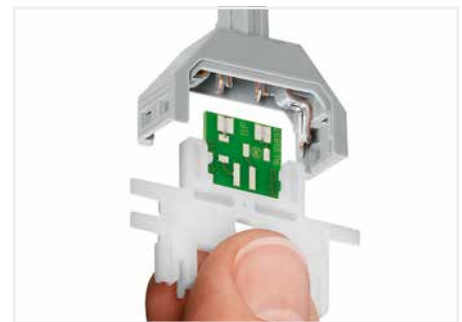

Pushing PCB into plug contact via operating tool.

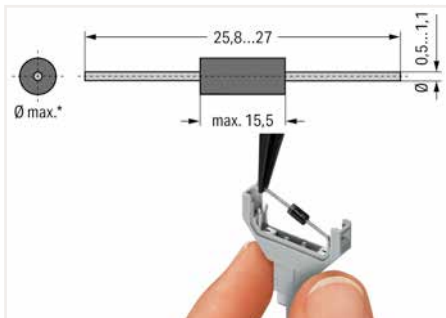

\*max. 3.4 mm Ø at 5.2 mm module width and  
 \*max. 5.4 mm Ø at 10.4 mm module width  
**Notice: Reconnection only possible with similar or larger wire diameter.**



Component plugs for building custom circuits solder-free assembly of diodes, resistors, etc. (Illustration shows a 1N4007 diode)

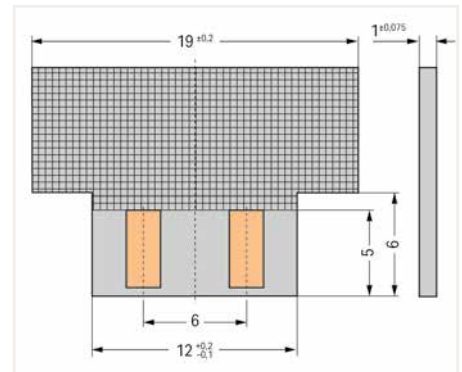

Dimensions of self-assembled PCBs:  
 Module height: 2 mm at 5.2 mm module width and module height: 3.3 mm at 10.4 mm module width



When closing the cover, please insert cover as shown in the illustration.



Opening the cover via operating tool (2.5 mm blade).



Opening the cover via multi-purpose operating tool for component plugs.

## Component Plug TOPJOB® S on Carrier Terminal Blocks 2.5 (4) mm<sup>2</sup> 2042 Series



Component plug; 4-pole; transparent housing; with fiber optics; 10.3 mm wide

Item No.	Pack. Unit
2042-321	5



Component plug; 6-pole; transparent housing; with fiber optics; 15.5 mm wide

Item No.	Pack. Unit
2042-331	5

Component plug; 8-pole; transparent housing; with fiber optics; 20.7 mm wide

Item No.	Pack. Unit
2042-341	5

Component plug; 10-pole; transparent housing; with fiber optics; 25.9 mm wide

Item No.	Pack. Unit
2042-351	5

### Accessories for Carrier Terminal Blocks

Appropriate marking systems: WMB/Marking strips

2-conductor carrier terminal block;  
0.25 ... 2.5 (4) mm<sup>2</sup> / 22 ... 12 AWG  
Terminal block width: 5.2 mm / 0.205 inch

Color	Item No.	Pack. Unit
gray	2002-1661	50

End and intermediate plate; 1 mm thick

Color	Item No.	Pack. Unit
orange	2002-1692	100 (25)
gray	2002-1691	100 (25)

3-conductor carrier terminal block;  
0.25 ... 2.5 (4) mm<sup>2</sup> / 22 ... 12 AWG  
Terminal block width: 5.2 mm / 0.205 inch

Color	Item No.	Pack. Unit
gray	2002-1761	50

End and intermediate plate; 1 mm thick

Color	Item No.	Pack. Unit
orange	2002-1792	100 (25)
gray	2002-1791	100 (25)

4-conductor carrier terminal block;  
0.25 ... 2.5 (4) mm<sup>2</sup> / 22 ... 12 AWG  
Terminal block width: 5.2 mm / 0.205 inch

Color	Item No.	Pack. Unit
gray	2002-1861	50

End and intermediate plate; 1 mm thick

Color	Item No.	Pack. Unit
orange	2002-1892	100 (25)
gray	2002-1891	100 (25)

2-conductor carrier terminal block;  
0.25 ... 2.5 (4) mm<sup>2</sup> / 22 ... 12 AWG  
Terminal block width: 5.2 mm / 0.205 inch

Color	Item No.	Pack. Unit
gray	2002-1961	50

End and intermediate plate; 1 mm thick

Color	Item No.	Pack. Unit
orange	2002-1992	100 (25)
gray	2002-1991	100 (25)

Protective warning marker; with black high-voltage symbol; for 5 terminal blocks

Color	Item No.	Pack. Unit
yellow	2002-115	100 (25)

Push-in type wire jumper; insulated; 1.5 mm<sup>2</sup> conductor cross-section; I<sub>N</sub> 18 A

Length (L)	Item No.	Pack. Unit
L = 60 mm	2009-412	100 (10)
L = 110 mm	2009-414	100 (10)
L = 250 mm	2009-416	100 (10)

Push-in type jumper bar; insulated; I<sub>N</sub> 25 A; light gray

Way	Item No.	Pack. Unit
2-way	2002-402	25
3-way	2002-403	25
4-way	2002-404	25
5-way	2002-405	25
6-way	2002-406	25
7-way	2002-407	25
8-way	2002-408	25
9-way	2002-409	25
10-way	2002-410	25

Push-in type jumper bar; insulated; I<sub>N</sub> 25 A; light gray

Way	Item No.	Pack. Unit
1 to 3	2002-433	25
1 to 4	2002-434	25
1 to 5	2002-435	25
1 to 6	2002-436	25
1 to 7	2002-437	25
1 to 8	2002-438	25
1 to 9	2002-439	25
1 to 10	2002-440	25

Staggered jumper; insulated; I<sub>N</sub> 25 A; light gray

Way	Item No.	Pack. Unit
2-way	2002-472	25
3-way	2002-473	25
4-way	2002-474	25
5-way	2002-475	25
6-way	2002-476	25
7-way	2002-477	25
8-way	2002-478	25
9-way	2002-479	25
10-way	2002-480	25
11-way	2002-481	25
12-way	2002-482	25

Length for 2002-1661 – 66.5 mm / 2.62 inch  
2-conductor carrier terminal block

Length for 2002-1761 – 76.8 mm / 3.02 inch  
3-conductor carrier terminal block

Length for 2002-1861 – 87.5 mm / 3.45 inch  
4-conductor carrier terminal block

Length for 2002-1961 – 72.9 mm / 2.87 inch  
2-conductor carrier terminal block; with additional jumper slot

Please observe the application notes:  
Jumpers, from page 160  
Marking, from page 246

Approvals and corresponding ratings,  
visit [www.wago.com](http://www.wago.com)

### Accessories for Carrier Terminal Blocks

Appropriate marking systems:  
WMB/WMB Inline/Marking strips

WMB marking card; white; 10 strips with 10 markers/card;  
5 ... 5.2 mm stretchable

Color	Item No.	Pack. Unit
plain	793-5501	5

WMB marking card; plain; 10 strips with 10 markers/card;  
5 ... 5.2 mm stretchable

Color	Item No.	Pack. Unit
yellow	793-5501/000-002	5
red	793-5501/000-005	5
blue	793-5501/000-006	5
gray	793-5501/000-007	5
orange	793-5501/000-012	5
light green	793-5501/000-017	5
green	793-5501/000-023	5
violet	793-5501/000-024	5

Screwless end stop; for DIN-35 rail; 6 mm wide

Color	Item No.	Pack. Unit
gray	249-116	100 (25)

Screwless end stop; for DIN-35 rail; 10 mm wide

Color	Item No.	Pack. Unit
gray	249-117	50 (25)

Sold & Serviced By:

**ELECTROMATE**

Toll Free Phone (877) SERV098  
[www.electromate.com](http://www.electromate.com)  
[sales@electromate.com](mailto:sales@electromate.com)





## Double-Deck Disconnect/Test Terminal Block TOPJOB® S 2.5 (4) mm<sup>2</sup>; 2002 Series

Technical Data	
0.25 ... 2.5 (4) mm <sup>2</sup> ①	22 ... 12 AWG
400 V/6 kV/3 ②	300 V, 15 A ③
I <sub>N</sub> 16 A	300 V, 15 A ④
Terminal block width: 5.2 mm / 0.205 inch	
 10 ... 12 mm / 0.39 ... 0.47 inch	

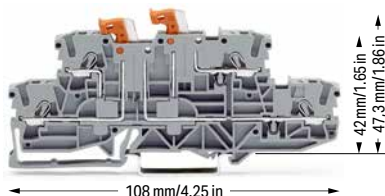

Double-deck, double-disconnect terminal block; with 2 pivoting knife disconnects; gray

	Item No.	Pack. Unit
○ L/L ⑤	2002-2951 ⑥	50
○ N/L ⑤	2002-2952 ⑥	50

Double-deck, double-disconnect terminal block; with 2 pivoting knife disconnects; blue

● N/N ⑤	2002-2954 ⑥	50
---------	-------------	----

Technical Data	
0.25 ... 2.5 (4) mm <sup>2</sup> ①	22 ... 12 AWG
400 V/6 kV/3 ②	300 V, 15 A ③
I <sub>N</sub> 16 A	300 V, 15 A ④
Terminal block width: 5.2 mm / 0.205 inch	
 10 ... 12 mm / 0.39 ... 0.47 inch	

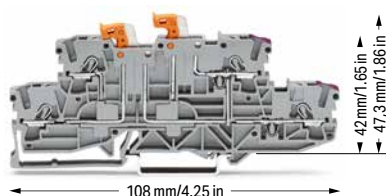

Double-deck, double-disconnect terminal block; with two pivoting knife disconnects; lower and upper decks internally commoned on right side, violet conductor entry; gray

○ L/L ⑤	2002-2958 ⑥	50
---------	-------------	----

Double-deck, double-disconnect terminal block; with two pivoting knife disconnects; lower and upper decks internally commoned on right side, violet conductor entry; blue

● N/N ⑤	2002-2959 ⑥	50
---------	-------------	----

Technical Data	
0.25 ... 2.5 (4) mm <sup>2</sup> ①	22 ... 12 AWG
400 V/6 kV/3 ②	300 V, 15 A ③
I <sub>N</sub> 16 A	300 V, 15 A ④
Terminal block width: 5.2 mm / 0.205 inch	
 10 ... 12 mm / 0.39 ... 0.47 inch	

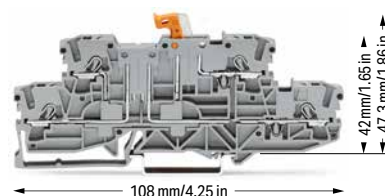

Double-deck disconnect terminal block; with pivoting knife disconnect; same profile as double-deck, double-disconnect terminal block; gray

	Item No.	Pack. Unit
○ L/L ⑤	2002-2971 ⑥	50
○ N/L ⑤	2002-2972 ⑥	50

Double-deck disconnect terminal block; with pivoting knife disconnect; same profile as double-deck, double-disconnect terminal block; blue

● N/N ⑤	2002-2974 ⑥	50
---------	-------------	----

### Accessories; 2002 Series

Appropriate marking systems: WMB/WMB Inline/Marking strips

End and intermediate plate; 1 mm thick		
orange	2002-2992	100 (25)
gray	2002-2991	100 (25)

Insulation stop; 5 pcs/strip; 0.25 ... 0.5 mm <sup>2</sup>		
light gray	2002-171	200 (25)

Insulation stop; 5 pcs/strip; 0.75 ... 1 mm <sup>2</sup>		
dark gray	2002-172	200 (25)

Protective warning marker; with black high-voltage symbol; for 5 terminal blocks		
yellow	2002-115	100 (25)

Push-in type jumper bar; insulated; I <sub>N</sub> 25 A; light gray		
2-way	2002-402	25
3-way	2002-403	25
4-way	2002-404	25
5-way	2002-405	25
6-way	2002-406	25
7-way	2002-407	25
8-way	2002-408	25
9-way	2002-409	25
10-way	2002-410	25

Push-in type wire jumper; insulated; 1.5 mm <sup>2</sup> conductor cross-section; I <sub>N</sub> 18 A		
L = 60 mm	2009-412	100 (10)
L = 110 mm	2009-414	100 (10)
L = 250 mm	2009-416	100 (10)

Push-in type jumper bar; insulated; I <sub>N</sub> 25 A; light gray		
1 to 3	2002-433	25
1 to 4	2002-434	25
1 to 5	2002-435	25
1 to 6	2002-436	25
1 to 7	2002-437	25
1 to 8	2002-438	25
1 to 9	2002-439	25
1 to 10	2002-440	25

Delta jumper; insulated; I <sub>N</sub> = I <sub>N</sub> terminal block; light gray		
1-2 3-4 5-6	2002-406/020-000	25

Star point jumper; insulated; I <sub>N</sub> = I <sub>N</sub> terminal block; light gray		
1-3-5	2002-405/011-000	25

Staggered jumper; insulated; I <sub>N</sub> 25 A; light gray		
2-way	2002-472	25
3-way	2002-473	25
4-way	2002-474	25
5-way	2002-475	25
6-way	2002-476	25
7-way	2002-477	25
8-way	2002-478	25
9-way	2002-479	25
10-way	2002-480	25
11-way	2002-481	25
12-way	2002-482	25

Adjacent jumper for continuous commoning; insulated; I <sub>N</sub> 25 A, light gray		
2-way	2002-400	25

Adjacent jumper for continuous commoning; insulated; I <sub>N</sub> 25 A; 1 to 3		
light gray	2002-423	25
red	2002-423/000-005	25
blue	2002-423/000-006	25

Adjacent jumper for continuous commoning; insulated; I <sub>N</sub> 25 A, light gray		
5-way	2002-415	25

Modular connector; snaps together; for jumper contact slot		
gray	2002-511	100 (25)

Spacer module; snaps together; bridges commoned terminal blocks		
gray	2002-549	100 (25)

End plate; for modular connector; 1.5 mm thick		
gray	2002-541	100 (25)

Test plug adapter; for 4 mm Ø test plug		
gray	2009-174	100 (25)

❶ Conductor range: 0.25 ... 4 mm<sup>2</sup> "s+f-st";  
Push-in termination: 1 ... 4 mm<sup>2</sup> "s" and 1 ... 2.5 mm<sup>2</sup>  
"insulated ferrules, 12 mm"  
Depending on the conductor characteristic, a conductor with a smaller cross section can also be inserted via push-in termination.

❷ 400 V = rated voltage  
6 kV = rated impulse voltage  
3 = pollution degree

❸ Terminal blocks with an Ex mark are suitable for Ex ec IIc applications.

Please observe the application notes:  
Jumpers, from page 160  
Testing accessories, from page 154  
Marking, from page 246

Approvals and corresponding ratings,  
visit [www.wago.com](http://www.wago.com)



Double-deck, double-disconnect terminal blocks (2002-2951) with group marker carrier (2002-160) accommodated in jumper contact slot



Double-deck, double-disconnect terminal block (2002-2951) with group marker carrier (2002-160) accommodated in jumper contact slot

#### Accessories; 2002 Series

Appropriate marking systems:  
WMB/WMB Inline/Marking strips

Banana plug; for 4 mm socket diameter; color mixed; 10 x orange, white, black, blue, yellow; max. 42 V



215-111 50

Testing tap; for max. 2.5 mm<sup>2</sup>



gray 2009-182 100 (25)

WMB Inline, plain; 1,500 WMB markers (5 mm)/reel;  
5 ... 5.2 mm stretchable



white 2009-115 1

Marking strip; plain; 11 mm wide; 50 m reel



white 2009-110 1

WMB marking card; white; 10 strips with 10 markers/card;  
5 ... 5.2 mm stretchable



plain 793-5501 5

WMB marking card; plain; 10 strips with 10 markers/card;  
5 ... 5.2 mm stretchable



yellow	793-5501/000-002	5
red	793-5501/000-005	5
blue	793-5501/000-006	5
gray	793-5501/000-007	5
orange	793-5501/000-012	5
light green	793-5501/000-017	5
green	793-5501/000-023	5
violet	793-5501/000-024	5

Group marker carrier; snap-on type for jumper slot; 5 mm wide



gray 2009-191 50 (25)

Screwless end stop; for DIN-35 rail; 6 mm wide



gray 249-116 100 (25)

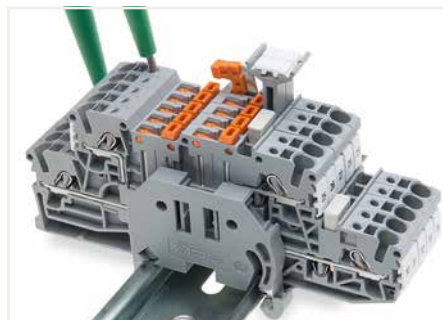

Testing with voltage tester.

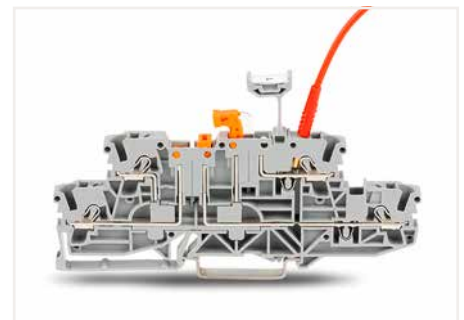

Double-deck, double-disconnect terminal block (2002-2951) with group marker carrier (2002-160) accommodated in a jumper contact slot and test plug (210-136)

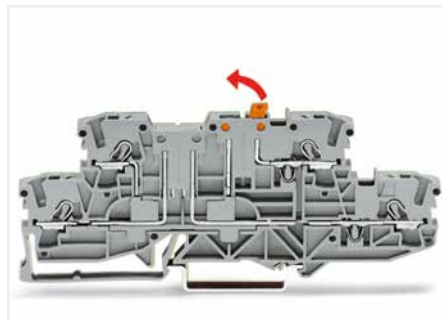



Double-deck disconnect terminal block (2002-2971)  
Opening a knife disconnect.

## Double-Deck Carrier Terminal Block TOPJOB® S

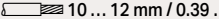
### 2.5 (4) mm<sup>2</sup>; 2002 Series

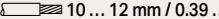
Technical Data	
0.25 ... 2.5 (4) mm <sup>2</sup> ①	22 ... 12 AWG
400 V/6 kV/3 ②	300 V, 15 A ③
I <sub>N</sub> 16 A	300 V, 15 A ④
Terminal block width: 5.2 mm / 0.205 inch	
 10 ... 12 mm / 0.39 ... 0.47 inch	

Technical Data	
0.25 ... 2.5 (4) mm <sup>2</sup> ①	22 ... 12 AWG
400 V/6 kV/3 ②	300 V, 15 A ③
I <sub>N</sub> 16 A	300 V, 15 A ④
Terminal block width: 5.2 mm / 0.205 inch	
 10 ... 12 mm / 0.39 ... 0.47 inch	

Technical Data	
0.25 ... 2.5 (4) mm <sup>2</sup> ①	22 ... 12 AWG
400 V/6 kV/3 ②	300 V, 15 A ③
I <sub>N</sub> 16 A	300 V, 15 A ④
Terminal block width: 5.2 mm / 0.205 inch	
 10 ... 12 mm / 0.39 ... 0.47 inch	

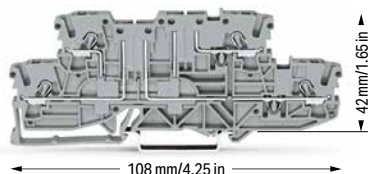

Double-deck, double-disconnect terminal block; gray		
	Bestellnr.	VPE
○ L/L	2002-2941	50

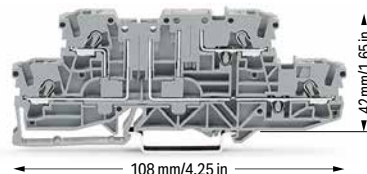

Double-deck carrier terminal block; gray		
	Bestellnr.	VPE
○ L/L	2002-2961	50

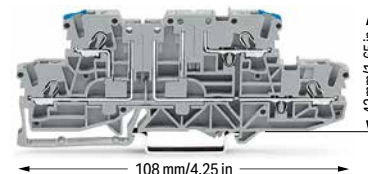



Double-deck carrier terminal block; gray		
	Bestellnr.	VPE
○ L/N	2002-2963	50

#### Accessories; 2002 Series

Appropriate marking systems: WMB/WMB Inline/Marking strips

End and intermediate plate; 1 mm thick			
	orange	2002-2992	100 (25)
	gray	2002-2991	100 (25)

Insulation stop; 5 pcs/strip; 0.25 ... 0.5 mm <sup>2</sup>			
	light gray	2002-171	200 (25)

Insulation stop; 5 pcs/strip; 0.75 ... 1 mm <sup>2</sup>			
	dark gray	2002-172	200 (25)

Protective warning marker; with black high-voltage symbol; for 5 terminal blocks			
	yellow	2002-115	100 (25)

Push-in type jumper bar; insulated; I <sub>N</sub> 25 A; light gray			
	2-way	2002-402	25
	3-way	2002-403	25
	4-way	2002-404	25
	5-way	2002-405	25
	6-way	2002-406	25
	7-way	2002-407	25
	8-way	2002-408	25
	9-way	2002-409	25
	10-way	2002-410	25

Push-in type jumper bar; insulated; I <sub>N</sub> 25 A; light gray			
	1 to 3	2002-433	25
	1 to 4	2002-434	25
	1 to 5	2002-435	25
	1 to 6	2002-436	25
	1 to 7	2002-437	25
	1 to 8	2002-438	25
	1 to 9	2002-439	25
	1 to 10	2002-440	25

Delta jumper; insulated; I <sub>N</sub> = I <sub>N</sub> terminal block; light gray			
	1-2 3-4 5-6	2002-406/020-000	25

Star point jumper; insulated; I <sub>N</sub> = I <sub>N</sub> terminal block; light gray			
	1-3-5	2002-405/011-000	25

Staggered jumper; insulated; I <sub>N</sub> 25 A; light gray			
	2-way	2002-472	25
	3-way	2002-473	25
	4-way	2002-474	25
	5-way	2002-475	25
	6-way	2002-476	25
	7-way	2002-477	25
	8-way	2002-478	25
	9-way	2002-479	25
	10-way	2002-480	25
	11-way	2002-481	25
	12-way	2002-482	25

Adjacent jumper for continuous commoning; insulated; I <sub>N</sub> 25 A, light gray			
	2-way	2002-400	25

Adjacent jumper for continuous commoning; insulated; I <sub>N</sub> 25 A; 1 to 3			
	light gray	2002-423	25
	red	2002-423/000-005	25
	blue	2002-423/000-006	25

Adjacent jumper for continuous commoning; insulated; I <sub>N</sub> 25 A, light gray			
	5-way	2002-415	25

Push-in type wire jumper; insulated; 1.5 mm <sup>2</sup> conductor cross-section; I <sub>N</sub> 18 A			
	L = 60 mm	2009-412	100 (10)
	L = 110 mm	2009-414	100 (10)
	L = 250 mm	2009-416	100 (10)

Modular connector; snaps together; for jumper contact slot			
	gray	2002-511	100 (25)

Spacer module; snaps together; bridges commoned terminal blocks			
	gray	2002-549	100 (25)

End plate; for modular connector; 1.5 mm thick			
	gray	2002-541	100 (25)

Test plug adapter; for 4 mm Ø test plug			
	gray	2009-174	100 (25)

Banana plug; for 4 mm socket diameter; color mixed; 10 x orange, white, black, blue, yellow; max. 42 V			
		215-111	50

Testing tap; for max. 2.5 mm <sup>2</sup>			
	gray	2009-182	100 (25)

Disconnect plug for carrier terminal blocks; suitable when using a carrier terminal block as disconnect terminal block			
	orange	2002-401	100 (25)

① Conductor range: 0.25 ... 4 mm<sup>2</sup> "s+f-st";  
Push-in termination: 1 ... 4 mm<sup>2</sup> "s" and 1 ... 2.5 mm<sup>2</sup>  
"insulated ferrules, 12 mm"  
Depending on the conductor characteristic, a conductor  
with a smaller cross section can also be inserted  
via push-in termination.

② 400 V = rated voltage  
6 kV = rated impulse voltage  
3 = pollution degree

Please observe the application notes:  
Jumpers, from page 160  
Testing accessories, from page 154  
Marking, from page 246

Approvals and corresponding ratings,  
visit [www.wago.com](http://www.wago.com)

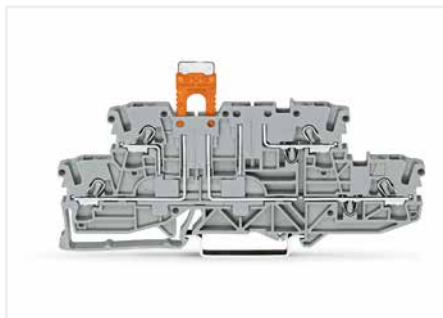

Carrier terminal block (2002-2941) with disconnect plug  
(2002-401) in parked position

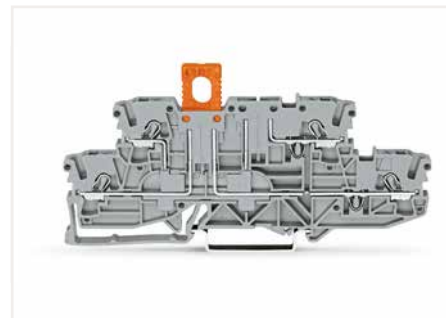

Carrier terminal block (2002-2941) with disconnect plug  
(2002-401) in operating position

#### Accessories; 2002 Series

Appropriate marking systems:  
WMB/WMB Inline/Marking strips

WMB Inline, plain; 1,500 WMB markers (5 mm)/reel;  
5 ... 5.2 mm stretchable

white 2009-115 1



Marking strip; plain; 11 mm wide; 50 m reel

white 2009-110 1



WMB marking card; white; 10 strips with 10 markers/card;  
5 ... 5.2 mm stretchable

plain 793-5501 5



WMB marking card; plain; 10 strips with 10 markers/card;  
5 ... 5.2 mm stretchable

yellow 793-5501/000-002 5

red 793-5501/000-005 5

blue 793-5501/000-006 5

gray 793-5501/000-007 5

orange 793-5501/000-012 5

light green 793-5501/000-017 5

green 793-5501/000-023 5

violet 793-5501/000-024 5



Group marker carrier; snap-on type for jumper slot; 5 mm  
wide

gray 2009-191 50 (25)



Screwless end stop; for DIN-35 rail; 6 mm wide

gray 249-116 100 (25)



Screwless end stop; for DIN-35 rail; 10 mm wide

gray 249-117 50 (25)



# Double-Deck Diode Terminal Block and LED Terminal Block TOPJOB® S

## 2.5 (4) mm<sup>2</sup>; 2002 Series

Technical Data	
0.25 ... 2.5 (4) mm <sup>2</sup> ①	22 ... 12 AWG
U <sub>N</sub> 250 V; U <sub>RM</sub> 1000 V	
1N4007 - 0.5 A continuous current	
Terminal block width: 5.2 mm / 0.205 inch	
 10 ... 12 mm / 0.39 ... 0.47 inch	

Technical Data	
0.25 ... 2.5 (4) mm <sup>2</sup> ①	22 ... 12 AWG
U <sub>N</sub> 250 V; U <sub>RM</sub> 1000 V	
1N4007 - 0.5 A continuous current	
Terminal block width: 5.2 mm / 0.205 inch	
 10 ... 12 mm / 0.39 ... 0.47 inch	

Technical Data	
0.25 ... 2.5 (4) mm <sup>2</sup> ①	22 ... 12 AWG
24 VDC	
I <sub>F</sub> 0.025 A max.	
Terminal block width: 5.2 mm / 0.205 inch	
 10 ... 12 mm / 0.39 ... 0.47 inch	

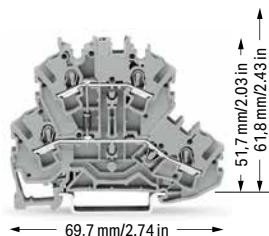

2002-2211/1000-410      2002-2211/1000-411

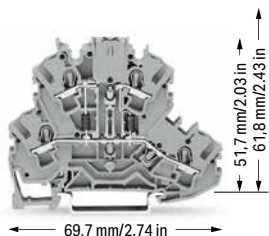

2002-2213/1000-487      2002-2213/1000-488

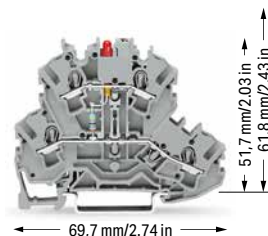

2002-2221/1000-434      2002-2221/1000-413

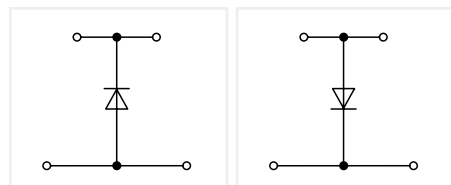

Double-deck diode terminal block; with 1N4007 diode

Color	Item No.	Pack. Unit
○ gray	2002-2211/1000-410	50
○ gray	2002-2211/1000-411	50

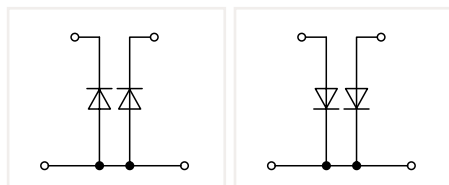

Double-deck diode terminal block; with two 1N4007 diodes

Color	Item No.	Pack. Unit
○ gray	2002-2213/1000-487	50
○ gray	2002-2213/1000-488	50

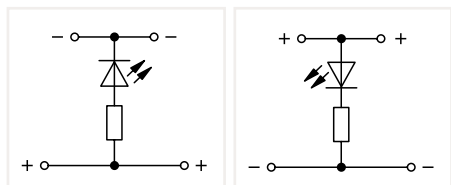

Double-deck LED terminal block; with red LED

Color	Item No.	Pack. Unit
○ gray	2002-2221/1000-434	50
○ gray	2002-2221/1000-413	50

Other terminal blocks with the same profile:

Through	2002-2201	Page 54
---------	-----------	---------

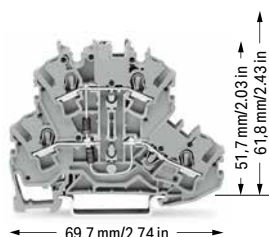

2002-2214/1000-492      2002-2214/1000-491

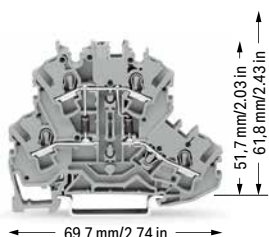

2002-2214/1000-489      2002-2214/1000-490

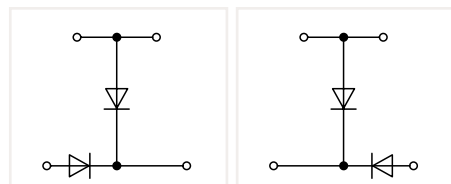

Double-deck diode terminal block; with two 1N4007 diodes

Color	Item No.	Pack. Unit
○ gray	2002-2214/1000-492	50
○ gray	2002-2214/1000-491	50

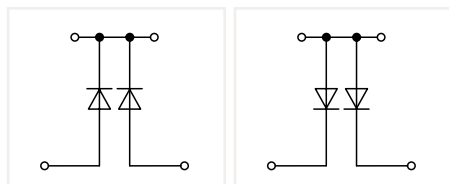

Double-deck diode terminal block; with two 1N4007 diodes

Color	Item No.	Pack. Unit
○ gray	2002-2214/1000-489	50
○ gray	2002-2214/1000-490	50



# Double-Deck Diode Terminal Blocks and LED Terminal Blocks TOPJOB® S Circuit Configuration Examples

❶ Conductor range: 0.25 ... 4 mm<sup>2</sup> "s+f-st";  
Push-in termination: 1 ... 4 mm<sup>2</sup> "s" and 1 ... 2.5 mm<sup>2</sup>  
"insulated ferrules, 12 mm"  
Depending on the conductor characteristic, a conductor with a smaller cross section can also be inserted via push-in termination.

Approvals and corresponding ratings, visit [www.wago.com](http://www.wago.com)

**Accessories; 2002 Series**  
Appropriate marking systems:  
WMB/WMB Inline/Marking strips

**End and intermediate plate; 0.8 mm thick**

	orange	2002-2292	100 (25)
	gray	2002-2291	100 (25)

**Double-deck marker carrier; pivoting**

	gray	2002-121	50 (25)
---	------	----------	---------

**Insulation stop; 5 pcs/strip; 0.25 ... 0.5 mm<sup>2</sup>**

	light gray	2002-171	200 (25)
---	------------	----------	----------

**Insulation stop; 5 pcs/strip; 0.75 ... 1 mm<sup>2</sup>**

	dark gray	2002-172	200 (25)
---	-----------	----------	----------

**Push-in type jumper bar; insulated; I<sub>n</sub> 25 A; light gray**

	2-way	2002-402	25
	3-way	2002-403	25
	4-way	2002-404	25
	5-way	2002-405	25
	6-way	2002-406	25
	7-way	2002-407	25
	8-way	2002-408	25
	9-way	2002-409	25
	10-way	2002-410	25

**Push-in type jumper bar; insulated; I<sub>n</sub> 25 A; light gray**

	1 to 3	2002-433	25
	1 to 4	2002-434	25
	1 to 5	2002-435	25
	1 to 6	2002-436	25
	1 to 7	2002-437	25
	1 to 8	2002-438	25
	1 to 9	2002-439	25
	1 to 10	2002-440	25

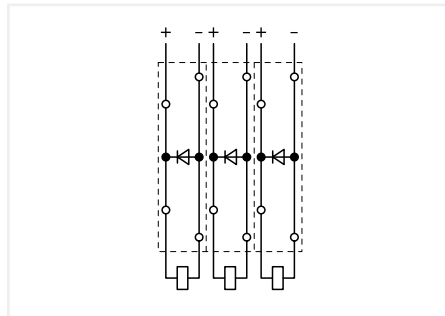

Open diode gates can be created using the following terminal blocks:  
2002-2211/1000-410 or 2002-2211/1000-411

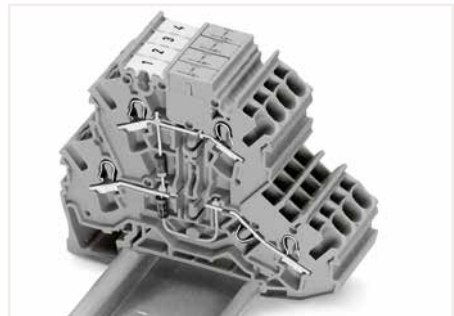

Double-deck diode terminal blocks were specifically developed for custom diode circuits, such as lamp test and collective fault signal circuits. These terminal blocks provide high-density wiring in a width of just 5.2 mm. Push-in type jumper bars provide additional options for custom circuit design.

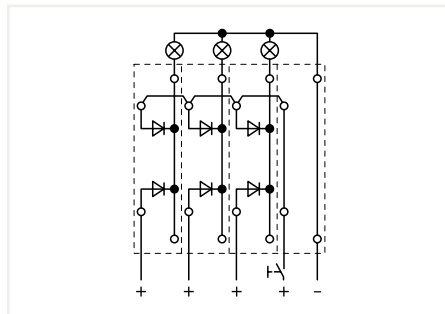

Polarized diode gates with a common cathode can be created using the following terminal blocks:  
2002-2213/1000-487 or 2002-2213/1000-488

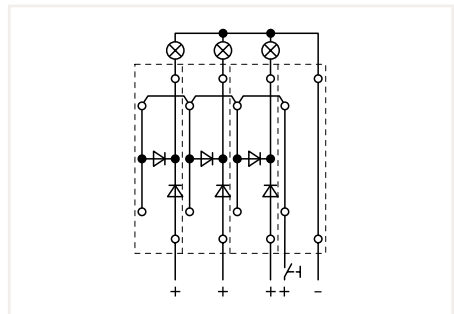

Lamp test circuits can be created using the following terminal blocks:  
2002-2214/1000-492 or 2002-2214/1000-491

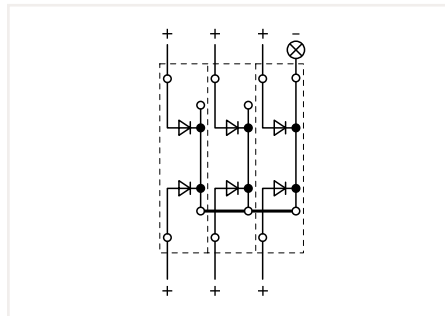

Polarized diode gates with a common cathode can be created using the following terminal blocks:  
2002-2214/1000-489 or 2002-2214/1000-490

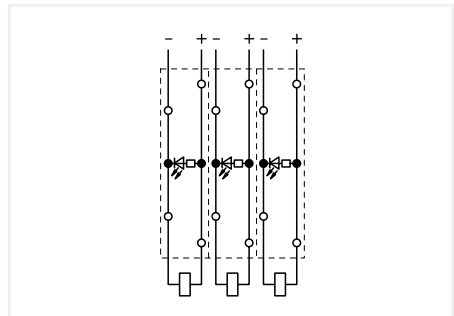

Circuit-related voltage indications can be created using the following terminal blocks:  
2002-2221/1000-434 or 2002-2221/1000-413

# Triple-Deck Diode Terminal Block, Triple-Deck LED Terminal Block TOPJOB® S

## 2.5 (4) mm<sup>2</sup>; 2002 Series

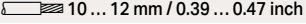
Technical Data	
0.25 ... 2.5 (4) mm <sup>2</sup> ①	22 ... 12 AWG
U <sub>N</sub> 250 V; U <sub>RM</sub> 1000 V	
1N4007 - 0.5 A continuous current	
Terminal block width: 5.2 mm / 0.205 inch	
 10 ... 12 mm / 0.39 ... 0.47 inch	

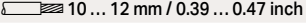
Technical Data	
0.25 ... 2.5 (4) mm <sup>2</sup> ①	22 ... 12 AWG
U <sub>N</sub> 250 V; U <sub>RM</sub> 1000 V	
1N4007 - 0.5 A continuous current	
Terminal block width: 5.2 mm / 0.205 inch	
 10 ... 12 mm / 0.39 ... 0.47 inch	

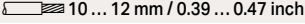
Technical Data	
0.25 ... 2.5 (4) mm <sup>2</sup> ①	22 ... 12 AWG
24 VDC	
I <sub>F</sub> 0.025 A max.	
Terminal block width: 5.2 mm / 0.205 inch	
 10 ... 12 mm / 0.39 ... 0.47 inch	

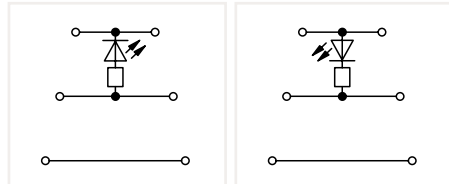
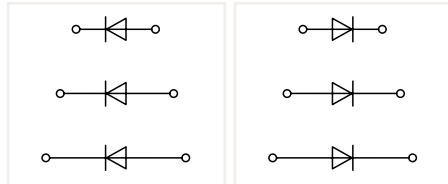
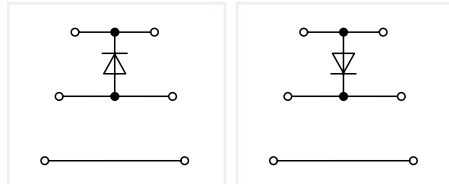
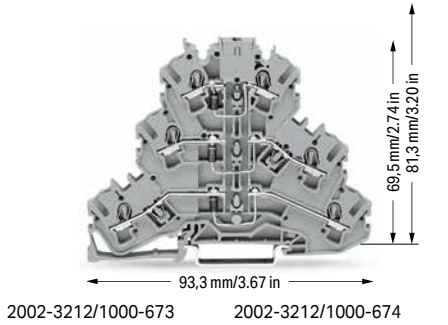
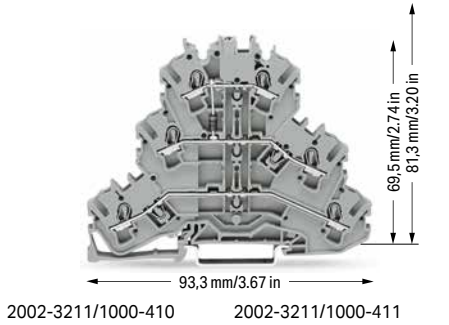

Triple-deck diode terminal block, with 1N4007 diode		
Color	Item No.	Pack. Unit
○ gray	2002-3211/1000-410	50
○ gray	2002-3211/1000-411	50

Triple-deck diode terminal block; with three 1N4007 diodes		
Color	Item No.	Pack. Unit
○ gray	2002-3212/1000-673	50
○ gray	2002-3212/1000-674	50

Triple-deck LED terminal block; with red LED		
Color	Item No.	Pack. Unit
○ gray	2002-3221/1000-434	50
○ gray	2002-3221/1000-413	50

Other terminal blocks with the same profile:

Through	2002-3201	Page 66
---------	-----------	---------

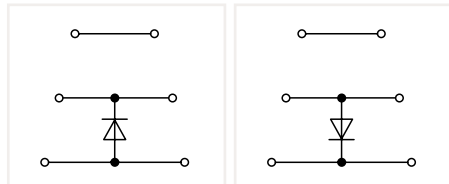
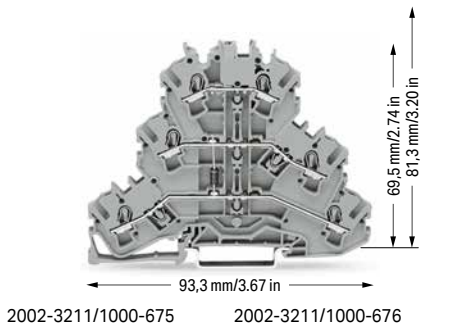

Triple-deck diode terminal block, with 1N4007 diode		
Color	Item No.	Pack. Unit
○ gray	2002-3211/1000-675	50
○ gray	2002-3211/1000-676	50

① Conductor range: 0.25 ... 4 mm<sup>2</sup> "s+f-st";  
Push-in termination: 1 ... 4 mm<sup>2</sup> "s" and 1 ... 2.5 mm<sup>2</sup>  
"insulated ferrules, 12 mm"  
Depending on the conductor characteristic, a conductor  
with a smaller cross section can also be inserted  
via push-in termination.

Approvals and corresponding ratings,  
visit [www.wago.com](http://www.wago.com)

**Accessories; 2002 Series**

Appropriate marking systems:  
WMB/WMB Inline/Marking strips

**End and intermediate plate; 0.8 mm thick**

	orange	2002-3292	100 (25)
	gray	2002-3291	100 (25)

**Insulation stop; 5 pcs/strip; 0.25 ... 0.5 mm<sup>2</sup>**

	light gray	2002-171	200 (25)
---	------------	----------	----------

**Insulation stop; 5 pcs/strip; 0.75 ... 1 mm<sup>2</sup>**

	dark gray	2002-172	200 (25)
---	-----------	----------	----------

**Push-in type jumper bar; insulated; I<sub>N</sub> 25 A; light gray**

	2-way	2002-402	25
	3-way	2002-403	25
	4-way	2002-404	25
	5-way	2002-405	25
	6-way	2002-406	25
	7-way	2002-407	25
	8-way	2002-408	25
	9-way	2002-409	25
	10-way	2002-410	25

**Push-in type jumper bar; insulated; I<sub>N</sub> 25 A; light gray**

	1 to 3	2002-433	25
	1 to 4	2002-434	25
	1 to 5	2002-435	25
	1 to 6	2002-436	25
	1 to 7	2002-437	25
	1 to 8	2002-438	25
	1 to 9	2002-439	25
	1 to 10	2002-440	25

**Modular connector; snaps together; for jumper contact slot**

	gray	2002-511	100 (25)
---	------	----------	----------

**Spacer module; snaps together; bridges commoned terminal blocks**

	gray	2002-549	100 (25)
---	------	----------	----------

**End plate; for modular connector; 1.5 mm thick**

	gray	2002-541	100 (25)
---	------	----------	----------

**Test plug; with 500 mm cable; 2 mm Ø; max. 42 V**

	red	210-136	50 (1)
---	-----	---------	--------

**Test plug adapter; for 4 mm Ø test plug**

	gray	2009-174	100 (25)
---	------	----------	----------

**Accessories; 2002 Series**

Appropriate marking systems:  
WMB/WMB Inline/Marking strips

**Banana plug; for 4 mm socket diameter; color mixed; 10 x orange, white, black, blue, yellow; max. 42 V**

		215-111	50
---	--	---------	----

**Testing tap; for max. 2.5 mm<sup>2</sup>**

	gray	2009-182	100 (25)
---	------	----------	----------

**WMB Inline, plain; 1,500 WMB markers (5 mm)/reel; 5 ... 5.2 mm stretchable**

	white	2009-115	1
---	-------	----------	---

**Marking strip; plain; 11 mm wide; 50 m reel**

	white	2009-110	1
---	-------	----------	---

**WMB marking card; white; 10 strips with 10 markers/card; 5 ... 5.2 mm stretchable**

	plain	793-5501	5
---	-------	----------	---

**Triple-deck marker carrier; pivoting**

	gray	2002-131	50 (25)
--	------	----------	---------

**Group marker carrier; snap-on type for jumper slot; 5 mm wide**

	gray	2009-191	50 (25)
---	------	----------	---------

**Screwless end stop; for DIN-35 rail; 6 mm wide**

	gray	249-116	100 (25)
---	------	---------	----------



Double- and triple-deck LED terminal blocks:  
Using LED terminal blocks, monitoring units can be  
designed, e.g., for control and operating circuits.



Triple-deck diode terminal blocks were specifically developed for custom diode circuits, such as lamp test and collective fault signal circuits.  
These terminal blocks provide high-density wiring in a width of just 5.2 mm.  
Push-in type jumper bars provide additional options for custom circuit design.

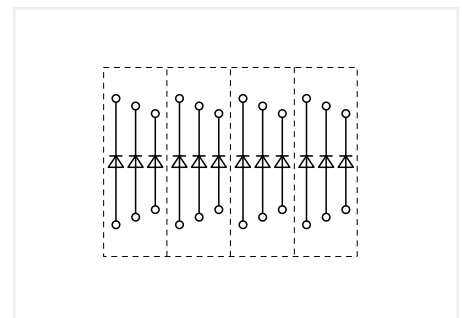

Open diode gates can be created and connected individually using the following terminal blocks:  
2002-3212/1000-673 or 2002-3212/1000-674

Using push-in type jumper bars, individual decks can be turned into polarized diode gates.

# CONNECTORS

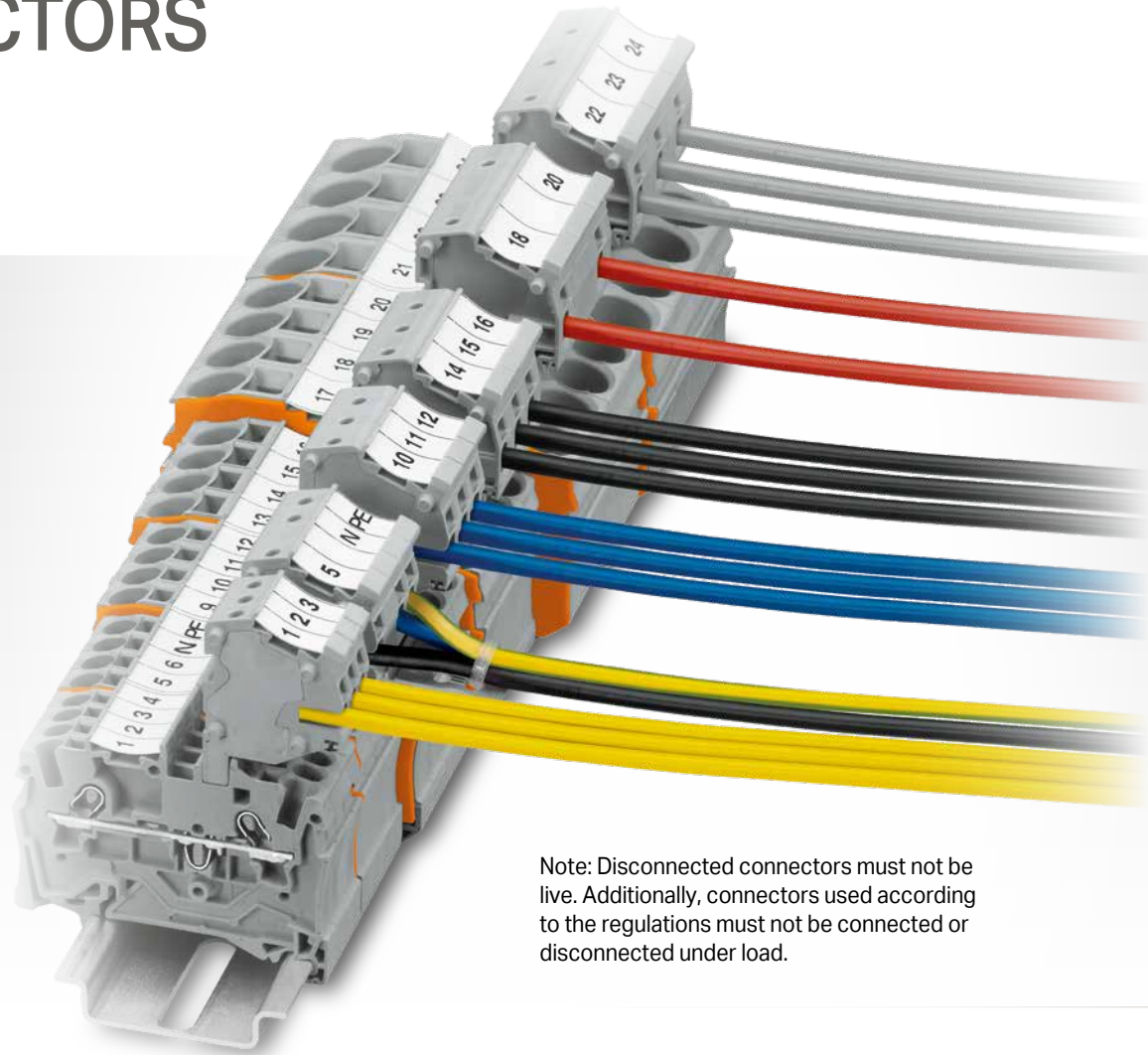

Note: Disconnected connectors must not be live. Additionally, connectors used according to the regulations must not be connected or disconnected under load.

## Connectors



Modular connectors with Push-in CAGE CLAMP® technology offer an additional connection option for conductors of the same size as the terminal block being used (up to 23 A). They can also double as test plugs.

## Connector Strips



Additionally, 2- to 10-pole connector strips for the 2001 and 2002 Series, as well as 2- to 5-pole connector strips for the 2004 Series are available.

## Testing



Modular connectors for 2001, 2002, 2004, 2006, 2010 and 2016 Series have a test socket for 2 mm or 2.3 mm Ø test plugs (max. test voltage: 42 V).

# TESTING ACCESSORIES

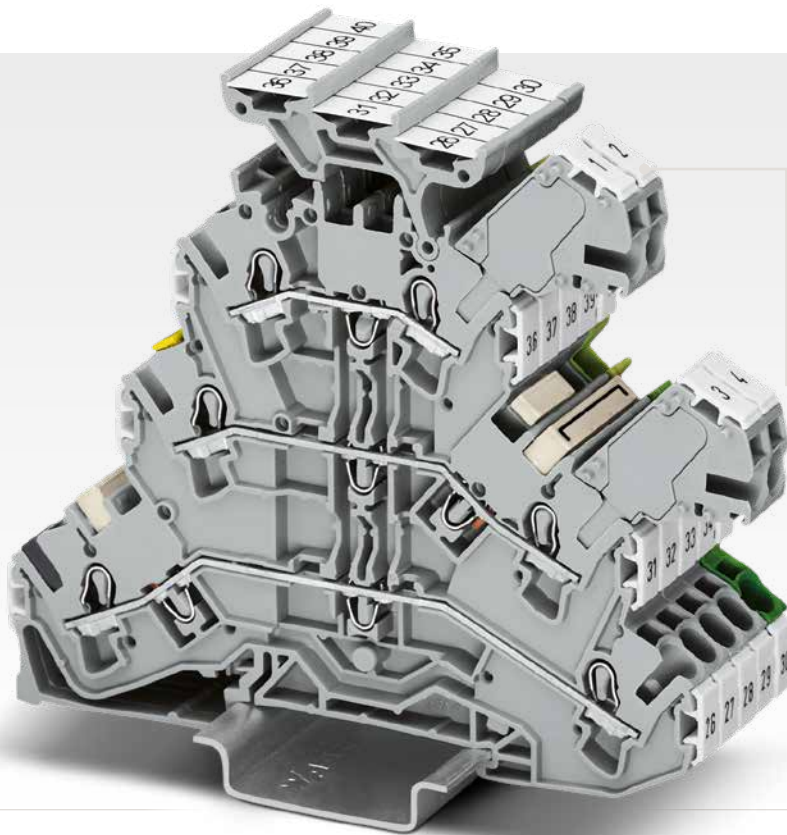

## Connectors

- Circuit identification via WMB markers
- Customizable to suit required number of poles

## Test Plugs



The Test Plugs TOPJOB® S can be simply pushed into the conductor entry and then unplugged – no tools required. Test plugs are a convenient workaround for multilevel terminal block assemblies with inaccessible jumper slots. Additionally, terminal blocks can be skipped using spacer modules.

## Test Plug Adapter



Test plug adapter (2009-174, CAT I) for 4 mm Ø plugs – compatible with 2000 to 2016 Series

## Testing Tap



Testing tap (2009-182) for tool-free connection of test cables up to 2.5 mm<sup>2</sup> (12 AWG) – compatible with 2000 to 2016 Series



## Connector, Connector Strip TOPJOB® S

1 (1.5) mm<sup>2</sup>; 2000 Series and 1.5 (2,5) mm<sup>2</sup>; 2001 Series and 2.5 (4) mm<sup>2</sup>; 2002 Series

Technical Data	
0.14 ... 1 (1.5) mm <sup>2</sup> ①	24 ... 16 AWG
500 V/6 kV/3 ④	
I <sub>N</sub> 13.5 A	
Terminal block width: 3.5 mm / 0.138 inch	
 9 ... 11 mm / 0.35 ... 0.43 inch	



Modular connector; for jumper contact slot; snaps together; gray

	Item No.	Pack. Unit
<input type="radio"/> 1-pole	2000-510	100 (25)

Modular connector; with end plate; for jumper contact slot; snaps together; gray  
Terminal block width: 5 mm / 0.197 inch

<input type="radio"/> 1-pole	2000-511	100 (25)
------------------------------	----------	----------

Spacer module; snaps together; bridges commoned terminal blocks

<input type="radio"/> gray	2000-549	100 (25)
----------------------------	----------	----------

connector strip; for jumper contact slot; gray

<input type="radio"/> 2-pole	2000-552	25
<input type="radio"/> 3-pole	2000-553	25
<input type="radio"/> 4-pole	2000-554	25
<input type="radio"/> 5-pole	2000-555	10
<input type="radio"/> 6-pole	2000-556	10
<input type="radio"/> 7-pole	2000-557	10
<input type="radio"/> 8-pole	2000-558	10
<input type="radio"/> 9-pole	2000-559	10
<input type="radio"/> 10-pole	2000-560	10

Accessories; item-specific

WMB Inline; plain; 2,300 WMB markers (3.5 mm)/reel

 white	2009-113	1
---	----------	---

WMB marking card; white; 10 strips with 10 markers/card; for 3.5 mm terminal block width

 plain	793-3501	5
--	----------	---

Technical Data	
0.25 ... 1.5 (2.5) mm <sup>2</sup> ②	22 ... 14 AWG
500 V/6 kV/3 ④	300 V, 15 A ⑤
I <sub>N</sub> 18 A	
Terminal block width: 4.2 mm / 0.165 inch	
 9 ... 11 mm / 0.35 ... 0.43 inch	



Modular connector; for jumper contact slot; snaps together; gray

	Item No.	Pack. Unit
<input type="radio"/> 1-pole	2001-511	100 (25)

Modular connector; with end plate; for jumper contact slot; snaps together; gray  
Terminal block width: 5 mm / 0.197 inch

<input type="radio"/> 1-pole	2001-511	100 (25)
------------------------------	----------	----------

Spacer module; snaps together; bridges commoned terminal blocks

<input type="radio"/> gray	2001-549	100 (25)
----------------------------	----------	----------

connector strip; for jumper contact slot; gray

<input type="radio"/> 2-pole	2001-552	25
<input type="radio"/> 3-pole	2001-553	25
<input type="radio"/> 4-pole	2001-554	25
<input type="radio"/> 5-pole	2001-555	10
<input type="radio"/> 6-pole	2001-556	10
<input type="radio"/> 7-pole	2001-557	10
<input type="radio"/> 8-pole	2001-558	10
<input type="radio"/> 9-pole	2001-559	10
<input type="radio"/> 10-pole	2001-560	10

Accessories; item-specific

WMB Inline; plain; 2,000 WMB markers (4 mm)/reel; 4 ... 4.2 mm stretchable

 white	2009-114	1
---	----------	---

WMB marking card; white; 10 strips with 10 markers/card; 4 ... 4.2 mm stretchable

 plain	793-4501	5
---	----------	---

WMB marking card; plain; 10 strips with 10 markers/card; 4 ... 4.2 mm stretchable

 yellow	793-4501/000-002	5
 red	793-4501/000-005	5
 blue	793-4501/000-006	5
 gray	793-4501/000-007	5
 orange	793-4501/000-012	5
 light green	793-4501/000-017	5
 green	793-4501/000-023	5
 violet	793-4501/000-024	5

Technical Data	
0.25 ... 2.5 (4) mm <sup>2</sup> ③	22 ... 12 AWG
500 V/6 kV/3 ④	300 V, 20 A ⑤
I <sub>N</sub> 24 A	
Terminal block width: 5.2 mm / 0.205 inch	
 10 ... 12 mm / 0.39 ... 0.47 inch	

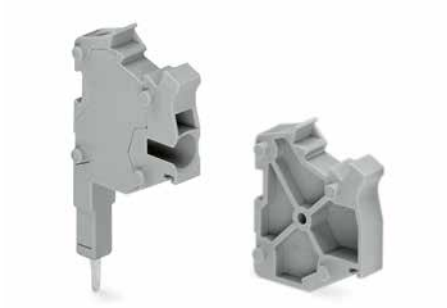

Modular connector; for jumper contact slot; snaps together; gray

	Item No.	Pack. Unit
<input type="radio"/> 1-pole	2002-511	100 (25)

Modular connector; with end plate; for jumper contact slot; snaps together; gray  
Terminal block width: 5 mm / 0.197 inch

<input type="radio"/> 1-pole	2002-511	100 (25)
------------------------------	----------	----------

Spacer module; snaps together; bridges commoned terminal blocks

<input type="radio"/> gray	2002-549	100 (25)
----------------------------	----------	----------

connector strip; for jumper contact slot; gray

<input type="radio"/> 2-pole	2002-552	25
<input type="radio"/> 3-pole	2002-553	25
<input type="radio"/> 4-pole	2002-554	25
<input type="radio"/> 5-pole	2002-555	10
<input type="radio"/> 6-pole	2002-556	10
<input type="radio"/> 7-pole	2002-557	10
<input type="radio"/> 8-pole	2002-558	10
<input type="radio"/> 9-pole	2002-559	10
<input type="radio"/> 10-pole	2002-560	10

Accessories; item-specific

WMB Inline; plain; 1,500 WMB markers (5 mm)/reel; 5 ... 5.2 mm stretchable

 white	2009-115	1
---	----------	---

WMB marking card; white; 10 strips with 10 markers/card; 5 ... 5.2 mm stretchable

 plain	793-5501	5
---	----------	---

WMB marking card; plain; 10 strips with 10 markers/card; 5 ... 5.2 mm stretchable

 yellow	793-5501/000-002	5
 red	793-5501/000-005	5
 blue	793-5501/000-006	5
 gray	793-5501/000-007	5
 orange	793-5501/000-012	5
 light green	793-5501/000-017	5
 green	793-5501/000-023	5
 violet	793-5501/000-024	5

**PUSH-IN CAGE CLAMP®**

❶ Conductor range: 0.14 ... 1.5 mm<sup>2</sup> "s+f-st";  
Push-in termination: 0.5 ... 1.5 mm<sup>2</sup> "s" and  
0.5 ... 0.75 mm<sup>2</sup> "insulated ferrules; 10 mm"  
Depending on the conductor characteristic, a conductor  
with a smaller cross section can also be inserted  
via push-in termination.

❷ Conductor range: 0.25 ... 2.5 mm<sup>2</sup> "s+f-st";  
Push-in termination: 0.75 ... 2.5 mm<sup>2</sup> "s" and  
0.75 ... 1.5 mm<sup>2</sup> "insulated ferrules; 12 mm"  
Depending on the conductor characteristic, a conductor  
with a smaller cross section can also be inserted  
via push-in termination.

❸ Conductor range: 0.25 ... 4 mm<sup>2</sup> "s+f-st";  
Push-in termination: 1 ... 4 mm<sup>2</sup> "s" and 1 ... 2.5 mm<sup>2</sup>  
"insulated ferrules, 12 mm"  
Depending on the conductor characteristic, a conductor  
with a smaller cross section can also be inserted  
via push-in termination.

❹ 500 V = rated voltage  
6 kV = rated impulse voltage  
3 = pollution degree

**Note:**

According to EN 61984, pluggable connectors without  
a current interrupting capacity must not be mated or  
unmated when live or under load.

Approvals and corresponding ratings,  
visit [www.wago.com](http://www.wago.com)

**Accessories; for connector strips**

Appropriate marking systems:  
WMB/WMB InLine/Marking strips

**End plate; for modular connector; 1.5 mm thick**

gray	2002-541	100 (25)
------	----------	----------



**Test plug; with 500 mm cable; 2 mm Ø; max. 42 V**

red	210-136	50 (1)
-----	---------	--------



**Test plug; with 500 mm cable; 2.3 mm Ø; max. 42 V**

yellow	210-137	50 (1)
--------	---------	--------



**Strain relief plate; gray**

35 mm wide	734-326	100 (25)
6 mm wide	734-327	100 (25)
12.5 mm wide	734-328	100 (25)
25 mm wide	734-329	100 (25)



**Marking strip; plain; 11 mm wide; 50 m reel**

white	2009-110	1
-------	----------	---

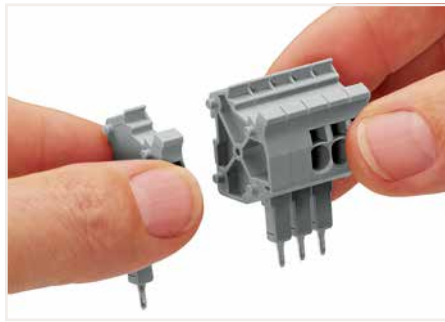

Snapping connectors and spacers together to assemble a multipole connector.



The modular connectors also connect conductors of the same size as the terminal blocks being used.

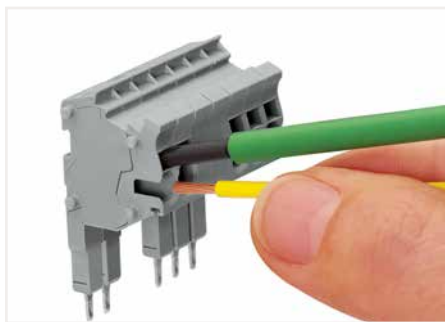

Operating tool for fine-stranded conductors without ferrules – push-in connection of solid conductors

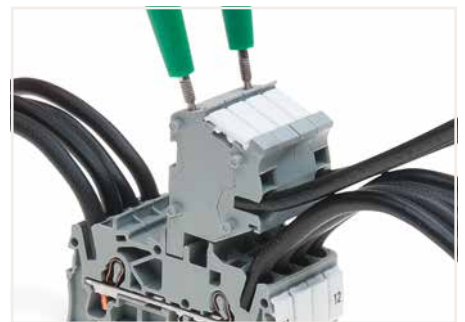

Connectors with a 2 mm Ø test socket for testing voltage via 2-pole voltage tester



Snapping on a strain relief plate.



Rail-mount terminal block assembly for electric motor wiring

## Connector, Connector Strip TOPJOB® S

### 4 (6) mm<sup>2</sup>; 2004 Series; 2006 Series; 2010 Series and 2016 Series

#### Technical Data

0.5 ... 4 (6) mm <sup>2</sup> ①	22 ... 10 AWG
500 V/6 kV/3 ②	300 V, 15 A, $I_N$
$I_N$ 32 A	
Terminal block width: 6.2 mm / 0.244 inch	
 11 ... 13 mm / 0.43 ... 0.51 inch	



#### Technical Data

0.5 ... 4 (6) mm <sup>2</sup> ①	22 ... 10 AWG
500 V/6 kV/3 ②	
$I_N$ 32 A	
Terminal block width: 7.5 mm / 0.295 inch	
 11 ... 13 mm / 0.43 ... 0.51 inch	



#### Technical Data

0.5 ... 4 (6) mm <sup>2</sup> ①	22 ... 10 AWG
500 V/6 kV/3 ②	
$I_N$ 32 A	
Terminal block width: 10 mm / 0.394 inch	
 11 ... 13 mm / 0.43 ... 0.51 inch	



Modular connector; for jumper contact slot; snaps together; gray

	Item No.	Pack. Unit
○ 1-pole	2004-511	100 (25)

Modular connector; for jumper contact slot; snaps together; gray

	Item No.	Pack. Unit
○ 1-pole	2006-511	50 (25)

Modular connector; for jumper contact slot; snaps together; gray

	Item No.	Pack. Unit
○ 1-pole	2010-511	50 (25)

Spacer module; snaps together; bridges commoned terminal blocks

○ gray	2004-549	100 (25)
--------	----------	----------

Spacer module; snaps together; bridges commoned terminal blocks

○ gray	2006-549	50 (25)
--------	----------	---------

Spacer module; snaps together; bridges commoned terminal blocks

○ gray	2010-549	50 (25)
--------	----------	---------

connector strip; for jumper contact slot; gray

○ 2-pole	2004-552	25
○ 3-pole	2004-553	25
○ 4-pole	2004-554	25
○ 5-pole	2004-555	10

Accessories; item-specific

Test plug; with 500 mm cable; 2.3 mm Ø; max. 42 V

 yellow	210-137	50 (1)
--	---------	--------

Accessories, for connector strips

Appropriate marking systems: WMB/WMB Inline/Marking strips

End plate; for modular connector; 1.5 mm thick

gray	2004-541	100 (25)
------	----------	----------



Test plug; with 500 mm cable; 2 mm Ø; max. 42 V

red	210-136	50 (1)
-----	---------	--------



Strain relief plate; gray

35 mm wide	734-326	100 (25)
6 mm wide	734-327	100 (25)
12.5 mm wide	734-328	100 (25)
25 mm wide	734-329	100 (25)



Marking strip; plain; 11 mm wide; 50 m reel

white	2009-110	1
-------	----------	---



WMB marking card; white; 10 strips with 10 markers/card; 5 ... 5.2 mm stretchable

plain	793-5501	5
-------	----------	---



**Technical Data**0.5 ... 4 (6) mm<sup>2</sup> ① | 22 ... 10 AWG

500 V/6 kV/3 ②

I<sub>N</sub> 32 A

Terminal block width: 12 mm / 0.472 inch

 11 ... 13 mm / 0.43 ... 0.51 inch

① Conductor range: 0.5 ... 6 mm<sup>2</sup> "s+f-st";  
Push-in termination: 1.5 ... 6 mm<sup>2</sup> "s" and 1.5 ... 4 mm<sup>2</sup>  
"insulated ferrules; 12 mm"  
Depending on the conductor characteristic, a conductor with a smaller cross section can also be inserted via push-in termination.

② 500 V = rated voltage  
6 kV = rated impulse voltage  
3 = pollution degree

**Note:**

According to EN 61984, pluggable connectors without a current interrupting capacity must not be mated or unmated when live or under load.

Approvals and corresponding ratings, visit [www.wago.com](http://www.wago.com)

Modular connector; for jumper contact slot; snaps together; gray

	Item No.	Pack. Unit
<input type="radio"/> 1-pole	2016-511	50 (25)

Spacer module; snaps together; bridges commoned terminal blocks

<input type="radio"/> gray	2016-549	50 (25)
----------------------------	----------	---------

PUSH-IN CAGE CLAMP®

# L-Type Test Plug Module TOPJOB® S for Testing 5.2 mm Wide Rail-Mount Terminal Blocks – via Conductor Entries

## 2.5 (4) mm<sup>2</sup>; 2002 Series

### Technical Data

0.25 ... 2.5 (4) mm<sup>2</sup> ① | 22 ... 12 AWG

500 V/6 kV/3 ②

I<sub>N</sub> 18 A

Terminal block width: 5.2 mm / 0.205 inch

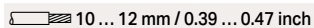
 10 ... 12 mm / 0.39 ... 0.47 inch

① Conductor range: 0.25 ... 4 mm<sup>2</sup> "s+f-st";  
Push-in termination: 1 ... 4 mm<sup>2</sup> "s" and 1 ... 2.5 mm<sup>2</sup> "insulated ferrules, 12 mm"  
Depending on the conductor characteristic, a conductor with a smaller cross section can also be inserted via push-in termination.

② 500 V = rated voltage  
6 kV = rated impulse voltage  
3 = pollution degree

Approvals and corresponding ratings,  
visit [www.wago.com](http://www.wago.com)



L-type test plug assembly:  
L-type test plug modules and L-type spacer modules  
(max. 10-pole)  
Additionally, terminal blocks can be skipped using spacer modules.

L-type test plug module; snaps together; gray  
According to EN 61984, pluggable connectors without a current interrupting capacity must not be mated or unmated when live or under load.

	Item No.	Pack. Unit
○ 1-pole	2002-611	100 (25)

L-type spacer module; snaps together; bridges commoned terminal blocks

○ gray	2002-649	100 (25)
--------	----------	----------

### Accessories; for L-type test plug modules

Appropriate marking systems:  
WMB/WMB Inline/Mini-WSB

End plate; for modular test plug module; 1.5 mm thick

gray	2002-641	100 (25)
------	----------	----------



Test plug; with 500 mm cable; 2 mm Ø; max. 42 V

red	210-136	50 (1)
-----	---------	--------



Test plug; with 500 mm cable; 2.3 mm Ø; max. 42 V

yellow	210-137	50 (1)
--------	---------	--------



Strain relief plate; gray

35 mm wide	734-326	100 (25)
6 mm wide	734-327	100 (25)
12.5 mm wide	734-328	100 (25)
25 mm wide	734-329	100 (25)



WMB Inline, plain; 1,500 WMB markers (5 mm)/reel;  
5 ... 5.2 mm stretchable

white	2009-115	1
-------	----------	---



WMB marking card; white; 10 strips with 10 markers/card;  
5 ... 5.2 mm stretchable

plain	793-5501	5
-------	----------	---



L-type test plug modules fitted in a triple-deck terminal block



L-type test plug modules for testing rail-mount terminal blocks via conductor entries

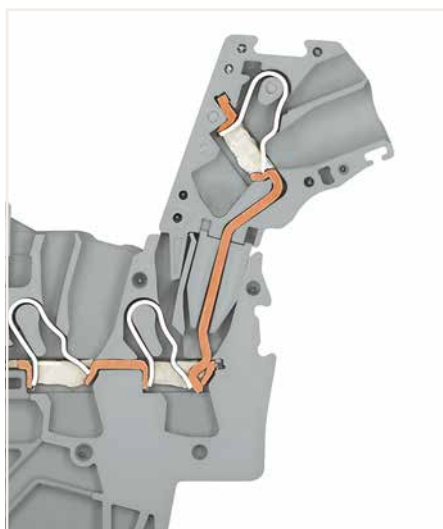

L-type test plug module – cross-sectional view of contacts



## Test Plug Adapter, Testing Tap TOPJOB® S 2009 Series



Test plug adapter; for 4 mm Ø test plug; for testing Rail-Mount Terminal Blocks TOPJOB® S  
Power must be switched off when installing the test plug adapter. The safety guidelines for working on live installations must be observed.

Color	Item No.	Pack. Unit
○ gray	2009-174	100 (25)

Testing tap; for max. 2.5 mm<sup>2</sup>; connects test cables (0.08 ... 2.5 mm<sup>2</sup>) without tool  
Power must be switched off when installing the testing tap. The safety guidelines for working on live installations must be observed.

Color	Item No.	Pack. Unit
○ gray	2009-182	100 (25)



Test plug adapter (2009-174, CAT I) for 4 mm Ø plugs – compatible with 2000 to 2016 Series



Testing tap (2009-182) for tool-free connection of test cables up to 2.5 mm<sup>2</sup> (12 AWG) – compatible with 2000 to 2016 Series

## Colored Push-In Type Jumper Bar TOPJOB® S 2000 Series and 2002 Series

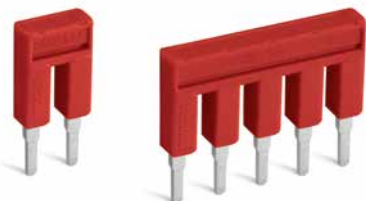

### Push-in type jumper bar; insulated; I<sub>N</sub> 14 A; red

	Item No.	Pack. Unit
● 2-way	2000-402/000-005	25
● 3-way	2000-403/000-005	25
● 4-way	2000-404/000-005	25
● 5-way	2000-405/000-005	25
● 6-way	2000-406/000-005	25
● 7-way	2000-407/000-005	25
● 8-way	2000-408/000-005	25
● 9-way	2000-409/000-005	25
● 10-way	2000-410/000-005	25

### Push-in type jumper bar; insulated; I<sub>N</sub> 14 A; blue

	Item No.	Pack. Unit
● 2-way	2000-402/000-006	25
● 3-way	2000-403/000-006	25
● 4-way	2000-404/000-006	25
● 5-way	2000-405/000-006	25
● 6-way	2000-406/000-006	25
● 7-way	2000-407/000-006	25
● 8-way	2000-408/000-006	25
● 9-way	2000-409/000-006	25
● 10-way	2000-410/000-006	25

### Push-in type jumper bar; insulated; yellow-green

	Item No.	Pack. Unit
● 2-way	2000-402/000-018	25

### Push-in type jumper bar; insulated; I<sub>N</sub> 25 A; red

● 2-way	2002-402/000-005	25
● 3-way	2002-403/000-005	25
● 4-way	2002-404/000-005	25
● 5-way	2002-405/000-005	25
● 6-way	2002-406/000-005	25
● 7-way	2002-407/000-005	25
● 8-way	2002-408/000-005	25
● 9-way	2002-409/000-005	25
● 10-way	2002-410/000-005	25

### Push-in type jumper bar; insulated; I<sub>N</sub> 25 A; blue

● 2-way	2002-402/000-006	25
● 3-way	2002-403/000-006	25
● 4-way	2002-404/000-006	25
● 5-way	2002-405/000-006	25
● 6-way	2002-406/000-006	25
● 7-way	2002-407/000-006	25
● 8-way	2002-408/000-006	25
● 9-way	2002-409/000-006	25
● 10-way	2002-410/000-006	25



For example, colored push-in type jumper bars are used with sensor terminal blocks.

# Adjacent Jumper for Continuous Commoning TOPJOB® S 2002 Series

Technical Data	
800 V	
I <sub>N</sub> 25 A	



Adjacent jumper for continuous commoning; insulated; light gray		
	Item No.	Pack. Unit
<input type="radio"/> 2-way	2002-400	25

Technical Data	
800 V/8 kV/3	
I <sub>N</sub> 25 A	



Adjacent jumper for continuous commoning; insulated; 1 to 3		
Color	Item No.	Pack. Unit
<input type="radio"/> light gray	2002-423	25
<input type="radio"/> red	2002-423/000-005	25
<input type="radio"/> blue	2002-423/000-006	25

Technical Data	
800 V/8 kV/3	
I <sub>N</sub> 25 A	



Adjacent jumper for continuous commoning; insulated; light gray		
	Item No.	Pack. Unit
<input type="radio"/> 5-way	2002-415	25



Continuous jumpers (2002 Series) readily connect an endless number of terminal blocks to each other via single jumper slot. Use the second jumper slot for additional commoning or testing.



The 1-to-3 adjacent jumper for continuous commoning enables every other terminal block to be commoned. For example, positive and negative potentials can be accommodated alongside each other.

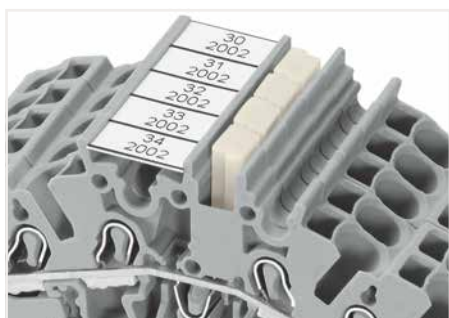

Adjacent jumpers for continuous commoning (2002-400)

# Staggered Jumper TOPJOB® S 2002 Series

**Technical Data**

400 V/6 kV/3

I<sub>N</sub> 25 A

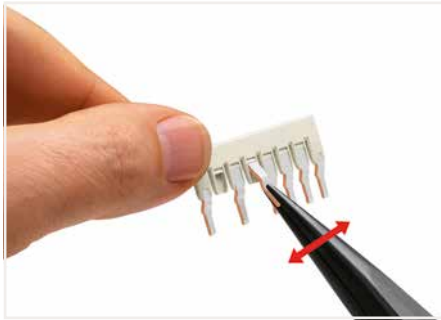

**Staggered jumper (seven contacts):**  
Individual jumper contacts can be broken off by bending them. The remaining piece of insulation will meet requirements for clearances and creepage distances.

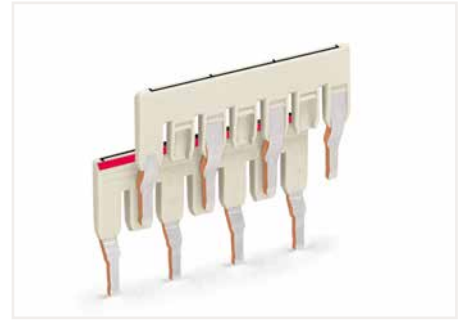

Staggered jumpers (seven contacts)

Staggered jumper; insulated; for 2002, 2003, 2022 and 2022 Series Rail-Mount Terminal Blocks; light gray

	Item No.	Pack. Unit
<input type="radio"/> 2-way	2002-472	25
<input type="radio"/> 3-way	2002-473	25
<input type="radio"/> 4-way	2002-474	25
<input type="radio"/> 5-way	2002-475	25
<input type="radio"/> 6-way	2002-476	25
<input type="radio"/> 7-way	2002-477	25
<input type="radio"/> 8-way	2002-478	25
<input type="radio"/> 9-way	2002-479	25
<input type="radio"/> 10-way	2002-480	25
<input type="radio"/> 11-way	2002-481	25
<input type="radio"/> 12-way	2002-482	25

Customized staggered jumper; insulated; with contact lugs broken off at the factory and circuit printing; light gray

<input type="radio"/> 1-3	2002-473/011-000	25
<input type="radio"/> 1-3-5	2002-475/011-000	25
<input type="radio"/> 1-3-5-7	2002-477/011-000	25
<input type="radio"/> 1-3-5-7-9	2002-479/011-000	25
<input type="radio"/> 1-3-5-7-9-11	2002-481/011-000	25

**Commoning using staggered jumpers:**

Individual jumper contacts can be broken off by bending them. The remaining piece of insulation will meet requirements for clearances and creepage distances. Custom staggered jumpers can be created, e.g., for bridging over a terminal block with a different potential. Make sure that only one contact lug is in contact with the terminal block.

The contact lugs of the customized staggered jumpers contact the terminal blocks via the gaps created in the second jumper. Insert and press the ready-made jumper assembly into the jumper slot until it hits backstop.

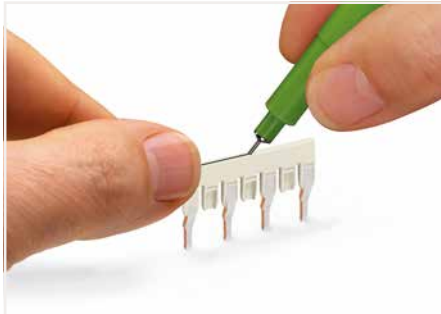

**Staggered jumper:**  
Marking with a felt-tip pen.



Locate red stripes of the staggered jumpers on the inside. Insert staggered jumper and push down until it hits backstop.



**Staggering jumpers in a single jumper slot.**  
Custom staggered jumpers can be created, e.g., for bridging over a terminal block with a different potential. Make sure that only one contact lug is in contact with the terminal block. The contact lugs of the customized staggered jumpers contact the terminal blocks via the gaps created in the second jumper. Insert and press the ready-made jumper assembly into the jumper slot until it hits backstop.

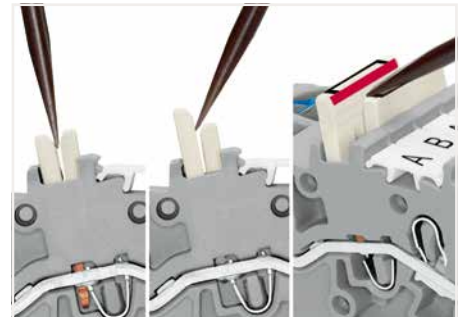

**Removing a staggered jumper:**  
Insert the operating tool between the staggered jumpers, then lift up the jumper.



Commoning two potentials in one single jumper slot via extremely slim staggered jumpers.

Sold & Serviced By:  
  
 Toll Free Phone (877) SERV098  
[www.electromate.com](http://www.electromate.com)  
[sales@electromate.com](mailto:sales@electromate.com)

# Star Point Jumper, Delta Jumper, Collective Jumper Carrier TOPJOB® S

Technical Data
800 V/8 kV/3
$I_N = I_N$ terminal block

Technical Data
800 V/8 kV/3
$I_N = I_N$ terminal block



Star point jumper; insulated; 1-3-5; light gray		
	Item No.	Pack. Unit
○	2000-405/011-000	25
○	2001-405/011-000	25
○	2002-405/011-000	25
○	2004-405/011-000	25
○	2006-405/011-000	25
○	2010-405/011-000	25
○	2016-405/011-000	25

Delta jumper; insulated; 1-2 3-4 5-6; light gray		
	Item No.	Pack. Unit
○	2000-406/020-000	25
○	2001-406/020-000	25
○	2002-406/020-000	25
○	2004-406/020-000	25

Collective jumper carrier; for DIN-35 rail; for 2000 to 2016 Series jumpers		
Color	Item No.	Pack. Unit
○ gray	2009-180	25

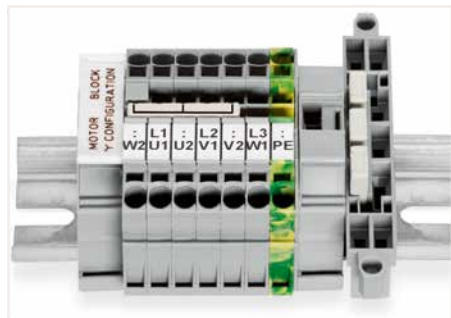

This star point jumper has been specially developed to create a "star point" and is used on motor terminal boards equipped with rail-mount terminal blocks TOPJOB® S.



This delta jumper has been specially developed to create a delta configuration and is used on motor terminal boards equipped with rail-mount terminal blocks TOPJOB® S.



Collective jumper carrier



## Push-In Type Wire Jumper TOPJOB® S 2009 Series

### Technical Data

800 V/8 kV/3

 $I_N$  9 A

Push-in type wire jumper; insulated; 0.75 mm<sup>2</sup> conductor cross-section; for 2000, 2020 and 2200 Series Rail-Mount Terminal Blocks; gray

	Item No.	Pack. Unit
L = 60 mm	2009-402	100 (10)
L = 110 mm	2009-404	100 (10)
L = 250 mm	2009-406	100 (10)

### Technical Data

800 V/8 kV/3

 $I_N$  18 A

Push-in type wire jumper; insulated; 1.5 mm<sup>2</sup> conductor cross-section; for 2001, 2002, 2003, 2022, 2201 and 2202 Series Rail-Mount Terminal Blocks; black

	Item No.	Pack. Unit
L = 60 mm	2009-412	100 (10)
L = 110 mm	2009-414	100 (10)
L = 250 mm	2009-416	100 (10)

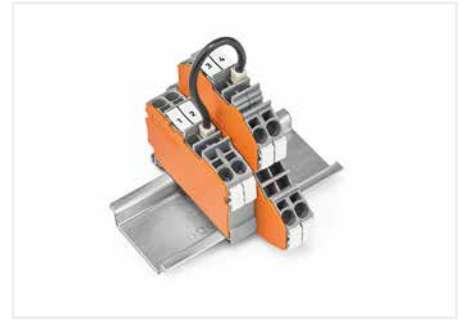

Push-in type wire jumpers connect terminal blocks over longer distances and across multiple levels.



Push-in type wire jumper; insulated; L = 110 mm; 1.5 mm<sup>2</sup> conductor cross-section; for 2001, 2002, 2003, 2022, 2201 and 2202 Series Rail-Mount Terminal Blocks

Color	Item No.	Pack. Unit
● red	2009-414/000-005	100 (10)
● blue	2009-414/000-006	100 (10)



Push down the wire jumper until fully inserted. Lift the jumper with an operating tool for rewiring.

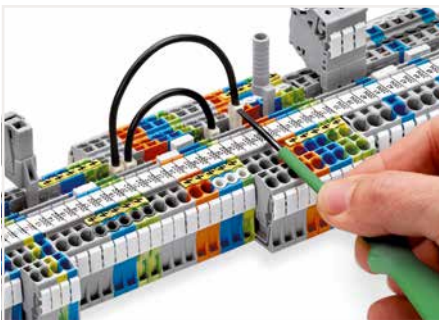

Push down the wire jumper until fully inserted. Lift the jumper with an operating tool for rewiring.

## Vertical Jumper TOPJOB® S 2000 Series and 2002 Series

Technical Data	
500 V/6 kV/3	
I <sub>N</sub> 13.5 A	



Double-deck vertical jumper; insulated		
Color	Item No.	Pack. Unit
○ light gray	2000-492	100 (25)

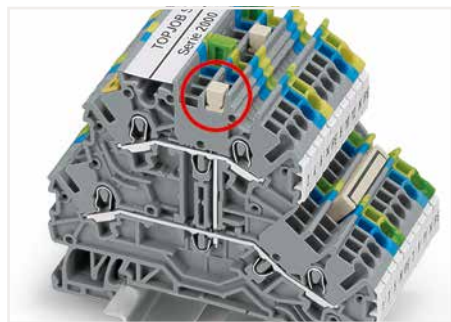

Commoning two levels via double-deck vertical jumper (2000-492).

Technical Data	
500 V/6 kV/3	
I <sub>N</sub> 24 A	



Double-deck vertical jumper; insulated		
Color	Item No.	Pack. Unit
○ light gray	2002-492	100 (25)
● orange	2002-492/000-012	100 (25)

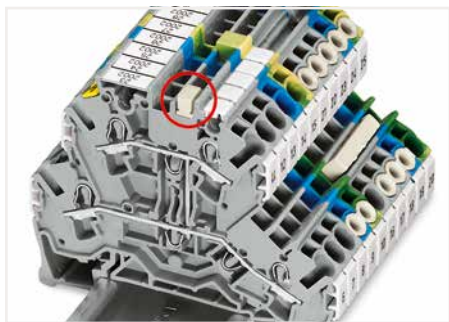

Commoning two levels via double-deck vertical jumper (2002-492).

Technical Data	
500 V/6 kV/3	
I <sub>N</sub> 24 A	



Triple-deck vertical jumper; insulated		
Color	Item No.	Pack. Unit
○ light gray	2002-493	100 (25)

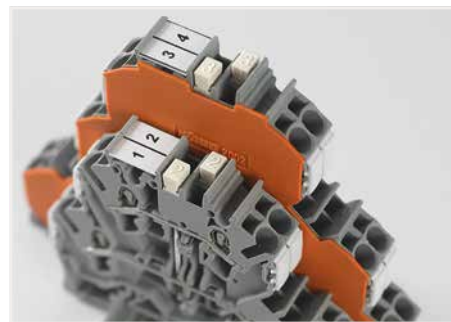

Created for double- and triple-deck terminal blocks TOPJOB® S, the vertical jumpers can common two or three levels. Clearly marked numerals ("2" and "3") distinguish the double-deck (2002-492) and triple-deck vertical jumpers (2002-493), even when inserted.



Commoning three levels via triple-deck vertical jumper (2002-493).

## Disconnect plug, Blind Plug for Carrier Terminal Block TOPJOB® S 2002 Series and 2006 Series

### Technical Data

400 V/6 kV/3

 $I_N$  10 A

### Technical Data

800 V/8 kV/3

 $I_N$  30 A

Disconnect plug for carrier terminal blocks; suitable when using a carrier terminal block as disconnect terminal block

Color	Item No.	Pack. Unit
● orange	2002-401	100 (25)

Disconnect plug for carrier terminal blocks; suitable when using a carrier terminal block as disconnect terminal block

Color	Item No.	Pack. Unit
● orange	2006-401	100 (25)
○ white	2006-401/000-050	100 (25)

Blind plug for carrier terminal block; indicates a disconnection

Color	Item No.	Pack. Unit
● red	2006-451	100 (25)

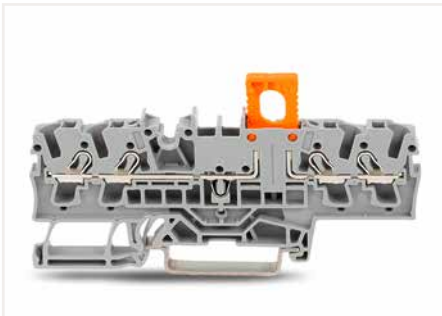

Carrier terminal block (2002-1661) with disconnect plug (2002-401) in operating position

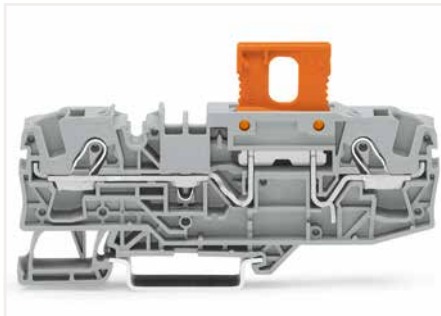

Carrier terminal block (2006-1661) with disconnect plug (2006-401) in operating position

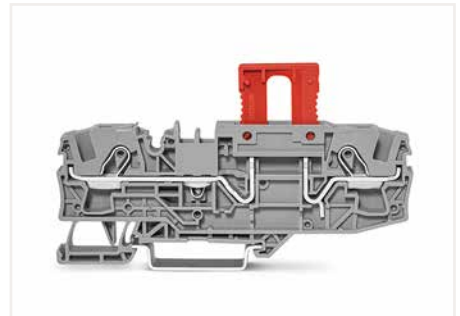

Blind plug (2006-451) for carrier terminal block; indicates a disconnection

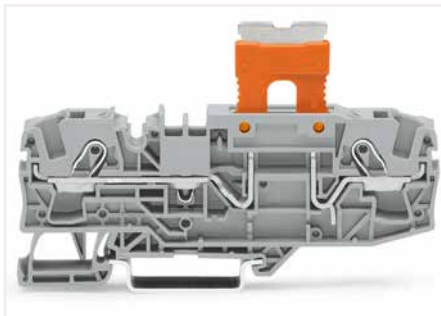

Carrier terminal block (2006-1661) with disconnect plug (2006-401) in parked position

## Lockout Cap TOPJOB® S 2006 Series

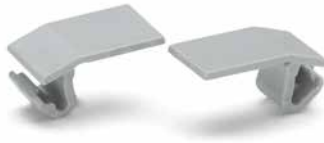

Lockout cap; for conductor entry and operating slot

Color	Item No.	Pack. Unit
○ gray	2006-191	25



Cover (2006-191) seals unused conductor entry.

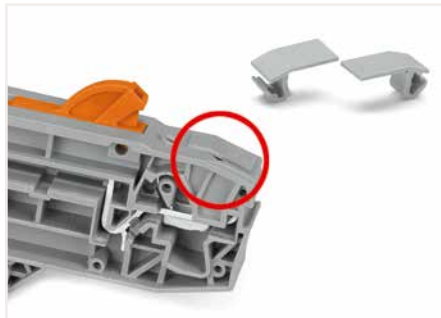

Cover (2006-191) seals unused conductor entry.

# PLUGGABLE RAIL-MOUNT TERMINAL BLOCKS

## X-COM®S-SYSTEM and X-COM®S-SYSTEM-MINI

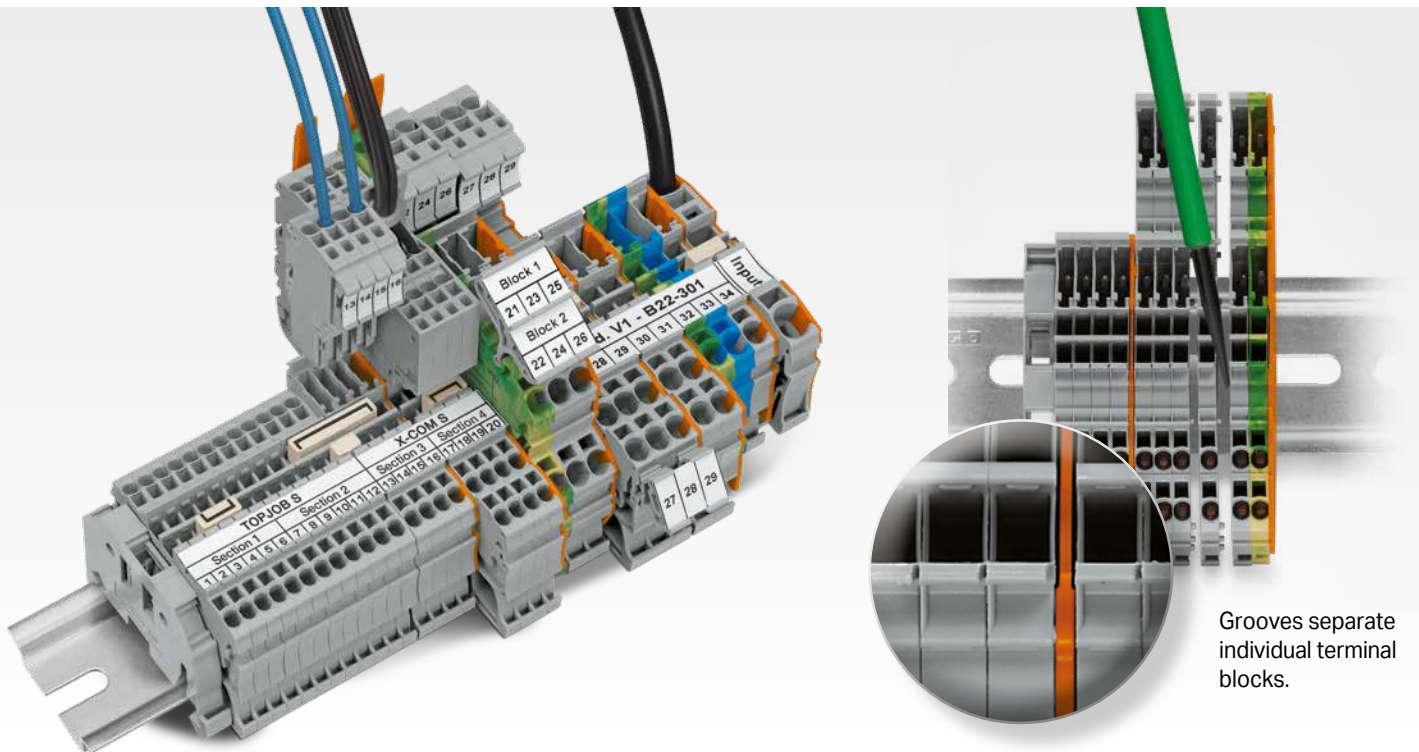

Grooves separate individual terminal blocks.

## X-COM®S-SYSTEM and X-COM®S-SYSTEM-MINI

- COM-bine pluggable connectors and rail-mount terminal blocks
- X-COM®S-SYSTEM (2022 Series): up to 4 mm<sup>2</sup> (12 AWG) at 32 A
- X-COM®S-SYSTEM-MINI (2020 Series): up to 1.5 mm<sup>2</sup> (16 AWG) at just 3.5 mm (0.137 inch) terminal block wide
- Save time and money via pre-assembled components
- Preassembled units can be tested before installation
- Components can be quickly and reliably replaced due to 100% mismatching and touch-proof protection

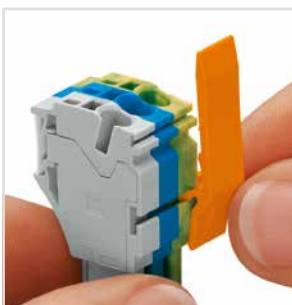

Slide the locking lever into position.

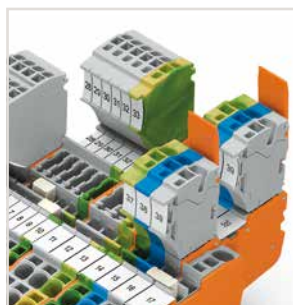

Female plugs can be individually locked.

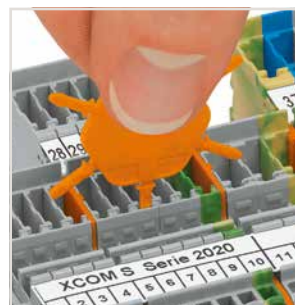

Insert coding pin into the corresponding slot and twist it off.



Remove the coding finger using a cutting tool.



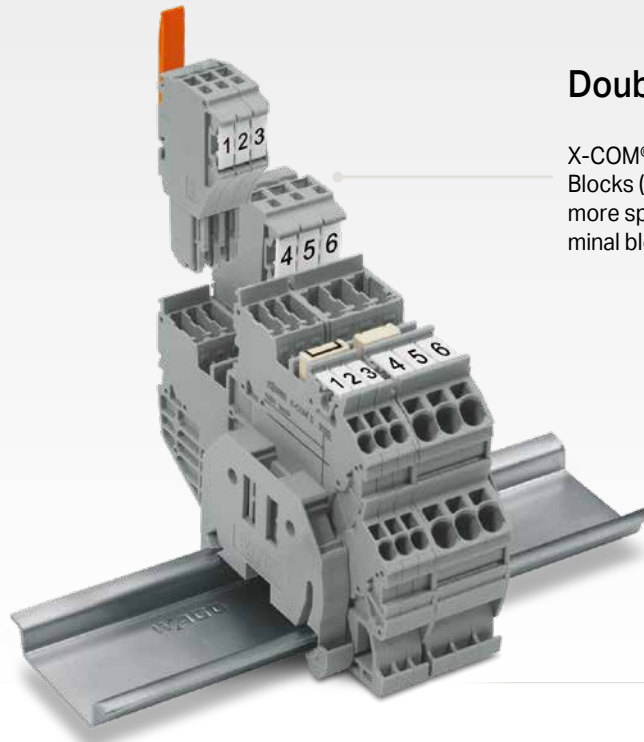

## Double Space Savings

X-COM®S-SYSTEM-MINI Terminal Blocks (3.5 mm wide) – save even more space using double-deck terminal blocks.

- X-COM®S-SYSTEM and X-COM®S-SYSTEM-MINI Female Plugs are modular.
- Female plug assemblies up to a maximum of 15 poles can be customized.
- X-COM®S-SYSTEM-MINI Female Plugs do not have an integrated end plate; an end plate must be used at the end of the carrier terminal block assembly.



X-COM®S-SYSTEM Terminal Blocks can be commoned using Jumpers TOPJOB® S. An end plate provides connection to Terminal Blocks TOPJOB® S. 2020 and 2022 Series Terminal Blocks are combinable.

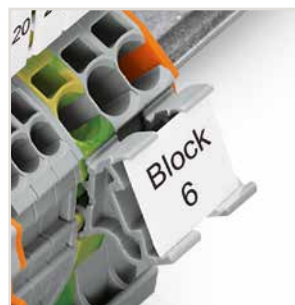

Additional marking option via snap-on type adapter



Test plug adapter (CAT I) for 4 mm test plugs or banana plugs – also suitable for X-COM®S-SYSTEM-MINI Terminal Blocks

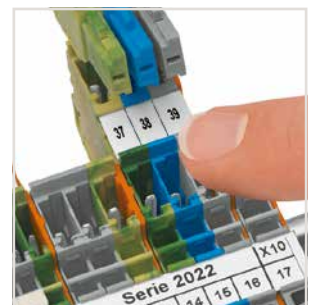

Carrier terminal blocks and female plugs are touch-proof.

# X-COM®S-SYSTEM-MINI; 2020 Series X-COM®S-SYSTEM; 2022 Series Description and Installation

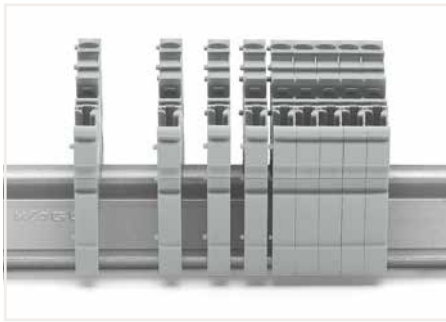

Snap individual carrier terminal blocks onto the DIN-rail and slide together.



Open the assembly by laterally sliding a block via operating tool (3.5 x 0.5 mm blade).

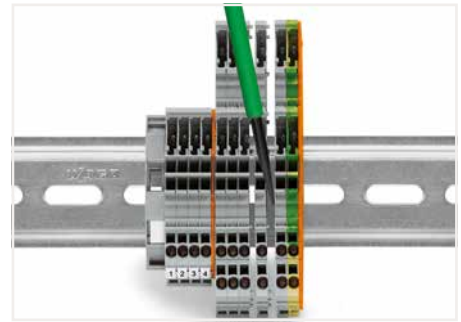

Separate terminal block assembly and slide individual terminal blocks laterally using an operating tool.



Carrier terminal blocks and female plugs are touch-proof.



Push-in CAGE CLAMP® enables solid conductors to be connected by simply pushing them into the unit.

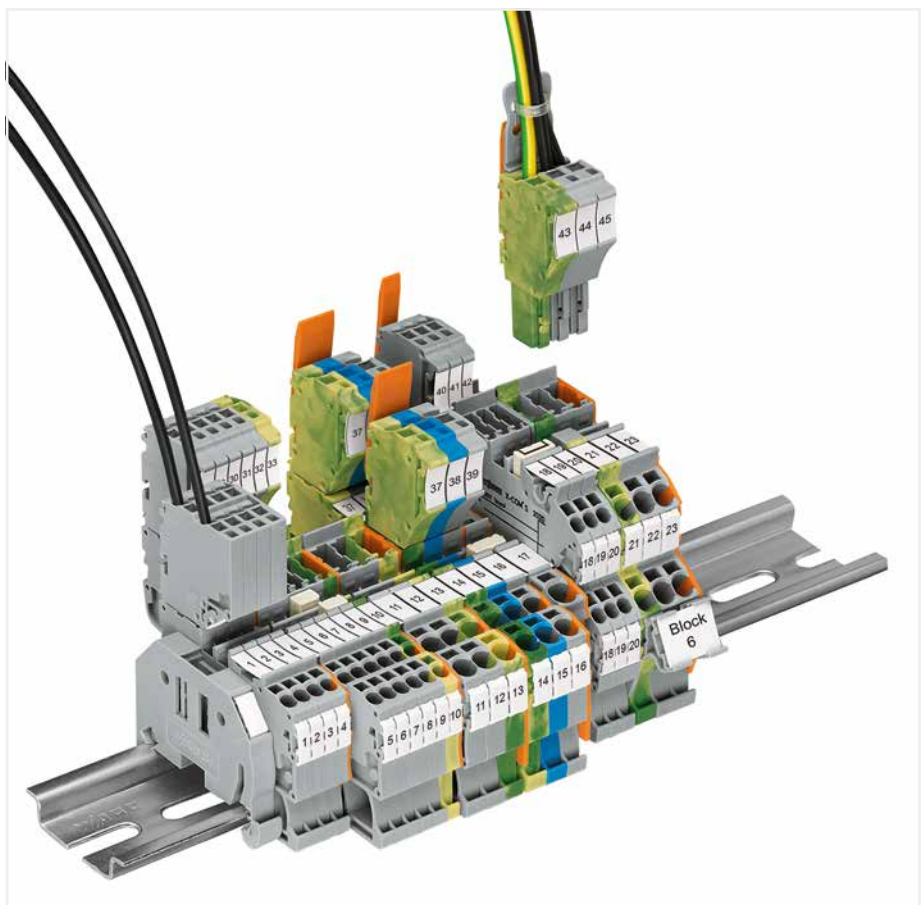

Note: Female plugs used according to the regulations must not be connected/disconnected when live or under load.



Insert coding pin into the corresponding slot and twist it off.



Coding a female plug: remove coding finger using a suitable tool.

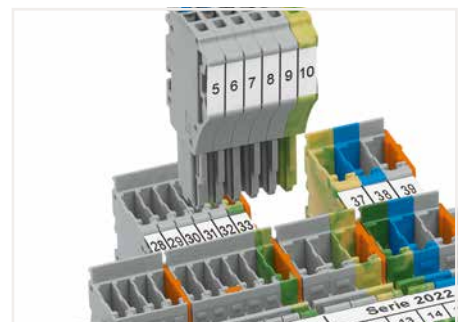

Insert coded female connector into X-COM®S-SYSTEM terminal block assembly.



Push-in CAGE CLAMP® terminates the following copper conductors:  
solid "s"



stranded "st"



fine-stranded "f-st",  
also with tinned  
single strands



**PUSH-IN CAGE CLAMP®**

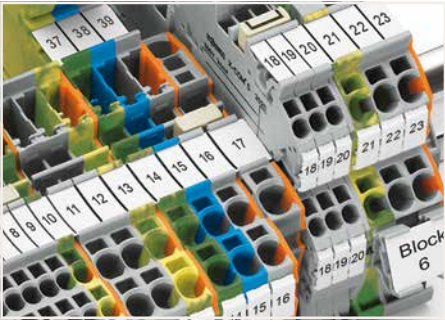

Commoning X-COM®S-SYSTEM Terminal Blocks using jumpers for Terminal Blocks TOPJOB® S. An end plate provides connection to Terminal Blocks TOPJOB® S. 2020 and 2022 Series Terminal Blocks are combinable. Jumper slots are on the same level for both series.

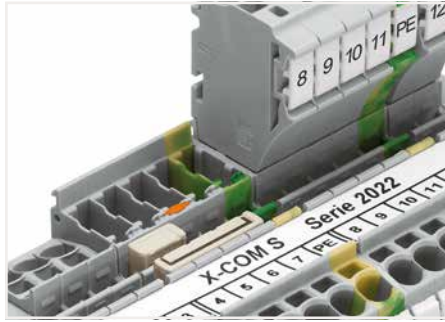

Pairing push-in comb style jumpers.

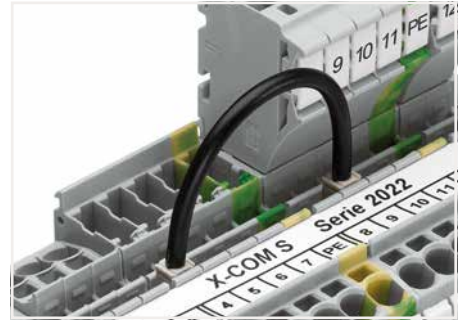

Commoning with push-in type wire jumper.

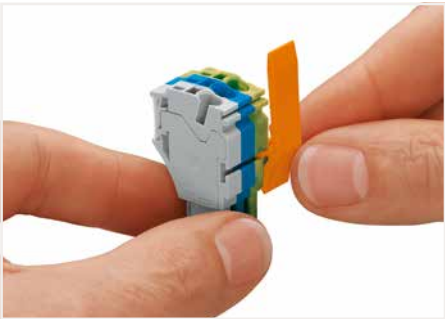

Slide the locking lever into position.



Female plugs can be individually locked.

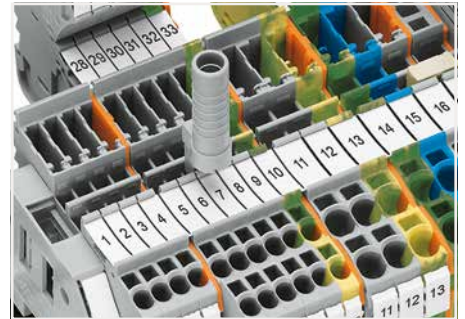

Test plug adapter (2009-174) for 4 mm test plugs or banana plugs – also suitable for X-COM®S-SYSTEM-MINI Terminal Blocks.

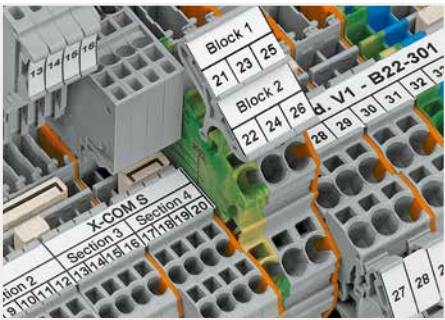

Clear marking via large marking area

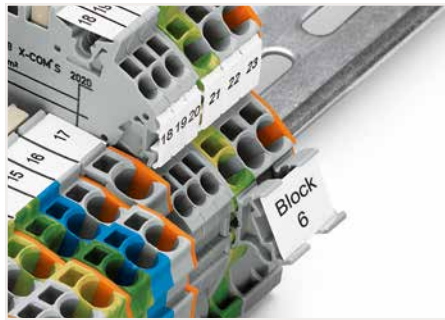

Marker carrier (2009-198)



fine-stranded, tip-bonded





fine-stranded, with ferrule (gastight crimped)



fine-stranded, with pin terminal (gastight crimped)



# 1-Conductor/1-Pin Carrier Terminal Block, 2-Conductor/1-Pin Carrier Terminal Block, 2-Conductor/2-Pin Carrier Terminal Block X-COM®S-SYSTEM-MINI 1 (1.5) mm<sup>2</sup>; 2020 Series



Technical Data	
0.14 ... 1 (1.5) mm <sup>2</sup> ①	24 ... 16 AWG
500 V/6 kV/3 ②	300 V, 10 A ③
I <sub>N</sub> 13.5 A ④	300 V, 10 A ⑤
Terminal block width: 3.5 mm / 0.138 inch	
 9 ... 11 mm / 0.35 ... 0.43 inch	

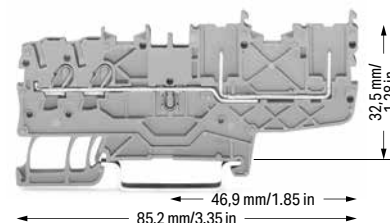
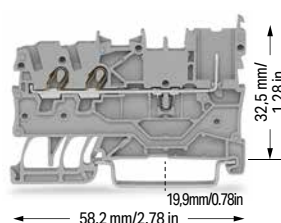
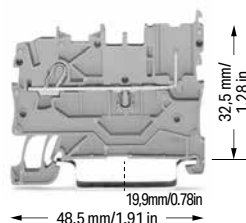

Technical Data	
0.14 ... 1 (1.5) mm <sup>2</sup> ①	24 ... 16 AWG
500 V/6 kV/3 ②	300 V, 10 A ③
I <sub>N</sub> 13.5 A ④	300 V, 10 A ⑤
Terminal block width: 3.5 mm / 0.138 inch	
 9 ... 11 mm / 0.35 ... 0.43 inch	

Technical Data	
0.14 ... 1 (1.5) mm <sup>2</sup> ①	24 ... 16 AWG
500 V/6 kV/3 ②	300 V, 10 A ③
I <sub>N</sub> 13.5 A ④	300 V, 10 A ⑤
Terminal block width: 3.5 mm / 0.138 inch	
 9 ... 11 mm / 0.35 ... 0.43 inch	





1-conductor/1-pin carrier terminal block		
Color	Item No.	Pack. Unit
 gray	2020-1201	50
 blue	2020-1204	50



2-conductor/1-pin carrier terminal block		
Color	Item No.	Pack. Unit
 gray	2020-1301	50
 blue	2020-1304	50



2-conductor/2-pin carrier terminal block		
Color	Item No.	Pack. Unit
 gray	2020-1401	50
 blue	2020-1404	50



1-conductor/1-pin ground carrier terminal block		
 green-yellow	2020-1207	50

2-conductor/1-pin ground carrier terminal block		
 green-yellow	2020-1307	50

2-conductor/2-pin ground carrier terminal block		
 green-yellow	2020-1407	50









Accessories; item-specific			
End and intermediate plate; 1 mm thick			
 orange	2020-1292	100 (25)	
 gray	2020-1291	100 (25)	

Accessories; item-specific			
End and intermediate plate; 1 mm thick			
 orange	2020-1392	100 (25)	
 gray	2020-1391	100 (25)	

Accessories; item-specific			
End and intermediate plate; 1 mm thick			
 orange	2020-1492	100 (25)	
 gray	2020-1491	100 (25)	









## Accessories; 2020 Series



Appropriate marking systems: WMB/WMB Inline/Marking strips

Push-in type jumper bar; insulated; I <sub>N</sub> 14 A; light gray			
 2-way	2000-402	25	
 3-way	2000-403	25	
 4-way	2000-404	25	
 5-way	2000-405	25	
 6-way	2000-406	25	
 7-way	2000-407	25	
 8-way	2000-408	25	
 9-way	2000-409	25	
 10-way	2000-410	25	

Delta jumper; insulated; I <sub>N</sub> = I <sub>N</sub> terminal block; light gray			
 1-2 3-4 5-6	2000-406/020-000	25	

Test plug adapter; for 4 mm Ø test plug			
 gray	2009-174	100 (25)	

Push-in type jumper bar; insulated; I <sub>N</sub> 14 A; light gray			
 1 to 3	2000-433	25	
 1 to 4	2000-434	25	
 1 to 5	2000-435	25	
 1 to 6	2000-436	25	
 1 to 7	2000-437	25	
 1 to 8	2000-438	25	
 1 to 9	2000-439	25	
 1 to 10	2000-440	25	

Push-in type wire jumper; insulated; 0.75 mm <sup>2</sup> conductor cross-section; I <sub>N</sub> 9 A			
 L = 60 mm	2009-402	100 (10)	
 L = 110 mm	2009-404	100 (10)	
 L = 250 mm	2009-406	100 (10)	

Banana plug; for 4 mm socket diameter; color mixed; 10 x orange, white, black, blue, yellow; max. 42 V			
	215-111	50	

Carrier with 6 coding pins; for coding female plugs			
 orange	2020-100	100 (25)	

Testing tap; for max. 2.5 mm <sup>2</sup>			
 gray	2009-182	100 (25)	

Protective warning marker; with black high-voltage symbol; for 5 terminal blocks			
 yellow	2000-115	100 (25)	

Test pin; 1 mm Ø			
	859-500	1	

1-conductor female plug			
 gray	2020-102	100	

2-conductor female plug			
 gray	2020-202	100	

❶ Conductor range: 0.14 ... 1.5 mm<sup>2</sup> "s+f-st";  
Push-in termination: 0.5 ... 1.5 mm<sup>2</sup> "s" and  
0.5 ... 0.75 mm<sup>2</sup> "insulated ferrules; 10 mm"  
Depending on the conductor characteristic, a conduc-  
tor with a smaller cross section can also be inserted  
via push-in termination.

❷ 500 V = rated voltage  
6 kV = rated impulse voltage  
3 = pollution degree

❸ Current-carrying capacity curves upon request

**Note:**

When used as intended, female plugs must not be  
connected/disconnected when live or under load.  
An appropriate end plate must be applied to the  
carrier terminal blocks after each female plug.

Please observe the application notes:

Jumpers, from page 160

Testing accessories, page 159

Marking, from page 246

Approvals and corresponding ratings,  
visit [www.wago.com](http://www.wago.com)

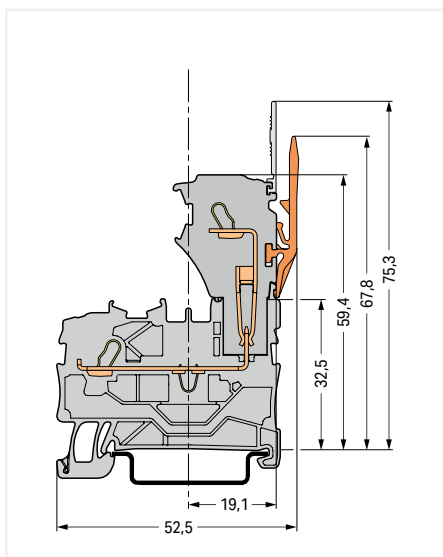

Carrier terminal block

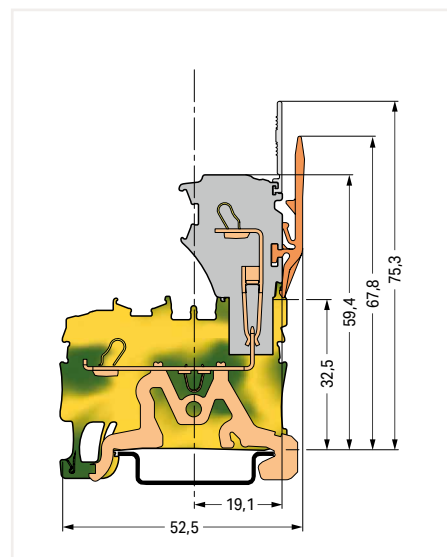

Ground carrier terminal block

**Accessories; 2020 Series**

Appropriate marking systems:  
WMB/WMB Inline/Marking strips

**WMB Inline; plain; 2,300 WMB markers (3.5 mm)/reel**

white 2009-113 1

**WMB marking card; white; 10 strips with 10 markers/card;  
for 3.5 mm terminal block width**

plain 793-3501 5

**Marking strip; plain; 11 mm wide; 50 m reel**

white 2009-110 1

**Screwless end stop; for DIN-35 rail; 6 mm wide**

gray 249-116 100 (25)

**Screwless end stop; for DIN-35 rail; 10 mm wide**

gray 249-117 50 (25)



# 1-Conductor/1-Pin Double-Deck Carrier Terminal Block X-COM®S-SYSTEM-MINI

## 1 (1.5) mm<sup>2</sup>; 2020 Series

Technical Data	
0.14 ... 1 (1.5) mm <sup>2</sup> ①	24 ... 16 AWG
500 V/6 kV/3 ②	300 V, 10 A ③
I <sub>N</sub> 13.5 A ④	300 V, 10 A ⑤
Terminal block width: 3.5 mm / 0.138 inch	
9 ... 11 mm / 0.35 ... 0.43 inch	

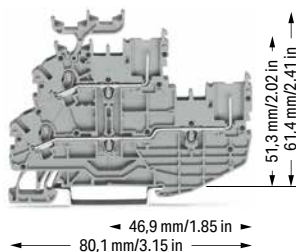

1-conductor/1-pin double-deck carrier terminal block; through/through terminal block; with marker carrier; gray

	Item No.	Pack. Unit
○ L/L	2020-2231	50
○ N/L	2020-2232	50
○ L/N	2020-2233	50

Technical Data	
0.14 ... 1 (1.5) mm <sup>2</sup> ①	24 ... 16 AWG
500 V/6 kV/3 ②	300 V, 10 A ③
I <sub>N</sub> 13.5 A ④	300 V, 10 A ⑤
Terminal block width: 3.5 mm / 0.138 inch	
9 ... 11 mm / 0.35 ... 0.43 inch	

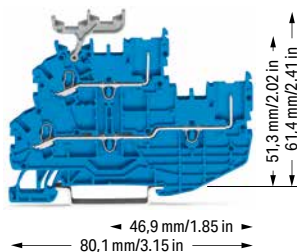

1-conductor/1-pin double-deck carrier terminal block; through/through terminal block; with marker carrier; blue

	Item No.	Pack. Unit
● N/N	2020-2234	50

Technical Data	
0.14 ... 1 (1.5) mm <sup>2</sup> ①	24 ... 16 AWG
500 V/6 kV/3 ②	300 V, 10 A ③
I <sub>N</sub> 13.5 A ④	300 V, 10 A ⑤
Terminal block width: 3.5 mm / 0.138 inch	
9 ... 11 mm / 0.35 ... 0.43 inch	

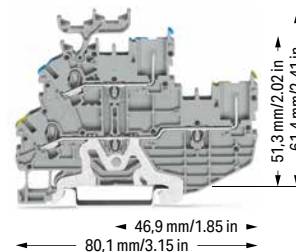

1-conductor/1-pin double-deck carrier terminal block; ground conductor/through terminal block; with marker carrier; gray

	Item No.	Pack. Unit
○ PE/N	2020-2247	50
○ PE/L	2020-2257	50

1-conductor/1-pin double-deck carrier terminal block; through/through terminal block; without marker carrier; gray		
○ L/L	2020-2201	50
○ N/L	2020-2202	50
○ L/N	2020-2203	50

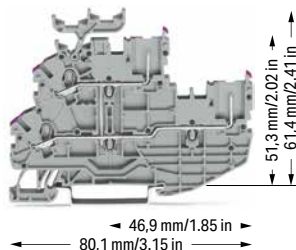

1-conductor/1-pin double-deck carrier terminal block; through/through terminal block; without marker carrier; blue		
● N/N	2020-2204	50

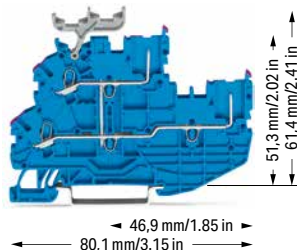

1-conductor/1-pin double-deck carrier terminal block; ground conductor/through terminal block; without marker carrier; gray		
○ PE/N	2020-2217	50
○ PE/L	2020-2227	50

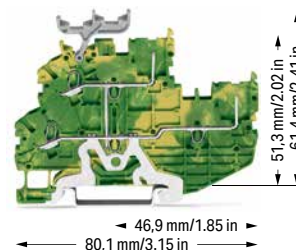

2-conductor/2-pin double-deck carrier terminal block; 2-conductor/2-pin through terminal block; with marker carrier, internally commoned; violet conductor entry; gray		
○ L	2020-2238	50

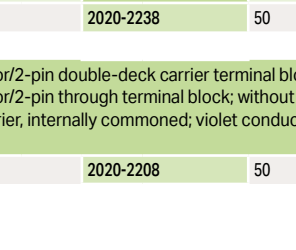

2-conductor/2-pin double-deck carrier terminal block; 2-conductor/2-pin through terminal block; with marker carrier, internally commoned; violet conductor entry; blue		
● N	2020-2239	50

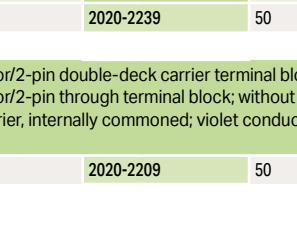

2-conductor/2-pin double-deck carrier block; 2-conductor/2-pin ground conductor block; with marker carrier; internally commoned; green-yellow		
● PE	2020-2237	50

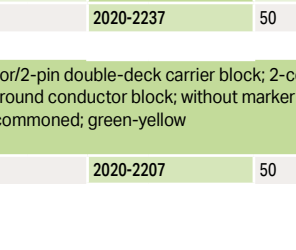

2-conductor/2-pin double-deck carrier terminal block; 2-conductor/2-pin through terminal block; without marker carrier, internally commoned; violet conductor entry; gray		
○ L	2020-2208	50

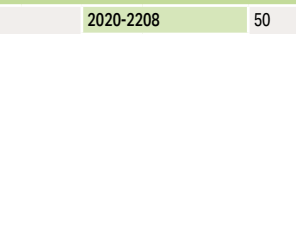

2-conductor/2-pin double-deck carrier terminal block; 2-conductor/2-pin through terminal block; without marker carrier, internally commoned; violet conductor entry; blue		
● N	2020-2209	50

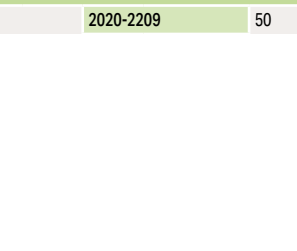

2-conductor/2-pin double-deck carrier block; 2-conductor/2-pin ground conductor block; without marker carrier; internally commoned; green-yellow		
● PE	2020-2207	50

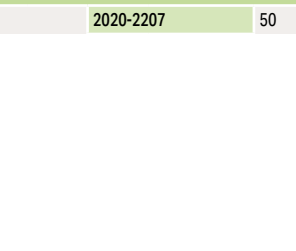

1 Conductor range: 0.14 ... 1.5 mm<sup>2</sup> "s+f-st";  
Push-in termination: 0.5 ... 1.5 mm<sup>2</sup> "s" and  
0.5 ... 0.75 mm<sup>2</sup> "insulated ferrules; 10 mm"  
Depending on the conductor characteristic, a conductor  
with a smaller cross section can also be inserted  
via push-in termination.

2 500 V = rated voltage  
6 kV = rated impulse voltage  
3 = pollution degree

3 Current-carrying capacity curves upon request

**Note:**

When used as intended, female plugs must not be  
connected/disconnected when live or under load.  
An appropriate end plate must be applied to the  
carrier terminal blocks after each female plug.

Please observe the application notes:  
Jumpers, from page 160  
Testing accessories, page 159  
Marking, from page 246

Approvals and corresponding ratings,  
visit [www.wago.com](http://www.wago.com)

**Accessories; 2020 Series**

Appropriate marking systems:  
WMB/WMB Inline/Marking strips

**End and intermediate plate; 1 mm thick**

	orange	2020-2292	100 (25)
	gray	2020-2291	100 (25)

**Push-in type jumper bar; insulated; I<sub>N</sub> 14 A; light gray**

	2-way	2000-402	25
	3-way	2000-403	25
	4-way	2000-404	25
	5-way	2000-405	25
	6-way	2000-406	25
	7-way	2000-407	25
	8-way	2000-408	25
	9-way	2000-409	25
	10-way	2000-410	25

**Push-in type jumper bar; insulated; I<sub>N</sub> 14 A; light gray**

	1 to 3	2000-433	25
	1 to 4	2000-434	25
	1 to 5	2000-435	25
	1 to 6	2000-436	25
	1 to 7	2000-437	25
	1 to 8	2000-438	25
	1 to 9	2000-439	25
	1 to 10	2000-440	25

**Double-deck vertical jumper; insulated; I<sub>N</sub> 13.5 A**

	light gray	2000-492	100 (25)
---	------------	----------	----------

**Protective warning marker; with black high-voltage  
symbol; for 5 terminal blocks**

	yellow	2000-115	100 (25)
---	--------	----------	----------

**Carrier with 6 coding pins; for coding female plugs**

	orange	2020-100	100 (25)
---	--------	----------	----------

**Test pin; 1 mm Ø**

		859-500	1
---	--	---------	---

**Accessories; 2020 Series**

Appropriate marking systems:  
WMB/WMB Inline/Marking strips

**Test plug adapter; for 4 mm Ø test plug**

	gray	2009-174	100 (25)
---	------	----------	----------

**Banana plug; for 4 mm socket diameter; color mixed; 10 x  
orange, white, black, blue, yellow; max. 42 V**

		215-111	50
---	--	---------	----

**Testing tap; for max. 2.5 mm<sup>2</sup>**

	gray	2009-182	100 (25)
---	------	----------	----------

**Test plug; with 500 mm cable; 2 mm Ø; max. 42 V**

	red	210-136	50 (1)
---	-----	---------	--------

**Test plug; with 500 mm cable; 2.3 mm Ø; max. 42 V**

	yellow	210-137	50 (1)
---	--------	---------	--------

**1-conductor female plug**

	gray	2020-102	100
--	------	----------	-----

**2-conductor female plug**

	gray	2020-202	100
---	------	----------	-----

**WMB Inline; plain; 2,300 WMB markers (3.5 mm)/reel**

	white	2009-113	1
---	-------	----------	---

**WMB marking card; white; 10 strips with 10 markers/card;  
for 3.5 mm terminal block width**

	plain	793-3501	5
---	-------	----------	---

**Marking strip; plain; 11 mm wide; 50 m reel**

	white	2009-110	1
---	-------	----------	---

**Double-deck marker carrier; pivoting**

	gray	2000-121	50 (25)
---	------	----------	---------



Size comparison:  
Double-deck carrier terminal blocks with 3.5 mm and  
5.2 mm terminal block widths

# 1-Conductor Female Plug, 2-Conductor Female Plug X-COM®S-SYSTEM-MINI

## 1 (1.5) mm<sup>2</sup>; 2020 Series

Technical Data	
0.14 ... 1 (1.5) mm <sup>2</sup> ①	24 ... 16 AWG
500 V/6 kV/3 ②	300 V, 10 A ③
I <sub>N</sub> 13.5 A ③	300 V, 10 A ③
Module width: 3.5 mm / 0.138 inch	
9 ... 11 mm / 0.35 ... 0.43 inch	



Technical Data	
0.14 ... 1 (1.5) mm <sup>2</sup> ①	24 ... 16 AWG
500 V/6 kV/3 ②	300 V, 10 A ③
I <sub>N</sub> 13.5 A ③	300 V, 10 A ③
Module width: 3.5 mm / 0.138 inch	
9 ... 11 mm / 0.35 ... 0.43 inch	



① Conductor range: 0.14 ... 1.5 mm<sup>2</sup> "s+f-st"; Push-in termination: 0.5 ... 1.5 mm<sup>2</sup> "s" and 0.5 ... 0.75 mm<sup>2</sup> "insulated ferrules; 10 mm" Depending on the conductor characteristic, a conductor with a smaller cross section can also be inserted via push-in termination.

② 500 V = rated voltage  
6 kV = rated impulse voltage  
3 = pollution degree

③ Current-carrying capacity curves upon request

Item no. suffixes

blue .../000-006

green-yellow .../000-016

Approvals and corresponding ratings, visit [www.wago.com](http://www.wago.com)

Dimensions (in mm):

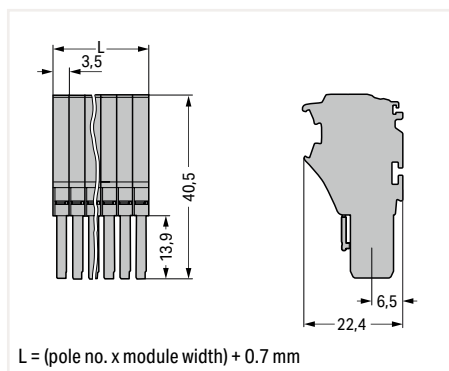

Dimensions (in mm):

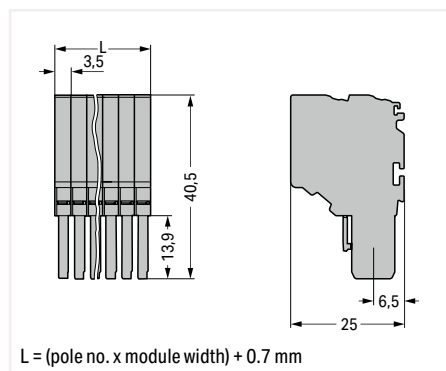

1-conductor female plug; fits into carrier terminal blocks; codable; gray  
According to EN 61984, pluggable connectors without a current interrupting capacity must not be mated or unmated when live or under load.  
Notice: An appropriate end plate must be applied to the carrier terminal blocks after each female plug.

Pole No.	Item No.	Pack. Unit
○ 2	2020-102	100
○ 3	2020-103	50
○ 4	2020-104	50
○ 5	2020-105	50
○ 6	2020-106	50
○ 7	2020-107	25
○ 8	2020-108	25
○ 9	2020-109	25
○ 10	2020-110	25
○ 11	2020-111	20
○ 12	2020-112	20
○ 13	2020-113	10
○ 14	2020-114	10
○ 15	2020-115	10

2-conductor female plug; fits into carrier terminal blocks; codable; gray  
According to EN 61984, pluggable connectors without a current interrupting capacity must not be mated or unmated when live or under load.  
Notice: An appropriate end plate must be applied to the carrier terminal blocks after each female plug.

Pole No.	Item No.	Pack. Unit
○ 2	2020-202	100
○ 3	2020-203	50
○ 4	2020-204	50
○ 5	2020-205	50
○ 6	2020-206	25
○ 7	2020-207	25
○ 8	2020-208	25
○ 9	2020-209	25
○ 10	2020-210	25
○ 11	2020-211	20
○ 12	2020-212	20
○ 13	2020-213	10
○ 14	2020-214	10
○ 15	2020-215	10

### Accessories; for female plugs

Appropriate marking systems: WMB/WMB Inline/Marking strips

Protective warning marker; with black high-voltage symbol; for 5 terminal blocks

yellow 2000-115 100 (25)



Locking lever; 4.8 mm wide

orange 2022-142 100 (25)

gray 2022-141 100 (25)



Carrier with 6 coding pins; for coding female plugs

orange 2020-100 100 (25)



Locking lever; 9.6 mm wide

orange 2022-152 100 (25)

gray 2022-151 100 (25)



X-COM®S-SYSTEM terminal block assembly



X-COM®S-SYSTEM terminal block assembly

## Carrier Terminal Blocks and 1-/2-Conductor Female Plugs X-COM®S-SYSTEM-MINI Types of Assembly



1-conductor female plug  
Carrier terminal blocks can be commoned via 2000 Series Push-In Type Jumper Bars and tested via 859-500 Test Pin.

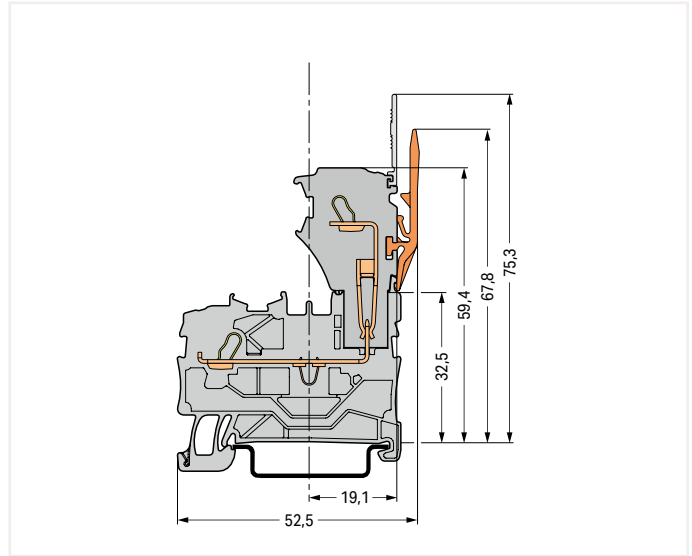

Carrier terminal block

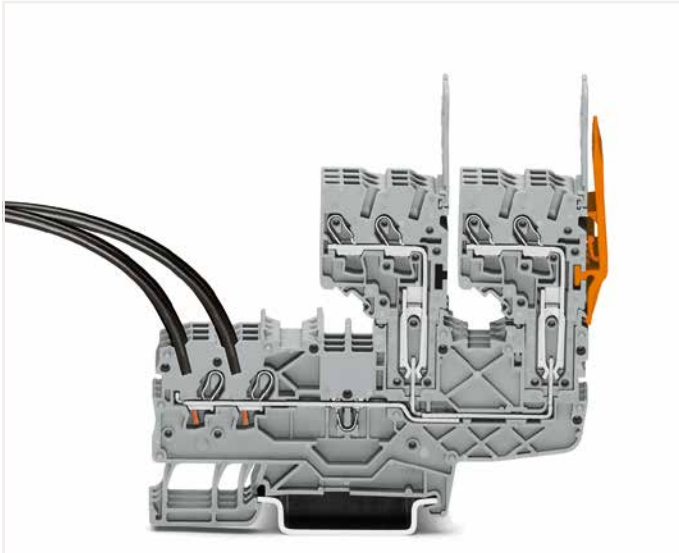

2-conductor female plug  
Carrier terminal blocks can be commoned via 2000 Series Push-In Type Jumper Bars and tested via 859-500 Test Pin.

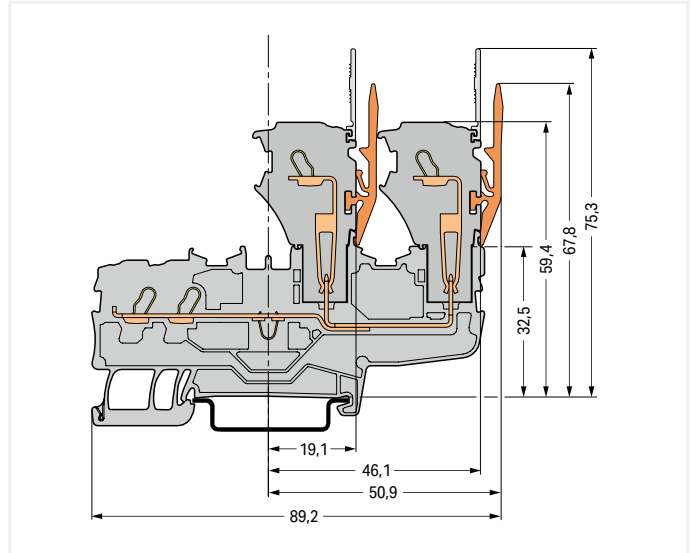

Carrier terminal block

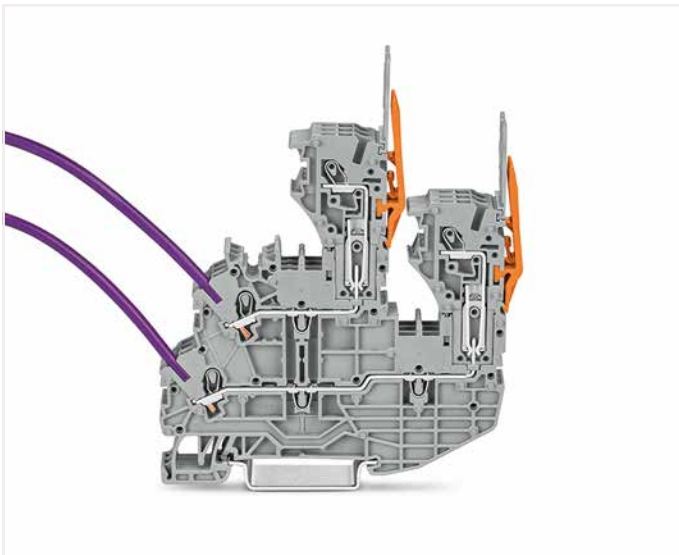

1-conductor female plug  
Double-deck carrier terminal blocks can be commoned via 2000 Series Push-In Type Jumper Bars and tested via 859-500 Test Pin.

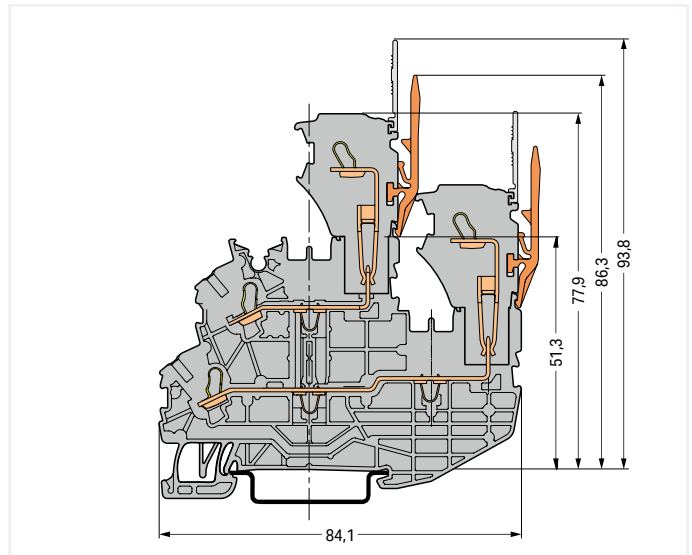

Double-deck carrier terminal block

## Female Plug for Self-Assembly X-COM®S-SYSTEM-MINI 1 (1.5) mm<sup>2</sup>; 2020 Series

### Technical Data

0.14 ... 1 (1.5) mm <sup>2</sup> ①	24 ... 16 AWG
500 V/6 kV/3 ②	300 V, 10 A ③
I <sub>N</sub> 13.5 A ③	300 V, 10 A ③
Terminal block width: 3.5 mm / 0.138 inch	
 9 ... 11 mm / 0.35 ... 0.43 inch	

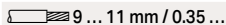

### Technical Data

0.14 ... 1 (1.5) mm <sup>2</sup> ①	24 ... 16 AWG
500 V/6 kV/3 ②	300 V, 10 A ③
I <sub>N</sub> 13.5 A ③	300 V, 10 A ③
Terminal block width: 3.5 mm / 0.138 inch	
 9 ... 11 mm / 0.35 ... 0.43 inch	



① Conductor range: 0.14 ... 1.5 mm<sup>2</sup> "s+f-st"; Push-in termination: 0.5 ... 1.5 mm<sup>2</sup> "s" and 0.5 ... 0.75 mm<sup>2</sup> "insulated ferrules; 10 mm" Depending on the conductor characteristic, a conductor with a smaller cross section can also be inserted via push-in termination.

② 500 V = rated voltage  
6 kV = rated impulse voltage  
3 = pollution degree

③ Current-carrying capacity curves upon request



#### Note:

According to EN 61984, pluggable connectors without a current interrupting capacity must not be mated or unmated when live or under load.



Notice: An appropriate end plate must be applied to the carrier terminal blocks after each female plug.

Approvals and corresponding ratings, visit [www.wago.com](http://www.wago.com)

### 1-conductor end module; codable

Color	Item No.	Pack. Unit
 gray	2020-181	250
 blue	2020-184	250
 green-yellow	2020-187	250



### 2-conductor end module; codable

Color	Item No.	Pack. Unit
 gray	2020-281	250
 blue	2020-284	250
 green-yellow	2020-287	250

### 1-conductor base module; with end plate; codable

 gray	2020-161	250
 blue	2020-164	250
 green-yellow	2020-167	250

### 2-conductor base module; with end plate; codable

 gray	2020-261	250
 blue	2020-264	250
 green-yellow	2020-267	250

### Accessories; for female plugs

Appropriate marking systems: WMB/WMB Inline/Marking strips

#### Protective warning marker; with black high-voltage symbol; for 5 terminal blocks

yellow	2000-115	100 (25)
--------	----------	----------



#### WMB Inline; plain; 2,300 WMB markers (3.5 mm)/reel

white	2009-113	1
-------	----------	---



#### Carrier with 6 coding pins; for coding female plugs

orange	2020-100	100 (25)
--------	----------	----------



#### WMB marking card; white; 10 strips with 10 markers/card; for 3.5 mm terminal block width

plain	793-3501	5
-------	----------	---



#### Locking lever; 4.8 mm wide

orange	2022-142	100 (25)
gray	2022-141	100 (25)



#### Marking strip; plain; 11 mm wide; 50 m reel

white	2009-110	1
-------	----------	---



#### Locking lever; 9.6 mm wide

orange	2022-152	100 (25)
gray	2022-151	100 (25)



#### Strain relief plate; gray

35 mm wide	734-326	100 (25)
6 mm wide	734-327	100 (25)
12.5 mm wide	734-328	100 (25)
25 mm wide	734-329	100 (25)





**Customizing Modular Female Plugs**

WAGO's modular X-COM®S-SYSTEM female plugs can be customized for applications requiring varying numbers of poles (e.g., when designing prototypes).

**Modules and Pole Numbers**

A customized X-COM®S-SYSTEM-MINI female plug consists of:

- One base module with end plate
- Up to 14 end modules

**Intended Use**

According to EN 61984, pluggable connectors without a current interrupting capacity must not be mated or unmated when live or under load.

**Mounting**

The appropriate mounting tool shall be used in order to guarantee that the individual modules are properly attached to each other without damaging the locking latches.





End module



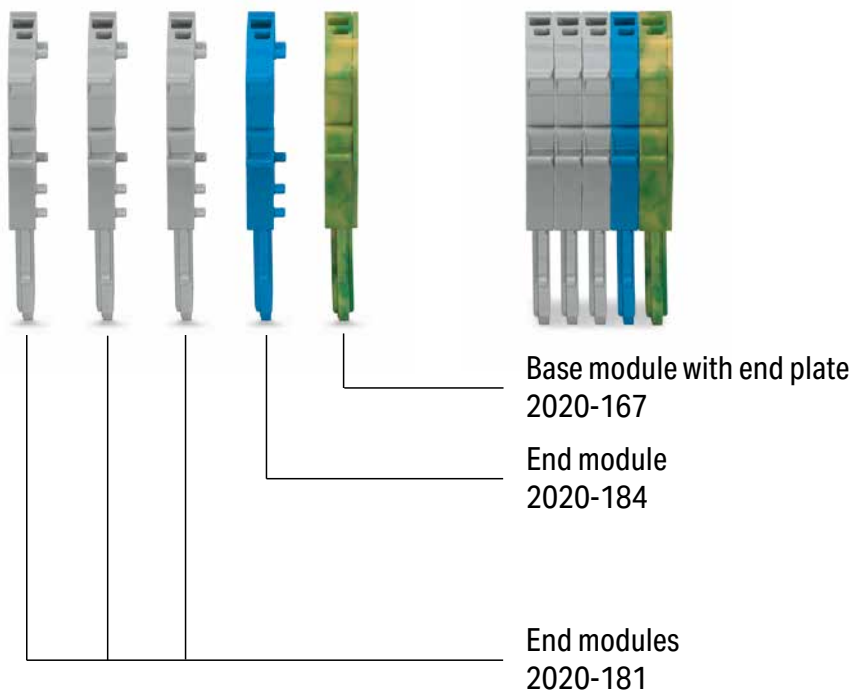





Base module

**Example: 5-Pole, 1-Conductor Female Plug**

## Pre-Assembled 1-Conductor Female Plug X-COM®S-SYSTEM-MINI 1 (1.5) mm<sup>2</sup>; 2020 Series

Technical Data	
0.14 ... 1 (1.5) mm <sup>2</sup> ①	24 ... 16 AWG
500 V/6 kV/3 ②	300 V, 10 A 
I <sub>N</sub> 13.5 A ③	300 V, 10 A 
Module width: 3.5 mm / 0.138 inch	
 9 ... 11 mm / 0.35 ... 0.43 inch	

Technical Data	
0.14 ... 1 (1.5) mm <sup>2</sup> ①	24 ... 16 AWG
500 V/6 kV/3 ②	300 V, 10 A 
I <sub>N</sub> 13.5 A ③	300 V, 10 A 
Module width: 3.5 mm / 0.138 inch	
 9 ... 11 mm / 0.35 ... 0.43 inch	

Technical Data	
0.14 ... 1 (1.5) mm <sup>2</sup> ①	24 ... 16 AWG
500 V/6 kV/3 ②	300 V, 10 A 
I <sub>N</sub> 13.5 A ③	300 V, 10 A 
Module width: 3.5 mm / 0.138 inch	
 9 ... 11 mm / 0.35 ... 0.43 inch	



1-conductor female plug; with ground base module (green-yellow); fits into carrier terminal blocks; codable		
Pole No.	Item No.	Pack. Unit
3	2020-103/000-036	50
4	2020-104/000-036	50
5	2020-105/000-036	50
6	2020-106/000-036	50
7	2020-107/000-036	25
8	2020-108/000-036	25
9	2020-109/000-036	25
10	2020-110/000-036	25
11	2020-111/000-036	20
12	2020-112/000-036	20
13	2020-113/000-036	10
14	2020-114/000-036	10
15	2020-115/000-036	10

1-conductor female plug; with ground end module (green-yellow); fits into carrier terminal blocks; codable		
Pole No.	Item No.	Pack. Unit
3	2020-103/000-037	50
4	2020-104/000-037	50
5	2020-105/000-037	50
6	2020-106/000-037	50
7	2020-107/000-037	25
8	2020-108/000-037	25
9	2020-109/000-037	25
10	2020-110/000-037	25
11	2020-111/000-037	20
12	2020-112/000-037	20
13	2020-113/000-037	10
14	2020-114/000-037	10
15	2020-115/000-037	10

1-conductor female plug; with ground base module (green-yellow); fits into carrier terminal blocks; codable		
Pole No.	Item No.	Pack. Unit
3	2020-103/000-038	50
4	2020-104/000-038	50
5	2020-105/000-038	50
6	2020-106/000-038	50
7	2020-107/000-038	25
8	2020-108/000-038	25
9	2020-109/000-038	25
10	2020-110/000-038	25
11	2020-111/000-038	20
12	2020-112/000-038	20
13	2020-113/000-038	10
14	2020-114/000-038	10
15	2020-115/000-038	10

### Accessories; for female plugs

Appropriate marking systems: WMB/WMB Inline/Marking strips

Protective warning marker; with black high-voltage symbol; for 5 terminal blocks		
yellow	2000-115	100 (25)



Carrier with 6 coding pins; for coding female plugs		
orange	2020-100	100 (25)



Locking lever; 4.8 mm wide		
orange	2022-142	100 (25)
gray	2022-141	100 (25)



Locking lever; 9.6 mm wide		
orange	2022-152	100 (25)
gray	2022-151	100 (25)



Strain relief plate; gray			
35 mm wide	734-326	100 (25)	
6 mm wide	734-327	100 (25)	
12.5 mm wide	734-328	100 (25)	
25 mm wide	734-329	100 (25)	



WMB Inline; plain; 2,300 WMB markers (3.5 mm)/reel			
white	2009-113	1	



WMB marking card; white; 10 strips with 10 markers/card; for 3.5 mm terminal block width			
plain	793-3501	5	



Marking strip; plain; 11 mm wide; 50 m reel			
white	2009-110	1	



## Technical Data

0.14 ... 1 (1.5) mm<sup>2</sup> ① | 24 ... 16 AWG

500 V/6 kV/3 ② | 300 V, 10 A ③

I<sub>N</sub> 13.5 A ③ | 300 V, 10 A ③

Module width: 3.5 mm / 0.138 inch

9 ... 11 mm / 0.35 ... 0.43 inch



① Conductor range: 0.14 ... 1.5 mm<sup>2</sup> "s+f-st";  
Push-in termination: 0.5 ... 1.5 mm<sup>2</sup> "s" and  
0.5 ... 0.75 mm<sup>2</sup> "insulated ferrules; 10 mm"  
Depending on the conductor characteristic, a conduc-  
tor with a smaller cross section can also be inserted  
via push-in termination.

② 500 V = rated voltage  
6 kV = rated impulse voltage  
3 = pollution degree

③ Current-carrying capacity curves upon request

**Note:**

According to EN 61984, pluggable connectors without  
a current interrupting capacity must not be mated or  
unmated when live or under load.

Notice: An appropriate end plate must be applied to  
the carrier terminal blocks after each female plug.

Approvals and corresponding ratings,  
visit [www.wago.com](http://www.wago.com)

1-conductor female plug; with ground end module  
(green-yellow); fits into carrier terminal blocks; codable

Pole No.	Item No.	Pack. Unit
3	2020-103/000-039	50
4	2020-104/000-039	50
5	2020-105/000-039	50
6	2020-106/000-039	50
7	2020-107/000-039	25
8	2020-108/000-039	25
9	2020-109/000-039	25
10	2020-110/000-039	25
11	2020-111/000-039	20
12	2020-112/000-039	20
13	2020-113/000-039	10
14	2020-114/000-039	10
15	2020-115/000-039	10

Sold & Serviced By:

 **ELECTROMATE**

Toll Free Phone (877) SERV098  
[www.electromate.com](http://www.electromate.com)  
[sales@electromate.com](mailto:sales@electromate.com)

## Pre-Assembled 2-Conductor Female Plug X-COM®S-SYSTEM-MINI 1 (1.5) mm<sup>2</sup>; 2020 Series

Technical Data	
0.14 ... 1 (1.5) mm <sup>2</sup> ①	24 ... 16 AWG
500 V/6 kV/3 ②	300 V, 10 A ③
I <sub>N</sub> 13.5 A ④	300 V, 10 A ⑤
Module width: 3.5 mm / 0.138 inch	
9 ... 11 mm / 0.35 ... 0.43 inch	

Technical Data	
0.14 ... 1 (1.5) mm <sup>2</sup> ①	24 ... 16 AWG
500 V/6 kV/3 ②	300 V, 10 A ③
I <sub>N</sub> 13.5 A ④	300 V, 10 A ⑤
Module width: 3.5 mm / 0.138 inch	
9 ... 11 mm / 0.35 ... 0.43 inch	

Technical Data	
0.14 ... 1 (1.5) mm <sup>2</sup> ①	24 ... 16 AWG
500 V/6 kV/3 ②	300 V, 10 A ③
I <sub>N</sub> 13.5 A ④	300 V, 10 A ⑤
Module width: 3.5 mm / 0.138 inch	
9 ... 11 mm / 0.35 ... 0.43 inch	

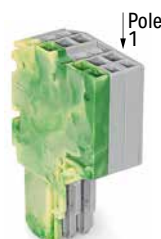

2-conductor female plug; with ground base module (green-yellow); fits into carrier terminal blocks; codable		
Pole No.	Item No.	Pack. Unit
3	2020-203/000-036	50
4	2020-204/000-036	50
5	2020-205/000-036	50
6	2020-206/000-036	50
7	2020-207/000-036	25
8	2020-208/000-036	25
9	2020-209/000-036	25
10	2020-210/000-036	25
11	2020-211/000-036	20
12	2020-212/000-036	20
13	2020-213/000-036	10
14	2020-214/000-036	10
15	2020-215/000-036	10

2-conductor female plug; with ground end module (green-yellow); fits into carrier terminal blocks; codable		
Pole No.	Item No.	Pack. Unit
3	2020-203/000-037	50
4	2020-204/000-037	50
5	2020-205/000-037	50
6	2020-206/000-037	50
7	2020-207/000-037	25
8	2020-208/000-037	25
9	2020-209/000-037	25
10	2020-210/000-037	25
11	2020-211/000-037	20
12	2020-212/000-037	20
13	2020-213/000-037	10
14	2020-214/000-037	10
15	2020-215/000-037	10

2-conductor female plug; with ground base module (green-yellow); fits into carrier terminal blocks; codable		
Pole No.	Item No.	Pack. Unit
3	2020-203/000-038	50
4	2020-204/000-038	50
5	2020-205/000-038	50
6	2020-206/000-038	50
7	2020-207/000-038	25
8	2020-208/000-038	25
9	2020-209/000-038	25
10	2020-210/000-038	25
11	2020-211/000-038	20
12	2020-212/000-038	20
13	2020-213/000-038	10
14	2020-214/000-038	10
15	2020-215/000-038	10

### Accessories; for female plugs

Appropriate marking systems: WMB/WMB Inline/Marking strips

Protective warning marker; with black high-voltage symbol; for 5 terminal blocks		
yellow	2000-115	100 (25)



Carrier with 6 coding pins; for coding female plugs		
orange	2020-100	100 (25)



Locking lever; 4.8 mm wide		
orange	2022-142	100 (25)
gray	2022-141	100 (25)



Locking lever; 9.6 mm wide		
orange	2022-152	100 (25)
gray	2022-151	100 (25)



Strain relief plate; gray			
35 mm wide	734-326	100 (25)	
6 mm wide	734-327	100 (25)	
12.5 mm wide	734-328	100 (25)	
25 mm wide	734-329	100 (25)	



WMB Inline; plain; 2,300 WMB markers (3.5 mm)/reel		
white	2009-113	1



WMB marking card; white; 10 strips with 10 markers/card; for 3.5 mm terminal block width		
plain	793-3501	5



Marking strip; plain; 11 mm wide; 50 m reel		
white	2009-110	1



## Technical Data

0.14 ... 1 (1.5) mm <sup>2</sup> ①	24 ... 16 AWG
500 V/6 kV/3 ②	300 V, 10 A ③
I <sub>N</sub> 13.5 A ③	300 V, 10 A ③
Module width: 3.5 mm / 0.138 inch	
9 ... 11 mm / 0.35 ... 0.43 inch	

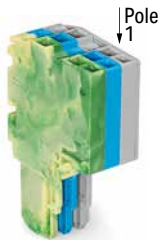

① Conductor range: 0.14 ... 1.5 mm<sup>2</sup> "s+f-st";  
Push-in termination: 0.5 ... 1.5 mm<sup>2</sup> "s" and  
0.5 ... 0.75 mm<sup>2</sup> "insulated ferrules; 10 mm"  
Depending on the conductor characteristic, a conductor  
with a smaller cross section can also be inserted  
via push-in termination.

② 500 V = rated voltage  
6 kV = rated impulse voltage  
3 = pollution degree

③ Current-carrying capacity curves upon request

**Note:**

According to EN 61984, pluggable connectors without  
a current interrupting capacity must not be mated or  
unmated when live or under load.

Notice: An appropriate end plate must be applied to  
the carrier terminal blocks after each female plug.

Approvals and corresponding ratings,  
visit [www.wago.com](http://www.wago.com)

2-conductor female plug; with ground end module  
(green-yellow); fits into carrier terminal blocks; codable

Pole No.	Item No.	Pack. Unit
3	2020-203/000-039	50
4	2020-204/000-039	50
5	2020-205/000-039	50
6	2020-206/000-039	50
7	2020-207/000-039	25
8	2020-208/000-039	25
9	2020-209/000-039	25
10	2020-210/000-039	25
11	2020-211/000-039	20
12	2020-212/000-039	20
13	2020-213/000-039	10
14	2020-214/000-039	10
15	2020-215/000-039	10



# 1-Conductor Female Plug X-COM®S-SYSTEM-MINI; with Lateral Locking Lever and Strain Relief Plate

## 1 (1.5) mm<sup>2</sup>; 2020 Series

Technical Data	
0.14 ... 1 (1.5) mm <sup>2</sup> ①	24 ... 16 AWG
500 V/6 kV/3 ②	300 V, 10 A ③
I <sub>N</sub> 13.5 A ④	300 V, 10 A ⑤
Module width: 3.5 mm / 0.138 inch	
9 ... 11 mm / 0.35 ... 0.43 inch	

Technical Data	
0.14 ... 1 (1.5) mm <sup>2</sup> ①	24 ... 16 AWG
500 V/6 kV/3 ②	300 V, 10 A ③
I <sub>N</sub> 13.5 A ④	300 V, 10 A ⑤
Module width: 3.5 mm / 0.138 inch	
9 ... 11 mm / 0.35 ... 0.43 inch	

Technical Data	
0.14 ... 1 (1.5) mm <sup>2</sup> ①	24 ... 16 AWG
500 V/6 kV/3 ②	300 V, 10 A ③
I <sub>N</sub> 13.5 A ④	300 V, 10 A ⑤
Module width: 3.5 mm / 0.138 inch	
9 ... 11 mm / 0.35 ... 0.43 inch	



1-conductor female plug; with locking lever; fits into carrier terminal blocks; codable; gray

Pole No.	Item No.	Pack. Unit
○ 2	2020-102/122-000	100
○ 3	2020-103/122-000	50
○ 4	2020-104/124-000	50
○ 5	2020-105/124-000	50
○ 6	2020-106/124-000	25
○ 7	2020-107/124-000	25
○ 8	2020-108/124-000	25
○ 9	2020-109/124-000	25
○ 10	2020-110/125-000	25
○ 11	2020-111/125-000	20
○ 12	2020-112/125-000	20
○ 13	2020-113/125-000	10
○ 14	2020-114/125-000	10
○ 15	2020-115/125-000	10

1-conductor female plug; with strain relief plate; fits into carrier terminal blocks; codable; gray

Pole No.	Item No.	Pack. Unit
○ 2	2020-102/132-000	100
○ 3	2020-103/132-000	50
○ 4	2020-104/133-000	50
○ 5	2020-105/133-000	50
○ 6	2020-106/133-000	25
○ 7	2020-107/134-000	25
○ 8	2020-108/134-000	25
○ 9	2020-109/134-000	25
○ 10	2020-110/135-000	25
○ 11	2020-111/135-000	20
○ 12	2020-112/135-000	20
○ 13	2020-113/135-000	10
○ 14	2020-114/135-000	10
○ 15	2020-115/135-000	10

1-conductor female plug; with strain relief plate and locking lever; fits into carrier terminal blocks; codable; gray

Pole No.	Item No.	Pack. Unit
○ 2	2020-102/142-000	100
○ 3	2020-103/142-000	50
○ 4	2020-104/143-000	50
○ 5	2020-105/143-000	50
○ 6	2020-106/143-000	25
○ 7	2020-107/144-000	25
○ 8	2020-108/144-000	25
○ 9	2020-109/144-000	25
○ 10	2020-110/145-000	25
○ 11	2020-111/145-000	20
○ 12	2020-112/145-000	20
○ 13	2020-113/145-000	10
○ 14	2020-114/145-000	10
○ 15	2020-115/145-000	10

### Accessories; for female plugs

Appropriate marking systems: WMB/WMB Inline/Marking strips

Protective warning marker; with black high-voltage symbol; for 5 terminal blocks  
yellow 2000-115 100 (25)



Carrier with 6 coding pins; for coding female plugs  
orange 2020-100 100 (25)



WMB Inline; plain; 2,300 WMB markers (3.5 mm)/reel  
white 2009-113 1



Marking strip; plain; 11 mm wide; 50 m reel  
white 2009-110 1



WMB marking card; white; 10 strips with 10 markers/card; for 3.5 mm terminal block width  
plain 793-3501 5



❶ Conductor range: 0.14 ... 1.5 mm<sup>2</sup> "s+f-st";  
 Push-in termination: 0.5 ... 1.5 mm<sup>2</sup> "s" and  
 0.5 ... 0.75 mm<sup>2</sup> "insulated ferrules; 10 mm"  
 Depending on the conductor characteristic, a conductor  
 with a smaller cross section can also be inserted  
 via push-in termination.

❷ 500 V = rated voltage  
 6 kV = rated impulse voltage  
 3 = pollution degree

❸ Current-carrying capacity curves upon request

**Note:**  
 According to EN 61984, pluggable connectors without  
 a current interrupting capacity must not be mated or  
 unmated when live or under load.  
 Notice: An appropriate end plate must be applied to  
 the carrier terminal blocks after each female plug.

Approvals and corresponding ratings,  
 visit [www.wago.com](http://www.wago.com)

Strain Relief Plate (SRP), Gray				Locking Lever (LL), Gray				SRP and LL, Gray
Assembled				Assembled				Assembled
SRP				Pole No.	Quantity	1-Way	2-Way	
Item No. Suffix				Item No. Suffix				Item No. Suffix
Item No.	Color	Width						
734-327	gray	6mm	/132-0xx	2 to 3	1	/122-0xx	-	/142-0xx
734-328	gray	12.5mm	/133-0xx	4 to 6	1	-	/124-0xx	/143-0xx
734-329	gray	25mm	/134-0xx	7 to 9	1	-	/124-0xx	/144-0xx
734-326	gray	35mm	/135-0xx	10 to 15	2	-	/125-0xx	/145-0xx

For colored female plugs, the item number suffix "xx" must be replaced by the blue "-006" and the green-yellow "-016" color suffix.

Dimensions of locking levers

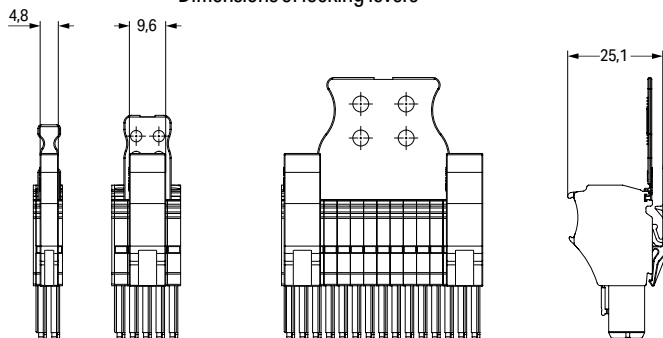

Description	Color	Item No.	Suffix No.
1-conductor female plug	gray	2020-102	none
2- to 15-pole	blue green-yellow	to 2020-115	/000-006 /000-016

Dimensions of strain relief plates

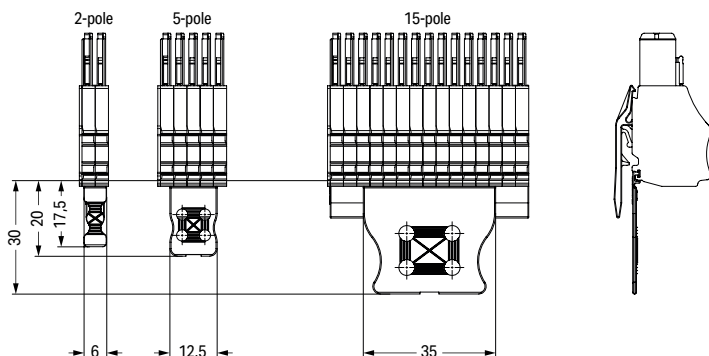

## 2-Conductor Female Plug X-COM®S-SYSTEM-MINI; with Lateral Locking Lever and Strain Relief Plate

### 1 (1.5) mm<sup>2</sup>; 2020 Series

Technical Data	
0.14 ... 1 (1.5) mm <sup>2</sup> ①	24 ... 16 AWG
500 V/6 kV/3 ②	300 V, 10 A ③
I <sub>N</sub> 13.5 A ④	300 V, 10 A ⑤
Module width: 3.5 mm / 0.138 inch	
9 ... 11 mm / 0.35 ... 0.43 inch	

Technical Data	
0.14 ... 1 (1.5) mm <sup>2</sup> ①	24 ... 16 AWG
500 V/6 kV/3 ②	300 V, 10 A ③
I <sub>N</sub> 13.5 A ④	300 V, 10 A ⑤
Module width: 3.5 mm / 0.138 inch	
9 ... 11 mm / 0.35 ... 0.43 inch	

Technical Data	
0.14 ... 1 (1.5) mm <sup>2</sup> ①	24 ... 16 AWG
500 V/6 kV/3 ②	300 V, 10 A ③
I <sub>N</sub> 13.5 A ④	300 V, 10 A ⑤
Module width: 3.5 mm / 0.138 inch	
9 ... 11 mm / 0.35 ... 0.43 inch	

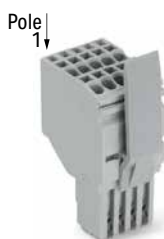

2-conductor female plug; with locking lever; fits into carrier terminal blocks; codable; gray

Pole No.	Item No.	Pack. Unit
○ 2	2020-202/122-000	100
○ 3	2020-203/122-000	50
○ 4	2020-204/124-000	50
○ 5	2020-205/124-000	50
○ 6	2020-206/124-000	25
○ 7	2020-207/124-000	25
○ 8	2020-208/124-000	25
○ 9	2020-209/124-000	25
○ 10	2020-210/125-000	25
○ 11	2020-211/125-000	20
○ 12	2020-212/125-000	20
○ 13	2020-213/125-000	10
○ 14	2020-214/125-000	10
○ 15	2020-215/125-000	10

2-conductor female plug; with strain relief plate; fits into carrier terminal blocks; codable; gray

Pole No.	Item No.	Pack. Unit
○ 2	2020-202/132-000	100
○ 3	2020-203/132-000	50
○ 4	2020-204/133-000	50
○ 5	2020-205/133-000	50
○ 6	2020-206/133-000	25
○ 7	2020-207/134-000	25
○ 8	2020-208/134-000	25
○ 9	2020-209/134-000	25
○ 10	2020-210/135-000	25
○ 11	2020-211/135-000	20
○ 12	2020-212/135-000	20
○ 13	2020-213/135-000	10
○ 14	2020-214/135-000	10
○ 15	2020-215/135-000	10

2-conductor female plug; with strain relief plate and locking lever; fits into carrier terminal blocks; codable; gray

Pole No.	Item No.	Pack. Unit
○ 2	2020-202/142-000	100
○ 3	2020-203/142-000	50
○ 4	2020-204/143-000	50
○ 5	2020-205/143-000	50
○ 6	2020-206/143-000	25
○ 7	2020-207/144-000	25
○ 8	2020-208/144-000	25
○ 9	2020-209/144-000	25
○ 10	2020-210/145-000	25
○ 11	2020-211/145-000	20
○ 12	2020-212/145-000	20
○ 13	2020-213/145-000	10
○ 14	2020-214/145-000	10
○ 15	2020-215/145-000	10

#### Accessories; for female plugs

Appropriate marking systems: WMB/WMB Inline/Marking strips

Protective warning marker; with black high-voltage symbol; for 5 terminal blocks

yellow 2000-115 100 (25)



Carrier with 6 coding pins; for coding female plugs

orange 2020-100 100 (25)



WMB Inline; plain; 2,300 WMB markers (3.5 mm)/reel

white 2009-113 1



Marking strip; plain; 11 mm wide; 50 m reel

white 2009-110 1



WMB marking card; white; 10 strips with 10 markers/card; for 3.5 mm terminal block width

plain 793-3501 5



❶ Conductor range: 0.14 ... 1.5 mm<sup>2</sup> "s+f-st";  
 Push-in termination: 0.5 ... 1.5 mm<sup>2</sup> "s" and  
 0.5 ... 0.75 mm<sup>2</sup> "insulated ferrules; 10 mm"  
 Depending on the conductor characteristic, a conductor  
 with a smaller cross section can also be inserted  
 via push-in termination.

❷ 500 V = rated voltage  
 6 kV = rated impulse voltage  
 3 = pollution degree

❸ Current-carrying capacity curves upon request

**Note:**

According to EN 61984, pluggable connectors without  
 a current interrupting capacity must not be mated or  
 unmated when live or under load.

Notice: An appropriate end plate must be applied to  
 the carrier terminal blocks after each female plug.

Approvals and corresponding ratings,  
 visit [www.wago.com](http://www.wago.com)

Strain Relief Plate (SRP), Gray				Locking Lever (LL), Gray				SRP and LL, Gray
Assembled				Assembled				Assembled
SRP				Pole No.	Quantity	1-Way	2-Way	
Item No. Suffix				Item No. Suffix				Item No. Suffix
Item No.	Color	Width						
734-327	gray	6mm	/132-0xx	2 to 3	1	/122-0xx	-	/142-0xx
734-328	gray	12.5mm	/133-0xx	4 to 6	1	-	/124-0xx	/143-0xx
734-329	gray	25mm	/134-0xx	7 to 9	1	-	/124-0xx	/144-0xx
734-326	gray	35mm	/135-0xx	10 to 15	2	-	/125-0xx	/145-0xx

For colored female plugs, the item number suffix "xx" must be replaced by the blue "-006" and the green-yellow "-016" color suffix.

Dimensions of locking levers

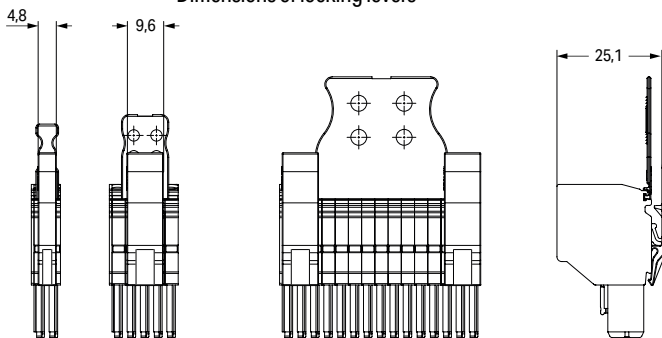

Description	Color	Item No.	Suffix No.
2-conductor female plug	gray	2020-202	none
2- to 15-pole	blue	to	/000-006
	green-yellow	2020-215	/000-016

Dimensions of strain relief plates

# 1-Conductor/1-Pin Carrier Terminal Block, 2-Conductor/1-Pin Carrier Terminal Block, 2-Conductor/2-Pin Carrier Terminal Block X-COM®S-SYSTEM

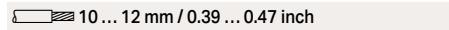

## 2.5 (4) mm<sup>2</sup>; 2022 Series

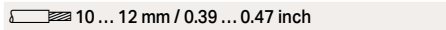

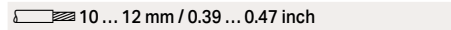
Technical Data	
0.25 ... 2.5 (4) mm <sup>2</sup> ①	22 ... 12 AWG
690 V/6 kV/3 ②	600 V, 20 A ③
I <sub>N</sub> 24 A (32 A) ④	600 V, 20 A ⑤
Terminal block width: 5.2 mm / 0.205 inch	
 10 ... 12 mm / 0.39 ... 0.47 inch	

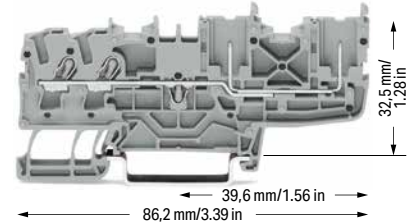
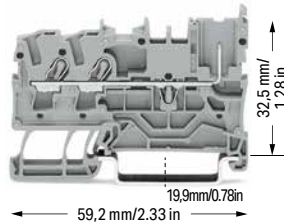
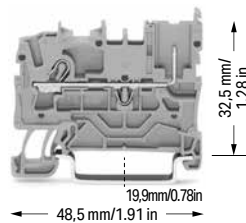

Technical Data	
0.25 ... 2.5 (4) mm <sup>2</sup> ①	22 ... 12 AWG
690 V/6 kV/3 ②	600 V, 20 A ③
I <sub>N</sub> 24 A (32 A) ④	600 V, 20 A ⑤
Terminal block width: 5.2 mm / 0.205 inch	
 10 ... 12 mm / 0.39 ... 0.47 inch	

Technical Data	
0.25 ... 2.5 (4) mm <sup>2</sup> ①	22 ... 12 AWG
690 V/6 kV/3 ②	600 V, 20 A ③
I <sub>N</sub> 24 A (28 A) ④	600 V, 20 A ⑤
Terminal block width: 5.2 mm / 0.205 inch	
 10 ... 12 mm / 0.39 ... 0.47 inch	





1-conductor/1-pin carrier terminal block		
Color	Item No.	Pack. Unit
 gray	2022-1201	100
 blue	2022-1204	100
 orange	2022-1202	100



2-conductor/1-pin carrier terminal block		
Color	Item No.	Pack. Unit
 gray	2022-1301	100
 blue	2022-1304	100
 orange	2022-1302	100



2-conductor/2-pin carrier terminal block		
Color	Item No.	Pack. Unit
 gray	2022-1401	50
 blue	2022-1404	50
 orange	2022-1402	50



1-conductor/1-pin ground carrier terminal block		
 green-yellow	2022-1207	100

2-conductor/1-pin ground carrier terminal block		
 green-yellow	2022-1307	100

2-conductor/2-pin ground carrier terminal block		
 green-yellow	2022-1407	50

Accessories; item-specific			
End and intermediate plate; 1 mm thick			
	orange	2022-1292	100 (25)
	gray	2022-1291	100 (25)

Accessories; item-specific			
End and intermediate plate; 1 mm thick			
	orange	2022-1392	100 (25)
	gray	2022-1391	100 (25)

Accessories; item-specific			
End and intermediate plate; 1 mm thick			
	orange	2022-1492	100 (25)
	gray	2022-1491	100 (25)

### Accessories; 2022 Series

Appropriate marking systems: WMB/WMB Inline/Marking strips

Insulation stop; 5 pcs/strip; 0.25 ... 0.5 mm <sup>2</sup>			
	light gray	2002-171	200 (25)

Delta jumper; insulated; I <sub>N</sub> = I <sub>N</sub> terminal block; light gray			
	1-2 3-4 5-6	2002-406/020-000	25

Adjacent jumper for continuous commoning; insulated; I <sub>N</sub> 25 A, light gray			
	5-way	2002-415	25

Insulation stop; 5 pcs/strip; 0.75 ... 1 mm <sup>2</sup>			
	dark gray	2002-172	200 (25)

Star point jumper; insulated; I <sub>N</sub> = I <sub>N</sub> terminal block; light gray			
	1-3-5	2002-405/011-000	25

Push-in type wire jumper; insulated; 1.5 mm <sup>2</sup> conductor cross-section; I <sub>N</sub> 18 A			
	L = 60 mm	2009-412	100 (10)
	L = 110 mm	2009-414	100 (10)
	L = 250 mm	2009-416	100 (10)

Protective warning marker; with black high-voltage symbol; for 5 terminal blocks			
	yellow	2002-115	100 (25)

Staggered jumper; insulated; I <sub>N</sub> 25 A; light gray			
	2-way	2002-472	25
	3-way	2002-473	25
	4-way	2002-474	25
	5-way	2002-475	25
	6-way	2002-476	25
	7-way	2002-477	25
	8-way	2002-478	25
	9-way	2002-479	25
	10-way	2002-480	25
	11-way	2002-481	25
	12-way	2002-482	25

Carrier with 6 coding pins; for coding female plugs			
	orange	2022-100	100 (25)

Push-in type jumper bar; insulated; I <sub>N</sub> 25 A; light gray			
	2-way	2002-402	25
	3-way	2002-403	25
	4-way	2002-404	25
	5-way	2002-405	25
	6-way	2002-406	25
	7-way	2002-407	25
	8-way	2002-408	25
	9-way	2002-409	25
	10-way	2002-410	25

Adjacent jumper for continuous commoning; insulated; I <sub>N</sub> 25 A, light gray			
	2-way	2002-400	25

Test pin; 1 mm Ø			
		859-500	1

Push-in type jumper bar; insulated; I <sub>N</sub> 25 A; light gray			
	1 to 3	2002-433	25
	1 to 4	2002-434	25
	1 to 5	2002-435	25
	1 to 6	2002-436	25
	1 to 7	2002-437	25
	1 to 8	2002-438	25
	1 to 9	2002-439	25
	1 to 10	2002-440	25

Adjacent jumper for continuous commoning; insulated; I <sub>N</sub> 25 A; 1 to 3			
	light gray	2002-423	25
	red	2002-423/000-005	25
	blue	2002-423/000-006	25

1-conductor female plug			
	gray	2022-101	200



❶ Conductor range: 0.25 ... 4 mm<sup>2</sup> "s+f-st";  
Push-in termination: 1 ... 4 mm<sup>2</sup> "s" and 1 ... 2.5 mm<sup>2</sup>  
"insulated ferrules, 12 mm"  
Depending on the conductor characteristic, a conductor with a smaller cross section can also be inserted via push-in termination.

❷ 690 V = rated voltage  
6 kV = rated impulse voltage  
3 = pollution degree

❸ Current-carrying capacity curves upon request

**Note:**

When used as intended, female plugs must not be connected/disconnected when live or under load.

Please observe the application notes:  
Jumpers, from page 160  
Marking, from page 246

Approvals and corresponding ratings,  
visit [www.wago.com](http://www.wago.com)

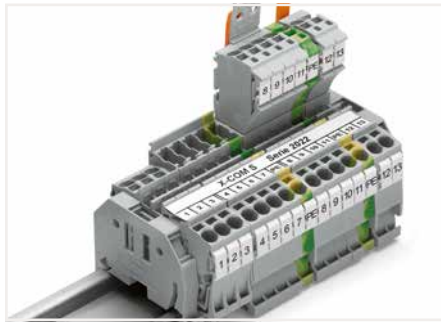

2022 Series X-COM®S-SYSTEM Carrier Terminal Blocks combined with 2002 Series Through Terminal Blocks



Carrier terminal blocks and female plugs are touch-proof.

**Accessories; 2022 Series**

Appropriate marking systems:  
WMB/WMB Inline/Marking strips

WMB Inline, plain; 1,500 WMB markers (5 mm)/reel;  
5 ... 5.2 mm stretchable

	white	2009-115	1
---	-------	----------	---

Marking strip; plain; 11 mm wide; 50 m reel

	white	2009-110	1
---	-------	----------	---

WMB marking card; white; 10 strips with 10 markers/card;  
5 ... 5.2 mm stretchable

	plain	793-5501	5
---	-------	----------	---

WMB marking card; plain; 10 strips with 10 markers/card;  
5 ... 5.2 mm stretchable

	yellow	793-5501/000-002	5
	red	793-5501/000-005	5
	blue	793-5501/000-006	5
	gray	793-5501/000-007	5
	orange	793-5501/000-012	5
	light green	793-5501/000-017	5
	green	793-5501/000-023	5
	violet	793-5501/000-024	5

Screwless end stop; for DIN-35 rail; 6 mm wide

	gray	249-116	100 (25)
---	------	---------	----------

Screwless end stop; for DIN-35 rail; 10 mm wide

	gray	249-117	50 (25)
---	------	---------	---------

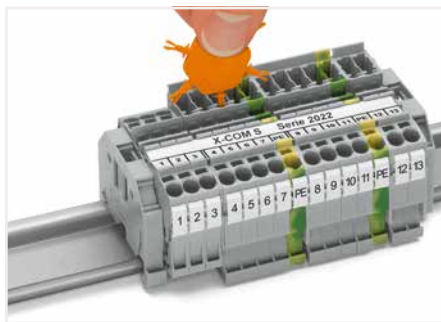

Insert coding pin into the corresponding slot and twist it off.



## 2-Pin Carrier Terminal Block, 4-Pin Carrier Terminal Block X-COM®S-SYSTEM 2022 Series

### Technical Data

690 V/6 kV/3 ①

 $I_N$  24 A (28 A) ②

Terminal block width: 5.2 mm / 0.205 inch

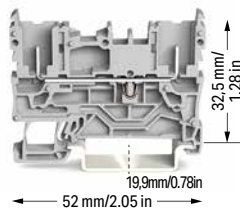

### 2-pin carrier terminal block

Color	Item No.	Pack. Unit
gray	2022-1601	50
blue	2022-1604	50
orange	2022-1602	50

### 2-pin ground carrier terminal block

green-yellow	2022-1607	50
--------------	-----------	----

### Item-Specific Accessories

#### End plate; 1 mm thick

orange	2022-1692	100 (25)
gray	2022-1691	100 (25)

### Accessories; 2022 Series

Appropriate marking systems: WMB/WMB Inline/Marking strips

### Push-in type jumper bar; insulated; $I_N$ 25 A; light gray

2-way	2002-402	25
3-way	2002-403	25
4-way	2002-404	25
5-way	2002-405	25
6-way	2002-406	25
7-way	2002-407	25
8-way	2002-408	25
9-way	2002-409	25
10-way	2002-410	25

### Push-in type jumper bar; insulated; $I_N$ 25 A; light gray

1 to 3	2002-433	25
1 to 4	2002-434	25
1 to 5	2002-435	25
1 to 6	2002-436	25
1 to 7	2002-437	25
1 to 8	2002-438	25
1 to 9	2002-439	25
1 to 10	2002-440	25

### Delta jumper; insulated; $I_N = I_N$ terminal block; light gray

1-2 3-4 5-6	2002-406/020-000	25
-------------	------------------	----

### Star point jumper; insulated; $I_N = I_N$ terminal block; light gray

1-3-5	2002-405/011-000	25
-------	------------------	----

### Adjacent jumper for continuous commoning; insulated; $I_N$ 25 A, light gray

2-way	2002-400	25
-------	----------	----

### Technical Data

690 V/6 kV/3 ①

 $I_N$  24 A (27 A) ②

Terminal block width: 5.2 mm / 0.205 inch

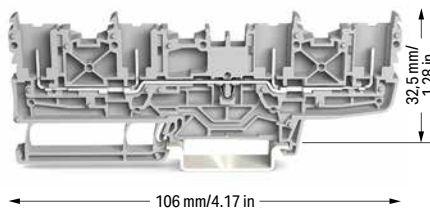

### 4-pin carrier terminal block

Color	Item No.	Pack. Unit
gray	2022-1801	50
blue	2022-1804	50
orange	2022-1802	50

### 4-pin ground carrier terminal block

green-yellow	2022-1807	50
--------------	-----------	----

### Item-Specific Accessories

#### End plate; 1 mm thick

orange	2022-1892	100 (25)
gray	2022-1891	100 (25)

① 690 V = rated voltage

6 kV = rated impulse voltage

3 = pollution degree

② Current-carrying capacity curves upon request

#### Note:

When used as intended, female plugs must not be connected/disconnected when live or under load.

Please observe the application notes:

Jumpers, from page 160

Marking, from page 246

Approvals and corresponding ratings, visit [www.wago.com](http://www.wago.com)

### Accessories; 2022 Series

Appropriate marking systems:  
WMB/WMB Inline/Marking strips

### 1-conductor female plug

gray	2022-101	200
------	----------	-----



### WMB Inline, plain; 1,500 WMB markers (5 mm)/reel; 5 ... 5.2 mm stretchable

white	2009-115	1
-------	----------	---



### Marking strip; plain; 11 mm wide; 50 m reel

white	2009-110	1
-------	----------	---



### WMB marking card; white; 10 strips with 10 markers/card; 5 ... 5.2 mm stretchable

plain	793-5501	5
-------	----------	---



### WMB marking card; plain; 10 strips with 10 markers/card; 5 ... 5.2 mm stretchable

yellow	793-5501/000-002	5
red	793-5501/000-005	5
blue	793-5501/000-006	5
gray	793-5501/000-007	5
orange	793-5501/000-012	5
light green	793-5501/000-017	5
green	793-5501/000-023	5
violet	793-5501/000-024	5

### Screwless end stop; for DIN-35 rail; 6 mm wide

gray	249-116	100 (25)
------	---------	----------



### Screwless end stop; for DIN-35 rail; 10 mm wide

gray	249-117	50 (25)
------	---------	---------



# Carrier Terminal Blocks and 1-Conductor Female Plugs X-COM®S-SYSTEM

## Types of Assembly

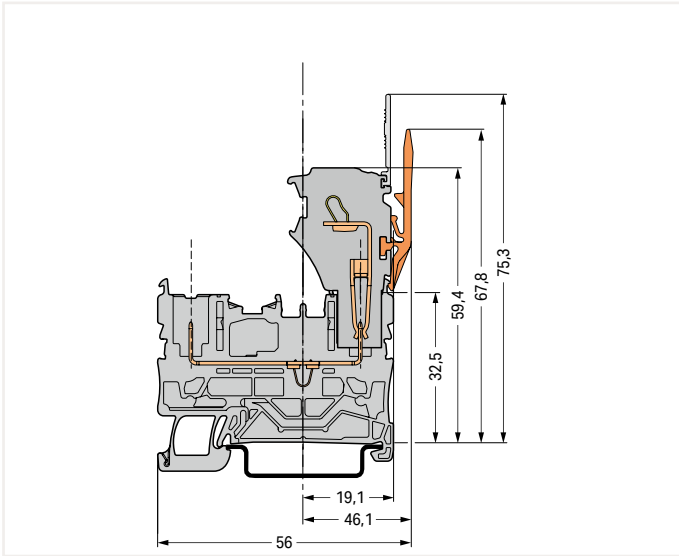

Carrier terminal block

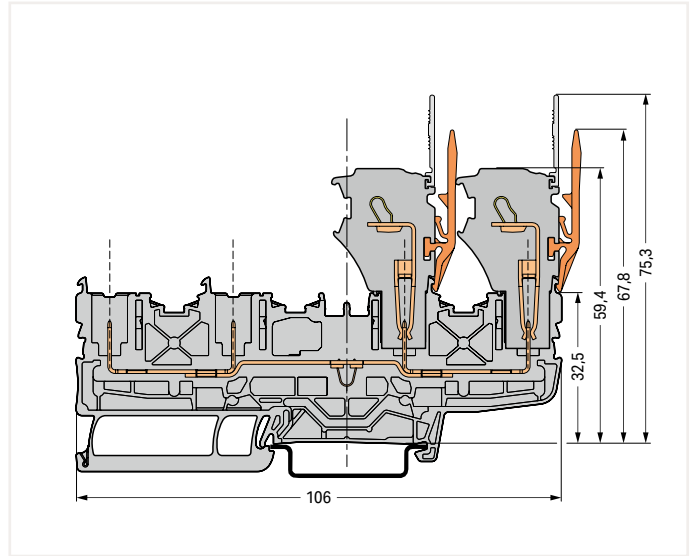

Carrier terminal block

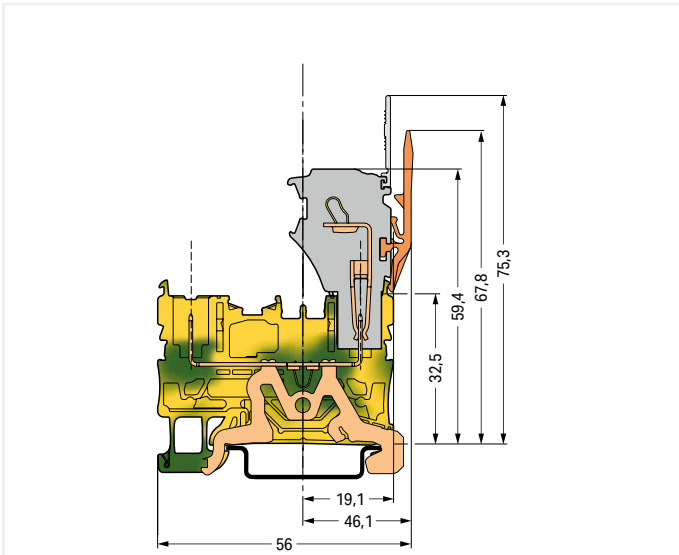

Ground carrier terminal block

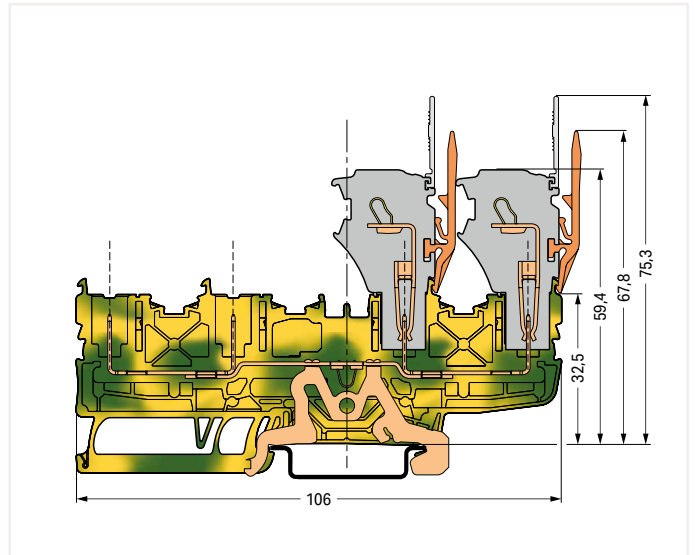

Ground carrier terminal block

# 1-Conductor/1-Pin Double-Deck Carrier Terminal Block X-COM®S-SYSTEM

## 2.5 (4) mm<sup>2</sup>; 2022 Series

Technical Data	
0.25 ... 2.5 (4) mm <sup>2</sup> ①	22 ... 12 AWG
690 V/6 kV/3 ②	600 V, 20 A ③
I <sub>N</sub> 24 A (28 A) ④	600 V, 20 A ⑤
Terminal block width: 5.2 mm / 0.205 inch	
 10 ... 12 mm / 0.39 ... 0.47 inch	

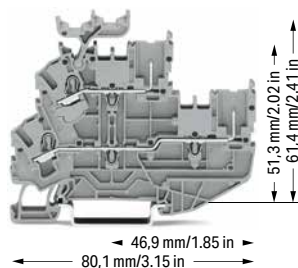

1-conductor/1-pin double-deck carrier terminal block; through/through terminal block; with marker carrier; gray

	Item No.	Pack. Unit
<input type="radio"/> L/L	2022-2231	50
<input type="radio"/> N/L	2022-2232	50
<input type="radio"/> L/N	2022-2233	50

Technical Data	
0.25 ... 2.5 (4) mm <sup>2</sup> ①	22 ... 12 AWG
690 V/6 kV/3 ②	600 V, 20 A ③
I <sub>N</sub> 24 A (28 A) ④	600 V, 20 A ⑤
Terminal block width: 5.2 mm / 0.205 inch	
 10 ... 12 mm / 0.39 ... 0.47 inch	

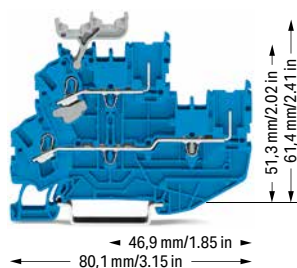

1-conductor/1-pin double-deck carrier terminal block; through/through terminal block; with marker carrier; blue

	Item No.	Pack. Unit
<input checked="" type="radio"/> N/N	2022-2234	50

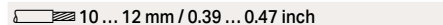
Technical Data	
0.25 ... 2.5 (4) mm <sup>2</sup> ①	22 ... 12 AWG
690 V/6 kV/3 ②	600 V, 20 A ③
I <sub>N</sub> 24 A (28 A) ④	600 V, 20 A ⑤
Terminal block width: 5.2 mm / 0.205 inch	
 10 ... 12 mm / 0.39 ... 0.47 inch	

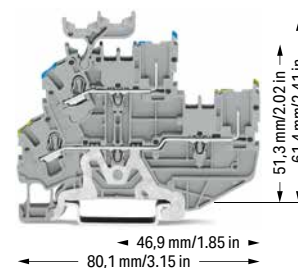

1-conductor/1-pin double-deck carrier terminal block; ground conductor/through terminal block; with marker carrier; gray

	Item No.	Pack. Unit
<input type="radio"/> PE/N	2022-2247	50
<input type="radio"/> PE/L	2022-2257	50

1-conductor/1-pin double-deck carrier terminal block; through/through terminal block; without marker carrier; gray		
<input type="radio"/> L/L	2022-2201	50
<input type="radio"/> N/L	2022-2202	50
<input type="radio"/> L/N	2022-2203	50

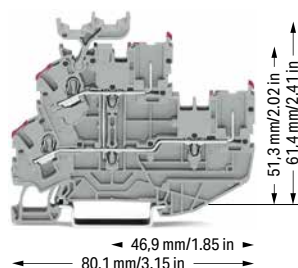

1-conductor/1-pin double-deck carrier terminal block; through/through terminal block; without marker carrier; blue		
<input checked="" type="radio"/> N/N	2022-2204	50

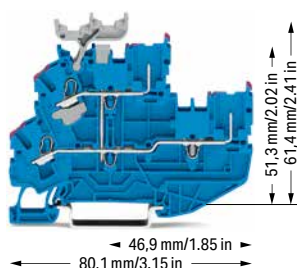

1-conductor/1-pin double-deck carrier terminal block; ground conductor/through terminal block; without marker carrier; gray		
<input type="radio"/> PE/N	2022-2217	50
<input type="radio"/> PE/L	2022-2227	50

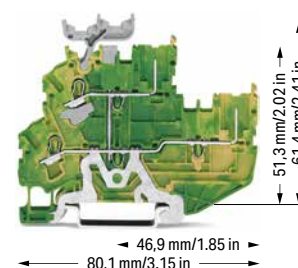

2-conductor/2-pin double-deck carrier terminal block; 2-conductor/2-pin through terminal block; with marker carrier, internally commoded; violet conductor entry; gray		
<input type="radio"/> L	2022-2238	50

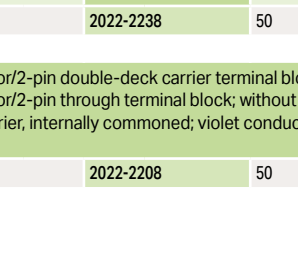

2-conductor/2-pin double-deck carrier terminal block; 2-conductor/2-pin through terminal block; with marker carrier, internally commoded; violet conductor entry; blue		
<input checked="" type="radio"/> N	2022-2239	50

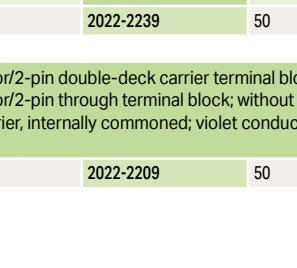

2-conductor/2-pin double-deck carrier block; 2-conductor/2-pin ground conductor block; with marker carrier, internally commoded; green-yellow		
<input checked="" type="radio"/> PE	2022-2237	50

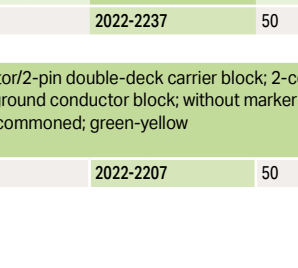

2-conductor/2-pin double-deck carrier terminal block; 2-conductor/2-pin through terminal block; without marker carrier, internally commoded; violet conductor entry; gray		
<input type="radio"/> L	2022-2208	50

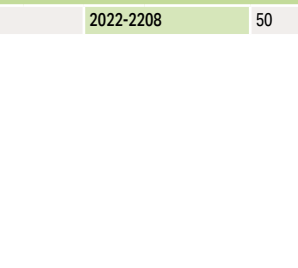

2-conductor/2-pin double-deck carrier terminal block; 2-conductor/2-pin through terminal block; without marker carrier, internally commoded; violet conductor entry; blue		
<input checked="" type="radio"/> N	2022-2209	50

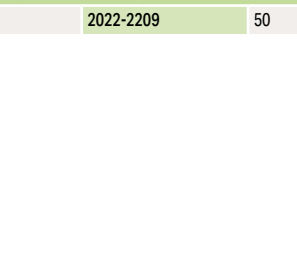

2-conductor/2-pin double-deck carrier block; 2-conductor/2-pin ground conductor block; without marker carrier, internally commoded; green-yellow		
<input checked="" type="radio"/> PE	2022-2207	50

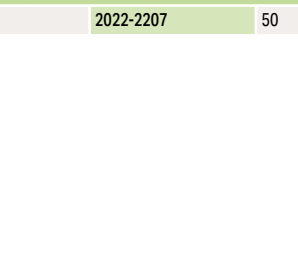

❶ Conductor range: 0.25 ... 4 mm<sup>2</sup> "s+f-st";  
Push-in termination: 1 ... 4 mm<sup>2</sup> "s" and 1 ... 2.5 mm<sup>2</sup> "insulated ferrules, 12 mm"  
Depending on the conductor characteristic, a conductor with a smaller cross section can also be inserted via push-in termination.

❷ 690 V = rated voltage  
6 kV = rated impulse voltage  
3 = pollution degree

❸ Current-carrying capacity curves upon request

**Note:**

When used as intended, female plugs must not be connected/disconnected when live or under load.

Please observe the application notes:  
Jumpers, from page 160  
Marking, from page 246

Approvals and corresponding ratings,  
visit [www.wago.com](http://www.wago.com)

**Accessories; 2022 Series**

Appropriate marking systems:  
WMB/WMB Inline/Marking strips

Adjacent jumper for continuous commoning; insulated;  
I<sub>N</sub> 25 A, light gray



2-way	2002-400	25
-------	----------	----

Adjacent jumper for continuous commoning; insulated;  
I<sub>N</sub> 25 A; 1 to 3



light gray	2002-423	25
red	2002-423/000-005	25
blue	2002-423/000-006	25

Adjacent jumper for continuous commoning; insulated;  
I<sub>N</sub> 25 A, light gray



5-way	2002-415	25
-------	----------	----

**Carrier with 6 coding pins; for coding female plugs**



orange	2022-100	100 (25)
--------	----------	----------

**Test pin; 1 mm Ø**



	859-500	1
--	---------	---

**1-conductor female plug**



gray	2022-101	200
------	----------	-----

**WMB Inline, plain; 1,500 WMB markers (5 mm)/reel;  
5 ... 5.2 mm stretchable**



white	2009-115	1
-------	----------	---

**Marking strip; plain; 11 mm wide; 50 m reel**



white	2009-110	1
-------	----------	---

**WMB marking card; white; 10 strips with 10 markers/card;  
5 ... 5.2 mm stretchable**



plain	793-5501	5
-------	----------	---

**WMB marking card; plain; 10 strips with 10 markers/card;  
5 ... 5.2 mm stretchable**



yellow	793-5501/000-002	5
red	793-5501/000-005	5
blue	793-5501/000-006	5
gray	793-5501/000-007	5
orange	793-5501/000-012	5
light green	793-5501/000-017	5
green	793-5501/000-023	5
violet	793-5501/000-024	5

**Double-deck marker carrier; pivoting**



gray	2002-121	50 (25)
------	----------	---------

**Screwless end stop; for DIN-35 rail; 6 mm wide**



gray	249-116	100 (25)
------	---------	----------



Size comparison:  
Double-deck carrier terminal blocks with 3.5 mm and 5.2 mm terminal block widths

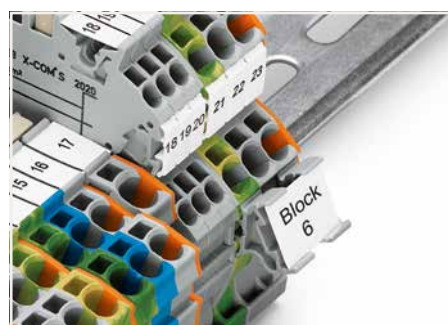

Marker carrier (2009-198)

**Accessories; 2022 Series**

Appropriate marking systems:  
WMB/WMB Inline/Marking strips

**End and intermediate plate; 1 mm thick**



orange	2022-2292	100 (25)
gray	2022-2291	100 (25)

**Insulation stop; 5 pcs/strip; 0.25 ... 0.5 mm<sup>2</sup>**



light gray	2002-171	200 (25)
------------	----------	----------

**Insulation stop; 5 pcs/strip; 0.75 ... 1 mm<sup>2</sup>**



dark gray	2002-172	200 (25)
-----------	----------	----------

**Protective warning marker; with black high-voltage symbol;  
for 5 terminal blocks**



yellow	2002-115	100 (25)
--------	----------	----------

**Push-in type jumper bar; insulated; I<sub>N</sub> 25 A; light gray**



2-way	2002-402	25
3-way	2002-403	25
4-way	2002-404	25
5-way	2002-405	25
6-way	2002-406	25
7-way	2002-407	25
8-way	2002-408	25
9-way	2002-409	25
10-way	2002-410	25

**Push-in type jumper bar; insulated; I<sub>N</sub> 25 A; light gray**



1 to 3	2002-433	25
1 to 4	2002-434	25
1 to 5	2002-435	25
1 to 6	2002-436	25
1 to 7	2002-437	25
1 to 8	2002-438	25
1 to 9	2002-439	25
1 to 10	2002-440	25

**Double-deck vertical jumper; insulated; I<sub>N</sub> 24 A**



light gray	2002-492	100 (25)
orange	2002-492/000-012	100 (25)



# 1-Conductor Female Plug X-COM®S-SYSTEM

## 2.5 (4) mm<sup>2</sup>; 2022 Series

### Technical Data

0.25 ... 2.5 (4) mm<sup>2</sup> ① 22 ... 12 AWG

690 V/6 kV/3 ② 600 V, 20 A ③

I<sub>N</sub> 24 A (32 A) ③ 600 V, 20 A ③

Module width: 5.2 mm / 0.205 inch

10 ... 12 mm / 0.39 ... 0.47 inch



Dimensions (in mm):

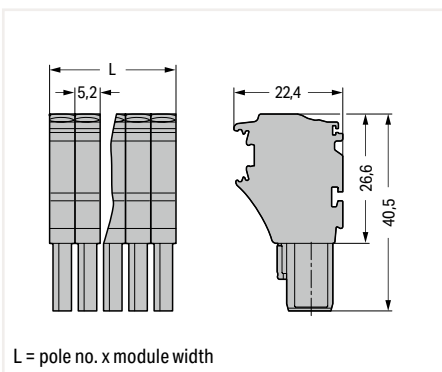

1-conductor female plug; fits into carrier terminal blocks; codable; gray  
According to EN 61984, pluggable connectors without a current interrupting capacity must not be mated or unmated when live or under load.

Pole No.	Item No.	Pack. Unit
1	2022-101	200
2	2022-102	200
3	2022-103	100
4	2022-104	100
5	2022-105	50
6	2022-106	50
7	2022-107	50
8	2022-108	50
9	2022-109	50
10	2022-110	25
11	2022-111	25
12	2022-112	25
13	2022-113	25
14	2022-114	25
15	2022-115	25

1-conductor female plug; fits into carrier terminal blocks; codable; green-yellow  
According to EN 61984, pluggable connectors without a current interrupting capacity must not be mated or unmated when live or under load.

1	2022-101/000-016	200
2	2022-102/000-016	200

① Conductor range: 0.25 ... 4 mm<sup>2</sup> "s+f-st";  
Push-in termination: 1 ... 4 mm<sup>2</sup> "s" and 1 ... 2.5 mm<sup>2</sup> "insulated ferrules, 12 mm"  
Depending on the conductor characteristic, a conductor with a smaller cross section can also be inserted via push-in termination.

② 690 V = rated voltage  
6 kV = rated impulse voltage  
3 = pollution degree

③ Current-carrying capacity curves upon request

Item no. suffixes

blue .../000-006

orange .../000-012

Approvals and corresponding ratings,  
visit [www.wago.com](http://www.wago.com)

### Accessories; for female plugs

Appropriate marking systems:  
WMB/WMB Inline/Marking strips

#### Insulation stop; 5 pcs/strip; 0.25 ... 0.5 mm<sup>2</sup>

light gray 2002-171 200 (25)



#### Insulation stop; 5 pcs/strip; 0.75 ... 1 mm<sup>2</sup>

dark gray 2002-172 200 (25)



#### Protective warning marker; with black high-voltage symbol; for 5 terminal blocks

yellow 2002-115 100 (25)



#### Locking lever; 4.8 mm wide

orange 2022-142 100 (25)



gray 2022-141 100 (25)



#### Locking lever; 9.6 mm wide

orange 2022-152 100 (25)



gray 2022-151 100 (25)



#### Carrier with 6 coding pins; for coding female plugs

orange 2022-100 100 (25)



#### Strain relief plate; gray

35 mm wide 734-326 100 (25)



6 mm wide 734-327 100 (25)

12.5 mm wide 734-328 100 (25)

25 mm wide 734-329 100 (25)

55 mm wide 734-430 50 (25)

75 mm wide 734-431 50 (25)

#### WMB Inline, plain; 1,500 WMB markers (5 mm)/reel; 5 ... 5.2 mm stretchable

white 2009-115 1



#### Marking strip; plain; 11 mm wide; 50 m reel

white 2009-110 1



#### WMB marking card; white; 10 strips with 10 markers/card; 5 ... 5.2 mm stretchable

plain 793-5501 5

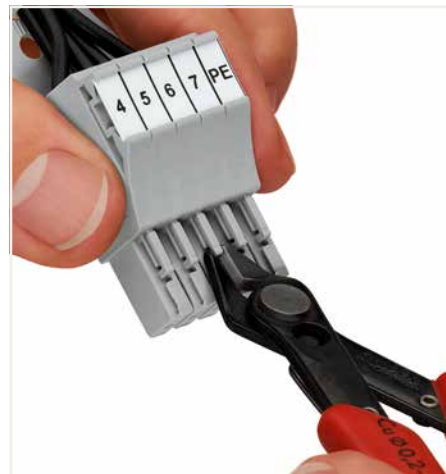

Coding a female plug: remove coding finger using a suitable tool.

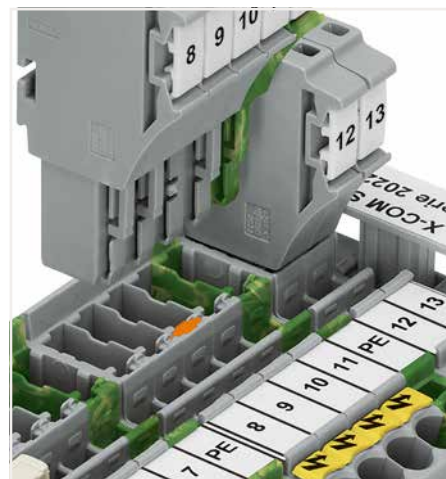

Insert a coding pin (2022-100) into the corresponding location of the carrier terminal block.

## Carrier Terminal Blocks and 1-Conductor Female Plugs X-COM®S-SYSTEM

### Types of Assembly

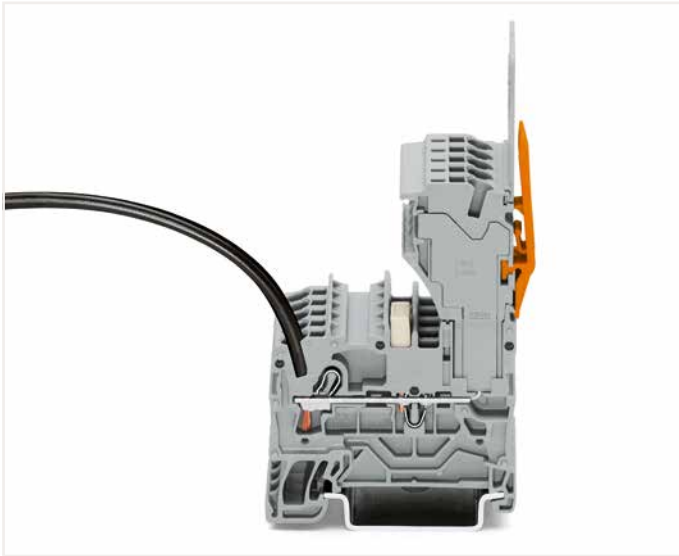

1-conductor female plug  
Carrier terminal blocks can be commoned via 2002 Series Push-In Type Jumper Bars and tested via 859-500 Test Pin.

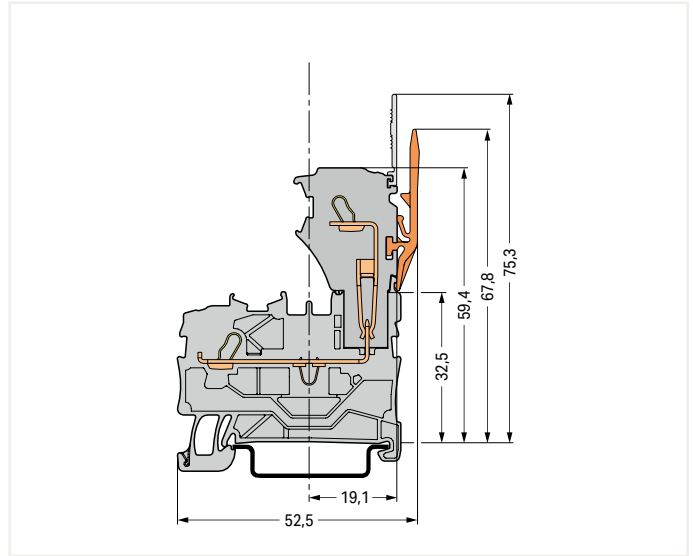

Carrier terminal block

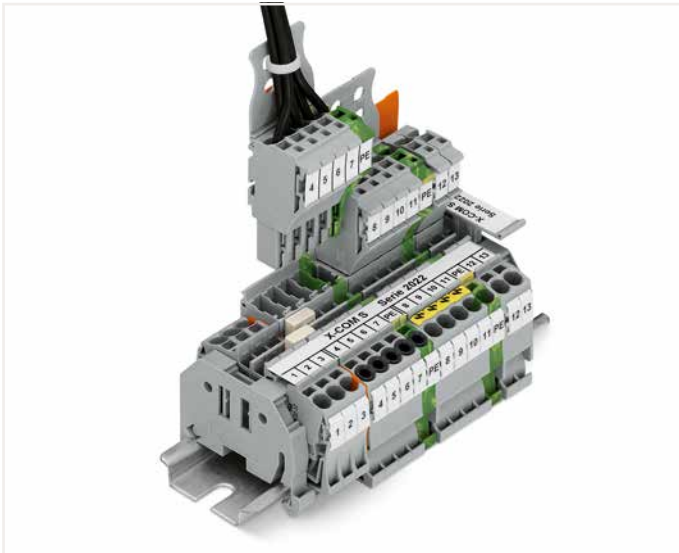

X-COM®S-SYSTEM terminal block assembly

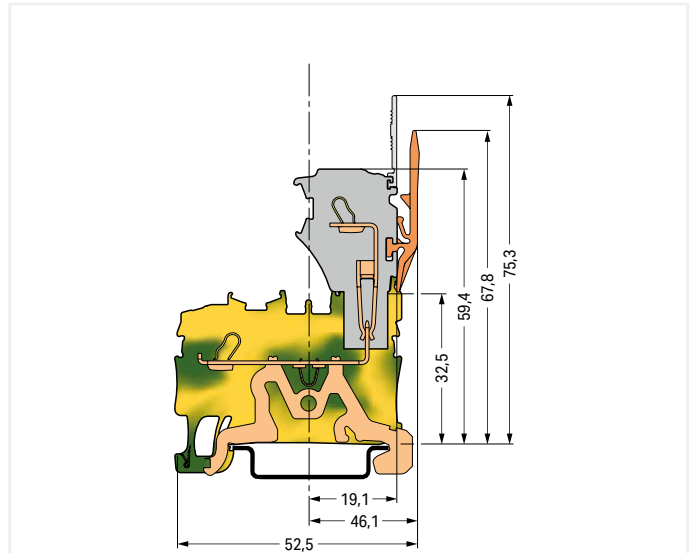

Ground carrier terminal block

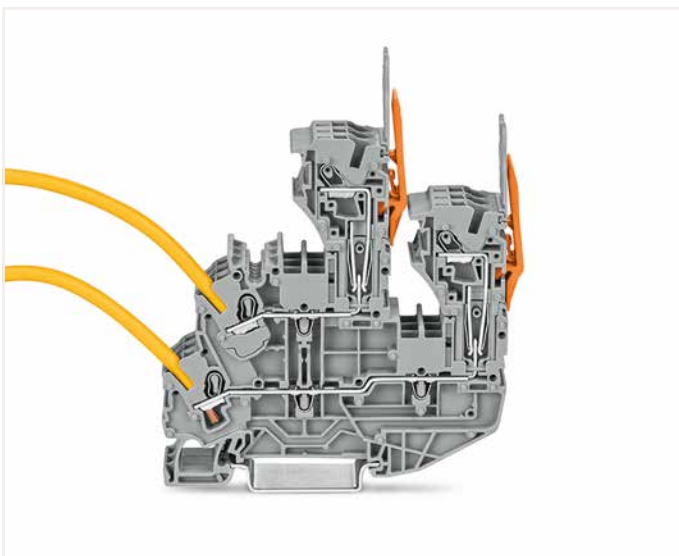

1-conductor female plug  
Double-deck carrier terminal blocks can be commoned via 2002 Series Push-In Type Jumper Bars and tested via 859-500 Test Pin.

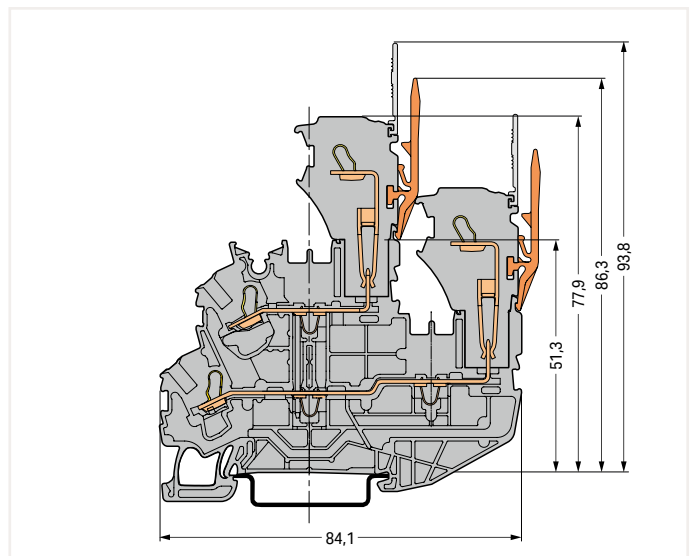

Double-deck carrier terminal block

## Female Plug for Self-Assembly X-COM®S-SYSTEM



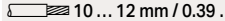

### 2.5 (4) mm<sup>2</sup>; 2022 Series

#### Technical Data

0.25 ... 2.5 (4) mm <sup>2</sup> ①	22 ... 12 AWG
690 V/6 kV/3 ②	600 V, 20 A ③
I <sub>N</sub> 24 A (32 A) ③	600 V, 20 A ③
Terminal block width: 5.2 mm / 0.205 inch	
 10 ... 12 mm / 0.39 ... 0.47 inch	



#### 1-conductor end module; codable

Color	Item No.	Pack. Unit
 gray	2022-181	250
 blue	2022-184	250
 orange	2022-182	250
 green-yellow	2022-187	250

#### 1-conductor center module; codable

 gray	2022-171	250
 blue	2022-174	250
 orange	2022-172	250
 green-yellow	2022-177	250

#### 1-conductor base module; with integrated end plate; codable

 gray	2022-161	250
 blue	2022-164	250
 orange	2022-162	250
 green-yellow	2022-167	250

#### Accessories; for female plugs

Appropriate marking systems:  
WMB/WMB Inline/Marking strips

#### Insulation stop; 5 pcs/strip; 0.25 ... 0.5 mm<sup>2</sup>

 light gray	2002-171	200 (25)
--	----------	----------

#### Insulation stop; 5 pcs/strip; 0.75 ... 1 mm<sup>2</sup>

 dark gray	2002-172	200 (25)
---	----------	----------

#### Protective warning marker; with black high-voltage symbol; for 5 terminal blocks

 yellow	2002-115	100 (25)
--	----------	----------

#### Locking lever; 4.8 mm wide

 orange	2022-142	100 (25)
gray	2022-141	100 (25)

#### Locking lever; 9.6 mm wide

 orange	2022-152	100 (25)
gray	2022-151	100 (25)

#### Carrier with 6 coding pins; for coding female plugs

 orange	2022-100	100 (25)
--	----------	----------

- Conductor range: 0.25 ... 4 mm<sup>2</sup> "s+f-st";  
Push-in termination: 1 ... 4 mm<sup>2</sup> "s" and 1 ... 2.5 mm<sup>2</sup> "insulated ferrules, 12 mm"  
Depending on the conductor characteristic, a conductor with a smaller cross section can also be inserted via push-in termination.
- 690 V = rated voltage  
6 kV = rated impulse voltage  
3 = pollution degree
- Current-carrying capacity curves upon request

#### Note:

According to EN 61984, pluggable connectors without a current interrupting capacity must not be mated or unmated when live or under load.

Approvals and corresponding ratings, visit [www.wago.com](http://www.wago.com)

#### Accessories; for female plugs

Appropriate marking systems:  
WMB/WMB Inline/Marking strips

#### Strain relief plate; gray

 35 mm wide	734-326	100 (25)
6 mm wide	734-327	100 (25)
12.5 mm wide	734-328	100 (25)
25 mm wide	734-329	100 (25)
55 mm wide	734-430	50 (25)
75 mm wide	734-431	50 (25)

#### WMB Inline, plain; 1,500 WMB markers (5 mm)/reel; 5 ... 5.2 mm stretchable

 white	2009-115	1
---	----------	---

#### Marking strip; plain; 11 mm wide; 50 m reel

 white	2009-110	1
---	----------	---

#### WMB marking card; white; 10 strips with 10 markers/card; 5 ... 5.2 mm stretchable

 plain	793-5501	5
---	----------	---

#### WMB marking card; plain; 10 strips with 10 markers/card; 5 ... 5.2 mm stretchable

 yellow	793-5501/000-002	5
red	793-5501/000-005	5
blue	793-5501/000-006	5
gray	793-5501/000-007	5
orange	793-5501/000-012	5
light green	793-5501/000-017	5
green	793-5501/000-023	5
violet	793-5501/000-024	5

#### Customizing Modular Female Plugs

WAGO's modular X-COM®S-SYSTEM female plugs can be customized for applications requiring varying numbers of poles (e.g., when designing prototypes).

#### Modules and Pole Numbers

A customized X-COM®S-SYSTEM female plug consists of:

- One base module with an integrated end plate
- Up to 13 center modules (corresponding to a 15-pole female plug = maximum pole number)
- One end module

#### Intended Use

According to EN 61984, pluggable connectors without a current interrupting capacity must not be mated or unmated when live or under load.

#### Mounting

The appropriate mounting tool shall be used in order to guarantee that the individual modules are properly attached to each other without damaging the locking latches.

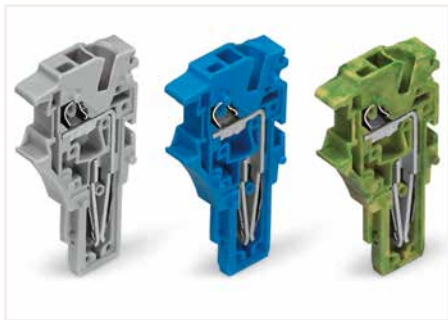

End module

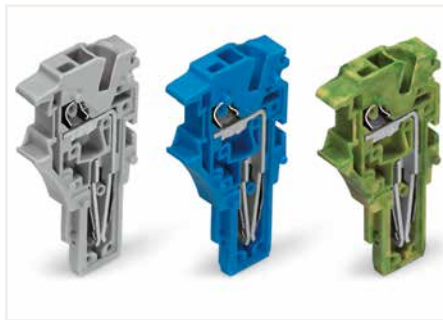

Center module



Base module

### Example: 5-Pole, 1-Conductor Female Plug

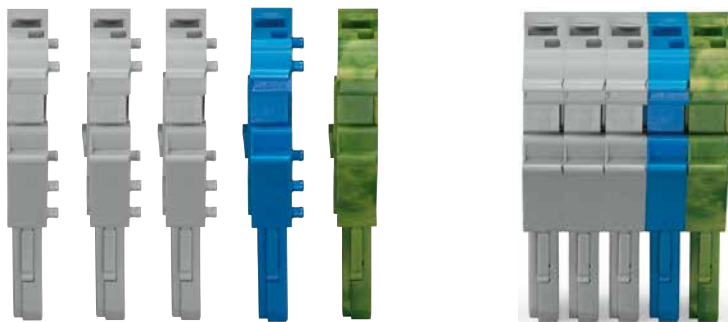

Base module with integrated end plate  
2022-167

Center module  
2022-174

Center modules  
2022-171

End module  
2022-181

## Pre-Assembled 1-Conductor Female Plug X-COM®S-SYSTEM 2.5 (4) mm<sup>2</sup>; 2022 Series

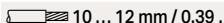
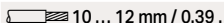
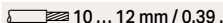
Technical Data		Technical Data		Technical Data	
0.25 ... 2.5 (4) mm <sup>2</sup> ①	22 ... 12 AWG	0.25 ... 2.5 (4) mm <sup>2</sup> ①	22 ... 12 AWG	0.25 ... 2.5 (4) mm <sup>2</sup> ①	22 ... 12 AWG
690 V/6 kV/3 ②	600 V, 20 A ③	690 V/6 kV/3 ②	600 V, 20 A ③	690 V/6 kV/3 ②	600 V, 20 A ③
I <sub>N</sub> 24 A (32 A) ④	600 V, 20 A ⑤	I <sub>N</sub> 24 A (32 A) ④	600 V, 20 A ⑤	I <sub>N</sub> 24 A (32 A) ④	600 V, 20 A ⑤
Module width: 5.2 mm / 0.205 inch		Module width: 5.2 mm / 0.205 inch		Module width: 5.2 mm / 0.205 inch	
 10 ... 12 mm / 0.39 ... 0.47 inch		 10 ... 12 mm / 0.39 ... 0.47 inch		 10 ... 12 mm / 0.39 ... 0.47 inch	

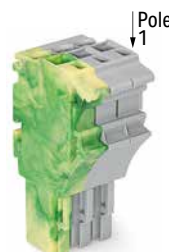

1-conductor female plug; with ground base module (green-yellow); fits into carrier terminal blocks; codable

Pole No.	Item No.	Pack. Unit
3	2022-103/000-036	100
4	2022-104/000-036	100
5	2022-105/000-036	50
6	2022-106/000-036	50
7	2022-107/000-036	50
8	2022-108/000-036	50
9	2022-109/000-036	50
10	2022-110/000-036	25
11	2022-111/000-036	25
12	2022-112/000-036	25
13	2022-113/000-036	25
14	2022-114/000-036	25
15	2022-115/000-036	25

1-conductor female plug; with ground end module (green-yellow); fits into carrier terminal blocks; codable

Pole No.	Item No.	Pack. Unit
3	2022-103/000-037	100
4	2022-104/000-037	100
5	2022-105/000-037	50
6	2022-106/000-037	50
7	2022-107/000-037	50
8	2022-108/000-037	50
9	2022-109/000-037	50
10	2022-110/000-037	25
11	2022-111/000-037	25
12	2022-112/000-037	25
13	2022-113/000-037	25
14	2022-114/000-037	25
15	2022-115/000-037	25

1-conductor female plug; with ground base module (green-yellow); fits into carrier terminal blocks; codable

Pole No.	Item No.	Pack. Unit
3	2022-103/000-038	100
4	2022-104/000-038	100
5	2022-105/000-038	50
6	2022-106/000-038	50
7	2022-107/000-038	50
8	2022-108/000-038	50
9	2022-109/000-038	50
10	2022-110/000-038	25
11	2022-111/000-038	25
12	2022-112/000-038	25
13	2022-113/000-038	25
14	2022-114/000-038	25
15	2022-115/000-038	25

### Accessories; for female plugs

Appropriate marking systems: WMB/WMB Inline/Marking strips

Insulation stop; 5 pcs/strip; 0.25 ... 0.5 mm<sup>2</sup>

light gray	2002-171	200 (25)
------------	----------	----------



Insulation stop; 5 pcs/strip; 0.75 ... 1 mm<sup>2</sup>

dark gray	2002-172	200 (25)
-----------	----------	----------



Protective warning marker; with black high-voltage symbol; for 5 terminal blocks

yellow	2002-115	100 (25)
--------	----------	----------



Locking lever; 4.8 mm wide

orange	2022-142	100 (25)
gray	2022-141	100 (25)



Locking lever; 9.6 mm wide

orange	2022-152	100 (25)
gray	2022-151	100 (25)



Carrier with 6 coding pins; for coding female plugs

orange	2022-100	100 (25)
--------	----------	----------



Strain relief plate; gray

35 mm wide	734-326	100 (25)
6 mm wide	734-327	100 (25)
12.5 mm wide	734-328	100 (25)
25 mm wide	734-329	100 (25)
55 mm wide	734-430	50 (25)
75 mm wide	734-431	50 (25)



WMB Inline, plain; 1,500 WMB markers (5 mm)/reel; 5 ... 5.2 mm stretchable

white	2009-115	1
-------	----------	---



Marking strip; plain; 11 mm wide; 50 m reel

white	2009-110	1
-------	----------	---



WMB marking card; white; 10 strips with 10 markers/card; 5 ... 5.2 mm stretchable

plain	793-5501	5
-------	----------	---



WMB marking card; plain; 10 strips with 10 markers/card; 5 ... 5.2 mm stretchable

yellow	793-5501/000-002	5
red	793-5501/000-005	5
blue	793-5501/000-006	5
gray	793-5501/000-007	5
orange	793-5501/000-012	5
light green	793-5501/000-017	5
green	793-5501/000-023	5
violet	793-5501/000-024	5





## Technical Data

0.25 ... 2.5 (4) mm<sup>2</sup> ① | 22 ... 12 AWG

690 V/6 kV/3 ② | 600 V, 20 A ③

I<sub>N</sub> 24 A (32 A) ③ | 600 V, 20 A ③

Module width: 5.2 mm / 0.205 inch

10 ... 12 mm / 0.39 ... 0.47 inch

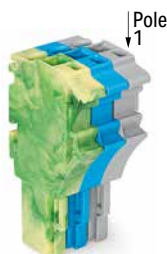

① Conductor range: 0.25 ... 4 mm<sup>2</sup> "s+f-st";  
Push-in termination: 1 ... 4 mm<sup>2</sup> "s" and 1 ... 2.5 mm<sup>2</sup> "insulated ferrules, 12 mm"  
Depending on the conductor characteristic, a conductor with a smaller cross section can also be inserted via push-in termination.

② 690 V = rated voltage  
6 kV = rated impulse voltage  
3 = pollution degree

③ Current-carrying capacity curves upon request

**Note:**

According to EN 61984, pluggable connectors without a current interrupting capacity must not be mated or unmated when live or under load.

Approvals and corresponding ratings, visit [www.wago.com](http://www.wago.com)

1-conductor female plug; with ground end module (green-yellow); fits into carrier terminal blocks; codable

Pole No.	Item No.	Pack. Unit
3	2022-103/000-039	100
4	2022-104/000-039	100
5	2022-105/000-039	50
6	2022-106/000-039	50
7	2022-107/000-039	50
8	2022-108/000-039	50
9	2022-109/000-039	50
10	2022-110/000-039	25
11	2022-111/000-039	25
12	2022-112/000-039	25
13	2022-113/000-039	25
14	2022-114/000-039	25
15	2022-115/000-039	25

Sold & Serviced By:

 **ELECTROMATE**

Toll Free Phone (877) SERV098

[www.electromate.com](http://www.electromate.com)

[sales@electromate.com](mailto:sales@electromate.com)

# 1-Conductor Female Plug X-COM®S-SYSTEM; with Lateral Locking Lever and Strain Relief Plate 2.5 (4) mm<sup>2</sup>; 2022 Series

Technical Data	
0.25 ... 2.5 (4) mm <sup>2</sup> ①	22 ... 12 AWG
690 V/6 kV/3 ②	600 V, 20 A ③
I <sub>N</sub> 24 A (32 A) ④	600 V, 20 A ⑤
Module width: 5.2 mm / 0.205 inch	
 10 ... 12 mm / 0.39 ... 0.47 inch	

Technical Data	
0.25 ... 2.5 (4) mm <sup>2</sup> ①	22 ... 12 AWG
690 V/6 kV/3 ②	600 V, 20 A ③
I <sub>N</sub> 24 A (32 A) ④	600 V, 20 A ⑤
Module width: 5.2 mm / 0.205 inch	
 10 ... 12 mm / 0.39 ... 0.47 inch	

Technical Data	
0.25 ... 2.5 (4) mm <sup>2</sup> ①	22 ... 12 AWG
690 V/6 kV/3 ②	600 V, 20 A ③
I <sub>N</sub> 24 A (32 A) ④	600 V, 20 A ⑤
Module width: 5.2 mm / 0.205 inch	
 10 ... 12 mm / 0.39 ... 0.47 inch	

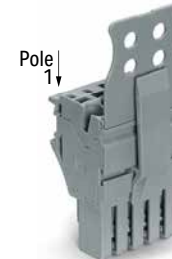

1-conductor female plug; with locking lever; fits into carrier terminal blocks; codable; gray

Pole No.	Item No.	Pack. Unit
○ 1	2022-101/122-000	200
○ 2	2022-102/122-000	100
○ 3	2022-103/123-000	100
○ 4	2022-104/123-000	50
○ 5	2022-105/123-000	50
○ 6	2022-106/123-000	50
○ 7	2022-107/123-000	25
○ 8	2022-108/123-000	25
○ 9	2022-109/123-000	25
○ 10	2022-110/123-000	25
○ 11	2022-111/126-000	25
○ 12	2022-112/126-000	20
○ 13	2022-113/126-000	20
○ 14	2022-114/126-000	10
○ 15	2022-115/127-000	10

1-conductor female plug; with strain relief plate; fits into carrier terminal blocks; codable; gray

Pole No.	Item No.	Pack. Unit
○ 1	2022-101/132-000	200
○ 2	2022-102/132-000	100
○ 3	2022-103/133-000	100
○ 4	2022-104/133-000	50
○ 5	2022-105/134-000	50
○ 6	2022-106/134-000	50
○ 7	2022-107/135-000	25
○ 8	2022-108/135-000	25
○ 9	2022-109/135-000	25
○ 10	2022-110/135-000	25
○ 11	2022-111/136-000	25
○ 12	2022-112/136-000	20
○ 13	2022-113/136-000	20
○ 14	2022-114/136-000	10
○ 15	2022-115/137-000	10

1-conductor female plug; with strain relief plate and locking lever; fits into carrier terminal blocks; codable; gray

Pole No.	Item No.	Pack. Unit
○ 1	2022-101/142-000	200
○ 2	2022-102/142-000	100
○ 3	2022-103/143-000	100
○ 4	2022-104/143-000	50
○ 5	2022-105/144-000	50
○ 6	2022-106/144-000	50
○ 7	2022-107/145-000	25
○ 8	2022-108/145-000	25
○ 9	2022-109/145-000	25
○ 10	2022-110/145-000	25
○ 11	2022-111/146-000	25
○ 12	2022-112/146-000	20
○ 13	2022-113/146-000	20
○ 14	2022-114/146-000	10
○ 15	2022-115/147-000	10

1-conductor female plug; with locking lever; fits into carrier terminal blocks; codable

● 1 blue	2022-101/122-006	200
● 1 green-yellow	2022-101/122-016	200

1-conductor female plug; with strain relief plate; fits into carrier terminal blocks; codable

● 1 blue	2022-101/132-006	200
● 1 green-yellow	2022-101/132-016	200

1-conductor female plug; with strain relief plate and locking lever; fits into carrier terminal blocks; codable

● 1 blue	2022-101/142-006	200
● 1 green-yellow	2022-101/142-016	200

## Accessories; for female plugs

Appropriate marking systems: WMB/WMB Inline/Marking strips

Insulation stop; 5 pcs/strip; 0.25 ... 0.5 mm<sup>2</sup>

light gray 2002-171 200 (25)



Insulation stop; 5 pcs/strip; 0.75 ... 1 mm<sup>2</sup>

dark gray 2002-172 200 (25)



Protective warning marker; with black high-voltage symbol; for 5 terminal blocks

yellow 2002-115 100 (25)



Carrier with 6 coding pins; for coding female plugs

orange 2022-100 100 (25)



WMB Inline, plain; 1,500 WMB markers (5 mm)/reel; 5 ... 5.2 mm stretchable

white 2009-115 1



Marking strip; plain; 11 mm wide; 50 m reel

white 2009-110 1



WMB marking card; white; 10 strips with 10 markers/card; 5 ... 5.2 mm stretchable

plain 793-5501 5



WMB marking card; plain; 10 strips with 10 markers/card; 5 ... 5.2 mm stretchable

yellow 793-5501/000-002 5

red 793-5501/000-005 5

blue 793-5501/000-006 5

gray 793-5501/000-007 5

orange 793-5501/000-012 5

light green 793-5501/000-017 5

green 793-5501/000-023 5

violet 793-5501/000-024 5



① Conductor range: 0.25 ... 4 mm<sup>2</sup> "s+f-st";  
 Push-in termination: 1 ... 4 mm<sup>2</sup> "s" and 1 ... 2.5 mm<sup>2</sup>  
 "insulated ferrules, 12 mm"  
 Depending on the conductor characteristic, a conductor with a smaller cross section can also be inserted via push-in termination.

② 690 V = rated voltage  
 6 kV = rated impulse voltage  
 3 = pollution degree

③ Current-carrying capacity curves upon request

**Note:**

According to EN 61984, pluggable connectors without a current interrupting capacity must not be mated or unmated when live or under load.

Approvals and corresponding ratings, visit [www.wago.com](http://www.wago.com)

Strain Relief Plate (SRP), Gray			Locking Lever (LL), Gray				SRP and LL, Gray	
Assembled			Assembled				Assembled	
SRP			Pole No.	Quantity	1-Way	2-Way		
Item No. Suffix			Item No. Suffix				Item No. Suffix	
Item No.	Color	Width						
734-327	gray	6mm	/132-0xx	1 to 2	1	/122-0xx	-	/142-0xx
734-328	gray	12.5mm	/133-0xx	3 to 4	1	-	/123-0xx	/143-0xx
734-329	gray	25mm	/134-0xx	5 to 6	1	-	/123-0xx	/144-0xx
734-326	gray	35mm	/135-0xx	7 to 10	1	-	/123-0xx	/145-0xx
734-430	gray	55mm	/136-0xx	11 to 14	2	-	/126-0xx	/146-0xx
734-431	gray	75mm	/137-0xx	15	2	-	/127-0xx	/147-0xx

For colored female plugs, the item number suffix "xx" must be replaced by the blue "-006" and the green-yellow "-016" color suffix.

Dimensions of locking levers

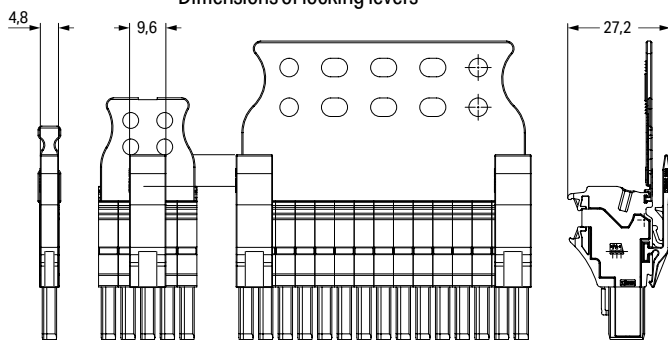

Description	Color	Item No.	Suffix No.
1-conductor female plug	gray	2022-101	none
1- to 15-pole	blue green-yellow	to 2022-115	/000-006 /000-016

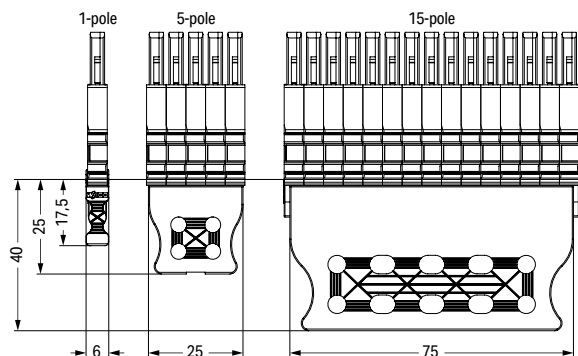
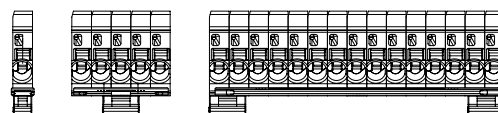

Dimensions of strain relief plates

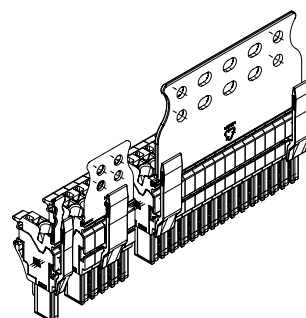

# 1-Conductor/1-Pin Carrier Terminal Block, 2-Conductor/1-Pin Carrier Terminal Block, 2-Conductor/2-Pin Carrier Terminal Block X-COM®S-SYSTEM; for Ex nA Applications

## 2.5 (4) mm<sup>2</sup>; 2022 Series

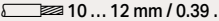
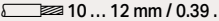
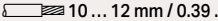
Technical Data		Technical Data		Technical Data	
0.25 ... 2.5 (4) mm <sup>2</sup> ①	22 ... 12 AWG	0.25 ... 2.5 (4) mm <sup>2</sup> ①	22 ... 12 AWG	0.25 ... 2.5 (4) mm <sup>2</sup> ①	22 ... 12 AWG
630 V ②	600 V, 20 A ③	630 V ②	600 V, 20 A ③	630 V ②	600 V, 20 A ③
I <sub>N</sub> 20 A	600 V, 20 A ④	I <sub>N</sub> 20 A	600 V, 20 A ④	I <sub>N</sub> 20 A	600 V, 20 A ④
Terminal block width: 5.2 mm / 0.205 inch		Terminal block width: 5.2 mm / 0.205 inch		Terminal block width: 5.2 mm / 0.205 inch	
 10 ... 12 mm / 0.39 ... 0.47 inch		 10 ... 12 mm / 0.39 ... 0.47 inch		 10 ... 12 mm / 0.39 ... 0.47 inch	

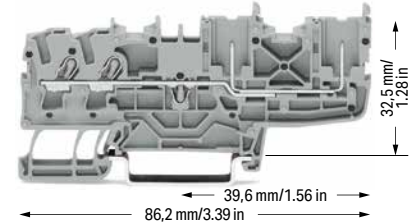
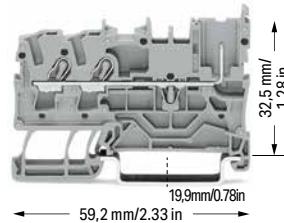
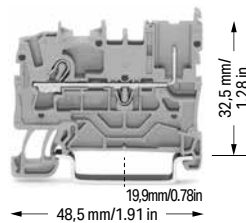

1-conductor/1-pin carrier terminal block; suitable for Ex nA applications

Color	Item No.	Pack. Unit
gray	2022-1201/999-953	100
blue	2022-1204/999-953	100

2-conductor/1-pin carrier terminal block; suitable for Ex nA applications

Color	Item No.	Pack. Unit
gray	2022-1301/999-953	100
blue	2022-1304/999-953	100

2-conductor/2-pin carrier terminal block; suitable for Ex nA applications

Color	Item No.	Pack. Unit
gray	2022-1401/999-953	50
blue	2022-1404/999-953	50

1-conductor/1-pin ground carrier terminal block; suitable for Ex nA applications

green-yellow	2022-1207/999-953	100
--------------	-------------------	-----

2-conductor/1-pin ground carrier terminal block; suitable for Ex nA applications

green-yellow	2022-1307/999-953	100
--------------	-------------------	-----

2-conductor/2-pin ground carrier terminal block; suitable for Ex nA applications

green-yellow	2022-1407/999-953	50
--------------	-------------------	----

Accessories; item-specific

End and intermediate plate; 1 mm thick

orange	2022-1292	100 (25)
gray	2022-1291	100 (25)

Accessories; item-specific

End and intermediate plate; 1 mm thick

orange	2022-1392	100 (25)
gray	2022-1391	100 (25)

Accessories; item-specific

End and intermediate plate; 1 mm thick

orange	2022-1492	100 (25)
gray	2022-1491	100 (25)

Accessories; 2022 Series

Appropriate marking systems: WMB/WMB Inline/Marking strips

Insulation stop; 5 pcs/strip; 0.25 ... 0.5 mm<sup>2</sup>

light gray	2002-171	200 (25)
------------	----------	----------

Insulation stop; 5 pcs/strip; 0.75 ... 1 mm<sup>2</sup>

dark gray	2002-172	200 (25)
-----------	----------	----------

Protective warning marker; with black high-voltage symbol; for 5 terminal blocks

yellow	2002-115	100 (25)
--------	----------	----------

Push-in type jumper bar; insulated; I<sub>N</sub> 25 A; light gray

2-way	2002-402	25
3-way	2002-403	25
4-way	2002-404	25
5-way	2002-405	25
6-way	2002-406	25
7-way	2002-407	25
8-way	2002-408	25
9-way	2002-409	25
10-way	2002-410	25

Push-in type jumper bar; insulated; I<sub>N</sub> 25 A; light gray

1 to 3	2002-433	25
1 to 4	2002-434	25
1 to 5	2002-435	25
1 to 6	2002-436	25
1 to 7	2002-437	25
1 to 8	2002-438	25
1 to 9	2002-439	25
1 to 10	2002-440	25

Staggered jumper; insulated; I<sub>N</sub> 25 A; light gray

2-way	2002-472	25
3-way	2002-473	25
4-way	2002-474	25
5-way	2002-475	25
6-way	2002-476	25
7-way	2002-477	25
8-way	2002-478	25
9-way	2002-479	25
10-way	2002-480	25
11-way	2002-481	25
12-way	2002-482	25

Push-in type wire jumper; insulated; 1.5 mm<sup>2</sup> conductor cross-section; I<sub>N</sub> 18 A

L = 60 mm	2009-412	100 (10)
L = 110 mm	2009-414	100 (10)
L = 250 mm	2009-416	100 (10)

Carrier with 6 coding pins; for coding female plugs

orange	2022-100	100 (25)
--------	----------	----------

Test pin; 1 mm Ø

	859-500	1
--	---------	---

1-conductor female plug; with shorter locking lever; suitable for Ex nA applications; fits into carrier terminal blocks; codable

gray	2022-103/999-953	100
------	------------------	-----

WMB Inline, plain; 1,500 WMB markers (5 mm)/reel; 5 ... 5.2 mm stretchable

white	2009-115	1
-------	----------	---

Marking strip; plain; 11 mm wide; 50 m reel

white	2009-110	1
-------	----------	---

WMB marking card; white; 10 strips with 10 markers/card; 5 ... 5.2 mm stretchable

plain	793-5501	5
-------	----------	---

WMB marking card; plain; 10 strips with 10 markers/card; 5 ... 5.2 mm stretchable

yellow	793-5501/000-002	5
red	793-5501/000-005	5
blue	793-5501/000-006	5
gray	793-5501/000-007	5
orange	793-5501/000-012	5
light green	793-5501/000-017	5
green	793-5501/000-023	5
violet	793-5501/000-024	5

1 Conductor range: 0.25 ... 4 mm<sup>2</sup> "s+f-st";  
 Push-in termination: 1 ... 4 mm<sup>2</sup> "s" and 1 ... 2.5 mm<sup>2</sup>  
 "insulated ferrules, 12 mm"  
 Depending on the conductor characteristic, a conductor with a smaller cross section can also be inserted via push-in termination.

2 630 V = rated voltage for use in Zone 2 hazardous areas, "nA" type of protection

**Note:**

When used as intended, female plugs must not be connected/disconnected when live or under load.

Please observe the application notes:  
 Jumpers, from page 160  
 Marking, from page 246

Approvals and corresponding ratings, visit [www.wago.com](http://www.wago.com)



630 V = rated voltage for use in Zone 2 hazardous areas, "nA" type of protection

"n" refers to an ignition protection class in Zone 2:  
 This zone covers areas in which a dangerous, explosive atmosphere consisting of gases, vapors or dust is unlikely to exist and will only persist for a short period if it does.

"A" means: non-sparking (function modules without relays/ switches)

Ex marking:  
 "Ex" sign and extended item number ".../999-953" are printed on the side of both carrier terminal blocks and female plugs with Ex approval.  
 Shorter locking lever (factory-mounted) makes accidental disconnection more difficult.

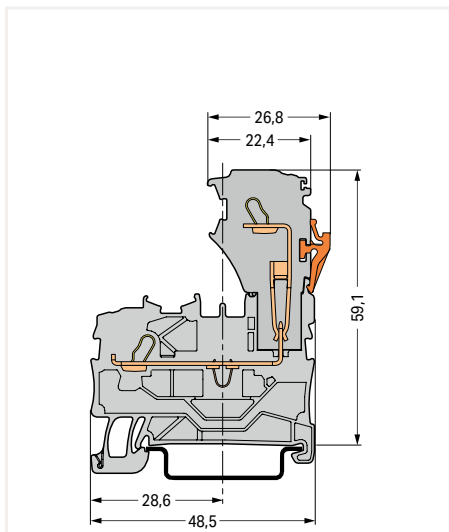

Carrier terminal block

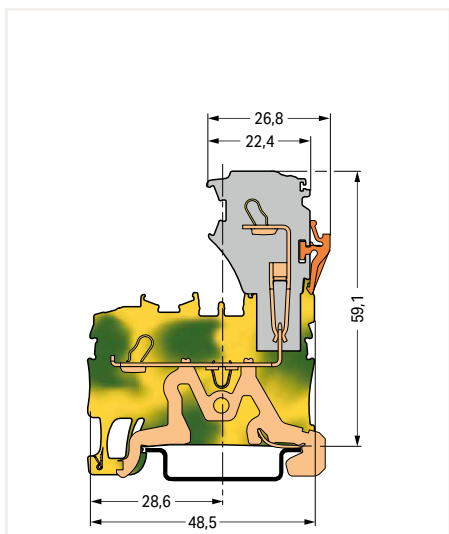

Ground carrier terminal block



# 1-Conductor/1-Pin Double-Deck Carrier Terminal Block X-COM®S-SYSTEM; for Ex nA Applications

## 2.5 (4) mm<sup>2</sup>; 2022 Series

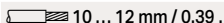
Technical Data	
0.25 ... 2.5 (4) mm <sup>2</sup> ①	22 ... 12 AWG
630 V ②	600 V; 20 A ③
I <sub>N</sub> 20 A	600 V; 20 A ④
Terminal block width: 5.2 mm / 0.205 inch	
 10 ... 12 mm / 0.39 ... 0.47 inch	

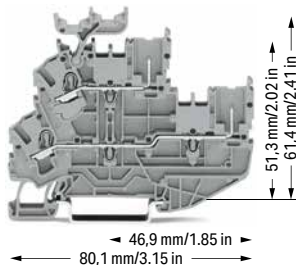

1-conductor/1-pin double-deck carrier terminal block; through/through terminal block; with marker carrier; suitable for Ex nA applications; gray

	Item No.	Pack. Unit
<input type="radio"/> L/L	2022-2231/999-953	50
<input type="radio"/> N/L	2022-2232/999-953	50
<input type="radio"/> L/N	2022-2233/999-953	50

Technical Data	
0.25 ... 2.5 (4) mm <sup>2</sup> ①	22 ... 12 AWG
630 V ②	600 V; 20 A ③
I <sub>N</sub> 20 A	600 V; 20 A ④
Terminal block width: 5.2 mm / 0.205 inch	
 10 ... 12 mm / 0.39 ... 0.47 inch	

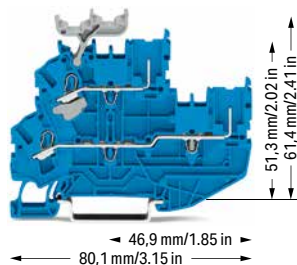

1-conductor/1-pin double-deck carrier terminal block; through/through terminal block; with marker carrier; suitable for Ex nA applications; blue

	Item No.	Pack. Unit
<input checked="" type="radio"/> N/N	2022-2234/999-953	50

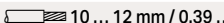
Technical Data	
0.25 ... 2.5 (4) mm <sup>2</sup> ①	22 ... 12 AWG
Terminal block width: 5.2 mm / 0.205 inch	
 10 ... 12 mm / 0.39 ... 0.47 inch	

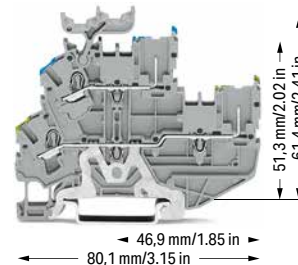

1-conductor/1-pin double-deck carrier terminal block; ground conductor/through terminal block; with marker carrier; for Ex nA applications; gray

	Item No.	Pack. Unit
<input type="radio"/> PE/N	2022-2247/999-953	50
<input type="radio"/> PE/L	2022-2257/999-953	50

Technical Data		
1-conductor/1-pin double-deck carrier terminal block; through/through terminal block; without marker carrier; for Ex nA applications; gray		
<input type="radio"/> L/L	2022-2201/999-953	50
<input type="radio"/> N/L	2022-2202/999-953	50
<input type="radio"/> L/N	2022-2203/999-953	50

Technical Data		
1-conductor/1-pin double-deck carrier terminal block; through/through terminal block; without marker carrier; for Ex nA applications; blue		
<input checked="" type="radio"/> N/N	2022-2204/999-953	50

Technical Data		
1-conductor/1-pin double-deck carrier terminal block; ground conductor/through terminal block; without marker carrier; for Ex nA applications; gray		
<input type="radio"/> PE/N	2022-2217/999-953	50
<input type="radio"/> PE/L	2022-2227/999-953	50

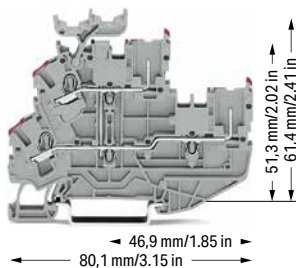

2-conductor/2-pin double-deck carrier terminal block; 2-conductor/2-pin through terminal block; with marker carrier, internally commoned; violet conductor entry; for Ex nA applications; gray

	Item No.	Pack. Unit
<input type="radio"/> L	2022-2238/999-953	50

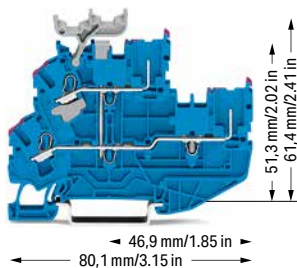

2-conductor/2-pin double-deck carrier terminal block; 2-conductor/2-pin through terminal block; with marker carrier, internally commoned; violet conductor entry; for Ex nA applications; blue

	Item No.	Pack. Unit
<input checked="" type="radio"/> N	2022-2239/999-953	50

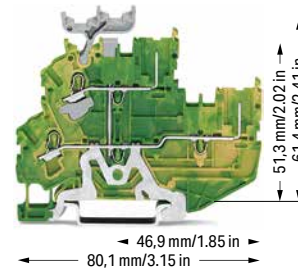

2-conductor/2-pin double-deck carrier block; 2-conductor/2-pin ground conductor block; with marker carrier; internally commoned; for Ex nA applications; green-yellow

	Item No.	Pack. Unit
<input checked="" type="radio"/> PE	2022-2237/999-953	50

Technical Data		
2-conductor/2-pin double-deck carrier terminal block; 2-conductor/2-pin through terminal block; without marker carrier, internally commoned; violet conductor entry; for Ex nA applications; gray		
<input type="radio"/> L	2022-2208/999-953	50

Technical Data		
2-conductor/2-pin double-deck carrier terminal block; 2-conductor/2-pin through terminal block; without marker carrier, internally commoned; violet conductor entry; for Ex nA applications; blue		
<input checked="" type="radio"/> N	2022-2209/999-953	50

Technical Data		
2-conductor/2-pin double-deck carrier block; 2-conductor/2-pin ground conductor block; without marker carrier; internally commoned; for Ex nA applications; green-yellow		
<input checked="" type="radio"/> PE	2022-2207/999-953	50

① Conductor range: 0.25 ... 4 mm<sup>2</sup> "s+f-st";  
Push-in termination: 1 ... 4 mm<sup>2</sup> "s" and 1 ... 2.5 mm<sup>2</sup>  
"insulated ferrules, 12 mm"  
Depending on the conductor characteristic, a conductor  
with a smaller cross section can also be inserted  
via push-in termination.

② 630 V = rated voltage for use in Zone 2 hazardous  
areas, "nA" type of protection  
with double-deck vertical jumper,

**Note:**

When used as intended, female plugs must not be  
connected/disconnected when live or under load.

Please observe the application notes:  
Jumpers, from page 160  
Marking, from page 246

Approvals and corresponding ratings,  
visit [www.wago.com](http://www.wago.com)

**Accessories; 2022 Series**

Appropriate marking systems:  
WMB/WMB Inline/Marking strips

**End and intermediate plate; 1 mm thick**

	orange	2022-2292	100 (25)
	gray	2022-2291	100 (25)

**Insulation stop; 5 pcs/strip; 0.25 ... 0.5 mm<sup>2</sup>**

	light gray	2002-171	200 (25)
---	------------	----------	----------

**Insulation stop; 5 pcs/strip; 0.75 ... 1 mm<sup>2</sup>**

	dark gray	2002-172	200 (25)
---	-----------	----------	----------

**Protective warning marker; with black high-voltage  
symbol; for 5 terminal blocks**

	yellow	2002-115	100 (25)
---	--------	----------	----------

**Push-in type jumper bar; insulated; I<sub>n</sub> 25 A; light gray**

	2-way	2002-402	25
	3-way	2002-403	25
	4-way	2002-404	25
	5-way	2002-405	25
	6-way	2002-406	25
	7-way	2002-407	25
	8-way	2002-408	25
	9-way	2002-409	25
	10-way	2002-410	25

**Push-in type jumper bar; insulated; I<sub>n</sub> 25 A; light gray**

	1 to 3	2002-433	25
	1 to 4	2002-434	25
	1 to 5	2002-435	25
	1 to 6	2002-436	25
	1 to 7	2002-437	25
	1 to 8	2002-438	25
	1 to 9	2002-439	25
	1 to 10	2002-440	25

**Double-deck vertical jumper; insulated; I<sub>n</sub> 24 A**

	light gray	2002-492	100 (25)
	orange	2002-492/000-012	100 (25)

**Accessories; 2022 Series**

Appropriate marking systems:  
WMB/WMB Inline/Marking strips

**Adjacent jumper for continuous commoning; insulated;  
I<sub>n</sub> 25 A, light gray**

	2-way	2002-400	25
---	-------	----------	----

**Adjacent jumper for continuous commoning; insulated;  
I<sub>n</sub> 25 A; 1 to 3**

	light gray	2002-423	25
	red	2002-423/000-005	25
	blue	2002-423/000-006	25

**Adjacent jumper for continuous commoning; insulated;  
I<sub>n</sub> 25 A, light gray**

	5-way	2002-415	25
---	-------	----------	----

**Carrier with 6 coding pins; for coding female plugs**

	orange	2022-100	100 (25)
---	--------	----------	----------

**Test pin; 1 mm Ø**

		859-500	1
---	--	---------	---

**1-conductor female plug; with shorter locking lever;  
suitable for Ex nA applications; fits into carrier terminal  
blocks; codable**

	gray	2022-103/999-953	100
---	------	------------------	-----

**WMB Inline, plain; 1,500 WMB markers (5 mm)/reel;  
5 ... 5.2 mm stretchable**

	white	2009-115	1
---	-------	----------	---

**Marking strip; plain; 11 mm wide; 50 m reel**

	white	2009-110	1
---	-------	----------	---

**WMB marking card; white; 10 strips with 10 markers/card;  
5 ... 5.2 mm stretchable**

	plain	793-5501	5
---	-------	----------	---

**WMB marking card; plain; 10 strips with 10 markers/card;  
5 ... 5.2 mm stretchable**

	yellow	793-5501/000-002	5
	red	793-5501/000-005	5
	blue	793-5501/000-006	5
	gray	793-5501/000-007	5
	orange	793-5501/000-012	5
	light green	793-5501/000-017	5
	green	793-5501/000-023	5
	violet	793-5501/000-024	5

**Double-deck marker carrier; pivoting**

	gray	2002-121	50 (25)
---	------	----------	---------

**Screwless end stop; for DIN-35 rail; 6 mm wide**

	gray	249-116	100 (25)
---	------	---------	----------

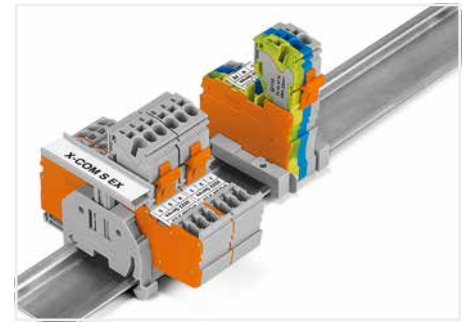

Group marking with height-adjustable group marker carrier (2009-163)

# 1-Conductor Female Plug X-COM®S-SYSTEM; for Ex nA Applications

## 2.5 (4) mm<sup>2</sup>; 2022 Series

### Technical Data

0.25 ... 2.5 (4) mm<sup>2</sup> ① 22 ... 12 AWG

630 V ② 600 V, 20 A

I<sub>N</sub> 20 A 600 V, 20 A

Module width: 5.2 mm / 0.205 inch

10 ... 12 mm / 0.39 ... 0.47 inch

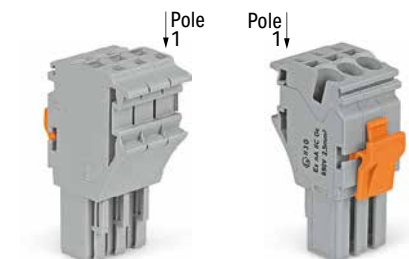

Dimensions (in mm):

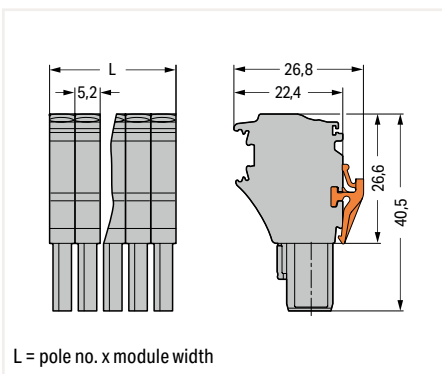

1-conductor female plug; with shorter locking lever; suitable for Ex nA applications; fits into carrier terminal blocks; codable; gray  
According to EN 61984, pluggable connectors without a current interrupting capacity must not be mated or unmated when live or under load.

Pole No.	Item No.	Pack. Unit
2	2022-102/999-953	200
3	2022-103/999-953	100
4	2022-104/999-953	100
5	2022-105/999-953	50
6	2022-106/999-953	50
7	2022-107/999-953	50
8	2022-108/999-953	50

① Conductor range: 0.25 ... 4 mm<sup>2</sup> "s+f-st"; Push-in termination: 1 ... 4 mm<sup>2</sup> "s" and 1 ... 2.5 mm<sup>2</sup> "insulated ferrules, 12 mm"  
Depending on the conductor characteristic, a conductor with a smaller cross section can also be inserted via push-in termination.

② 630 V = rated voltage for use in Zone 2 hazardous areas, "nA" type of protection

Approvals and corresponding ratings, visit [www.wago.com](http://www.wago.com)

### Accessories; for female plugs

Appropriate marking systems:  
WMB/WMB Inline/Marking strips

Insulation stop; 5 pcs/strip; 0.25 ... 0.5 mm<sup>2</sup>

light gray 2002-171 200 (25)



Insulation stop; 5 pcs/strip; 0.75 ... 1 mm<sup>2</sup>

dark gray 2002-172 200 (25)



Protective warning marker; with black high-voltage symbol; for 5 terminal blocks

yellow 2002-115 100 (25)



Carrier with 6 coding pins; for coding female plugs

orange 2022-100 100 (25)



Strain relief plate; gray

35 mm wide	734-326	100 (25)
6 mm wide	734-327	100 (25)
12.5 mm wide	734-328	100 (25)
25 mm wide	734-329	100 (25)
55 mm wide	734-430	50 (25)
75 mm wide	734-431	50 (25)



WMB Inline, plain; 1,500 WMB markers (5 mm)/reel; 5 ... 5.2 mm stretchable

white 2009-115 1



Marking strip; plain; 11 mm wide; 50 m reel

white 2009-110 1



WMB marking card; white; 10 strips with 10 markers/card; 5 ... 5.2 mm stretchable

plain 793-5501 5



WMB marking card; plain; 10 strips with 10 markers/card; 5 ... 5.2 mm stretchable

yellow	793-5501/000-002	5
red	793-5501/000-005	5
blue	793-5501/000-006	5
gray	793-5501/000-007	5
orange	793-5501/000-012	5
light green	793-5501/000-017	5
green	793-5501/000-023	5
violet	793-5501/000-024	5



Each female plug is supplied with a locking lever.

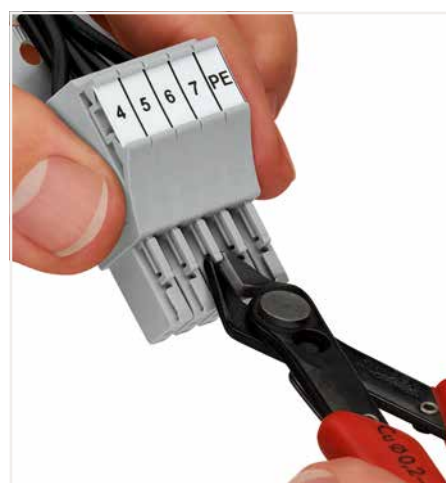

Coding a female plug: remove coding finger using a suitable tool.

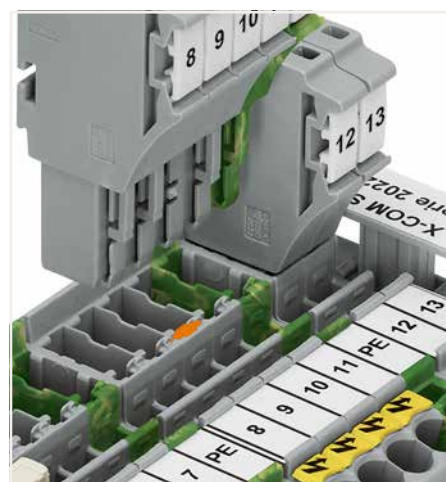

Insert a coding pin (2022-100) into the corresponding location of the carrier terminal block.

## Pre-Assembled 1-Conductor Female Plug X-COM®S-SYSTEM; for Ex nA Applications 2.5 (4) mm<sup>2</sup>; 2022 Series

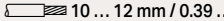
Technical Data	
0.25 ... 2.5 (4) mm <sup>2</sup> ①	22 ... 12 AWG
630 V ②	600 V, 20 A $\overline{A}$
I <sub>N</sub> 20 A	600 V, 20 A $\overline{A}$
Module width: 5.2 mm / 0.205 inch	
 10 ... 12 mm / 0.39 ... 0.47 inch	

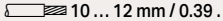
Technical Data	
0.25 ... 2.5 (4) mm <sup>2</sup> ①	22 ... 12 AWG
630 V ②	600 V, 20 A $\overline{A}$
I <sub>N</sub> 20 A	600 V, 20 A $\overline{A}$
Module width: 5.2 mm / 0.205 inch	
 10 ... 12 mm / 0.39 ... 0.47 inch	

① Conductor range: 0.25 ... 4 mm<sup>2</sup> "s+f-st"; Push-in termination: 1 ... 4 mm<sup>2</sup> "s" and 1 ... 2.5 mm<sup>2</sup> "insulated ferrules, 12 mm"  
Depending on the conductor characteristic, a conductor with a smaller cross section can also be inserted via push-in termination.

② 630 V = rated voltage for use in Zone 2 hazardous areas, "nA" type of protection

### Note:

According to EN 61984, pluggable connectors without a current interrupting capacity must not be mated or unmated when live or under load.

Approvals and corresponding ratings, visit [www.wago.com](http://www.wago.com)



1-conductor female plug; with shorter locking lever; with ground base module (green-yellow); fits into carrier terminal blocks; codable

Pole No.	Item No.	Pack. Unit
3	2022-103/000-038/999-953	100
4	2022-104/000-038/999-953	100
5	2022-105/000-038/999-953	50
6	2022-106/000-038/999-953	50

1-conductor female plug; with shorter locking lever; with ground end module (green-yellow); fits into carrier terminal blocks; codable

Pole No.	Item No.	Pack. Unit
3	2022-103/000-039/999-953	100
4	2022-104/000-039/999-953	100
5	2022-105/000-039/999-953	50
6	2022-106/000-039/999-953	50

### Accessories; for female plugs

Appropriate marking systems: WMB/WMB Inline/Marking strips

Insulation stop; 5 pcs/strip; 0.25 ... 0.5 mm <sup>2</sup>			
	light gray	2002-171	200 (25)

Insulation stop; 5 pcs/strip; 0.75 ... 1 mm <sup>2</sup>			
	dark gray	2002-172	200 (25)

Protective warning marker; with black high-voltage symbol; for 5 terminal blocks			
	yellow	2002-115	100 (25)

Carrier with 6 coding pins; for coding female plugs			
	orange	2022-100	100 (25)

Strain relief plate; gray			
	35 mm wide	734-326	100 (25)
	6 mm wide	734-327	100 (25)
	12.5 mm wide	734-328	100 (25)
	25 mm wide	734-329	100 (25)
	55 mm wide	734-430	50 (25)
	75 mm wide	734-431	50 (25)

WMB Inline, plain; 1,500 WMB markers (5 mm)/reel; 5 ... 5.2 mm stretchable			
	white	2009-115	1

Marking strip; plain; 11 mm wide; 50 m reel			
	white	2009-110	1

WMB marking card; white; 10 strips with 10 markers/card; 5 ... 5.2 mm stretchable			
	plain	793-5501	5

WMB marking card; plain; 10 strips with 10 markers/card; 5 ... 5.2 mm stretchable			
	yellow	793-5501/000-002	5
	red	793-5501/000-005	5
	blue	793-5501/000-006	5
	gray	793-5501/000-007	5
	orange	793-5501/000-012	5
	light green	793-5501/000-017	5
	green	793-5501/000-023	5
	violet	793-5501/000-024	5

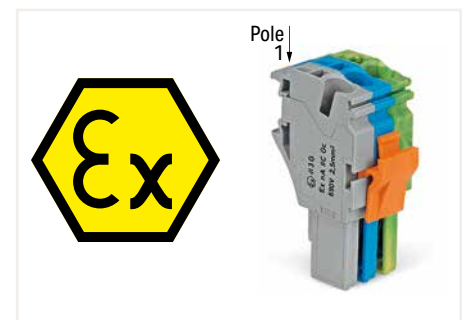

### Ex marking:

"Ex" sign and extended item number ".../999-953" are printed on the side of both carrier terminal blocks and female plugs with Ex approval. Shorter locking lever (factory-mounted) makes accidental disconnection more difficult.



# MULTILEVEL INSTALLATION TERMINAL BLOCKS

## For Building Installations and Industrial Applications

### Multilevel Installation Terminal Blocks with N-Disconnect Slide Links for Mounting with N-busbar

- Configure larger circuit groups
- Automatically and permanently connect to the N-busbar by simply sliding the screwless N-disconnect link

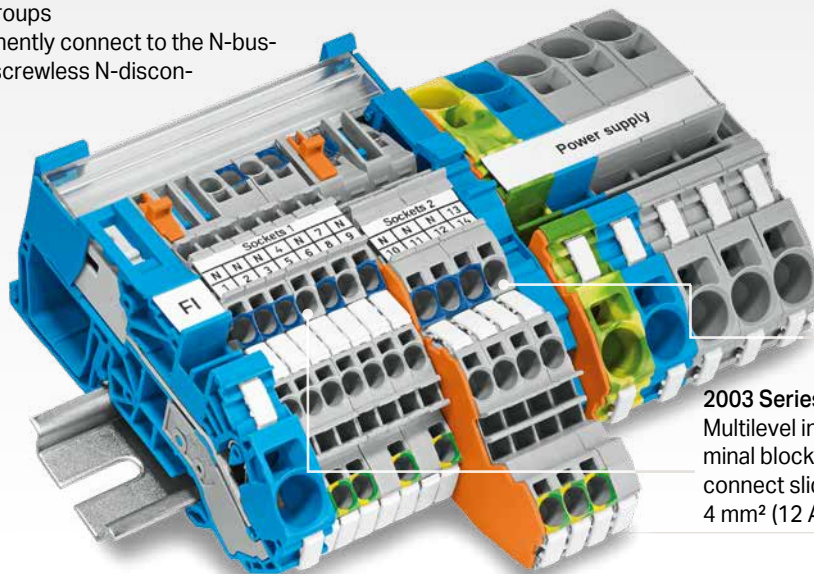

**2005 Series**  
Multilevel installation terminal blocks with an N-disconnect slide link up to 6 mm<sup>2</sup> (10 AWG), 36 A

**2003 Series**  
Multilevel installation terminal blocks with an N-disconnect slide link up to 4 mm<sup>2</sup> (12 AWG), 32 A

### Maximum Touch-Proof Safety

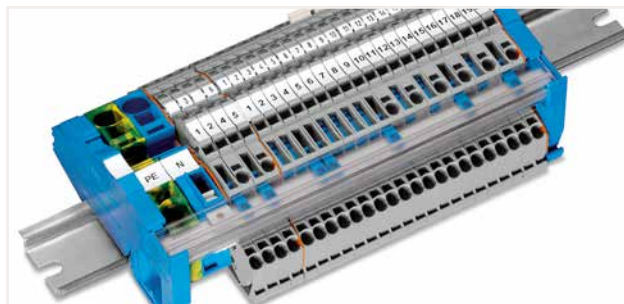

- Transparent busbar cover provides touch protection for the busbar.
- Cover enables user to see if N-disconnect slide links are connected to the N-busbar.

### Maximum Wiring Space



- 2003 and 2005 Series Multilevel Installation Terminal Blocks feature extremely compact dimensions while providing all of the functionality of a 4 mm<sup>2</sup> or 6 mm<sup>2</sup> terminal block.
- Maximize wiring space in standard distribution cabinets.



## Multilevel Installation Terminal Blocks with Internal N-Disconnection for Mounting without N-Busbar

- Configure smaller circuit groups, e.g., in installations with multiple RCD potentials.
- Internal N-knife disconnect enables N-potential disconnection within the terminal block by opening the the knife disconnect.

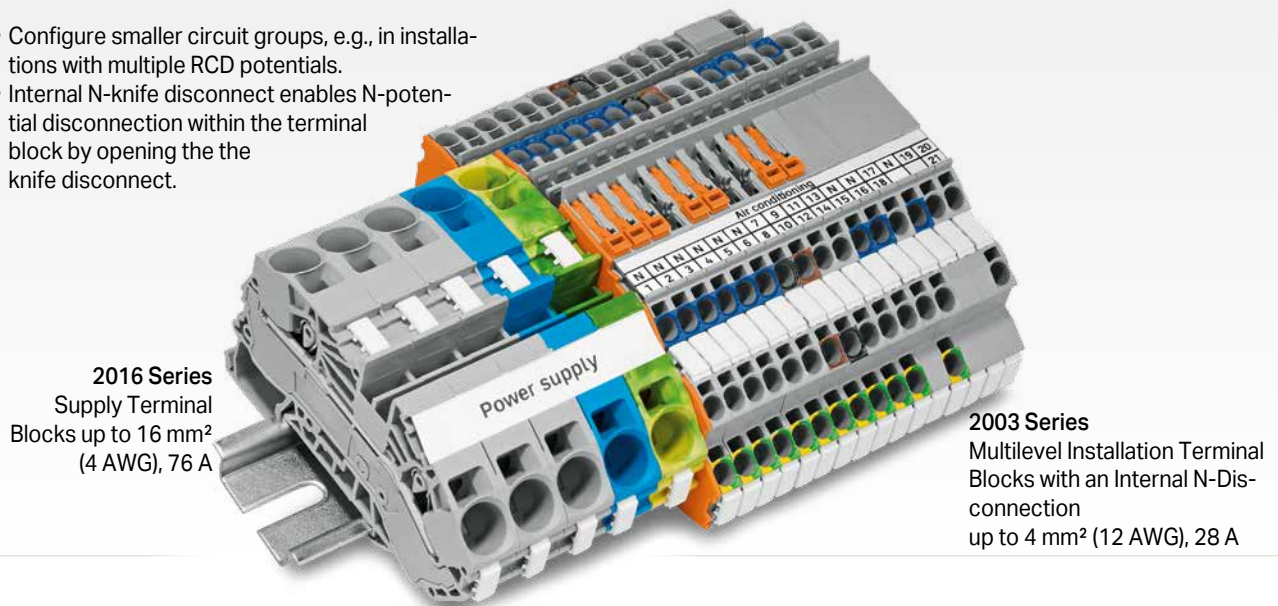

**2016 Series**  
Supply Terminal  
Blocks up to 16 mm<sup>2</sup>  
(4 AWG), 76 A

**2003 Series**  
Multilevel Installation Terminal  
Blocks with an Internal N-Dis-  
connection  
up to 4 mm<sup>2</sup> (12 AWG), 28 A

## Insulation Resistance Measurement – Fast and Safe



- Disconnect N-potential via pivoting knife disconnect.
- Plug N/L test adapter into the free shaft to link N and L conductors.
- Measurement with connected live conductors halves testing times and protects the connected devices against high test voltage.

## Multilevel Installation Terminal Blocks as Fuse Terminal Block

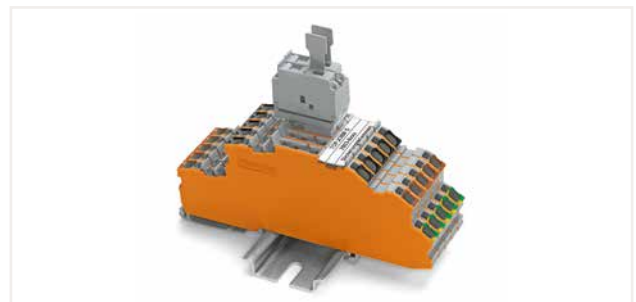

- Multilevel installation terminal blocks carry a centered slot, allowing them to be used as fuse terminal blocks in a standard distribution board's cutout.
- The fuse plugs can be used in combination with an end and intermediate plate (1 mm/0.039 inch thick).

# Installation Rail-Mount Terminal Blocks TOPJOB® S

## Installation

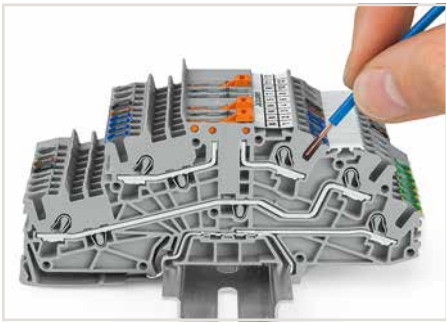

Inserting a conductor via push-in termination. Solid conductors with cross-sections from either one size above, or up to two sizes below, the rated cross-section can be simply pushed in – no tools needed.

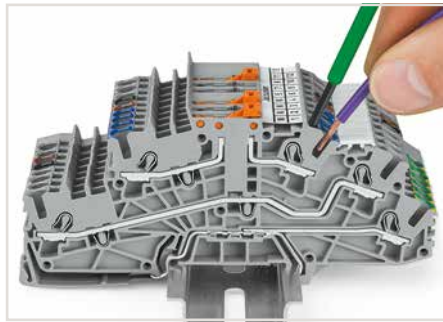

Inserting a conductor via operating tool. Connecting fine-stranded conductors without ferrules, or small cross-sectional conductors that cannot be pushed in, is performed similarly to the original CAGE CLAMP® – just use an operating tool.

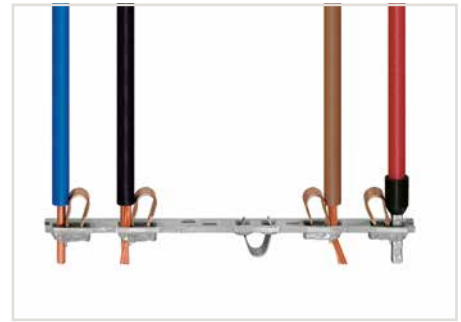

All conductor types at a glance

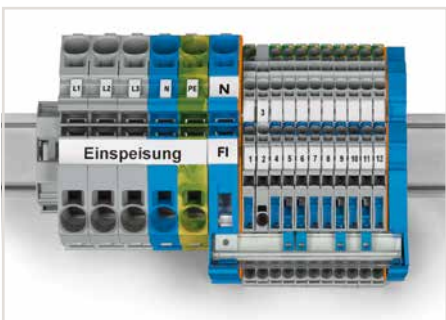

Mounting busbars on busbar carriers: Insert busbar ends onto large busbar carriers (2009-305) or onto supply terminal blocks with an integrated busbar carrier.

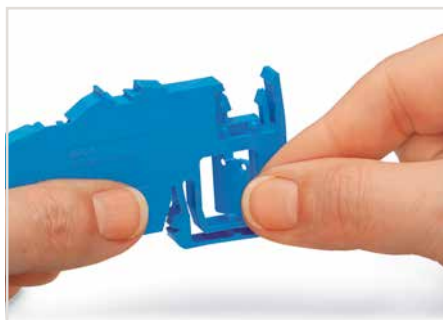

Removing the separator plate from the busbar carrier or from the N-disconnect terminal block.

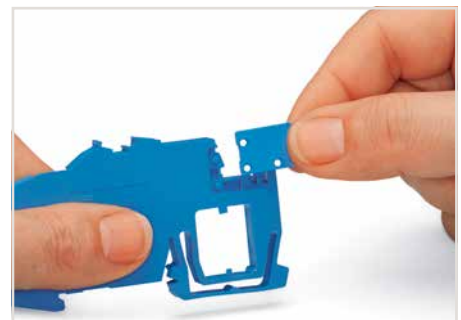

Inserting the separator plate into the busbar carrier to protect the N-busbar against accidental contact.



Inserting separator plate removed from N-disconnect terminal block.

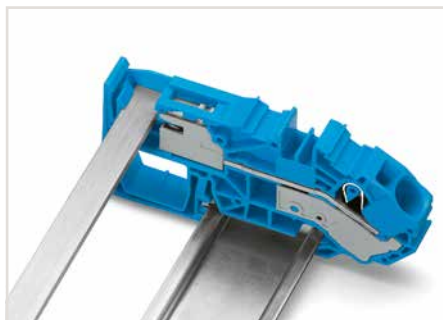

Touch-proof N-busbar via inserted separator plate

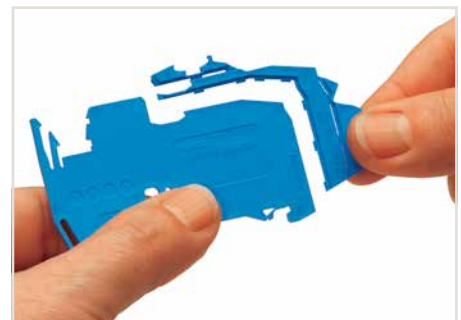

Perforations make it possible to fit the carrier to all Installation Rail-Mount Terminal Blocks TOPJOB® S using a single part.



The compact busbar carrier (1.5 mm thick), which is placed every 200 mm, provides additional busbar support for longer assemblies.

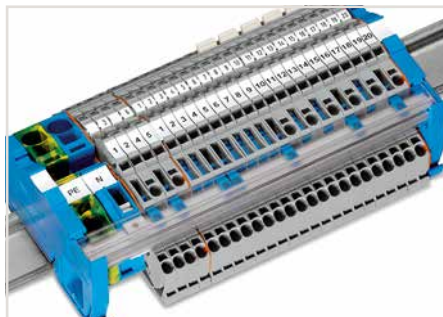

The busbar transparent cover (Item No. 777-303) protects the busbar against accidental contact and makes it easy to see which terminal blocks are connected to the busbar.



Tool-operated N-disconnect slide link



Push-in CAGE CLAMP® terminates the following copper conductors: solid "s"



stranded "st"



fine-stranded "f-st", also with tinned single strands

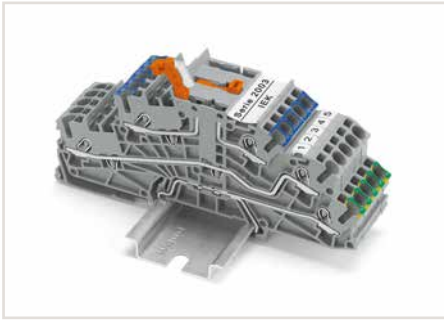

N-potential disconnection via N-knife disconnect within a terminal block assembly without a busbar.



For multilevel installation terminal blocks with internal N-disconnection, test plug adapters can be inserted into the free vertical test slot when the N-potential is disconnected.

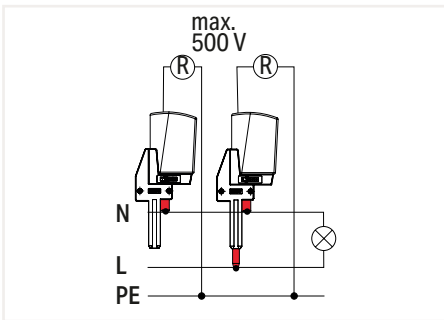

Test plug adapters for both individual N-potential measurement and insulation resistance measurement of the connected N- and L-potentials are available.

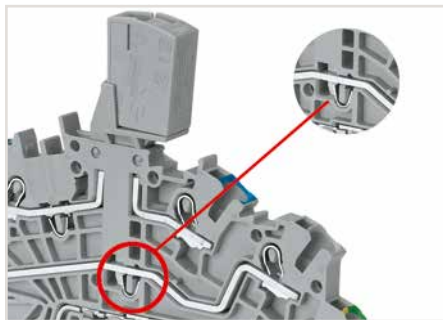

Multilevel installation terminal block fitted with an N/L-test plug adapter for quick and safe insulation resistance measurement of the connected N- and L-potentials

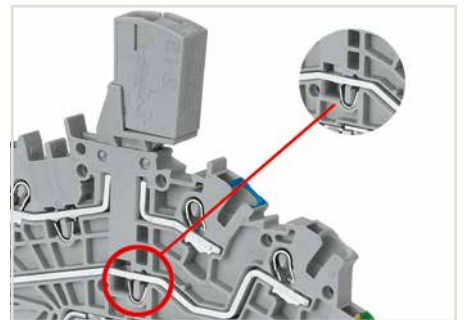

Multilevel installation terminal block fitted with an N-test plug adapter for insulation resistance measurement of the N-potential

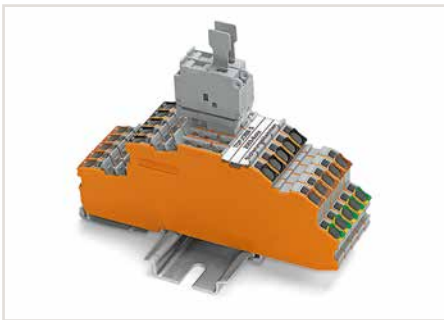

Single-fuse plugs can be used in combination with 1 mm thick end and intermediate plates on carrier terminal blocks without an N-knife disconnect.



Double-fuse plugs with 5 x 25 mm glass cartridge fuses can be used on carrier terminal blocks without an N-knife disconnect in standard terminal block width.

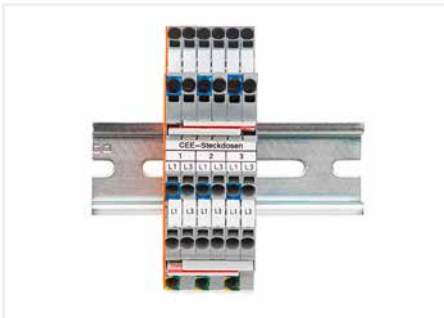

Commoning two potentials in one single jumper slot via extremely slim staggered jumpers.

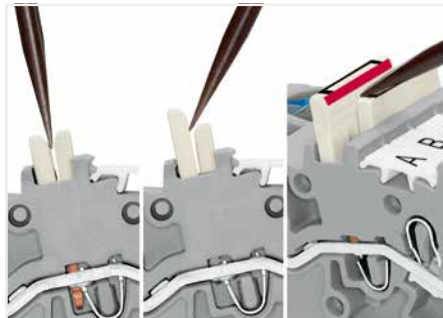

Insert the operating tool between the staggered jumpers, then lift up the jumper.



fine-stranded, tip-bonded



fine-stranded, with ferrule (gastight crimped)





fine-stranded, with pin terminal (gastight crimped)



# Multilevel Installation Terminal Block TOPJOB® S; with N-Disconnect Slide Link

## 2.5 (4) mm<sup>2</sup>; 2003 Series

Technical Data	
0.25 ... 2.5 (4) mm <sup>2</sup> ①	22 ... 12 AWG
250 V/4 kV/3; 32 A (32 A) ②	
400 V/6 kV/3; 32 A (32 A) ②	
Terminal block width: 5.2 mm / 0.205 inch	
 10 ... 12 mm / 0.39 ... 0.47 inch	

Technical Data	
0.25 ... 2.5 (4) mm <sup>2</sup> ①	22 ... 12 AWG
400 V/6 kV/3 ②	
I <sub>N</sub> 32 A	
Terminal block width: 5.2 mm / 0.205 inch	
 10 ... 12 mm / 0.39 ... 0.47 inch	

- ① Conductor range: 0.25 ... 4 mm<sup>2</sup> "s+f-st"; Push-in termination: 1 ... 4 mm<sup>2</sup> "s" and 1 ... 2.5 mm<sup>2</sup> "insulated ferrules, 12 mm"  
Depending on the conductor characteristic, a conductor with a smaller cross section can also be inserted via push-in termination.
  - ② 250 V / 400 V = rated voltage  
4 kV / 6 kV = rated impulse voltage  
3 = pollution degree  
250 V/4 kV potential – ground  
400 V/6 kV potential – potential
- Please observe the application notes:  
Jumpers, from page 160  
Testing accessories, page 159  
Marking, from page 246
- Approvals and corresponding ratings, visit [www.wago.com](http://www.wago.com)

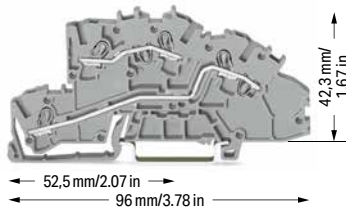
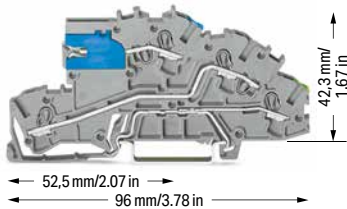

Multilevel installation terminal block; with N-disconnect slide link; gray

	Item No.	Pack. Unit
<input type="radio"/> NT/L/PE	2003-7641	50

Multilevel installation terminal block; gray

	Item No.	Pack. Unit
<input type="radio"/> L/L	2003-7642	50
<input type="radio"/> N/L	2003-7649	50

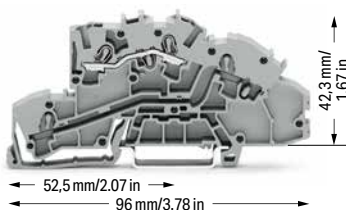
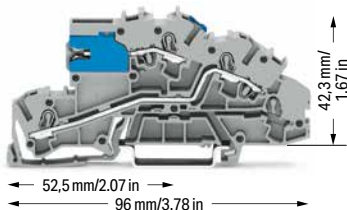

Multilevel installation terminal block; with N-disconnect slide link; gray

	Item No.	Pack. Unit
<input type="radio"/> NT/L	2003-7640	50
<input type="radio"/> LT/L	2003-7659	50

Multilevel installation terminal block; gray

	Item No.	Pack. Unit
<input type="radio"/> L	2003-7650	50
<input type="radio"/> N	2003-7651	50

Multilevel installation terminal block; gray

<input type="radio"/> N/L/PE	2003-7646	50
<input type="radio"/> L/L/PE	2003-7645	50

### Accessories; 2003 Series

Appropriate marking systems: WMB/WMB Inline/Marking strips

End and intermediate plate; 0.8 mm thick		
 orange	2003-7692	100 (25)

Busbar; tin-plated; 1000 mm long; copper (10 x 3) mm		
 I <sub>N</sub> 140 A	210-133	1

Busbar carrier; not suitable as an end stop; snaps onto DIN-35 rail; 1.5 mm thick		
 blue	2009-304	100 (25)

N-supply terminal block; I <sub>N</sub> 76 A; 16 mm <sup>2</sup> ; 12 mm wide		
 blue	2016-7714	20

Busbar carrier; with end stop function and detachable separator plate; snaps onto DIN-35 rail; 7.5 mm thick		
 blue	2009-305	25

Ground supply terminal block; 16 mm <sup>2</sup> ; 12 mm wide		
 green-yellow	2016-7607	20

Busbar cover; 1000 mm long		
 transparent	777-303	1

Connector; for busbar; with blue cover; 2.5 ... 16 mm <sup>2</sup>		
 blue	210-281	100 (50)

Connector; for busbar; 2.5 ... 35 mm <sup>2</sup>		
 unplated	209-105	50

### Accessories; 2003 Series

Appropriate marking systems:  
WMB/WMB Inline/Marking strips

Lock-out; prevents reclosing of slide link; snap-on type		
 orange	2003-7300	100 (25)

Insulation stop; 5 pcs/strip; 0.25 ... 0.5 mm <sup>2</sup>		
 light gray	2002-171	200 (25)

Insulation stop; 5 pcs/strip; 0.75 ... 1 mm <sup>2</sup>		
 dark gray	2002-172	200 (25)

Push-in type jumper bar; insulated; I <sub>N</sub> 25 A; light gray		
 2-way	2002-402	25
3-way	2002-403	25
4-way	2002-404	25
5-way	2002-405	25
6-way	2002-406	25
7-way	2002-407	25
8-way	2002-408	25
9-way	2002-409	25
10-way	2002-410	25

Push-in type jumper bar; insulated; I <sub>N</sub> 25 A; light gray		
 1 to 3	2002-433	25
1 to 4	2002-434	25
1 to 5	2002-435	25
1 to 6	2002-436	25
1 to 7	2002-437	25
1 to 8	2002-438	25
1 to 9	2002-439	25
1 to 10	2002-440	25

Adjacent jumper for continuous commoning; insulated; I <sub>N</sub> 25 A, light gray		
 2-way	2002-400	25

Adjacent jumper for continuous commoning; insulated; I <sub>N</sub> 25 A; 1 to 3		
 light gray	2002-423	25
red	2002-423/000-005	25
blue	2002-423/000-006	25

Adjacent jumper for continuous commoning; insulated; I <sub>N</sub> 25 A, light gray		
 5-way	2002-415	25

## Accessories; 2003 Series

Appropriate marking systems: WMB/WMB Inline/Marking strips

Staggered jumper; insulated; I<sub>N</sub> 25 A; light gray

2-way	2002-472	25
3-way	2002-473	25
4-way	2002-474	25
5-way	2002-475	25
6-way	2002-476	25
7-way	2002-477	25
8-way	2002-478	25
9-way	2002-479	25
10-way	2002-480	25
11-way	2002-481	25
12-way	2002-482	25

Customized staggered jumper; insulated; with contact lugs broken off at the factory and circuit printing; I<sub>N</sub> 25 A; light gray

1-3	2002-473/011-000	25
1-3-5	2002-475/011-000	25
1-3-5-7	2002-477/011-000	25
1-3-5-7-9	2002-479/011-000	25
1-3-5-7-9-11	2002-481/011-000	25

Push-in type wire jumper; insulated; 1.5 mm<sup>2</sup> conductor cross-section; I<sub>N</sub> 18 A

L = 60 mm	2009-412	100 (10)
L = 110 mm	2009-414	100 (10)
L = 250 mm	2009-416	100 (10)

## Test plug adapter; for 4 mm Ø test plug



gray	2009-174	100 (25)
------	----------	----------

## Banana plug; for 4 mm socket diameter; color mixed; 10 x orange, white, black, blue, yellow; max. 42 V



215-111	50
---------	----

Testing tap; for max. 2.5 mm<sup>2</sup>

gray	2009-182	100 (25)
------	----------	----------

## Test plug; with 500 mm cable; 2 mm Ø; max. 42 V



red	210-136	50 (1)
-----	---------	--------

## Test plug; with 500 mm cable; 2.3 mm Ø; max. 42 V



yellow	210-137	50 (1)
--------	---------	--------

## Operating tool; 3.5 mm and 2.5 mm blade width; for Installation Terminal Blocks TOPJOB® S



2009-309	50 (1)
----------	--------

## Operating tool; 3.5 mm and 5.5 mm blade width; for Installation Terminal Blocks TOPJOB® S



2009-310	50 (1)
----------	--------

## WMB Inline, plain; 1,500 WMB markers (5 mm)/reel; 5 ... 5.2 mm stretchable



white	2009-115	1
-------	----------	---

## Marking strip; plain; 11 mm wide; 50 m reel



white	2009-110	1
-------	----------	---

## WMB marking card; white; 10 strips with 10 markers/card; 5 ... 5.2 mm stretchable



plain	793-5501	5
-------	----------	---

## WMB marking card; plain; 10 strips with 10 markers/card; 5 ... 5.2 mm stretchable



yellow	793-5501/000-002	5
red	793-5501/000-005	5
blue	793-5501/000-006	5
gray	793-5501/000-007	5
orange	793-5501/000-012	5
light green	793-5501/000-017	5
green	793-5501/000-023	5
violet	793-5501/000-024	5

## Screwless end stop; for DIN-35 rail; 6 mm wide



gray	249-116	100 (25)
------	---------	----------

## Screwless end stop; for DIN-35 rail; 10 mm wide



gray	249-117	50 (25)
------	---------	---------

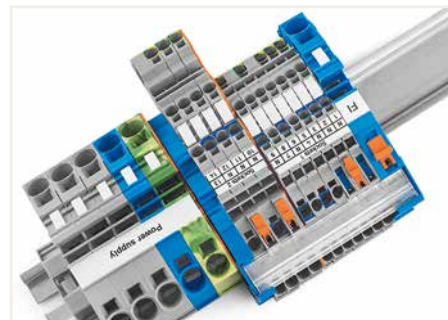

## TOPJOB® S – Terminal Blocks for Every Application

- Push-in termination of solid conductors in small distribution boards saves time and money.
- Operating errors can be prevented as all Terminal Blocks for building installations are equipped with push-in connection technology.
- The use of standard accessories reduces order-processing and warehousing costs.
- The busbar position is the same, making Installation Terminal Blocks TOPJOB® S compatible with standard Installation Terminal Blocks TOPJOB®.

For the construction and operation of power installations in fire-prone, hazardous locations or public buildings – such as conference centers, stores, hospitals, schools, theaters or hotels – the DIN VDE 0100-710 or DIN VDE 0100-718 standards shall be observed. DIN VDE 0100-482 shall also be observed for fire-prone, hazardous locations. These VDE regulations mandate that every neutral conductor must be provided with a disconnection device so, e.g., insulation resistance measurement is possible for every circuit without disconnecting the N-conductor. WAGO's N-disconnect terminal blocks meet this requirement.

## Application note:

N-disconnect slide links, used in installation terminal blocks, consist of switch contacts that are opened and then closed again as part of regular circuit testing. To guarantee a reliable connection, a corrosion-resistant contact area is required on the N-busbar.

Historically, uninsulated copper busbars that have been cleaned/stripped of any possible corrosion prior to install can be used in dry, pollution-free locations.

According to DIN VDE 0100-520 (VDE 0100, Part 520), installation equipment exposed to contamination or corrosive substances (e.g., water) that promote corrosion or deterioration, must be protected or made of a corrosion- or wear-resistant material. In these cases, tinned copper busbars guarantee a reliable connection.

WAGO only offers tinned copper busbars.

Sold &amp; Serviced By:

Toll Free Phone (877) SERV098  
www.electromate.com  
sales@electromate.com



## Multilevel Installation Terminal Block TOPJOB® S; with Internal N-Disconnection

### 2.5 (4) mm<sup>2</sup>; 2003 Series

#### Technical Data

0.25 ... 2.5 (4) mm<sup>2</sup> ① | 22 ... 12 AWG  
 250 V/4 kV/3; 20 A (25 A) ②  
 400 V/6 kV/3; 20 A (25 A) ②  
 Terminal block width: 5.2 mm / 0.205 inch  
 10 ... 12 mm / 0.39 ... 0.47 inch

#### Technical Data

0.25 ... 2.5 (4) mm<sup>2</sup> ① | 22 ... 12 AWG  
 400 V/6 kV/3 ②  
 I<sub>N</sub> 24 A (28 A)  
 Terminal block width: 5.2 mm / 0.205 inch  
 10 ... 12 mm / 0.39 ... 0.47 inch

#### Technical Data

0.25 ... 2.5 (4) mm<sup>2</sup> ① | 22 ... 12 AWG  
 250 V/4 kV/3; 24 A (28 A) ②  
 400 V/6 kV/3; 24 A (28 A) ②  
 Terminal block width: 5.2 mm / 0.205 inch  
 10 ... 12 mm / 0.39 ... 0.47 inch

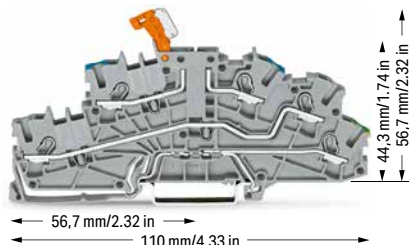

Multilevel installation terminal block; with pivoting knife disconnect; gray

	Item No.	Pack. Unit
<input type="radio"/> NT/L/PE	2003-6641	50
<input type="radio"/> LT/L/PE	2003-6644	50

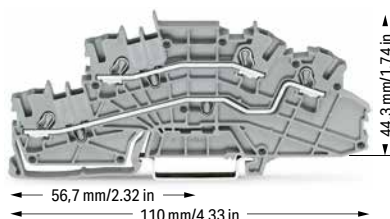

Multilevel installation terminal block; gray

	Item No.	Pack. Unit
<input type="radio"/> L/L	2003-6642	50
<input type="radio"/> N/L	2003-6649	50

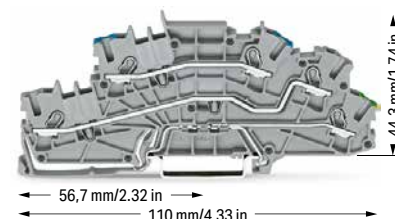

Multilevel installation terminal block; gray

	Item No.	Pack. Unit
<input type="radio"/> N/L/PE	2003-6646	50
<input type="radio"/> L/L/PE	2003-6645	50

#### Accessories; item-specific

##### N/L-test plug adapter; for vertical test slot; gray

	2-pole	2003-499	100 (25)
--	--------	----------	----------

##### N-test plug adapter; for vertical test slot; gray

	1-pole	2003-500	100 (25)
---	--------	----------	----------

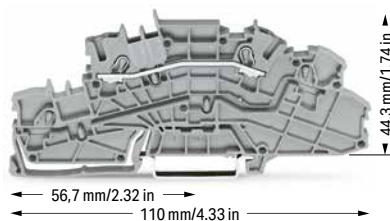

Multilevel installation terminal block; gray

	Item No.	Pack. Unit
<input type="radio"/> L	2003-6650	50
<input type="radio"/> N	2003-6651	50

#### Accessories; 2003 Series

Appropriate marking systems: WMB/WMB Inline/Marking strips

##### End and intermediate plate; 0.8 mm thick

	orange	2003-6692	100 (25)
--	--------	-----------	----------

##### Insulation stop; 5 pcs/strip; 0.25 ... 0.5 mm<sup>2</sup>

	light gray	2002-171	200 (25)
--	------------	----------	----------

##### Insulation stop; 5 pcs/strip; 0.75 ... 1 mm<sup>2</sup>

	dark gray	2002-172	200 (25)
--	-----------	----------	----------

##### Push-in type jumper bar; insulated; I<sub>N</sub> 25 A; light gray

	2-way	2002-402	25
	3-way	2002-403	25
	4-way	2002-404	25
	5-way	2002-405	25
	6-way	2002-406	25
	7-way	2002-407	25
	8-way	2002-408	25
	9-way	2002-409	25
	10-way	2002-410	25

##### Push-in type jumper bar; insulated; I<sub>N</sub> 25 A; light gray

	1 to 3	2002-433	25
	1 to 4	2002-434	25
	1 to 5	2002-435	25
	1 to 6	2002-436	25
	1 to 7	2002-437	25
	1 to 8	2002-438	25
	1 to 9	2002-439	25
	1 to 10	2002-440	25

##### Push-in type wire jumper; insulated; 1.5 mm<sup>2</sup> conductor cross-section; I<sub>N</sub> 18 A

	L = 60 mm	2009-412	100 (10)
	L = 110 mm	2009-414	100 (10)
	L = 250 mm	2009-416	100 (10)

1 Conductor range: 0.25 ... 4 mm<sup>2</sup> "s+f-st";  
Push-in termination: 1 ... 4 mm<sup>2</sup> "s" and 1 ... 2.5 mm<sup>2</sup> "insulated ferrules, 12 mm"  
Depending on the conductor characteristic, a conductor with a smaller cross section can also be inserted via push-in termination.

2 250 V / 400 V = rated voltage  
4 kV / 6 kV = rated impulse voltage  
3 = pollution degree  
250 V/4 kV potential – ground  
400 V/6 kV potential – potential

Please observe the application notes:  
Jumpers, from page 160  
Testing accessories, page 159  
Marking, from page 246

Approvals and corresponding ratings, visit [www.wago.com](http://www.wago.com)

**Accessories; 2003 Series**

Appropriate marking systems:  
WMB/WMB Inline/Marking strips

WMB Inline, plain; 1,500 WMB markers (5 mm)/reel;  
5 ... 5.2 mm stretchable

white	2009-115	1
-------	----------	---

Marking strip; plain; 11 mm wide; 50 m reel

white	2009-110	1
-------	----------	---

WMB marking card; white; 10 strips with 10 markers/card;  
5 ... 5.2 mm stretchable

plain	793-5501	5
-------	----------	---

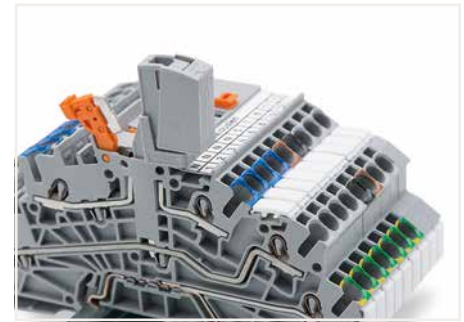

For multilevel installation terminal blocks with internal N-disconnection, test plug adapters can be inserted into the free vertical test slot when the N-potential is disconnected.

**Accessories; 2003 Series**

Appropriate marking systems:  
WMB/WMB Inline/Marking strips

Staggered jumper; insulated; I<sub>N</sub> 25 A; light gray

	2-way	2002-472	25
	3-way	2002-473	25
	4-way	2002-474	25
	5-way	2002-475	25
	6-way	2002-476	25
	7-way	2002-477	25
	8-way	2002-478	25
	9-way	2002-479	25
	10-way	2002-480	25
	11-way	2002-481	25
	12-way	2002-482	25

Customized staggered jumper; insulated; with contact lugs broken off at the factory and circuit printing; I<sub>N</sub> 25 A; light gray

	1-3	2002-473/011-000	25
	1-3-5	2002-475/011-000	25
	1-3-5-7	2002-477/011-000	25
	1-3-5-7-9	2002-479/011-000	25
	1-3-5-7-9-11	2002-481/011-000	25

Adjacent jumper for continuous commoning; insulated; I<sub>N</sub> 25 A, light gray

	2-way	2002-400	25
--	-------	----------	----

Adjacent jumper for continuous commoning; insulated; I<sub>N</sub> 25 A; 1 to 3

	light gray	2002-423	25
	red	2002-423/000-005	25
	blue	2002-423/000-006	25

Adjacent jumper for continuous commoning; insulated; I<sub>N</sub> 25 A, light gray

	5-way	2002-415	25
--	-------	----------	----

Test plug adapter; for 4 mm Ø test plug

	gray	2009-174	100 (25)
--	------	----------	----------

Banana plug; for 4 mm socket diameter; color mixed; 10 x orange, white, black, blue, yellow; max. 42 V

		215-111	50
--	--	---------	----

Testing tap; for max. 2.5 mm<sup>2</sup>

	gray	2009-182	100 (25)
--	------	----------	----------

WMB marking card; plain; 10 strips with 10 markers/card;  
5 ... 5.2 mm stretchable

	yellow	793-5501/000-002	5
	red	793-5501/000-005	5
	blue	793-5501/000-006	5
	gray	793-5501/000-007	5
	orange	793-5501/000-012	5
	light green	793-5501/000-017	5
	green	793-5501/000-023	5
	violet	793-5501/000-024	5

Screwless end stop; for DIN-35 rail; 6 mm wide

	gray	249-116	100 (25)
--	------	---------	----------

Screwless end stop; for DIN-35 rail; 10 mm wide

	gray	249-117	50 (25)
--	------	---------	---------

Operating tool; 3.5 mm and 2.5 mm blade width; for Installation Terminal Blocks TOPJOB® S

		2009-309	50 (1)
--	--	----------	--------

Operating tool; 3.5 mm and 5.5 mm blade width; for Installation Terminal Blocks TOPJOB® S

		2009-310	50 (1)
--	--	----------	--------

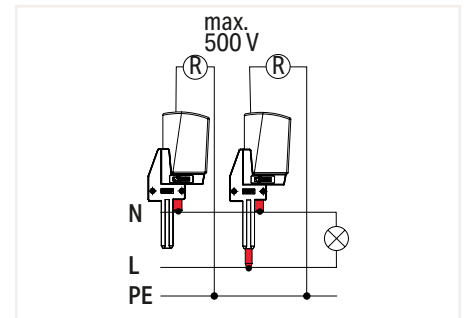

Test plug adapters for both individual N-potential measurement and insulation resistance measurement of the connected N- and L-potentials are available.

# Multilevel Installation Terminal Block TOPJOB® S

## 2.5 (4) mm<sup>2</sup>; 2003 Series

Technical Data	
0.25 ... 2.5 (4) mm <sup>2</sup> ①	22 ... 12 AWG
250 V/4 kV/3; 10 A ②	
400 V/6 kV/3; 10 A ②	
Terminal block width: 5.2 mm / 0.205 inch	
 10 ... 12 mm / 0.39 ... 0.47 inch	

Technical Data	
0.25 ... 2.5 (4) mm <sup>2</sup> ①	22 ... 12 AWG
250 V/4 kV/3; 10 A ②	
400 V/6 kV/3; 10 A ②	
Terminal block width: 5.2 mm / 0.205 inch	
 10 ... 12 mm / 0.39 ... 0.47 inch	

- ① Conductor range: 0.25 ... 4 mm<sup>2</sup> "s+f-st"; Push-in termination: 1 ... 4 mm<sup>2</sup> "s" and 1 ... 2.5 mm<sup>2</sup> "insulated ferrules, 12 mm"  
Depending on the conductor characteristic, a conductor with a smaller cross section can also be inserted via push-in termination.
  - ② 250 V / 400 V = rated voltage  
4 kV / 6 kV = rated impulse voltage  
3 = pollution degree  
250 V/4 kV potential – ground  
400 V/6 kV potential – potential
- Please observe the application notes:  
Jumpers, from page 160  
Testing accessories, page 159  
Marking, from page 246
- Approvals and corresponding ratings, visit [www.wago.com](http://www.wago.com)

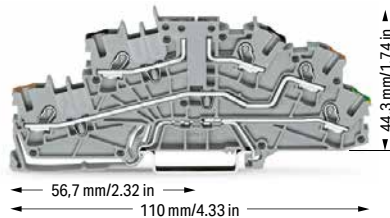
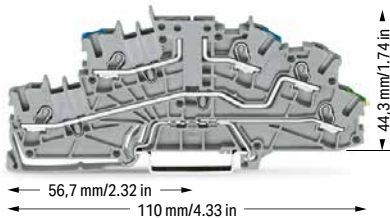

Multilevel installation terminal block; carrier terminal block without knife disconnect; gray  
Maximum current depends on accessories used.

	Item No.	Pack. Unit
○ N/L/PE	2003-6640	50

Multilevel installation terminal block; carrier terminal block without knife disconnect; black upper-deck, brown middle-deck, green-yellow lower-deck printing  
Maximum current depends on accessories used.

	Item No.	Pack. Unit
○ P2/P1/PE	2003-6643	50

Multilevel installation terminal block; carrier terminal block without knife disconnect; blue middle-deck; green-yellow lower-deck printing; gray

	Item No.	Pack. Unit
○ L/N/PE	2003-6661	50

Multilevel installation terminal block; carrier terminal block without knife disconnect; brown upper-deck, black middle-deck, green-yellow lower-deck printing

	Item No.	Pack. Unit
○ P1/P2/PE	2003-6660	50

### Accessories; 2003 Series

Appropriate marking systems: WMB/WMB Inline/Marking strips

N/L-test plug adapter; for vertical test slot; gray

	Item No.	Pack. Unit
2-pole	2003-499	100 (25)

N-test plug adapter; for vertical test slot; gray

	Item No.	Pack. Unit
1-pole	2003-500	100 (25)

End and intermediate plate; 0.8 mm thick

	Item No.	Pack. Unit
orange	2003-6692	100 (25)

Fuse plug with pull-tab; for 5 x 20 mm glass cartridge fuse  
Electrical ratings are given by the fuse.

	Item No.	Pack. Unit
gray	2004-911	50

End and intermediate plate; only for use with fuse plugs; 1 mm thick

	Item No.	Pack. Unit
orange	2003-6693	100 (25)

Double-fuse plug; for 5 x 20 mm glass cartridge fuse  
Electrical ratings are given by the fuse.

	Item No.	Pack. Unit
gray	2003-911	25

End and intermediate plate; 1 mm thick; only for use with double-fuse plugs

	Item No.	Pack. Unit
orange	2003-6694	100 (25)

Push-in type jumper bar; insulated; I<sub>N</sub> 25 A; light gray

	Item No.	Pack. Unit
2-way	2002-402	25
3-way	2002-403	25
4-way	2002-404	25
5-way	2002-405	25
6-way	2002-406	25
7-way	2002-407	25
8-way	2002-408	25
9-way	2002-409	25
10-way	2002-410	25

Push-in type jumper bar; insulated; I<sub>N</sub> 25 A; light gray

	Item No.	Pack. Unit
1 to 3	2002-433	25
1 to 4	2002-434	25
1 to 5	2002-435	25
1 to 6	2002-436	25
1 to 7	2002-437	25
1 to 8	2002-438	25
1 to 9	2002-439	25
1 to 10	2002-440	25

Push-in type wire jumper; insulated; 1.5 mm<sup>2</sup> conductor cross-section; I<sub>N</sub> 18 A

	Item No.	Pack. Unit
L = 60 mm	2009-412	100 (10)
L = 110 mm	2009-414	100 (10)
L = 250 mm	2009-416	100 (10)

### Accessories; 2003 Series

Appropriate marking systems:  
WMB/WMB Inline/Marking strips

Staggered jumper; insulated; I<sub>N</sub> 25 A; light gray

	Item No.	Pack. Unit
2-way	2002-472	25
3-way	2002-473	25
4-way	2002-474	25
5-way	2002-475	25
6-way	2002-476	25
7-way	2002-477	25
8-way	2002-478	25
9-way	2002-479	25
10-way	2002-480	25
11-way	2002-481	25
12-way	2002-482	25

Customized staggered jumper; insulated; with contact lugs broken off at the factory and circuit printing; I<sub>N</sub> 25 A; light gray

	Item No.	Pack. Unit
1-3	2002-473/011-000	25
1-3-5	2002-475/011-000	25
1-3-5-7	2002-477/011-000	25
1-3-5-7-9	2002-479/011-000	25
1-3-5-7-9-11	2002-481/011-000	25

Adjacent jumper for continuous commoning; insulated; I<sub>N</sub> 25 A, light gray

	Item No.	Pack. Unit
2-way	2002-400	25

Adjacent jumper for continuous commoning; insulated; I<sub>N</sub> 25 A; 1 to 3

	Item No.	Pack. Unit
light gray	2002-423	25
red	2002-423/000-005	25
blue	2002-423/000-006	25

Adjacent jumper for continuous commoning; insulated; I<sub>N</sub> 25 A, light gray

	Item No.	Pack. Unit
5-way	2002-415	25

Test plug adapter; for 4 mm Ø test plug

	Item No.	Pack. Unit
gray	2009-174	100 (25)

Banana plug; for 4 mm socket diameter; color mixed; 10 x orange, white, black, blue, yellow; max. 42 V

	Item No.	Pack. Unit
	215-111	50

Testing tap; for max. 2.5 mm<sup>2</sup>

	Item No.	Pack. Unit
gray	2009-182	100 (25)

**Accessories; 2003 Series**

Appropriate marking systems:  
WMB/WMB Inline/Marking strips

WMB Inline, plain; 1,500 WMB markers (5 mm)/reel;  
5 ... 5.2 mm stretchable

	white	2009-115	1
---	-------	----------	---

Marking strip; plain; 11 mm wide; 50 m reel

	white	2009-110	1
---	-------	----------	---

WMB marking card; white; 10 strips with 10 markers/card;  
5 ... 5.2 mm stretchable

	plain	793-5501	5
---	-------	----------	---

WMB marking card; plain; 10 strips with 10 markers/card;  
5 ... 5.2 mm stretchable

	yellow	793-5501/000-002	5
	red	793-5501/000-005	5
	blue	793-5501/000-006	5
	gray	793-5501/000-007	5
	orange	793-5501/000-012	5
	light green	793-5501/000-017	5
	green	793-5501/000-023	5
	violet	793-5501/000-024	5

Screwless end stop; for DIN-35 rail; 6 mm wide

	gray	249-116	100 (25)
---	------	---------	----------

Screwless end stop; for DIN-35 rail; 10 mm wide

	gray	249-117	50 (25)
---	------	---------	---------

Operating tool; 3.5 mm and 2.5 mm blade width; for  
Installation Terminal Blocks TOPJOB® S

	2009-309	50 (1)
---	----------	--------

Operating tool; 3.5 mm and 5.5 mm blade width; for  
Installation Terminal Blocks TOPJOB® S

	2009-310	50 (1)
---	----------	--------

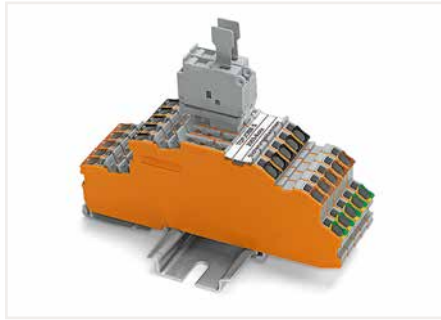

Single-fuse plugs can be used in combination with 1 mm thick end and intermediate plates on carrier terminal blocks without an N-knife disconnect.

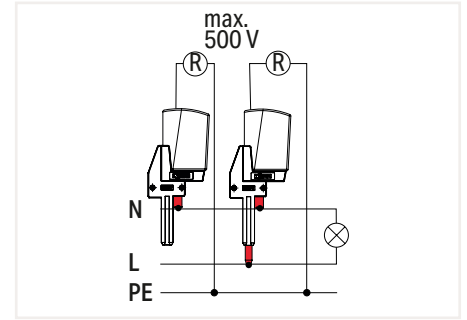

Test plug adapters for both individual N-potential measurement and insulation resistance measurement of the connected N- and L-potentials are available.

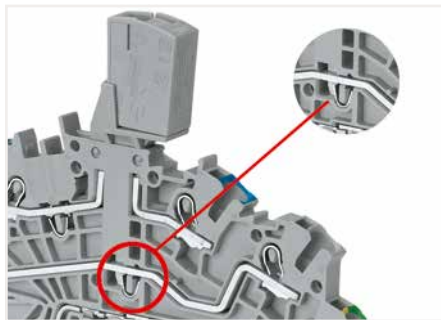

Multilevel installation terminal block fitted with an N/L-test plug adapter for quick and safe insulation resistance measurement of the connected N- and L-potentials

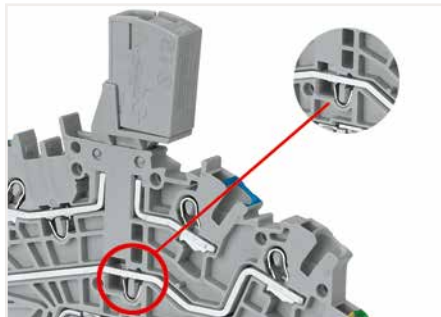

Multilevel installation terminal block fitted with an N-test plug adapter for insulation resistance measurement of the N-potential

# Double-Fuse Plug TOPJOB® S on Carrier Terminal Block 2.5 (4) mm<sup>2</sup> 2003 Series

### Technical Data

250 V / I<sub>N</sub> 6.3 A  
Plug width: 10.4 mm / 0.409 inch

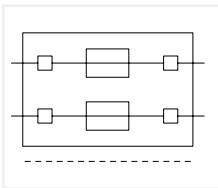

Double-fuse plug; for 5 x 20 mm glass cartridge fuse  
Electrical ratings are given by the fuse.

Color	Item No.	Pack. Unit
○ gray	2003-911	50

### Technical Data

250 V / I<sub>N</sub> 6.3 A  
Plug width: 10.4 mm / 0.409 inch

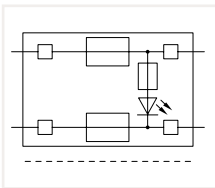

Double-fuse plug; for 5 x 20 mm glass cartridge fuse; with LED; gray  
Electrical ratings are given by the fuse and blown fuse indication. Leakage current in case of a blown fuse: LED 0.25 mA

Color	Item No.	Pack. Unit
○ 230 V	2003-911/1000-923	50

### Accessories; for fuse plugs

Appropriate marking systems: WMB/Marking strips

2-conductor carrier terminal block;  
0.25 ... 2.5 (4) mm<sup>2</sup> / 22 ... 12 AWG  
Terminal block width: 5.2 mm / 0.205 inch

gray	2002-1661	50
------	-----------	----



End and intermediate plate; 1 mm thick

orange	2002-1692	100 (25)
gray	2002-1691	100 (25)



3-conductor carrier terminal block;  
0.25 ... 2.5 (4) mm<sup>2</sup> / 22 ... 12 AWG  
Terminal block width: 5.2 mm / 0.205 inch

gray	2002-1761	50
------	-----------	----



End and intermediate plate; 1 mm thick

orange	2002-1792	100 (25)
gray	2002-1791	100 (25)



4-conductor carrier terminal block;  
0.25 ... 2.5 (4) mm<sup>2</sup> / 22 ... 12 AWG  
Terminal block width: 5.2 mm / 0.205 inch

gray	2002-1861	50
------	-----------	----



End and intermediate plate; 1 mm thick

orange	2002-1892	100 (25)
gray	2002-1891	100 (25)



End plate for fuse terminal blocks; 2 mm thick

orange	2002-992	100 (25)
gray	2002-991	100 (25)



2-conductor carrier terminal block;  
0.25 ... 2.5 (4) mm<sup>2</sup> / 22 ... 12 AWG  
Terminal block width: 5.2 mm / 0.205 inch

gray	2002-1961	50
------	-----------	----



End and intermediate plate; 1 mm thick

orange	2002-1992	100 (25)
gray	2002-1991	100 (25)



Double-deck carrier terminal block;  
0.25 ... 2.5 (4) mm<sup>2</sup> / 22 ... 12 AWG  
Terminal block width: 5.2 mm / 0.205 inch

L/L	2002-2961	50
-----	-----------	----



Double-deck carrier terminal block;  
0.25 ... 2.5 (4) mm<sup>2</sup> / 22 ... 12 AWG  
Terminal block width: 5.2 mm / 0.205 inch

L/N	2002-2963	50
-----	-----------	----



Double-deck carrier terminal block;  
0.25 ... 2.5 (4) mm<sup>2</sup> / 22 ... 12 AWG  
Terminal block width: 5.2 mm / 0.205 inch

L/L	2002-2941	50
-----	-----------	----



End and intermediate plate; 1 mm thick

orange	2002-2992	100 (25)
gray	2002-2991	100 (25)



Shorting link; 5 x 20 mm; allows the fuse plug to be used as a disconnect plug

I <sub>N</sub> 6.3 A	281-503	250 (25)
----------------------	---------	----------



Length for 2002-1661 – 66.5 mm / 2.62 inch  
2-conductor carrier terminal block

Length for 2002-1761 – 76.8 mm / 3.02 inch  
3-conductor carrier terminal block

Length for 2002-1861 – 87.5 mm / 3.45 inch  
4-conductor carrier terminal block

Length for 2002-1961 – 72.9 mm / 2.87 inch  
2-conductor carrier terminal block with additional jumper slot

Length for 2002-2961 – 108 mm / 4.25 inch  
Double-deck carrier terminal block

Length for 2003-6640 – 110 mm / 4.33 inch  
Multilevel Installation Terminal Block

Approvals and corresponding ratings, visit [www.wago.com](http://www.wago.com)

### Accessories; for fuse plugs

Appropriate marking systems:  
WMB/Marking strips

Multilevel installation terminal block;  
0.25 ... 2.5 (4) mm<sup>2</sup> / 22 ... 12 AWG  
Terminal block width: 5.2 mm / 0.205 inch

N/L/PE	2003-6640	50
--------	-----------	----



Multilevel installation terminal block;  
0.25 ... 2.5 (4) mm<sup>2</sup> / 22 ... 12 AWG  
Terminal block width: 5.2 mm / 0.205 inch

L/N/PE	2003-6661	50
--------	-----------	----



Multilevel installation terminal block;  
0.25 ... 2.5 (4) mm<sup>2</sup> / 22 ... 12 AWG  
Terminal block width: 5.2 mm / 0.205 inch

P2/P1/PE	2003-6643	50
----------	-----------	----



Multilevel installation terminal block;  
0.25 ... 2.5 (4) mm<sup>2</sup> / 22 ... 12 AWG  
Terminal block width: 5.2 mm / 0.205 inch

P1/P2/PE	2003-6660	50
----------	-----------	----



End and intermediate plate; 0.8 mm thick

orange	2003-6692	100 (25)
--------	-----------	----------



End and intermediate plate; 1 mm thick; only for use with double-fuse plugs

orange	2003-6694	100 (25)
--------	-----------	----------



WMB marking card; white; 10 strips with 10 markers/card; 5 ... 5.2 mm stretchable

plain	793-5501	5
-------	----------	---



WMB marking card; plain; 10 strips with 10 markers/card; 5 ... 5.2 mm stretchable

yellow	793-5501/000-002	5
red	793-5501/000-005	5
blue	793-5501/000-006	5
gray	793-5501/000-007	5
orange	793-5501/000-012	5
light green	793-5501/000-017	5
green	793-5501/000-023	5
violet	793-5501/000-024	5





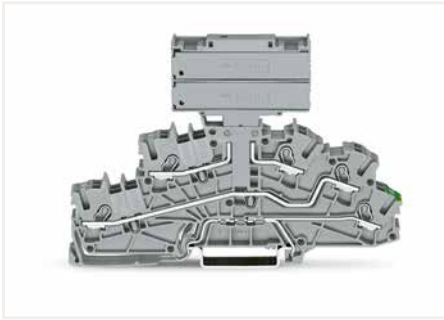

Double-fuse plugs with 5 x 25 mm glass cartridge fuses can be used on carrier terminal blocks without an N-knife disconnect in standard terminal block width.

#### Glass cartridge fuses 5 x 20

Series Item No.	Overload and short circuit protection		Short circuit protection only	
	Individual argmt.	Group argmt.	Individual argmt.	Group argmt.
Fuse terminal blocks				
2003-911	1.6 W	1.6 W	2.5 W	2.5 W
2003-911/.....				

When selecting glass cartridge fuses, make sure that the maximum power loss listed below is not exceeded. The power loss is determined according to IEC or EN 60947-7-3/VDE 0611-6 at 23°C. The temperature rise of the terminal blocks must be checked according to their application and mounting. Higher ambient temperatures represent an additional impact on fuse cartridges. Therefore, in such applications, the rated current must be reduced if necessary. More details are available from the manufacturers.

# Multilevel Installation Terminal Block TOPJOB® S; with N-Disconnect Slide Link

## 4 (6) mm<sup>2</sup>; 2005 Series

### Technical Data

0.5 ... 4 (6) mm<sup>2</sup> ① | 20 ... 10 AWG  
 250 V/4 kV/3; 36 A (36 A) ②  
 400 V/6 kV/3; 36 A (36 A) ②  
 Terminal block width: 6.2 mm / 0.244 inch  
 11 ... 13 mm / 0.43 ... 0.51 inch

### Technical Data

0.5 ... 4 (6) mm<sup>2</sup> ① | 20 ... 10 AWG  
 400 V/6 kV/3 ②  
 I<sub>N</sub> 36 A  
 Terminal block width: 6.2 mm / 0.244 inch  
 11 ... 13 mm / 0.43 ... 0.51 inch

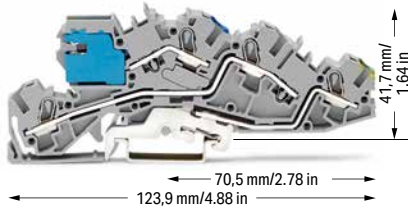

Multilevel installation terminal block; with N-disconnect slide link; gray

	Item No.	Pack. Unit
○ N/L/PE	2005-7641	50

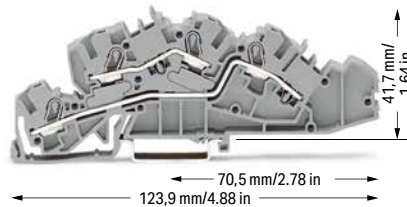

Multilevel installation terminal block; gray

	Item No.	Pack. Unit
○ L/L	2005-7642	50
○ N/L	2005-7649	50



Multilevel installation terminal block; gray

	Item No.	Pack. Unit
○ N/L/PE	2005-7646	50

Multilevel installation terminal block; gray

	Item No.	Pack. Unit
○ L/L/PE	2005-7645	50

### Accessories; 2005 Series

Appropriate marking systems: WMB/Marking strips

#### End and intermediate plate; 1 mm thick

orange	2005-7692	100 (25)
--------	-----------	----------



#### Busbar carrier; not suitable as an end stop; snaps onto DIN-35 rail; 1.5 mm thick

blue	2009-304	100 (25)
------	----------	----------



#### Busbar carrier; with end stop function and detachable separator plate; snaps onto DIN-35 rail; 7.5 mm thick

blue	2009-305	25
------	----------	----



#### Busbar cover; 1000 mm long

transparent	777-303	1
-------------	---------	---



#### Busbar; tin-plated; 1000 mm long; copper (10 x 3) mm

I <sub>N</sub> 140 A	210-133	1
----------------------	---------	---



#### Lock-out; prevents reclosing of slide link; snap-on type

orange	2005-7300	100 (25)
--------	-----------	----------



#### N-supply terminal block; I<sub>N</sub> 76 A; 16 mm<sup>2</sup>; 12 mm wide

blue	2016-7714	20
------	-----------	----



#### Ground supply terminal block; 16 mm<sup>2</sup>; 12 mm wide

green-yellow	2016-7607	20
--------------	-----------	----



#### Connector; for busbar; with blue cover; 2.5 ... 16 mm<sup>2</sup>

blue	210-281	100 (50)
------	---------	----------



#### Connector; for busbar; 2.5 ... 35 mm<sup>2</sup>

unplated	209-105	50
----------	---------	----



① Conductor range: 0.5 ... 6 mm<sup>2</sup> "s+f-st";  
 Push-in termination: 1.5 ... 6 mm<sup>2</sup> "s" and 1.5 ... 4 mm<sup>2</sup> "insulated ferrules; 12 mm"  
 Depending on the conductor characteristic, a conductor with a smaller cross section can also be inserted via push-in termination.

② 250 V/400 V = rated voltage  
 4 kV/6 kV = rated impulse voltage  
 3 = pollution degree  
 250 V/4 kV potential – ground  
 400 V/6 kV potential – potential

Please observe the application notes:  
 Testing accessories, page 159  
 Marking, from page 246

Approvals and corresponding ratings,  
 visit [www.wago.com](http://www.wago.com)

### Accessories; 2005 Series

Appropriate marking systems:  
 WMB/Marking strips

#### Insulation stop; 5 pcs/strip; 0.25 ... 0.5 mm<sup>2</sup>

light gray	2004-171	200 (25)
------------	----------	----------



#### Insulation stop; 5 pcs/strip; 0.75 ... 1 mm<sup>2</sup>

dark gray	2004-172	200 (25)
-----------	----------	----------



#### Push-in type jumper bar; insulated; I<sub>N</sub> 32 A; light gray

2-way	2004-402	25
3-way	2004-403	25
4-way	2004-404	25
5-way	2004-405	25
6-way	2004-406	25
7-way	2004-407	25
8-way	2004-408	25
9-way	2004-409	25
10-way	2004-410	25



#### Push-in type jumper bar; insulated; I<sub>N</sub> 32 A; light gray

1 to 3	2004-433	25
1 to 4	2004-434	25
1 to 5	2004-435	25
1 to 6	2004-436	25
1 to 7	2004-437	25
1 to 8	2004-438	25
1 to 9	2004-439	25
1 to 10	2004-440	25



#### Test plug adapter; for 4 mm Ø test plug

gray	2009-174	100 (25)
------	----------	----------



#### Banana plug; for 4 mm socket diameter; color mixed; 10 x orange, white, black, blue, yellow; max. 42 V

	215-111	50
--	---------	----



#### Testing tap; for max. 2.5 mm<sup>2</sup>

gray	2009-182	100 (25)
------	----------	----------



#### Test plug; with 500 mm cable; 2 mm Ø; max. 42 V

red	210-136	50 (1)
-----	---------	--------



#### Test plug; with 500 mm cable; 2.3 mm Ø; max. 42 V

	210-137	50 (1)
--	---------	--------



**Accessories; 2005 Series**

Appropriate marking systems:  
WMB/Marking strips

**Marking strip; plain; 11 mm wide; 50 m reel**

white	2009-110	1
-------	----------	---

**WMB marking card; white; 10 strips with 10 markers/card; 5 ... 5.2 mm stretchable**

plain	793-5501	5
-------	----------	---

**WMB marking card; plain; 10 strips with 10 markers/card; 5 ... 5.2 mm stretchable**

yellow	793-5501/000-002	5
red	793-5501/000-005	5
blue	793-5501/000-006	5
gray	793-5501/000-007	5
orange	793-5501/000-012	5
light green	793-5501/000-017	5
green	793-5501/000-023	5
violet	793-5501/000-024	5

**Screwless end stop; for DIN-35 rail; 6 mm wide**

gray	249-116	100 (25)
------	---------	----------

**Screwless end stop; for DIN-35 rail; 10 mm wide**

gray	249-117	50 (25)
------	---------	---------

**Operating tool; 3.5 mm and 2.5 mm blade width; for Installation Terminal Blocks TOPJOB® S**

	2009-309	50 (1)
--	----------	--------

**Operating tool; 3.5 mm and 5.5 mm blade width; for Installation Terminal Blocks TOPJOB® S**

	2009-310	50 (1)
--	----------	--------

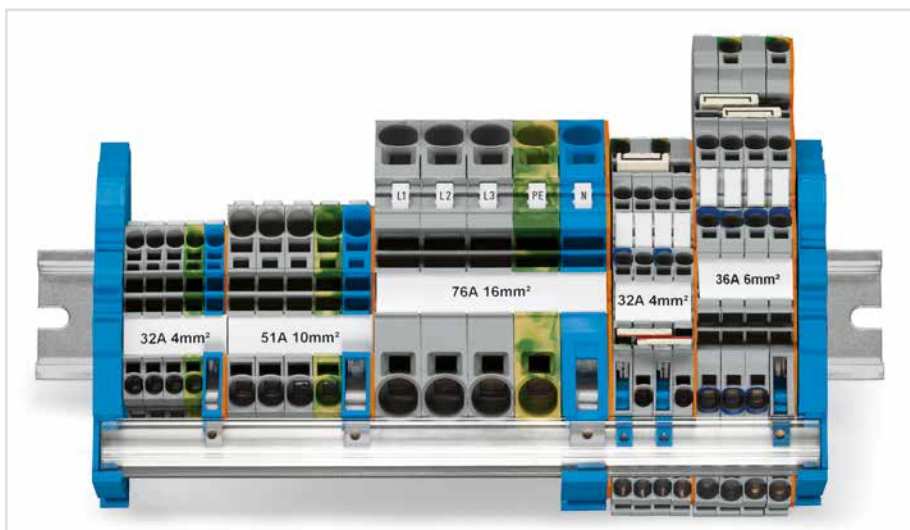
**Application note:**

N-disconnect slide links, used in installation terminal blocks, consist of switch contacts that are opened and then closed again as part of regular circuit testing. To guarantee a reliable connection, a corrosion-resistant contact area is required on the N-busbar.

Historically, uninsulated copper busbars that have been cleaned/stripped of any possible corrosion prior to install can be used in dry, pollution-free locations.

According to DIN VDE 0100-520 (VDE 0100, Part 520), installation equipment exposed to contamination or corrosive substances (e.g., water) that promote corrosion or deterioration, must be protected or made of a corrosion- or wear-resistant material. In these cases, tinned copper busbars guarantee a reliable connection.

WAGO only offers tinned copper busbars.

# N-Disconnect Terminal Block, Power Distribution Disconnect Terminal Block TOPJOB® S

## 2002 Series; 2006 Series; 2010 Series; 2016 Series

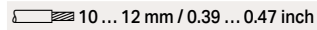
Technical Data	
0.25 ... 2.5 (4) mm <sup>2</sup> ①	22 ... 12 AWG
250 V/4 kV/3 ⑤	
I <sub>N</sub> 32 A	
Terminal block width: 5.2 mm / 0.205 inch	
 10 ... 12 mm / 0.39 ... 0.47 inch	

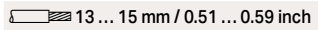
Technical Data	
0.5 ... 6 (10) mm <sup>2</sup> ②	20 ... 8 AWG
250 V/4 kV/3 ⑤	
I <sub>N</sub> 51 A	
Terminal block width: 7.5 mm / 0.295 inch	
 13 ... 15 mm / 0.51 ... 0.59 inch	

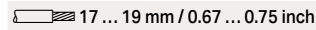
Technical Data	
0.5 ... 10 (16) mm <sup>2</sup> ③	20 ... 6 AWG
250 V/4 kV/3 ⑤	
I <sub>N</sub> 57 A	
Terminal block width: 10 mm / 0.394 inch	
 17 ... 19 mm / 0.67 ... 0.75 inch	

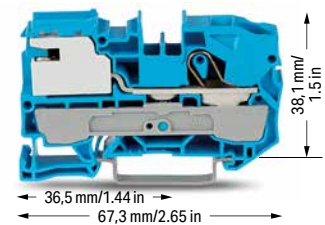
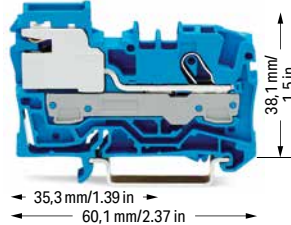
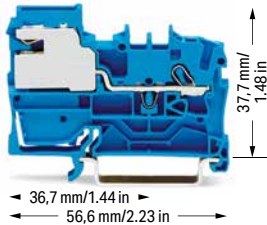

1-conductor N-disconnect terminal block		
Color	Item No.	Pack. Unit
● blue	2002-7114	50

1-conductor N-disconnect terminal block		
Color	Item No.	Pack. Unit
● blue	2006-7114	50

1-conductor N-disconnect terminal block		
Color	Item No.	Pack. Unit
● blue	2010-7114	25

1-conductor power distribution disconnect terminal block		
○ gray	2002-7111	50

1-conductor power distribution disconnect terminal block		
○ gray	2006-7111	50

1-conductor power distribution disconnect terminal block		
○ gray	2010-7111	25

Appropriate through and ground conductor terminal blocks, see page 38

Appropriate through and ground conductor terminal blocks, see page 44

Appropriate through and ground conductor terminal blocks, see page 45

Accessories; item-specific			
End and intermediate plate; 0.8 mm thick			
orange	2002-7192	100 (25)	



Accessories; item-specific			
End and intermediate plate; 1 mm thick			
orange	2006-7192	100 (25)	



Accessories; item-specific			
End and intermediate plate; 1 mm thick			
orange	2010-7192	100 (25)	



Lock-out; prevents reclosing of slide link; snap-on type			
orange	2005-7300	100 (25)	



Lock-out; prevents reclosing of slide link; snap-on type			
orange	2006-7300	100 (25)	



Lock-out; prevents reclosing of slide link; snap-on type			
orange	2006-7300	100 (25)	

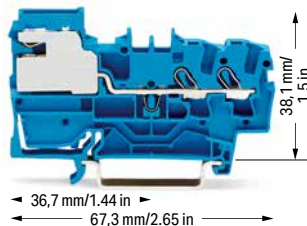

2-conductor N-disconnect terminal block		
Color	Item No.	Pack. Unit
● blue	2002-7214	50

2-conductor power distribution disconnect terminal block		
○ gray	2002-7211	50

### Accessories; for N-conductor and power distribution disconnect terminal blocks

Appropriate marking systems: WMB/Marking strips

Busbar carrier; not suitable as an end stop; snaps onto DIN-35 rail; 1.5 mm thick			
blue	2009-304	100 (25)	



Busbar carrier; with end stop function and detachable separator plate; snaps onto DIN-35 rail; 7.5 mm thick			
blue	2009-305	25	



Busbar; tin-plated; 1000 mm long; copper (10 x 3) mm			
I <sub>N</sub> 140 A	210-133	1	



Busbar cover; 1000 mm long			
transparent	777-303	1	



Connector; for busbar; 2.5 ... 35 mm <sup>2</sup>			
unplated	209-105	1	



Connector; for busbar; with blue cover; 2.5 ... 16 mm <sup>2</sup>			
blue	210-281	100 (50)	



Test plug; with 500 mm cable; 2 mm Ø; max. 42 V			
red	210-136	50 (1)	



Test plug; with 500 mm cable; 2.3 mm Ø; max. 42 V			
	210-137	50 (1)	



Marking strip; plain; 11 mm wide; 50 m reel			
white	2009-110	1	



WMB marking card; white; 10 strips with 10 markers/card; 5 ... 5.2 mm stretchable			
plain	793-5501	5	

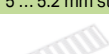

**Technical Data**0.5 ... 16 (25 "f-st") mm<sup>2</sup> ③ | 20 ... 4 AWG

250 V/4 kV/3 ⑤

I<sub>N</sub> 65 A

Terminal block width: 12 mm / 0.472 inch

18 ... 20 mm / 0.71 ... 0.79 inch

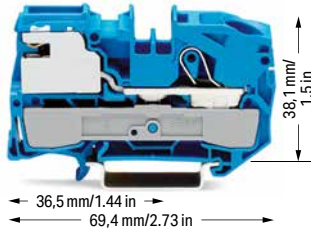
**1-conductor N-disconnect terminal block**

Color	Item No.	Pack. Unit
● blue	2016-7114	25

**1-conductor power distribution disconnect terminal block**

○ gray	2016-7111	25
--------	-----------	----

Appropriate through and ground conductor terminal blocks, see page 46

**Accessories; item-specific****End and intermediate plate; 1 mm thick**

orange	2016-7192	100 (25)
--------	-----------	----------

**Lock-out; prevents reclosing of slide link; snap-on type**

orange	2006-7300	100 (25)
--------	-----------	----------

① Conductor range: 0.25 ... 4 mm<sup>2</sup> "s+f-st";  
Push-in termination: 1 ... 4 mm<sup>2</sup> "s" and 1 ... 2.5 mm<sup>2</sup> "insulated ferrules; 12 mm"  
Depending on the conductor characteristic, a conductor with a smaller cross section can also be inserted via push-in termination.

② Conductor range: 0.5 ... 10 mm<sup>2</sup> "s+f-st";  
Push-in termination: 2.5 ... 10 mm<sup>2</sup> "s" and 2.5 ... 6 mm<sup>2</sup> "insulated ferrules; 12 mm"  
Depending on the conductor characteristic, a conductor with a smaller cross section can also be inserted via push-in termination.

③ Conductor range: 0.5 ... 16 mm<sup>2</sup> "s+f-st";  
Push-in termination: 4 ... 16 mm<sup>2</sup> "s" and 4 ... 10 mm<sup>2</sup> "insulated ferrules; 18 mm"  
Depending on the conductor characteristic, a conductor with a smaller cross section can also be inserted via push-in termination.

④ Conductor range: 0.5 ... 16 mm<sup>2</sup> "s+f-st"; 25 mm<sup>2</sup> "f-st";  
Push-in termination: 6 ... 16 mm<sup>2</sup> "s" and 6 ... 16 mm<sup>2</sup> "insulated ferrules; 18 mm"  
Depending on the conductor characteristic, a conductor with a smaller cross section can also be inserted via push-in termination.

⑤ 250 V = rated voltage  
4 kV = rated impulse voltage  
3 = pollution degree

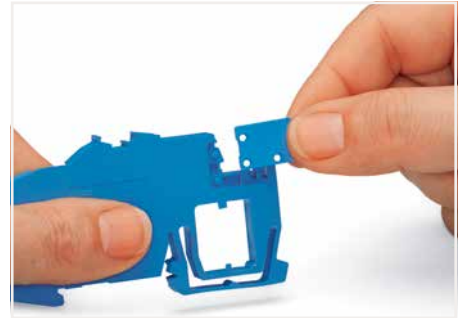
Approvals and corresponding ratings, visit [www.wago.com](http://www.wago.com)

Inserting the separator plate into the busbar carrier to protect the N-busbar against accidental contact.



Removing the separator plate from the busbar carrier or from the N-disconnect terminal block.



Inserting separator plate removed from N-disconnect terminal block.



Touch-proof N-busbar via inserted separator plate

**N-conductor disconnect terminal blocks:**

For the construction and operation of power installations in fire-prone, hazardous locations or public buildings – such as conference centers, stores, hospitals, schools, theaters or hotels – the DIN VDE 0100-710 or DIN VDE 0100-718 standards shall be observed. DIN VDE 0100-482 shall also be observed for fire-prone, hazardous locations. These VDE regulations mandate that every neutral conductor must be provided with a disconnection device so, e.g., insulation testing is possible for every circuit without disconnecting the N-conductor. WAGO's N-disconnect terminal blocks meet this requirement.

**Power distribution disconnect terminal blocks:**

According to DIN VDE 0100-710, "Requirements for operating facilities, rooms and special installations – medical facilities," equipotential bonding conductors shall be run on a potential equalization busbar. The potential equalization busbar and the protective ground conductor busbar must be mounted in a common housing and be connected to each other using a disconnectable copper conductor of minimum 16 mm<sup>2</sup> (6 AWG). Furthermore, all equipotential bonding conductors must be connected to the potential equalization busbar and clearly arranged so they can be disconnected individually and accessed at any time. Depending on their function, they must be provided with captive marking. WAGO's power distribution disconnect terminal blocks meet these requirements.



PUSH-IN CAGE CLAMP®

# Supply Terminal Block for Distribution Boxes, Ground Conductor Terminal Block, N-Disconnect Terminal Block, Power Distribution Disconnect Terminal Block TOPJOB® S

## 16 (25 "f-st") mm<sup>2</sup>; 2016 Series

### Technical Data

0.5 ... 16 (25 "f-st") mm<sup>2</sup> ① | 20 ... 4 AWG

800 V/8 kV/3 ②

I<sub>N</sub> 76 A

Terminal block width: 12 mm / 0.472 inch

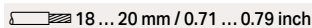
 18 ... 20 mm / 0.71 ... 0.79 inch

### Technical Data

0.5 ... 16 (25 "f-st") mm<sup>2</sup> ① | 20 ... 4 AWG

250 V/4 kV/3 ③

I<sub>N</sub> 76 A

Terminal block width: 12 mm / 0.472 inch

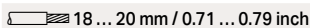
 18 ... 20 mm / 0.71 ... 0.79 inch

① Conductor range: 0.5 ... 16 mm<sup>2</sup> "s+f-st", 25 mm<sup>2</sup> "f-st"; Push-in termination: 6 ... 16 mm<sup>2</sup> "s" and 6 ... 16 mm<sup>2</sup> "insulated ferrules; 18 mm"  
Depending on the conductor characteristic, a conductor with a smaller cross section can also be inserted via push-in termination.



② 800 V = rated voltage  
8 kV = rated impulse voltage  
3 = pollution degree

③ 250 V = rated voltage  
4 kV = rated impulse voltage  
3 = pollution degree

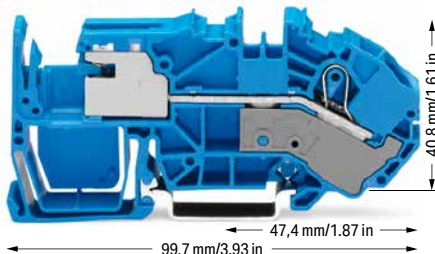
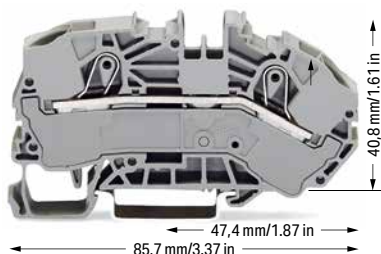
Approvals and corresponding ratings, visit [www.wago.com](http://www.wago.com)



### 2-conductor supply terminal block for distribution boxes

Color	Item No.	Pack. Unit
 gray	2016-7601	20
 blue	2016-7604	20

### 2-conductor ground terminal block 15 mm high DIN-35 rails shall be used for a current load higher than 76 A!

 green-yellow	2016-7607	20
---	-----------	----

### Accessories; item-specific

#### End and intermediate plate; 1 mm thick

 orange	2016-7692	100 (25)
 gray	2016-7691	100 (25)

### 1-conductor N-disconnect terminal block

Color	Item No.	Pack. Unit
 blue	2016-7714	20

### 1-conductor power distribution disconnect terminal block

 gray	2016-7711	20
--	-----------	----

### Accessories; item-specific

#### End and intermediate plate; 1 mm thick

 orange	2016-7792	100 (25)
--	-----------	----------

#### Lock-out; prevents reclosing of slide link; snap-on type

 orange	2006-7300	100 (25)
--	-----------	----------

### Accessories; 2016 Series

Appropriate marking systems: WMB/Marking strips

#### Push-in type jumper bar; insulated; I<sub>N</sub> 76 A; light gray

 2-way	2016-402	25
 3-way	2016-403	25
 4-way	2016-404	25
 5-way	2016-405	25

#### Push-in type jumper bar; insulated; I<sub>N</sub> 76 A; light gray

 1 to 3	2016-433	25
 1 to 4	2016-434	25
 1 to 5	2016-435	25

#### Protective warning marker; with black high-voltage symbol; for 5 terminal blocks

 yellow	2016-115	100 (25)
---	----------	----------

#### Finger guard; touch-proof cover protects unused conductor entries

 yellow	2016-100	100 (25)
---	----------	----------

#### Busbar; tin-plated; 1000 mm long; copper (10 x 3) mm

 I <sub>N</sub> 140 A	210-133	1
---	---------	---

#### Busbar cover; 1000 mm long

 transparent	777-303	1
--	---------	---

#### Test plug adapter; for 4 mm Ø test plug

 gray	2009-174	100 (25)
--	----------	----------

#### Testing tap; for max. 2.5 mm<sup>2</sup>

 gray	2009-182	100 (25)
--	----------	----------

#### Test plug; with 500 mm cable; 2 mm Ø; max. 42 V

 red	210-136	50 (1)
---	---------	--------

#### Test plug; with 500 mm cable; 2.3 mm Ø; max. 42 V

 yellow	210-137	50 (1)
--	---------	--------

#### Marking strip; plain; 11 mm wide; 50 m reel

 white	2009-110	1
---	----------	---

#### WMB marking card; white; 10 strips with 10 markers/card; 5 ... 5.2 mm stretchable

 plain	793-5501	5
---	----------	---

### N-conductor disconnect terminal blocks:

For the construction and operation of power installations in fire-prone, hazardous locations or public buildings – such as conference centers, stores, hospitals, schools, theaters or hotels – the DIN VDE 0100-710 or DIN VDE 0100-718 standards shall be observed. DIN VDE 0100-482 shall also be observed for fire-prone, hazardous locations. These VDE regulations mandate that every neutral conductor must be provided with a disconnection device so, e.g., insulation testing is possible for every circuit without disconnecting the N-conductor. WAGO's N-disconnect terminal blocks meet this requirement.

### Power distribution disconnect terminal blocks:

According to DIN VDE 0100-710, "Requirements for operating facilities, rooms and special installations – medical facilities," equipotential bonding conductors shall be run on a potential equalization busbar. The potential equalization busbar and the protective ground conductor busbar must be mounted in a common housing and be connected to each other using a disconnectable copper conductor of minimum 16 mm<sup>2</sup> (6 AWG). Furthermore, all equipotential bonding conductors must be connected to the potential equalization busbar and clearly arranged so they can be disconnected individually and accessed at any time. Depending on their function, they must be provided with captive marking. WAGO's power distribution disconnect terminal blocks meet these requirements.

## Supply Terminal Blocks Assembly TOPJOB® S

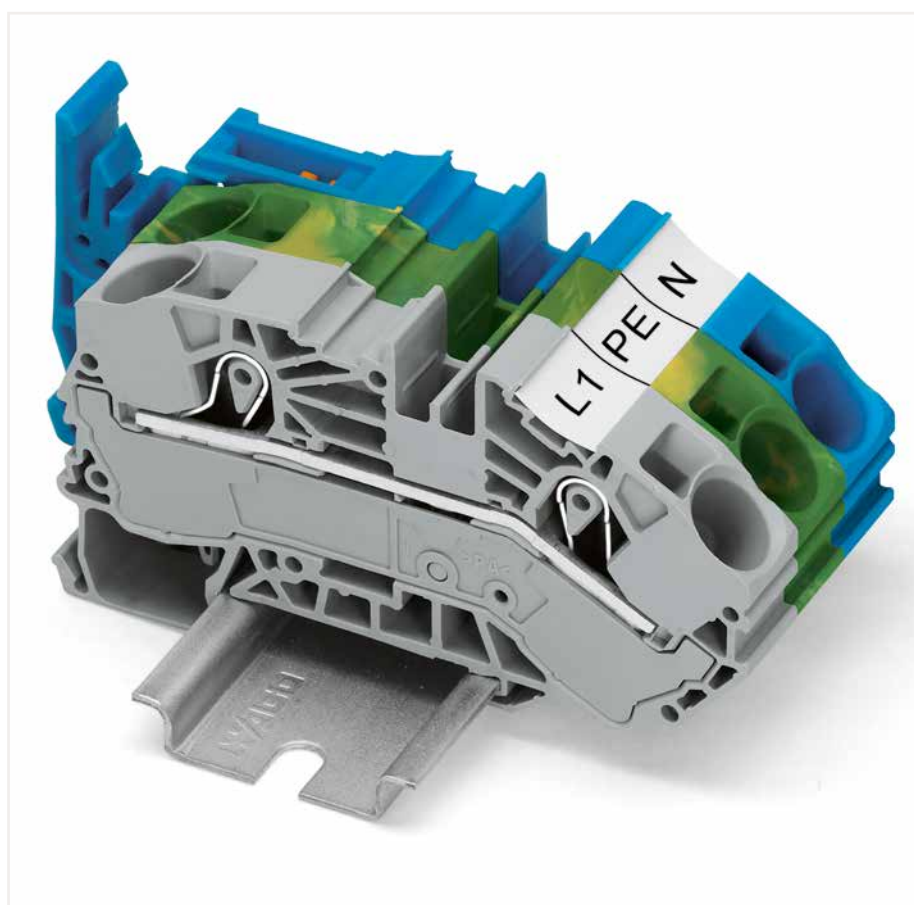

With an angled conductor entry, the 2016 Series Supply Terminal Blocks simplify the wiring of solid conductors in distribution boxes. Solid conductors of the largest cross-section can be connected easily, enabling the distribution box cover to fit without interfering with the conductors.

## Electrical Interconnection Set and Rail-Mount Terminal Block Set 821 Series



Electrical interconnection set; L-BOXX® 102; 221 Series & TOPJOB® S with Lever

	Item No.	Pack. Unit
	821-153	1

### Contents

Qty.	Item No.	Description
		COMPACT Splicing Connectors
100	221-412	COMPACT splicing connector; 2 wires; 0.14 ... 4 mm <sup>2</sup> ; with levers; transparent
50	221-413	COMPACT splicing connector; 3 wires; 0.14 ... 4 mm <sup>2</sup> ; with levers; transparent
25	221-415	COMPACT splicing connector; 5 wires; 0.14 ... 4 mm <sup>2</sup> ; with levers; transparent
50	221-612	COMPACT splicing connector; 2 wires; 0.5 ... 6 mm <sup>2</sup> ; with levers; transparent
30	221-613	COMPACT splicing connector; 3 wires; 0.5 ... 6 mm <sup>2</sup> ; with levers; transparent
15	221-615	COMPACT splicing connector; 5 wires; 0.5 ... 6 mm <sup>2</sup> ; with levers; transparent
		TOPJOB® S Rail-Mount Terminal Blocks
60	2102-1201	2-conductor through terminal block; with lever and Push-in CAGE CLAMP®; 0.25 ... 2.5 (4) mm <sup>2</sup> ; gray
12	2106-1201	2-conductor through terminal block; with lever and Push-in CAGE CLAMP®; 0.5 ... 6 (10) mm <sup>2</sup> ; gray
		Accessories
1	210-110	Felt-tip pen; smudge-proof
5	221-500	Mounting carrier; 221 Series – 4 mm <sup>2</sup> ; for DIN-35 rail/screw mounting; orange
3	221-510	Mounting carrier; 221 Series – 6 mm <sup>2</sup> ; for DIN-35 rail/screw mounting; orange
10	249-116	Screwless end stop; for DIN-35 rail; 6 mm wide; gray
2	793-5501	WMB marker card; plain
2	793-5566	WMB marker card; marking 1 ... 50
25	2002-400	Adjacent jumper for continuous commoning; insulated; 2-way; Nominal current: 25 A; light gray
25	2006-402	Push-in type jumper bar; insulated; 2-way; Nominal current: 41 A; light gray
1	2009-310	Operating tool; 3.5 x 0.5 mm and 5.5 x 0.8 mm blades
15	2102-1292	End and intermediate plate; for 2-conductor terminal blocks; orange
5	2106-1292	End and intermediate plate; for 2-conductor terminal blocks; orange

Rail-mount terminal block set; L-BOXX® 102; 20xx, 21xx, 22xx Series

	Item No.	Pack. Unit
	821-154	1

### Contents

Qty.	Item No.	Description
		TOPJOB® S Rail-Mount Terminal Blocks
10	2002-1301	3-conductor through terminal block; with Push-in CAGE CLAMP®; 0.25 ... 2.5 (4) mm <sup>2</sup> ; gray
8	2004-1201	2-conductor through terminal block; with Push-in CAGE CLAMP®; 0.5 ... 4 (6) mm <sup>2</sup> ; gray
20	2102-1201	2-conductor through terminal block; with lever and Push-in CAGE CLAMP®; 0.25 ... 2.5 (4) mm <sup>2</sup> ; gray
6	2102-5301	3-conductor through terminal block; with lever and push-button; 0.25 ... 2.5 (4) mm <sup>2</sup> ; gray
2	2102-5304	3-conductor through terminal block; with lever and push-button; 0.25 ... 2.5 (4) mm <sup>2</sup> ; blue
2	2102-5307	3-conductor ground terminal block; with lever and push-button; 0.25 ... 2.5 (4) mm <sup>2</sup> ; green-yellow
6	2106-5301	3-conductor through terminal block; with lever and push-button; 0.5 ... 6 (10) mm <sup>2</sup> ; gray
2	2106-5304	3-conductor through terminal block; with lever and push-button; 0.5 ... 6 (10) mm <sup>2</sup> ; blue
2	2106-5307	3-conductor ground terminal block; with lever and push-button; 0.5 ... 6 (10) mm <sup>2</sup> ; green-yellow
6	2116-5301	3-conductor through terminal block; with lever and push-button; 0.5 ... 16 (25) mm <sup>2</sup> ; gray
2	2116-5304	3-conductor through terminal block; with lever and push-button; 0.5 ... 16 (25) mm <sup>2</sup> ; blue
2	2116-5307	3-conductor ground terminal block; with lever and push-button; 0.5 ... 16 (25) mm <sup>2</sup> ; green-yellow
25	2200-1401	4-conductor through terminal block; with push-button; 0.14 ... 1 (1.5) mm <sup>2</sup> ; gray
10	2202-1301	3-conductor through terminal block; with push-button; 0.25 ... 2.5 (4) mm <sup>2</sup> ; gray
8	2204-1201	2-conductor through terminal block; with push-button; 0.5 ... 4 (6) mm <sup>2</sup> ; gray
6	2210-1201	2-conductor through terminal block; with push-button; 0.5 ... 10 (16) mm <sup>2</sup> ; gray
2	2210-1204	2-conductor through terminal block; with push-button; 0.5 ... 10 (16) mm <sup>2</sup> ; blue
2	2210-1207	2-conductor ground terminal block; with push-button; 0.5 ... 10 (16) mm <sup>2</sup> ; green-yellow

### Contents 821-154 (continued)

Qty.	Item No.	Description
		Accessories
10	249-116	Screwless end stop; for DIN-35 rail; 6 mm wide; gray
25	2000-402	Push-in type jumper bar; insulated; 2-way; Nominal current: 14 A; light gray
10	2000-1491	End and intermediate plate; for 4-conductor terminal blocks; gray
25	2002-400	Adjacent jumper for continuous commoning; insulated; 2-way; Nominal current: 25 A; light gray
25	2002-402	Push-in type jumper bar; insulated; 2-way; Nominal current: 25 A; light gray
10	2002-1391	End and intermediate plate; for 3-conductor terminal blocks; gray
10	2004-402	Push-in type jumper bar; insulated; 2-way; Nominal current: 32 A; light gray
10	2004-1291	End and intermediate plate; for 2-conductor terminal blocks; gray
10	2006-402	Push-in type jumper bar; insulated; 2-way; Nominal current: 41 A; light gray
5	2010-402	Push-in type jumper bar; insulated; 2-way; Nominal current: 57 A; light gray
5	2010-1291	End and intermediate plate; for 2-conductor terminal blocks; gray
10	2016-402	Push-in type jumper bar; insulated; 2-way; Nominal current: 76 A; light gray
10	2102-1291	End and intermediate plate; for 2-conductor terminal blocks; gray
5	2102-1391	End and intermediate plate; for 3-conductor terminal blocks; gray
5	2106-1391	End and intermediate plate; for 3-conductor terminal blocks; gray
5	2116-1391	End and intermediate plate; for 3-conductor terminal blocks; gray

**Rail-mount terminal block set; L-BOXX® 102; 2002, 2006, 2016 Series**

	Item No.	Pack. Unit
	821-155	1

**Contents**

Qty.	Item No.	Description
		TOPJOB® S Rail-Mount Terminal Blocks
75	2002-1201	2-conductor through terminal block; 0.25 ... 2.5 (4) mm <sup>2</sup> ; gray
25	2002-1204	2-conductor through terminal block; 0.25 ... 2.5 (4) mm <sup>2</sup> ; blue
25	2002-1207	2-conductor ground terminal block; 0.25 ... 2.5 (4) mm <sup>2</sup> ; green-yellow
9	2006-1201	2-conductor through terminal block; 0.5 ... 6 (10) mm <sup>2</sup> ; gray
3	2006-1204	2-conductor through terminal block; 0.5 ... 6 (10) mm <sup>2</sup> ; blue
3	2006-1207	2-conductor ground terminal block; 0.5 ... 6 (10) mm <sup>2</sup> ; green-yellow
12	2016-1201	2-conductor through terminal block; 0.5 ... 16 (25) mm <sup>2</sup> ; gray
6	2016-1204	2-conductor through terminal block; 0.5 ... 16 (25) mm <sup>2</sup> ; blue
6	2016-1207	2-conductor ground terminal block; 0.5 ... 16 (25) mm <sup>2</sup> ; green-yellow
		Accessories
1	210-110	Felt-tip pen; smudge-proof
1	210-722	Operating tool set; with a partially insulated shaft
5	249-119	Height-adjustable group marker carrier
10	249-117	Screwless end stop; for DIN-35 rail; 10 mm wide; gray
2	793-5501	WMB marker card; plain
2	793-5566	WMB marker card; marking 1 ... 50
1	793-5472	WMB marker card; Marking L1, L2, L3, N, PE
25	2002-400	Adjacent jumper for continuous commoning; insulated; 2-way; Nominal current: 25 A; light gray
25	2002-1292	End and intermediate plate; for 2-conductor terminal blocks; orange
25	2006-402	Push-in type jumper bar; insulated; 2-way; Nominal current: 41 A; light gray
10	2006-1292	End and intermediate plate; for 2-conductor terminal blocks; orange
1	2009-110	Marking strip; white; 1 m long
5	2009-182	Testing tap; for max. 2.5 mm <sup>2</sup>
1	2009-310	Operating tool; 3.5 x 0.5 mm and 5.5 x 0.8 mm blades
25	2016-402	Push-in type jumper bar; insulated; 2-way; Nominal current: 76 A; light gray
10	2016-1292	End and intermediate plate; for 2-conductor terminal blocks; orange

# HIGH-CURRENT RAIL-MOUNT TERMINAL BLOCKS

## POWER CAGE CLAMP up to 185 mm<sup>2</sup> (350 kcmil)

### Installation

- Firmly snap a ground conductor terminal block onto DIN-rail.
- The contact foot is secured, providing the appropriate power grounding connection.
- Use a 2.3 mm copper carrier rail.

### Marking

- WMB markers are suitable for all high-current rail-mount terminal blocks.
- Apply marking strips directly to both 35 mm<sup>2</sup> (2 AWG) and 185 mm<sup>2</sup> (350 kcmil) terminal blocks.
- Use marking strip carriers for 35 to 95 mm<sup>2</sup> (2–4/0 AWG) terminal blocks.



### Conductor Termination



Rotate the T-wrench or screwdriver counter-clockwise to the stop ①. Next, push in the orange locking tab. The clamp is locked open for hands-free wiring.



Insert a stripped conductor into the clamping unit until it hits backstop. Hold in this position.



A short counter-clockwise rotation ② releases the tab. When unlocked, the T-wrench rotates clockwise, securely clamping the conductor.



1. Bend conductor
2. Cut conductor to length (Conductor end must be straight!)
3. Strip conductor (Observe strip length printed on terminal block!)





## Safety

- Warning covers visually indicate high-voltage applications, e.g., "CAUTION: Power is still on even after switching off the main switch!"
- Yellow finger guards (detachable) provide touch-proof safety by shielding jumper contact slots and/or unused conductor entries.
- Risk of injury! Keep fingers out of the conductor entry hole!

## Voltage Tap

- Provides safe and easy power distribution to additional loads.
- Insert the unwired tap before actuating the spring for termination.
- For 35 mm<sup>2</sup> (2 AWG) blocks, insert the power tap into the jumper slot in the middle of the terminal block.

## Commoning

for 35 mm<sup>2</sup> (2 AWG)



Commoning adjacent terminal blocks using a centrally positioned push-in jumper. Use an operating tool to remove the conductor.

for 50, 95 and 185 mm<sup>2</sup> (2/0, 4/0 AWG and 350 kcmil)

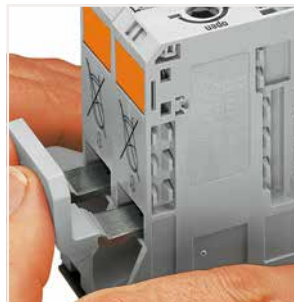

Commoning with an adjacent jumper: insert the jumper above the conductor entry hole prior to conductor termination. The nominal cross-section remains unchanged.

## Commoning

via Step-Down Jumpers with TOPJOB® S



Commoning 35 mm<sup>2</sup> (2 AWG) high-current terminal blocks with 10/16 mm<sup>2</sup> (8/6 AWG) Terminal Blocks TOPJOB® S using step-down jumpers.

Testing



Easy troubleshooting via 4 mm Ø touch-proof test plug. A test plug adapter (283-404) is used for the 35 mm<sup>2</sup> (2 AWG) terminal block (Test plugs are not available from WAGO, but are offered by industry suppliers such as Multi-Contact Deutschland GmbH).

# High-Current Rail-Mount Terminal Blocks; 35 mm<sup>2</sup> 285 Series Description and Installation

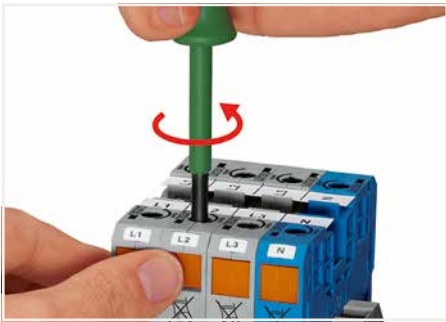

**Conductor termination – step 1:**  
Rotate the operating tool (5.5 mm blade width) counter-clockwise. Next, push in the orange locking tab. The clamp is locked open for hands-free wiring.

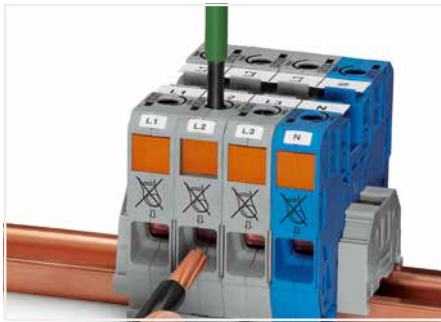

**Conductor termination – step 2:**  
Insert a stripped conductor into the clamping unit until it hits backstop. Hold in this position.

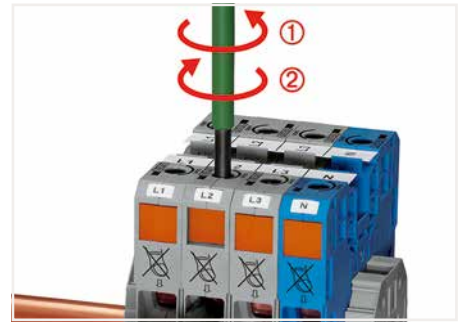

**Conductor termination – step 3:**  
A short counter-clockwise rotation closes the clamp, securing the conductor ①. When unlocked, allow operating tool to rotate clockwise ② to securely terminate the conductor.



The power tap is inserted into the jumper contact slot. It can be fitted with a strain relief plate.



Testing



Testing with test plug adapter (283-404).



High-current rail-mount terminal blocks, 35 mm<sup>2</sup> (2 AWG) and 50 mm<sup>2</sup> (2/0 AWG)



**POWER CAGE CLAMP**  
terminates the following  
copper conductors:  
solid "s"



stranded "st"



fine-stranded,  
also with tinned  
single strands

**POWER CAGE CLAMP®**



Commoning adjacent terminal blocks using a centrally positioned push-in jumper.



Slide the marking strip laterally to remove the jumper.



Commoning 35 mm<sup>2</sup> (2 AWG) POWER CAGE CLAMP Terminal Blocks with 10/16 mm<sup>2</sup> (8/6 AWG) 2010 and 2016 Series Terminal Blocks TOPJOB® S using step-down jumpers (not valid for 2016-76xx and 2016-77xx).



Step-down jumpers common terminal blocks of different sizes, without losing a conductor clamping point. This can be beneficial on long conductor runs where voltage drop can be a problem. A large conductor can be easily connected to smaller conductors at the distribution point.

Step-down jumpers are simply pushed down for full insertion, similar to adjacent jumpers. Commoning may be made in either direction using the special thin end plate to cover the open side. Additional through terminal blocks having a smaller cross-section may be commoned using adjacent jumpers.

In this case, pay attention that:  
The total current of the outgoing circuits does not exceed the nominal current of the step-down jumper.



Side-entry wiring means that even larger conductors, which have limited flexibility, can be easily connected.



WMB markers or self-adhesive, printable marking strips can be accommodated on 35, 50 and 95 mm<sup>2</sup> high-current terminal blocks.



Marker carrier for marking strip or 2 x WMB markers for 285-13x, 285-15x and 285-19x terminal blocks



fine-stranded, with ferrule (gastight crimped)



# High-Current Through Terminal Block, High-Current Ground Conductor Terminal Block

## 35 mm<sup>2</sup>; 285 Series

### Technical Data

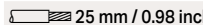
6 ... 35 mm <sup>2</sup>	10 ... 2 AWG
1000 V/8 kV/3 ①	880 V, 115 A <sup>②</sup>
I <sub>N</sub> 125 A	600 V, 115 A <sup>③</sup>
Terminal block width: 16 mm / 0.63 inch	
 25 mm / 0.98 inch	

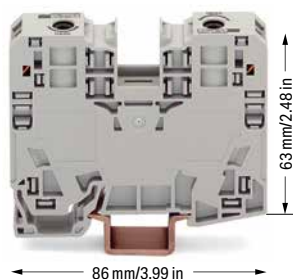

### Technical Data

0.2 ... 6 mm <sup>2</sup>	24 ... 10 AWG
800 V/8 kV/3 ②	600 V, 30 A <sup>③</sup>
I <sub>N</sub> 32 A	600 V, 32 A <sup>③</sup>
Module width: 8 mm / 0.315 inch	
 12 ... 13 mm / 0.47 ... 0.51 inch	



- 1000 V = rated voltage  
8 kV = rated impulse voltage  
3 = pollution degree
- 800 V = rated voltage  
8 kV = rated impulse voltage  
3 = pollution degree
- Terminal blocks with an Ex mark are suitable for Ex e II applications.  
880 V, 101 A  
1 jumper, 75 A

Please observe the application notes:  
Step-down jumpers, see page 229  
Marking, from page 246

Approvals and corresponding ratings,  
visit [www.wago.com](http://www.wago.com)

### 2-conductor through terminal block; only for DIN 35 x 15 rail

Color	Item No.	Pack. Unit
gray	285-135	15
blue	285-134	15
light gray ③	285-935 ③	15
dark gray/yellow	285-131	15

### 2-conductor ground terminal block; only suitable for DIN 35 x 15 rail; 1.5 mm and 2.3 mm thick

green-yellow	285-137	15
green-yellow ③	285-137/999-950 ③	15

### Accessories; item-specific

#### Adjacent jumper; insulated; I<sub>N</sub> 85 A

	gray	285-435	50 (25)
---	------	---------	---------

#### Step-down jumper; insulated; I<sub>N</sub> 90 A

	gray	285-430	50 (25)
---	------	---------	---------

#### Protective warning marker; with a black high-voltage symbol

	yellow	285-420	100 (25)
---	--------	---------	----------

#### Finger guard; touch-proof cover protects unused conductor entries

	yellow	285-421	100 (25)
---	--------	---------	----------

#### Test plug adapter; 11.6 mm wide; for 4 mm Ø test plug; for 1.5 ... 16 mm<sup>2</sup> terminal blocks

	gray	283-404	25
---	------	---------	----

#### Three-phase set; with 35 mm<sup>2</sup> high-current terminal blocks

		285-139	1
---	--	---------	---

#### Power tap; I<sub>N</sub> 24 A; with 500 mm cable; for 16 mm<sup>2</sup> (283/783 Series) and 35 mm<sup>2</sup> (285/785 Series) rail-mount terminal blocks

	gray	283-407	25
---	------	---------	----

#### Operating tool with a partially insulated shaft; type 3; (5.5 x 0.8) mm blade

		210-721	25 (1)
---	--	---------	--------

### Power tap; for 35 mm<sup>2</sup> high-current terminal blocks

Color	Item No.	Pack. Unit
gray	285-427	5

### Accessories; item-specific

#### Strain relief plate; gray

	1-pole	769-410	100 (25)
---	--------	---------	----------

#### Test plug; with 500 mm cable; 2 mm Ø; max. 42 V

	red	210-136	50 (1)
---	-----	---------	--------

#### WMB marking card; white; 10 strips with 10 markers/card; for 5 ... 17.5 mm terminal block width

	plain	793-501	5
---	-------	---------	---

#### WMB marking card; white; 10 strips with 10 markers/card; 5 ... 5.2 mm stretchable

	plain	793-5501	5
---	-------	----------	---

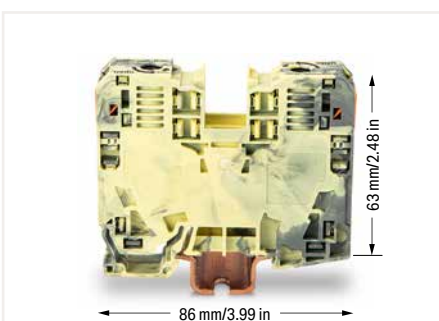

2-conductor through terminal block, dark gray/yellow (285-131), for ground connection without contact to the DIN-rail

### Accessories; for high-current terminal blocks

Appropriate marking systems:  
WMB/WMB Inline/Marking strips

#### Copper DIN-rail; per EN 60715; 35 x 15 mm; 2.3 mm thick; 2 m long

	unslotted	210-198	10
---	-----------	---------	----

#### Marking strip; plain; 11 mm wide; 50 m reel

	white	2009-110	1
--	-------	----------	---

#### WMB marking card; white; 10 strips with 10 markers/card; for 5 ... 17.5 mm terminal block width

	plain	793-501	5
---	-------	---------	---

#### WMB marking card; white; 10 strips with 10 markers/card; 5 ... 5.2 mm stretchable

	plain	793-5501	5
---	-------	----------	---

#### Marker carrier; for POWER CAGE CLAMP 35/50/95 mm<sup>2</sup>; 10.4 mm wide

	gray	285-442	25
---	------	---------	----

#### Screwless end stop; for DIN-35 rail; 14 mm wide

	gray	249-197	10
---	------	---------	----



Always push voltage tap (283-407) down into the terminal block until fully inserted!





# High-Current Rail-Mount Terminal Blocks; 50 ... 185 mm<sup>2</sup> 285 Series Description and Installation

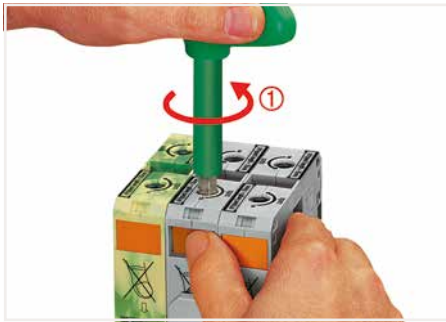

**Conductor termination – step 1:**  
Rotate the T-wrench counter-clockwise to the stop ①. Next, push in the orange locking tab. The clamp is locked open for hands-free wiring.



**Conductor termination – step 2:**  
Insert a stripped conductor into the clamping unit until it hits backstop. Hold in this position.



**Conductor termination – step 3:**  
A short counter-clockwise rotation ② releases the tab. When unlocked, the T-wrench rotates clockwise, securely clamping the conductor.



For the optimal clamping force:

- Bend conductor.
- Cut conductor to length (conductor end must be straight).
- Stripping a conductor.



Always observe the printed strip length!



**Grounding foot:**  
Ground conductor terminal blocks (limited to max. 120 mm<sup>2</sup>/250 kcmil per EN 60947-7-2) must be snapped onto a 2.3 mm thick copper DIN-rail.



Protective warning marker may indicate:  
Notice: Power is still on even after switching off the main switch!



Risk of injury!  
Do not insert fingers in the conductor entry!



Yellow, detachable finger guards provide touch-proof safety by shielding jumper contact slots and/or unused conductor entries.



**POWER CAGE CLAMP**  
terminates the following  
copper conductors:  
solid "s"



stranded "st"



fine-stranded "f-st",  
also with tinned  
single strands

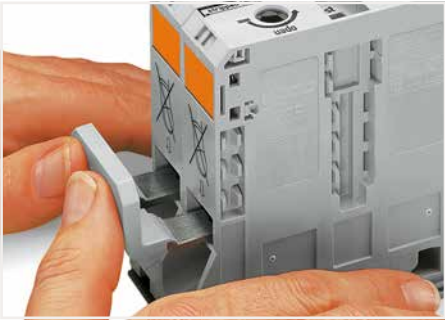

Commoning with an adjacent jumper: insert the jumper above the conductor entry hole – prior to conductor termination. The nominal cross-section remains unchanged.

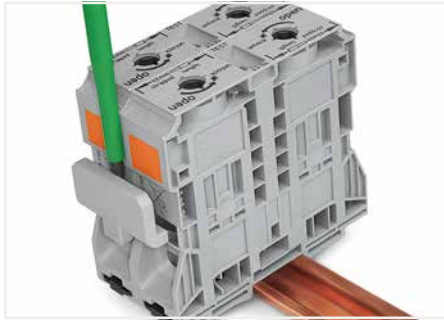

Removing jumper via operating tool.

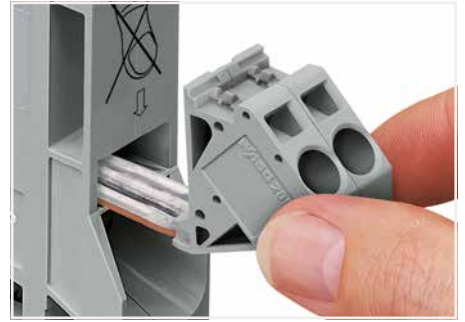

Reliably and easily tap directly into the power supply. Insert the unwired tap before opening the clamping unit.

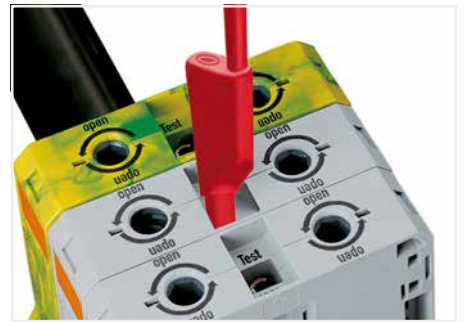
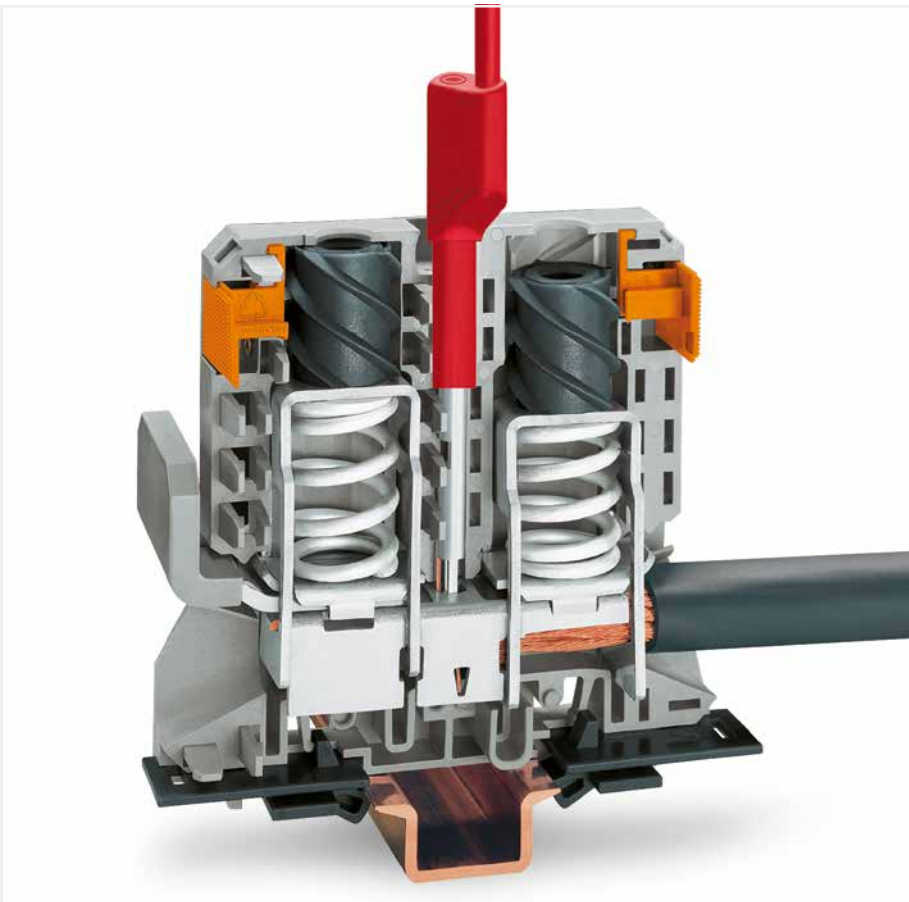

Testing via touch-proof 4 mm Ø test plugs (not available from WAGO, but offered by industry suppliers such as, Multi-Contact Deutschland GmbH).



Testing



WMB markers or self-adhesive, printable marking strips can be accommodated on 35, 50 and 95 mm<sup>2</sup> high-current terminal blocks.

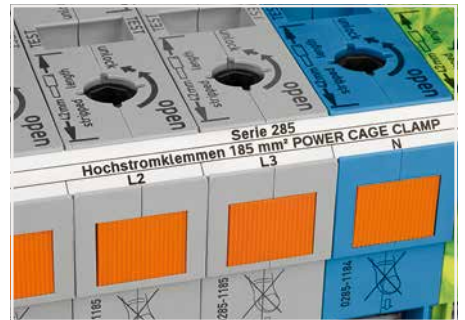

In addition to WMB markers, marking strips can be directly applied to 185 mm<sup>2</sup> (350 kcmil) high-current terminal blocks.



fine-stranded, with ferrule (gastight crimped)



# High-Current Through Terminal Block, High-Current Ground Conductor Terminal Block

## 50 (70 "f-st") mm<sup>2</sup>; 285 Series

### Technical Data

10 ... 50 (70 "f-st") mm <sup>2</sup>	8 ... 1/0 AWG
1000 V/8 kV/3 ①	880 V, 150 A <sup>NA</sup>
I <sub>N</sub> 150 A	600 V, 150 A <sup>CE</sup>
Terminal block width: 20 mm / 0.787 inch	
30 mm / 1.18 inch	

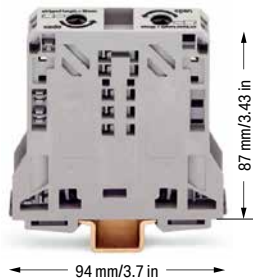

2-conductor through terminal block; only for DIN 35 x 15 rail

Color	Item No.	Pack. Unit
gray	285-150	5
blue	285-154	5
light gray ②	285-950	5
dark gray/yellow	285-151	5

2-conductor ground terminal block; only suitable for DIN 35 x 15 rail; 2.3 mm thick; copper

green-yellow	285-157	5
green-yellow ②	285-157/999-950	5

### Accessories; item-specific

Adjacent jumper; insulated; I<sub>N</sub> 150 A, for 1 jumper; I<sub>N</sub> 130 A, for 2 ... 4 jumpers

gray	285-450	100 (25)
------	---------	----------

Protective warning marker; with a black high-voltage symbol

yellow	285-440	50 (25)
--------	---------	---------

Protective warning marker; with a black high-voltage symbol

yellow	285-449	25
--------	---------	----

Finger guard; touch-proof cover protects unused conductor entries and jumper slots

yellow	285-441	100 (25)
--------	---------	----------

Three-phase set; with 50 mm<sup>2</sup> high-current terminal blocks

three-phase set	285-159	1
-----------------	---------	---

Copper DIN-rail; per EN 60715; 35 x 15 mm; 2.3 mm thick; 2 m long

unslotted	210-198	10
-----------	---------	----

Screwless end stop; for DIN-35 rail; 14 mm wide

gray	249-197	10
------	---------	----

T-wrench with a partially insulated shaft

T-wrench	285-172	1
----------	---------	---

### Technical Data

0.2 ... 6 mm <sup>2</sup>	24 ... 10 AWG
1000 V/8 kV/3 ①	600 V, 30 A <sup>NA</sup>
I <sub>N</sub> 41 A	600 V, 41 A <sup>CE</sup>
Module width: 16 mm / 0.63 inch	
12 ... 13 mm / 0.47 ... 0.51 inch	



Power tap; for 50 mm<sup>2</sup> high-current terminal blocks

Color	Item No.	Pack. Unit
gray	285-447	5

### Accessories; item-specific

Protective warning marker; with black high-voltage symbol; for 5 terminal blocks

yellow	282-415	50 (25)
--------	---------	---------

WMB marking card; white; 10 strips with 10 markers/card; for 5 ... 17.5 mm terminal block width

plain	793-501	5
-------	---------	---

WMB marking card; white; 10 strips with 10 markers/card; 5 ... 5.2 mm stretchable

plain	793-5501	5
-------	----------	---

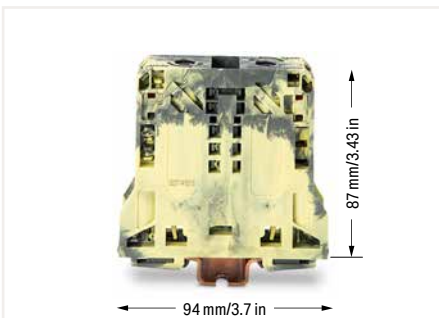

2-conductor through terminal block, dark gray/yellow (285-151), for ground connection without contact to the DIN-rail

① 1000 V = rated voltage  
8 kV = rated impulse voltage  
3 = pollution degree

② Terminal blocks with an Ex mark are suitable for Ex e II applications.  
880 V, 134 A

Adjacent jumpers (285-450) can only be removed or inserted when the clamp is closed.

Approvals and corresponding ratings, visit [www.wago.com](http://www.wago.com)

### Accessories; for high-current terminal blocks

Appropriate marking systems:  
WMB/WMB Inline/Marking strips

Marking strip; plain; 11 mm wide; 50 m reel

white	2009-110	1
-------	----------	---

WMB marking card; white; 10 strips with 10 markers/card; for 5 ... 17.5 mm terminal block width

plain	793-501	5
-------	---------	---

WMB marking card; white; 10 strips with 10 markers/card; 5 ... 5.2 mm stretchable

plain	793-5501	5
-------	----------	---

Marker carrier; for POWER CAGE CLAMP 35/50/95 mm<sup>2</sup>; 10.4 mm wide

gray	285-442	25
------	---------	----



Marker carrier for marking strip or 2 x WMB markers for 285-13x, 285-15x and 285-19x terminal blocks





# High-Current Through Terminal Block; with Mounting Flanges

## 50 (70 "f-st") mm<sup>2</sup>; 285 Series

Technical Data	
10 ... 50 (70 "f-st") mm <sup>2</sup>	8 ... 1/0 AWG
1000 V/8 kV/3 ①	880 V, 150 A ②
I <sub>N</sub> 150 A	600 V, 150 A ③
Terminal block width: 20 mm / 0.787 inch	
30 mm / 1.18 inch	

Technical Data	
10 ... 50 (70 "f-st") mm <sup>2</sup>	8 ... 1/0 AWG
1000 V/8 kV/3 ①	880 V, 150 A ②
I <sub>N</sub> 150 A	600 V, 150 A ③
Terminal block width: 20 mm / 0.787 inch	
30 mm / 1.18 inch	

- ① 1000 V = rated voltage  
8 kV = rated impulse voltage  
3 = pollution degree
  - ② Terminal blocks with an Ex mark are suitable for Ex e II applications.  
880 V, 134 A
- Adjacent jumpers (285-450) can only be removed or inserted when the clamp is closed.
- Approvals and corresponding ratings, visit [www.wago.com](http://www.wago.com)

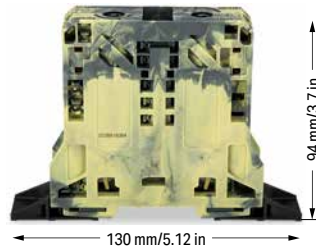

2-conductor through terminal block; with mounting flanges		
Color	Item No.	Pack. Unit
○ gray	285-141	5
● blue	285-144	5
○ light gray ②	285-143 ②	5

2-conductor through terminal block; with mounting flanges		
Color	Item No.	Pack. Unit
● dark gray/yellow	285-147	5
● dark gray/yellow ②	285-147/999-950 ②	5

### Accessories; for high-current terminal blocks

Appropriate marking systems: WMB/WMB Inline/Marking strips

Adjacent jumper; insulated; I <sub>N</sub> 150 A, for 1 jumper; I <sub>N</sub> 130 A, for 2 ... 4 jumpers		
gray	285-450	100 (25)



Marking strip; plain; 11 mm wide; 50 m reel		
white	2009-110	1



Block-to-block connector; for 50 mm <sup>2</sup> high-current terminal blocks		
orange	285-448	50 (25)



WMB marking card; white; 10 strips with 10 markers/card; for 5 ... 17.5 mm terminal block width		
plain	793-501	5



Protective warning marker; with a black high-voltage symbol		
yellow	285-440	50 (25)



WMB marking card; white; 10 strips with 10 markers/card; 5 ... 5.2 mm stretchable		
plain	793-5501	5



Protective warning marker; with a black high-voltage symbol		
yellow	285-449	25



Marker carrier; for POWER CAGE CLAMP 35/50/95 mm <sup>2</sup> ; 10.4 mm wide		
gray	285-442	25



Finger guard; touch-proof covers unused conductor entries and jumper slots		
yellow	285-441	100 (25)



Three-phase set; with 50 mm <sup>2</sup> high-current terminal blocks		
	285-148	1



Power tap; for 50 mm <sup>2</sup> high-current terminal blocks		
gray	285-447	5

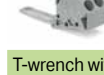

T-wrench with a partially insulated shaft		
	285-172	1



Optionally, insert block-to-block connector (285-448) into housing slot.



Align and snap high-current, through terminal blocks together.

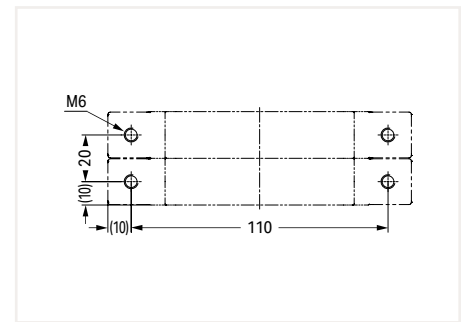

Dimensions (in mm):  
Drill hole separation distance



# High-Current Through Terminal Block, High-Current Ground Conductor Terminal Block

## 95 mm<sup>2</sup>; 285 Series

### Technical Data

25 ... 95 mm <sup>2</sup>	4 ... 4/0 AWG
1000 VAC/DC/1500 VDC/12 kV/3	1000 V, 200 A <b>VA</b>
I <sub>N</sub> 232 A	1000 V, 210 A <b>AE</b>
Terminal block width: 25 mm / 0.984 inch	
35 mm / 1.38 inch	

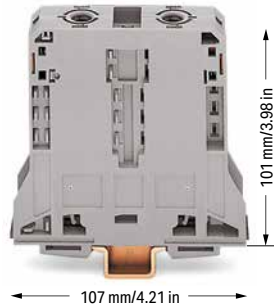

### Technical Data

0.2 ... 10 (16) mm <sup>2</sup> ①	24 ... 8 AWG
1000 V/8 kV/3 ②	600 V, 50 A <b>VA</b>
I <sub>N</sub> 57 A	600 V, 57 A <b>AE</b>
Module width: 20 mm / 0.787 inch	
12 ... 13 mm / 0.47 ... 0.51 inch	



- Power tap; for 95 mm<sup>2</sup> high-current terminal blocks  
Max. conductor size: 16 mm<sup>2</sup>
  - 1000 VAC/DC  
1500 VDC = rated voltage  
12 kV = rated impulse voltage  
3 = pollution degree
  - 1000 V = rated voltage  
8 kV = rated impulse voltage  
3 = pollution degree
  - Terminal blocks with an Ex mark are suitable for Ex e II applications.  
25 ... 95 mm<sup>2</sup> / 4 ... 4/0 AWG  
880 V, 211 A  
1 jumper, 211 A  
2 ... 4 jumpers, 175 A  
35 ... 70 mm<sup>2</sup> / 2 ... 2/0 AWG  
for ground conductor terminal blocks
- Approvals and corresponding ratings, visit [www.wago.com](http://www.wago.com)

### 2-conductor through terminal block; only for DIN 35 x 15 rail

Color	Item No.	Pack. Unit
gray	285-195	5
blue	285-194	5
light gray <b>AE</b>	285-995 ④	5
dark gray/yellow	285-191	5

### 2-conductor ground terminal block; only suitable for DIN 35 x 15 rail; 2.3 mm thick; copper

green-yellow	285-197	5
green-yellow <b>AE</b>	285-197/999-950 ④	5

### Accessories; item-specific

Adjacent jumper; insulated; I<sub>N</sub> 232 A, for 1 jumper; I<sub>N</sub> 192 A, for 2 ... 4 jumpers

gray	285-495	25
------	---------	----

### Protective warning marker; with a black high-voltage symbol

yellow	285-170	50 (25)
--------	---------	---------

### Protective warning marker; with a black high-voltage symbol

yellow	285-175	25
--------	---------	----

### Finger guard; touch-proof cover protects unused conductor entries and jumper slots

yellow	285-169	25
--------	---------	----

### Three-phase set; with 95 mm<sup>2</sup> high-current terminal blocks

three-phase set	285-199	1
-----------------	---------	---

### Copper DIN-rail; per EN 60715; 35 x 15 mm; 2.3 mm thick; 2 m long

unslotted	210-198	10
-----------	---------	----

### Screwless end stop; for DIN-35 rail; 14 mm wide

gray	249-197	10
------	---------	----

### T-wrench with a partially insulated shaft

T-wrench	285-172	1
----------	---------	---

### Power tap; for 95 mm<sup>2</sup> high-current terminal blocks

Color	Item No.	Pack. Unit
gray	285-407	5

### Accessories; item-specific

Protective warning marker; with black high-voltage symbol; for 5 terminal blocks

yellow	284-415	50 (25)
--------	---------	---------

### WMB marking card; white; 10 strips with 10 markers/card; for 5 ... 17.5 mm terminal block width

plain	793-501	5
-------	---------	---

### WMB marking card; white; 10 strips with 10 markers/card; 5 ... 5.2 mm stretchable

plain	793-5501	5
-------	----------	---

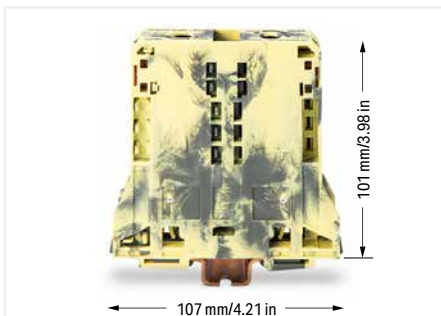

2-conductor through terminal block, dark gray/yellow (285-191), for ground connection without contact to the DIN-rail

### Accessories; for high-current terminal blocks

Appropriate marking systems:  
WMB/WMB Inline/Marking strips

### Marking strip; plain; 11 mm wide; 50 m reel

white	2009-110	1
-------	----------	---

### WMB marking card; white; 10 strips with 10 markers/card; for 5 ... 17.5 mm terminal block width

plain	793-501	5
-------	---------	---

### WMB marking card; white; 10 strips with 10 markers/card; 5 ... 5.2 mm stretchable

plain	793-5501	5
-------	----------	---

### Marker carrier; for POWER CAGE CLAMP 35/50/95 mm<sup>2</sup>; 10.4 mm wide

gray	285-442	25
------	---------	----



Marker carrier for marking strip or 2 x WMB markers for 285-13x, 285-15x and 285-19x terminal blocks



## High-Current Through Terminal Block; with Mounting Flanges

### 95 mm<sup>2</sup>; 285 Series

#### Technical Data

25 ... 95 mm <sup>2</sup>	4 ... 4/0 AWG
1000 V/8 kV/3 ①	1000 V, 200 A $I_N$
$I_N$ 232 A	1000 V, 210 A Ⓔ
Terminal block width: 25 mm / 0.984 inch	
35 mm / 1.38 inch	

#### Technical Data

25 ... 95 mm <sup>2</sup>	4 ... 4/0 AWG
1000 V/8 kV/3 ①	1000 V, 200 A $I_N$
$I_N$ 232 A	1000 V, 210 A Ⓔ
Terminal block width: 25 mm / 0.984 inch	
35 mm / 1.38 inch	

- ① 1000 V = rated voltage  
8 kV = rated impulse voltage  
3 = pollution degree

Approvals and corresponding ratings, visit [www.wago.com](http://www.wago.com)

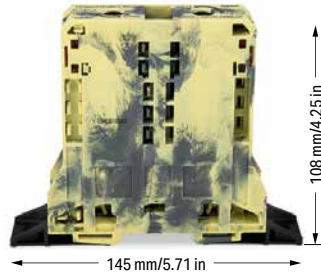

#### 2-conductor through terminal block; with mounting flanges

Color	Item No.	Pack. Unit
gray	285-181	5
blue	285-184	5

#### 2-conductor through terminal block; with mounting flanges

Color	Item No.	Pack. Unit
dark gray/yellow	285-187	5

#### Accessories; for high-current terminal blocks

Appropriate marking systems: WMB/WMB Inline/Marking strips

Adjacent jumper; insulated;  $I_N$  232 A, for 1 jumper;  $I_N$  192 A, for 2 ... 4 jumpers

Color	Item No.	Pack. Unit
gray	285-495	25



Marking strip; plain; 11 mm wide; 50 m reel

Color	Item No.	Pack. Unit
white	2009-110	1



Block-to-block connector; for 95 mm<sup>2</sup> high-current terminal blocks

Color	Item No.	Pack. Unit
orange	285-168	50 (25)



WMB marking card; white; 10 strips with 10 markers/card; for 5 ... 17.5 mm terminal block width

Color	Item No.	Pack. Unit
plain	793-501	5



Protective warning marker; with a black high-voltage symbol

Color	Item No.	Pack. Unit
yellow	285-170	25



WMB marking card; white; 10 strips with 10 markers/card; 5 ... 5.2 mm stretchable

Color	Item No.	Pack. Unit
plain	793-5501	5



Protective warning marker; with a black high-voltage symbol

Color	Item No.	Pack. Unit
yellow	285-175	25



Marker carrier; for POWER CAGE CLAMP 35/50/95 mm<sup>2</sup>; 10.4 mm wide

Color	Item No.	Pack. Unit
gray	285-442	25



Finger guard; touch-proof cover protects unused conductor entries and jumper slots

Color	Item No.	Pack. Unit
yellow	285-169	25



Three-phase set; with 95 mm<sup>2</sup> high-current terminal blocks

Item No.	Pack. Unit
285-188	1



Power tap; for 95 mm<sup>2</sup> high-current terminal blocks

Item No.	Pack. Unit
285-407	5



T-wrench with a partially insulated shaft

Item No.	Pack. Unit
285-172	1



Optionally, insert block-to-block connector (285-168) into housing slot.



Align and snap high-current, through terminal blocks together.

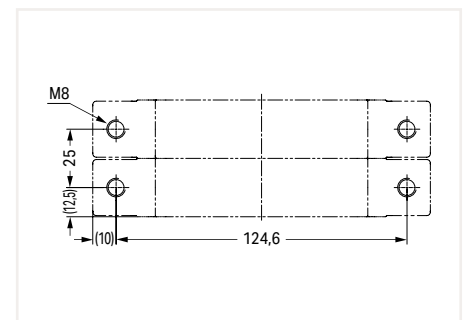

Dimensions (in mm):  
Drill hole separation distance



# High-Current Through Terminal Block, High-Current Ground Conductor Terminal Block

## 185 mm<sup>2</sup>; 285 Series

### Technical Data

50 ... 185 mm <sup>2</sup> ①	1/0 AWG ... 350 kcmil
1000 VAC/DC/1500 VDC/12 kV/3 ③ 1000 V, 310 A ④	
I <sub>N</sub> 353 A	1000 V, 310 A ⑥
Terminal block width: 32 mm / 1.26 inch	
45 ... 47 mm / 1.77 ... 1.85 inch	



### Technical Data

0.2 ... 10 (16) mm <sup>2</sup> ②	24 ... 8 AWG
1000 V/8 kV/3 ④	600 V, 50 A ④
I <sub>N</sub> 57 A	600 V, 50 A ⑥
Module width: 20 mm / 0.787 inch	
12 ... 13 mm / 0.47 ... 0.51 inch	



### 2-conductor through terminal block; only for DIN 35 x 15 rail

Color	Item No.	Pack. Unit
gray	285-1185	5
blue	285-1184	5
light gray ⑤	285-1189 ⑤	5
dark gray/yellow	285-1181	5

### 2-conductor ground terminal block; only suitable for DIN 35 x 15 rail; 2.3 mm thick; copper

green-yellow	285-1187	5
green-yellow ⑤	285-1187/999-950 ⑤	5

### Accessories; item-specific

Adjacent jumper; insulated; I<sub>N</sub> 309 A for 1 jumper

gray	285-1171	25
------	----------	----

Protective warning marker; with a black high-voltage symbol

yellow	285-1177	50 (25)
--------	----------	---------

Protective warning marker; with a black high-voltage symbol

yellow	285-1176	25
--------	----------	----

Finger guard; touch-proof cover protects unused conductor entries and jumper slots

yellow	285-1178	25
--------	----------	----

Three-phase set; with 185 mm<sup>2</sup> high-current terminal blocks

	285-1169	1
--	----------	---

Copper DIN-rail; per EN 60715; 35 x 15 mm; 2.3 mm thick; 2 m long

unslotted	210-198	10
-----------	---------	----

Screwless end stop; for DIN-35 rail; 14 mm wide

gray	249-197	10
------	---------	----

T-wrench with a partially insulated shaft

	285-172	1
--	---------	---

### Power tap; for 185 mm<sup>2</sup> high-current terminal blocks

Color	Item No.	Pack. Unit
gray	285-1175	5

### Accessories; item-specific

Protective warning marker; with black high-voltage symbol; for 5 terminal blocks

yellow	284-415	50 (25)
--------	---------	---------

WMB marking card; white; 10 strips with 10 markers/card; for 5 ... 17.5 mm terminal block width

plain	793-501	5
-------	---------	---

WMB marking card; white; 10 strips with 10 markers/card; 5 ... 5.2 mm stretchable

plain	793-5501	5
-------	----------	---

① 50 ... 120 mm<sup>2</sup> / 1/0 AWG ... 250 kcmil for ground conductor terminal blocks (285-1187)

② Power tap; for 185 mm<sup>2</sup> high-current terminal blocks Max. conductor size: 16 mm<sup>2</sup>

③ 1000 VAC/DC  
1500 VDC = rated voltage  
12 kV = rated impulse voltage  
3 = pollution degree

④ 1000 V = rated voltage  
8 kV = rated impulse voltage  
3 = pollution degree

⑤ Terminal blocks with an Ex mark are suitable for Ex e II applications.  
50 ... 185 mm<sup>2</sup> / 1/0 AWG ... 350 kcmil  
1000 V, 250 A  
1 jumper, 236 A  
50 ... 120 mm<sup>2</sup> / 1/0 AWG ... 250 kcmil for ground conductor terminal blocks

Approvals and corresponding ratings, visit [www.wago.com](http://www.wago.com)

### Accessories; for high-current terminal blocks

Appropriate marking systems:  
WMB/WMB Inline/Marking strips

Marking strip; plain; 11 mm wide; 50 m reel

white	2009-110	1
-------	----------	---

WMB marking card; white; 10 strips with 10 markers/card; for 5 ... 17.5 mm terminal block width

plain	793-501	5
-------	---------	---

WMB marking card; white; 10 strips with 10 markers/card; 5 ... 5.2 mm stretchable

plain	793-5501	5
-------	----------	---

Marker carrier; for POWER CAGE CLAMP 35/50/95 mm<sup>2</sup>; 10.4 mm wide

gray	285-442	25
------	---------	----



Tapping directly into the power supply.

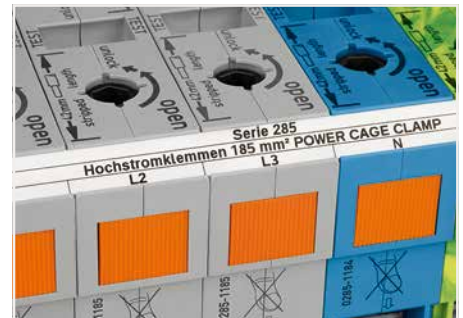

In addition to WMB markers, marking strips can be directly applied to 185 mm<sup>2</sup> (350 kcmil) high-current terminal blocks.

## High-Current Through Terminal Block; with Mounting Flanges 185 mm<sup>2</sup>; 285 Series

### Technical Data

50 ... 185 mm <sup>2</sup>	1/0 AWG ... 350 kcmil
1000 VAC/DC/1500 VDC/12 kV/3 ① 1000 V, 310 A ②	
I <sub>N</sub> 353 A	1000 V, 310 A ②
Terminal block width: 32 mm / 1.26 inch	
45 ... 47 mm / 1.77 ... 1.85 inch	



### Technical Data

50 ... 185 mm <sup>2</sup>	1/0 AWG ... 350 kcmil
1000 VAC/DC/1500 VDC/12 kV/3 ① 1000 V, 310 A ②	
I <sub>N</sub> 353 A	1000 V, 310 A ②
Terminal block width: 32 mm / 1.26 inch	
45 ... 47 mm / 1.77 ... 1.85 inch	

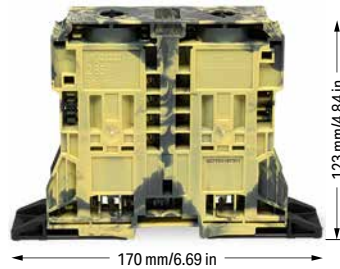

### 2-conductor through terminal block; with mounting flanges

Color	Item No.	Pack. Unit
○ gray	285-1161	4
● blue	285-1164	4
○ light gray ②	285-1163 ②	4

### 2-conductor through terminal block; with mounting flanges

Color	Item No.	Pack. Unit
● dark gray/yellow	285-1167	4
● dark gray/yellow ②	285-1167/999-950 ②	4

### Accessories; for high-current terminal blocks

Appropriate marking systems: WMB/WMB Inline/Marking strips

#### Adjacent jumper; insulated; I<sub>N</sub> 309 A for 1 jumper

gray	285-1171	25
------	----------	----



#### Marking strip; plain; 11 mm wide; 50 m reel

white	2009-110	1
-------	----------	---



#### Block-to-block connector; for 185 mm<sup>2</sup> high-current terminal blocks

orange	285-1179	50 (25)
--------	----------	---------



#### WMB marking card; white; 10 strips with 10 markers/card; for 5 ... 17.5 mm terminal block width

plain	793-501	5
-------	---------	---



#### Protective warning marker; with a black high-voltage symbol

yellow	285-1177	50 (25)
--------	----------	---------



#### WMB marking card; white; 10 strips with 10 markers/card; 5 ... 5.2 mm stretchable

plain	793-5501	5
-------	----------	---



#### Protective warning marker; with a black high-voltage symbol

yellow	285-1176	25
--------	----------	----



#### Finger guard; touch-proof cover protects unused conductor entries and jumper slots

yellow	285-1178	25
--------	----------	----



#### Three-phase set; with 185 mm<sup>2</sup> high-current terminal blocks

	285-1165	1
--	----------	---



#### Power tap; for 185 mm<sup>2</sup> high-current terminal blocks

	285-1175	5
--	----------	---



#### T-wrench with a partially insulated shaft

	285-172	1
--	---------	---



- 1000 VAC/DC  
1500 VDC = rated voltage  
12 kV = rated impulse voltage  
3 = pollution degree
  - Terminal blocks with an Ex mark are suitable for Ex e II applications.  
50 ... 185 mm<sup>2</sup> / 1/0 AWG ... 350 kcmil  
1000 V, 250 A  
1 jumper, 236 A
- Approvals and corresponding ratings, visit [www.wago.com](http://www.wago.com)



Optionally, insert block-to-block connector (285-1179) into housing slot.

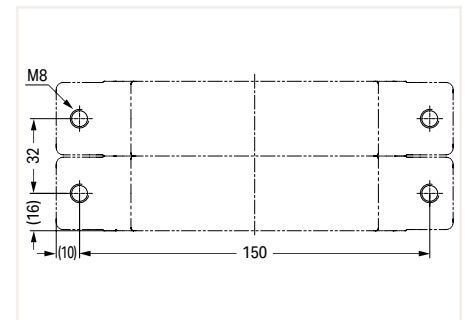

Dimensions (in mm):  
Drill hole separation distance



Secure the terminal block to a mounting plate using two M8 cylinder-head screws and appropriate washers.

## Smart Data

### Supports Workflow from Control Cabinet Planning to Installation

#### Electrical Planning

Directly import data from a CAE circuit diagram into the Smart Designer engineering software or output marking data on Smart Printer

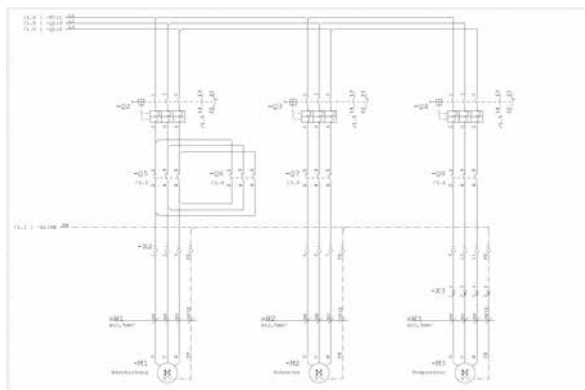

#### Technical and Commercial Item Data

Classified by ETIM and eCl@ss – also in Advanced Format



#### Mechanical Planning

CAD export into all standard CAD formats and in different granularities



### Smart Designer

- Free online configuration and ordering software for all electrical interconnect and automation components
- No installation required
- Available worldwide – 24 hours a day
- Item data is always updated
- Auto-audit feature checks product compatibility via programmed database
- Design in full 3-D

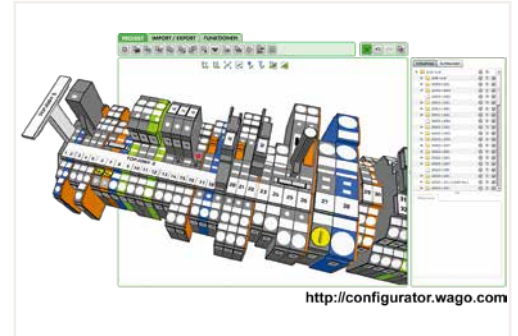

### Smart Script

- XML-based software for all WAGO labeling materials
- Data import from CAE systems
- Font size check
- Material selection wizard



Configuration made easy – <http://configurator.wago.com>



# Smart Printer

## The Fastest Marking System

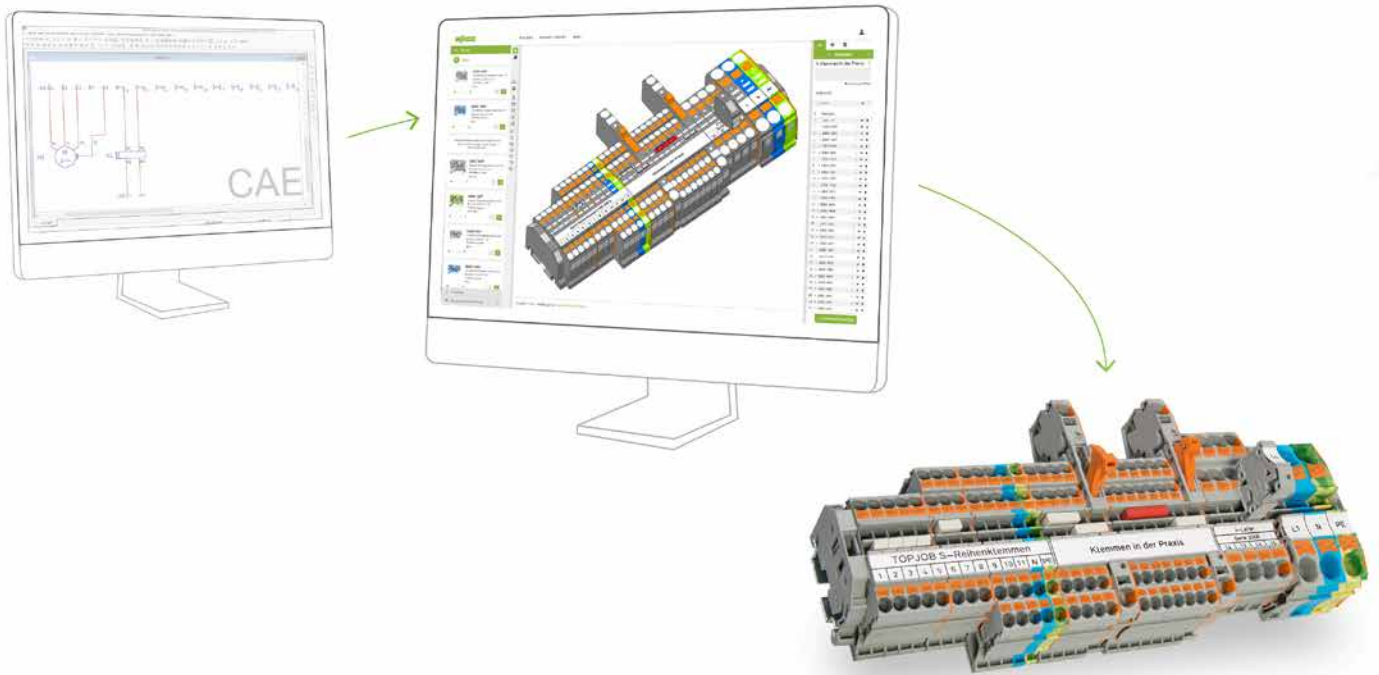

### Smart Script



Smart Script  
Import from CAE systems or create customized marking.

### Smart Designer

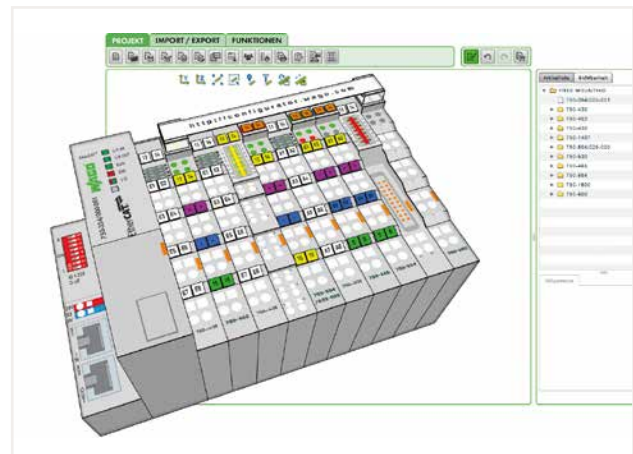

Smart Designer  
After designing, print labeling materials directly from the project via Smart Printer



#### Smart Printer

- Compact and easy-to-use
- Quickly print and install marking strips
- Cost-effective marking from beginning to end

## Terminal Block Marking

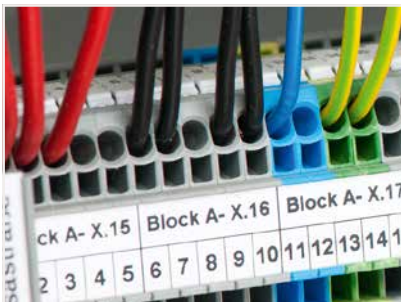

Multi-line marking strips for clear, detailed control cabinet labels

- WMB Inline markers on a reel are suitable for various terminal block sizes – just one marker size for all standard applications
- Same profile across all WAGO Rail-Mount Terminal Blocks TOPJOB® S ensures quick labeling

## Cable and Conductor Marking



Different versions available:

- Marking sleeves, self-laminating labels, conductor markers for thread-on mounting or shrink tubes
- Large variety of marking surface sizes

## Device Marking

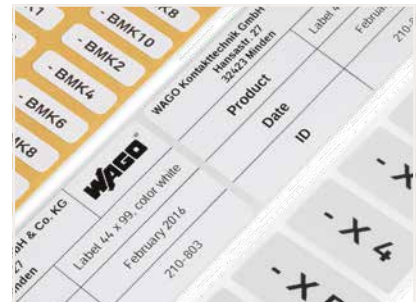

Broad selection of label types (e.g., printable fabric), push-button markers and type plates optimizes marking for devices and control cabinets

- Labels and markers are available in a variety of colors and sizes

# Marking Systems

## Description and Installation

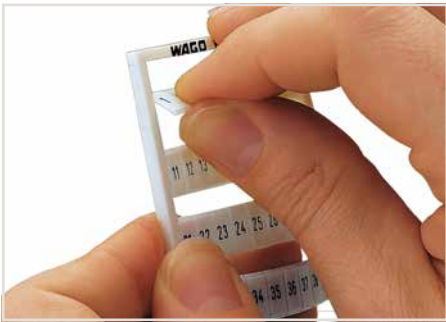

Separating a strip from the WMB or WMB marker card.



Stretching a WMB marker strip.



Separating an individual marker from the strip – for larger terminal blocks.

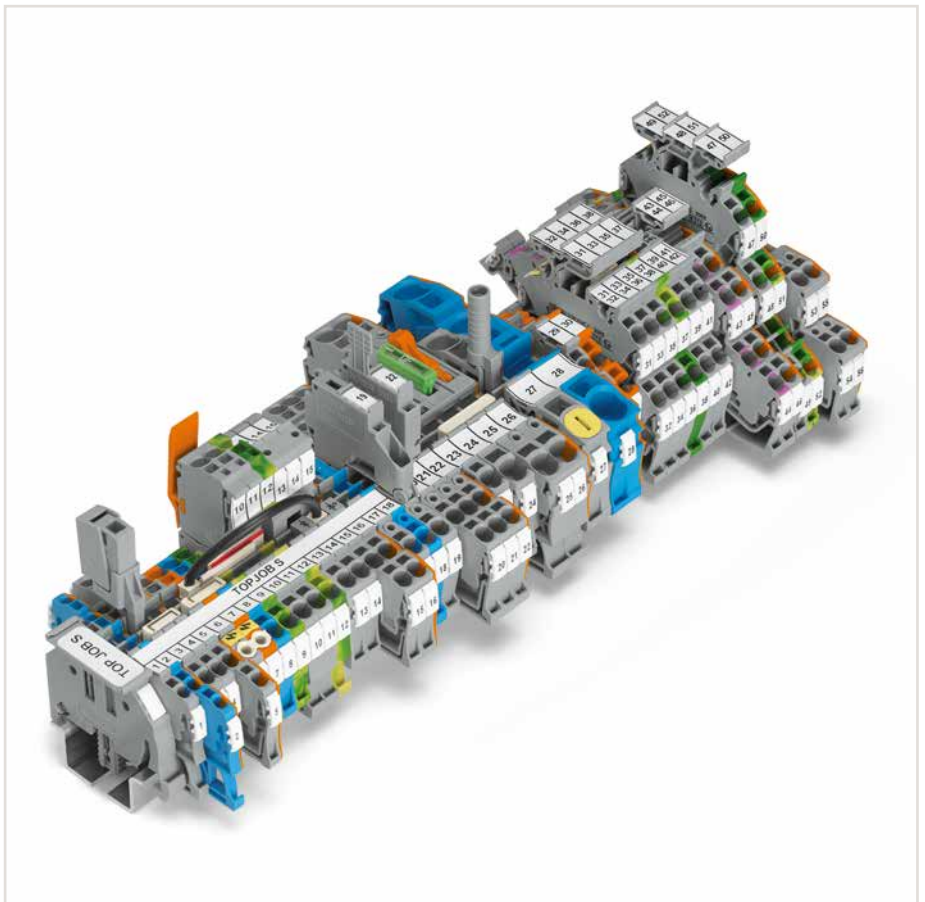

Printing a marking strip (2009-110) via Smart Printer.

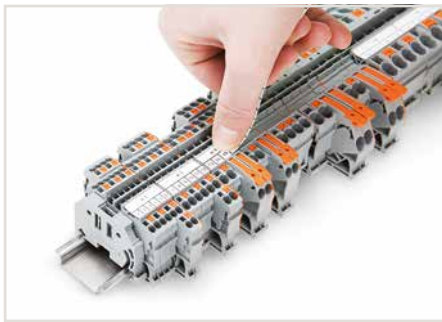

Snapping a marking strip into the marker slot.



Marking strip – multi-line printing



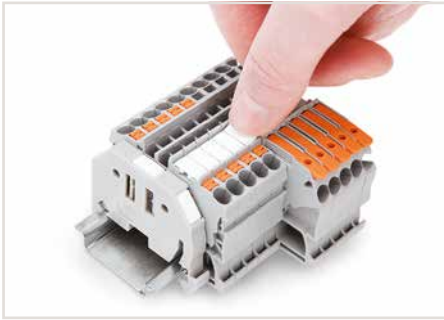

Snapping a marking strip into the marker slot.



Snapping a WMB strip into the marker slot of the double marker carrier.



WMB "decade" marking

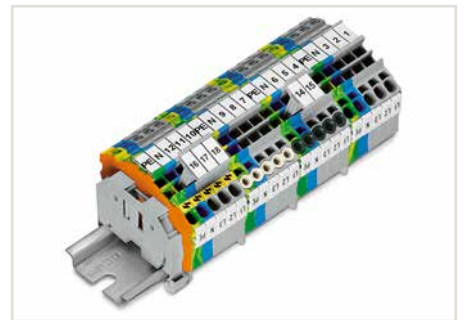

Group marker carriers for WAGO Rail-Mount Terminal Blocks TOPJOB® S – can be snapped into jumper slots.

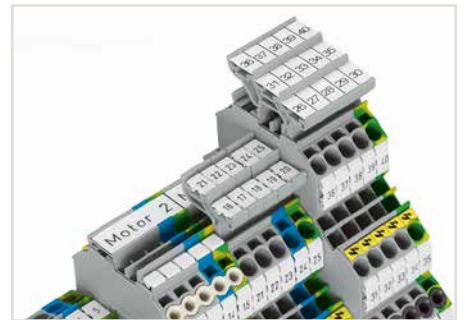

Double- and triple-deck marker carriers can be retrofitted into the jumper contact slot of double- and triple-deck terminal blocks.



Height adjustable group marker carrier (2009-163) for marking strips (2009-110)



Height-adjustable group marker carrier

## Marking System

### Terminal Block Width: 3.5 mm, 4 ... 4.2 mm and from 5 mm

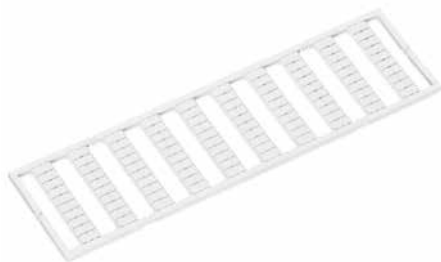

Use		
Marker width	Can be snapped onto the following terminal block series	
	for continuous marking	that will be separated
3.5 mm	2000, 2020	-
4 ... 4.2 mm	279, 2001	-
5 ... 5.2 mm	270, 280, 780, 869, 870, 880, 2002, 2003, 2022	Terminal blocks with spacing > 5 ... 5.2 mm
5 ... 17.5 mm	270, 280, 780, 869, 870, 880	281 ... 285, 781 ... 785, 2002, 2004, 2005, 2006, 2007, 2010, 2016, 2022

WMB marker card; plain; 10 strips with 10 markers/card					
Color	5 mm Item No.	5 ... 5.2 mm Item No.	4 ... 4.2 mm Item No.	3.5 mm Item No.	Pack. Unit
○ white	793-501	793-5501	793-4501	793-3501	5
● yellow	793-501/000-002	793-5501/000-002	793-4501/000-002		5
● red	793-501/000-005	793-5501/000-005	793-4501/000-005		5
● blue	793-501/000-006	793-5501/000-006	793-4501/000-006		5
○ gray	793-501/000-007	793-5501/000-007	793-4501/000-007		5
● orange	793-501/000-012	793-5501/000-012	793-4501/000-012		5
● light green	793-501/000-017	793-5501/000-017	793-4501/000-017		5
● green	793-501/000-023	793-5501/000-023	793-4501/000-023		5
● violet	793-501/000-024	793-5501/000-024	793-4501/000-024		5



Use		
Marker width	Can be snapped onto the following terminal block series	
	for continuous marking	that will be separated
3.5 mm	2000, 2020	-
4 ... 4.2 mm	279, 2001	-
5 ... 5.2 mm	270, 280, 780, 869, 870, 880, 2002, 2003, 2022	Terminal blocks with spacing > 5 ... 5.2 mm

WMB Inline; plain; 2,300 WMB markers (3.5 mm)/reel		
Color	3.5 mm Item No.	Pack. Unit
○ white	2009-113	1

WMB Inline; plain; 2,000 WMB markers (4 mm)/reel; stretchable 4 ... 4.2 mm		
Color	4 ... 4.2 mm Item No.	Pack. Unit
○ white	2009-114	1

WMB Inline; plain; 1,500 WMB markers (5 mm)/reel; stretchable 5 ... 5.2 mm		
Color	5 ... 5.2 mm Item No.	Pack. Unit
○ white	2009-115	1



Use		
	Can be snapped onto the following terminal block series	
	2000, 2001, 2002, 2003, 2004, 2005, 2006, 2007, 2010, 2016, 2020, 2022	

Marking strip; plain; 11 mm wide; 50 m reel		
Color	3.5 mm Item No.	Pack. Unit
○ white	2009-110	1



## Group Marker Carrier, Marker Carrier TOPJOB® S



Group marker carrier; snap-on type for jumper slot; gray

	Item No.	Pack. Unit
○ 5 mm wide	2009-191	50 (25)
○ 10 mm wide	2009-192	50 (25)
○ 15 mm wide	2009-193	50 (25)

Group marker carrier; snap-on type for jumper slot; gray

○ 10 mm wide	2009-196	50 (25)
--------------	----------	---------

Marker carrier; for lateral marker slots; 5 mm wide

Color	Item No.	Pack. Unit
○ gray	2009-198	200 (25)

Marker carrier; for jumper slots of double-deck, double-disconnect terminal blocks (2002 Series); 5 mm wide

Color	Item No.	Pack. Unit
○ gray	2002-160	50 (25)

Marker carrier; for jumper slots (2002 Series); 5 mm wide

Color	Item No.	Pack. Unit
○ gray	2002-161	100 (25)



2009-193 Group Marker Carrier (equipped with marking strips) for all 2001 to 2016 Series TOPJOB® S Rail-Mount Terminal Blocks.

Do not use on an end plate!



Using marker carriers for marking strips (2002-161) in jumper slots.



Using marker carriers for marking strips (2009-198) in lateral marker slots.

## Pivoting Group Marker Carrier, Multilevel Marker Carrier TOPJOB® S

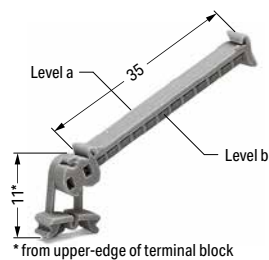

### Pivoting group marker carrier

Color	Item No.	Pack. Unit
○ gray	249-105	50 (25)

### Marker; 4 x 30 markers/sheet

○ white	209-183	1
---------	---------	---

### Protective marker cover

transparent	209-184	50
-------------	---------	----

### Double-deck marker carrier; pivoting

Color	Item No.	Pack. Unit
○ gray	2000-121	50 (25)

### Double-deck marker carrier; pivoting

Color	Item No.	Pack. Unit
○ gray	2002-121	50 (25)



### Triple-deck marker carrier; pivoting

Color	Item No.	Pack. Unit
○ gray	2002-131	50 (25)

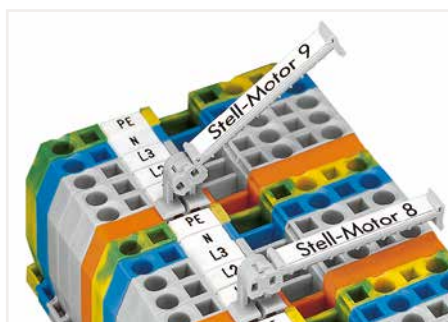

This pivoting group marker carrier has been developed for group marking of rail-mount terminal blocks and incorporates many customer requirements.

- Can be used in all multiprofile marker slots for rail-mount terminal blocks from 5 mm (0.197 inch) on or in spacer housings as shown above.
- Pivotal in seven different stable positions, providing the best visual angle in case of difficult mounting conditions

### Double-deck terminal blocks:

A double-deck marker carrier (2000-121) can be retrofitted to double-deck terminal blocks without a marker carrier.

## Height-Adjustable Group Marker Carrier, Laterally Movable Marking System



Height-adjustable group marker carrier; snaps onto end stops (249-116 and 249-117), adjustable in height from 43.5 to 59.5 mm; for 1 marker or self-adhesive marker and transparent protection cover; 10 mm wide

Color	Item No.	Pack. Unit
○ gray	249-119	50 (25)

Height-adjustable group marker carrier; snaps onto end stops (249-116 and 249-117), adjustable in height from 43.5 to 59.5 mm; for 2 WMB markers or 1 continuous strip; 10 mm wide

○ gray	249-118	100 (25)
--------	---------	----------

Height-adjustable group marker carrier; snaps onto end stops (249-116 and 249-117), adjustable in height from 42.2 to 58.2 mm; with marking surface; 6 mm wide

○ white	249-120	50 (25)
---------	---------	---------

Height-adjustable group marker carrier; snaps onto end stops (249-116 and 249-117), adjustable in height from 45 to 61 mm; for 9 WMB markers or 1 marking strip TOPJOB® S; 12.2 mm wide

○ gray	2009-163	50 (25)
--------	----------	---------



Carrier-through element; height-adjustable; snaps onto end stops (249-116 and 249-117)

○ gray	709-118	50 (25)
--------	---------	---------

Carrier-end element; height-adjustable; snaps onto end stops (249-116 and 249-117)

○ gray	709-119	50 (25)
--------	---------	---------

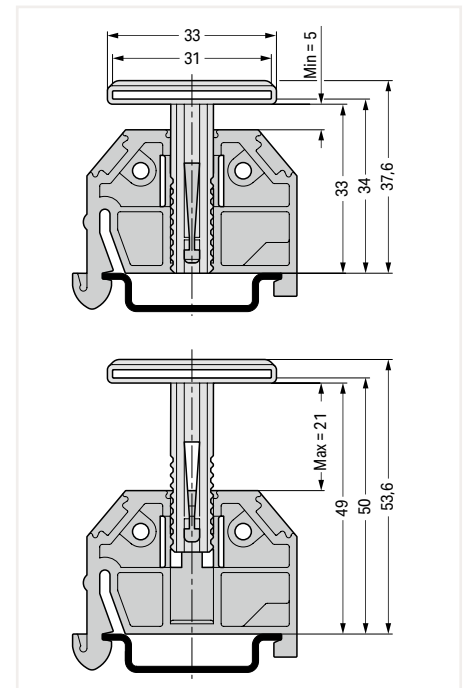

Dimensions in mm

### Accessories; item-specific

Marking strip receptacle; folded; 1 m long; 16 mm wide; 1.7 mm thick

transparent	709-120	1
-------------	---------	---



Marking card; with 14 marking strips; DIN A4

709-193	1
---------	---



Height adjustable group marker carrier (2009-163) for marking strips (2009-110)



This laterally movable marking system can be used as an additional group marker carrier or continuous marking strip carrier for terminal strips or single-deck rail-mount terminal blocks, e.g., for:

- DIN-35 rail-mount terminal strips (264 Series)
- Single-deck rail-mount terminal blocks (279 to 284 Series) with a maximum height of 49 mm (1.93 inch) from upper-edge of DIN-rail (please observe conductor radius)

# Thermal Transfer Printer Smart Printer



Open the printer.



Printer – open



Accessories for unwinding material



Insert the ink ribbon.



Prepare the marking material.



Insert and secure the appropriate roller into the printer.



Printer has several interfaces:  
USB, ETHERNET, serial COM port



Fast, cost-effective and easy to use –  
printing WMB Inline markers via Smart Printer

## Thermal Transfer Printer, Cutter Smart Printer



Smart Printer; WMB Inline markers; Marking strips; Conductor markers and labels; Resolution: 300 dpi

Item No.	Pack. Unit
258-5000	1

### Smart Printer

includes:

- Power supply and cable
- USB cable
- 1 x marking strip reel (2009-110)
- 1 x WMB Inline marker reel (2009-115)
- 2 x roller (258-5006 + 258-5007)
- 1 x reel holder
- 1 x ink ribbon (258-5005)

### Technical Data

Printing method	Thermal transfer
Print head	Glass layer, spring-mounted
Print speed (max.)	127 mm/s (WAGO recommends 50.8 mm/s)
Print width (max.)	47 mm
Print length (max.)	762 mm
Print resolution	300 dpi (12 pixels/mm)
See-through/reflective sensor	Yes, centrally mounted
Operating display	Color TFT LCD with navigation button
Memory	8 MB Flash, 16 MB SDRAM
Interfaces	USB, RS-232, ETHERNET 10/100 Mbps, USB Host
Operating voltage	100 ... 240 VAC, 50 ... 60 Hz (automatic adjustment)
Dimensions (mm) W x H x D	135 x 175 x 245
Weight	2000 g (without printing material)
Operating temperature	5 ... 40 °C (41 ... 104 °F)
Storage temperature	-20 ... 50 °C (-4 ... 122 °F)
Safety approvals	CE (EMC)
Ink ribbon (see also Full Line Catalog, Volume 6, Marking)	External roll diameter: 40 mm; Internal core diameter: 12.7 mm (0.5 inch); Max. length: 110 m; Max. width: 58 mm



Cutter for Smart Printer; for marking strips only; not suitable for WMB Inline markers

Item No.	Pack. Unit
258-5030	1

### Hardware requirements:

- Printer model: Smart Printer
- From manufacturing month/year: 0814 – August 2014
- Firmware version: 1.UW7i
- Printer driver: Version 7.4.2

### Software requirements:

- Smart Script: Version 3.88.9.0 or higher
- WAGO printer settings: Version 2.4.0.0 or higher

### Approved print material to be cut:

- Marking strips: 2009-110, 709-177, 709-178, 757-901/000-005
- Self-adhesive marking strips: 210-702, 210-870 ... -877
- Cable tie markers: 211-835 ... -836, 211-836/000-002
- Self-laminating labels: 211-855 ... -857
- Conductor markers for thread-on mounting: 211-861 ... -863
- Type labels: 210-801 ... -804, 210-812
- Continuous labels: 210-831 ... -834
- Label for circuit identification: 210-813

### Dimensions of printing materials:

- Width (max.): 46 mm
- Thickness (max.): 250 µm

### Technical Data

Width	60 mm
Height	107 mm
Depth	131 mm
Weight	1050 g



# DIN-Rail; Rail End Cap; Angled Support Bracket, Collective Jumper Carrier



Dimensions in mm

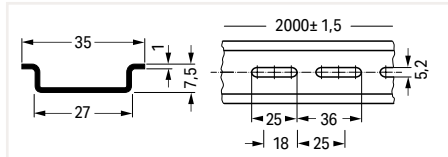

Steel DIN-rail; I<sub>N</sub> 76 A (based on 1 m length); 35 x 7.5 mm; 1 mm thick; 2 m long; per EN 60715

	Item No.	Pack. Unit
unslotted	210-113	10 (1)

Hole width: 25 mm; Hole spacing: 36 mm

slotted	210-112	10 (1)
---------	---------	--------

Hole width: 18 mm; Hole spacing: 25 mm

slotted	210-115	1
---------	---------	---



Dimensions in mm

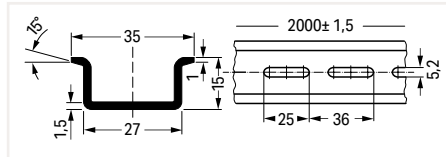

Steel DIN-rail; I<sub>N</sub> 125 A (based on 1 m length); 35 x 15 mm; 1.5 mm thick; 2 m long; similar to EN 60715

	Item No.	Pack. Unit
unslotted	210-114	10 (1)
slotted	210-197	10 (1)



Dimensions in mm

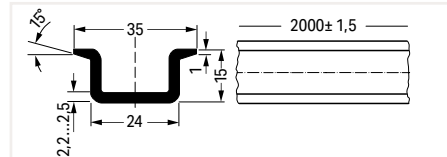

Steel DIN-rail; I<sub>N</sub> 125 A (based on 1 m length); 35 x 15 mm; 2.3 mm thick; 2 m long; per EN 60715

	Item No.	Pack. Unit
unslotted	210-118	10 (1)



Dimensions in mm

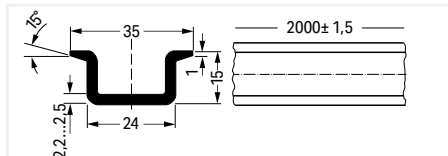

Copper DIN-rail; I<sub>N</sub> 309 A (based on 1 m length); 35 x 15 mm; 2.3 mm thick; 2 m long; per EN 60715

	Item No.	Pack. Unit
unslotted	210-198	10 (1)



Dimensions in mm

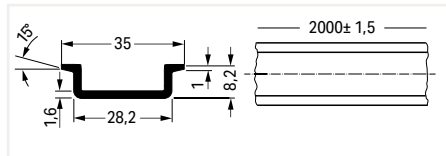

Aluminum DIN-rail; I<sub>N</sub> 76 A (based on 1 m length); 35 x 8.2 mm; 1.6 mm thick; 2 m long; similar to EN 60715

	Item No.	Pack. Unit
unslotted	210-196	20 (1)



Rail end cap; for DIN-35 rail (7.5 mm high)

Color	Item No.	Pack. Unit
○ gray	209-109	50 (25)



Dimensions in mm

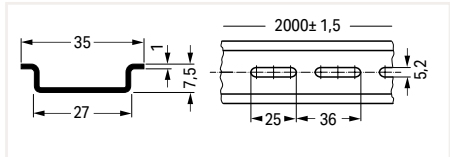

Steel DIN-rail; I, 76 A (based on 1 m length); 35 x 7.5 mm; 1 mm thick; 2 m long; per EN 60715

	Item No.	Pack. Unit
unslotted	210-505	1
slotted	210-504	1



Dimensions in mm

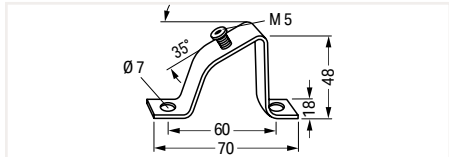

Angled support bracket; without screw

	Item No.	Pack. Unit
	210-148	10

Screw M5 x 8		
	210-149	100 (20)



Dimensions in mm

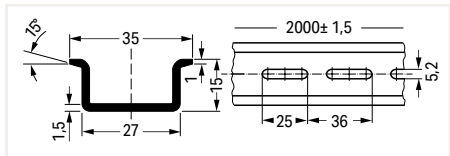

Steel DIN-rail; I, 125 A (based on 1 m length); 35 x 15 mm; 1.5 mm thick; 2 m long; per EN 60715

	Item No.	Pack. Unit
unslotted	210-506	1
slotted	210-508	1



Dimensions in mm

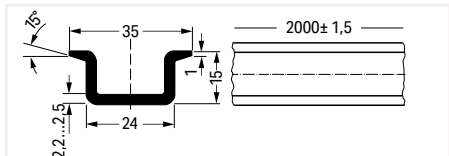

Carrier rail; plastic  
Not suited for use with ground terminal blocks!

	Item No.	Pack. Unit
	210-509	10 (1)

Sold & Serviced By:



Toll Free Phone (877) SERV098

www.electromate.com

sales@electromate.com

## Sealable, Transparent Covers for Rail-Mount Terminal Blocks

### 709 Series

#### Description and Installation



Snapping a cover carrier onto the DIN-rail.



Application example:  
Cover (type 1) without safety warning



Application example:  
Cover (type 1) with safety warning

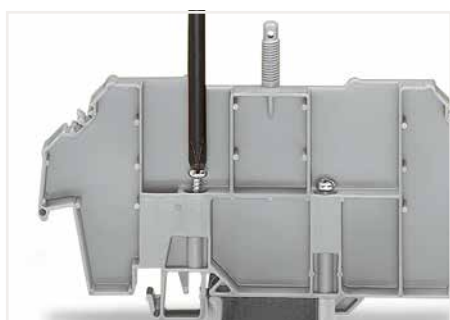

Tightening both securing screw (left) and mounting screw (right).



Application example:  
Cover (type 2) with safety warning

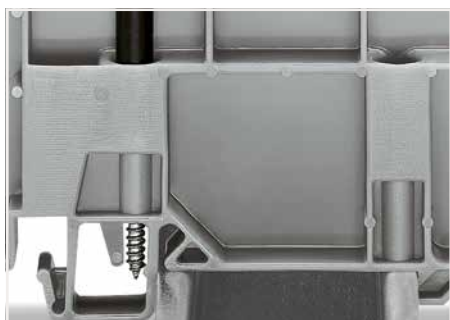

Securing screw – prevents lifting off from the rail.  
Mounting screw – prevents the cover carrier from being moved on the rail.

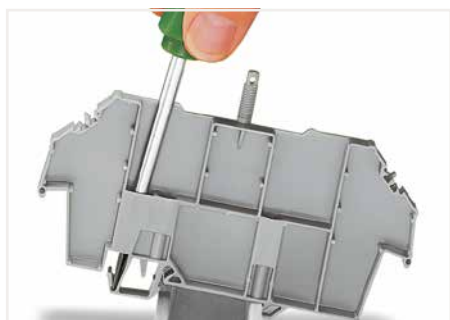

Removing a cover carrier from the DIN-rail.



Inserting a marking strip into the cover.



Cover with lead seals:  
Using covers without lead seals,  
the thread dome-head can be broken off.

# Sealable, Transparent Cover; for Rail-Mount Terminal Blocks 709 Series





Cover; Type 1; for cover carrier (type 1); 1 m long		
Color	Item No.	Pack. Unit
transparent	709-153	10



Cover; Type 2; for cover carrier (type 2); 1 m long		
Color	Item No.	Pack. Unit
transparent	709-154	10

Accessories			
Marking card; with 6 marking strips; for group marking or safety instructions			
	plain	709-183	1

Spare mounting/securing screw; for cover			
		209-196	200 (25)

Spare knurled nut; for cover			
		210-549	100 (25)



Cover carrier; Type 1; incl. mounting/securing screws and knurled nut; for rail-mount terminal blocks (279 to 282, 880 Series); for "Mini" rail-mount terminal blocks (264 Series); for sensor/actuator terminal blocks (270 Series)

Color	Item No.	Pack. Unit
○ gray	709-167	10



Cover carrier; Type 2; incl. mounting/securing screws and knurled nut; for rail-mount terminal blocks (283 to 285 Series); for double- and triple-deck terminal blocks (279 to 281 Series); for TOPJOB® rail-mount terminal blocks (780 to 785 and 775 Series); for sensor/actuator terminal blocks (280 Series); for disconnect/test terminal blocks for transformer circuits (282 Series)

Color	Item No.	Pack. Unit
○ gray	709-168	10

Dimensions in mm

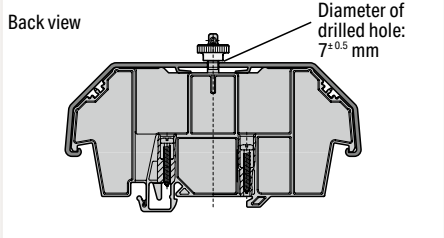
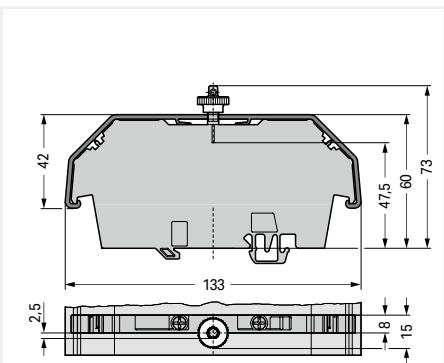

Dimensions in mm

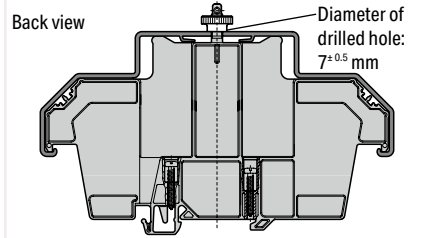
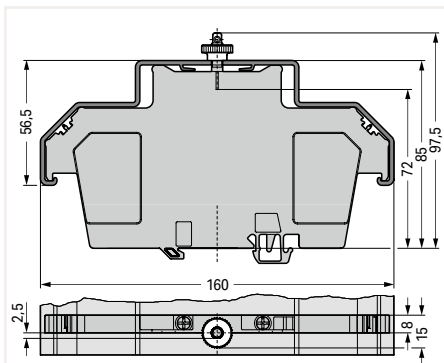

# Sealable, Transparent Cover; for Rail-Mount Terminal Blocks 709 Series



Cover, Type 3; for cover carrier (type 3); 1 m long

Color	Item No.	Pack. Unit
transparent	709-156	10



Cover carrier; Type 3; for rail-mount terminal blocks (2000 to 2016 Series, 2102 to 2116 Series, 2200 to 2216 Series); for transformer terminal blocks (2007 Series)

Color	Item No.	Pack. Unit
○ gray	709-169	10

### Accessories

Marking card; with 6 marking strips; for group marking or safety instructions

 plain	709-183	1
---	---------	---

Marking strip; plain; 11 mm wide; 50 m reel

 white	2009-110	1
---	----------	---

Spare mounting/securing screw; for cover

	209-196	200 (25)
---	---------	----------

Spare knurled nut; for cover

	210-549	100 (25)
---	---------	----------

Dimensions in mm

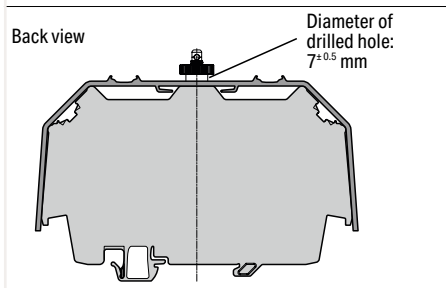
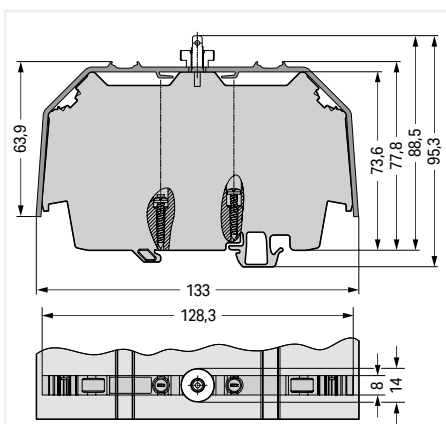



## Screwless End Stop; for DIN-35 Rail 249 Series

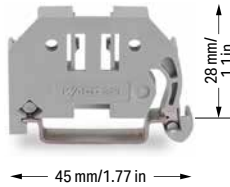

Screwless end stop; for DIN-35 rail; 6 mm wide

Color	Item No.	Pack. Unit
○ gray	249-116	100 (25)

Screwless end stop; for DIN-35 rail; 10 mm wide

○ gray	249-117	50 (25)
--------	---------	---------



Screwless end stop; for DIN-35 rail; 14 mm wide

Color	Item No.	Pack. Unit
○ gray	249-197	10



Simply snap on – that's it!



Simply snap on – that's it!



Simply snap on – that's it!



Removing an end stop from the DIN-rail.

Snap on – that's it! Assembling the WAGO Screwless End Stop is as simple and quick as snapping a rail-mount terminal block onto the rail.

### Tool free!

A tool-free design allows rail-mount terminal blocks to be safely and economically secured against any movement on all DIN-35 rails per DIN EN 60715 (35 x 7.5 mm; 35 x 15 mm).

### Screwless!

The "secret" to a perfect fit lies in the two small clamping plates which keep the end stop in position, even if the rails are mounted vertically.

### Simply snap on – that's it!

In addition, costs are significantly reduced when using large numbers of end stops.

Additional benefit: Three marker slots for all WAGO Rail-Mount Terminal Block Marking Systems and one snap-in hole for WAGO's adjustable height group marker carriers offer individual marking options.

## Operating Tool



Operating tool with a partially insulated shaft; Type 1, (2.5 x 0.4) mm blade

Item No.	Pack. Unit
210-719	50 (1)

Operating tool with a partially insulated shaft; Type 2, (3.5 x 0.5) mm blade

210-720	50 (1)
---------	--------

Operating tool with a partially insulated shaft; Type 3, (5.5 x 0.8) mm blade

210-721	25 (1)
---------	--------

Set of operating tools with a partially insulated shaft; Type 1, (2.5 x 0.4) mm blade; Type 2, (3.5 x 0.5) mm blade; Type 3, (5.5 x 0.8) mm blade

210-722	1
---------	---



Operating tool; Blades: 3.5 mm and 2.5 mm; for installation terminal blocks (TOPJOB® S)

Item No.	Pack. Unit
2009-309	50 (1)

Operating tool; Blades: 3.5 mm and 5.5 mm; for installation terminal blocks (TOPJOB® S)

2009-310	50 (1)
----------	--------



T-wrench with a partially insulated shaft

Item No.	Pack. Unit
285-172	1

T-wrench with a partially insulated shaft and anti-rotation protection

285-173	1
---------	---

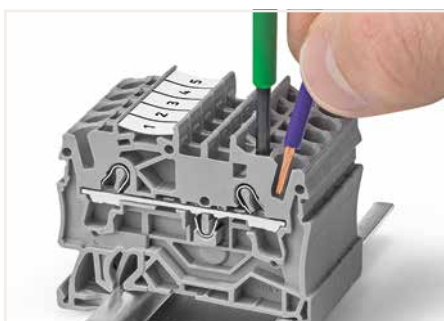

The blade of this operating tool with a partially insulated shaft is ideal for operating front-entry terminal blocks.



Open the clamping unit using an operating tool.



T-wrench with a partially insulated shaft and anti-rotation protection (285-173)



Set of operating tools in a box (210-722)

## Cable Cutter



Cable cutter; for copper and aluminum cables up to 35 mm<sup>2</sup> (2 AWG)

Item No.	Pack. Unit
206-118	10 (1)



Cutting a cable.

# Cable Stripper



Cable knife; for Ø 8 ... 28 mm / 0.31 ... 1.10 inch; with a unique, changeable cable bracket system; including cable bracket

Item No.	Pack. Unit
206-1403	1



Cable knife set; for Ø 4 ... 70 mm / 0.16 ... 2.75 inch; including all cable brackets in a Sortimo® Box

Item No.	Pack. Unit
206-1400	1

Never use this tool on or near live electrical circuits!



To replace the cable bracket, use the new bracket as an operating tool and pull it upwards.

## Item-Specific Accessories

Cable bracket; for Ø 4 ... 16 mm / 0.16 ... 0.63 inch

206-1411	1
----------	---



Cable bracket; for Ø 8 ... 28 mm / 0.31 ... 1.10 inch

206-1412	1
----------	---



Cable bracket; for Ø 27 ... 35 mm / 1.06 ... 1.38 inch

206-1413	1
----------	---



Cable bracket; for Ø 35 ... 50 mm / 1.38 ... 1.97 inch

206-1414	1
----------	---



Cable bracket; for Ø 50 ... 70 mm / 1.97 ... 2.75 inch

206-1415	1
----------	---



## Accessories

Spare inside blade

206-1418	1
----------	---



Spare hook blade

206-1419	1
----------	---



The cutting depth of the hook blade can be adjusted with the slider.



The cutting depth of the inner knife can be adjusted with the screw.

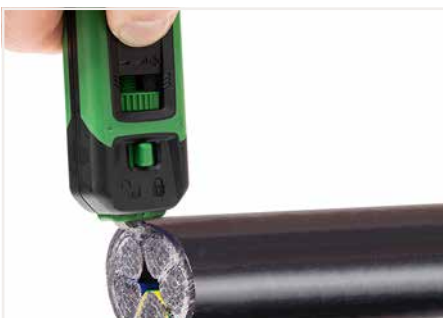

Strip large cross sections with the hook blade.



Release the fuse before using the hook blade.

## Cable Stripper



In-socket cable stripper; for  $\varnothing$  8 ... 13 mm / 5/16 ... 1/2 inch

Item No.	Pack. Unit
206-1441	1



Universal cable stripper; for  $\varnothing$  8 ... 13 mm / 5/16 ... 1/2 inch

Item No.	Pack. Unit
206-1442	1



Data cable stripper; for  $\varnothing$  4.5 ... 10 mm / 3/16 ... 3/8 inch

Item No.	Pack. Unit
206-1451	1



### Product features:

- Extra long design and improved force transmission simplifies stripping in deep device connection sockets
- Special four-blade design for an even more precise round cut
- No cutting depth adjustment required
- TiN-coated blades, TÜV/GS tested
- $\varnothing$  8 ... 13 mm / 5/16 ... 1/2 inch
- Strips all standard round cables, including NYM 3 x 1.5 mm<sup>2</sup>/16 AWG ... 5 x 2.5 mm<sup>2</sup>/14 AWG



### Sheath stripping: longitudinal cut

### Product features:

- Secure grip achieved with soft padding for non-slip grips
- Technically improved functionality
- New locking mechanism prevents the unwanted opening of the tool
- Absolutely straightforward, quick and easy longitudinal cuts – with innovative internal cable duct
- Redesigned blade layout and intake to stop cable waste from jamming the tool
- Durable and ergonomically designed pocket clip
- $\varnothing$  8 ... 13 mm / 5/16 ... 1/2 inch



### Product features:

- Strip outer insulation and foil sheathing with one tool
- Ideal for stripping PVC-insulated data cables with thin insulation (e.g., Cat. 5, Cat. 6, Cat. 7, twisted pair cable)
- TiN-coated blades
- $\varnothing$  4.5 ... 10 mm / 3/16 ... 3/8 inch



Stripping a cable sheath.



Built-in handy knife



Stripping a wire insulation.



## Cable Stripper



Never use this tool on or near live electrical circuits!

The stripping pliers for sensor cables have a blade geometry specially designed for sensor cables with a smaller cross section and a working range from  $\varnothing$  3.2 mm / 0.13 inch (for stranded cables and round cables with  $\varnothing$  3.2 mm ... 4.4 mm / 0.13 ... 0.17 inch).

The stripping pliers for control cables are designed for stronger cables from  $\varnothing$  4.4 mm / 0.17 inch (for stranded cables and round cables with  $\varnothing$  4.4 mm ... 7 mm / 0.17 ... 0.27 inch).

These stripping pliers quickly and safely strip cables for connecting, e.g., sensor/actuator distribution boxes, bus couplers and pluggable connectors.

Suitable for:

- Halogen-free PUR sensor/actuator cables
- Highly flexible TPE-U cables
- Control cables
- PUR cables
- PUR/PVC cables
- PVC cables
- Multi-core cables
- Shielded and unshielded cables

Stripping pliers; for sensor cables; for  $\varnothing$  3.2 ... 4.4 mm / 0.13 ... 0.17 inch

Item No.	Pack. Unit
206-1481	1

Stripping pliers; for control cables; for  $\varnothing$  4.4 ... 7 mm / 0.17 ... 0.27 inch

Item No.	Pack. Unit
206-1482	1

### Item-Specific Accessories

Replacement blade set; for  $\varnothing$  3.2 ... 4.4 mm / 0.13 ... 0.17 inch

	206-1491	1
--	----------	---

### Item-Specific Accessories

Replacement blade set; for  $\varnothing$  4.4 ... 7 mm / 0.17 ... 0.27 inch

	206-1492	1
---	----------	---



## Wire Stripper



Wire stripper "Quickstrip Vario"; 0.03 ... 16 mm<sup>2</sup> / 34 ... 6 AWG; with wire cutter

Item No.	Pack. Unit
206-1125	1

### Accessories

#### Blade set; Standard; 0.03 ... 16 mm<sup>2</sup> / 34 ... 6 AWG

206-1126 1



#### Blade set; V-blade; 0.14 ... 4 mm<sup>2</sup> / 24 ... 12 AWG

206-1127 1



#### Blade set; Oval blade; 10 ... 16 mm<sup>2</sup> / 8 ... 6 AWG

206-1128 1



#### Spare stripping stop

206-1129 1



#### Spare cut protector

206-1131 1



#### Spare clamping jaws

206-1132 1

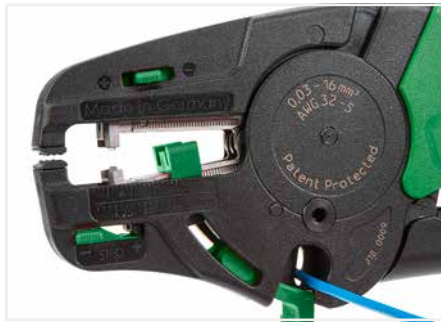

Cutting a conductor.



Partially stripping a conductor.

### Wire Stripper:

- Automatically adjust to conductor size
- Stripping blades cause no damage to conductor strands
- Gripping pressure of jaws adjusts automatically to conductor insulation diameter
- Clamping jaws and stripping blades automatically open once the stripping process is completed – no splaying of the conductor strands
- Exact strip length may be set by sliding black setting stop
- Stripping blades can be replaced
- Self-sharpening, fully protected cutter (replaceable)
- Entire body made of glass-fiber-reinforced polyamide
- Cutting capacity of the wire cutter of fine-stranded conductors up to 16 mm<sup>2</sup> (6 AWG)

## Crimping Tool



Crimping tool "Variocrimp 4"; for insulated and uninsulated ferrules; Crimping range: 0.25 ... 4 mm<sup>2</sup> (24 ... 12 AWG)

	Item No.	Pack. Unit
	206-1204	1

### Item-Specific Accessories

Spring clamp; large

	206-1205	1
--	----------	---

Spring clamp; small

	206-1206	1
---	----------	---



Crimping tool "Variocrimp 16"; for insulated and uninsulated ferrules; Crimping range: 6 mm<sup>2</sup> (10 AWG), 10 mm<sup>2</sup> (8 AWG) and 16 mm<sup>2</sup> (6 AWG)

	Item No.	Pack. Unit
	206-1216	1

### Item-Specific Accessories

Spring clamp; small

	206-1206	1
---	----------	---

### Application notes:

- The built-in crimping pressure control of "Variocrimp 4" automatically adjusts the crimping force to the conductor cross section. Select the wire gauge on "Variocrimp 16" before crimping.
- Only one crimping station is needed to handle the specified conductor range.
- Uniform, compact crimping on all four sides for high conductor retention.
- No need to center the ferrules into the terminal blocks.
- Crimping can be performed from either side (for left- or right-handed users).
- Built-in ratchet mechanism ensures gas-tight crimp connection.
- Crimping tools open automatically after crimping operation is complete.
- Ergonomically designed handles.



Insert the ferruled conductor into the crimping station.



Squeeze handles until ratchet mechanism is released.

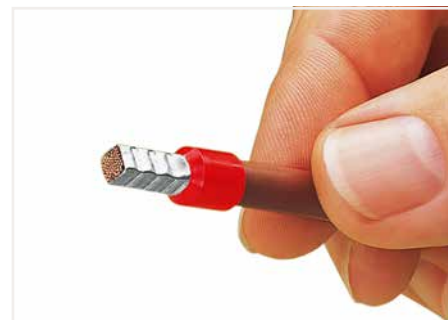

A perfect gas-tight crimp – both electrically and mechanically reliable



Only for "Variocrimp 16":  
Adjust conductor cross section with crimping tool in open position.

Sold & Serviced By:

 **ELECTROMATE**

Toll Free Phone (877) SERV098

[www.electromate.com](http://www.electromate.com)

[sales@electromate.com](mailto:sales@electromate.com)

## Insulated ferrule; for Rail-Mount Terminal Block TOPJOB® S

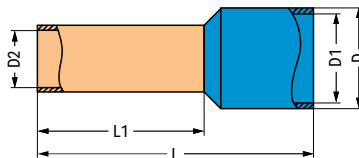

Ferrule; insulated; electro-tin-plated; electrolytic copper; gastight crimped; per DIN 46288 (Part 4/09.09)

Conductor Cross Section	Color	Strip Length	L	L 1	D	D 1	D 2	Item No.	Pack. Unit
0.5 mm <sup>2</sup> / 20 AWG	○ white	12 mm / 0.47 inch	16	10	3,1	2,6	1	216-241	1000
0.75 mm <sup>2</sup> / 18 AWG	○ gray	12 mm / 0.47 inch	16	10	3,3	2,8	1,2	216-242	1000
0.75 mm <sup>2</sup> / 18 AWG	○ gray	14 mm / 0.55 inch	18	12	3,3	2,8	1,2	216-262	1000
1 mm <sup>2</sup> / 18 AWG	● red	12 mm / 0.47 inch	16	10	3,5	3	1,4	216-243	1000
1 mm <sup>2</sup> / 18 AWG	● red	14 mm / 0.55 inch	18	12	3,5	3	1,4	216-263	1000
1.5 mm <sup>2</sup> / 16 AWG	● black	12 mm / 0.47 inch	16	10	4	3,5	1,7	216-244	1000
1.5 mm <sup>2</sup> / 16 AWG	● black	14 mm / 0.55 inch	18	12	4	3,5	1,7	216-264	1000
1.5 mm <sup>2</sup> / 16 AWG	● black	20 mm / 0.79 inch	24	18	4	3,5	1,7	216-284	500
2.5 mm <sup>2</sup> / 14 AWG	● blue	12 mm / 0.47 inch	17	10	4,7	4,2	2,2	216-246	1000
2.5 mm <sup>2</sup> / 14 AWG	● blue	14 mm / 0.55 inch	19	12	4,7	4,2	2,2	216-266	1000
2.5 mm <sup>2</sup> / 14 AWG	● blue	20 mm / 0.79 inch	25	18	4,7	4,2	2,2	216-286	500
4 mm <sup>2</sup> / 12 AWG	○ gray	14 mm / 0.55 inch	20	12	5,4	4,8	2,8	216-267	500
4 mm <sup>2</sup> / 12 AWG	○ gray	20 mm / 0.79 inch	26	18	5,4	4,8	2,8	216-287	100
6 mm <sup>2</sup> / 10 AWG	● yellow	14 mm / 0.55 inch	20	12	6,9	6,3	3,5	216-208	100
6 mm <sup>2</sup> / 10 AWG	● yellow	20 mm / 0.79 inch	26	18	6,9	6,3	3,5	216-288	100
10 mm <sup>2</sup> / 8 AWG	● red	20 mm / 0.79 inch	28	18	8,4	7,6	4,5	216-289	100
16 mm <sup>2</sup> / 6 AWG	● blue	23 mm / 0.91 inch	28	18	9,6	8,8	5,8	216-210	100

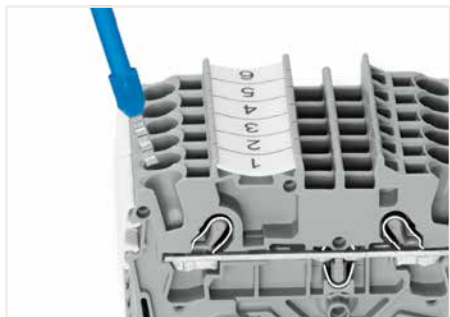

Fine-stranded conductors with ferrules from at least two sizes below the rated cross section up to the rated cross section can also be simply pushed in – without tools.

## Crimping Tool



Crimping tool 25; for insulated and uninsulated ferrules; crimping range: 10 mm<sup>2</sup> (8 AWG), 16 mm<sup>2</sup> (6 AWG) and 25 mm<sup>2</sup> (4 AWG)

	Item No.	Pack. Unit
	206-1225	1



Crimping tool 50; for insulated and uninsulated ferrules; crimping range: 35 mm<sup>2</sup> (2 AWG) and 50 mm<sup>2</sup> (1/0 AWG)

	Item No.	Pack. Unit
	206-1250	1



Insert the ferruled conductor into the crimping station.



Squeeze handles until ratchet mechanism is released.

### Application notes:

- Improved crimping for higher conductor retention
- Crimping can be performed from either side (for left- or right-handed users).
- Built-in ratchet mechanism ensures gas-tight crimp connection.
- Crimping tools open automatically after crimping operation is complete.
- Ergonomically designed handles.

### What is a "gas-tight" connection?

In a gas-tight connection, the conductor and the ferrule are compressed, eliminating all spaces. Under normal atmospheric conditions, neither a liquid nor gaseous medium can penetrate the crimped connection.

Oxidation between crimped single conductors is prevented, virtually eliminating the possibility of any increase in the crimped connection's resistance. In some exceptional cases, minute, isolated spaces may be present. However, these instances can be considered as closed off due to the twisted conductor.

Inadequate crimping can allow the conductor to be pulled out of the connection. Hollow spaces also remain, permitting oxidation formation and an increase in contact resistance.

Elevated resistance is detrimental for both signal transmission (signal flow is damped) and power transmission, resulting in power loss and contact heating (risk of fire). Crimping tools with built-in ratchets are recommended (e.g., WAGO Crimping Tools). These tools open automatically after the crimping operation is complete. Space-saving crimping from all four sides is ideal for spring clamp termination.

Ferruled conductor cross sections specified for WAGO products are based on this crimping method.



## Uninsulated Ferrule

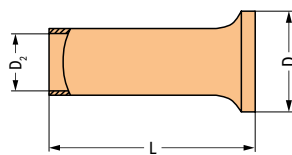

Ferrule; uninsulated; electro-tin-plated; electrolytic copper; gastight crimped; per DIN 46288 (Part 4/09.09)

Conductor Cross Section	Strip Length	L	D	D 2	Item No.	Pack. Unit
25 mm <sup>2</sup> / 4 AWG	25 mm / 0.98 inch	25	9,5	7,3	216-413	50
35 mm <sup>2</sup> / 2 AWG	25 mm / 0.98 inch	25	11	8,3	216-414	50
35 mm <sup>2</sup> / 2 AWG	30 mm / 1.18 inch	30	11	8,3	216-424	50
50 mm <sup>2</sup> / 1/0 AWG	30 mm / 1.18 inch	30	13	10,3	216-425	50
50 mm <sup>2</sup> / 1/0 AWG	35 mm / 1.38 inch	35	13	10,3	216-435	50

## Test and Measurement Devices

### 206 Series



Testboy; with integrated flashlight, non-contact voltage tester

Item No.	Pack. Unit
206-804	6 (1)



A device that will reliably detect AC voltage in cables, sockets, fuses, switches, outlets and other installations. Testboy can detect the following:

- Live conductors
- Cable breaks
- Blown fuses (in cartridges or holders)
- Defective switches
- Defective lamps in strings of lights

# Test and Measurement Devices

## 206 Series



Profi-LCD+; 2-pole voltage tester with LCD display; removable 4 mm Ø test probes	
Item No.	Pack. Unit
206-707	1



Profi-LED+; 2-pole voltage tester with LED display; removable 4 mm Ø test probes	
Item No.	Pack. Unit
206-706	1



Spare test probes; 4 mm Ø (2 pieces)	
Item No.	Pack. Unit
206-808	1



- Additional Profi-LCD+ features:
- Automatic measurement range selection
  - Single-pole phase testing AC > 100 V
  - Two-pole sequence testing (R and L)
  - Continuity testing
  - RDC/RCD testing (30 mA) via buttons
  - One-hand operation for SCHUKO® and CEE sockets
  - LED torch lamp function
  - Automatic backlight
  - Auto power-off function
  - CAT IV 1000 V
  - TÜV/GS tested and approved
  - IEC/EN 61243-3 (DIN VDE 0682-401)



- Additional Profi-LED+ features:
- Automatic measurement range selection
  - Single-pole phase testing AC > 100 V
  - Two-pole sequence testing (R and L)
  - Continuity testing
  - RDC/RCD testing (30 mA) via buttons
  - One-hand operation for SCHUKO® and CEE sockets
  - LED torch lamp function
  - CAT IV 1000 V
  - TÜV/GS tested and approved
  - IEC/EN 61243-3 (DIN VDE 0682-401)

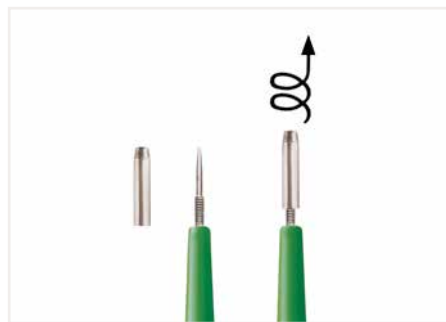

- Profi-LED+:
- Improved socket contact via 4 mm Ø test probes
  - Removable test probes for small test ports (suitable for all WAGO Terminal Blocks)



## Banana Plug (Only for Safety Extra-Low Voltage) 215 Series

### Technical Data

0.08 ... 2.5 mm<sup>2</sup> 28 ... 14 AWG

max. 42 V

Test current: 20 A

Measuring range category: CAT I

9 ... 11 mm / 0.35 ... 0.43 inch



Conductor termination: Press button fully, insert stripped conductor into square entry and release.



Testing via banana plug.  
Picture shows a test plug adapter (209-170).

Banana plug; for 4 mm socket diameter; color mixed; 10 x orange, white, black, blue, yellow

	Item No.	Pack. Unit
	215-111	50

### Banana plug; single

Banana plug; for 4 mm socket diameter

orange 215-211 50



Banana plug; for 4 mm socket diameter

red 215-212 50



Banana plug; for 4 mm socket diameter

black 215-311 50



Banana plug; for 4 mm socket diameter

green 215-411 50



Banana plug; for 4 mm socket diameter

yellow 215-511 50



Banana plug; for 4 mm socket diameter

white 215-611 50



Banana plug; for 4 mm socket diameter

blue 215-711 50



Banana plug; for 4 mm socket diameter

gray 215-811 50



Banana plug; for 4 mm socket diameter

green-yellow 215-911 50

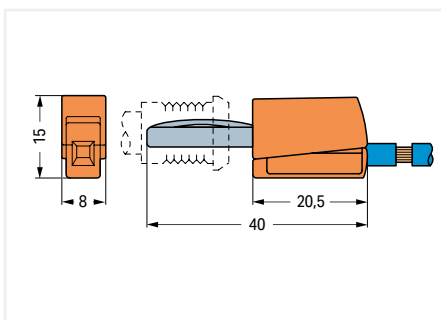

Dimensions in mm

# Test Plug 210 Series



Test plug; with 500 mm cable; 2 mm Ø; max. 42 V		
Color	Item No.	Pack. Unit
● red	210-136	50 (1)

Test plug; with 500 mm cable; 2.3 mm Ø; max. 42 V		
Color	Item No.	Pack. Unit
● yellow	210-137	50 (1)

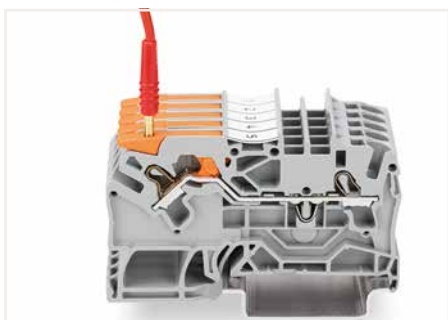

Testing with a 2 mm Ø test plug (max. 42 V).



Testing with a 2.3 mm Ø test plug (max. 42 V).



## Item Number Index

Item No.	Page	Item No.	Page	Item No.	Page	Item No.	Page
<b>206 Series</b>		<b>210 Series</b>		<b>282 Series</b>		<b>285 Series</b>	
206-118	261	210-722	260	282-436/301-000	112	285-950	236
				282-436/304-000	112	285-995	238
206-706	271			282-437	112		
206-707	271	<b>215 Series</b>		282-437/011-000	112	285-1161	241
		215-111	272	282-437/012-000	112	285-1163	241
206-804	270			282-438	112	285-1164	241
206-808	271	215-211	272	282-438/300-000	112	285-1165	241
		215-212	272	282-438/301-000	112	285-1167	241
206-1125	265			282-439	112	285-1167/999-950	241
206-1126	265	215-311	272	282-439/011-000	112	285-1169	240
206-1127	265			282-440	112	285-1171	240
206-1128	265	215-411	272			285-1175	240
206-1129	265			282-881	112	285-1176	240
206-1131	265	215-511	272	282-882	112	285-1177	240
206-1132	265			282-883	112	285-1178	240
		215-611	272	282-884	112	285-1179	241
206-1204	266			282-885	112	285-1181	240
206-1205	266	215-711	272	282-886	112	285-1184	240
206-1206	266			282-887	112	285-1185	240
206-1216	266	215-811	272	282-888	112	285-1187	240
206-1225	268					285-1187/999-950	240
206-1250	268	215-911	272			285-1189	240
				<b>283 Series</b>			
206-1400	262	<b>216 Series</b>		283-404	232	<b>709 Series</b>	
206-1403	262	216-208	267	283-407	232	709-118	251
206-1411	262	216-210	267			709-119	251
206-1412	262	216-241	267	<b>284 Series</b>		709-120	251
206-1413	262	216-242	267	284-415	238	709-153	257
206-1414	262	216-243	267			709-154	257
206-1415	262	216-244	267	<b>285 Series</b>		709-156	258
206-1418	262	216-246	267	285-131	232	709-167	257
206-1419	262	216-262	267	285-134	232	709-168	257
206-1441	263	216-263	267	285-135	232	709-169	258
206-1442	263	216-264	267	285-137	232	709-183	257
206-1451	263	216-266	267	285-137/999-950	232	709-193	251
206-1481	264	216-267	267	285-139	232		
206-1482	264	216-284	267	285-141	237	<b>734 Series</b>	
206-1491	264	216-286	267	285-143	237	734-326	155
206-1492	264	216-287	267	285-144	237	734-327	155
		216-288	267	285-147	237	734-328	155
		216-289	267	285-147/999-950	237	734-329	155
				285-148	237		
<b>209 Series</b>		216-413	269	285-150	236	734-430	194
209-105	212	216-414	269	285-151	236	734-431	194
209-109	254	216-424	269	285-154	236		
209-183	250	216-425	269	285-157	236		
209-184	250	216-435	269	285-157/999-950	236	<b>769 Series</b>	
209-190	34			285-159	236	769-410	232
209-191	34	<b>249 Series</b>		285-168	239		
209-192	55	249-105	250	285-169	238		
209-196	257	249-116	259	285-170	238	<b>777 Series</b>	
<b>210 Series</b>		249-117	259	285-172	260	777-303	212
210-103	135	249-118	251	285-173	260		
210-112	254	249-119	251	285-175	238		
210-113	254	249-120	251	285-181	239		
210-114	254	249-197	259	285-184	239	<b>793 Series</b>	
210-115	254			285-187	239	793-501	248
210-118	254	<b>258 Series</b>		285-188	239	793-501/000-002	248
210-123	135	258-5000	253	285-191	238	793-501/000-005	248
210-133	212	258-5030	253	285-194	238	793-501/000-006	248
210-136	273	<b>281 Series</b>		285-195	238	793-501/000-007	248
210-137	273	281-503	116	285-197	238	793-501/000-012	248
210-148	255			285-197/999-950	238	793-501/000-017	248
210-149	255	<b>282 Series</b>		285-199	238	793-501/000-023	248
210-196	254	282-415	236			793-501/000-024	248
210-197	254	282-432	112	285-407	238		
210-198	254	282-432/100-000	112	285-420	232	793-3501	248
		282-433	112	285-421	232		
210-254	112	282-435/011-000	112	285-427	232	793-4501	248
210-281	212	282-433/100-000	112	285-430	232	793-4501/000-002	248
		282-434	112	285-435	232	793-4501/000-005	248
210-504	255	282-434	112	285-440	236	793-4501/000-006	248
210-505	255	282-434/100-000	112	285-441	236	793-4501/000-007	248
210-506	255	282-435	112	285-442	232	793-4501/000-012	248
210-508	255	282-435/011-000	112	285-447	236	793-4501/000-017	248
210-509	255	282-435/300-000	112	285-448	237	793-4501/000-023	248
210-549	257	282-435/301-000	112	285-449	236	793-4501/000-024	248
		282-436	112	285-450	236		
210-719	260			285-495	238	793-5501	248
210-720	260					793-5501/000-002	248
210-721	260			285-935	232	793-5501/000-005	248

Item No.	Page	Item No.	Page	Item No.	Page	Item No.	Page
<b>793 Series</b>		<b>2000 Series</b>		<b>2000 Series</b>		<b>2001 Series</b>	
793-5501/000-006	248	2000-1204	34	2000-5310/1102-950	125	2001-1304	36
793-5501/000-007	248	2000-1205	34	2000-5311	122	2001-1305	36
793-5501/000-012	248	2000-1206	34	2000-5311/1101-951	122	2001-1306	36
793-5501/000-017	248	2000-1207	34	2000-5311/1102-950	122	2001-1307	36
793-5501/000-023	248	2000-1291	16	2000-5317/101-000	124	2001-1308	36
793-5501/000-024	248	2000-1292	16	2000-5317/102-000	124	2001-1311/1000-410	130
<b>794 Series</b>		2000-1301	34	2000-5317/1101-951	124	2001-1311/1000-411	130
794-5553/000-002	113	2000-1302	34	2000-5317/1102-950	124	2001-1321/1000-413	130
794-5554/000-006	113	2000-1303	34	2000-5352	122	2001-1321/1000-434	130
<b>821 Series</b>		2000-1304	34	2000-5352/1102-953	122	2001-1401	36
821-153	226	2000-1306	34	2000-5357/101-000	124	2001-1402	36
821-154	226	2000-1306	34	2000-5357/102-000	124	2001-1403	36
821-155	227	2000-1307	34	2000-5372	122	2001-1404	36
<b>859 Series</b>		2000-1307	34	2000-5372/1102-953	122	2001-1405	36
859-500	172	2000-1391	16	2000-5377/101-000	124	2001-1406	36
<b>2000</b>		2000-1392	16	2000-5377/102-000	124	2001-1407	36
2000-115	34	2000-1401	34	2000-5391	122	2001-1408	36
2000-121	250	2000-1402	34	2000-5410	125	2001-1411/1000-410	130
2000-402	16	2000-1403	34	2000-5410/1101-951	125	2001-1411/1000-411	130
2000-402/000-005	160	2000-1404	34	2000-5410/1102-950	125	2001-1421/1000-413	130
2000-402/000-006	160	2000-1405	34	2000-5417	123	2001-1421/1000-434	130
2000-402/000-018	160	2000-1406	34	2000-5417/1101-951	123	2001-1441	37
2000-403	16	2000-1407	34	2000-5417/1102-950	123	<b>2002 Series</b>	
2000-403/000-005	160	2000-1491	16	2000-5457	123	2002-115	8
2000-403/000-006	160	2000-1492	16	2000-5457/1102-953	123	2002-116	140
2000-404	16	2000-2141	35	2000-5477	123	2002-121	250
2000-404/000-005	160	2000-2195	35	2000-5477/1102-953	123	2002-131	250
2000-404/000-006	160	2000-2196	35	2000-5491	123	2002-160	249
2000-405	16	2000-2201	50	<b>2001 Series</b>		2002-161	249
2000-405/000-005	160	2000-2201/099-000	52	2001-115	36	2002-171	8
2000-405/000-006	160	2000-2202	50	2001-171	18	2002-172	8
2000-405/011-000	163	2000-2202/099-000	52	2001-402	18	2002-191	68
2000-406	16	2000-2203	50	2001-403	18	2002-192	68
2000-406/000-005	160	2000-2203/099-000	52	2001-404	18	2002-194	68
2000-406/000-006	160	2000-2204	50	2001-405	18	2002-400	161
2000-406/020-000	163	2000-2204/099-000	52	2001-405/011-000	163	2002-401	166
2000-407	16	2000-2207	50	2001-406	18	2002-402	8
2000-407/000-005	160	2000-2207/099-000	52	2001-406/020-000	163	2002-402/000-005	160
2000-407/000-006	160	2000-2208	50	2001-407	18	2002-402/000-006	160
2000-408	16	2000-2208/099-000	52	2001-407	18	2002-403	8
2000-408/000-005	160	2000-2209	50	2001-408	18	2002-403/000-005	160
2000-408/000-006	160	2000-2209/099-000	52	2001-409	18	2002-403/000-006	160
2000-409	16	2000-2217	50	2001-410	18	2002-404	8
2000-409/000-005	160	2000-2217/099-000	52	2001-433	18	2002-404/000-005	160
2000-409/000-006	160	2000-2218	51	2001-434	18	2002-404/000-006	160
2000-410	16	2000-2218/099-000	53	2001-435	18	2002-405	8
2000-410/000-005	160	2000-2227	50	2001-436	18	2002-405/000-005	160
2000-410/000-006	160	2000-2227/099-000	52	2001-437	18	2002-405/000-006	160
2000-433	16	2000-2228	51	2001-438	18	2002-405/011-000	163
2000-434	16	2000-2228/099-000	53	2001-439	18	2002-406	8
2000-435	16	2000-2231	50	2001-440	18	2002-406/000-005	160
2000-436	16	2000-2231/099-000	52	2001-511	154	2002-406/000-006	160
2000-437	16	2000-2232	50	2001-549	154	2002-406/020-000	163
2000-438	16	2000-2232/099-000	52	2001-552	154	2002-407	8
2000-439	16	2000-2233	50	2001-553	154	2002-407/000-005	160
2000-440	16	2000-2233/099-000	52	2001-554	154	2002-407/000-006	160
2000-492	165	2000-2234	50	2001-554	154	2002-408	8
2000-510	154	2000-2234/099-000	52	2001-555	154	2002-408/000-005	160
2000-511	154	2000-2237	50	2001-556	154	2002-408/000-006	160
2000-549	154	2000-2237/099-000	52	2001-557	154	2002-409	8
2000-552	154	2000-2238	50	2001-557	154	2002-409/000-005	160
2000-553	154	2000-2238/099-000	52	2001-558	154	2002-409/000-006	160
2000-554	154	2000-2239	50	2001-559	154	2002-410	8
2000-555	154	2000-2239/099-000	52	2001-560	154	2002-410/000-005	160
2000-556	154	2000-2247	50	2001-1201	36	2002-410/000-006	160
2000-557	154	2000-2247/099-000	52	2001-1202	36	2002-415	161
2000-558	154	2000-2248	51	2001-1203	36	2002-423	161
2000-559	154	2000-2248/099-000	53	2001-1204	36	2002-423/000-005	161
2000-560	154	2000-2257	50	2001-1205	36	2002-423/000-006	161
2000-1201	34	2000-2257/099-000	52	2001-1206	36	2002-433	8
2000-1202	34	2000-2258	51	2001-1207	36	2002-434	8
2000-1203	34	2000-2258/099-000	53	2001-1208	36	2002-435	8
		2000-2291	51	2001-1211/1000-410	130	2002-436	8
		2000-2292	51	2001-1211/1000-411	130	2002-437	8
		2000-5310/101-000	125	2001-1301	36	2002-438	8
		2000-5310/102-000	125	2001-1302	36	2002-439	8
		2000-5310/1101-951	125	2001-1303	36	2002-440	8

## Item Number Index

Item No.	Page	Item No.	Page	Item No.	Page	Item No.	Page
<b>2002 Series</b>		<b>2002 Series</b>		<b>2002 Series</b>		<b>2002 Series</b>	
2002-472	162	2002-1311/1000-411	132	2002-1891	80	2002-2257	54
2002-473	162	2002-1321/1000-413	132	2002-1892	80	2002-2257/099-000	56
2002-473/011-000	162	2002-1321/1000-434	132			2002-2258	55
2002-474	162	2002-1391	18	2002-1901	95	2002-2258/099-000	57
2002-475	162	2002-1392	18	2002-1902	95	2002-2291	55
2002-475/011-000	162	2002-1393	18	2002-1904	95	2002-2292	55
2002-476	162	2002-1394	18	2002-1907	95	2002-2295	55
2002-477	162			2002-1911	98	2002-2296	55
2002-477/011-000	162	2002-1401	38	2002-1911/1000-541	98		
2002-478	162	2002-1402	38	2002-1911/1000-542	98	2002-2401	60
2002-479	162	2002-1403	38	2002-1911/1000-836	98	2002-2402	60
2002-479/011-000	162	2002-1404	38	2002-1911/1000-867	98	2002-2403	60
2002-480	162	2002-1405	38	2002-1961	95	2002-2404	60
2002-481	162	2002-1406	38	2002-1971	94	2002-2407	60
2002-481/011-000	162	2002-1407	38	2002-1971/401-000	94	2002-2408	60
2002-482	162	2002-1408	38	2002-1972	94	2002-2409	60
2002-492	165	2002-1411/1000-410	132	2002-1972/401-000	94	2002-2417	60
2002-492/000-012	165	2002-1411/1000-411	132	2002-1974	94	2002-2418	61
2002-493	165	2002-1421/1000-413	132	2002-1974/401-000	94	2002-2427	60
		2002-1421/1000-434	132	2002-1981	97	2002-2428	61
2002-511	154	2002-1441	39	2002-1981/1000-413	96	2002-2431	60
2002-541	155	2002-1491	18	2002-1981/1000-414	96	2002-2432	60
2002-549	154	2002-1492	18	2002-1981/1000-429	96	2002-2433	60
2002-552	154	2002-1493	18	2002-1981/1000-434	96	2002-2434	60
2002-553	154	2002-1494	18	2002-1981/1000-435	96	2002-2437	60
2002-554	154			2002-1981/1000-449	96	2002-2438	60
2002-555	154	2002-1601	89	2002-1991	82	2002-2439	60
2002-556	154	2002-1602	89	2002-1992	82	2002-2447	60
2002-557	154	2002-1604	89			2002-2448	61
2002-558	154	2002-1611	98	2002-2201	54	2002-2457	60
2002-559	154	2002-1611/1000-541	98	2002-2201/097-000	58	2002-2458	61
2002-560	154	2002-1611/1000-542	98	2002-2201/098-000	58	2002-2491	61
		2002-1611/1000-836	98	2002-2201/099-000	56	2002-2492	61
2002-611	158	2002-1611/1000-867	98	2002-2202	54		
2002-641	158	2002-1661	89	2002-2202/099-000	56	2002-2601	62
2002-649	158	2002-1671	88	2002-2203	54	2002-2602	62
		2002-1671/401-000	88	2002-2203/099-000	56	2002-2603	62
2002-800	140	2002-1672	88	2002-2204	54	2002-2604	62
2002-800/1000-410	136	2002-1672/401-000	88	2002-2204/099-000	56	2002-2607	62
2002-800/1000-411	136	2002-1674	88	2002-2207	54	2002-2608	62
2002-800/1000-541	138	2002-1674/401-000	88	2002-2207/099-000	56	2002-2609	62
2002-800/1000-542	138	2002-1681	88	2002-2208	54	2002-2611	65
2002-800/1000-836	138	2002-1691	76	2002-2208/099-000	56	2002-2611/1000-541	65
2002-810	140	2002-1692	76	2002-2209	54	2002-2611/1000-542	65
2002-820	140			2002-2209/099-000	56	2002-2611/1000-836	65
2002-880	137	2002-1701	91	2002-2211/1000-410	148	2002-2611/1000-867	65
2002-880/1000-411	137	2002-1702	91	2002-2211/1000-411	148	2002-2612	65
2002-880/1000-541	139	2002-1704	91	2002-2213/1000-487	148	2002-2647	62
2002-880/1000-542	139	2002-1707	91	2002-2213/1000-488	148	2002-2657	62
2002-880/1000-836	139	2002-1711	98	2002-2214/1000-489	148	2002-2661	64
		2002-1711/1000-541	98	2002-2214/1000-490	148	2002-2662	64
2002-991	86	2002-1711/1000-542	98	2002-2214/1000-491	148	2002-2667	64
2002-992	86	2002-1711/1000-836	98	2002-2214/1000-492	148	2002-2671	64
		2002-1711/1000-867	98	2002-2217	54	2002-2672	64
2002-1091	65	2002-1761	91	2002-2217/099-000	56	2002-2678	64
2002-1092	65	2002-1771	90	2002-2218	55	2002-2691	63
		2002-1771/401-000	90	2002-2218/099-000	57	2002-2692	63
2002-1201	38	2002-1772	90	2002-2221/1000-413	148		
2002-1202	38	2002-1772/401-000	90	2002-2221/1000-434	148	2002-2701	59
2002-1203	38	2002-1774	90	2002-2227	54	2002-2702	59
2002-1204	38	2002-1774/401-000	90	2002-2227/099-000	56	2002-2703	59
2002-1205	38	2002-1781	90	2002-2228	55	2002-2704	59
2002-1206	38	2002-1791	78	2002-2228/099-000	57	2002-2707	59
2002-1207	38	2002-1792	78	2002-2231	54	2002-2707/999-950	59
2002-1208	38			2002-2231/099-000	56	2002-2708	59
2002-1211/1000-410	132	2002-1801	93	2002-2232	54	2002-2709	59
2002-1211/1000-411	132	2002-1802	93	2002-2232/099-000	56	2002-2717	59
2002-1291	18	2002-1804	93	2002-2233	54	2002-2727	59
2002-1292	18	2002-1811	99	2002-2233/099-000	56	2002-2791	48
2002-1293	18	2002-1811/1000-541	99	2002-2234	54	2002-2792	48
2002-1294	18	2002-1811/1000-542	99	2002-2234/099-000	56		
		2002-1811/1000-836	99	2002-2237	54	2002-2941	146
2002-1301	38	2002-1811/1000-867	99	2002-2237/099-000	56	2002-2951	144
2002-1302	38	2002-1861	93	2002-2238	54	2002-2952	144
2002-1303	38	2002-1871	92	2002-2238/099-000	56	2002-2954	144
2002-1304	38	2002-1871/401-000	92	2002-2239	54	2002-2958	144
2002-1305	38	2002-1872	92	2002-2239/099-000	56	2002-2959	144
2002-1306	38	2002-1872/401-000	92	2002-2247	54	2002-2961	116
2002-1307	38	2002-1874	92	2002-2247/099-000	56	2002-2963	116
2002-1308	38	2002-1874/401-000	92	2002-2248	55	2002-2971	144
2002-1311/1000-410	132	2002-1881	92	2002-2248/099-000	57	2002-2972	144

Item No.	Page	Item No.	Page	Item No.	Page	Item No.	Page
<b>2002 Series</b>		<b>2003 Series</b>		<b>2004 Series</b>		<b>2006 Series</b>	
2002-2974	144	2003-6642	214	2004-1301	42	2006-1201	44
2002-2991	116	2003-6643	216	2004-1302	42	2006-1202	44
2002-2992	116	2003-6644	214	2004-1303	42	2006-1204	44
		2003-6645	214	2004-1304	42	2006-1207	44
2002-3201	66	2003-6646	214	2004-1305	42	2006-1208	44
2002-3203	66	2003-6649	214	2004-1306	42	2006-1291	24
2002-3204	66	2003-6650	214	2004-1307	42	2006-1292	24
2002-3207	66	2003-6651	214	2004-1311/1000-400	134	2006-1293	24
2002-3208	66	2003-6660	216	2004-1311/1000-401	134	2006-1294	24
2002-3209	66	2003-6661	216	2004-1391	22		
2002-3211/1000-410	150	2003-6692	214	2004-1392	22	2006-1301	44
2002-3211/1000-411	150	2003-6693	216	2004-1393	22	2006-1302	44
2002-3211/1000-675	150	2003-6693	216	2004-1394	22	2006-1304	44
2002-3211/1000-676	150	2003-6694	216			2006-1305	44
2002-3212/1000-673	150			2004-1401	42	2006-1307	44
2002-3212/1000-674	150	2003-7300	212	2004-1402	42	2006-1391	24
2002-3217	66			2004-1403	42	2006-1392	24
2002-3218	67	2003-7640	212	2004-1404	42	2006-1393	24
2002-3221/1000-413	150	2003-7641	212	2004-1405	42	2006-1394	24
2002-3221/1000-434	150	2003-7642	212	2004-1406	42		
2002-3227	66	2003-7645	212	2004-1407	42	2006-1601	101
2002-3228	67	2003-7646	212	2004-1408	42	2006-1604	101
2002-3231	66	2003-7649	212	2004-1411/1000-400	134	2006-1611	104
2002-3233	66	2003-7650	212	2004-1411/1000-401	134	2006-1611/1000-541	104
2002-3234	66	2003-7651	212	2004-1491	22	2006-1611/1000-542	104
2002-3237	66	2003-7659	212	2004-1492	22	2006-1611/1000-836	104
2002-3238	66	2003-7692	212	2004-1493	22	2006-1611/1000-867	104
2002-3239	66			2004-1494	22	2006-1621	104
2002-3247	66					2006-1621/1000-541	104
2002-3248	67	<b>2004 Series</b>		<b>2005 Series</b>		2006-1621/1000-542	104
2002-3257	66	2004-115	42	2005-7300	220	2006-1621/1000-836	104
2002-3258	67	2004-171	22	2005-7641	220	2006-1621/1000-859	104
2002-3291	67	2004-172	22	2005-7642	220	2006-1631	104
2002-3292	67			2005-7645	220	2006-1631/099-000	105
		2004-402	22	2005-7646	220	2006-1631/1000-541	104
2002-4101	68	2004-403	22	2005-7646	220	2006-1631/1000-542	104
2002-4111	68	2004-404	22	2005-7649	220	2006-1631/1000-836	104
2002-4127	68	2004-405	22	2005-7692	220	2006-1631/1000-859	104
2002-4131	68	2004-405/011-000	163			2006-1631/1000-867	104
2002-4141	68	2004-406	22	<b>2006 Series</b>		2006-1631/1099-541	105
2002-4157	68	2004-406/020-000	163	2006-115	9	2006-1631/1099-542	105
2002-4191	68	2004-407	22	2006-191	167	2006-1631/1099-836	105
2002-4192	68	2004-408	22			2006-1631/1099-859	105
		2004-409	22	2006-401	166	2006-1631/1099-867	105
2002-6301	40	2004-410	22	2006-401/000-050	166	2006-1661	100
2002-6302	40	2004-433	22	2006-402	9	2006-1664	100
2002-6303	40	2004-434	22	2006-403	9	2006-1671	100
2002-6304	40	2004-435	22	2006-404	9	2006-1671/1000-848	100
2002-6305	40	2004-436	22	2006-405	9	2006-1671/1000-849	100
2002-6306	40	2004-437	22	2006-405/011-000	163	2006-1671/1000-850	100
2002-6307	40	2004-438	22	2006-433	9	2006-1671/1000-851	100
2002-6308	40	2004-439	22	2006-434	9	2006-1674	100
2002-6391	40	2004-440	22	2006-435	9	2006-1681	103
2002-6392	40			2006-451	166	2006-1681/1000-413	102
		2004-511	156	2006-499	18	2006-1681/1000-414	102
2002-6401	41	2004-541	156			2006-1681/1000-429	102
2002-6402	41	2004-549	156	2006-511	156	2006-1681/1000-434	102
2002-6403	41	2004-552	156	2006-549	156	2006-1681/1000-435	102
2002-6404	41	2004-553	156			2006-1681/1000-449	102
2002-6405	41	2004-554	156	2006-911	118	2006-1691	100
2002-6406	41	2004-555	156	2006-911/1000-541	118	2006-1692	100
2002-6407	41			2006-911/1000-542	118	2006-1695	118
		2004-911	116	2006-911/1000-836	118	2006-1696	118
2002-7111	222	2004-911/1000-541	116	2006-921	118		
2002-7114	222	2004-911/1000-542	116	2006-921/1000-541	118	2006-7111	222
2002-7192	222	2004-911/1000-836	116	2006-921/1000-542	118	2006-7114	222
		2004-911/1000-867	116	2006-921/1000-836	118	2006-7192	222
2002-7211	222			2006-921/1000-859	118		
2002-7214	222	2004-1201	42	2006-931	118	2006-7300	222
2002-7292	222	2004-1202	42	2006-931/099-000	118		
		2004-1203	42	2006-931/1000-541	118	2006-8401	106
<b>2003 Series</b>		2004-1204	42	2006-931/1000-836	118		
2003-499	214	2004-1205	42	2006-931/1000-859	118	2006-8601	106
		2004-1206	42	2006-931/1000-867	118	2006-8604	106
2003-500	214	2004-1207	42	2006-931/1099-541	119	2006-8661	106
		2004-1211/1000-400	134	2006-931/1099-542	119	2006-8664	106
2003-911	218	2004-1211/1000-401	134	2006-931/1099-836	119	2006-8671	106
2003-911/1000-923	218	2004-1291	22	2006-931/1099-859	119	2006-8674	106
		2004-1292	22	2006-991	104	2006-8691	106
2003-6640	216	2004-1293	22	2006-992	104	2006-8692	106
2003-6641	214	2004-1294	22				

## Item Number Index

Item No.	Page	Item No.	Page	Item No.	Page	Item No.	Page
<b>2007 Series</b>		<b>2010 Series</b>		<b>2020 Series</b>		<b>2020 Series</b>	
2007-8442	112	2010-1391	25	2020-105/000-037	180	2020-115/000-038	180
2007-8443	112	2010-1392	25	2020-105/000-038	180	2020-115/000-039	180
2007-8444	112			2020-105/000-039	180	2020-115/125-000	184
2007-8445	112	2010-7111	222	2020-105/124-000	184	2020-115/135-000	184
2007-8446	112	2010-7114	222	2020-105/133-000	184	2020-115/145-000	184
2007-8447	112	2010-7192	222	2020-105/143-000	184	2020-161	178
2007-8448	112			2020-106	176	2020-164	178
		<b>2016 Series</b>		2020-106/000-036	180	2020-167	178
2007-8801	112	2016-100	11	2020-106/000-037	180	2020-181	178
2007-8804	112	2016-115	11	2020-106/000-038	180	2020-184	178
2007-8807	113			2020-106/000-039	180	2020-187	178
2007-8811	112	2016-402	11	2020-106/124-000	184		
2007-8821	112	2016-403	11	2020-106/133-000	184	2020-202	176
2007-8873	114	2016-404	11	2020-106/143-000	184	2020-202/122-000	186
2007-8876	115	2016-405	11	2020-107	176	2020-202/132-000	186
2007-8891	112	2016-405/011-000	163	2020-107/000-036	180	2020-202/142-000	186
2007-8892	112	2016-433	11	2020-107/000-037	180	2020-203	176
2007-8893	112	2016-434	11	2020-107/000-038	180	2020-203/000-036	182
2007-8894	112	2016-435	11	2020-107/000-039	180	2020-203/000-037	182
2007-8899	112	2016-499	25	2020-107/124-000	184	2020-203/000-038	182
				2020-107/134-000	184	2020-203/000-039	182
<b>2009 Series</b>		2016-511	157	2020-107/144-000	184	2020-203/122-000	186
2009-110	248	2016-549	157	2020-108	176	2020-203/132-000	186
2009-113	248			2020-108/000-036	180	2020-203/142-000	186
2009-114	248	2016-1201	46	2020-108/000-037	180	2020-204	176
2009-115	248	2016-1202	46	2020-108/000-038	180	2020-204/000-036	182
2009-163	251	2016-1203	46	2020-108/000-039	180	2020-204/000-037	182
2009-174	159	2016-1204	46	2020-108/124-000	184	2020-204/000-038	182
2009-180	163	2016-1207	46	2020-108/134-000	184	2020-204/000-039	182
2009-182	159	2016-1208	46	2020-108/144-000	184	2020-204/124-000	186
2009-191	249	2016-1291	26	2020-109	176	2020-204/133-000	186
2009-192	249	2016-1292	26	2020-109/000-036	180	2020-204/143-000	186
2009-193	249			2020-109/000-037	180	2020-205	176
2009-196	249	2016-1301	46	2020-109/000-038	180	2020-205/000-036	182
2009-198	249	2016-1302	46	2020-109/000-039	180	2020-205/000-037	182
		2016-1303	46	2020-109/124-000	184	2020-205/000-038	182
2009-304	212	2016-1304	46	2020-109/134-000	184	2020-205/000-039	182
2009-305	212	2016-1305	46	2020-109/144-000	184	2020-205/124-000	186
2009-309	260	2016-1306	46	2020-110	176	2020-205/133-000	186
2009-310	260	2016-1307	46	2020-110/000-036	180	2020-205/143-000	186
		2016-1391	26	2020-110/000-037	180	2020-206	176
2009-402	164	2016-1392	26	2020-110/000-038	180	2020-206/000-036	182
2009-404	164			2020-110/000-039	180	2020-206/000-037	182
2009-406	164	2016-7111	223	2020-110/125-000	184	2020-206/000-038	182
2009-412	164	2016-7114	223	2020-110/135-000	184	2020-206/000-039	182
2009-414	164	2016-7192	223	2020-110/145-000	184	2020-206/124-000	186
2009-414/000-005	164			2020-111	176	2020-206/133-000	186
2009-414/000-006	164	2016-7601	224	2020-111/000-036	180	2020-206/143-000	186
2009-416	164	2016-7604	224	2020-111/000-037	180	2020-207	176
		2016-7607	224	2020-111/000-038	180	2020-207/000-036	182
<b>2010 Series</b>		2016-7691	224	2020-111/000-039	180	2020-207/000-037	182
2010-100	10	2016-7692	224	2020-111/125-000	184	2020-207/000-038	182
2010-115	10			2020-111/135-000	184	2020-207/000-039	182
		2016-7711	224	2020-111/145-000	184	2020-207/124-000	186
2010-402	10	2016-7714	224	2020-112	176	2020-207/134-000	186
2010-403	10	2016-7792	224	2020-112/000-036	180	2020-207/144-000	186
2010-404	10			2020-112/000-037	180	2020-208	176
2010-405	10	<b>2020 Series</b>		2020-112/000-038	180	2020-208/000-036	182
2010-405/011-000	163	2020-100	127	2020-112/000-039	180	2020-208/000-037	182
2010-433	10	2020-102	176	2020-112/125-000	184	2020-208/000-038	182
2010-434	10	2020-102/122-000	184	2020-112/135-000	184	2020-208/000-039	182
2010-435	10	2020-102/132-000	184	2020-112/145-000	184	2020-208/124-000	186
		2020-102/142-000	184	2020-113	176	2020-208/134-000	186
2010-511	156	2020-103	176	2020-113/000-036	180	2020-208/144-000	186
2010-549	156	2020-103/000-036	180	2020-113/000-037	180	2020-209	176
		2020-103/000-037	180	2020-113/000-038	180	2020-209/000-036	182
2010-1201	45	2020-103/000-038	180	2020-113/000-039	180	2020-209/000-037	182
2010-1202	45	2020-103/000-039	180	2020-113/125-000	184	2020-209/000-038	182
2010-1204	45	2020-103/122-000	184	2020-113/135-000	184	2020-209/000-039	182
2010-1205	45	2020-103/132-000	184	2020-113/145-000	184	2020-209/124-000	186
2010-1207	45	2020-103/142-000	184	2020-114	176	2020-209/134-000	186
2010-1208	45	2020-104	176	2020-114/000-036	180	2020-209/144-000	186
2010-1291	25	2020-104/000-036	180	2020-114/000-037	180	2020-210	176
2010-1292	25	2020-104/000-037	180	2020-114/000-038	180	2020-210/000-036	182
		2020-104/000-038	180	2020-114/000-039	180	2020-210/000-037	182
2010-1301	45	2020-104/000-039	180	2020-114/125-000	184	2020-210/000-038	182
2010-1302	45	2020-104/124-000	184	2020-114/135-000	184	2020-210/000-039	182
2010-1304	45	2020-104/133-000	184	2020-114/145-000	184	2020-210/125-000	186
2010-1305	45	2020-104/143-000	184	2020-115	176	2020-210/135-000	186
2010-1307	45	2020-105	176	2020-115/000-036	180	2020-210/145-000	186
		2020-105/000-036	180	2020-115/000-037	180	2020-211	176



Item No.	Page	Item No.	Page	Item No.	Page	Item No.	Page
<b>2020 Series</b>		<b>2020 Series</b>		<b>2022 Series</b>		<b>2022 Series</b>	
2020-211/000-036	182	2020-2257	174	2022-106/999-953	206	2022-164	196
2020-211/000-037	182	2020-2291	175	2022-107	194	2022-167	196
2020-211/000-038	182	2020-2292	175	2022-107/000-036	198	2022-171	196
2020-211/000-039	182			2022-107/000-037	198	2022-172	196
2020-211/125-000	186	2020-5311	127	2022-107/000-038	198	2022-174	196
2020-211/135-000	186	2020-5311/1102-950	127	2022-107/000-039	198	2022-177	196
2020-211/145-000	186	2020-5317/102-000	129	2022-107/123-000	200	2022-181	196
2020-212	176	2020-5317/1102-950	129	2022-107/135-000	200	2022-182	196
2020-212/000-036	182	2020-5372	127	2022-107/145-000	200	2022-184	196
2020-212/000-037	182	2020-5372/1102-953	127	2022-107/999-953	206	2022-187	196
2020-212/000-038	182	2020-5377/102-000	129	2022-108	194		
2020-212/000-039	182	2020-5391	127	2022-108/000-036	198	2022-1201	188
2020-212/125-000	186			2022-108/000-037	198	2022-1201/999-953	202
2020-212/135-000	186	2020-5417	128	2022-108/000-038	198	2022-1202	188
2020-212/145-000	186	2020-5417/1102-950	128	2022-108/000-039	198	2022-1204	188
2020-213	176	2020-5477	128	2022-108/123-000	200	2022-1204/999-953	202
2020-213/000-036	182	2020-5477/1102-953	128	2022-108/135-000	200	2022-1207	188
2020-213/000-037	182	2020-5491	128	2022-108/145-000	200	2022-1207/999-953	202
2020-213/000-038	182			2022-108/999-953	206	2022-1291	188
2020-213/000-039	182	<b>2022 Series</b>		2022-109	194	2022-1292	188
2020-213/125-000	186	2022-100	188	2022-109/000-036	198		
2020-213/135-000	186	2022-101	194	2022-109/000-037	198	2022-1301	188
2020-213/145-000	186	2022-101/000-016	194	2022-109/000-038	198	2022-1301/999-953	202
2020-214	176	2022-101/122-000	200	2022-109/000-039	198	2022-1302	188
2020-214/000-036	182	2022-101/122-006	200	2022-109/123-000	200	2022-1304	188
2020-214/000-037	182	2022-101/122-016	200	2022-109/135-000	200	2022-1304/999-953	202
2020-214/000-038	182	2022-101/132-000	200	2022-109/145-000	200	2022-1307	188
2020-214/000-039	182	2022-101/132-006	200	2022-110	194	2022-1307/999-953	202
2020-214/125-000	186	2022-101/132-016	200	2022-110/000-036	198	2022-1391	188
2020-214/135-000	186	2022-101/142-000	200	2022-110/000-037	198	2022-1392	188
2020-214/145-000	186	2022-101/142-006	200	2022-110/000-038	198		
2020-215	176	2022-101/142-016	200	2022-110/000-039	198	2022-1401	188
2020-215/000-036	182	2022-102	194	2022-110/123-000	200	2022-1401/999-953	202
2020-215/000-037	182	2022-102/000-016	194	2022-110/135-000	200	2022-1402	188
2020-215/000-038	182	2022-102/122-000	200	2022-110/145-000	200	2022-1404	188
2020-215/000-039	182	2022-102/132-000	200	2022-111	194	2022-1404/999-953	202
2020-215/125-000	186	2022-102/142-000	200	2022-111/000-036	198	2022-1407	188
2020-215/135-000	186	2022-102/999-953	206	2022-111/000-037	198	2022-1407/999-953	202
2020-215/145-000	186	2022-103	194	2022-111/000-038	198	2022-1491	188
2020-261	178	2022-103/000-036	198	2022-111/000-039	198	2022-1492	188
2020-264	178	2022-103/000-037	198	2022-111/126-000	200		
2020-267	178	2022-103/000-038	198	2022-111/136-000	200	2022-1601	190
2020-281	178	2022-103/000-038/999-953	207	2022-111/146-000	200	2022-1602	190
2020-284	178	2022-103/000-039	198	2022-112	194	2022-1604	190
2020-287	178	2022-103/000-039/999-953	207	2022-112/000-036	198	2022-1607	190
		2022-103/123-000	200	2022-112/000-037	198	2022-1691	190
2020-1201	172	2022-103/133-000	200	2022-112/000-038	198	2022-1692	190
2020-1204	172	2022-103/143-000	200	2022-112/000-039	198		
2020-1207	172	2022-103/999-953	206	2022-112/126-000	200	2022-1801	190
2020-1291	172	2022-104	194	2022-112/136-000	200	2022-1802	190
2020-1292	172	2022-104/000-036	198	2022-112/146-000	200	2022-1804	190
		2022-104/000-037	198	2022-113	194	2022-1807	190
2020-1301	172	2022-104/000-038	198	2022-113/000-036	198	2022-1891	190
2020-1304	172	2022-104/000-038/999-953	207	2022-113/000-037	198	2022-1892	190
2020-1307	172	2022-104/000-039	198	2022-113/000-038	198		
2020-1391	172	2022-104/000-039/999-953	207	2022-113/000-039	198	2022-2201	192
2020-1392	172	2022-104/123-000	200	2022-113/126-000	200	2022-2201/999-953	204
		2022-104/133-000	200	2022-113/136-000	200	2022-2202	192
2020-1401	172	2022-104/143-000	200	2022-113/146-000	200	2022-2202/999-953	204
2020-1404	172	2022-104/999-953	206	2022-114	194	2022-2203	192
2020-1407	172	2022-105	194	2022-114/000-036	198	2022-2203/999-953	204
2020-1491	172	2022-105/000-036	198	2022-114/000-037	198	2022-2204	192
2020-1492	172	2022-105/000-037	198	2022-114/000-038	198	2022-2204/999-953	204
		2022-105/000-038	198	2022-114/000-039	198	2022-2207	192
2020-2201	174	2022-105/000-038/999-953	207	2022-114/126-000	200	2022-2207/999-953	204
2020-2202	174	2022-105/000-039	198	2022-114/136-000	200	2022-2208	192
2020-2203	174	2022-105/000-039/999-953	207	2022-114/146-000	200	2022-2208/999-953	204
2020-2204	174	2022-105/123-000	200	2022-115	194	2022-2209	192
2020-2207	174	2022-105/134-000	200	2022-115/000-036	198	2022-2209/999-953	204
2020-2208	174	2022-105/144-000	200	2022-115/000-037	198	2022-2217	192
2020-2209	174	2022-105/999-953	206	2022-115/000-038	198	2022-2217/999-953	204
2020-2217	174	2022-106	194	2022-115/000-039	198	2022-2227	192
2020-2227	174	2022-106/000-036	198	2022-115/127-000	200	2022-2227/999-953	204
2020-2231	174	2022-106/000-037	198	2022-115/137-000	200	2022-2231	192
2020-2232	174	2022-106/000-038	198	2022-115/147-000	200	2022-2231/999-953	204
2020-2233	174	2022-106/000-038/999-953	207	2022-141	176	2022-2232	192
2020-2234	174	2022-106/000-039	198	2022-142	176	2022-2232/999-953	204
2020-2237	174	2022-106/000-039/999-953	207	2022-151	176	2022-2233	192
2020-2238	174	2022-106/123-000	200	2022-152	176	2022-2233/999-953	204
2020-2239	174	2022-106/134-000	200	2022-161	196	2022-2234	192
2020-2247	174	2022-106/144-000	200	2022-162	196	2022-2234/999-953	204

## Item Number Index

Item No.	Page	Item No.	Page	Item No.	Page	Item No.	Page
<b>2022 Series</b>		<b>2110 Series</b>		<b>2202 Series</b>		<b>2206 Series</b>	
2022-2237	192	2110-5304	14	2202-1671	76	2206-1204	24
2022-2237/999-953	204	2110-5307	14	2202-1672	76	2206-1207	24
2022-2238	192	<b>2116 Series</b>		2202-1674	76		
2022-2238/999-953	204	2116-1201	11	2202-1681	76	2206-1301	24
2022-2239	192	2116-1201/605-038	11	2202-1701	79	2206-1304	24
2022-2239/999-953	204	2116-1204	11	2202-1702	79	2206-1307	24
2022-2247	192	2116-1207	11	2202-1704	79	<b>2210 Series</b>	
2022-2247/999-953	204	2116-1291	11	2202-1707	79	2210-1201	25
2022-2257	192	2116-1292	11	2202-1711	86	2210-1204	25
2022-2257/999-953	204			2202-1711/1000-541	86	2210-1207	25
2022-2291	193	2116-1301	11	2202-1711/1000-542	86		
2022-2292	193	2116-1304	11	2202-1711/1000-836	86	2210-1301	25
<b>2042 Series</b>		2116-1307	11	2202-1711/1000-867	86	2210-1304	25
2042-321	142	2116-1391	11	2202-1761	78	2210-1307	25
2042-331	142	2116-1392	11	2202-1771	78		
2042-341	142			2202-1772	78	<b>2216 Series</b>	
2042-351	142	2116-5201	15	2202-1774	78	2216-1201	26
<b>2102 Series</b>		2116-5204	15	2202-1781	78	2216-1204	26
2102-1201	8	2116-5207	15			2216-1207	26
2102-1204	8			2202-1801	81		
2102-1207	8	2116-5301	15	2202-1802	81	2216-1301	26
2102-1291	8	2116-5304	15	2202-1804	81	2216-1304	26
2102-1292	8	2116-5307	15	2202-1811	87	2216-1307	26
		<b>2200 Series</b>		2202-1811/1000-541	87		
2102-1301	8	2200-1201	16	2202-1811/1000-542	87		
2102-1304	8	2200-1204	16	2202-1811/1000-836	87		
2102-1307	8	2200-1207	16	2202-1861	80		
2102-1391	8			2202-1871	80		
2102-1392	8	2200-1301	16	2202-1872	80		
		2200-1304	16	2202-1874	80		
2102-5201	12	2200-1307	16	2202-1881	80		
2102-5204	12						
2102-5207	12	2200-1401	16	2202-1901	83		
		2200-1404	16	2202-1902	83		
2102-5301	12	2200-1407	16	2202-1904	83		
2102-5304	12	<b>2201 Series</b>		2202-1907	83		
2102-5307	12	2201-1201	18	2202-1911	86		
<b>2106 Series</b>		2201-1202	18	2202-1911/1000-541	86		
2106-1201	9	2201-1204	18	2202-1911/1000-542	86		
2106-1204	9	2201-1207	18	2202-1911/1000-836	86		
2106-1207	9			2202-1911/1000-867	86		
2106-1291	9	2201-1301	18	2202-1961	82		
2106-1292	9	2201-1302	18	2202-1971	82		
		2201-1302	18	2202-1972	82		
2106-1301	9	2201-1304	18	2202-1974	82		
2106-1304	9	2201-1307	18	2202-1981	85		
2106-1307	9			2202-1981/1000-413	84		
2106-1391	9	2201-1401	18	2202-1981/1000-414	84		
2106-1392	9	2201-1402	18	2202-1981/1000-429	84		
		2201-1402	18	2202-1981/1000-434	84		
2106-5201	13	2201-1404	18	2202-1981/1000-435	84		
2106-5204	13	2201-1407	18	2202-1981/1000-449	84		
2106-5207	13	<b>2202 Series</b>		2202-2701	48		
		2202-1201	20	2202-2702	48		
2106-5301	13	2202-1203	20	2202-2703	48		
2106-5304	13	2202-1204	20	2202-2704	48		
2106-5307	13	2202-1205	20	2202-2707	48		
		2202-1207	20	2202-2708	48		
				2202-2709	48		
<b>2110 Series</b>		2202-1301	20	2202-2717	48		
2110-1201	10	2202-1304	20	2202-2727	48		
2110-1204	10	2202-1307	20	<b>2204 Series</b>			
2110-1207	10			2204-1201	22		
2110-1291	10	2202-1401	20	2204-1204	22		
2110-1292	10	2202-1403	20	2204-1207	22		
		2202-1404	20				
2110-1301	10	2202-1405	20	2204-1301	22		
2110-1304	10	2202-1407	20	2204-1304	22		
2110-1307	10			2204-1307	22		
2110-1391	10	2202-1601	77				
2110-1392	10	2202-1602	77	2204-1401	22		
		2202-1604	77	2204-1404	22		
2110-5201	14	2202-1611	86	2204-1407	22		
2110-5204	14	2202-1611/1000-541	86				
2110-5207	14	2202-1611/1000-542	86	<b>2206 Series</b>			
		2202-1611/1000-836	86	2206-1201	24		
2110-5301	14	2202-1611/1000-867	86				
		2202-1661	76				



**WAGO Worldwide**  
**Companies and Representatives**

Sold & Serviced By:



Toll Free Phone (877) SERV098  
[www.electromate.com](http://www.electromate.com)  
[sales@electromate.com](mailto:sales@electromate.com)



















Sold & Serviced By:



Toll Free Phone (877) SERV098

[www.electromate.com](http://www.electromate.com)

[sales@electromate.com](mailto:sales@electromate.com)

WAGO is a registered trademark of WAGO Verwaltungsgesellschaft mbH.

"Copyright – WAGO Kontakttechnik GmbH & Co. KG – All rights reserved. The content and structure of the WAGO websites, catalogs, videos and other WAGO media are subject to copyright. Distribution or modification to the contents of these pages and videos is prohibited. Furthermore, the content may neither be copied nor made available to third parties for commercial purposes. Also subject to copyright are the images and videos that were made available to WAGO Kontakttechnik GmbH & Co. KG by third parties."