

RoundRail Linear Guides

Dual Shaft Rail 2DA

with Integrated Carriage Unpack and Install Inch

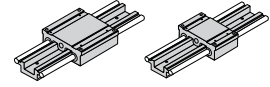

Features

- Used in continuously supported applications when rigidity is required
- Adaptable to any drive system
- Pre-aligned and preassembled for immediate installation and use
- Designed for medium to heavy loads

Components

- 1 Dual LinearRace shaft rail assembly
- 1 integrated carriage with 4 open type Super Smart Ball Bushing Bearings

Specifying this Thomson Linear Guide

1. Determine the proper Linear Guide for your load and life requirements.
2. Select the part number.
3. Add the letter "L" followed by the overall length in inches, as a suffix to the part number.

Part Numbering System

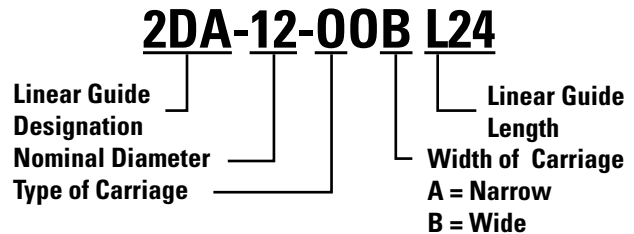

Dimensions (Inch)

2DA XX 00B
 Rail Cross Section

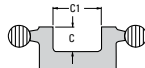

Dual Shaft Rail Linear Guide with Integrated Full Length Carriage

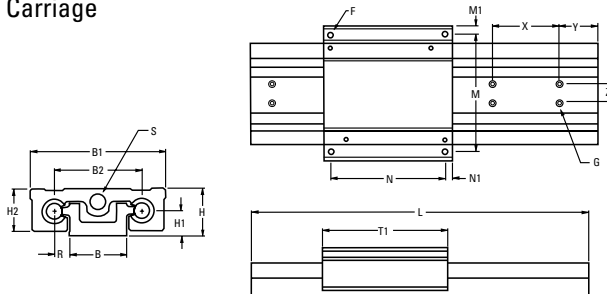

Load Rating and Limit by Direction

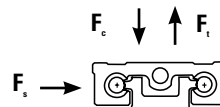

	Dynamic Load Rating	Load Limit
F_c	C	0.5C
F_t	C	0.5C
F_s	0.5C	0.5C

Dynamic Load Rating: load value used in life calculation.
 Load Limit: Maximum allowable load applied to bearing.

2DA XX 00A
 Rail Cross Section

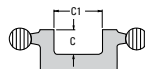

Dual Shaft Rail Linear Guide with Integrated Short Length Carriage

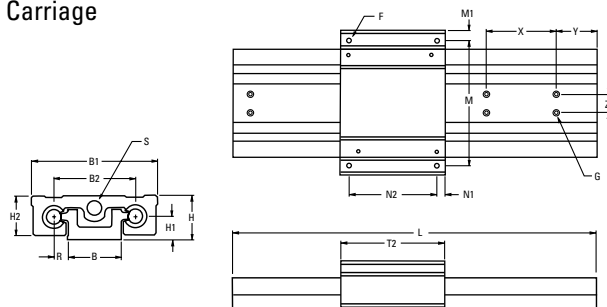

Load Rating and Limit by Direction

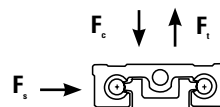

	Dynamic Load Rating	Load Limit
F_c	C	0.5C
F_t	C	0.5C
F_s	0.5C	0.5C

Dynamic Load Rating: load value used in life calculation.
 Load Limit: Maximum allowable load applied to bearing.

RoundRail Linear Guides

Dual Shaft Rail Linear Guide 2DA with Integrated Carriage (Dimensions in inches)

Part Number	Nominal Diameter	T1	H	H1	H2	B	R	B1	B2	C	C1
2DA-08-00B	.500	4.5	1.625	.875	1.43	2.00	.500	4.6	3.0	.64	1.25
2DA-12-00B	.750	6.0	2.125	1.125	1.93	2.63	.688	6.1	4.0	.75	1.662
2DA-16-00B	1.000	7.5	2.625	1.375	2.44	3.25	.875	7.6	5.0	.99	2.00

Dual Shaft Rail Linear Guide 2DA with Integrated Carriage (Dimensions in inches)

Part Number	N	N1	M	M1	X	Y	Z	S As Extruded	F	G		Maximum Stroke Length	Carriage	Dual Shaft Rail Assembly
										Bolt	Hole			
2DA-08-00B	4.00	.25	4.00	.30	4.0	2.0	.75	.50	#10-32	1/4	.28	L-(4.5)	DSRC-08-SB	DSRA-08
2DA-12-00B	5.25	.37	5.25	.42	6.0	3.0	1.0	.70	1/4-20	5/16	.34	L-(6.0)	DSRC-12-SB	DSRA-12
2DA-16-00B	6.75	.37	6.75	.42	6.0	3.0	1.25	.90	5/16-18	3/8	.41	L-(7.5)	DSRC-16-SB	DSRA-16

Support rails are supplied in 24 inch lengths unless quoted otherwise.

Dual Shaft Rail Support Material: Black Anodized Aluminum Alloy

Maximum continuous length of support rails is 72". If longer continuous shaft support rails are required, please contact the Danaher Motion Linear Guides Application Engineering department.

Dynamic Load Capacity Matrix (4 million inches travel)

Linear Guide Assembly Part Number	Dynamic Load Capacity (lb.) (Even Distribution)	Dynamic Roll Moment (in-lb.)
2DA-08-00B	480	720
2DA-12-00B	3200	6400
2DA-16-00B	5400	13500

Note: Above load ratings used for life calculations. Load limit of assembly 50%.

Dual Shaft Rail Linear Guide 2DA with Integrated Carriage (Dimensions in inches)

Part Number	Nominal Diameter	T2	H	H1	H2	B	R	B1	B2	C	C1
2DA-08-00A	.500	3.5	1.625	.875	1.43	2.00	.500	4.6	3.0	.64	1.25
2DA-12-00A	.750	4.5	2.125	1.125	1.93	2.63	.688	6.1	4.0	.75	1.662
2DA-16-00A	1.000	6.0	2.625	1.375	2.44	3.25	.875	7.6	5.0	.99	2.00

Dual Shaft Rail Linear Guide 2DA with Integrated Carriage (Dimensions in inches)

Part Number	N	N2	M	M1	X	Y	Z	S As Extruded	F	G		Maximum Stroke Length	Carriage	Dual Shaft Rail Assembly
										Bolt	Hole			
2DA-08-00A	.25	3.00	4.00	.30	4.0	2.0	.75	.50	#10-32	1/4	.28	L-(3.5)	DSRC-08-SB	DSRA-08
2DA-12-00A	.37	3.75	5.25	.42	6.0	3.0	1.0	.70	1/4-20	5/16	.34	L-(4.5)	DSRC-12-SB	DSRA-12
2DA-16-00A	.37	5.25	6.75	.42	6.0	3.0	1.25	.90	5/16-18	3/8	.41	L-(6.0)	DSRC-16-SB	DSRA-16

Support rails are supplied in 24 inch lengths unless quoted otherwise.

Dual Shaft Rail Support Material: Black Anodized Aluminum Alloy

Maximum continuous length of support rails is 72". If longer continuous shaft support rails are required, please contact the Danaher Motion Linear Guides Application Engineering department.

† Super Ball Bushing Bearings are used in 500 inch size carriages.

Dynamic Load Capacity Matrix (4 million inches travel)

Linear Guide Assembly Part Number	Dynamic Load Capacity (lb.) (Even Distribution)	Dynamic Roll Moment (in-lb.)
2DA-08-00A	480	720
2DA-12-00A	3200	6400
2DA-16-00A	5400	13500

Note: Above load ratings used for life calculations. Load limit of assembly 50%.