



## Lead Screws, Ball Screws and Ball Splines

Sold & Serviced By:

 **ELECTROMATE**

Toll Free Phone (877) SERV098

Toll Free Fax (877) SERV099

[www.electromate.com](http://www.electromate.com)

[sales@electromate.com](mailto:sales@electromate.com)

 **THOMSON**<sup>®</sup>

*Linear Motion. Optimized.<sup>™</sup>*



*Linear Motion. Optimized.™*

## Thomson – the Choice for Optimized Motion Solutions

Often the ideal design solution is not about finding the fastest, sturdiest, most accurate or even the least expensive option. Rather, the ideal solution is the optimal balance of performance, life and cost.

### The Best Positioned Supplier of Mechanical Motion Technology

Thomson has several advantages that make us the supplier of choice for motion control technology.

- Thomson provides the broadest standard product offering of mechanical motion technologies in the industry.
- Modified versions of standard product or white sheet design solutions are routine for us.
- Choose Thomson and gain access to over 70 years of global application experience in industries including packaging, factory automation, material handling, medical, clean energy, printing, automotive, machine tool, aerospace and defense.
- As part of Danaher Corporation, we are financially strong and unique in our ability to bring together control, drive, motor, power transmission and precision linear motion technologies.

### A Name You Can Trust

A wealth of product and application information as well as 3D models, software tools, our distributor locator and global contact information is available at [www.thomsonlinear.com](http://www.thomsonlinear.com). For assistance, contact your local sales office (contact information listed on the back of catalog). Talk to us early in the design process to see how Thomson can help identify the optimal balance of performance, life and cost for your next application. And, call us or any of our 2000+ distribution partners around the world for fast delivery of replacement parts.

### The Danaher Business System

The Danaher Business System (DBS) was established to increase the value we bring to customers. It is a mature and successful set of tools we use daily to continually improve manufacturing operations and product development processes. DBS is based on the principles of Kaizen which continuously and aggressively eliminate waste in every aspect of our business. DBS focuses the entire organization on achieving breakthrough results that create competitive advantages in quality, delivery and performance – advantages that are passed on to you. Through these advantages Thomson is able to provide you faster times to market as well as unsurpassed product selection, service, reliability and productivity.

### Local Support Around the Globe

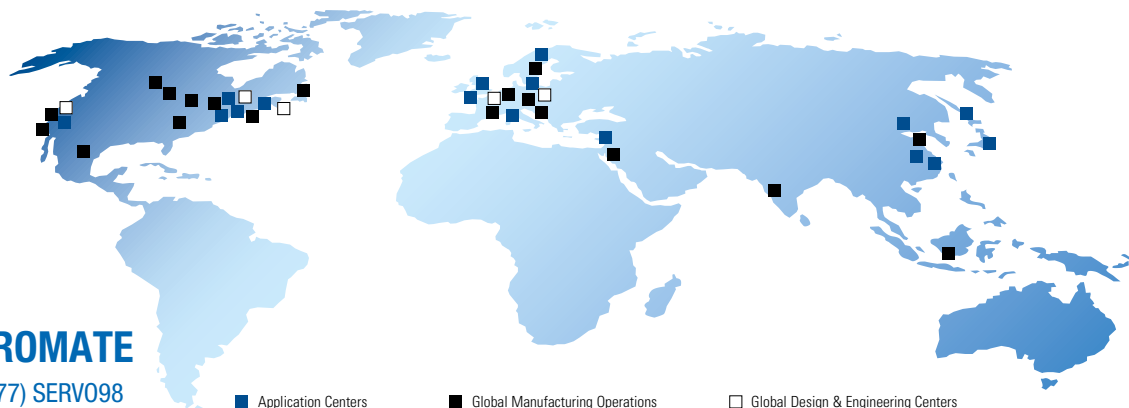

Sold & Serviced By:



Toll Free Phone (877) SERV098

Toll Free Fax (877) SERV099

[www.electromate.com](http://www.electromate.com)

[sales@electromate.com](mailto:sales@electromate.com)

### A World Class Heritage Serves as Our Foundation

**The very best of the Thomson, Warner, BSA and Neff ball and lead screw lines are now combined to form the most complete product offering in the industry**

Thomson has a long history of manufacturing quality lead screws and ball screws. Our roots are planted in four separate companies that held strong and definitive footholds in the market. Those companies — **Ball Screws & Actuators Co, Warner Linear, Thomson Industries, and Neff Automation** — now form the nucleus of the Thomson ball screw and lead screw business.

Founded in 1971, the **Ball Screws & Actuators Co. (BSA)** was a pioneer and leader in precision plastic nut, lead screw and ball screw technologies for linear motion applications. Their custom and off-the-shelf solutions featured many patented products, including their ActiveCAM technology for eliminating backlash while increasing performance and wear life. BSA joined Danaher Motion in 1996 and brought a wealth of experience and knowledge to the ball and lead screw team.

Tollo Linear was founded in 1982 and manufactured linear actuators, linear drive units and handling components under a variety of trademarked product names. Its products were sold to direct customers, OEM manufacturers, and system houses throughout the world. In 1989, Tollo Linear was purchased by Warner Electric and the new division became known as **Warner Linear**. After substantial growth in the industry, Warner Linear, including its superior ball screw product line, was acquired by Danaher Motion in 2000.

**Thomson Industries** was the leading U.S. producer of linear motion control products, including linear actuators, ball screws, linear bearings and rails, and precision gearboxes. Its products were found in a range of precision motion applications in the medical, industrial, aerospace and mobile off-highway markets. In October 2002, Danaher Motion acquired Thomson Industries and retained the strong Thomson brand name.

**Neff Automation** was founded in 1905 and has since been a leading manufacturer of industrial products for linear motion applications. In the past four decades Neff has become a market leader in high precision rolled ball screws, providing solutions for customers all across the globe. In 2004 Neff Automation joined Danaher Motion, bringing high quality products, manufacturing expertise, and deep application knowledge to the ball and lead screw team.

The current lead screw and ball screw offerings of Danaher Motion combine the quality, strength and expertise of the distinct products and professionals at these four companies under the **Thomson** name. The products set the solid foundation for the broad range of standard and custom lead and ball screws available today. If past history and experience is an indication of what the future holds, Thomson is significantly poised to remain a prominent leader and pioneer in the ball screw and lead screw industry.

Ball Screws and Actuators (BSA)  
Warner Linear Ball Screws  
Thomson Industries  
Neff Automation



**Thomson BSA Lead Screws & Supernuts**  
**Precision Rolled Ball Screws — Inch Series**  
**Precision Plus Ball Screws — Inch & Metric Series**  
**Miniature Rolled Ball Screws — Metric Series**  
**Thomson NEFF Rolled Ball Screws — Metric Series**  
**Precision Rolled Ball Splines — Inch Series**

<b>Company Overview</b> .....	3
<b>Product Overview</b> .....	5
<b>Request for Quote</b> .....	6
<b>Application Analysis Worksheet</b> .....	7
<b>Technology Comparison</b> .....	8
<b>Lead Screws</b>	
Product Overview .....	12
Advanced Anti-Backlash Supernuts .....	14
Flange Mount Supernuts .....	25
Thread Mount Supernuts .....	28
Thread Mount Bronze Nuts .....	31
Standard Mounting Flanges .....	33
Stainless Steel Lead Screws .....	34
V-Thread Screws .....	37
<b>Ball Screws — Inch Series</b>	
Product Overview .....	40
Precision Rolled Ball Screws — Inch Series .....	44
Visual Product Reference — Precision Rolled Ball Screws — Inch Series .....	89
Precision Plus Ball Screws — Inch Series .....	99
<b>Ball Screws — Metric Series</b>	
Product Overview .....	104
Miniature Rolled Ball Screws — Metric Series .....	111
Thomson NEFF Rolled Ball Screws — Metric Series .....	115
Precision Plus Ball Screws — Metric Series .....	129
<b>Ball Splines</b>	
Precision Rolled Ball Splines — Inch Series .....	133
<b>Bearing Supports/End Machining</b>	
Product Overview .....	138
Quick Install Assemblies .....	141
Bearing Supports/End Machining .....	148
<b>Engineering</b>	
Lead Screws .....	175
Ball Screws — Inch Series .....	179
Ball Screws — Metric Series .....	193
Ball Splines .....	203
Bearing Supports .....	207
Installation .....	209
Maintenance and Service .....	218
Lubrication .....	225
Glossary/Formulas .....	226

## Product Overview

### THOMSON BSA PRECISION LEAD SCREWS AND SUPERNUTS®

Offering smooth, precise, cost effective positioning, this is the “just right” solution for your application.

Thomson BSA precision lead screws are an excellent economical solution for your linear motion requirements. For more than 30 years, Thomson BSA has designed and manufactured the highest quality lead screw assemblies in the industry. Our precision rolling machines ensure accurate positioning to 0.003 in/ft and our PTFE coating process produces assemblies that have less drag torque and last longer. All of our standard plastic nut assemblies use an internally lubricated Acetal — providing excellent lubricity and wear resistance with or without additional lubrication. With the introduction of our new unique patent pending zero backlash designs, Thomson BSA provides assemblies with high axial stiffness, zero backlash and the absolute minimum drag torque to reduce motor requirements. These designs produce products that cost less, perform better and last longer. Both designs automatically adjust for wear insuring zero backlash for the life of the nut. For significantly higher loads, standard bronze nuts are available.

### THOMSON BALL SCREWS — INCH SERIES

The most comprehensive imperial-based ball screw product offering in the industry.

Thomson is the market leader in inch-dimensioned ball screws, featuring the very best of the ball screw product offerings of BSA, Warner Linear, and Thomson Industries, integrated into a single, comprehensive product offering. Our **Precision Rolled Ball Screws** come in a full range of diameters, leads, and ball nut configurations, in either preloaded or non-preloaded types, all in industry-standard envelopes. They provide dependable accuracy and repeatability at an economical price. Thomson also offers inch-based **Precision Plus Ball Screws**, which provide higher-level precision for immediate improvement in machine performance. All Thomson ball screws feature a Gothic arch ball groove geometry that extends service life, reduces lash, and optimizes stiffness in preloaded assemblies. This unique design feature also eliminates skidding, increases positioning accuracy, and maximizes travel life.

### THOMSON BALL SCREWS — METRIC SERIES

Superior performance for today’s most stringent positioning requirements.

Thomson offers a full range of internal return metric ball screw products, featuring four distinct product families. **Miniature Rolled Ball Screw Assemblies** are an efficient, cost-effective solution in a small envelope. Ball screw assemblies range from 4mm to 14mm in diameter, with standard lead accuracies of 52 microns/300mm. **Thomson NEFF Rolled Ball Screw Assemblies** are designed and manufactured to provide high level performance at an affordable price. Ball screws are manufactured using Thomson’s patented, German-engineered Precision Screw Forming (PSF) Technology, which provides high accuracy (23 microns/300mm standard) with the manufacturing efficiency of rolled processes. **Thomson NEFF Rolled Ball Screw Assemblies** are available in a wide range of diameters, leads and nut styles — all designed to provide quiet, smooth running, efficient performance. Ball nuts include one of three unique ball return systems providing perfect guidance, low wear, and smooth running performance. **Precision Plus Ball Screw Assemblies** are our highest precision product, with standard lead accuracies of 12 microns/300mm. These ball screw assemblies feature our FL-style ball nut, designed to provide high repeatability and high stiffness for the most demanding ball screw applications.

### THOMSON PRECISION BALL SPLINES

High reliability, speed, and versatility for tough applications with torque loads.

Thomson precision ball splines provide high speed, anti-friction linear motion under high torsional loads. They have high reliability under varying operating conditions and predictable life expectancy. They resist radial displacement resulting from torque loads, and require smaller forces to achieve axial displacement of the spline member while transmitting torque. Ball splines have application versatility such as helicopter rotor couplings; translating drive shaft couplings, non-swiveling telescoping struts; honing machine and drill press spindles, workhead and table ways, and remote and robot handling machines.



Lead Screws



Ball Screws - Inch Series



Ball Screws - Metric Series



Ball Splines

Bearing Supports/  
End Machining

Engineering

Date: \_\_\_\_/\_\_\_\_/\_\_\_\_

## Request for Quote

Use this form if you have already selected a product. We will respond within four hours.

### 1. Information

<b>Name</b>		<b>Title/Dept.</b>	
<b>Company Name</b>			
<b>Address</b>			
<b>Phone</b>		<b>Fax</b>	
<b>Email</b>			

**Note:** If this product or assembly has been quoted or ordered before, please provide the quote number or order number.

<b>Quote No.</b>		<b>Order No.</b>	
------------------	--	------------------	--

### 2. Screw and Nut Part Numbers

<b>Qty.</b>		<b>Lead Error</b>	0.004"/ft <input type="checkbox"/>	0.005"/ft <input type="checkbox"/>	50µ/300mm <input type="checkbox"/>	23µ/300mm <input type="checkbox"/>	12µ/300mm <input type="checkbox"/>
<b>Diameter</b>		<b>Lead</b>					
<b>Screw P/N</b>		<b>Overall Length*</b>					
<b>Ball Nut P/N</b>		<b>Flange P/N</b>		<b>Wiper P/N</b>			

### 3. Bearing Supports

<b>Right End</b>	<input type="checkbox"/> None	<input type="checkbox"/> Floating	<input type="checkbox"/> Quick Mount
<b>Left End</b>	<input type="checkbox"/> None	<input type="checkbox"/> Floating	<input type="checkbox"/> Quick Mount

### 4. End Machining\*

<b>Right End</b>	<input type="checkbox"/> BK	<input type="checkbox"/> BF	<input type="checkbox"/> FK	<input type="checkbox"/> FF	<input type="checkbox"/> QK	<input type="checkbox"/> QF	<input type="checkbox"/> Cut to Length Only
	<input type="checkbox"/> BK1	<input type="checkbox"/> BF1	<input type="checkbox"/> FK1	<input type="checkbox"/> FF1	<input type="checkbox"/> QK1	<input type="checkbox"/> QF1	<input type="checkbox"/> Annealed _____ (specify length annealed)
<b>Left End</b>	<input type="checkbox"/> BK	<input type="checkbox"/> BF	<input type="checkbox"/> FK	<input type="checkbox"/> FF	<input type="checkbox"/> QK	<input type="checkbox"/> QF	<input type="checkbox"/> Cut to Length Only
	<input type="checkbox"/> BK1	<input type="checkbox"/> BF1	<input type="checkbox"/> FK1	<input type="checkbox"/> FF1	<input type="checkbox"/> QK1	<input type="checkbox"/> QF1	<input type="checkbox"/> Annealed _____ (specify length annealed)

### 5. Configuration\*

<input type="checkbox"/> Ball Nut (V-Thread/Flange) Facing Left End	<input type="checkbox"/> Ball Nut (V-Thread/Flange) Facing Right End	<input type="checkbox"/> Modified Flange (Attach Print)
---	--	---

\* Customer print will take precedence if provided.

Need a quote or have a question about an application? Contact us in North America at:

Phone: 540-633-3549

Fax: 540-639-4162

Email: thomson@thomsonlinear.com



Date: \_\_\_\_ / \_\_\_\_ / \_\_\_\_

## Application Data Sheet

*Use this form if you need assistance selecting a product. We will respond within four hours.*

### 1. Information

<b>Name</b>		<b>Title/Dept.</b>	
<b>Company Name</b>			
<b>Address</b>			
<b>Phone</b>		<b>Fax</b>	
<b>Email</b>			

### 2. Application Requirements

<b>What is your LOAD?</b>		<input type="checkbox"/> lbs	<input type="checkbox"/> kg
		<input type="checkbox"/> N	<input type="checkbox"/> Other (please specify)

<b>What is your MOTION?</b>		<input type="checkbox"/> Vertical	<input type="checkbox"/> Horizontal
		<input type="checkbox"/> Other (please specify)	

<b>What is your length of STROKE?</b>		<input type="checkbox"/> inch	<input type="checkbox"/> foot
		<input type="checkbox"/> mm	<input type="checkbox"/> Other (please specify)

<b>What is your required TRAVEL LIFE?</b>		<input type="checkbox"/> inch	<input type="checkbox"/> foot
		<input type="checkbox"/> mm	<input type="checkbox"/> Other (please specify)

<b>What is your SPEED?</b>		<input type="checkbox"/> inch	PER	<input type="checkbox"/> minute
		<input type="checkbox"/> mm		<input type="checkbox"/> second
		<input type="checkbox"/> foot		<input type="checkbox"/> Other (please specify)

<b>Accuracy Requirements</b>	0.004"/ft <input type="checkbox"/>	0.005"/ft <input type="checkbox"/>	52 $\mu$ /300mm <input type="checkbox"/>	23 $\mu$ /300mm <input type="checkbox"/>	12 $\mu$ /300mm <input type="checkbox"/>	Other (please specify)
------------------------------	---------------------------------------	---------------------------------------	---	---	---	------------------------

<b>Backlash Requirements</b>	0.000" <input type="checkbox"/>	0.002" <input type="checkbox"/>	0.010" <input type="checkbox"/>	0.05mm <input type="checkbox"/>	0.2mm <input type="checkbox"/>	Other (please specify)
------------------------------	------------------------------------	------------------------------------	------------------------------------	------------------------------------	-----------------------------------	------------------------

<b>Bearing Supports?</b>	<input type="checkbox"/> Fixed/Fixed	<input type="checkbox"/> Fixed/Free	<input type="checkbox"/> Fixed/Simple
	<input type="checkbox"/> Other (please specify)		

<b>Motor Cube Required?</b>	<input type="checkbox"/> NEMA 17	<input type="checkbox"/> NEMA 23	<input type="checkbox"/> Other (please specify)
	<input type="checkbox"/> NEMA 42	<input type="checkbox"/> NEMA 34	

<b>Quantity Required?</b>		<input type="checkbox"/> per Week	<input type="checkbox"/> per Month
		<input type="checkbox"/> per Year	<input type="checkbox"/> Other (please specify)

### Additional Information/Comments

--

## Technology Comparison

### Thomson Ball Screws and Lead Screws Are Your Best Choice for Linear Actuation

Thomson ball screws outperform other actuation methods.

Compared to bulky, noisy, and expensive hydraulic or pneumatic actuator systems, Thomson ball screws and lead screws are compact, quiet, and very affordable. In addition, there's no need for pumps, hoses, fluids, or shop air. This eliminates fire, safety, and health hazards due to leaking fluid or other contaminants typically associated with these types of actuation methods.

Belt, cable, and chain-drive mechanisms are relatively inexpensive. However, they aren't as precise, repeatable, or as safe to use as ball screws and lead screws. Their failure mode is either excessive wear or stretching, resulting in positioning inaccuracies during operation. These types of systems also have low load capacities.

Rack and pinion gear systems can be made to close tolerances, but lose precision as they wear and don't function as smoothly as ball screws, even when new. Because the force is supported by a few pinion teeth at any given time, the system also is limited in terms of load capacity.

Offset cam rollers rely on the tractive force between the rollers and the shaft to create linear motion, and therefore can handle only

moderate loads. The higher the load, the more likely it is that the system will slip, reducing repeatability.

In summary, when compared to other types of mechanical actuation methods, Thomson ball screws and lead screws provide the most cost-effective combination of speed, accuracy, efficiency, repeatability, quiet operation, lubrication retention, load capacity, and compactness.

Thomson precision ball screw and lead screw assemblies are the first choice in precise, reliable, cost-effective linear actuation.

Thomson lead screws excel in applications which require the "just right" solution. They are easily customized to provide compact, quiet and accurate positioning in light to medium load applications. Materials are inert as a standard and allow use in applications ranging from clean room to marine. Best of all, the value is high as you don't pay for processes and features not required in your application.

Let Thomson engineer your positioning screw today.

### Ball and Lead Screw vs. Other Actuation Methods

	Thomson Lead Screws	Thomson Ball Screws	Fluid Power	Belt, Cable, and Chain-Drive Mechanisms	Rack & Pinion	Offset Cam Rollers	Pneumatic Cylinders
Inexpensive	●	●	○	●		●	
Low Power Consumption		●		●	●	●	
Low Maintenance	●	●		○	○	○	●
High Accuracy		●					
High Repeatability	○	●					
High Efficiency		●			○	○	
High Load Capacity		●	●				○
Compact Size	●	●			●		○
Speed	●	●		●	●		●
Low Noise	●	○		○		○	
Design Flexibility	●	●			○		
Contamination Tolerance	●	○	●				

● = always  
○ = in most cases



**Technology Comparison**

## Design Considerations for Choosing Screw Type

Design Considerations	Thomson Lead Screw	Thomson Ball Screw
Load	Typically light (<100 lbs.)	Usually heavy (>100 lbs.)
Cost	Low cost \$\$	Higher cost \$\$\$
Anti-backlash	Available — but has low stiffness	Available
Self-locking	Yes — but depends on lead and lubrication	Fail safe brake locking option
Efficiency	Generally ranges from 30% to 70%	Generally ranges from 85% to 95%
Duty Cycle	Limited to plastic heat transfer properties	Unlimited
Corrosion Resistance	Available in stainless steel as a standard	Wide range of available sizes in stainless steel, as well as coating and plating options
Lubrication	Can operate with or without lubrication depending on application	Must have lubrication Wide range of lubricants
Operating Temperature	Limited to expansion differences between the screw and the nut	Wide temperature range
Travel Speed	Available in wide range of leads	Typically mid-range leads
Vibration and Noise	Typically quiet, high leads are best	Ball re-circulation
Custom Availability	Great flexibility in customizing materials and geometry	Great flexibility in customizing materials and geometry — limited by ball path envelope
Catalog Page	11	39

**NOTES:**

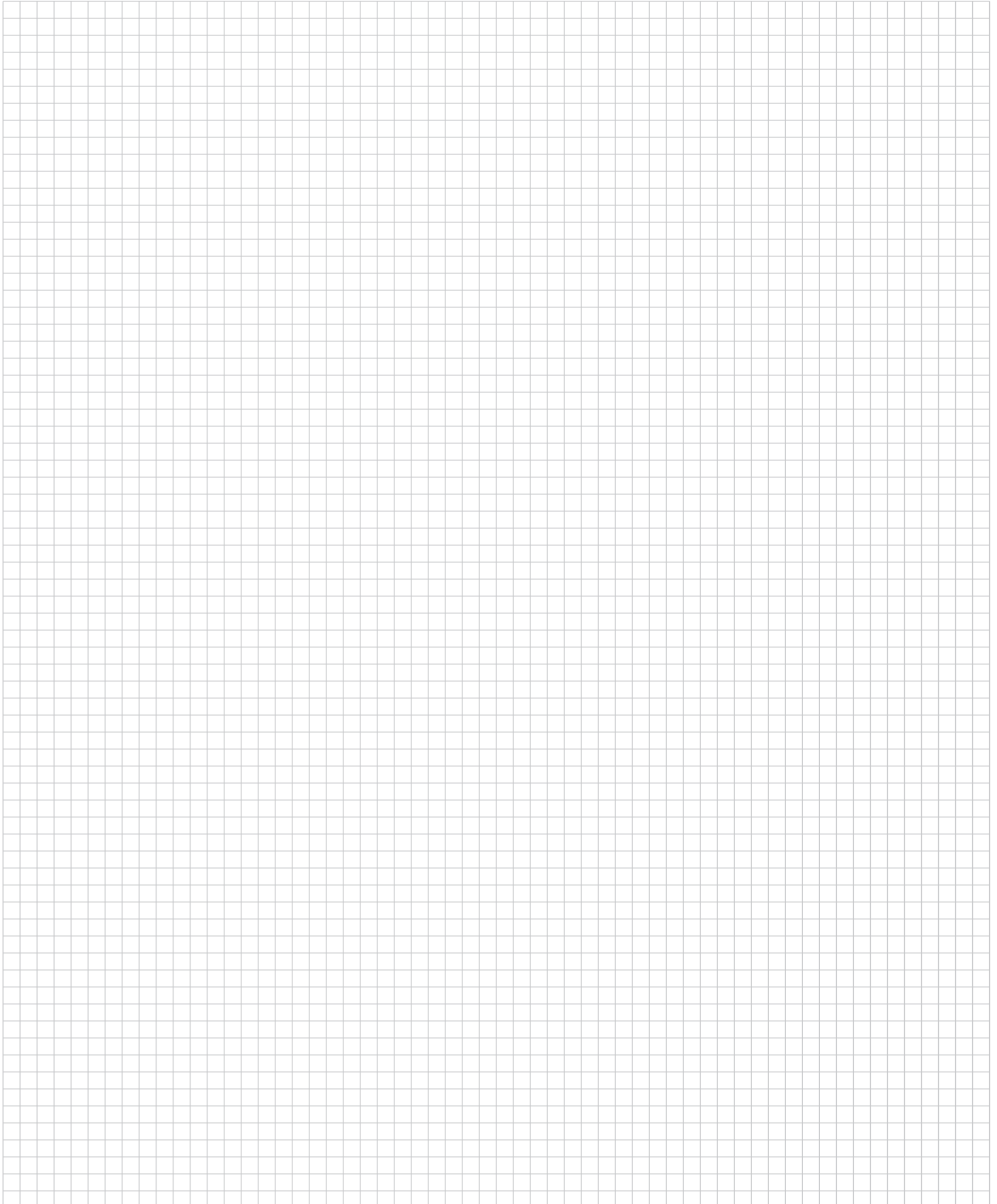

# Lead Screws



## Table of Contents

<b>Description</b>	<b>Page</b>
Product Overview .....	12
Advanced Anti-Backlash Supernuts .....	14
Flange Mount Supernuts .....	25
Thread Mount Supernuts .....	28
Thread Mount Bronze Nuts .....	32
Standard Mounting Flanges .....	34
Stainless Steel Lead Screws .....	35
V-Thread Screws .....	38

Need a quote or have a question about an application?  
Contact us in North America at:

Phone: 800-882-8857

Email: [thomsonbsa@thomsonlinear.com](mailto:thomsonbsa@thomsonlinear.com)

Web: [www.thomsonbsa.com](http://www.thomsonbsa.com)

## Lead Screws Product Overview

Offering smooth, precise, cost effective positioning, this is the “just right” solution for your application.

Thomson BSA precision lead screws are an excellent economical solution for your linear motion requirements. For more than 25 years, Thomson BSA has designed and manufactured the highest quality lead screw assemblies in the industry. Our precision rolling machines ensure accurate positioning to 0.003 in/ft and our PTFE coating process produces assemblies that have less drag torque and last longer.

Thomson BSA provides a large array of standard plastic nut assemblies in anti-backlash or standard Supernut® designs. All of our standard plastic nut assemblies use an internally lubricated Acetal — providing excellent lubricity and wear resistance with or without additional lubrication. With the introduction of our new unique patent pending zero backlash designs, Thomson BSA provides assemblies with high axial stiffness, zero backlash and the absolute minimum drag torque to reduce motor requirements. These designs produce products that cost less, perform better and last longer. Both designs automatically adjust for wear, insuring zero backlash for the life of the nut.

For significantly higher loads, standard bronze nuts are available. Thomson BSA uses SAE 660 bearing bronze, which provides high load capacity with good PV performance. We also offer end machining to your specification or can provide you with stock bearing mounts or motor mounts. Available from over 1800 distributors worldwide.

Thomson BSA also provides engineering design services to aid in your design requirements, producing a lead screw assembly to your specifications. Call the factory today to discuss your application with one of our experienced application engineers, 800-882-8857.



## Lead Screws Product Overview

### Lead Screw Product Summary

Series	Thomson BSA Precision Lead Screw	
	Inch	Metric
Lead accuracy	.010"/ft. for standard .003"/ft. for precision	250 micron/300mm for standard 75 micron/300mm for precision
Diameter	.187" - 3.00"	6mm - 24mm
Lead	.013" - 2.00"	.5mm - 50.0mm
Backlash	.010" (max)	.25mm (max)
Dynamic Load	Up to 400 lbs*	Up to 1.3 kN*
Max. Static Load	Up to 2,000 lbs*	Up to 6.6 kN*
Catalog Pages	14 - 38	14 - 38

\* Plastic nut ratings. Does not include bronze nut specifications.

### Lead Screw Product Availability

	Inch	Lead (in.)																
		0.031	0.050	0.063	0.083	0.100	0.125	0.167	0.200	0.250	0.300	0.375	0.500	0.800	1.000	1.200	1.500	2.000
Dia. (in.)	3/16		●				●											
	1/4	●	●	●			●		●	●			●					
	5/16				●			●		●			●		●			
	3/8		●	●	●	●	●	●	●	●	●	●	●		●	●		
	7/16						●			●			●					
	1/2			●		●			●	●			●	●	●		●	
	5/8					●	●		●	●			●					
	3/4					●	●	●	●				●		●		●	●
	1					●	●		●	●			●		●			
	1-1/4								●	●								
	1-1/2								●	●		●	●					
	2									●								
	2-1/4									●								
	2-1/2									●								
	2-3/4									●								
3									●									

	Metric	Lead (mm)															
		1	2	3	4	5	6	8	10	12	15	16	20	25	35	45	50
Dia. (mm)	6	●	●	●													
	10		●	●	●	●	●		●	●			●		●		
	12			●	●	●	●		●			●		●		●	
	16				●	●			●			●		●	●		
	20				●				●		●		●	●		●	●
	24					●											

Availability charts do not include V-thread screw leads.

## Advanced Anti-Backlash Supernuts®

### XCM 1800

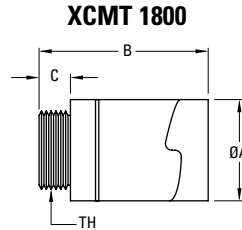

Our smallest anti-backlash nut design ever. The XCM 1800 uses the same patented† ActiveCAM™ mechanism as its larger siblings in a miniaturized package. This allows backlash free operation in space critical applications requiring high accuracy and low drag torque. This cost effective solution is available in either flanged or threaded versions. TriCoat® PTFE dry film lubricant is available as an option on most screws.

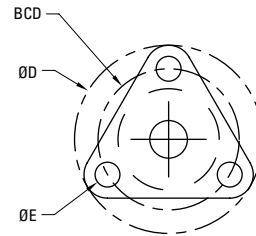

### XCMF 1800

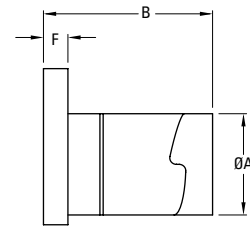

Note: See Screw Section on page 35. Specify XCMT or XCMF when ordering, see drawings at right.

Dia.	Lead	Part No.	Supernut® Dimensions								Design Load	Efficiency %	Drag Torque oz-in
			A	B	C	D	E	F	BCD	TH			
3/16"	0.050	XCM_1820	0.50	0.90 (max)	0.200	1.00	0.143	0.18	0.750	7/16"-20	5 lbs	49	< 1
	0.125	XCM_3-1824										70	
6mm*	1mm	XCM_6x1	0.50	0.90 (max)	0.200	1.00	0.143	0.18	0.750	7/16"-20	5 lbs	29	< 1
1/4"*	0.0125	XCM_2580	0.50	0.90 (max)	0.200	1.00	0.143	0.18	0.750	7/16"-20	5 lbs	13	< 1
	0.0208	XCM_2548										20	
	0.0250	XCM_2540										23	
	0.0278	XCM_2536										25	
	0.0313	XCM_2532										28	
	0.0357	XCM_2528										30	
	0.0417	XCM_2524										34	
1/4"	0.050	XCM_2520	0.50	0.90 (max)	0.200	1.00	0.143	0.18	0.750	7/16"-20	5 lbs	41	< 1
	0.063	XCM_2516										48	
	2mm	XCM_2-25x1M										53	
	3mm	XCM_3-25x1M										62	
	0.125	XCM_2-2516										64	
	0.200	XCM_4-2520										72	
	0.250	XCM_4-2516										76	
	0.500	XCM_7-2514										81	

\* V-Thread screws, see page 38.

† Patent No. 5839321



## Advanced Anti-Backlash Supernuts®

### XC 2500



The XC Model Anti-Backlash assembly is the most advanced Anti-Backlash nut design. The unique patented† ActiveCAM™ accomplishes high axial stiffness, zero backlash and the absolute minimum drag torque. This advantage produces assemblies that cost less, perform better and last longer. The ActiveCAM™ automatically adjusts for wear insuring zero backlash for the life of the nut.

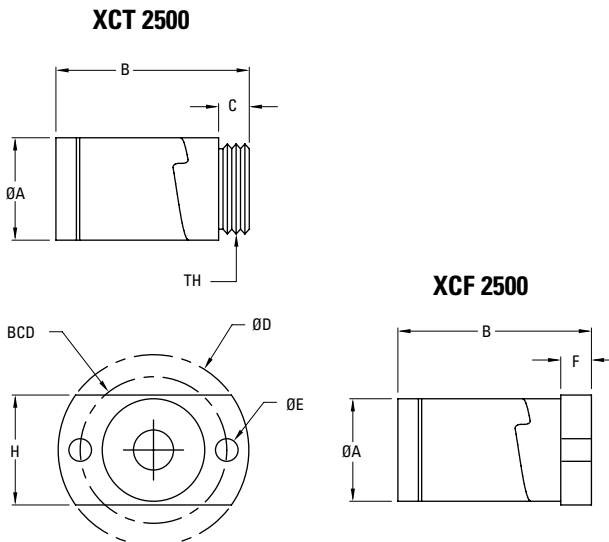

Note: See Screw Section on page 35. Specify XCT or XCF when ordering, see drawings at right.

Dia.	Lead	Part No.	Supernut® Dimensions									Design Load	Efficiency %	Drag Torque oz-in
			A	B	C	D	E	F	H	BCD	TH			
6mm*	1mm	XC_6x1	0.64	1.18 (max)	0.187	1.19	0.141	0.16	0.66	0.900	9/16" -18	10lbs	29	<1
1/4"*	0.0125	XC_2580	0.64	1.18 (max)	0.187	1.19	0.141	0.16	0.66	0.900	9/16" -18	10lbs	13	<1
	0.0208	XC_2548											20	
	0.0250	XC_2540											23	
	0.0278	XC_2536											25	
	0.0313	XC_2532											28	
	0.0357	XC_2528											30	
	0.0417	XC_2524											34	
1/4"	0.050	XC_2520	0.64	1.18 (max)	0.187	1.19	0.141	0.16	0.66	0.900	9/16" -18	10lbs	41	<1
	0.063	XC_2516											48	
	2mm	XC_2-25x1M											53	
	3mm	XC_3-25x1M											62	
	0.125	XC_2-2516											64	
	0.200	XC_4-2520											72	
	0.250	XC_4-2516											76	
	0.500	XC_7-2514											81	

\* V-Thread screws, see page 38.

† Patent No. 5839321

## Advanced Anti-Backlash Supernuts®

### XC 3700

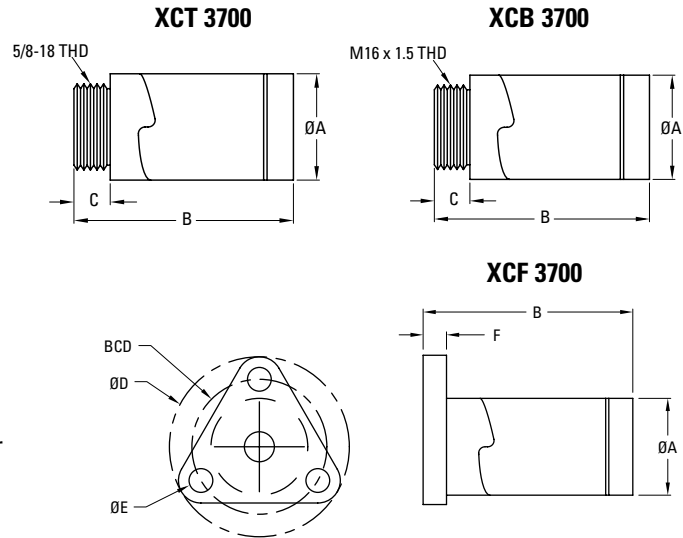

The XC Model Anti-Backlash assembly is the most advanced Anti-Backlash nut design. The unique patented† ActiveCAM™ accomplishes high axial stiffness, zero backlash and the absolute minimum drag torque. This advantage produces assemblies that cost less, perform better and last longer. The ActiveCAM™ automatically adjusts for wear insuring zero backlash for the life of the nut.

Note: See Screw Section on page 35. Specify XCT, XCB or XCF when ordering, see drawings at right.

Dia.	Lead	Part No.	Supernut® Dimensions							Design Load	Efficiency %	Drag Torque oz-in
			A	B	C	D	E	F	BCD			
5/16"	0.083	XC_3112	0.82	1.875 (max)	0.25	1.5	0.2	0.2	1.125	25 lbs	49	1 - 3
	0.167	XC_2-3112									65	
	0.250	XC_2-3108									72	
	0.500	XC_4-3108									80	
	1.000	XC_8-3108									81	
3/8"	0.050	XC_3720	0.82	1.875 (max)	0.25	1.5	0.2	0.2	1.125	25 lbs	32	1 - 3
	0.063	XC_3716									36	
	2mm	XC_37x2M									42	
	0.083	XC_3712									44	
	0.100	XC_3710									49	
	0.125	XC_3708									53	
	0.167	XC_2-3712									60	
	0.200	XC_2-3710									65	
	0.250	XC_2-3708									68	
	0.300	XC_3-3710									73	
	0.375	XC_4-3711									75	
0.500	XC_4-3708	79										
10mm	2mm	XC_10x2M	0.82	1.875 (max)	0.25	1.5	0.2	0.2	1.125	25 lbs	41	1 - 3
	3mm	XC_10x3M									53	
	4mm	XC_2-10x2M									59	
	5mm	XC_2-10x2.5M									64	
	6mm	XC_4-10x1.5M									67	
	10mm	XC_5-10x2M									76	
	12mm	XC_5-10x2-4M									78	
	20mm	XC_6-10x3.3M									81	
35mm	XC_10-10x3.5M	81										

† Patent No. 5839321

## Advanced Anti-Backlash Supernuts®

### XC 5000



The XC 5000 utilizes the same patented† ActiveCAM™ as found in the XC 3700 model. Along with the very low drag torque and high axial stiffness advantages, the XC 5000 has greater load capacity.

Note: See Screw Section on page 35. Specify XCT, XCB or XCF when ordering, see drawings at right.

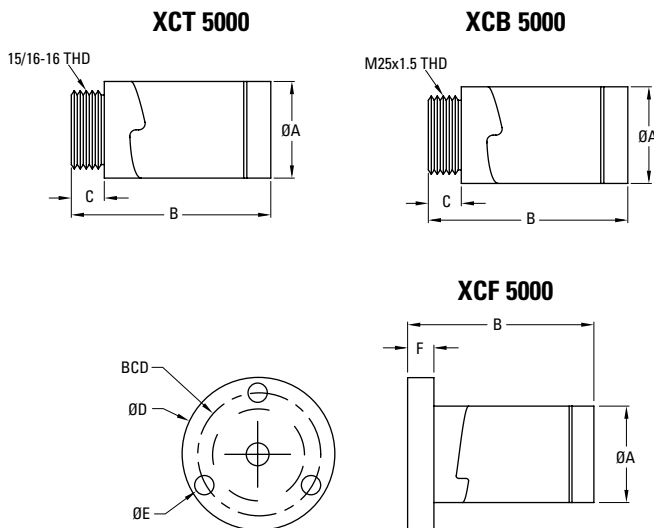

Dia.	Lead	Part No.	Supernut® Dimensions							Design Load	Efficiency %	Drag Torque oz-in
			A	B	C	D	E	F	BCD			
7/16"	0.125	XC_2-4316	1.12	2.25 (max)	0.375	1.75	0.2	0.3	1.406	125 lbs	55	1 - 3
	0.250	XC_2-4308									65	
	0.500	XC_4-4308									76	
12mm	3mm	XC_12x3M	1.12	2.25 (max)	0.375	1.75	0.2	0.3	1.406	125 lbs	48	1 - 3
	4mm	XC_2-12x2M									54	
	5mm	XC_2-12x2.5M									59	
	6mm	XC_3-12x2M									63	
	10mm	XC_4-12x2.5M									73	
	15mm	XC_6-12x2.5M									78	
	25mm	XC_10-12x2.5M									82	
	45mm	XC_15-12x3M									81	
1/2"	.0625	XC_5016	1.12	2.25 (max)	0.375	1.75	0.2	0.3	1.406	125 lbs	30	1 - 3
	0.100	XC_5010									41	
	4mm	XC_2-50x2M									52	
	0.200	XC_2-5010									57	
	0.250	XC_2-5008									62	
	0.500	XC_4-5008									75	
	0.800	XC_8-5010									80	
	1.000	XC_8-5008									81	
1.500	XC_12-5008	82										

† Patent No. 5839321

## Advanced Anti-Backlash Supernuts®

### XC 6200

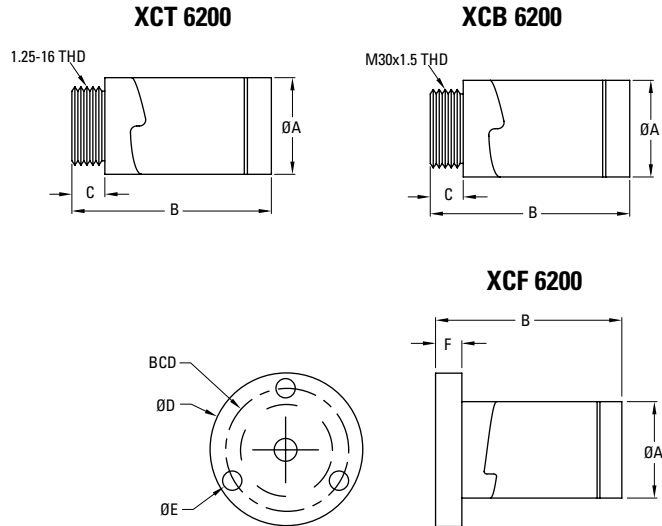

The XC 6200 utilizes the same patented† ActiveCAM™ as found in the XC 5000 model. Along with the very low drag torque and high axial stiffness advantages, the XC 6200 has greater load capacity.

Note: See Screw Section on page 35. Specify XCT, XCB or XCF when ordering, see drawings at right.

Dia.	Lead	Part No.	Supernut® Dimensions							Design Load	Efficiency %	Drag Torque oz-in
			A	B	C	D	E	F	BCD			
5/8"	0.100	XC_6210	1.40	2.60 (max)	0.5	2.13	0.22	0.5	1.688	175 lbs	35	2 - 6
	0.125	XC_6208									40	
	0.200	XC_2-6210									51	
	0.250	XC_2-6208									57	
	0.500	XC_4-6208									71	
16mm	4mm	XC_16x4M	1.40	2.60 (max)	0.5	2.13	0.22	0.5	1.688	175 lbs	47	2 - 6
	5mm	XC_2-16x2.5M									52	
	8mm	XC_4-16x2M									63	
	16mm	XC_7-16x2.3M									75	
	25mm	XC_5-16x5M									80	
	35mm	XC_7-16x5M									82	

† Patent No. 5839321

## Advanced Anti-Backlash Supernuts®

### XC 7500

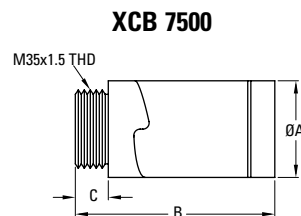
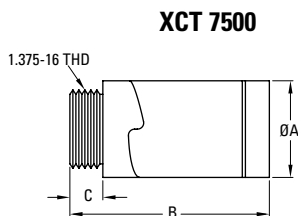

The XC 7500 utilizes the same patented† ActiveCAM™ as found in the XC 5000 model. Along with the very low drag torque and high axial stiffness advantages, the XC 7500 has greater load capacity.

Note: See Screw Section on page 35. Specify XCT, XCB or XCF when ordering, see drawings at right.

### Flange F75

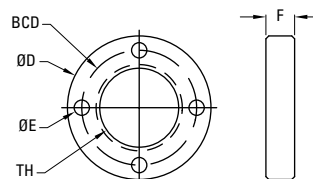

Dia.	Lead	Part No.	Nut Dimensions			Flange Dimensions (Optional)				Design Load	Efficiency %	Drag Torque oz-in
			A	B	C	D	E	F	BCD			
3/4"	0.100	XC_7510	1.63	2.9 (max)	0.5	2.5	0.27	0.50	2.00	250 lbs	31	3 - 10
	0.125	XC_7508									36	
	0.167	XC_7506									44	
	0.200	XC_7505									49	
	0.500	XC_5-7510									69	
	1.000	XC_8-7508									79	
	1.500	XC_12-7508									81	
	2.000	XC_10-7505									82	
20mm	4mm	XC_20x4M	1.63	2.9 (max)	0.5	2.5	0.27	0.50	2.00	250 lbs	41	3 - 10
	8mm	XC_2-20x4M									59	
	12mm	XC_3-20x4M									67	
	16mm	XC_4-20x4M									72	
	20mm	XC_5-20x4M									76	
	45mm	XC_9-20x5M									82	
	50mm	XC_10-20x5M									82	

† Patent No. 5839321

## Advanced Anti-Backlash Supernuts®

### XC 10000



The XC 10000 utilizes Thomson BSA's patented† ActiveCAM™ technology to provide very low drag torque, high axial stiffness and maximum wear life. This self compensating design produces excellent positional repeatability while insuring consistent performance for the long run.

Note: See Screw Section on page 35. Specify XCT, XCB or XCF when ordering, see drawings at right.

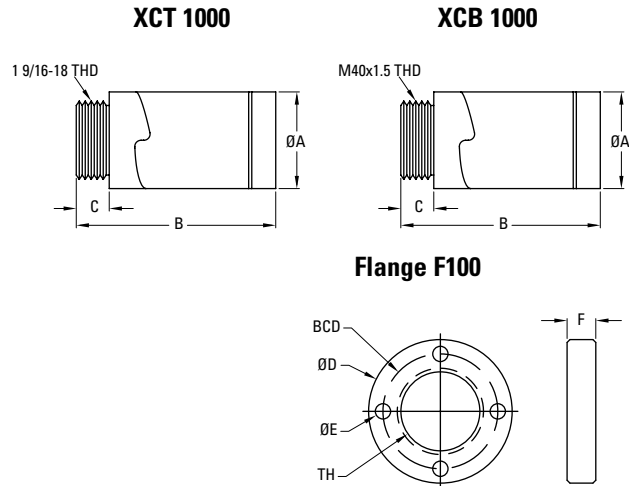

Dia.	Lead	Part No.	Nut Dimensions			Flange Dimensions (Optional)				Design Load	Efficiency %	Drag Torque oz-in
			A	B	C	D	E	F	BCD			
24mm	5mm	XC_24x5M	1.88	3.0 (max)	0.60	3.0	0.27	0.60	2.37	350 lbs	42	5-15
1"	0.100	XC_1010	1.88	3.0 (max)	0.60	3.0	0.27	0.60	2.37	350 lbs	25	5-15
	0.125	XC_1008									29	
	0.200	XC_1005									41	
	0.250	XC_2-1008									46	
	0.250	XC_1004									47	
	0.500	XC_5-1010									61	
1.000	XC_10-1010	74										

† Patent No. 5839321



## Advanced Anti-Backlash Supernuts®

### AFT

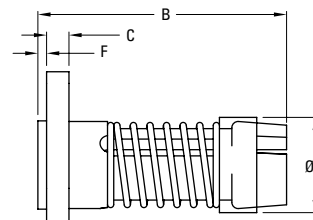
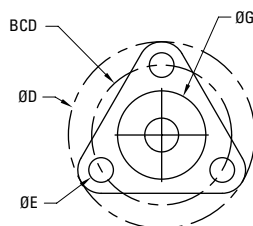

The low cost AFT Supernut is designed for light load OEM applications and offers smooth movement and low drag torque for axial loads up to 10 pounds. The AFT anti-backlash collar automatically adjusts for wear for the life of the nut.

Dia.	Lead	Part No.	Supernut® Dimensions								Design Load	Efficiency %	Drag Torque oz-in
			A	B	C	D	E	F	G	BCD			
3/8"	0.050	AFT3720	0.77	2.00	0.20	1.50	0.20	0.06	0.71	1.125	10 lbs	32	2 - 5
	0.063	AFT3716										36	
	2mm	AFT37x2M										42	
	0.083	AFT3712										44	
	0.100	AFT3710										49	
	0.125	AFT3708										53	
	0.167	AFT2-3712										60	
	0.200	AFT2-3710										65	
	0.250	AFT2-3708										68	
	0.300	AFT3-3710										73	
	0.375	AFT4-3711										75	
	0.500	AFT4-3708										79	
1.000	AFT5-3705	82											
1.200	AFT5-3704	82											
10mm	2mm	AFT10x2M	0.77	2.00	0.20	1.50	0.20	0.06	0.71	1.125	10 lbs	41	2 - 5
	3mm	AFT10x3M										53	
	4mm	AFT2-10x2M										59	
	5mm	AFT2-10x2.5M										64	
	6mm	AFT4-10x1.5M										67	
	10mm	AFT5-10x2M										76	
	12mm	AFT5-10x2.4M										78	
	20mm	AFT6-10x3.3M										81	
	35mm	AFT10-10x3.5M										81	
7/16"	0.125	AFT2-4316	0.77	2.00	0.20	1.50	0.20	0.06	0.71	1.125	10 lbs	55	2 - 5
	0.250	AFT2-4308										65	
	0.500	AFT4-4308										76	
1/2"	0.063	AFT5016	0.88	2.03	0.25	1.62	0.20	-	-	1.250	25 lbs	30	3 - 7
	0.100	AFT5010										41	
	4mm	AFT2-50x2M										52	
	0.200	AFT2-5010										57	
	0.250	AFT2-5008										62	
	0.500	AFT4-5008										75	
	0.800	AFT8-5010										80	
	1.000	AFT8-5008										81	

## Anti-Backlash Supernuts®

### SNAB Thread Mount Style

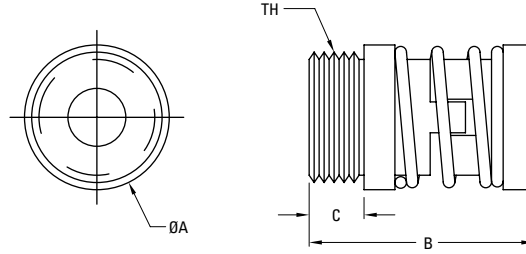

Our SNAB Model has the greatest design flexibility allowing anti-backlash assemblies through 1" diameters. All SNABs are made from our internally lubricated Acetal providing excellent lubricity and very low wear.

### SNAB\* - 3/16" to 3/8" (10mm) Diameter

#### Flanges

3/16" to 1/4"	F25
5/16" to 3/8" (10mm)	F37

Dimensions available on page 34.

Dia.	Lead	Part No.	Supernut® Dimensions					Preload Force (lbs)	Design Load	Max Static Load	Efficiency %	Drag Torque oz-in
			A	B (min)	B (max)	C	TH					
3/16"	0.050	SNAB1820X	0.625	1.125	1.250	0.187	9/16-18	1-3	10 lbs	150 lbs	49	2 - 4
	0.125	SNAB3-1824X									70	
6mm	1mm	SNAB6x1M	0.625	1.125	1.250	0.187	9/16-18	1-3	10 lbs	150 lbs	37	2 - 4
1/4"	0.031	SNAB2532X	0.625	1.125	1.250	0.187	9/16-18	1-3	25 lbs	225 lbs	30	2 - 4
	0.050	SNAB2520X									41	
	0.063	SNAB2516X									48	
	2mm	SNAB2-25x1M									53	
	3mm	SNAB3-25x1M									62	
	0.125	SNAB2-2516X									64	
	0.200	SNAB4-2520X									72	
	0.250	SNAB4-2516X									76	
5/16"	0.083	SNAB3112X	0.750	1.160	1.340	0.250	5/8-18	2-5	50 lbs	350 lbs	49	2 - 4
	0.167	SNAB2-3112X									65	
	0.250	SNAB2-3108X									72	
	0.500	SNAB4-3108X									80	
	1.000	SNAB8-3108X									81	
3/8"	0.050	SNAB3720X	0.750	1.160	1.340	0.250	5/8-18	2-5	70 lbs	350 lbs	32	2 - 4
	0.063	SNAB3716X									36	
	2mm	SNAB37x2M									42	
	0.083	SNAB3712X									44	
	0.100	SNAB710X									49	
	0.125	SNAB3708X									53	
	0.167	SNAB2-3712X									60	
	0.200	SNAB2-3710X									65	
	0.250	SNAB2-3708X									68	
	0.300	SNAB3-3710X									73	
	0.375	SNAB4-3711X									75	
	0.500	SNAB4-3708X									79	
	1.000	SNAB5-3705X	82									
1.200	SNAB5-3704X	82										
10mm	2mm	SNAB10x2M	0.750	1.160	1.340	0.250	5/8-18	2-5	70 lbs	350 lbs	41	2 - 4
	3mm	SNAB10x3M									53	
	4mm	SNAB2-10x2M									59	
	5mm	SNAB2-10x2.5M									64	
	6mm	SNAB4-10x1.5M									67	
	10mm	SNAB5-10x2M									76	
	12mm	SNAB5-10x2.4M									78	
	20mm	SNAB6-10x3.3M									81	
35mm	SNAB10-10x3.5M	81										

\* SNAB nuts are only as axially stiff as the spring force in one direction.

## Anti-Backlash Supernuts®

### SNAB Thread Mount Style

#### Flanges

7/16" to 5/8" (16mm)	F50
----------------------	-----

Dimensions available on page 34.

### SNAB\*

#### 7/16" to 5/8" (16mm) Diameter

Dia.	Lead	Part No.	Supernut® Dimensions					Preload Force (lbs)	Design Load	Max Static Load	Efficiency %	Drag Torque oz-in
			A	B (min)	B (max)	C	TH					
7/16"	0.125	SNAB2-4316X	1.000	1.700	2.000	0.375	15/16-16	4-9	100 lbs	500 lbs	55	3 - 5
	0.250	SNAB2-4308X									65	
	0.500	SNAB4-4308X									76	
12mm	3mm	SNAB12x3M	1.000	1.700	2.000	0.375	15/16-16	4-9	100 lbs	500 lbs	48	3 - 5
	4mm	SNAB2-12x2M									54	
	5mm	SNAB2-12x2.5M									59	
	6mm	SNAB3-12x2M									63	
	10mm	SNAB4-12x2.5M									73	
	15mm	SNAB6-12x2.5M									78	
	25mm	SNAB10-12x2.5M									82	
	45mm	SNAB15-12x3M									81	
1/2"	0.0625	SNAB5016	1.000	1.700	2.000	0.375	15/16-16	4-9	150 lbs	750 lbs	30	5 - 8
	0.100	SNAB5010X									41	
	4mm	SNAB2-50x2M									52	
	0.200	SNAB2-5010X									57	
	0.250	SNAB2-5008X									62	
	0.500	SNAB4-5008X									75	
	0.800	SNAB8-5010X									80	
	1.000	SNAB8-5008X									81	
	1.500	SNAB12-5008X									82	
5/8"	0.100	SNAB6210X	1.000	1.700	2.000	0.375	15/16-16	4-9	160 lbs	800 lbs	35	7 - 10
	0.125	SNAB6208X									40	
	0.200	SNAB2-6210X									51	
	0.250	SNAB2-6208X									57	
	0.500	SNAB4-6208X									71	
16mm	4mm	SNAB16x4M	1.000	1.700	2.000	0.375	15/16-16	4-9	160 lbs	800 lbs	47	7 - 10
	5mm	SNAB2-16x2.5M									52	
	8mm	SNAB4-16x2M									63	
	16mm	SNAB7-16x2.3M									75	
	25mm	SNAB5-16x5M									80	
	35mm	SNAB7-16x5M									82	

\* SNAB nuts are only as axially stiff as the spring force in one direction.

## Anti-Backlash Supernuts®

### SNAB Thread Mount Style

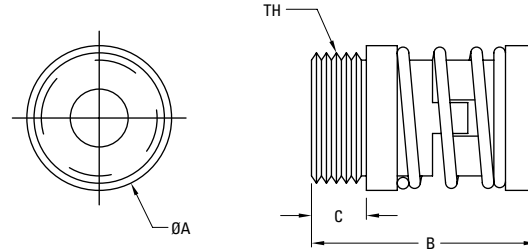

#### Flanges

3/4" to 1"	F100
------------	------

Dimensions available on page 34.

### SNAB\* 3/4" to 1" Diameter

Dia.	Lead	Part No.	Supernut® Dimensions					Preload Force (lbs)	Design Load	Max Static Load	Efficiency %	Drag Torque oz-in
			A	B (min)	B (max)	C	TH					
3/4"	0.100	SNAB7510X	1.750	2.500	3.000	0.600	1-9/16 - 18	10-20	300 lbs	1500 lbs	31	15 - 20
	0.125	SNAB7508X									36	
	0.167	SNAB7506X									44	
	0.200	SNAB7505X									49	
	0.500	SNAB5-7510X									69	
	1.000	SNAB8-7508X									79	
	1.500	SNAB12-7508X									81	
	2.000	SNAB10-7505X									82	
20mm	4mm	SNAB20x4M	1.750	2.500	3.000	0.600	1-9/16 - 18	10-20	300 lbs	1500 lbs	41	15 - 20
	8mm	SNAB2-20x4M									59	
	12mm	SNAB3-20x4M									67	
	16mm	SNAB4-20x4M									72	
	20mm	SNAB5-20x4M									76	
	45mm	SNAB9-20x5M									82	
50mm	SNAB10-20x5M	82										
24mm	5mm	SNAB24x5M	1.750	2.500	3.000	0.600	1-9/16 - 18	10-20	300 lbs	1500 lbs	42	15 - 20
1"	0.100	SNAB1010X	1.750	2.500	3.000	0.600	1-9/16 - 18	10-20	400 lbs	2000 lbs	25	15 - 20
	0.125	SNAB1008X									29	
	0.200	SNAB1005X									41	
	0.250	SNAB2-1008X									46	
	0.250	SNAB1004X									47	
	0.500	SNAB5-1010X									61	
	1.000	SNAB10-1010X									74	

\* SNAB nuts are only as axially stiff as the spring force in one direction.

## Flange Mount Supernuts®

### MTS

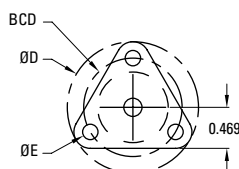

MTS 3/8" (10mm)  
Only

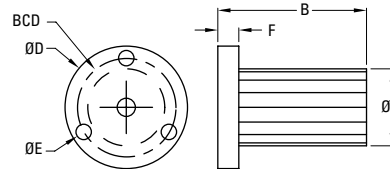

MTS 3/16" to 5/16"

### Integral Flange Mount

The MTS models provide the excellent lubricity and dimensional stability of our proprietary Acetal with the convenience of an integral flange.

### MTS - 3/16" to 3/8" (10mm) Diameter

Dia.	Lead	Part No.	Supernut® Dimensions						Design Load	Efficiency %	Drag Torque oz-in
			A	B	D	E	F	BCD			
3/16"	0.050	MTS1820	0.50	0.75	1.00	0.14	0.15	0.75	10 lbs	49	Free Wheeling
	0.125	MTS3-1824								70	
6mm	1mm	MTS6x1M	0.50	0.75	1.00	0.14	0.15	0.75	10 lbs	37	Free Wheeling
1/4"	0.031	MTS2532	0.50	0.75	1.00	0.14	0.15	0.75	25 lbs	30	Free Wheeling
	0.050	MTS2520								41	
	0.063	MTS2516								48	
	2mm	MTS2-25x1M								53	
	3mm	MTS3-25x1M								62	
	0.125	MTS2-2516								64	
	0.200	MTS4-2520								72	
	0.250	MTS4-2516								76	
5/16"	0.500	MTS7-2514	0.50	0.75	1.00	0.14	0.15	0.75	50 lbs	81	Free Wheeling
	0.083	MTS3112								49	
	0.167	MTS2-3112								65	
	0.250	MTS2-3108								72	
	0.500	MTS4-3108								80	
3/8"	1.000	MTS8-3108	0.71	1.50	1.5	0.20	0.20	1.125	60 lbs	81	Free Wheeling
	0.050	MTS3720								32	
	0.063	MTS3716								36	
	2mm	MTS37x2M								42	
	0.083	MTS3712								44	
	0.100	MTS3710								49	
	0.125	MTS3708								53	
	0.167	MTS2-3712								60	
	0.200	MTS2-3710								65	
	0.250	MTS2-3708								68	
	0.300	MTS3-3710								73	
	0.375	MTS4-3711								75	
	0.500	MTS4-3708								79	
10mm*	1.000	MTS5-3705	0.71	1.50	1.5	0.2	0.200	1.125	75 lbs	82	Free Wheeling
	1.200	MTS5-3704								82	
	2mm	MTS10x2M								41	
	3mm	MTS10x3M								53	
	4mm	MTS2-10x2M								59	
	5mm	MTS2-10x2.5M								64	
	6mm	MTS4-10x1.5M								67	
	10mm	MTS5-10x2M								76	
12mm	MTS5-10x2.4M	78									
20mm	MTS6-10x3.3M	81									
35mm	MTS10-10x3.5M	81									

\* 3/8" and 10mm with tri-flange

## Flange Mount Supernuts®

### MTS

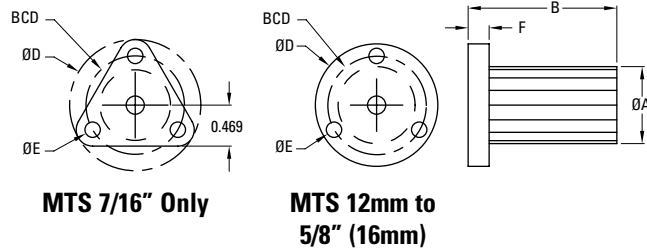

### MTS

#### 7/16" to 5/8" (16mm) Diameter

Dia.	Lead	Part No.	Supernut® Dimensions						Design Load	Efficiency %	Drag Torque oz-in
			A	B	D	E	F	BCD			
7/16"*	0.125	MTS2-4316	0.71	1.50	1.5	0.20	0.200	1.125	75 lbs	55	Free Wheeling
	0.250	MTS2-4308								65	
	0.500	MTS4-4308								76	
12mm	3mm	MTS12x3M	0.75	1.50	1.5	0.20	0.250	1.125	125 lbs	48	Free Wheeling
	4mm	MTS2-12x2M								54	
	5mm	MTS2-12x2.5M								59	
	6mm	MTS3-12x2M								63	
	10mm	MTS4-12x2.5M								73	
	15mm	MTS6-12x2.5M								78	
	25mm	MTS10-12x2.5M								82	
	45mm	MTS15-12x3M								81	
1/2"	0.0625	MTS5016	0.75	1.50	1.5	0.20	0.250	1.125	125 lbs	30	Free Wheeling
	0.100	MTS5010								41	
	4mm	MTS2-50x2M								52	
	0.200	MTS2-5010								57	
	0.250	MTS2-5008								62	
	0.500	MTS4-5008								75	
	0.800	MTS8-5010								80	
	1.000	MTS8-5008								81	
1.500	MTS12-6008	82									
5/8"	0.100	MTS6210	0.88	1.63	1.5	0.20	0.300	1.188	175 lbs	35	Free Wheeling
	0.125	MTS6208								40	
	0.200	MTS2-6210								51	
	0.250	MTS2-6208								57	
	0.500	MTS4-6208								71	
16mm	4mm	MTS16x4M	0.88	1.63	1.5	0.20	0.300	1.188	175 lbs	47	Free Wheeling
	5mm	MTS2-16x2.5M								52	
	8mm	MTS4-16x2M								63	
	16mm	MTS7-16x2.3M								75	
	25mm	MTS5-16x5M								80	
	35mm	MTS7-16x5M								82	

\* 7/16" with tri-flange



**Flange Mount Supernuts®**

MTS

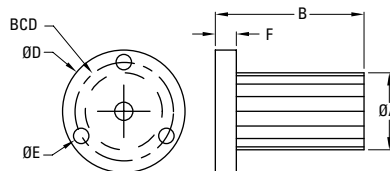

**MTS 3/4" (20mm)**

MTS

3/4" (20mm) Diameter

Dia.	Lead	Part No.	Supernut® Dimensions						Design Load	Efficiency %	Drag Torque oz-in
			A	B	D	E	F	BCD			
3/4"	0.100	MTS7510	1.125	1.75	2.0	0.20	0.300	1.438	275 lbs	31	Free Wheeling
	0.125	MTS7508								36	
	0.167	MTS7506								44	
	0.200	MTS7505								49	
	0.500	MTS5-7510								69	
	1.000	MTS8-7508								79	
	1.500	MTS12-7508								81	
20mm	2.000	MTS10-7505	1.125	1.75	2.0	0.20	0.300	1.438	275 lbs	82	Free Wheeling
	4mm	MTS20x4M								42	
	8mm	MTS2-20x4M								59	
	12mm	MTS3-20x4M								67	
	16mm	MTS4-20x4M								72	
	20mm	MTS5-20x4M								76	
	45mm	MTS9-20x5M								82	
50mm	MTS10-20x5M	82									

## Thread Mount Supernuts®

SN

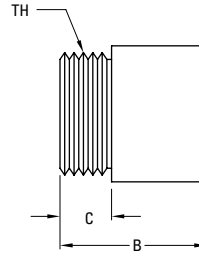
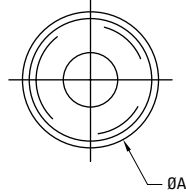

### Flanges

3/16" to 1/4"	F25
5/16" to 10mm	F37
7/16" to 16mm	F50
3/4" to 1"	F75
1-1/4"	F100
1-1/2"	R54-3

Dimensions available on page 34 or online.

### SN - 3/16" to 7/16" Diameter\*

Dia.	Lead	Part No.	Supernut® Dimensions				Design Load	Max. Static Load	Efficiency %	Flange
			A	B	C	TH				
3/16"	0.050	SN1820X	0.625	0.500	0.187	9/16-18	30 lbs	150 lbs	49	F25
	0.125	SN3-1824X							70	
6mm	1mm	SN6x1M	0.625	0.500	0.187	9/16-18	30 lbs	150 lbs	37	F25
1/4"	0.031	SN2532X	0.625	0.500	0.187	9/16-18	45 lbs	225 lbs	30	F25
	0.050	SN2520X							41	
	0.063	SN2516X							48	
	2mm	SN2-25x1M							53	
	3mm	SN3-25x1M							62	
	0.125	SN2-2516X							64	
	0.200	SN4-2520X							72	
	0.250	SN4-2516X							76	
5/16"	0.083	SN3112X	0.750	0.750	0.250	5/8-18	70 lbs	350 lbs	81	F37
	0.167	SN2-3112X							49	
	0.250	SN2-3108X							65	
	0.500	SN4-3108X							72	
	1.000	SN8-3108X							80	
3/8"	0.050	SN3720X	0.750	0.750	0.250	5/8-18	70 lbs	350 lbs	81	F37
	0.063	SN3716X							32	
	2mm	SN37x2M							36	
	0.083	SN3712X							42	
	0.100	SN3710X							44	
	0.125	SN3708X							49	
	0.167	SN2-3712X							53	
	0.200	SN2-3710X							60	
	0.250	SN2-3708X							65	
	0.300	SN3-3710X							68	
	0.375	SN4-3711X							73	
	0.500	SN4-3708X							75	
	1.000	SN5-3705X							79	
1.200	SN5-3704X	82								
10mm	2mm	SN10x2M	0.750	0.750	0.250	5/8-18	70 lbs	350 lbs	82	F37
	3mm	SN10x3M							41	
	4mm	SN2-10x2M							53	
	5mm	SN2-10x2.5M							59	
	6mm	SN4-10x1.5M							64	
	10mm	SN5-10x2M							67	
	12mm	SN5-10x2.4M							76	
	20mm	SN6-10x3.3M							78	
35mm	SN10-10x3.5M	67								
7/16"	0.125	SN2-4316X	1.000	1.000	0.375	15/16-16	100 lbs	500 lbs	81	F50
	0.250	SN2-4308X							55	
	0.500	SN4-4308X							65	
									76	

\* For all sizes shown on this page Drag Torque = Free Wheeling

## Thread Mount Supernuts®

SN

SN

1/2" (12mm) to 5/8" (16mm) Diameter\*

Dia.	Lead	Part No.	Supernut® Dimensions				Design Load	Max. Static Load	Efficiency %	Flange
			A	B	C	TH				
12mm	3mm	SN12x3M	1.000	1.000	0.375	15/16-16	100 lbs	500 lbs	48	F50
	4mm	SN2-12x2M							54	
	5mm	SN2-12x2.5M							59	
	6mm	SN3-12x2M							63	
	10mm	SN4-12x2.5M							73	
	15mm	SN6-12x2.5M							78	
	25mm	SN10-12x2.5M							82	
	45mm	SN15-12x3M							81	
1/2"	0.0625	SN5016X	1.000	1.000	0.375	15/16-16	150 lbs	750 lbs	30	F50
	0.100	SN5010X							41	
	4mm	SN2-50x2M							52	
	0.200	SN2-5010X							57	
	0.250	SN2-5008X							62	
	0.500	SN4-5008X							75	
	0.800	SN8-5010X							80	
	1.000	SN8-5008X							81	
1.500	SN12-5008X	82								
5/8"	0.100	SN6210X	1.000	1.000	0.375	15/16-16	160 lbs	800 lbs	35	F50
	0.125	SN6208X							40	
	0.200	SN2-6210X							51	
	0.250	SN2-6208X							57	
	0.500	SN4-6208X							71	
16mm	4mm	SN16x4M	1.000	1.000	0.375	15/16-16	160 lbs	800 lbs	47	F50
	5mm	SN2-16x2.5M							52	
	8mm	SN4-16x2M							63	
	16mm	SN7-16x2.3M							75	
	25mm	SN5-16x5M							80	
	35mm	SN7-16x5M							82	

\* For all sizes shown on this page Drag Torque = Free Wheeling

## Thread Mount Supernuts®

SN

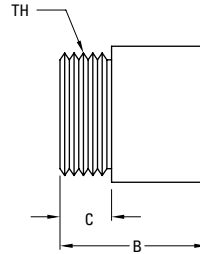
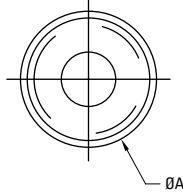

### Flanges

3/16" to 1/4"	F25
5/16" to 10mm	F37
7/16" to 16mm	F50
3/4" to 1"	F75
1-1/4"	F100
1-1/2"	R54-3

Dimensions available on page 34 or online.

SN  
 3/4" to 1 1/2" Diameter\*

Dia.	Lead	Part No.	Supernut® Dimensions				Design Load	Max. Static Load	Efficiency %	Flange
			A	B	C	TH				
3/4"	0.100	SN7510X	1.500	1.500	0.500	1 3/8-16	300 lbs	1500 lbs	31	F75
	0.125	SN7508X							36	
	0.167	SN7506X							44	
	0.200	SN7505X							49	
	0.500	SN5-7510X							69	
	1.000	SN8-7508X							79	
	1.500	SN12-7508X							81	
	2.000	SN10-7505X							82	
20mm	4mm	SN20x4M	1.500	1.500	0.500	1 3/8-16	300 lbs	1500 lbs	41	F75
	8mm	SN2-20x4M							59	
	12mm	SN3-20x4M							67	
	16mm	SN4-20x4M							72	
	20mm	SN5-20x4M							76	
	45mm	SN9-20x5M							82	
	50mm	SN10-20x5M							82	
24mm	5mm	SN24x5M	1.500	1.500	0.500	1 3/8-16	300 lbs	1500 lbs	42	F75
1"	0.100	SN1010X	1.500	1.500	0.500	1 3/8-16	400 lbs	2000 lbs	25	F75
	0.125	SN1008X							29	
	0.200	SN1005X							41	
	0.250	SN2-1008X							46	
	0.250	SN1004X							47	
	0.500	SN5-1010X							61	
	1.000	SN10-1010X							74	
1 1/4"	0.200	SN1205X	2.000	2.000	0.600	1 9/16-18	400 lbs	2000 lbs	35	F100
	0.200	SN2-1210X							35	
	0.250	SN1204X							41	
1 1/2"	0.200	SN1505X	2.000	2.500	0.530	1.967-18	400 lbs	2000 lbs	31	R54-3
	0.250	SN1504X							36	
	0.375	SN1503X							47	
	0.500	SN2-1504X							52	

\* For all sizes shown on this page Drag Torque = Free Wheeling

## Metric Thread Mount Supernuts®

SB

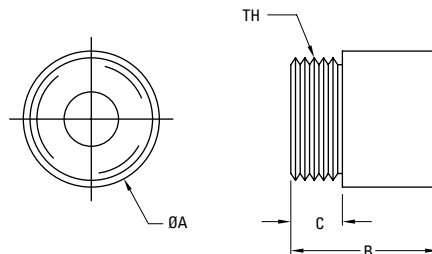

Our classic Supernut is now available with metric mounting thread. Offered with our metric screw line sizes 10mm through 24mm. The nut color is black to easily differentiate it from the SN nut (see p. 28)

SB

10mm to 24mm) Diameter\*

Dia.	Lead	Part No.	Supernut® Dimensions				Design Load lb (N)	Max. Static Load lb (N)	Efficiency %
			A in (mm)	B in (mm)	C in (mm)	TH			
10mm	2mm	SB10x2M	0.750 (19.1)	0.750 (19.1)	0.250 (6.5)	M16 x 1.5	70 (310)	350 (1550)	42
	3mm	SB10x3M							53
	4mm	SB2-10x2M							59
	5mm	SB2-10x2.5M							64
	6mm	SB4-10x1.5M							66
	10mm	SB5-10x2M							76
	12mm	SB5-10x2.4M							78
	20mm	SB6-10x3.3M							81
12mm	35mm	SB10-10x3.5M	81						
	3mm	SB12x3M	1.000 (25.4)	1.000 (25.4)	0.375 (9.5)	M22 x 1.5	100 (445)	500 (2225)	48
	4mm	SB2-12x2M							54
	5mm	SB2-12x2.5M							59
	6mm	SB3-12x2M							63
	10mm	SB4-12x2.5M							73
	15mm	SB6-12x2.5M							78
	25mm	SB10-12x2.5M							82
45mm	SB15-12x3M	81							
16mm	4mm	SB16x4M	1.000 (25.4)	1.000 (25.4)	0.375 (9.5)	M22 x 1.5	160 (710)	800 (3560)	48
	5mm	SB2-16x2.5M							52
	8mm	SB4-16x2M							63
	16mm	SB7-16x2.3M							75
	25mm	SB5-16x5M							80
20mm	35mm	SB7-16x5M	82						
	4mm	SB20x4M	1.500 (38.1)	1.500 (38.1)	0.500 (12.7)	M35 x 1.5	300 (1335)	1500 (6675)	42
	8mm	SB2-20x4M							59
	12mm	SB3-20x4M							67
	16mm	SB4-20x4M							72
	20mm	SB5-20x4M							76
	45mm	SB9-20x5M							82
50mm	SB10-20x5M	82							
24mm	5mm	SB24x5M	1.500 (38.1)	1.500 (38.1)	0.500 (12.7)	M35 x 1.5	300 (1335)	1500 (6675)	42

\* For all sizes shown on this page Drag Torque = Free Wheeling

## Thread Mount Bronze Nuts

For Acme Screws

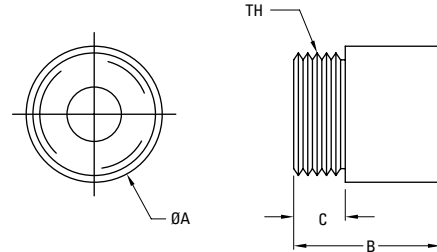

For standard bronze nuts, Thomson BSA uses SAE 660 bearing bronze which provides excellent load carrying ability, good wear resistance and is less susceptible to damage from impact and shock loading. Custom bronzes can be selected if required.

### Material Properties

Maximum Temperature	Friction Coefficient	Material*	Tensile Strength
max. 250°F	0.2 to 0.3	SAE 660	35,000 psi

\* Other materials available on a custom basis.

### 1/4" to 5/8" Diameter

Dia.	Lead	Nut Part No. for R.H. Screws	Nut Part No. for L.H. Screws	Bronze Nut Dimensions				Fits Flange No.	Design Load†	Maximum Static Load	Torque to Raise 1 Pound (in-oz)
				A	B	C	TH				
1/4"	.050	BN2520	BN2520L	0.625	0.625	0.187	9/16-18	F25	110 lbs	550 lbs	.41
	.0625	BN2516	—								.43
	.250	BN4-2516	—								1.00
3/8"	.0625	BN3716	—	0.750	0.750	0.250	5/8-18	F37	300 lbs	1,500 lbs	.61
	.083	BN3712	BN3712L								.64
	.100	BN3710	BN3710L								.67
	.125	BN3708S	—								.76
	.167	BN2-3712S	—								.86
1/2"	.100	BN5010	BN5010L	1.00	1.00	0.375	15/16-16	F50	620 lbs	3,100 lbs	.83
	.200	BN2-5010	—								1.10
5/8"	.100	BN6210	BN6210L	1.00	1.00	0.375	15/16-16	F50	860 lbs	4,300 lbs	.99
	.125	BN6208S	—								1.06
	.200	BN2-6210	—								1.26

† Load ratings based on using Thomson BSA grease. See page 225.



## Thread Mount Bronze Nuts

For Acme Screws

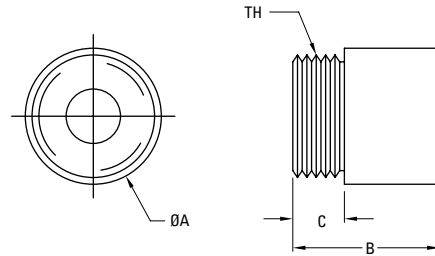

3/4" to 3" Diameter

Dia.	Lead	Nut Part No. for R.H. Screws	Nut Part No. for L.H. Screws	Bronze Nut Dimensions				Fits Flange No.	Design Load†	Maximum Static Load	Torque to Raise 1 Pound (in-oz)
				A	B	C	TH				
3/4"	.100	BN7510	BN7510L	1.50	1.50	0.500	1-3/8 - 16	F75	1,500 lbs	7,500 lbs	1.15
	.125	BN7508	—								1.21
	.167	BN7506	BN7506L								1.28
	.200	BN7505	BN7505L								1.35
1"	.100	BN1010	—	1.50	1.50	0.500	1-3/8 - 16	F75	1,900 lbs	9,500 lbs	1.47
	.125	BN1008	—								1.52
	.200	BN1005	—								1.67
	.250	BN1004	—								1.76
	.500	BN5-1010	—								2.55
	1.000	BN10-1010	—								3.91
1-1/4"	.200	BN1205*	—	1.75	1.75	0.625	1-9/16 - 18	R1004-3	3,000 lbs	15,000 lbs	1.99
	.250	BN1204*	—								2.09
1-1/2"	.200	BN1505*	—	2.25	2.25	0.530	1.967-18	R54-3	4,600 lbs	23,000 lbs	2.31
	.250	BN1504*	—								2.41
	.375	BN1503*	—								2.56
	.500	BN2-1504*	—								3.08
2"	.250	BN2004*	—	2.75	3.50	0.780	2.548-18	R50-3	8,000 lbs	40,000 lbs	3.04
2-1/4"	.250	BN2204*	—	3.37	3.00	1.56	3.137-12	R2202-3	12,800 lbs	64,000 lbs	3.70
2-1/2"	.250	BN2504*	—	3.37	3.00	1.56	3.137-12	R2202-3	16,000 lbs	80,000 lbs	3.90
2-3/4"	.250	BN2704*	—	4.00	4.00	1.75	3.625-12	R2501-3	20,000 lbs	100,000 lbs	4.20
3"	.250	BN3004*	—	4.00	4.00	1.75	3.625-12	R2501-3	23,000 lbs	115,000 lbs	4.50

† Load ratings based on using Thomson BSA grease. See page 225.

\* Non-stock item

## Standard Mounting Flanges

For Bronze Nuts and Supernuts®

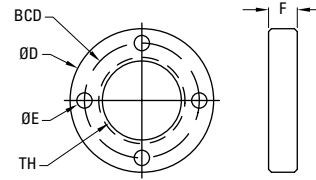

These mounting flanges are designed for easy mounting when fixed to a bronze nut or Supernut®.

## Aluminum (6061-T6) Flanges for Bronze Nuts and Supernuts®

Part No.	Flange Dimensions				
	D	E	F	BCD	TH
F25	1.25	0.140 (4X)	0.187	1.00	9/16 - 18
F37	1.60	0.177 (4X)	0.250	1.24	5/8 - 18
F50	2.00	0.266 (4X)	0.375	1.50	15/16 - 16
F75	2.50	0.266 (4X)	0.500	2.00	1-3/8 - 16
F100	3.00	0.266 (4X)	0.600	2.37	1-9/16 - 18

Aluminum flanges do not have a set screw which could deform the Supernut® and possibly cause binding. Aluminum flanges should be pinned or bonded to Supernuts® to prevent unwanted disassembly during operation.

### Lead Screws

Lead Screws — 3/16" to 3/8" Diameter



Nominal Major Diameter	Lead	Precision Prefix	Standard Prefix	BSA Part No.	Avail in Left Hand	Material	Root Diameter	Recommended Bearing
3/16"	0.050	SPR	SRA	1820	L	Stainless Steel	0.12	N/A
	0.125			3-1824			0.13	
6mm	1mm	SPR	SRA	6x1M	L	Stainless Steel	0.18	4mm
1/4"	0.031	SPR	SRA	2532	L	Stainless Steel	0.21	4mm
	0.050			2520	L		0.19	
	0.063			2516	L		0.17	
	2mm			2-25x1M			0.19	
	3mm			3-25x1M			0.19	
	0.125			2-2516			0.17	
	0.200			4-2520			.018	
	0.250			4-2516			0.17	
	0.500	N/A		7-2514		0.16		
5/16"	0.083	SPR	SRA	3112	L	Stainless Steel	0.22	4mm
	0.167			2-3112			0.20	
	0.250			2-3108S			0.22	
	0.500			4-3108S			0.21	
	1.000		8-3108		0.23			
3/8"	0.0500	SPR	SRA	3720	L	Stainless Steel	0.30	4mm
	0.0625			3716	L		0.30	
	2mm			37x2M	L		0.28	
	0.083			3712	L		0.28	
	0.100			3710	L		0.26	
	0.125			3708S	L		0.29	
	0.167			2-3712S			0.31	
	0.200			2-3710			0.26	
	0.250			2-3708S	L		0.29	
	0.300			3-3710			0.25	
	0.375			4-3711	L		0.27	
	0.500			4-3708S	L		0.27	
	1.00			5-3705			0.24	
	1.20			5-3704			0.24	
			N/A					

## Lead Screws

Lead Screws — 7/16" (10mm) to 5/8" (16mm) Diameter

Nominal Major Diameter	Lead	Precision Prefix	Standard Prefix	BSA Part No.	Avail in Left Hand	Material	Root Diameter	Recommended Bearing
10mm	2mm	SPT	SRT	10x2M	L	Stainless Steel	0.31	4mm
	3mm			10x3M	L		0.25	
	4mm			2-10x2M			0.29	
	5mm	SPR	SRA	2-10x2.5M			0.27	
	6mm			4-10x1.5M			0.31	
	10mm			5-10x2M			0.29	
	12mm			5-10x2.4M			.029	
	20mm			6-10x3.3M			0.30	
	35mm	N/A		10-10x3.5M			0.29	
7/16"	0.125	SPR	SRA	2-4316		Stainless Steel	0.35	6mm
	0.250			2-4308S			0.36	
	0.500			4-4308S			0.33	
12mm	3mm	SPT	SRT	12x3M		Stainless Steel	0.31	6mm
	4mm	SPR	SRA	2-12x2M			0.36	
	5mm	SPT	SRT	2-12x2.5M			0.35	
	6mm	SPR	SRA	3-12x2M			0.35	
	10mm	SPT	SRT	4-12x2.5M			0.35	
	15mm	SPR	SRA	6-12x2.5M			0.34	
	25mm	—	SRA	10-12x2.5M			0.36	
	45mm	—	SRA	15-12x3M			0.37	
1/2"	0.0625	SPR	SRA	5016		Stainless Steel	0.41	6mm
	0.100			5010	L		0.37	
	4mm			2-50x2M			0.39	
	0.200			2-5010			0.39	
	0.250			2-5008			0.38	
	0.500	4-5008			0.36			
	0.800	N/A		8-5010			0.37	
	1.000			8-5008			0.39	
	1.500			12-5008			0.39	
5/8"	0.100	SPR	SRA	6210	L	Stainless Steel	0.52	8 to 10mm
	0.125			6208S	L		0.52	
	0.200	SPR		2-6210	L		0.52	
	0.250			2-6208S			0.52	
	0.500			4-6208			0.48	
16mm	4mm	SPT	SRT	16x4M	L	Stainless Steel	0.45	8 to 10mm
	5mm	SPR	SRA	2-16x2.5M			0.48	
	8mm			4-16x2M			0.51	
	16mm			7-16x2.3M			0.49	
	25mm	N/A		5-16x5M			0.45	
	35mm			7-16x5M			0.48	

### Lead Screws

Lead Screws — 3/4" (24mm) to 3" Diameter

Nominal Major Diameter	Lead	Precision Prefix	Standard Prefix	BSA Part No.	Avail in Left Hand	Material	Root Diameter	Recommended Bearing
3/4"	0.100	SPR	SRA	7510	L	Stainless Steel	0.63	12mm
	0.125			7508	L		0.61	
	1.500	N/A		12-7508			0.62	
	0.167	SPR		7506	L		0.56	
	0.200			7505	L		0.53	
	0.500	N/A		5-7510			0.62	
	1.000			8-7508			0.61	
	2.000			10-7505†	L		0.59	
20mm	4mm	SPT	SRT	20x4M	L	Stainless Steel	0.61	12mm
	8mm	SPR	SRA	2-20x4M			0.58	
	12mm			3-20x4M			0.59	
	16mm			4-20x4M			0.59	
	20mm	–		5-20x4M			0.59	
	45mm	–		9-20x5M			0.62	
	50mm			10-20x5M			0.65	
24mm	5mm	SPT		SRT	24x5M	L	Stainless Steel	0.73
1"	0.100	SPR	SRA	1010	L	Stainless Steel	0.88	12 to 20mm
	0.125			1008	L		0.86	
	0.200			1005	L		0.78	
	0.250	N/A	RA	1004	L	Carbon Steel	0.72	12 to 15mm
	0.250	SPR	SRA	2-1008		Stainless Steel	0.84	12 to 20mm
	0.500	N/A		5-1010			0.88	
	1.000			10-1010			0.88	
1-1/4"	0.200	N/A	RA	1205	L	Low Carbon Steel	1.03	20mm
	0.200		SRA	1205	L	Stainless Steel	1.01	
	0.200			2-1210			1.11	
	0.250		RA	1204	L	Low Carbon Steel	0.98	
1-1/2"	0.200	N/A	RA	1505	L	Low Carbon Steel	1.28	25mm
	0.250			1504	L		1.23	
	0.375			1503			1.11	
	0.500			2-1504			1.23	
2"	0.250	N/A	RA	2004	L	Low Carbon Steel	1.73	*
2-1/4"	0.250	N/A	RA	2204	L	Low Carbon Steel	1.98	*
2-1/2"	0.250	N/A	RA	2504	L	Low Carbon Steel	2.23	*
2-3/4"	0.250	N/A	RA	2704	L	Low Carbon Steel	2.48	*
3"	0.250	N/A	RA	3004	L	Low Carbon Steel	2.73	*

† Nominal O.D. is .734"

## V-Thread Screws

Burnished Finish 303 Stainless Steel

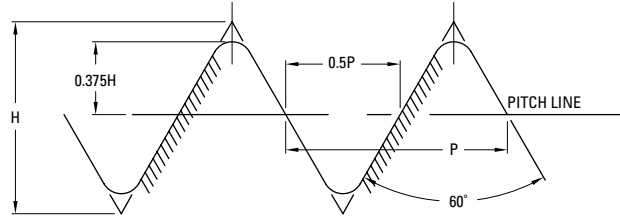
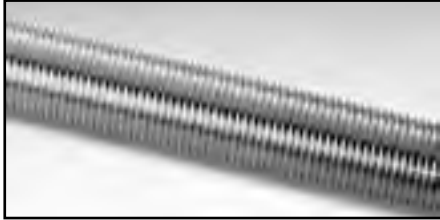

- Some sizes available in 1018 Steel
- Matching Supernuts and Left Hand Screws on special request
- Lead Accuracy is .015 in/ft

Diameter	Lead	Size	Part No.	Recommended Bearing
6mm	1mm	6 x 1	SV6x1	4mm
1/4"	0.0125	1/4-80	SV2580	4mm
	0.0208	1/4-48	SV2548	
	0.0250	1/4-40	SV2540	
	0.0278	1/4-36	SV2536	
	0.0313	1/4-32	SV2532	
	0.0357	1/4-28	SV2528	
	0.0417	1/4-24	SV2524	
	0.0500	1/4-20	SV2520	
5/16"	0.0130	5/16-80	SV3180	4mm
	0.0420	5/16-24	SV3124	
3/8"	0.013	3/8-80	SV3780	4 to 6mm
	0.0250	3/8-40	SV3740	
	0.0313	3/8-32	SV3732	
	0.0400	3/8-25	SV3725	
	0.0417	3/8-24	SV3724	
	0.0500	3/8-20	SV3720	
	0.0625	3/8-16	SV3716	
	0.0833	3/8-12	SV3712	
7/16"	0.0500	7/16-20	SV4320	6mm
1/2"	0.0130	1/2-80	SV5080	6 to 8mm
	0.0250	1/2-40	SV5040	
	0.0333	1/2-30	SV5030	
	0.0500	1/2-20	SV5020	
	0.0625	1/2-16	SV5016	
	0.0769	1/2-13	SV5013	

# Ball Screws — Inch Series



Ball Screws

## Table of Contents

<b>Description</b>	<b>Page</b>
Product Overview .....	40
Precision Rolled Ball Screws — Inch Series.....	44
Visual Product Reference — Precision Rolled Ball Screws — Inch Series .....	89
Precision Plus Ball Screws — Inch Series .....	99

Need a quote or have a question about an application?  
Contact us in North America at:

Phone: 540-633-3549

Fax: 540-639-4162

Email: [thomson@thomsonlinear.com](mailto:thomson@thomsonlinear.com)

## Ball Screws Product Overview

### Thomson Advantages

Ball screws are not all alike. Differences in design, quality, materials, manufacturing, and application support are all factors that affect the performance and extend the life of your ball screw. That's why it's important to select your ball screw — and ball screw supplier — very carefully.

#### **Design: Optimal solution for your application needs**

The Thomson engineering team has painstakingly evaluated the breadth of ball screw products from BSA, Warner Linear, and Thomson Industries and integrated them into a single, comprehensive, product offering. Our new line of ball screws come in a full range of diameters, leads, and ball nut configurations, in either preloaded or non-preloaded types, all in industry-standard envelopes. They provide dependable accuracy and repeatability at an economical price.

#### **Quality: Reliability and consistent performance**

At Thomson, we pride ourselves in consistently providing high quality ball screws. Our background in flight critical aerospace and defense applications uniquely positions us to provide the highest levels of quality across all our ball screw products. Our fully equipped engineering laboratory performs qualification testing for mechanical performance, environmental effects, and structural integrity. Your ball screw is inspected every step of the way to ensure top quality and performance. The result, Thomson ball screws perform the way you expect them to perform — no surprises, no problems.

#### **Materials: Just the right custom and standard offerings**

The materials used to manufacture ball screws are critical to their performance. Our in-house metallurgists control and verify that the materials used are of the highest quality. They can also select and recommend materials best suited to your particular application. We have years of experience working with a wide range of standard and non-standard materials. Put our experience and expertise to work for you!

#### **Manufacturing: Ensures consistent quality and delivery**

Thomson maintains the most modern and complete ball screw manufacturing facilities in the industry. In-house manufacturing capabilities include our proprietary heat treating and plating processes. Expert manufacturing using the most modern equipment available provides ball screws that set the standards for performance, precision, and travel life.

#### **Application Support: Over 70 years of experience at your disposal**

Working with Thomson is like having your own staff of ball screw design engineers able to address application concerns and recommend solutions. Thomson field sales and applications engineering personnel have more ball screw expertise than any other group in the industry. They are skilled at evaluating your requirements and designing assemblies that fit your needs.



**Catalog Standard  
 Ball Screws feature  
 a high luster polished  
 and oiled finish.**



## Inch Ball Screws Product Overview

### Precision Rolled Screws — Product Availability<sup>(1)</sup>, Accuracy and Axial Play

Screw Diameter	Accuracy	Max. Axial Backlash (Non-preloaded) <sup>(2)</sup>
0.187" to 4.000"	± .004 in/ft	0.002 to 0.015"

	Inch	Lead (in.)												
		0.050	0.062	0.125	0.200	0.250	0.413	0.473	0.500	0.660	1.000	1.500	1.875	2.000
Dia. (in.)	0.187	●	●											
	0.375			●										
	0.500				●				●					
	0.631				●						●			
	0.750				●				●					
	0.875				●									
	1.000					●			●		●			
	1.150				●									
	1.171						●							
	1.500						●		●	●	●		●	●
	2.000								●		●			
	2.250								●		●			
	2.500						●		●		●			
	3.000									●		●		
4.000										●				

### Precision Plus Screws — Product Availability<sup>(1)</sup>, Accuracy and Axial Play

Screw Diameter	Accuracy	Max. Axial Backlash
0.500" to 2.500"	± .0005 in/ft	0"

	Inch	Lead (in.)												
		0.050	0.062	0.125	0.200	0.250	0.413	0.473	0.500	0.660	1.000	1.500	1.875	2.000
Dia. (in.)	0.631				●									
	0.750				●									
	0.875				●									
	1.000				●	●								
	1.150				●									
	1.250				●				●					
	1.500				●	●			●					
	1.750				●									
	2.000				●									
	2.250								●					
	2.500						●							

(1) Additional sizes are available. See our comprehensive product reference section on page 89, or contact customer service for more details.

(2) Standard lash dependent on ball diameter. See page 219 as reference. Consult factory for special requirements.

## Precision Rolled Ball Screws Product Overview — Inch Series

### Standard Non-Preloaded Ball Nuts

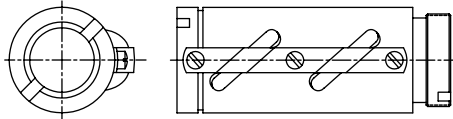

Standard Non-Preloaded Ball Nuts are a flexible, economical solution for use in industrial, transport grade applications. Both round and square models are available, with flange and wiper kits as accessories. Non-Preloaded Ball Nuts come standard with black-oxide coating (thin dense chrome is available upon request).

### Preloaded Ball Nuts

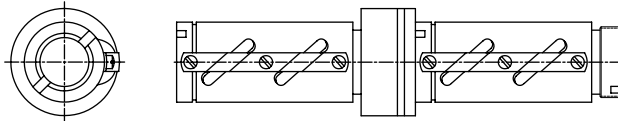

Preloaded Ball Nuts should be considered to eliminate backlash and increase system stiffness in applications where multi-directional positional accuracy and repeatability are required. Preloaded Ball Nuts consist of two non-preloaded ball nuts (round or square) joined by an adjustable preload package with springs. This design allows ease of setup and adjust of preload based on application requirements.

### Preloaded Ball Nuts with Integral Flange

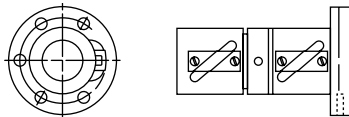

Preloaded Ball Nuts with Integral Flange provide higher-level positional accuracy and repeatability from a rolled screw assembly. These adjustable preload nuts feature precision ground internal threads, which enable smoother running, more consistent performance. The integral flange is held to high perpendicularity tolerances to ensure the load bearings are aligned to load to prevent unnecessary wear.

### Internal Return Ball Nuts

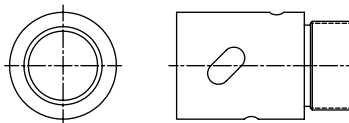

Internal Return Ball Nuts feature an internal ball recirculation system, which allows higher speeds, and lower noise in a compact envelope. Each nut includes an integrated wiper as standard. These ball nuts come standard "as machined" with corrosion protective film applied prior to shipment. Please note, a full line of internal return ball nuts are featured as part of our metric series ball screws.

### Cylindrical Ball Nuts

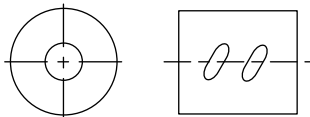

Cylindrical Ball Nuts are compact in size and ideal for constrained envelopes. These ball nuts come standard "as machined" with corrosion protective film applied prior to shipment. Please note, a full line of cylindrical ball nuts are featured as part of our metric series ball screws.

### High Capacity Ball Nuts

High Capacity Ball Nuts provide higher static and dynamic load capacities than our standard nuts. These ball nuts are typically longer than standard nuts, allowing for more balls in contact with the screw. High capacity nuts may also include larger balls than those found in standard ball nuts.

### High Speed Ball Nuts

High Speed Ball Nuts are designed to permit higher linear speeds in applications where critical speed of the ball nut (DN value) limits performance in an application. These ball nuts feature solid deflectors and reinforced ball return guides to allow smooth, reliable transition of balls entering and exiting the return system at high speeds.

## Precision Rolled Ball Screws Product Overview — Inch Series

### Tangential Ball Return

A unique Thomson feature which minimizes recirculated bearing ball deflection, for smoother and quieter operation. The tangential circuit consists of a pick-up deflector finger and modified return tube which allows the bearing balls to enter and exit the load carrying portion of the ball screw circuit in a straight path. Standard on ball bearing screws with up to 10,000 pound dynamic load capabilities.

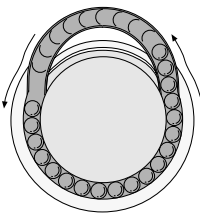

### Load Locking Spring

The load locking spring is a coil turned into the inactive portion of the nut and conforms to the ball tract. In normal operation, the spring is inactive and not in contact with the screw. In the event the ball bearings are lost from the nut, the load locking spring will not allow the load carrying nut to free-fall down the screw.

### End Journals and Bearing Supports

To assist the designer, standard end journals and bearing supports are included in this catalog. Ball screw assemblies, complete with end journals and bearing supports, may be ordered through a local Thomson distributor or directly from the factory.

Thomson welcomes the opportunity to custom machine end journals to unique customer designs.

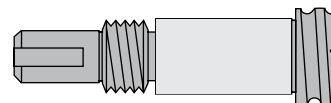

### Lube Holes

A standard 1/8-27 NPT tapped hole on ball nuts with a dynamic load capacity of 10,000 pounds or more provides easy access for continuing lubrication.

### Coating

Our catalog standard ball screws feature a high luster polished and oiled finish, which provides superior surface finish, smoother operation, and a high quality look and feel which is consistent across our entire product line. Additional ball screw coatings (thin dense chrome, black oxide, manganese phosphate) are available upon request.

### Wiper Kit

Wipers can increase the life and long-term performance of ball bearing screws by preventing most dirt and other foreign matter from entering the ball nut. Wipers are attached via two methods: Type A attaches directly to the ball nut body and flange; and Type B installs into the ends of the ball nut with easy-to-install snap rings kits. See our installation section on page 209 for more details.

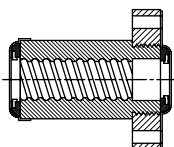

Type A

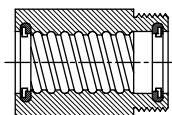

Type B

### Flanges

Standard flanges are offered for all ball nuts. Flanges provide an easy, low cost method to mount the load square and concentric to the ball screw.

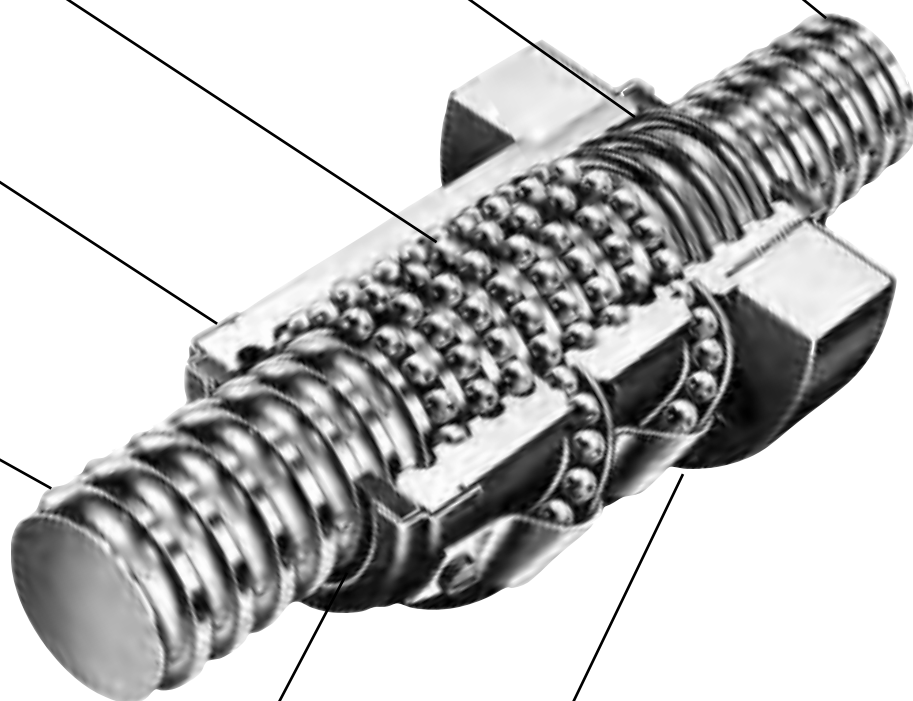

**0.187 x 0.050**

**Precision Rolled Ball Screws — Inch Series**

<b>Diameter x Lead (in.)</b>	0.187 x 0.050
<b>Lead Accuracy (in/ft)</b>	± 0.004
<b>Screw Weight (lbs/ft)</b>	0.1
<b>Screw Root Diameter (in.)</b>	0.14
<b>Nominal Ball Diameter (in.)</b>	0.039
<b>Number of Starts</b>	1

**Double Circuit, Cylindrical Ball Nut, Internal Return — Stainless Steel**

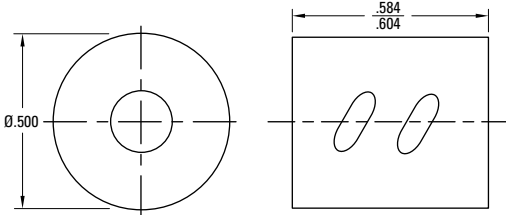

**Ball Screw Part Numbers**

<b>Thread Direction</b>	Right Hand	Left Hand	Right Hand
<b>Screw Material</b>	Alloy Steel	Alloy Steel	Stainless Steel
<b>Standard Length</b>			12"
<b>Maximum Length</b>			12"
<b>Part Number</b>			<b>7821634</b>

Ball screws can be cut to the length you require. Specify ball screw part number and overall length at time of order.

<b>Thread Direction</b>	Right Hand	Left Hand	Right Hand
<b>Nut Material</b>	Alloy Steel	Alloy Steel	Stainless Steel
<b>Dynamic Load (lbs)</b>			20
<b>Max. Static Load (lbs)</b>			75
<b>Torque to raise 1 lb (oz-in.)</b>			0.14
<b>Nut weight (lbs)</b>			0.005
<b>Ball Nut Part Number</b>			<b>7821609</b>
<b>Flange Part Number</b>			<b>N/A</b>
<b>Wiper Kit Part Number</b>			<b>N/A</b>

Note: Dimensional information for all End Journals and Bearing Supports is available on page 148. Information on required lubrication is on page 225.

## 0.187 x 0.062

## Precision Rolled Ball Screws — Inch Series

<b>Diameter x Lead (in.)</b>	0.187 x 0.062
<b>Lead Accuracy (in/ft)</b>	± 0.004
<b>Screw Weight (lbs/ft)</b>	0.1
<b>Screw Root Diameter (in.)</b>	0.14
<b>Nominal Ball Diameter (in.)</b>	0.039
<b>Number of Starts</b>	1

### Double Circuit, Cylindrical Ball Nut, Internal Return — Stainless Steel

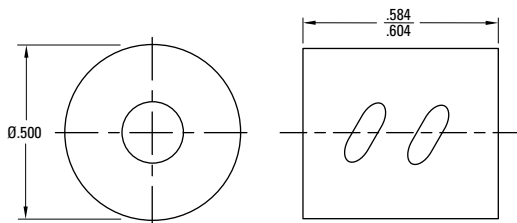

### Ball Screw Part Numbers

<b>Thread Direction</b>	Right Hand	Left Hand	Right Hand
<b>Screw Material</b>	Alloy Steel	Alloy Steel	Stainless Steel
<b>Standard Length</b>			12"
<b>Maximum Length</b>			12"
<b>Part Number</b>			<b>7821633</b>

Ball screws can be cut to the length you require. Specify ball screw part number and overall length at time of order.

<b>Thread Direction</b>	Right Hand	Left Hand	Right Hand
<b>Nut Material</b>	Alloy Steel	Alloy Steel	Stainless Steel
<b>Dynamic Load (lbs)</b>			20
<b>Max. Static Load (lbs)</b>			75
<b>Torque to raise 1 lb (oz-in.)</b>			0.18
<b>Nut weight (lbs)</b>			0.005
<b>Ball Nut Part Number</b>			<b>7821579</b>
<b>Flange Part Number</b>			<b>N/A</b>
<b>Wiper Kit Part Number</b>			<b>N/A</b>

Note: Dimensional information for all End Journals and Bearing Supports is available on page 148. Information on required lubrication is on page 225.

## 0.375 x 0.125

## Precision Rolled Ball Screws — Inch Series

<b>Diameter x Lead (in.)</b>	0.375 x 0.125
<b>Lead Accuracy (in/ft)</b>	± 0.004
<b>Screw Weight (lbs/ft)</b>	0.3
<b>Screw Root Diameter (in.)</b>	0.30
<b>Nominal Ball Diameter (in.)</b>	0.063
<b>Number of Starts</b>	1

### Ball Screw Part Numbers

Thread Direction	Right Hand	Left Hand	Right Hand
<b>Screw Material</b>	Alloy Steel	Alloy Steel	Stainless Steel
<b>Standard Length</b>	48"	48"	48"
<b>Maximum Length</b>	48"	48"	48"
<b>Part Number</b>	<b>5707538</b>	<b>5708532</b>	<b>5706540</b>

Ball screws can be cut to the length you require. Specify ball screw part number and overall length at time of order.

### Single Circuit, Round Ball Nut

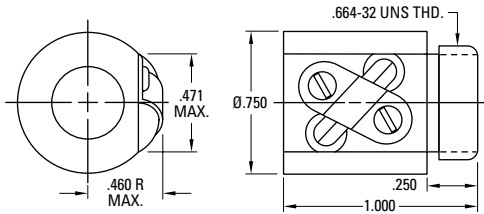

Direction	Right Hand	Left Hand	Right Hand
<b>Nut Material</b>	Alloy Steel	Alloy Steel	Stainless Steel
<b>Dynamic Load (lbs)</b>	136	136	24
<b>Max. Static Load (lbs)</b>	1415	1415	255
<b>Torque to raise 1 lb (oz-in.)</b>	0.35	0.35	0.35
<b>Nut weight (lbs)</b>	0.13	0.13	0.13
<b>Ball Nut Part Number</b>	<b>5709574</b>	<b>5709576</b>	<b>5709578</b>
<b>Flange Part Number</b>	<b>5706751</b>	<b>5706751</b>	<b>N/A</b>
<b>Wiper Kit Part Number</b>	<b>N/A</b>	<b>N/A</b>	<b>N/A</b>

### Flange Kit

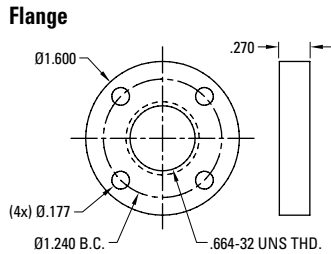

<b>Wiper Part Number</b>	<b>N/A</b>	
<b>Flange Part Number</b>	<b>5706751</b>	

Note: Dimensional information for all End Journals and Bearing Supports is available on page 148. Information on required lubrication is on page 225.

**0.375 x 0.125**

**Precision Rolled Ball Screws — Inch Series**

Diameter x Lead (in.)	0.375 x 0.125
Lead Accuracy (in/ft)	± 0.004
Screw Weight (lbs/ft)	0.3
Screw Root Diameter (in.)	0.31
Nominal Ball Diameter (in.)	0.078
Number of Starts	1

**Double Circuit, Round Ball Nut with Load Lock (11/16 - 24 V-Thread)**

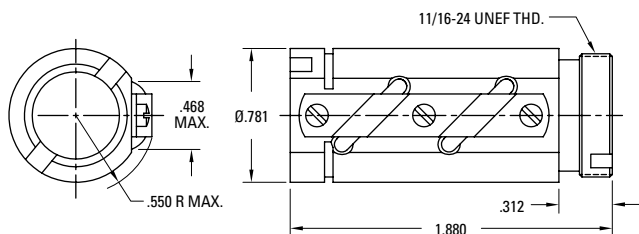

**Double Circuit, Round Ball Nut with Load Lock (.664 - 32 V-Thread)**

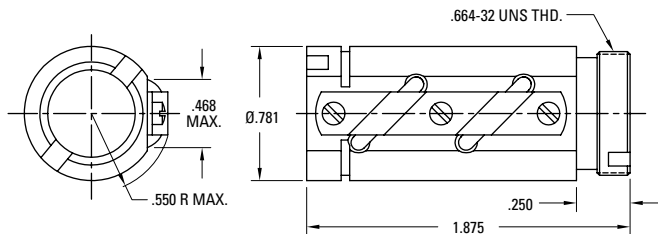

**Wiper and Flange Kits**

**Wiper**

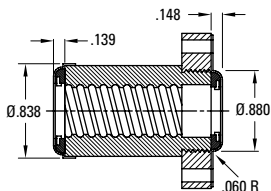

**Flange**

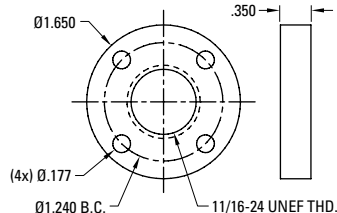

**Ball Screw Part Numbers**

Thread Direction	Right Hand	Left Hand	Right Hand
Screw Material	Alloy Steel	Alloy Steel	Stainless Steel
Standard Length	72"		
Maximum Length	72"		
Part Number	<b>190-9441</b>		

Ball screws can be cut to the length you require. Specify ball screw part number and overall length at time of order.

Thread Direction	Right Hand	Left Hand
Nut Material	Alloy Steel	
Dynamic Load (lbs)	500	
Max. Static Load (lbs)	4,250	
Torque to raise 1 lb (oz-in.)	0.35	
Nut weight (lbs)	0.16	
Ball Nut Part Number	<b>8103-448-003</b>	
Flange Part Number	<b>8103-448-002</b>	
Wiper Kit Part Number	<b>8103-101-002</b>	

Thread Direction	Right Hand	Left Hand
Nut Material	Alloy Steel	
Dynamic Load (lbs)	500	
Max. Static Load (lbs)	4,250	
Torque to raise 1 lb (oz-in.)	0.35	
Nut weight (lbs)	0.16	
Ball Nut Part Number	<b>8103-448-013</b>	
Flange Part Number	<b>N/A</b>	
Wiper Kit Part Number	<b>8103-101-002</b>	

Wiper Part Number	<b>8103-101-002</b>	
Flange Part Number	<b>8103-448-002</b>	

Note: Dimensional information for all End Journals and Bearing Supports is available on page 148. Information on required lubrication is on page 225.

**0.375 x 0.125**

**Precision Rolled Ball Screws — Inch Series**

<b>Diameter x Lead (in.)</b>	0.375 x 0.125
<b>Lead Accuracy (in/ft)</b>	± 0.004
<b>Screw Weight (lbs/ft)</b>	0.3
<b>Screw Root Diameter (in.)</b>	0.31
<b>Nominal Ball Diameter (in.)</b>	0.078
<b>Number of Starts</b>	1

**Ball Screw Part Numbers**

<b>Thread Direction</b>	Right Hand	Left Hand	Right Hand
<b>Screw Material</b>	Alloy Steel	Alloy Steel	Stainless Steel
<b>Standard Length</b>	31"		
<b>Maximum Length</b>	48"		
<b>Part Number</b>	<b>190-9452</b>		

Ball screws can be cut to the length you require. Specify ball screw part number and overall length at time of order.

**Single Circuit, Cylindrical Ball Nut**

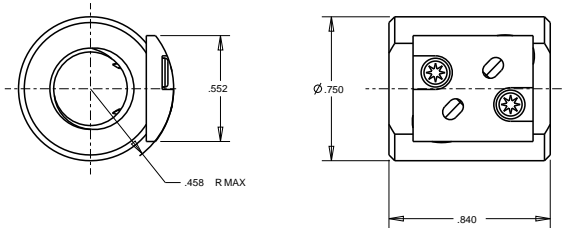

<b>Thread Direction</b>	Right Hand	Left Hand
<b>Nut Material</b>	Alloy Steel	
<b>Dynamic Load (lbs)</b>	170	
<b>Max. Static Load (lbs)</b>	1,600	
<b>Torque to raise 1 lb (oz-in.)</b>	0.35	
<b>Nut weight (lbs)</b>	0.13	
<b>Ball Nut Part Number</b>	<b>8103-448-017</b>	
<b>Flange Part Number</b>	N/A	
<b>Wiper Kit Part Number</b>	N/A	

**Single Circuit, Round Ball Nut**

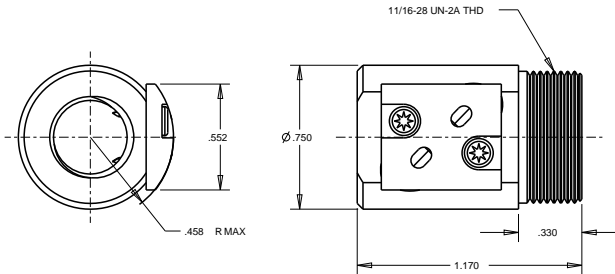

<b>Thread Direction</b>	Right Hand	Left Hand
<b>Nut Material</b>	Alloy Steel	
<b>Dynamic Load (lbs)</b>	170	
<b>Max. Static Load (lbs)</b>	1,600	
<b>Torque to raise 1 lb (oz-in.)</b>	0.35	
<b>Nut weight (lbs)</b>	0.13	
<b>Ball Nut Part Number</b>	<b>8103-448-018</b>	
<b>Flange Part Number</b>	N/A	
<b>Wiper Kit Part Number</b>	N/A	

**Wiper and Flange Kits**

<b>Wiper Part Number</b>	<b>8103-101-002</b>	
<b>Flange Part Number</b>	N/A	

**Wiper**

**Flange**

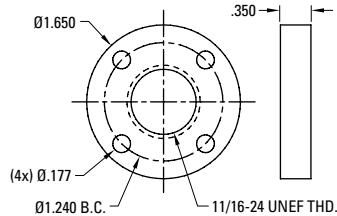
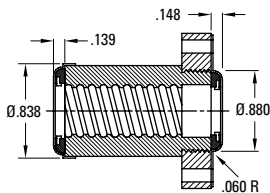

Note: Dimensional information for all End Journals and Bearing Supports is available on page 148. Information on required lubrication is on page 225.



## 0.500 x 0.200

## Precision Rolled Ball Screws — Inch Series

<b>Diameter x Lead (in.)</b>	0.500 x 0.200
<b>Lead Accuracy (in/ft)</b>	± 0.004
<b>Screw Weight (lbs/ft)</b>	0.7
<b>Screw Root Diameter (in.)</b>	0.41
<b>Nominal Ball Diameter (in.)</b>	0.125
<b>Number of Starts</b>	1

### Single Circuit, Round Ball Nut with Load Lock

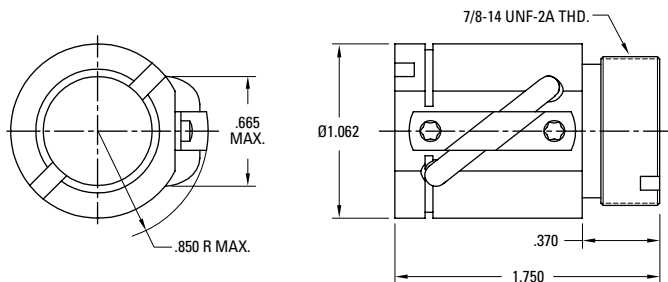

### Ball Screw Part Numbers

<b>Thread Direction</b>	Right Hand	Left Hand	Right Hand
<b>Screw Material</b>	Alloy Steel	Alloy Steel	Stainless Steel
<b>Standard Length</b>	72"		
<b>Maximum Length</b>	72"		
<b>Part Number</b>	<b>190-9097</b>		

Ball screws can be cut to the length you require. Specify ball screw part number and overall length at time of order.

<b>Thread Direction</b>	Right Hand	Left Hand
<b>Nut Material</b>	Alloy Steel	
<b>Dynamic Load (lbs)</b>	600	
<b>Max. Static Load (lbs)</b>	2,975	
<b>Torque to raise 1 lb (oz-in.)</b>	0.57	
<b>Nut weight (lbs)</b>	0.27	
<b>Ball Nut Part Number</b>	<b>8105-448-023</b>	
<b>Flange Part Number</b>	<b>N/A</b>	
<b>Wiper Kit Part Number</b>	<b>8105-101-002</b>	

# 0.500 x 0.200

# Precision Rolled Ball Screws — Inch Series

Diameter x Lead (in.)	0.500 x 0.200
Lead Accuracy (in/ft)	± 0.004
Screw Weight (lbs/ft)	0.7
Screw Root Diameter (in.)	0.41
Nominal Ball Diameter (in.)	0.125
Number of Starts	1

## Ball Screw Part Numbers

Thread Direction	Right Hand	Left Hand	Right Hand
Screw Material	Alloy Steel	Alloy Steel	Stainless Steel
Standard Length	72"		
Maximum Length	72"		
Part Number	<b>190-9097</b>		

Ball screws can be cut to the length you require. Specify ball screw part number and overall length at time of order.

## Double Circuit, Round Ball Nut with Load Lock

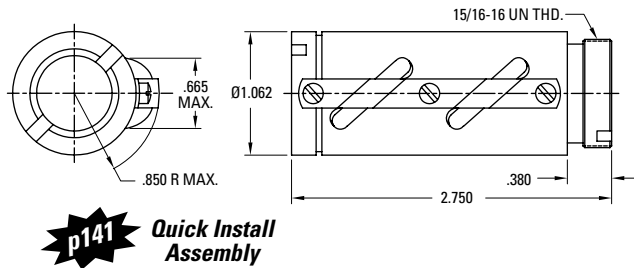

Thread Direction	Right Hand	Left Hand
Nut Material	Alloy Steel	
Dynamic Load (lbs)	1,200	
Max. Static Load (lbs)	9,430	
Torque to raise 1 lb (oz-in.)	0.57	
Nut weight (lbs)	0.55	
Ball Nut Part Number	<b>8105-448-013</b>	
Flange Part Number	<b>8105-448-002</b>	
Wiper Kit Part Number	<b>8105-101-002</b>	

## Preloaded, Double Circuit, Round Ball Nut with Load Lock

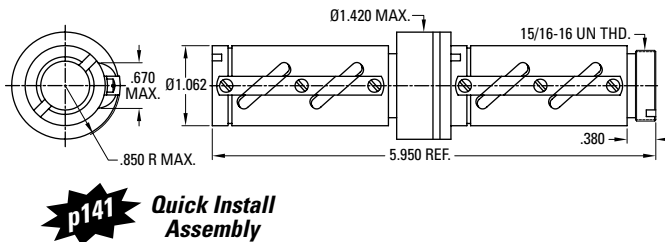

Thread Direction	Right Hand	Left Hand
Nut Material	Alloy Steel	
Dynamic Load (lbs)	1,200	
Max. Static Load (lbs)	9,430	
Torque to raise 1 lb (oz-in.)	0.57	
Nut weight (lbs)	1.30	
Ball Nut Part Number	<b>8105-448-008</b>	
Flange Part Number	<b>8105-448-002</b>	
Wiper Kit Part Number	<b>8105-101-002</b>	

## Wiper and Flange Kits

### Wiper

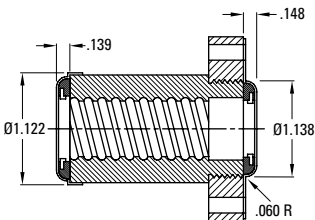

### Flange

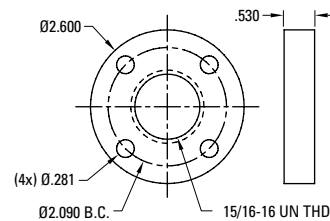

Wiper Part Number	<b>8105-101-002</b>	
Flange Part Number	<b>8105-448-002</b>	

Note: Dimensional information for all End Journals and Bearing Supports is available on page 148. Information on required lubrication is on page 225.

**0.500 x 0.500**

**Precision Rolled Ball Screws — Inch Series**

Diameter x Lead (in.)	0.500 x 0.500
Lead Accuracy (in/ft)	± 0.004
Screw Weight (lbs/ft)	0.7
Screw Root Diameter (in.)	0.41
Nominal Ball Diameter (in.)	0.125
Number of Starts	2

**Double Circuit, Round Ball Nut**

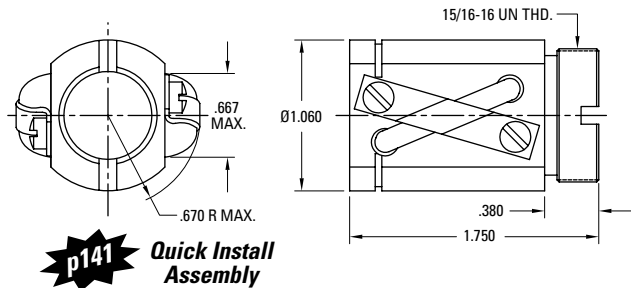

**Double Circuit, Round Ball Nut with Load Lock — High Capacity**

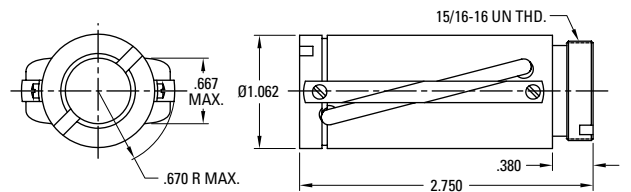

**Wiper and Flange Kits**

**Wiper**

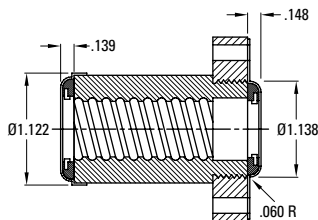

**Flange**

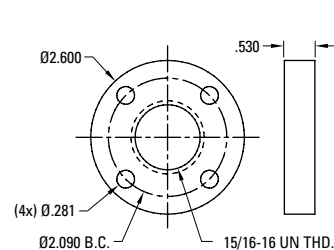

**Ball Screw Part Numbers**

Thread Direction	Right Hand	Left Hand	Right Hand
Screw Material	Alloy Steel	Alloy Steel	Stainless Steel
Standard Length	72"		72"
Maximum Length	72"		72"
Part Number	<b>190-9096</b>		<b>190-9010</b>

Ball screws can be cut to the length you require. Specify ball screw part number and overall length at time of order.

Thread Direction	Right Hand	Left Hand
Nut Material	Alloy Steel	
Dynamic Load (lbs)	929	
Max. Static Load (lbs)	4,150	
Torque to raise 1 lb (oz-in.)	1.42	
Nut weight (lbs)	0.27	
Ball Nut Part Number	<b>8105-448-014</b>	
Flange Part Number	<b>8105-448-002</b>	
Wiper Kit Part Number	<b>8105-101-002</b>	

Thread Direction	Right Hand	Left Hand	Right Hand
Nut Material	Alloy Steel	Alloy Steel	Stainless Steel
Dynamic Load (lbs)	2,200		380
Max. Static Load (lbs)	13,350		1,950
Torque to raise 1 lb (oz-in.)	1.42		1.42
Nut weight (lbs)	0.40		0.40
Ball Nut Part Number	<b>8105-448-011</b>		<b>8105-448-016<sup>(1)</sup></b>
Flange Part Number	<b>8105-448-002</b>		<b>8105-448-004</b>
Wiper Kit Part Number	<b>8105-101-002</b>		<b>8105-101-002</b>

(1) Load Lock not available

Wiper Part Number	<b>8105-101-002</b>		<b>8105-101-002</b>
Flange Part Number	<b>8105-448-002</b>		<b>8105-448-004</b>

Note: Dimensional information for all End Journals and Bearing Supports is available on page 148. Information on required lubrication is on page 225.

**0.631 x 0.200**

**Precision Rolled Ball Screws — Inch Series**

<b>Diameter x Lead (in.)</b>	0.631 x 0.200
<b>Lead Accuracy (in/ft)</b>	± 0.004
<b>Screw Weight (lbs/ft)</b>	0.9
<b>Screw Root Diameter (in.)</b>	0.50
<b>Nominal Ball Diameter (in.)</b>	0.125
<b>Number of Starts</b>	1

**Ball Screw Part Numbers**

Thread Direction	Right Hand	Left Hand	Right Hand
<b>Screw Material</b>	Alloy Steel	Alloy Steel	Stainless Steel
<b>Standard Length</b>	72"	72"	72"
<b>Maximum Length</b>	144"	144"	72"
<b>Part Number</b>	<b>190-9098</b>	<b>190-9099</b>	<b>5705378</b>

Ball screws can be cut to the length you require. Specify ball screw part number and overall length at time of order.

**Single Circuit, Square Ball Nut with Load Lock**

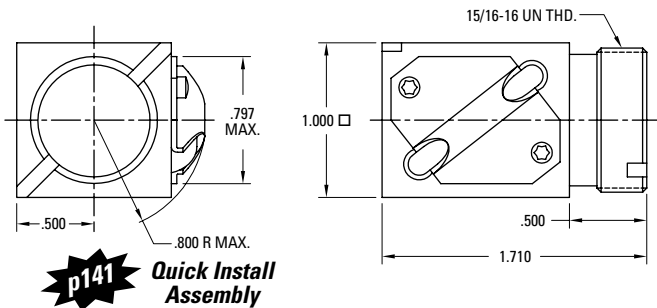

Thread Direction	Right Hand	Left Hand
<b>Nut Material</b>	Alloy Steel	Alloy Steel
<b>Dynamic Load (lbs)</b>	800	800
<b>Max. Static Load (lbs)</b>	6,384	6,384
<b>Torque to raise 1 lb (oz-in.)</b>	0.57	0.57
<b>Nut weight (lbs)</b>	0.27	0.27
<b>Ball Nut Part Number</b>	<b>8106-448-022</b>	<b>8106-448-026</b>
<b>Flange Part Number</b>	<b>8105-448-002</b>	<b>8105-448-002</b>
<b>Wiper Kit Part Number</b>	<b>N/A</b>	<b>N/A</b>

**Single Circuit, Square Ball Nut – Stainless Steel**

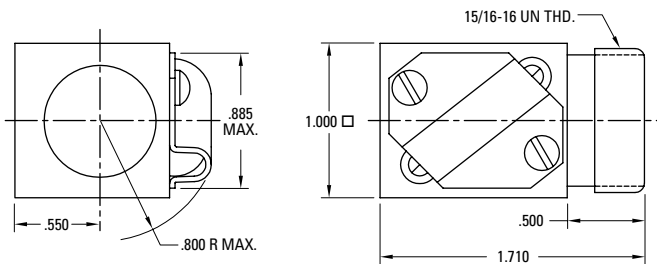

Thread Direction	Right Hand	Left Hand	Right Hand
<b>Nut Material</b>	Alloy Steel	Alloy Steel	Stainless Steel
<b>Dynamic Load (lbs)</b>			140
<b>Max. Static Load (lbs)</b>			1,149
<b>Torque to raise 1 lb (oz-in.)</b>			0.57
<b>Nut weight (lbs)</b>			0.27
<b>Ball Nut Part Number</b>			<b>5707645</b>
<b>Flange Part Number</b>			<b>N/A</b>
<b>Wiper Kit Part Number</b>			<b>N/A</b>

**Single Circuit, Round Ball Nut with Load Lock**

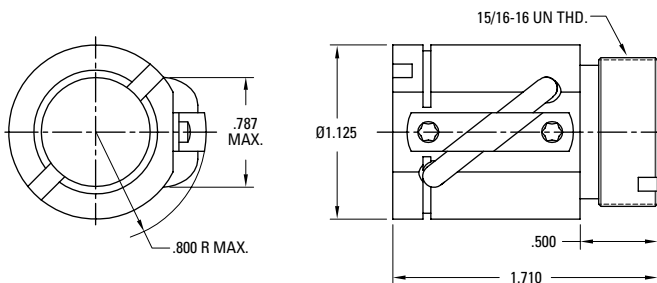

Thread Direction	Right Hand	Left Hand
<b>Nut Material</b>	Alloy Steel	Alloy Steel
<b>Dynamic Load (lbs)</b>	800	800
<b>Max. Static Load (lbs)</b>	6,384	6,384
<b>Torque to raise 1 lb (oz-in.)</b>	0.57	0.57
<b>Nut weight (lbs)</b>	0.27	0.27
<b>Ball Nut Part Number</b>	<b>8106-448-009</b>	<b>8106-448-008<sup>(1)</sup></b>
<b>Flange Part Number</b>	<b>8105-448-002</b>	<b>8105-448-002</b>
<b>Wiper Kit Part Number</b>	<b>8106-101-002</b>	<b>8106-101-002</b>

1) Load Lock not available

Note: Dimensional information for all End Journals and Bearing Supports is available on page 148. Information on required lubrication is on page 225.

**0.631 x 0.200**

**Precision Rolled Ball Screws — Inch Series**

Diameter x Lead (in.)	0.631 x 0.200
Lead Accuracy (in/ft)	± 0.004
Screw Weight (lbs/ft)	0.9
Screw Root Diameter (in.)	0.50
Nominal Ball Diameter (in.)	0.125
Number of Starts	1

**Preloaded, Single Circuit, Round Ball Nut**

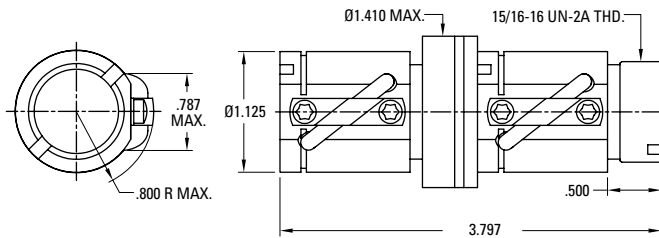

**Preloaded, Square Ball Nut**

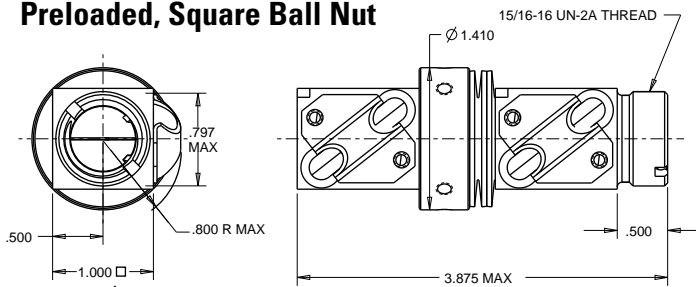

**p141** Quick Install Assembly

**Double Circuit, Square Ball Nut**

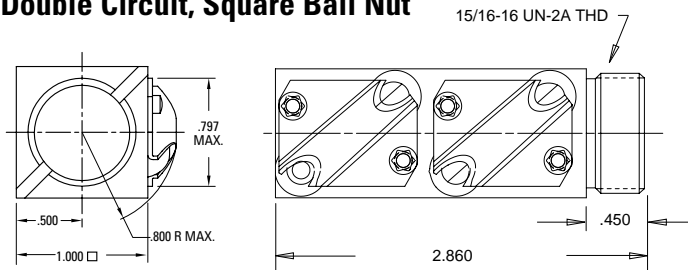

**Wiper and Flange Kits**

**Wiper**

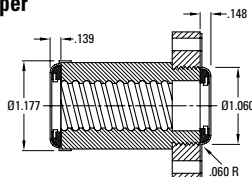

**Flange**

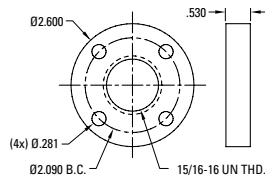

**Ball Screw Part Numbers**

Thread Direction	Right Hand	Left Hand
Screw Material	Alloy Steel	Alloy Steel
Standard Length	72"	72"
Maximum Length	144"	144"
Part Number	<b>190-9098</b>	<b>190-9099</b>

Ball screws can be cut to the length you require. Specify ball screw part number and overall length at time of order.

Thread Direction	Right Hand	Left Hand
Nut Material	Alloy Steel	Alloy Steel
Dynamic Load (lbs)	800	800
Max. Static Load (lbs)	6,384	6,384
Torque to raise 1 lb (oz-in.)	0.57	0.57
Nut weight (lbs)	0.79	0.79
Ball Nut Part Number	<b>8106-448-015</b>	<b>8106-448-019</b>
Flange Part Number	<b>8105-448-002</b>	<b>8105-448-002</b>
Wiper Kit Part Number	<b>8106-101-002</b>	<b>8106-101-002</b>

Thread Direction	Right Hand
Nut Material	Alloy Steel
Dynamic Load (lbs)	800
Max. Static Load (lbs)	6,384
Torque to raise 1 lb (oz-in.)	0.57
Nut weight (lbs)	0.79
Ball Nut Part Number	<b>8106-448-012</b>
Flange Part Number	<b>8105-448-002</b>
Wiper Kit Part Number	<b>N/A</b>

Thread Direction	Right Hand
Nut Material	Alloy Steel
Dynamic Load (lbs)	1,600
Max. Static Load (lbs)	12,768
Torque to raise 1 lb (oz-in.)	0.57
Nut weight (lbs)	0.54
Ball Nut Part Number	<b>8106-448-036</b>
Flange Part Number	<b>8105-448-002</b>
Wiper Kit Part Number	<b>N/A</b>

Wiper Part Number	<b>8106-101-002</b>
Flange Part Number	<b>8105-448-002</b>

Note: Dimensional information for all End Journals and Bearing Supports is available on page 148. Information on required lubrication is on page 225.

## 0.631 x 0.200

## Precision Rolled Ball Screws — Inch Series

<b>Diameter x Lead (in.)</b>	0.631 x 0.200
<b>Lead Accuracy (in/ft)</b>	± 0.004
<b>Screw Weight (lbs/ft)</b>	0.9
<b>Screw Root Diameter (in.)</b>	0.50
<b>Nominal Ball Diameter (in.)</b>	0.138
<b>Number of Starts</b>	1

### Triple Circuit, Internal Return, Round Ball Nut

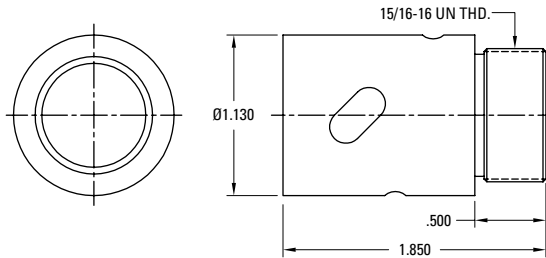

### Flange Kit

#### Flange

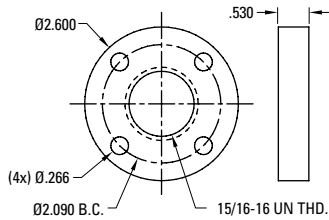

### Ball Screw Part Numbers

<b>Thread Direction</b>	Right Hand	Left Hand	Right Hand
<b>Screw Material</b>	Alloy Steel	Alloy Steel	Stainless Steel
<b>Standard Length</b>	118"		
<b>Maximum Length</b>	118"		
<b>Part Number</b>	<b>7832873-T7</b>		

Ball screws can be cut to the length you require. Specify ball screw part number and overall length at time of order.

<b>Thread Direction</b>	Right Hand	Left Hand
<b>Nut Material</b>	Alloy Steel	
<b>Dynamic Load (lbs)</b>	650	
<b>Max. Static Load (lbs)</b>	4,950	
<b>Torque to raise 1 lb (oz-in.)</b>	0.57	
<b>Nut weight (lbs)</b>	0.27	
<b>Ball Nut Part Number</b>	<b>7832872</b>	
<b>Flange Part Number</b>	<b>5707570</b>	
<b>Wiper Kit Part Number*</b>	<b>Internal</b>	

<b>Wiper Part Number</b>	<b>N/A</b>	
<b>Flange Part Number</b>	<b>5707570</b>	

\* Wiper Kit is included with this ball nut.

Note: Dimensional information for all End Journals and Bearing Supports is available on page 148. Information on required lubrication is on page 225.

## 0.631 x 0.200

## Precision Rolled Ball Screws — Inch Series

<b>Diameter x Lead (in.)</b>	0.631 x 0.200
<b>Lead Accuracy (in/ft)</b>	± 0.004
<b>Screw Weight (lbs/ft)</b>	0.9
<b>Screw Root Diameter (in.)</b>	0.50
<b>Nominal Ball Diameter (in.)</b>	0.125
<b>Number of Starts</b>	1

### Double Circuit, Square Ball Nut

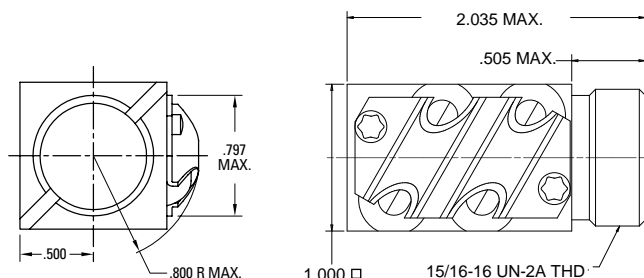

### Flange Kit

#### Flange

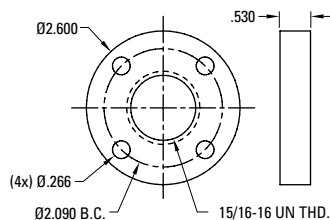

### Ball Screw Part Numbers

<b>Thread Direction</b>	Right Hand	Left Hand	Right Hand
<b>Screw Material</b>	Alloy Steel	Alloy Steel	Stainless Steel
<b>Standard Length</b>		72"	
<b>Maximum Length</b>		144"	
<b>Part Number</b>		<b>190-9099</b>	

Ball screws can be cut to the length you require. Specify ball screw part number and overall length at time of order.

<b>Thread Direction</b>	Right Hand	Left Hand
<b>Nut Material</b>		Alloy Steel
<b>Dynamic Load (lbs)</b>		1,600
<b>Max. Static Load (lbs)</b>		12,768
<b>Torque to raise 1 lb (oz-in.)</b>		0.57
<b>Nut weight (lbs)</b>		0.54
<b>Ball Nut Part Number</b>		<b>8106-448-037</b>
<b>Flange Part Number</b>		<b>8105-448-002</b>
<b>Wiper Kit Part Number</b>		<b>N/A</b>

<b>Wiper Part Number</b>		<b>N/A</b>
<b>Flange Part Number</b>		<b>5707570</b>

\* Wiper Kit is included with this ball nut.

Note: Dimensional information for all End Journals and Bearing Supports is available on page 148. Information on required lubrication is on page 225.

# 0.631 x 1.000

## Precision Rolled Ball Screws — Inch Series

Diameter x Lead (in.)	0.631 x 1.000
Lead Accuracy (in/ft)	± 0.004
Screw Weight (lbs/ft)	0.8
Screw Root Diameter (in.)	0.48
Nominal Ball Diameter (in.)	0.125
Number of Starts	4

### Ball Screw Part Numbers

Thread Direction	Right Hand	Left Hand	Right Hand
Screw Material	Alloy Steel	Alloy Steel	Stainless Steel
Standard Length	72"		
Maximum Length	96"		
Part Number	<b>7826712</b>		

Ball screws can be cut to the length you require. Specify ball screw part number and overall length at time of order.

### Double Circuit, Round Ball Nut

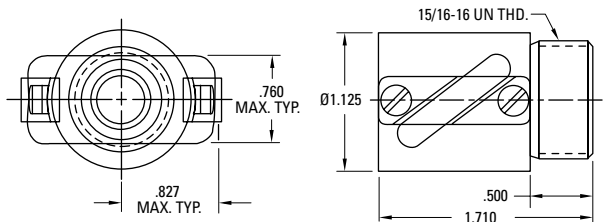

**p141** Quick Install Assembly

Thread Direction	Right Hand	Left Hand
Nut Material	Alloy Steel	
Dynamic Load (lbs)	578	
Max. Static Load (lbs)	2,425	
Torque to raise 1 lb (oz-in.)	2.83	
Nut weight (lbs)	0.28	
Ball Nut Part Number	<b>7826713</b>	
Flange Part Number	<b>5707570</b>	
Wiper Kit Part Number	<b>7827527</b>	

### Preloaded, Double Circuit, Round Ball Nut

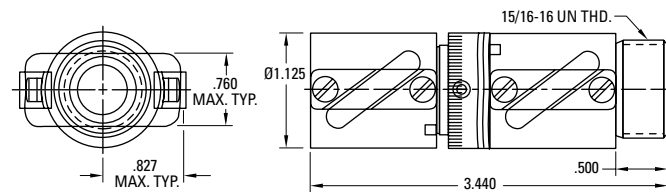

**p141** Quick Install Assembly

Thread Direction	Right Hand	Left Hand
Nut Material	Alloy Steel	
Dynamic Load (lbs)	578	
Max. Static Load (lbs)	2,425	
Torque to raise 1 lb (oz-in.)	2.83	
Nut weight (lbs)	0.67	
Ball Nut Part Number	<b>7827531</b>	
Flange Part Number	<b>5707570</b>	
Wiper Kit Part Number	<b>7827527</b>	

### Wiper and Flange Kits

#### Wiper

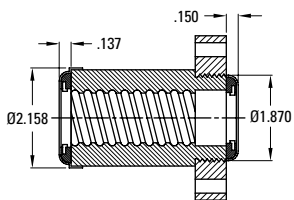

#### Flange

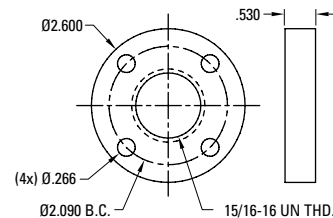

Note: Wiper kit does not include flange end cap.

Wiper Part Number	<b>7827527</b>	
Flange Part Number	<b>5707570</b>	

Note: Dimensional information for all End Journals and Bearing Supports is available on page 148. Information on required lubrication is on page 225.



**0.750 x 0.200****Precision Rolled Ball Screws — Inch Series**

Diameter x Lead (in.)	0.750 x 0.200
Lead Accuracy (in/ft)	± 0.004
Screw Weight (lbs/ft)	1.4
Screw Root Diameter (in.)	0.66
Nominal Ball Diameter (in.)	0.125
Number of Starts	1

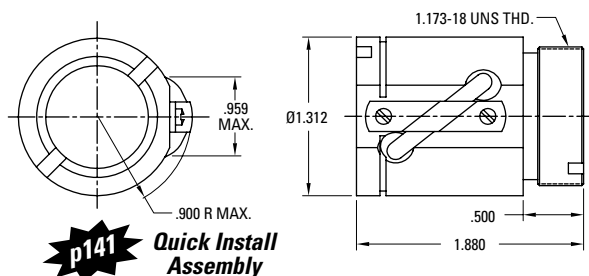
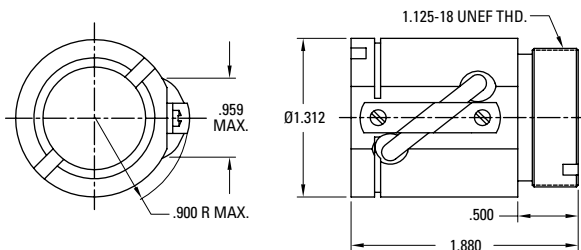
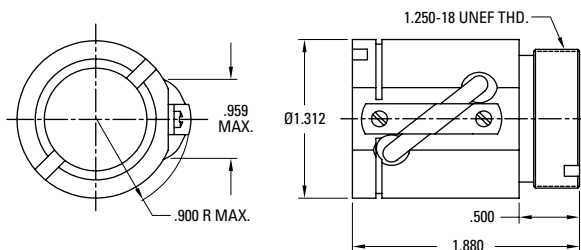
**Single Circuit, Round Ball Nut with Load Lock (1.173 - 18 V-Thread)****Single Circuit, Round Ball Nut (1.125 - 18 V-Thread)****Single Circuit, Round Ball Nut (1.250 - 18 V-Thread)****Ball Screw Part Numbers**

Thread Direction	Right Hand	Left Hand	Right Hand
Screw Material	Alloy Steel	Alloy Steel	Stainless Steel
Standard Length	72"		
Maximum Length	144"		
Part Number	<b>190-9101</b>		

Ball screws can be cut to the length you require. Specify ball screw part number and overall length at time of order.

Thread Direction	Right Hand	Left Hand
Nut Material	Alloy Steel	
Dynamic Load (lbs)	950	
Max. Static Load (lbs)	7,750	
Torque to raise 1 lb (oz-in.)	0.57	
Nut weight (lbs)	0.50	
Ball Nut Part Number	<b>8107-448-018</b>	
Flange Part Number	<b>8107-448-007</b>	
Wiper Kit Part Number	<b>8107-101-002</b>	

Thread Direction	Right Hand	Left Hand
Nut Material	Alloy Steel	
Dynamic Load (lbs)	950	
Max. Static Load (lbs)	7,750	
Torque to raise 1 lb (oz-in.)	0.57	
Nut weight (lbs)	0.50	
Ball Nut Part Number	<b>8107-448-026</b>	
Flange Part Number	<b>N/A</b>	
Wiper Kit Part Number	<b>N/A</b>	

Thread Direction	Right Hand	Left Hand
Nut Material	Carbon Steel	
Dynamic Load (lbs)	950	
Max. Static Load (lbs)	7,750	
Torque to raise 1 lb (oz-in.)	0.57	
Nut weight (lbs)	0.50	
Ball Nut Part Number	<b>8107-448-047</b>	
Flange Part Number	<b>N/A</b>	
Wiper Kit Part Number	<b>N/A</b>	

Note: Dimensional information for all End Journals and Bearing Supports is available on page 148. Information on required lubrication is on page 225.

**0.750 x 0.200**

**Precision Rolled Ball Screws — Inch Series**

<b>Diameter x Lead (in.)</b>	0.750 x 0.200
<b>Lead Accuracy (in/ft)</b>	± 0.004
<b>Screw Weight (lbs/ft)</b>	1.4
<b>Screw Root Diameter (in.)</b>	0.66
<b>Nominal Ball Diameter (in.)</b>	0.125
<b>Number of Starts</b>	1

**Ball Screw Part Numbers**

<b>Thread Direction</b>	Right Hand	Left Hand	Right Hand
<b>Screw Material</b>	Alloy Steel	Alloy Steel	Stainless Steel
<b>Standard Length</b>	72"		
<b>Maximum Length</b>	144"		
<b>Part Number</b>	<b>190-9101</b>		

Ball screws can be cut to the length you require. Specify ball screw part number and overall length at time of order.

**Double Circuit, Round Ball Nut with Load Lock (1.173 - 18 V-Thread)**

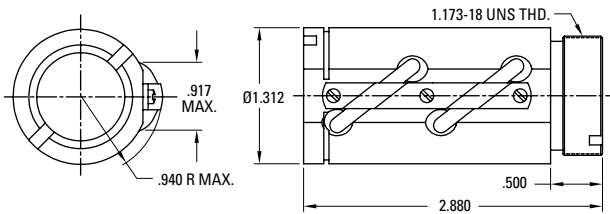

<b>Thread Direction</b>	Right Hand	Left Hand
<b>Nut Material</b>	Alloy Steel	
<b>Dynamic Load (lbs)</b>	1,900	
<b>Max. Static Load (lbs)</b>	18,800	
<b>Torque to raise 1 lb (oz-in.)</b>	0.57	
<b>Nut weight (lbs)</b>	0.75	
<b>Ball Nut Part Number</b>	<b>8107-448-016</b>	
<b>Flange Part Number</b>	<b>8107-448-007</b>	
<b>Wiper Kit Part Number</b>	<b>8107-101-002</b>	

**Double Circuit, Round Ball Nut with Load Lock (1.125 - 18 V-Thread)**

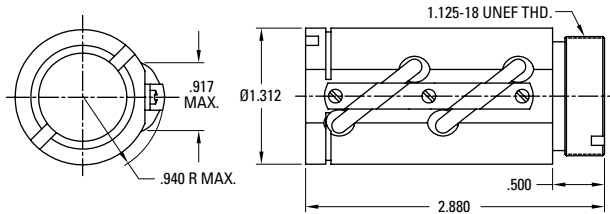

<b>Thread Direction</b>	Right Hand	Left Hand
<b>Nut Material</b>	Alloy Steel	
<b>Dynamic Load (lbs)</b>	1,900	
<b>Max. Static Load (lbs)</b>	18,800	
<b>Torque to raise 1 lb (oz-in.)</b>	0.57	
<b>Nut weight (lbs)</b>	0.75	
<b>Ball Nut Part Number</b>	<b>8107-448-027</b>	
<b>Flange Part Number</b>	<b>N/A</b>	
<b>Wiper Kit Part Number</b>	<b>N/A</b>	

**Double Circuit, Round Ball Nut with Load Lock (1.250 - 18 V-Thread)**

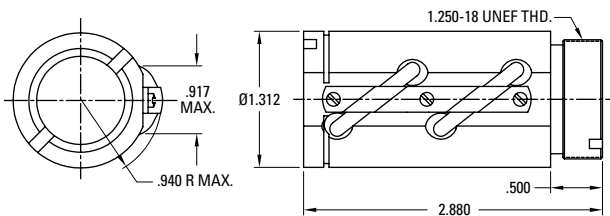

<b>Thread Direction</b>	Right Hand	Left Hand
<b>Nut Material</b>	Alloy Steel	
<b>Dynamic Load (lbs)</b>	1,900	
<b>Max. Static Load (lbs)</b>	18,800	
<b>Torque to raise 1 lb (oz-in.)</b>	0.57	
<b>Nut weight (lbs)</b>	0.75	
<b>Ball Nut Part Number</b>	<b>8107-448-046</b>	
<b>Flange Part Number</b>	<b>N/A</b>	
<b>Wiper Kit Part Number</b>	<b>N/A</b>	

Note: Dimensional information for all End Journals and Bearing Supports is available on page 148. Information on required lubrication is on page 225.

## 0.750 x 0.200

## Precision Rolled Ball Screws — Inch Series

Diameter x Lead (in.)	0.750 x 0.200
Lead Accuracy (in/ft)	± 0.004
Screw Weight (lbs/ft)	1.4
Screw Root Diameter (in.)	0.66
Nominal Ball Diameter (in.)	0.125
Number of Starts	1

### Preloaded, Single Circuit, Round Ball Nut (1.173 - 18 V-Thread)

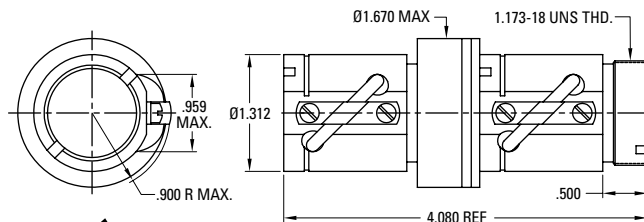

**p141** Quick Install Assembly

### Wiper and Flange Kits

#### Wiper

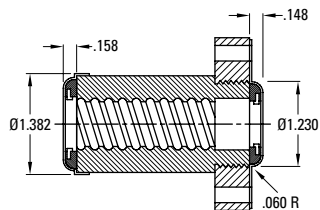

#### Flange

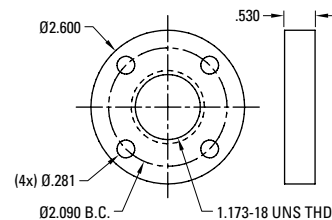

### Ball Screw Part Numbers

Thread Direction	Right Hand	Left Hand	Right Hand
Screw Material	Alloy Steel	Alloy Steel	Stainless Steel
Standard Length	72"		
Maximum Length	144"		
Part Number	190-9101		

Ball screws can be cut to the length you require. Specify ball screw part number and overall length at time of order.

Thread Direction	Right Hand	Left Hand
Nut Material	Alloy Steel	
Dynamic Load (lbs)	950	
Max. Static Load (lbs)	7,750	
Torque to raise 1 lb (oz-in.)	0.57	
Nut weight (lbs)	1.20	
Ball Nut Part Number	8107-448-025	
Flange Part Number	8107-448-007	
Wiper Kit Part Number	8107-101-002	

Wiper Part Number	8107-101-002	
Flange Part Number	8107-448-007	

Note: Dimensional information for all End Journals and Bearing Supports is available on page 148. Information on required lubrication is on page 225.

**0.750 x 0.500**

**Precision Rolled Ball Screws — Inch Series**

Diameter x Lead (in.)	0.750 x 0.500
Lead Accuracy (in/ft)	± 0.004
Screw Weight (lbs/ft)	1.4
Screw Root Diameter (in.)	0.63
Nominal Ball Diameter (in.)	0.156
Number of Starts	2

**Double Circuit, Round Ball Nut with Load Lock (1.250 - 16 V-Thread)**

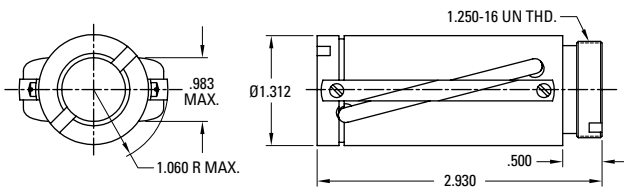

**p141** Quick Install Assembly

**Double Circuit, Round Ball Nut with Load Lock (1.173 - 18 V-Thread)**

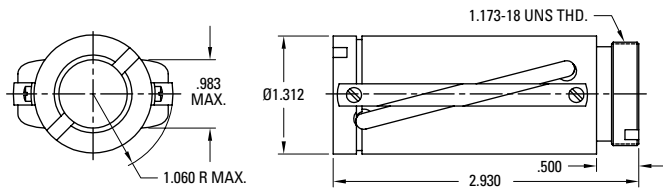

**Double Circuit, Round Ball Nut with Load Lock (1.250 - 18 V-Thread)**

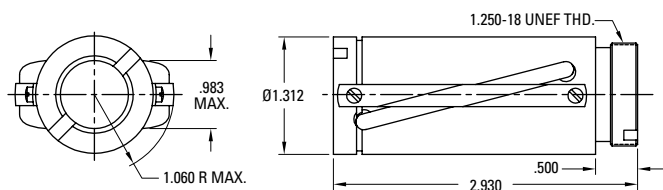

**Ball Screw Part Numbers**

Thread Direction	Right Hand	Left Hand	Right Hand
Screw Material	Alloy Steel	Alloy Steel	Stainless Steel
Standard Length	72"		72"
Maximum Length	144"		144"
Part Number	<b>190-9100</b>		<b>190-9006</b>

Ball screws can be cut to the length you require. Specify ball screw part number and overall length at time of order.

Thread Direction	Right Hand	Left Hand	Right Hand
Nut Material	Alloy Steel	Alloy Steel	Stainless Steel
Dynamic Load (lbs)	3,450		600
Max. Static Load (lbs)	24,200		3,460
Torque to raise 1 lb (oz-in.)	1.42		1.42
Nut weight (lbs)	0.80		0.80
Ball Nut Part Number	<b>8107-448-014</b>		<b>8107-448-020<sup>(1)</sup></b>
Flange Part Number	<b>8107-448-002</b>		<b>8107-448-004</b>
Wiper Kit Part Number	<b>8107-101-002</b>		<b>8107-101-002</b>

(1) Load Lock not available

Thread Direction	Right Hand	Left Hand
Nut Material	Alloy Steel	
Dynamic Load (lbs)	3,450	
Max. Static Load (lbs)	24,200	
Torque to raise 1 lb (oz-in.)	1.42	
Nut weight (lbs)	0.80	
Ball Nut Part Number	<b>8107-448-049</b>	
Flange Part Number	<b>N/A</b>	
Wiper Kit Part Number	<b>N/A</b>	

Thread Direction	Right Hand	Left Hand
Nut Material	Alloy Steel	
Dynamic Load (lbs)	3,450	
Max. Static Load (lbs)	24,200	
Torque to raise 1 lb (oz-in.)	1.42	
Nut weight (lbs)	0.80	
Ball Nut Part Number	<b>8107-448-048</b>	
Flange Part Number	<b>N/A</b>	
Wiper Kit Part Number	<b>N/A</b>	

Note: Dimensional information for all End Journals and Bearing Supports is available on page 148. Information on required lubrication is on page 225.

## 0.750 x 0.500

## Precision Rolled Ball Screws — Inch Series

Diameter x Lead (in.)	0.750 x 0.500
Lead Accuracy (in/ft)	± 0.004
Screw Weight (lbs/ft)	1.4
Screw Root Diameter (in.)	0.63
Nominal Ball Diameter (in.)	0.156
Number of Starts	2

### Preloaded, Double Circuit, Round Ball Nut with Load Lock (1.250 - 16 V-Thread)

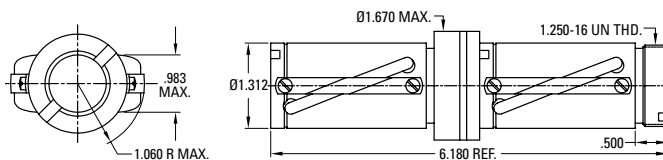

**p141** Quick Install Assembly

### Wiper and Flange Kits

#### Wiper

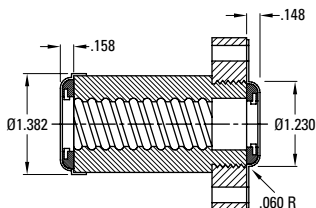

#### Flange

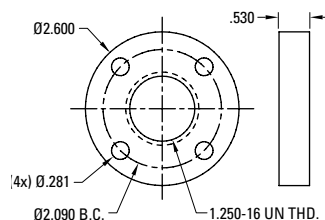

### Ball Screw Part Numbers

Thread Direction	Right Hand	Left Hand
Screw Material	Alloy Steel	Alloy Steel
Standard Length	72"	
Maximum Length	144"	
Part Number	<b>190-9100</b>	

Ball screws can be cut to the length you require. Specify ball screw part number and overall length at time of order.

Thread Direction	Right Hand	Left Hand
Nut Material	Alloy Steel	
Dynamic Load (lbs)	3,450	
Max. Static Load (lbs)	24,200	
Torque to raise 1 lb (oz-in.)	1.42	
Nut weight (lbs)	1.85	
Ball Nut Part Number	<b>8107-448-011</b>	
Flange Part Number	<b>8107-448-002</b>	
Wiper Kit Part Number	<b>8107-101-002</b>	

Wiper Part Number	<b>8107-101-002</b>	
Flange Part Number	<b>8107-448-002</b>	

Note: Dimensional information for all End Journals and Bearing Supports is available on page 148. Information on required lubrication is on page 225.

# 0.875 x 0.200

# Precision Rolled Ball Screws — Inch Series

<b>Diameter x Lead (in.)</b>	0.875 x 0.200
<b>Lead Accuracy (in/ft)</b>	± 0.004
<b>Screw Weight (lbs/ft)</b>	1.8
<b>Screw Root Diameter (in.)</b>	0.74
<b>Nominal Ball Diameter (in.)</b>	0.125
<b>Number of Starts</b>	1

## Ball Screw Part Numbers

<b>Thread Direction</b>	Right Hand	Left Hand	Right Hand
<b>Screw Material</b>	Alloy Steel	Alloy Steel	Stainless Steel
<b>Standard Length</b>	144"		
<b>Maximum Length</b>	144"		
<b>Part Number</b>	<b>5708859</b>		

Ball screws can be cut to the length you require. Specify ball screw part number and overall length at time of order.

## Double Circuit, Round Ball Nut

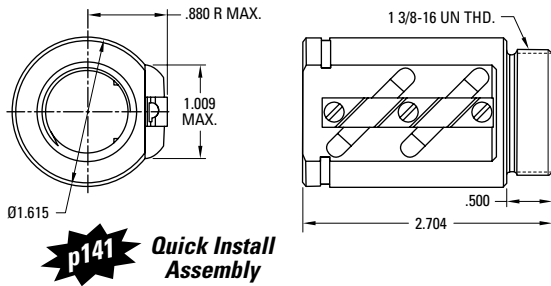

<b>Thread Direction</b>	Right Hand	Left Hand
<b>Nut Material</b>	Alloy Steel	
<b>Dynamic Load (lbs)</b>	1,942	
<b>Max. Static Load (lbs)</b>	18,063	
<b>Torque to raise 1 lb (oz-in.)</b>	0.57	
<b>Nut weight (lbs)</b>	0.69	
<b>Ball Nut Part Number</b>	<b>5708277</b>	
<b>Flange Part Number</b>	<b>5708281</b>	
<b>Wiper Kit Part Number</b>	<b>7831512</b>	

## Preloaded, Single Circuit, Round Ball Nut with Integral Flange

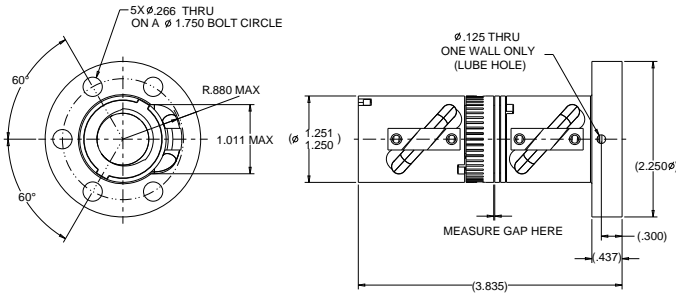

<b>Thread Direction</b>	Right Hand
<b>Nut Material</b>	Alloy Steel
<b>Dynamic Load (lbs)</b>	971
<b>Max. Static Load (lbs)</b>	9,482
<b>Torque to raise 1 lb (oz-in.)</b>	0.57
<b>Nut weight (lbs)</b>	1.81
<b>Ball Nut Part Number</b>	<b>7833677</b>
<b>Flange Part Number</b>	<b>Integral</b>
<b>Wiper Kit Part Number</b>	<b>Integral</b>

## Wiper and Flange Kits

### Wiper

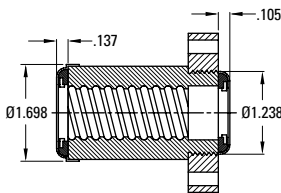

### Flange

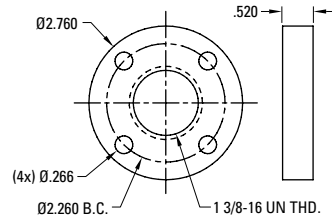

<b>Wiper Part Number</b>	<b>7831512</b>	
<b>Flange Part Number</b>	<b>5708281</b>	

Note: Wiper kit does not include flange end cap.

Note: Dimensional information for all End Journals and Bearing Supports is available on page 148. Information on required lubrication is on page 225.

## 1.000 x 0.250

## Precision Rolled Ball Screws — Inch Series

Diameter x Lead (in.)	1.000 x 0.250
Lead Accuracy (in/ft)	± 0.004
Screw Weight (lbs/ft)	2.3
Screw Root Diameter (in.)	0.84
Nominal Ball Diameter (in.)	0.156
Number of Starts	1

### Single Circuit, Square Ball Nut with Load Lock

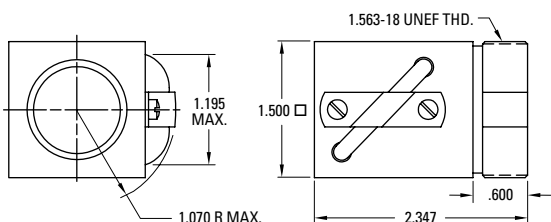

**p141** Quick Install Assembly

### Single Circuit, Round Ball Nut with Load Lock

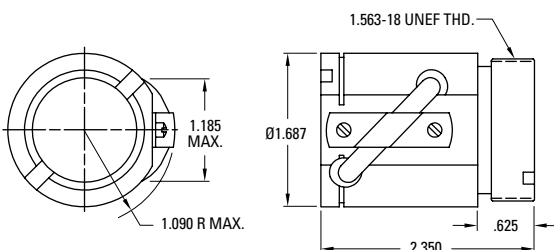

### Double Circuit, Square Ball Nut with Load Lock

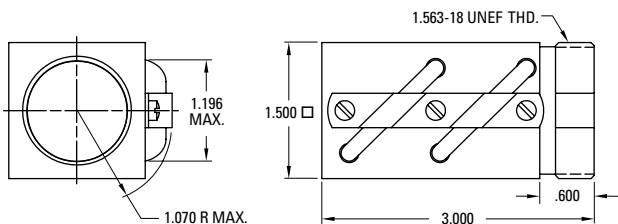

### Ball Screw Part Numbers

Thread Direction	Right Hand	Left Hand	Right Hand
Screw Material	Alloy Steel	Alloy Steel	Stainless Steel
Standard Length	144"	144"	
Maximum Length	288"	144"	
Part Number	<b>190-9104</b>	<b>190-9105</b>	

Ball screws can be cut to the length you require. Specify ball screw part number and overall length at time of order.

Thread Direction	Right Hand	Left Hand
Nut Material	Alloy Steel	Alloy Steel
Dynamic Load (lbs)	1,612	1,612
Max. Static Load (lbs)	15,300	15,300
Torque to raise 1 lb (oz-in.)	0.71	0.71
Nut weight (lbs)	0.81	0.81
Ball Nut Part Number	<b>8110-448-055</b>	<b>8110-448-091</b>
Flange Part Number	<b>8110-448-002</b>	<b>8110-448-002</b>
Wiper Kit Part Number	<b>N/A</b>	<b>N/A</b>

Thread Direction	Right Hand	Left Hand
Nut Material	Alloy Steel	Alloy Steel
Dynamic Load (lbs)	1,612	1,612
Max. Static Load (lbs)	13,913	13,913
Torque to raise 1 lb (oz-in.)	0.71	0.71
Nut weight (lbs)	0.81	0.81
Ball Nut Part Number	<b>8110-448-032</b>	<b>8110-448-030<sup>(1)</sup></b>
Flange Part Number	<b>8110-448-002</b>	<b>8110-448-002</b>
Wiper Kit Part Number	<b>8110-101-002</b>	<b>8110-101-002</b>

(1) Load Lock not available

Thread Direction	Right Hand	Left Hand
Nut Material	Alloy Steel	
Dynamic Load (lbs)	3,350	
Max. Static Load (lbs)	30,750	
Torque to raise 1 lb (oz-in.)	0.71	
Nut weight (lbs)	1.25	
Ball Nut Part Number	<b>8110-448-056</b>	
Flange Part Number	<b>8110-448-002</b>	
Wiper Kit Part Number	<b>N/A</b>	

Note: Dimensional information for all End Journals and Bearing Supports is available on page 148. Information on required lubrication is on page 225.

# 1.000 x 0.250

## Precision Rolled Ball Screws — Inch Series

Diameter x Lead (in.)	1.000 x 0.250
Lead Accuracy (in/ft)	± 0.004
Screw Weight (lbs/ft)	2.3
Screw Root Diameter (in.)	0.84
Nominal Ball Diameter (in.)	0.156
Number of Starts	1

### Ball Screw Part Numbers

Thread Direction	Right Hand	Left Hand	Right Hand
Screw Material	Alloy Steel	Alloy Steel	Stainless Steel
Standard Length	144"	144"	
Maximum Length	288"	144"	
Part Number	<b>190-9104</b>	<b>190-9105</b>	

Ball screws can be cut to the length you require. Specify ball screw part number and overall length at time of order.

### Double Circuit, Round Ball Nut with Load Lock

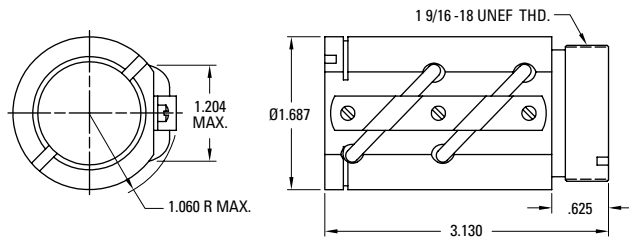

Thread Direction	Right Hand	Left Hand
Nut Material	Alloy Steel	Alloy Steel
Dynamic Load (lbs)	3,350	3,350
Max. Static Load (lbs)	30,750	30,750
Torque to raise 1 lb (oz-in.)	0.71	0.71
Nut weight (lbs)	1.25	1.25
Ball Nut Part Number	<b>8110-448-026</b>	<b>8110-448-024</b>
Flange Part Number	<b>8110-448-002</b>	<b>8110-448-002</b>
Wiper Kit Part Number	<b>8110-101-002</b>	<b>8110-101-002</b>

### Double Circuit, Round Ball Nut with Integral Flange

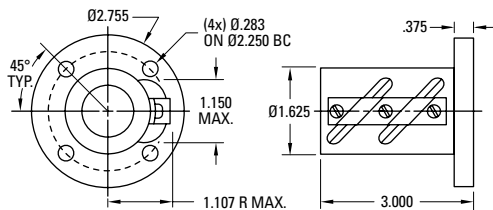

Thread Direction	Right Hand	Left Hand
Nut Material	Alloy Steel	Alloy Steel
Dynamic Load (lbs)	3,350	3,350
Max. Static Load (lbs)	30,750	30,750
Torque to raise 1 lb (oz-in.)	0.71	0.71
Nut weight (lbs)	1.50	1.50
Ball Nut Part Number	<b>8110-448-087</b>	<b>8110-448-088</b>
Flange Part Number	<b>Integral</b>	<b>Integral</b>
Wiper Kit Part Number	<b>N/A</b>	<b>N/A</b>

### Wiper and Flange Kits

#### Wiper

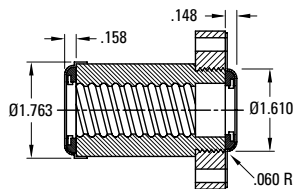

#### Flange

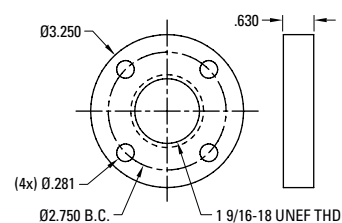

Wiper Part Number	<b>8110-101-002</b>	
Flange Part Number	<b>8110-448-002</b>	

Note: Dimensional information for all End Journals and Bearing Supports is available on page 148. Information on required lubrication is on page 225.



## 1.000 x 0.250

## Precision Rolled Ball Screws — Inch Series

Diameter x Lead (in.)	1.000 x 0.250
Lead Accuracy (in/ft)	± 0.004
Screw Weight (lbs/ft)	2.3
Screw Root Diameter (in.)	0.84
Nominal Ball Diameter (in.)	0.156
Number of Starts	1

### Preloaded, Single Circuit, Round Ball Nut with Integral Flange

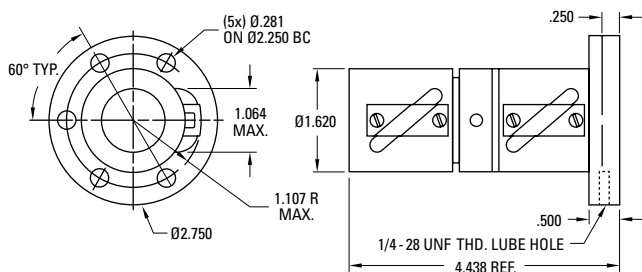

### Preloaded, Single Circuit, Square Ball Nut

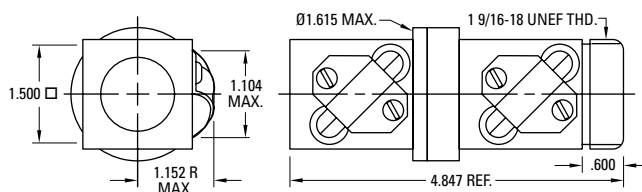

**P141** Quick Install Assembly

### Wiper and Flange Kits

#### Wiper

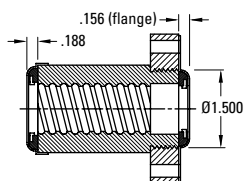

#### Flange

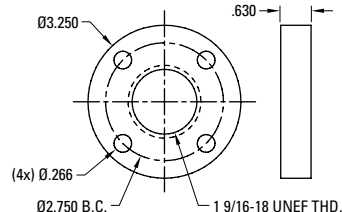

### Ball Screw Part Numbers

Thread Direction	Right Hand	Left Hand	Right Hand
Screw Material	Alloy Steel	Alloy Steel	Stainless Steel
Standard Length	192"	192"	
Maximum Length	192"	192"	
Part Number	<b>7820426</b>	<b>7820428</b>	

Ball screws can be cut to the length you require. Specify ball screw part number and overall length at time of order.

Thread Direction	Right Hand	Left Hand
Nut Material	Alloy Steel	
Dynamic Load (lbs)	1,612	
Max. Static Load (lbs)	13,913	
Torque to raise 1 lb (oz-in.)	0.71	
Nut weight (lbs)	2.00	
Ball Nut Part Number	<b>7823586</b>	
Flange Part Number	<b>Internal</b>	
Wiper Kit Part Number	<b>Internal</b>	

Thread Direction	Right Hand	Left Hand
Nut Material	Alloy Steel	Alloy Steel
Dynamic Load (lbs)	1,612	1,612
Max. Static Load (lbs)	13,913	13,913
Torque to raise 1 lb (oz-in.)	0.71	0.71
Nut weight (lbs)	1.90	1.90
Ball Nut Part Number	<b>5704167</b>	<b>5704168</b>
Flange Part Number	<b>5707571</b>	<b>5707571</b>
Wiper Kit Part Number	<b>5702649</b>	<b>5702649</b>

Wiper Part Number	<b>5702649</b>	
Flange Part Number	<b>5707571</b>	

Note: Dimensional information for all End Journals and Bearing Supports is available on page 148. Information on required lubrication is on page 225.

# 1.000 x 0.500

## Precision Rolled Ball Screws — Inch Series

Diameter x Lead (in.)	1.000 x 0.500
Lead Accuracy (in/ft)	± 0.004
Screw Weight (lbs/ft)	2.6
Screw Root Diameter (in.)	0.88
Nominal Ball Diameter (in.)	0.156
Number of Starts	2

### Ball Screw Part Numbers

Thread Direction	Right Hand	Left Hand	Right Hand
Screw Material	Alloy Steel	Alloy Steel	Stainless Steel
Standard Length	144"		
Maximum Length	288"		
Part Number	<b>190-9103</b>		

Ball screws can be cut to the length you require. Specify ball screw part number and overall length at time of order.

### Double Circuit, Round Ball Nut with Load Lock

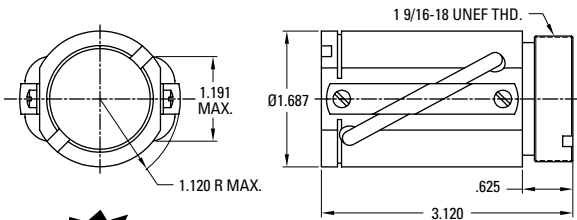

**p141** Quick Install Assembly

Thread Direction	Right Hand	Left Hand
Nut Material	Alloy Steel	
Dynamic Load (lbs)	3,950	
Max. Static Load (lbs)	32,300	
Torque to raise 1 lb (oz-in.)	1.42	
Nut weight (lbs)	1.25	
Ball Nut Part Number	<b>8110-448-022</b>	
Flange Part Number	<b>8110-448-002</b>	
Wiper Kit Part Number	<b>8110-101-002</b>	

### Preloaded, Double Circuit, Round Ball Nut with Load Lock

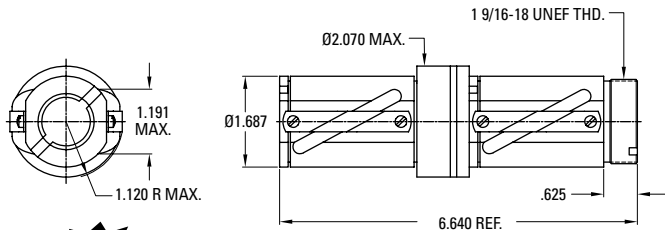

**p141** Quick Install Assembly

Thread Direction	Right Hand	Left Hand
Nut Material	Alloy Steel	
Dynamic Load (lbs)	3,950	
Max. Static Load (lbs)	32,300	
Torque to raise 1 lb (oz-in.)	1.42	
Nut weight (lbs)	2.90	
Ball Nut Part Number	<b>8110-448-016</b>	
Flange Part Number	<b>8110-448-002</b>	
Wiper Kit Part Number	<b>8110-101-002</b>	

### Wiper and Flange Kits

#### Wiper

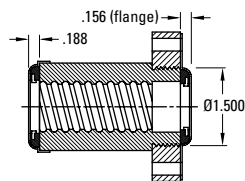

#### Flange

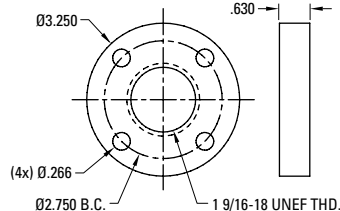

Wiper Part Number	<b>8110-101-002</b>	
Flange Part Number	<b>8110-448-002</b>	

Note: Dimensional information for all End Journals and Bearing Supports is available on page 148. Information on required lubrication is on page 225.

**1.000 x 1.000**

**Precision Rolled Ball Screws — Inch Series**

Diameter x Lead (in.)	1.000 x 1.000
Lead Accuracy (in/ft)	± 0.004
Screw Weight (lbs/ft)	2.3
Screw Root Diameter (in.)	0.84
Nominal Ball Diameter (in.)	0.156
Number of Starts	4

**Double Circuit, Round Ball Nut with Load Lock**

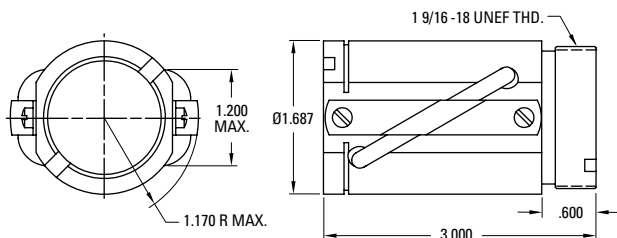

**Double Circuit, Square Ball Nut with Load Lock**

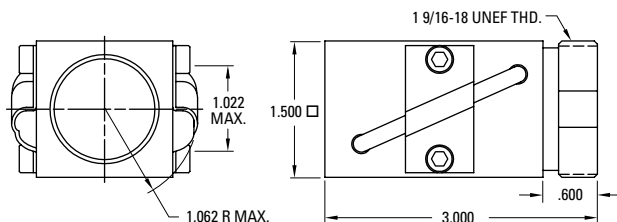

**p141** Quick Install Assembly

**Wiper and Flange Kits**

**Wiper**

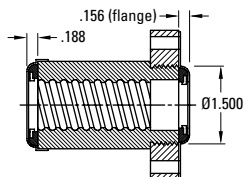

**Flange**

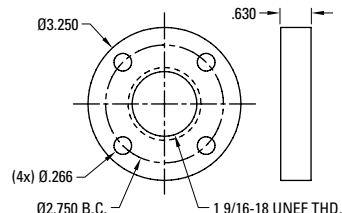

**Ball Screw Part Numbers**

Thread Direction	Right Hand	Left Hand	Right Hand
Screw Material	Alloy Steel	Alloy Steel	Stainless Steel
Standard Length	144"		144"
Maximum Length	288"		144"
Part Number	<b>190-9102</b>		<b>190-9150</b>

Ball screws can be cut to the length you require. Specify ball screw part number and overall length at time of order.

Thread Direction	Right Hand	Left Hand	Right Hand
Nut Material	Alloy Steel	Alloy Steel	Stainless Steel
Dynamic Load (lbs)	2,250		430
Max. Static Load (lbs)	13,750		2000
Torque to raise 1 lb (oz-in.)	2.83		2.83
Nut weight (lbs)	1.25		1.25
Ball Nut Part Number	<b>8110-448-020</b>		<b>8110-448-034<sup>(1)</sup></b>
Flange Part Number	<b>8110-448-002</b>		<b>8110-448-037</b>
Wiper Kit Part Number	<b>8110-101-002</b>		<b>8110-101-002</b>

(1) Load Lock not available

Thread Direction	Right Hand	Left Hand
Nut Material	Alloy Steel	
Dynamic Load (lbs)	2,400	
Max. Static Load (lbs)	13,600	
Torque to raise 1 lb (oz-in.)	2.83	
Nut weight (lbs)	1.25	
Ball Nut Part Number	<b>8110-448-086</b>	
Flange Part Number	<b>8110-448-002</b>	
Wiper Kit Part Number	<b>N/A</b>	

Wiper Part Number	<b>8110-101-002</b>	
Flange Part Number	<b>8110-448-002</b>	
Flange Part Number	<b>8110-448-037</b>	

Note: Dimensional information for all End Journals and Bearing Supports is available on page 148. Information on required lubrication is on page 225.

# 1.150 x 0.200

## Precision Rolled Ball Screws — Inch Series

<b>Diameter x Lead (in.)</b>	1.150 x 0.200
<b>Lead Accuracy (in/ft)</b>	± 0.004
<b>Screw Weight (lbs/ft)</b>	3.2
<b>Screw Root Diameter (in.)</b>	1.02
<b>Nominal Ball Diameter (in.)</b>	0.125
<b>Number of Starts</b>	1

### Preloaded, Single Circuit, Round Ball Nut with Integral Flange

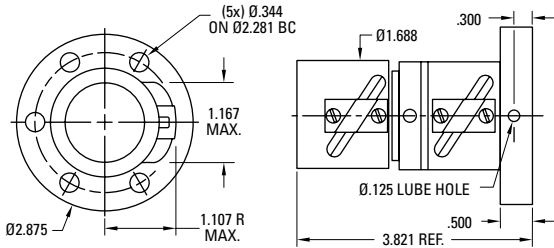

### Ball Screw Part Numbers

<b>Thread Direction</b>	Right Hand	Left Hand	Right Hand
<b>Screw Material</b>	Alloy Steel	Alloy Steel	Stainless Steel
<b>Standard Length</b>	240"		
<b>Maximum Length</b>	240"		
<b>Part Number</b>	<b>7820430</b>		

Ball screws can be cut to the length you require. Specify ball screw part number and overall length at time of order.

<b>Thread Direction</b>	Right Hand	Left Hand
<b>Nut Material</b>	Alloy Steel	
<b>Dynamic Load (lbs)</b>	1,185	
<b>Max. Static Load (lbs)</b>	13,090	
<b>Torque to raise 1 lb (oz-in.)</b>	0.57	
<b>Nut weight (lbs)</b>	1.75	
<b>Ball Nut Part Number</b>	<b>7823587</b>	
<b>Flange Part Number</b>	<b>Integral</b>	
<b>Wiper Kit Part Number</b>	<b>Internal</b>	

Note: Dimensional information for all End Journals and Bearing Supports is available on page 148. Information on required lubrication is on page 225.

## 1.150 x 0.200

## Precision Rolled Ball Screws — Inch Series

Diameter x Lead (in.)	1.150 x 0.200
Lead Accuracy (in/ft)	± 0.004
Screw Weight (lbs/ft)	3.2
Screw Root Diameter (in.)	1.02
Nominal Ball Diameter (in.)	0.125
Number of Starts	1

### Preloaded, Double Circuit, Round Ball Nut with Load Lock

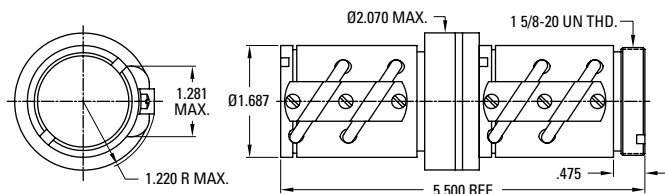

**p141** Quick Install Assembly

### Double Circuit, Round Ball Nut with Load Lock

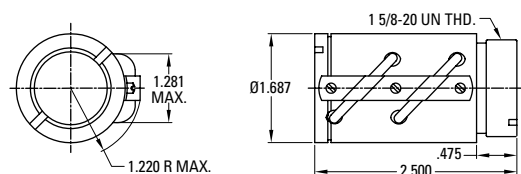

**p141** Quick Install Assembly

### Wiper and Flange Kits

#### Wiper

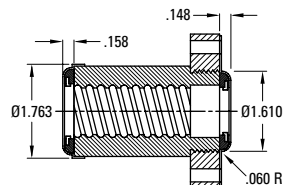

#### Flange

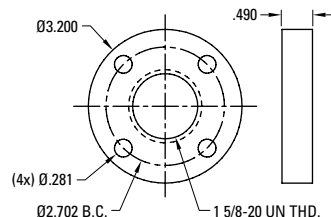

### Ball Screw Part Numbers

Thread Direction	Right Hand	Left Hand	Right Hand
Screw Material	Alloy Steel	Alloy Steel	Stainless Steel
Standard Length	144"		
Maximum Length	288"		
Part Number	190-9106		

Ball screws can be cut to the length you require. Specify ball screw part number and overall length at time of order.

Thread Direction	Right Hand	Left Hand
Nut Material	Alloy Steel	
Dynamic Load (lbs)	2,400	
Max. Static Load (lbs)	27,550	
Torque to raise 1 lb (oz-in.)	0.57	
Nut weight (lbs)	2.25	
Ball Nut Part Number	8111-448-004	
Flange Part Number	8111-448-002	
Wiper Kit Part Number	8111-101-002	

Thread Direction	Right Hand	Left Hand
Nut Material	Alloy Steel	
Dynamic Load (lbs)	2,400	
Max. Static Load (lbs)	27,550	
Torque to raise 1 lb (oz-in.)	0.57	
Nut weight (lbs)	0.88	
Ball Nut Part Number	8111-448-006	
Flange Part Number	8111-448-002	
Wiper Kit Part Number	8111-101-002	

Wiper Part Number	8111-101-002	
Flange Part Number	8111-448-002	

Note: Dimensional information for all End Journals and Bearing Supports is available on page 148. Information on required lubrication is on page 225.

# 1.171 x 0.413

## Precision Rolled Ball Screws — Inch Series

<b>Diameter x Lead (in.)</b>	1.171 x 0.413
<b>Lead Accuracy (in/ft)</b>	± 0.004
<b>Screw Weight (lbs/ft)</b>	2.8
<b>Screw Root Diameter (in.)</b>	0.87
<b>Nominal Ball Diameter (in.)</b>	0.281
<b>Number of Starts</b>	1

### Ball Screw Part Numbers

<b>Thread Direction</b>	Right Hand	Left Hand	Right Hand
<b>Screw Material</b>	Alloy Steel	Alloy Steel	Stainless Steel
<b>Standard Length</b>	192"		
<b>Maximum Length</b>	192"		
<b>Part Number</b>	<b>7820432</b>		

Ball screws can be cut to the length you require. Specify ball screw part number and overall length at time of order.

### Double Circuit, Round Ball Nut

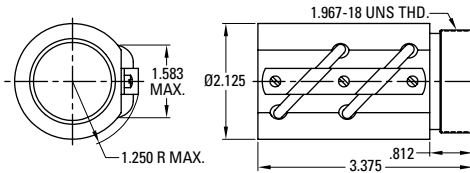

<b>Thread Direction</b>	Right Hand	Left Hand
<b>Nut Material</b>	Alloy Steel	
<b>Dynamic Load (lbs)</b>	3,894	
<b>Max. Static Load (lbs)</b>	22,917	
<b>Torque to raise 1 lb (oz-in.)</b>	1.17	
<b>Nut weight (lbs)</b>	1.94	
<b>Ball Nut Part Number</b>	<b>5707511</b>	
<b>Flange Part Number</b>	<b>5707572</b>	
<b>Wiper Kit Part Number</b>	<b>5702653</b>	

### Wiper and Flange Kits

#### Wiper

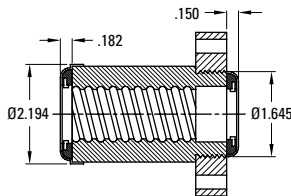

#### Flange

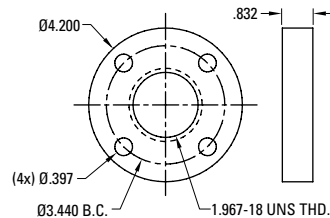

Note: Wiper kit does not include flange end cap.

<b>Wiper Part Number</b>	<b>5702653</b>	
<b>Flange Part Number</b>	<b>5707572</b>	

Note: Dimensional information for all End Journals and Bearing Supports is available on page 148. Information on required lubrication is on page 225.

**1.500 x 0.250**

**Precision Rolled Ball Screws — Inch Series**

Diameter x Lead (in.)	1.500 x 0.250
Lead Accuracy (in/ft)	± 0.004
Screw Weight (lbs/ft)	5.2
Screw Root Diameter (in.)	1.32
Nominal Ball Diameter (in.)	0.156
Number of Starts	1

**Ball Screw Part Numbers**

Thread Direction	Right Hand	Left Hand	Right Hand
Screw Material	Alloy Steel	Alloy Steel	Stainless Steel
Standard Length	240"	240"	
Maximum Length	240"	240"	
Part Number	<b>7820595</b>	<b>7820596</b>	

Ball screws can be cut to the length you require. Specify ball screw part number and overall length at time of order.

Ball Screws - Inch Series

**Double Circuit, Round Ball Nut with Load Lock**

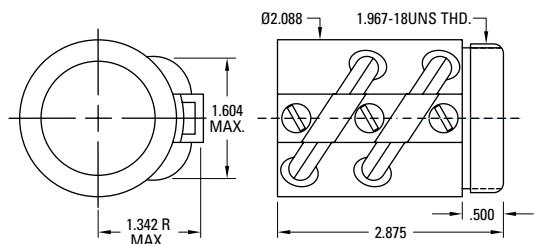

**P141** Quick Install Assembly

**Preloaded, Double Circuit, Round Ball Nut with Load Lock**

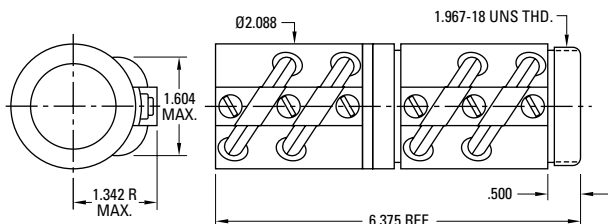

**P141** Quick Install Assembly

Thread Direction	Right Hand	Left Hand (1)
Nut Material	Alloy Steel	Alloy Steel
Dynamic Load (lbs)	4,198	4,198
Max. Static Load (lbs)	44,030	44,030
Torque to raise 1 lb (oz-in.)	0.71	0.71
Nut weight (lbs)	1.65	1.65
Ball Nut Part Number	<b>7833233</b>	<b>5701990<sup>(1)</sup></b>
Flange Part Number	<b>5706754</b>	<b>5706754</b>
Wiper Kit Part Number	<b>5702654</b>	<b>5702654</b>

(1) Load Lock not available

Thread Direction	Right Hand	Left Hand
Nut Material	Alloy Steel	Alloy Steel
Dynamic Load (lbs)	4,198	4,198
Max. Static Load (lbs)	44,030	44,030
Torque to raise 1 lb (oz-in.)	0.71	0.71
Nut weight (lbs)	3.80	3.80
Ball Nut Part Number	<b>7833234</b>	<b>5704573<sup>(1)</sup></b>
Flange Part Number	<b>5706754</b>	<b>5706754</b>
Wiper Kit Part Number	<b>5702654</b>	<b>5702654</b>

(1) Load Lock not available

**Wiper and Flange Kits**

**Wiper**

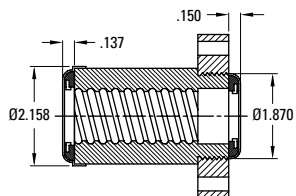

**Flange**

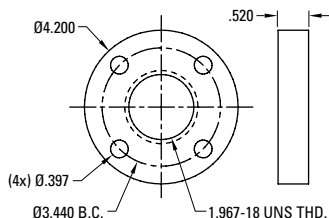

Note: Wiper kit does not include flange end cap.

Wiper Part Number	<b>5702654</b>	
Flange Part Number	<b>5706754</b>	

Note: Dimensional information for all End Journals and Bearing Supports is available on page 148. Information on required lubrication is on page 225.

# 1.500 x 0.473

## Precision Rolled Ball Screws — Inch Series

<b>Diameter x Lead (in.)</b>	1.500 x 0.473
<b>Lead Accuracy (in/ft)</b>	± 0.004
<b>Screw Weight (lbs/ft)</b>	4.5
<b>Screw Root Diameter (in.)</b>	1.14
<b>Nominal Ball Diameter (in.)</b>	0.344
<b>Number of Starts</b>	1

### Ball Screw Part Numbers

<b>Thread Direction</b>	Right Hand	Left Hand	Right Hand
<b>Screw Material</b>	Alloy Steel	Alloy Steel	Stainless Steel
<b>Standard Length</b>	240"		
<b>Maximum Length</b>	240"		
<b>Part Number</b>	<b>7820597</b>		

Ball screws can be cut to the length you require. Specify ball screw part number and overall length at time of order.

### Double Circuit, Round Ball Nut

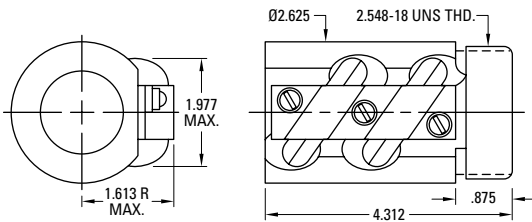

**p141** Quick Install Assembly

<b>Thread Direction</b>	Right Hand	Left Hand
<b>Nut Material</b>	Alloy Steel	
<b>Dynamic Load (lbs)</b>	10,050	
<b>Max. Static Load (lbs)</b>	57,770	
<b>Torque to raise 1 lb (oz-in.)</b>	1.34	
<b>Nut weight (lbs)</b>	3.94	
<b>Ball Nut Part Number</b>	<b>5707513</b>	
<b>Flange Part Number</b>	<b>5707573</b>	
<b>Wiper Kit Part Number</b>	<b>5702655</b>	

### Wiper and Flange Kits

#### Wiper

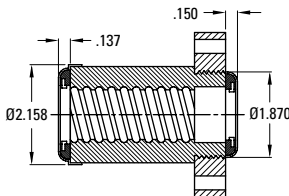

#### Flange

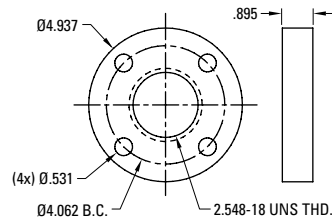

Note: Wiper kit does not include flange end cap.

<b>Wiper Part Number</b>	<b>5702655</b>	
<b>Flange Part Number</b>	<b>5707573</b>	

Note: Dimensional information for all End Journals and Bearing Supports is available on page 148. Information on required lubrication is on page 225.



**1.500 x 0.500**

**Precision Rolled Ball Screws — Inch Series**

Diameter x Lead (in.)	1.500 x 0.500
Lead Accuracy (in/ft)	± 0.004
Screw Weight (lbs/ft)	5.6
Screw Root Diameter (in.)	1.27
Nominal Ball Diameter (in.)	0.312
Number of Starts	1

**Double Circuit, Round Ball Nut with Load Lock**

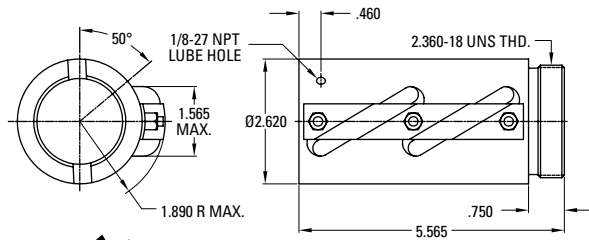

**Quick Install Assembly**

**Preloaded, Double Circuit, Round Ball Nut with Load Lock**

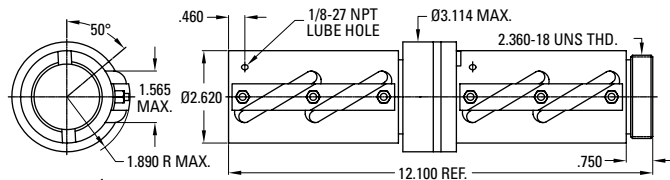

**Quick Install Assembly**

**Flange Kit**

**Flange**

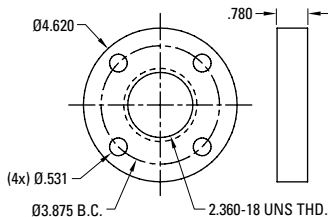

**Ball Screw Part Numbers**

Thread Direction	Right Hand	Left Hand	Right Hand
Screw Material	Alloy Steel	Alloy Steel	Stainless Steel
Standard Length	144"	144"	
Maximum Length	288"	144"	
Part Number	<b>190-9108</b>	<b>190-9109</b>	

Ball screws can be cut to the length you require. Specify ball screw part number and overall length at time of order.

Thread Direction	Right Hand	Left Hand
Nut Material	Alloy Steel	Alloy Steel
Dynamic Load (lbs)	14,513	14,513
Max. Static Load (lbs)	102,300	102,300
Torque to raise 1 lb (oz-in.)	1.42	1.42
Nut weight (lbs)	5.70	5.70
Ball Nut Part Number	<b>8115-448-016</b>	<b>8115-448-018</b>
Flange Part Number	<b>8115-448-004</b>	<b>8115-448-004</b>
Wiper Kit Part Number*	<b>Internal</b>	<b>Internal</b>

Thread Direction	Right Hand	Left Hand
Nut Material	Alloy Steel	
Dynamic Load (lbs)	14,513	
Max. Static Load (lbs)	102,300	
Torque to raise 1 lb (oz-in.)	1.42	
Nut weight (lbs)	12.20	
Ball Nut Part Number	<b>8115-448-006</b>	
Flange Part Number	<b>8115-448-004</b>	
Wiper Kit Part Number*	<b>Internal</b>	

Wiper Part Number	<b>8115-101-004</b>	
Flange Part Number	<b>8115-448-004</b>	

\* Wiper kit included with this ball nut.

Note: Dimensional information for all End Journals and Bearing Supports is available on page 148. Information on required lubrication is on page 225.

# 1.500 x 1.000

## Precision Rolled Ball Screws — Inch Series

Diameter x Lead (in.)	1.500 x 1.000
Lead Accuracy (in/ft)	± 0.004
Screw Weight (lbs/ft)	5.6
Screw Root Diameter (in.)	1.14
Nominal Ball Diameter (in.)	0.344
Number of Starts	2

### Ball Screw Part Numbers

Thread Direction	Right Hand	Left Hand	Right Hand
Screw Material	Alloy Steel	Alloy Steel	Stainless Steel
Standard Length	144"	240"	
Maximum Length	288"	240"	
Part Number	<b>7820598</b>	<b>7825925</b>	

Ball screws can be cut to the length you require. Specify ball screw part number and overall length at time of order.

### Double Circuit, Square Ball Nut

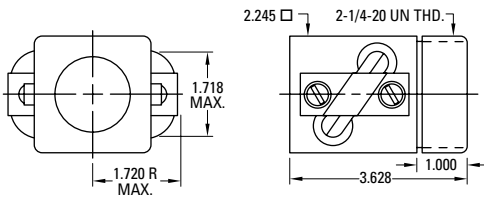

**p141** Quick Install Assembly

Thread Direction	Right Hand	Left Hand
Nut Material	Alloy Steel	Alloy Steel
Dynamic Load (lbs)	8,250	8,250
Max. Static Load (lbs)	34,662	34,662
Torque to raise 1 lb (oz-in.)	2.83	2.83
Nut weight (lbs)	3.88	3.88
Ball Nut Part Number	<b>5708280</b>	<b>5701995</b>
Flange Part Number	<b>5707777</b>	<b>5707777</b>
Wiper Kit Part Number	<b>5702657</b>	<b>5702657</b>

### Double Circuit, Square Ball Nut — High Speed

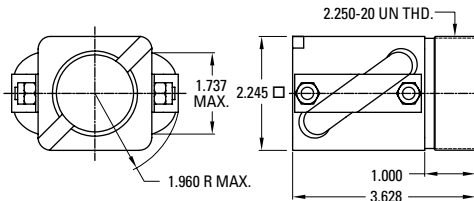

Thread Direction	Right Hand	Left Hand
Nut Material	Alloy Steel	
Dynamic Load (lbs)	8,250	
Max. Static Load (lbs)	34,662	
Torque to raise 1 lb (oz-in.)	2.83	
Nut weight (lbs)	3.88	
Ball Nut Part Number	<b>7833724</b>	
Flange Part Number	<b>5707777</b>	
Wiper Kit Part Number	<b>5702657</b>	

### Preloaded, Double Circuit, Square Ball Nut

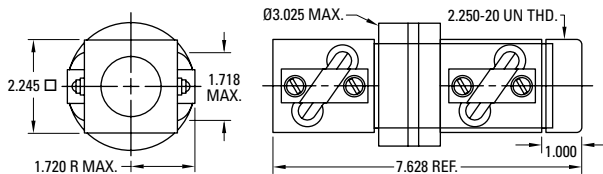

**p141** Quick Install Assembly

Thread Direction	Right Hand	Left Hand
Nut Material	Alloy Steel	
Dynamic Load (lbs)	8,250	
Max. Static Load (lbs)	34,662	
Torque to raise 1 lb (oz-in.)	2.83	
Nut weight (lbs)	8.55	
Ball Nut Part Number	<b>5700698</b>	
Flange Part Number	<b>5707777</b>	
Wiper Kit Part Number	<b>5702657</b>	

\* Wiper kit included with this ball nut.

### Wiper and Flange Kits

#### Wiper

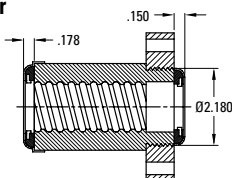

#### Flange

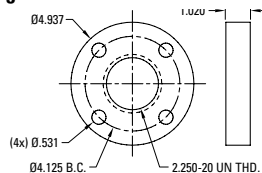

Note: Wiper kit does not include flange end cap.

Wiper Part Number	<b>5702657</b>	
Flange Part Number	<b>5707777</b>	

Note: Dimensional information for all End Journals and Bearing Supports is available on page 148. Information on required lubrication is on page 225.

## 1.500 x 1.000

## Precision Rolled Ball Screws — Inch Series

<b>Diameter x Lead (in.)</b>	1.500 x 1.000
<b>Lead Accuracy (in/ft)</b>	± 0.004
<b>Screw Weight (lbs/ft)</b>	5.6
<b>Screw Root Diameter (in.)</b>	1.14
<b>Nominal Ball Diameter (in.)</b>	0.344
<b>Number of Starts</b>	2

### Double Circuit, Round Ball Nut – High Speed

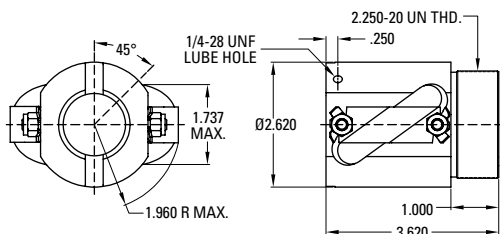

### Double Circuit, Round Ball Nut

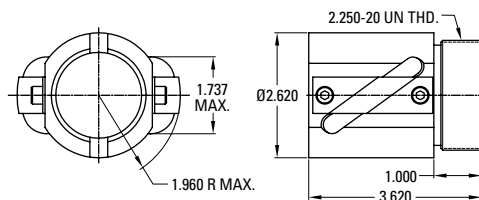

### Ball Screw Part Numbers

<b>Thread Direction</b>	Right Hand	Left Hand	Right Hand
<b>Screw Material</b>	Alloy Steel	Alloy Steel	Stainless Steel
<b>Standard Length</b>	144"		
<b>Maximum Length</b>	288"		
<b>Part Number</b>	<b>190-9107</b>		

Ball screws can be cut to the length you require. Specify ball screw part number and overall length at time of order.

<b>Thread Direction</b>	Right Hand	Left Hand
<b>Nut Material</b>	Alloy Steel	
<b>Dynamic Load (lbs)</b>	8,250	
<b>Max. Static Load (lbs)</b>	34,662	
<b>Torque to raise 1 lb (oz-in.)</b>	2.83	
<b>Nut weight (lbs)</b>	3.90	
<b>Ball Nut Part Number</b>	<b>8115-448-049</b>	
<b>Flange Part Number</b>	<b>8115-448-002</b>	
<b>Wiper Kit Part Number*</b>	<b>Integral</b>	

<b>Thread Direction</b>	Right Hand	Left Hand
<b>Nut Material</b>	Alloy Steel	
<b>Dynamic Load (lbs)</b>	8,250	
<b>Max. Static Load (lbs)</b>	34,662	
<b>Torque to raise 1 lb (oz-in.)</b>	2.83	
<b>Nut weight (lbs)</b>	3.90	
<b>Ball Nut Part Number</b>	<b>8115-448-014</b>	
<b>Flange Part Number</b>	<b>8115-448-002</b>	
<b>Wiper Kit Part Number*</b>	<b>Internal</b>	

\* Wiper kit included with this ball nut.

Note: Dimensional information for all End Journals and Bearing Supports is available on page 148. Information on required lubrication is on page 225.

**1.500 x 1.000**

**Precision Rolled Ball Screws — Inch Series**

<b>Diameter x Lead (in.)</b>	1.500 x 1.000
<b>Lead Accuracy (in/ft)</b>	± 0.004
<b>Screw Weight (lbs/ft)</b>	5.6
<b>Screw Root Diameter (in.)</b>	1.14
<b>Nominal Ball Diameter (in.)</b>	0.344
<b>Number of Starts</b>	2

**Ball Screw Part Numbers**

<b>Thread Direction</b>	Right Hand	Left Hand	Right Hand
<b>Screw Material</b>	Alloy Steel	Alloy Steel	Stainless Steel
<b>Standard Length</b>	144"		
<b>Maximum Length</b>	288"		
<b>Part Number</b>	<b>190-9107</b>		

Ball screws can be cut to the length you require. Specify ball screw part number and overall length at time of order.

**Preloaded, Double Circuit, Round Ball Nut**

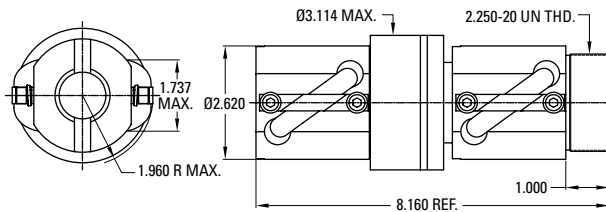

<b>Thread Direction</b>	Right Hand	Left Hand
<b>Nut Material</b>	Alloy Steel	
<b>Dynamic Load (lbs)</b>	8,250	
<b>Max. Static Load (lbs)</b>	47,800	
<b>Torque to raise 1 lb (oz-in.)</b>	2.83	
<b>Nut weight (lbs)</b>	8.60	
<b>Ball Nut Part Number</b>	<b>8115-448-011</b>	
<b>Flange Part Number</b>	<b>8115-448-002</b>	
<b>Wiper Kit Part Number*</b>	<b>Internal</b>	

**Wiper and Flange Kits**

**Wiper — 8115-101-012**

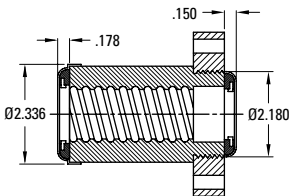

**Flange**

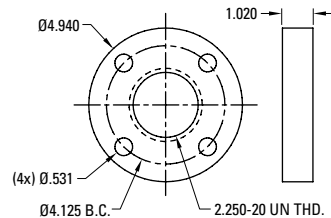

Note: Wiper kit does not include flange end cap.

<b>Wiper Part Number (RND)</b>	<b>8115-101-004</b>	
<b>Flange Part Number</b>	<b>8115-448-002</b>	

\* Wiper kit included with this ball nut.

Note: Dimensional information for all End Journals and Bearing Supports is available on page 148. Information on required lubrication is on page 225.

**1.500 x 1.875**

**Precision Rolled Ball Screws — Inch Series**

Diameter x Lead (in.)	1.500 x 1.875
Lead Accuracy (in/ft)	± 0.004
Screw Weight (lbs/ft)	5.3
Screw Root Diameter (in.)	1.19
Nominal Ball Diameter (in.)	0.281
Number of Starts	4

**Ball Screw Part Numbers**

Thread Direction	Right Hand	Left Hand
Screw Material	Alloy Steel	Alloy Steel
Standard Length	240"	
Maximum Length	240"	
Part Number	<b>7820599</b>	

Ball screws can be cut to the length you require. Specify ball screw part number and overall length at time of order.

**Double Circuit, Square Ball Nut**

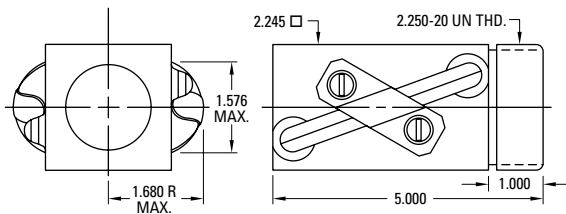

**p141** Quick Install Assembly

Thread Direction	Right Hand	Left Hand
Nut Material	Alloy Steel	
Dynamic Load (lbs)	7,242	
Max. Static Load (lbs)	29,895	
Torque to raise 1 lb (oz-in.)	5.31	
Nut weight (lbs)	4.22	
Ball Nut Part Number	<b>5707654</b>	
Flange Part Number	<b>5707777</b>	
Wiper Kit Part Number	<b>5702658</b>	

**Preloaded, Double Circuit, Square Ball Nut**

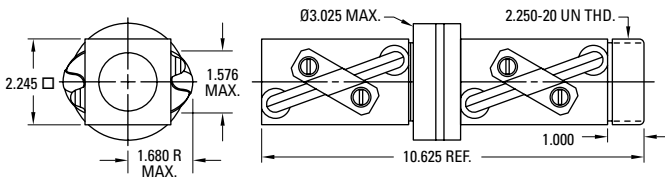

**p141** Quick Install Assembly

Thread Direction	Right Hand	Left Hand
Nut Material	Alloy Steel	
Dynamic Load (lbs)	7,242	
Max. Static Load (lbs)	29,895	
Torque to raise 1 lb (oz-in.)	5.31	
Nut weight (lbs)	9.93	
Ball Nut Part Number	<b>5704272</b>	
Flange Part Number	<b>5707777</b>	
Wiper Kit Part Number	<b>5702658</b>	

**Quad Circuit, Square Ball Nut**

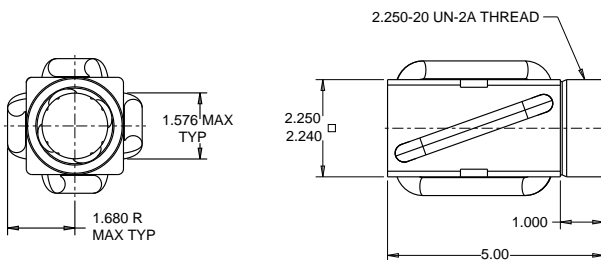

Thread Direction	Right Hand	Left Hand
Nut Material	Alloy Steel	
Dynamic Load (lbs)	14,484	
Max. Static Load (lbs)	59,790	
Torque to raise 1 lb (oz-in.)	5.31	
Nut weight (lbs)	4.25	
Ball Nut Part Number	<b>7833714</b>	
Flange Part Number	<b>5707777</b>	
Wiper Kit Part Number	<b>5702658</b>	

**Wiper and Flange Kits**

**Wiper**

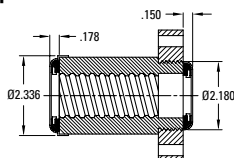

**Flange**

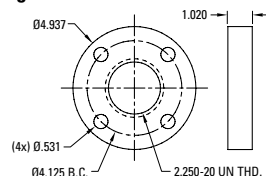

Note: Wiper kit does not include flange end cap.

Wiper Part Number	<b>5702658</b>	
Flange Part Number	<b>5707777</b>	

Note: Dimensional information for all End Journals and Bearing Supports is available on page 148. Information on required lubrication is on page 225.

**1.500 x 2.000**

**Precision Rolled Ball Screws — Inch Series**

Diameter x Lead (in.)	1.500 x 2.000
Lead Accuracy (in/ft)	± 0.004
Screw Weight (lbs/ft)	5.6
Screw Root Diameter (in.)	1.21
Nominal Ball Diameter (in.)	0.281
Number of Starts	4

**Ball Screw Part Numbers**

Thread Direction	Right Hand	Left Hand	Right Hand
Screw Material	Alloy Steel	Alloy Steel	Stainless Steel
Standard Length	144"		
Maximum Length	288"		
Part Number	<b>190-9345</b>		

Ball screws can be cut to the length you require. Specify ball screw part number and overall length at time of order.

**Double Circuit, Round Ball Nut with Load Lock**

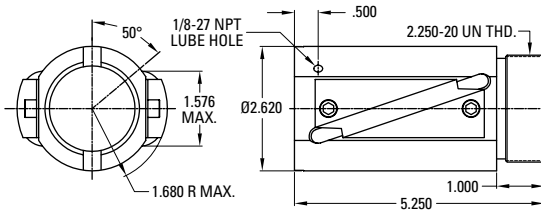

**p141** Quick Install Assembly

Thread Direction	Right Hand	Left Hand
Nut Material	Alloy Steel	
Dynamic Load (lbs)	7,600	
Max. Static Load (lbs)	29,000	
Torque to raise 1 lb (oz-in.)	5.66	
Nut weight (lbs)	5.00	
Ball Nut Part Number	<b>8115-448-056</b>	
Flange Part Number	<b>8115-448-002</b>	
Wiper Kit Part Number*	Internal	

**Double Circuit, Round Ball Nut with Load Lock — High Speed**

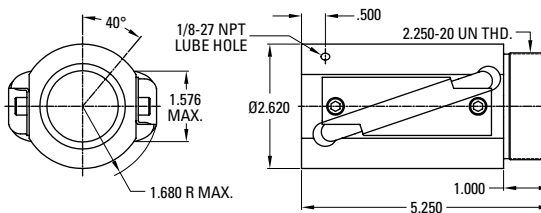

Thread Direction	Right Hand	Left Hand
Nut Material	Alloy Steel	
Dynamic Load (lbs)	7,600	
Max. Static Load (lbs)	29,000	
Torque to raise 1 lb (oz-in.)	5.66	
Nut weight (lbs)	5.00	
Ball Nut Part Number	<b>8115-448-057</b>	
Flange Part Number	<b>8115-448-002</b>	
Wiper Kit Part Number*	Internal	

**Flange Kit**

**Flange**

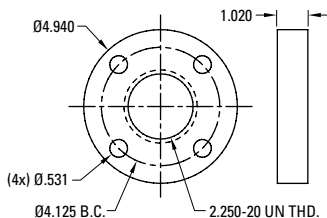

Wiper Part Number	<b>8115-101-004</b>	
Flange Part Number	<b>8115-448-002</b>	

\* Wiper kit included with this ball nut.

Note: Dimensional information for all End Journals and Bearing Supports is available on page 148. Information on required lubrication is on page 225.

**2.000 x 0.500**

**Precision Rolled Ball Screws — Inch Series**

<b>Diameter x Lead (in.)</b>	2.000 x 0.500
<b>Lead Accuracy (in/ft)</b>	± 0.004
<b>Screw Weight (lbs/ft)</b>	9.8
<b>Screw Root Diameter (in.)</b>	1.72
<b>Nominal Ball Diameter (in.)</b>	0.375
<b>Number of Starts</b>	1

**Double Circuit, Round Ball Nut with Load Lock**

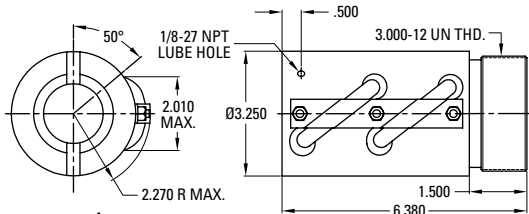

**p141** Quick Install Assembly

**Preloaded, Double Circuit, Round Ball Nut with Load Lock**

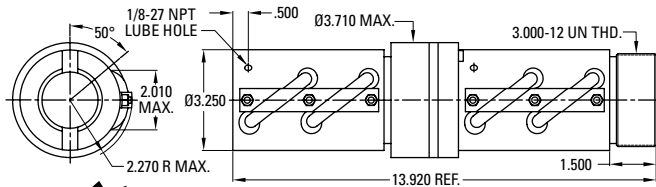

**p141** Quick Install Assembly

**Flange Kit**

**Flange**

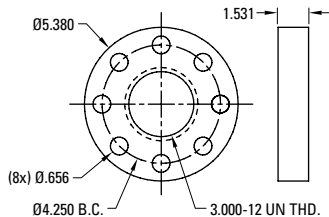

**Ball Screw Part Numbers**

<b>Thread Direction</b>	Right Hand	Left Hand	Right Hand
<b>Screw Material</b>	Alloy Steel	Alloy Steel	Stainless Steel
<b>Standard Length</b>	144"	144"	
<b>Maximum Length</b>	288"	288"	
<b>Part Number</b>	<b>190-9112</b>	<b>190-9113</b>	

Ball screws can be cut to the length you require. Specify ball screw part number and overall length at time of order.

<b>Thread Direction</b>	Right Hand	Left Hand
<b>Nut Material</b>	Alloy Steel	Alloy Steel
<b>Dynamic Load (lbs)</b>	18,500	18,500
<b>Max. Static Load (lbs)</b>	154,635	154,635
<b>Torque to raise 1 lb (oz-in.)</b>	1.42	1.42
<b>Nut weight (lbs)</b>	8.00	8.00
<b>Ball Nut Part Number</b>	<b>8120-448-011</b>	<b>8120-448-013</b>
<b>Flange Part Number</b>	<b>8120-448-002</b>	<b>8120-448-002</b>
<b>Wiper Kit Part Number*</b>	<b>Internal</b>	<b>Internal</b>

<b>Thread Direction</b>	Right Hand	Left Hand
<b>Nut Material</b>	Alloy Steel	Alloy Steel
<b>Dynamic Load (lbs)</b>	18,500	18,500
<b>Max. Static Load (lbs)</b>	154,635	154,635
<b>Torque to raise 1 lb (oz-in.)</b>	1.42	1.42
<b>Nut weight (lbs)</b>	19.25	19.25
<b>Ball Nut Part Number</b>	<b>8120-448-006</b>	<b>8120-448-007</b>
<b>Flange Part Number</b>	<b>8120-448-002</b>	<b>8120-448-002</b>
<b>Wiper Kit Part Number*</b>	<b>Internal</b>	<b>Internal</b>

<b>Wiper Part Number</b>	<b>8120-101-002</b>	
<b>Flange Part Number</b>	<b>8120-448-002</b>	

\* Wiper kit included with this ball nut.

Note: Dimensional information for all End Journals and Bearing Supports is available on page 148. Information on required lubrication is on page 225.

## 2.000 x 1.000

## Precision Rolled Ball Screws — Inch Series

Diameter x Lead (in.)	2.000 x 1.000
Lead Accuracy (in/ft)	± 0.004
Screw Weight (lbs/ft)	9.8
Screw Root Diameter (in.)	1.72
Nominal Ball Diameter (in.)	0.375
Number of Starts	2

### Ball Screw Part Numbers

Thread Direction	Right Hand	Left Hand	Right Hand
Screw Material	Alloy Steel	Alloy Steel	Stainless Steel
Standard Length	144"		
Maximum Length	288"		
Part Number	<b>190-9111</b>		

Ball screws can be cut to the length you require. Specify ball screw part number and overall length at time of order.

### Double Circuit, Round Ball Nut with Load Lock

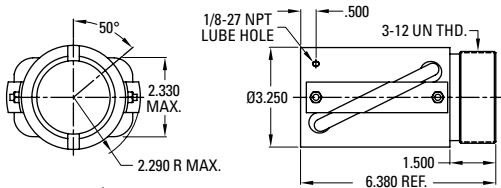

**p141** Quick Install Assembly

Thread Direction	Right Hand	Left Hand
Nut Material	Alloy Steel	
Dynamic Load (lbs)	21,200	
Max. Static Load (lbs)	152,605	
Torque to raise 1 lb (oz-in.)	2.83	
Nut weight (lbs)	8.00	
Ball Nut Part Number	<b>8120-448-021</b>	
Flange Part Number	<b>8120-448-002</b>	
Wiper Kit Part Number*	Internal	

### Preloaded, Double Circuit, Round Ball Nut with Load Lock

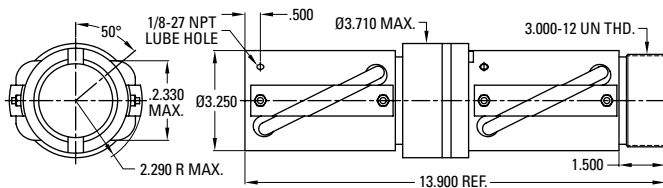

**p141** Quick Install Assembly

Thread Direction	Right Hand	Left Hand
Nut Material	Alloy Steel	
Dynamic Load (lbs)	21,200	
Max. Static Load (lbs)	152,605	
Torque to raise 1 lb (oz-in.)	2.83	
Nut weight (lbs)	19.25	
Ball Nut Part Number	<b>8120-448-019</b>	
Flange Part Number	<b>8120-448-002</b>	
Wiper Kit Part Number*	Internal	

### Flange Kit

#### Flange

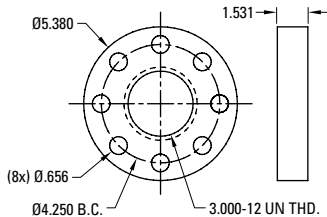

Wiper Part Number	<b>8120-101-002</b>	
Flange Part Number	<b>8120-448-002</b>	

\* Wiper kit included with this ball nut.

Note: Dimensional information for all End Journals and Bearing Supports is available on page 148. Information on required lubrication is on page 225.



## 2.250 x 0.500

## Precision Rolled Ball Screws — Inch Series

<b>Diameter x Lead (in.)</b>	2.250 x 0.500
<b>Lead Accuracy (in/ft)</b>	± 0.004
<b>Screw Weight (lbs/ft)</b>	10.9
<b>Screw Root Diameter (in.)</b>	1.85
<b>Nominal Ball Diameter (in.)</b>	0.375
<b>Number of Starts</b>	1

### Double Circuit, Round Ball Nut with Load Lock

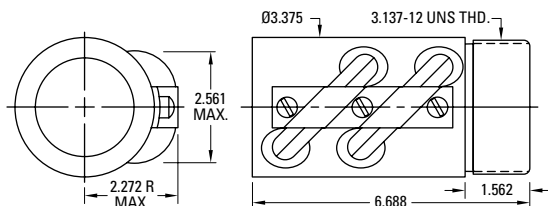

### Flange Kit

#### Flange

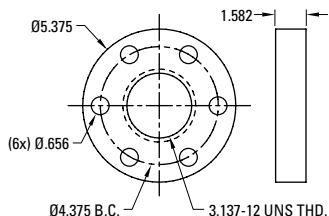

### Ball Screw Part Numbers

Thread Direction	Right Hand	Left Hand	Right Hand
<b>Screw Material</b>	Alloy Steel	Alloy Steel	Stainless Steel
<b>Standard Length</b>	240"	240"	
<b>Maximum Length</b>	240"	240"	
<b>Part Number</b>	<b>7820600</b>	<b>7820602</b>	

Ball screws can be cut to the length you require. Specify ball screw part number and overall length at time of order.

Thread Direction	Right Hand	Left Hand
<b>Nut Material</b>	Alloy Steel	Alloy Steel
<b>Dynamic Load (lbs)</b>	21,306	21,306
<b>Max. Static Load (lbs)</b>	161,150	161,150
<b>Torque to raise 1 lb (oz-in.)</b>	1.42	1.42
<b>Nut weight (lbs)</b>	8.25	8.25
<b>Ball Nut Part Number</b>	<b>7833235</b>	<b>5704000<sup>(1)</sup></b>
<b>Flange Part Number</b>	<b>5707574</b>	<b>5707574</b>
<b>Wiper Kit Part Number*</b>	<b>Internal</b>	<b>Internal</b>

(1) Load Lock not available

<b>Wiper Part Number</b>	<b>5702659</b>
<b>Flange Part Number</b>	<b>5707574</b>

\* Wiper kit included with this ball nut.

Note: Dimensional information for all End Journals and Bearing Supports is available on page 148. Information on required lubrication is on page 225.

## 2.250 x 1.000

## Precision Rolled Ball Screws — Inch Series

<b>Diameter x Lead (in.)</b>	2.250 x 1.000
<b>Lead Accuracy (in/ft)</b>	± 0.004
<b>Screw Weight (lbs/ft)</b>	10.9
<b>Screw Root Diameter (in.)</b>	1.85
<b>Nominal Ball Diameter (in.)</b>	0.375
<b>Number of Starts</b>	2

### Ball Screw Part Numbers

<b>Thread Direction</b>	Right Hand	Left Hand	Right Hand
<b>Screw Material</b>	Alloy Steel	Alloy Steel	Stainless Steel
<b>Standard Length</b>	240"		
<b>Maximum Length</b>	240"		
<b>Part Number</b>	<b>7820604</b>		

Ball screws can be cut to the length you require. Specify ball screw part number and overall length at time of order.

### Double Circuit, Round Ball Nut

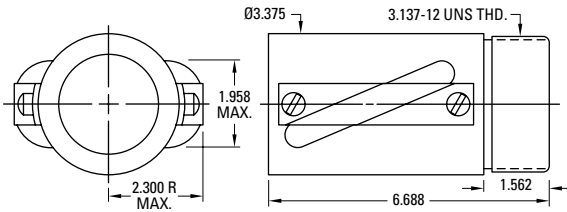

<b>Thread Direction</b>	Right Hand	Left Hand
<b>Nut Material</b>	Alloy Steel	
<b>Dynamic Load (lbs)</b>	26,538	
<b>Max. Static Load (lbs)</b>	161,150	
<b>Torque to raise 1 lb (oz-in.)</b>	2.83	
<b>Nut weight (lbs)</b>	8.25	
<b>Ball Nut Part Number</b>	<b>5704555</b>	
<b>Flange Part Number</b>	<b>5707574</b>	
<b>Wiper Kit Part Number*</b>	<b>Internal</b>	

### Flange Kit

#### Flange

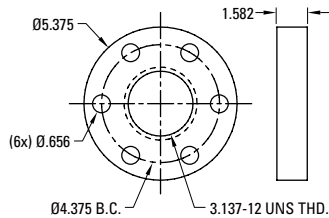

<b>Wiper Part Number</b>	<b>5702659</b>	
<b>Flange Part Number</b>	<b>5707574</b>	

\* Wiper kit included with this ball nut.

Note: Dimensional information for all End Journals and Bearing Supports is available on page 148. Information on required lubrication is on page 225.

## 2.500 x 0.250

## Precision Rolled Ball Screws — Inch Series

<b>Diameter x Lead (in.)</b>	2.500 x 0.250
<b>Lead Accuracy (in/ft)</b>	± 0.004
<b>Screw Weight (lbs/ft)</b>	15.5
<b>Screw Root Diameter (in.)</b>	2.32
<b>Nominal Ball Diameter (in.)</b>	0.156
<b>Number of Starts</b>	1

### Triple Circuit, Round Ball Nut

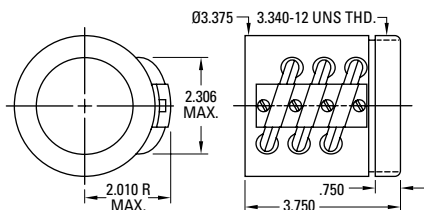

### Preloaded, Triple Circuit, Round Ball Nut with Integral Flange

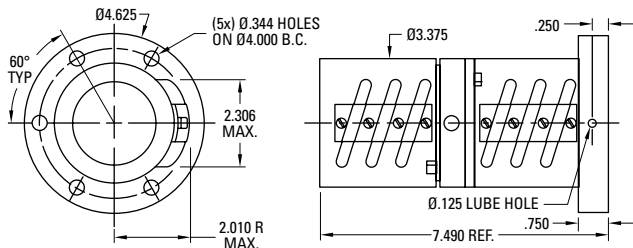

### Flange Kit

#### Flange

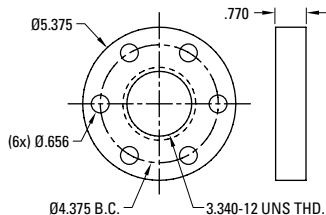

### Ball Screw Part Numbers

<b>Thread Direction</b>	Right Hand	Left Hand	Right Hand
<b>Screw Material</b>	Alloy Steel	Alloy Steel	Stainless Steel
<b>Standard Length</b>	240"		
<b>Maximum Length</b>	240"		
<b>Part Number</b>	<b>7820606</b>		

Ball screws can be cut to the length you require. Specify ball screw part number and overall length at time of order.

<b>Thread Direction</b>	Right Hand	Left Hand
<b>Nut Material</b>	Alloy Steel	
<b>Dynamic Load (lbs)</b>	6,315	
<b>Max. Static Load (lbs)</b>	81,938	
<b>Torque to raise 1 lb (oz-in.)</b>	0.71	
<b>Nut weight (lbs)</b>	4.72	
<b>Ball Nut Part Number</b>	<b>5703243</b>	
<b>Flange Part Number</b>	<b>5703263</b>	
<b>Wiper Kit Part Number*</b>	<b>Internal</b>	

<b>Thread Direction</b>	Right Hand	Left Hand
<b>Nut Material</b>	Alloy Steel	
<b>Dynamic Load (lbs)</b>	6,315	
<b>Max. Static Load (lbs)</b>	81,938	
<b>Torque to raise 1 lb (oz-in.)</b>	0.71	
<b>Nut weight (lbs)</b>	9.94	
<b>Ball Nut Part Number</b>	<b>7823590</b>	
<b>Flange Part Number</b>	<b>Integral</b>	
<b>Wiper Kit Part Number</b>	<b>Internal</b>	

<b>Wiper Part Number</b>	<b>5703324</b>	
<b>Flange Part Number</b>	<b>5703263</b>	

\* Wiper kit included with this ball nut.

Note: Dimensional information for all End Journals and Bearing Supports is available on page 148. Information on required lubrication is on page 225.

## 2.500 x 0.500

## Precision Rolled Ball Screws — Inch Series

<b>Diameter x Lead (in.)</b>	2.500 x 0.500
<b>Lead Accuracy (in/ft)</b>	± 0.004
<b>Screw Weight (lbs/ft)</b>	15.0
<b>Screw Root Diameter (in.)</b>	2.22
<b>Nominal Ball Diameter (in.)</b>	0.375
<b>Number of Starts</b>	1

### Ball Screw Part Numbers

<b>Thread Direction</b>	Right Hand	Left Hand	Right Hand
<b>Screw Material</b>	Alloy Steel	Alloy Steel	Stainless Steel
<b>Standard Length</b>	144"		
<b>Maximum Length</b>	288"		
<b>Part Number</b>	<b>190-9116</b>		

Ball screws can be cut to the length you require. Specify ball screw part number and overall length at time of order.

### Double Circuit, Round Ball Nut with Load Lock

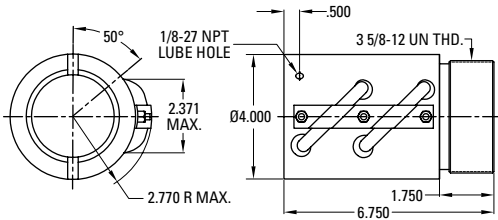

<b>Thread Direction</b>	Right Hand	Left Hand
<b>Nut Material</b>	Alloy Steel	
<b>Dynamic Load (lbs)</b>	22,981	
<b>Max. Static Load (lbs)</b>	186,000	
<b>Torque to raise 1 lb (oz-in.)</b>	1.42	
<b>Nut weight (lbs)</b>	13.00	
<b>Ball Nut Part Number</b>	<b>8125-448-010</b>	
<b>Flange Part Number</b>	<b>8125-448-002</b>	
<b>Wiper Kit Part Number*</b>	<b>Internal</b>	

### Flange Kit

#### Flange

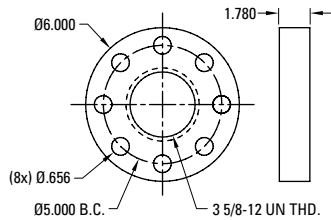

<b>Wiper Part Number</b>	<b>8125-101-002</b>	
<b>Flange Part Number</b>	<b>8125-448-002</b>	

\* Wiper kit included with this ball nut.

Note: Dimensional information for all End Journals and Bearing Supports is available on page 148. Information on required lubrication is on page 225.

## 2.500 x 1.000

## Precision Rolled Ball Screws — Inch Series

<b>Diameter x Lead (in.)</b>	2.500 x 1.000
<b>Lead Accuracy (in/ft)</b>	± 0.004
<b>Screw Weight (lbs/ft)</b>	15.0
<b>Screw Root Diameter (in.)</b>	2.22
<b>Nominal Ball Diameter (in.)</b>	0.375
<b>Number of Starts</b>	2

### Double Circuit, Round Ball Nut with Load Lock

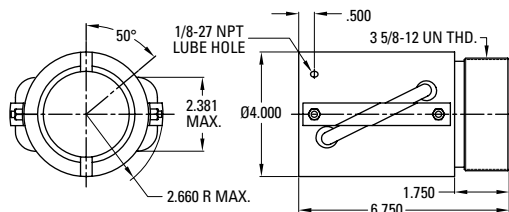

### Flange Kit

#### Flange

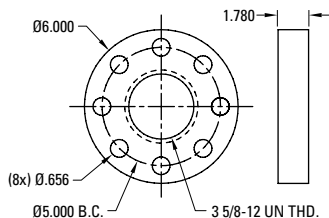

### Ball Screw Part Numbers

<b>Thread Direction</b>	Right Hand	Left Hand	Right Hand
<b>Screw Material</b>	Alloy Steel	Alloy Steel	Stainless Steel
<b>Standard Length</b>	144"		
<b>Maximum Length</b>	288"		
<b>Part Number</b>	<b>190-9115</b>		

Ball screws can be cut to the length you require. Specify ball screw part number and overall length at time of order.

<b>Thread Direction</b>	Right Hand	Left Hand
<b>Nut Material</b>	Alloy Steel	
<b>Dynamic Load (lbs)</b>	27,000	
<b>Max. Static Load (lbs)</b>	174,000	
<b>Torque to raise 1 lb (oz-in.)</b>	2.83	
<b>Nut weight (lbs)</b>	13.00	
<b>Ball Nut Part Number</b>	<b>8125-448-008</b>	
<b>Flange Part Number</b>	<b>8125-448-002</b>	
<b>Wiper Kit Part Number*</b>	<b>Internal</b>	

<b>Wiper Part Number</b>	<b>8125-101-002</b>	
<b>Flange Part Number</b>	<b>8125-448-002</b>	

\* Wiper kit included with this ball nut.

Note: Dimensional information for all End Journals and Bearing Supports is available on page 148. Information on required lubrication is on page 225.

## 3.000 x 0.660

## Precision Rolled Ball Screws — Inch Series

<b>Diameter x Lead (in.)</b>	3.000 x 0.660
<b>Lead Accuracy (in/ft)</b>	± 0.004
<b>Screw Weight (lbs/ft)</b>	18.3
<b>Screw Root Diameter (in.)</b>	2.48
<b>Nominal Ball Diameter (in.)</b>	0.500
<b>Number of Starts</b>	1

### Ball Screw Part Numbers

<b>Thread Direction</b>	Right Hand	Left Hand	Right Hand
<b>Screw Material</b>	Alloy Steel	Alloy Steel	Stainless Steel
<b>Standard Length</b>	144"		
<b>Maximum Length</b>	288"		
<b>Part Number</b>	<b>190-9117</b>		

Ball screws can be cut to the length you require. Specify ball screw part number and overall length at time of order.

### Triple Circuit, Round Ball Nut with Load Lock

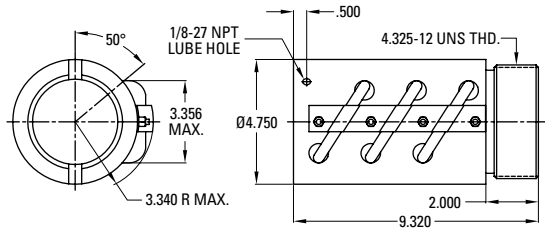

<b>Thread Direction</b>	Right Hand	Left Hand
<b>Nut Material</b>	Alloy Steel	
<b>Dynamic Load (lbs)</b>	44,316	
<b>Max. Static Load (lbs)</b>	323,950	
<b>Torque to raise 1 lb (oz-in.)</b>	1.87	
<b>Nut weight (lbs)</b>	26.00	
<b>Ball Nut Part Number</b>	<b>8130-448-007</b>	
<b>Flange Part Number</b>	<b>8130-448-002</b>	
<b>Wiper Kit Part Number*</b>	<b>Internal</b>	

### Flange Kit

#### Flange

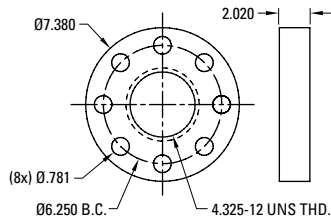

<b>Wiper Part Number</b>	<b>8130-101-002</b>	
<b>Flange Part Number</b>	<b>8130-448-002</b>	

\* Wiper kit included with this ball nut.

Note: Dimensional information for all End Journals and Bearing Supports is available on page 148. Information on required lubrication is on page 225.

# 3.000 x 1.500

## Precision Rolled Ball Screws — Inch Series

<b>Diameter x Lead (in.)</b>	3.000 x 1.500
<b>Lead Accuracy (in/ft)</b>	± 0.004
<b>Screw Weight (lbs/ft)</b>	19.3
<b>Screw Root Diameter (in.)</b>	2.48
<b>Nominal Ball Diameter (in.)</b>	0.500
<b>Number of Starts</b>	2

### Double Circuit, Round Ball Nut

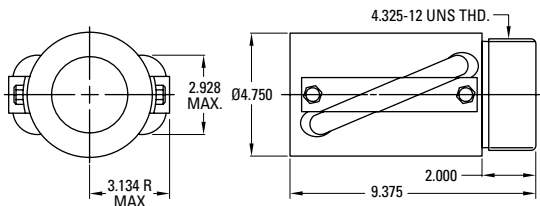

### Flange Kit

#### Flange

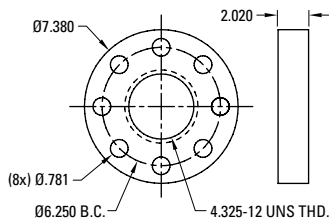

### Ball Screw Part Numbers

<b>Thread Direction</b>	Right Hand	Left Hand	Right Hand
<b>Screw Material</b>	Alloy Steel	Alloy Steel	Stainless Steel
<b>Standard Length</b>	240"		
<b>Maximum Length</b>	240"		
<b>Part Number</b>	<b>7820609</b>		

Ball screws can be cut to the length you require. Specify ball screw part number and overall length at time of order.

<b>Thread Direction</b>	Right Hand	Left Hand
<b>Nut Material</b>	Alloy Steel	
<b>Dynamic Load (lbs)</b>	53,646	
<b>Max. Static Load (lbs)</b>	253,617	
<b>Torque to raise 1 lb (oz-in.)</b>	4.25	
<b>Nut weight (lbs)</b>	27.2	
<b>Ball Nut Part Number</b>	<b>5704986</b>	
<b>Flange Part Number</b>	<b>5707575</b>	
<b>Wiper Kit Part Number*</b>	<b>Internal</b>	

<b>Wiper Part Number</b>	<b>5702661</b>	
<b>Flange Part Number</b>	<b>5707575</b>	

\* Wiper kit included with this ball nut.

Note: Dimensional information for all End Journals and Bearing Supports is available on page 148. Information on required lubrication is on page 225.

## 4.000 x 1.000

## Precision Rolled Ball Screws — Inch Series

<b>Diameter x Lead (in.)</b>	4.000 x 1.000
<b>Lead Accuracy (in/ft)</b>	± 0.004
<b>Screw Weight (lbs/ft)</b>	34.4
<b>Screw Root Diameter (in.)</b>	3.34
<b>Nominal Ball Diameter (in.)</b>	0.625
<b>Number of Starts</b>	1

### Ball Screw Part Numbers

<b>Thread Direction</b>	Right Hand	Left Hand	Right Hand
<b>Screw Material</b>	Alloy Steel	Alloy Steel	Stainless Steel
<b>Standard Length</b>	240"		
<b>Maximum Length</b>	240"		
<b>Part Number</b>	<b>5703262</b>		

Ball screws can be cut to the length you require. Specify ball screw part number and overall length at time of order.

### Triple Circuit, Round Ball Nut with Load Lock

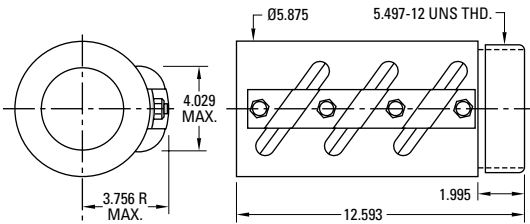

<b>Thread Direction</b>	Right Hand	Left Hand
<b>Nut Material</b>	Alloy Steel	
<b>Dynamic Load (lbs)</b>	85,758	
<b>Max. Static Load (lbs)</b>	476,970	
<b>Torque to raise 1 lb (oz-in.)</b>	2.83	
<b>Nut weight (lbs)</b>	53.5	
<b>Ball Nut Part Number</b>	<b>5703258</b>	
<b>Flange Part Number</b>	<b>5703307</b>	
<b>Wiper Kit Part Number*</b>	<b>Internal</b>	

### Flange Kit

#### Flange

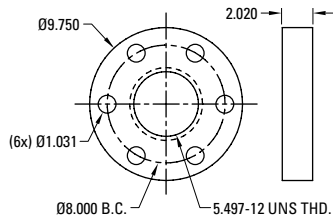

<b>Wiper Part Number</b>	<b>5703306</b>	
<b>Flange Part Number</b>	<b>5703307</b>	

\* Wiper kit included with this ball nut.

Note: Dimensional information for all End Journals and Bearing Supports is available on page 148. Information on required lubrication is on page 225.



## Visual Product Reference — Precision Rolled Ball Screws — Inch Series

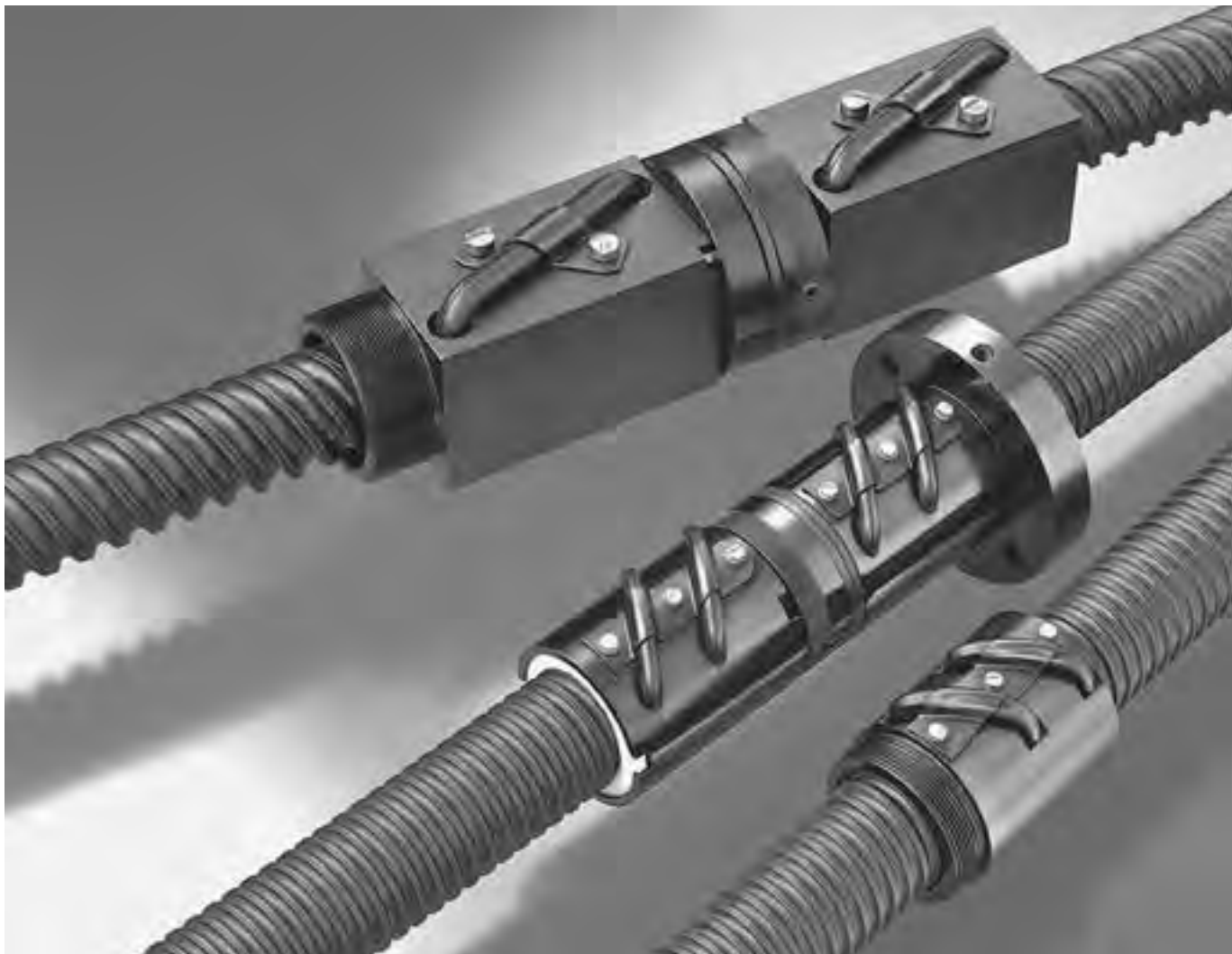

### Current and Historical Standard & Custom Ball Screw Components, Inch Series

The Visual Product Reference section is intended to document the many standard and custom ball screw components that have been produced by Thomson and Warner Linear. This section is intended to help identify existing customer product that may or may not be still shown as featured product in this catalog. Most of these products remain readily available for sale and can be ordered using the part numbers shown. The following tables are organized by ball nut shape and then sorted by ball circle diameter (BCD) and lead. Please contact the factory for assistance if the correct ball nut or screw cannot be identified or for any additional questions.

Need a quote or have a question about an application?  
Contact us in North America at:

Phone: 540-633-3549

Fax: 540-639-4162

Email: [thomson@thomsonlinear.com](mailto:thomson@thomsonlinear.com)

## Visual Product Reference — Precision Rolled Ball Screws — Inch Series

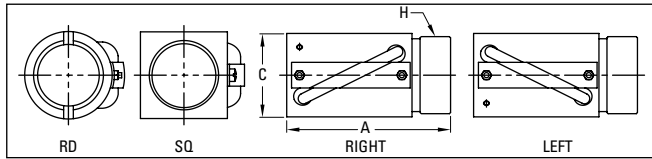

**Type A**

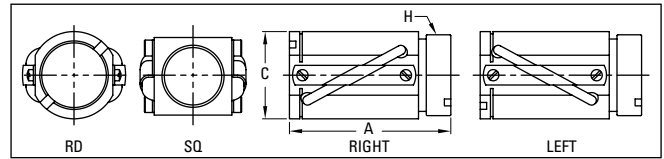

**Type B**

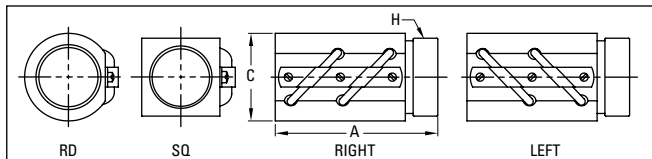

**Type C**

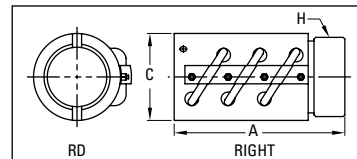

**Type D**

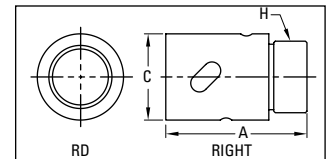

**Type E**

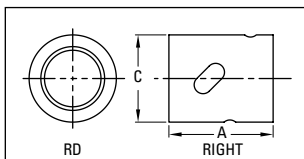

**Type F**

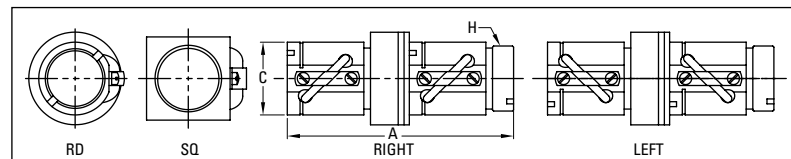

**Type G**

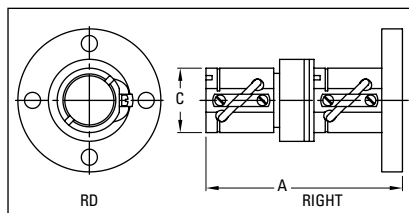

**Type H**

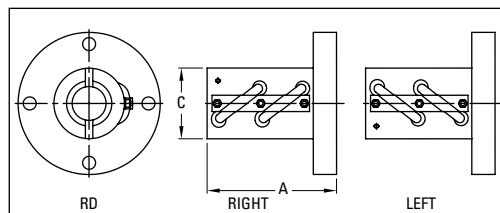

**Type J**

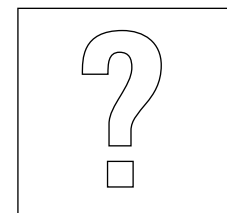

**Type Other**

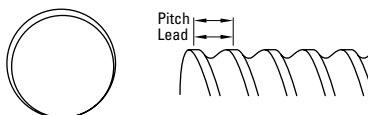

**Single Start**

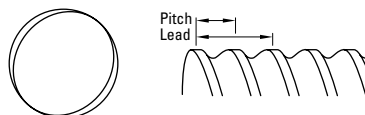

**Double Start**

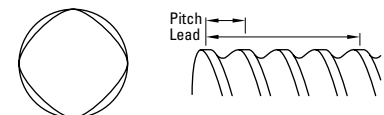

**Four Start**

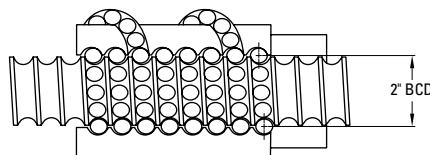

**Ball Circle Diameter (BCD)**



**Left Hand Screw**

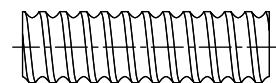

**Right Hand Screw**

### Visual Product Reference Instructions

1. Visually determine the ball nut "Type" based on the above figures.
2. Narrow the choice by selecting the appropriate ball circle diameter (BCD) and lead as defined in the figure above.
3. If the ball nut has an identifying model number, this will uniquely identify the nut as shown in the 4th column of the tables. Unmarked nuts are listed as Thomson and will require dimensions to identify.
4. Count the number of ball return circuits and match to column 5.
5. Measure length, width/diameter, and V-thread (if applicable) of the ball nut and match to columns 6 – 8.
6. Determine if the thread direction is left or right by matching nut or screw (screw direction is shown in figure above) to provided figures and locating in column 9.
7. If the ball nut is not available, determine the number of starts of the screw (integral number of independent threads — see figures above), measure the screw major diameter, and measure the screw lead (distance between two adjacent turns of the screw — see figure above). Screw information is provided in columns 11 – 13.
8. Determine if the screw and/or nut material is either carbon steel (STEEL) or stainless steel (SS) and locate in column 14. Carbon steel nuts are coated with black oxide or other finish to prevent corrosion.

## Visual Product Reference — Precision Rolled Ball Screws — Inch Series

### Type A

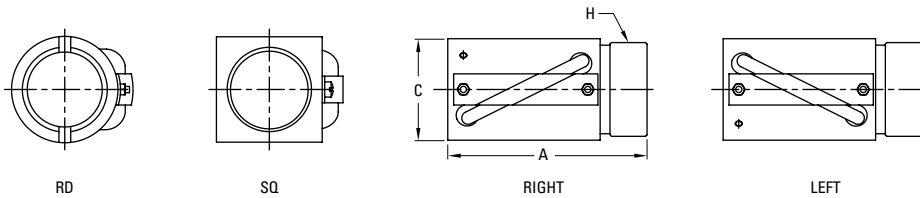

**Return:** Single Circuit  
**Shape:** Round or Square  
**Mounting:** V-Thread  
**Backlash:** Non-preloaded

BCD (in.)	Lead (in.)	Shape	Nut Model	No. of Circuits	Length (in.) "A"	Width/Dia. (in.) "C"	V-Thd. "H"	Thd. Dir.	No. of Starts	Major Screw Dia.	Mat'l	Nut P/N	Screw P/N	Flange P/N	Wiper P/N	Cat. Page
0.375	0.125	RD	Thomson	1	1.000	0.750	0.664-32	RH	1	0.365	STEEL	5709574	5707538	5706751	N/A	46
0.375	0.125	RD	Thomson	1	1.000	0.750	0.664-32	LH	1	0.365	STEEL	5709576	5708532	5706751	N/A	46
0.375	0.125	RD	Thomson	1	1.000	0.750	0.664-32	RH	1	0.365	SS	5709578	5706540	N/A	N/A	46
0.375	0.125	RD	Thomson	1	1.170	0.750	11/16-28	RH	1	0.370	STEEL	7831870	7824974	N/A	N/A	
0.500	0.200	RD	RC0505	1	1.750	1.062	0.875-14	RH	1	0.482	STEEL	8105-448-023	190-9097	N/A	8105-101-002	49
0.631	0.200	RD	Thomson	1	1.710	1.125	1-16	RH	1	0.620	STEEL	7832206	5707540	7832920	N/A	
0.631	0.200	RD	RC0605	1	1.710	1.125	15/16-16	RH	1	0.610	STEEL	8106-448-009	190-9098	8105-448-002	8106-101-002	52
0.631	0.200	RD	RE0605	1	1.710	1.125	15/16-16	LH	1	0.610	STEEL	8106-448-007	190-9099	8105-448-002	8106-101-002	
0.631	0.200	RD	RK0605	1	1.710	1.125	15/16-16	LH	1	0.610	STEEL	8106-448-008	190-9099	8105-448-002	8106-101-002	52
0.631	0.200	SQ	Thomson	1	1.710	1.000	15/16-16	RH	1	0.620	SS	5707645	5705378	N/A	5702647	52
0.631	0.200	SQ	Thomson	1	1.710	1.000	15/16-16	RH	1	0.620	STEEL	7820827	5707540	5707570	5702647	
0.631	0.200	SQ	Thomson	1	1.710	1.000	15/16-16	LH	1	0.620	STEEL	7820828	5707541	5707570	5702647	
0.631	0.200	SQ	RQ0605	1	1.710	1.000	15/16-16	RH	1	0.610	STEEL	8106-448-010	190-9098	8105-448-002	N/A	
0.631	0.200	SQ	RQ0605	1	1.710	1.000	15/16-16	RH	1	0.610	STEEL	8106-448-022	190-9098	8105-448-002	N/A	52
0.631	0.200	SQ	RR0605	1	1.710	1.000	15/16-16	LH	1	0.610	STEEL	8106-448-026	190-9099	8105-448-002	N/A	52
0.631	0.200	SQ	RR0605	1	1.710	1.000	15/16-16	LH	1	0.610	STEEL	8106-448-011	190-9099	8105-448-002	N/A	
0.750	0.200	RD	RC0705	1	1.880	1.312	1.173-18	RH	1	0.765	STEEL	8107-448-017	190-9101	8107-448-007	8107-101-002	
0.750	0.200	RD	RC0705	1	1.880	1.312	1.173-18	RH	1	0.765	STEEL	8107-448-018	190-9101	8107-448-007	8107-101-002	56
0.750	0.200	RD	RC0705	1	1.880	1.312	1.25-18	RH	1	0.765	STEEL	8107-448-047	190-9101	N/A	N/A	56
0.750	0.200	RD	RC0705STH	1	1.880	1.312	1.125-18	RH	1	0.765	STEEL	8107-448-026	190-9101	N/A	N/A	56
1.000	0.250	RD	RC1004	1	2.350	1.687	1-9/16-18	RH	1	0.985	STEEL	8110-448-029	190-9104	8110-448-002	8110-101-002	
1.000	0.250	RD	RC1004	1	2.350	1.687	1-9/16-18	RH	1	0.985	STEEL	8110-448-032	190-9104	8110-448-002	8110-101-002	62
1.000	0.250	RD	RK1004	1	2.350	1.687	1-9/16-18	LH	1	0.985	STEEL	8110-448-030	190-9105	8110-448-002	8110-101-002	62
1.000	0.250	SQ	Thomson	1	2.347	1.500	1.563-18	RH	1	0.985	STEEL	5707508	7820426	5707571	5702649	
1.000	0.250	SQ	Thomson	1	2.347	1.500	1.563-18	LH	1	0.985	STEEL	5707535	7820428	5707571	5702649	
1.000	0.250	SQ	RQ1004	1	2.347	1.500	1.563-18	RH	1	0.985	STEEL	8110-448-055	190-9104	8110-448-002	N/A	62

Note: Manganese Phosphate coating provided as standard finish on Thomson ball screws not featured in catalog pages.

## Visual Product Reference — Precision Rolled Ball Screws — Inch Series

### Type B

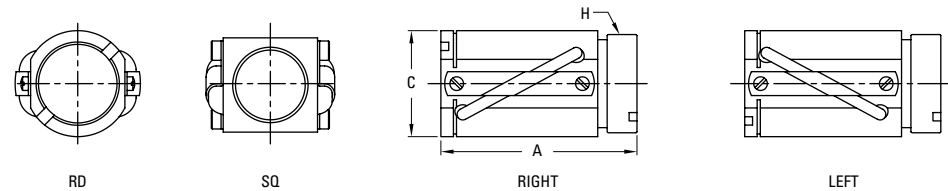

**Return:** Double Circuit  
**Shape:** Round or Square  
**Mounting:** V-Thread  
**Backlash:** Non-preloaded

BCD (in.)	Lead (in.)	Shape	Nut Model	No. of Circuits	Length (in.) "A"	Width/Dia. (in.) "C"	V-Thd. "H"	Thd. Dir.	No. of Starts	Major Screw Dia.	Mat'l	Nut P/N	Screw P/N	Flange P/N	Wiper P/N	Cat. Page
0.500	0.500	RD	R-0502	2	2.750	1.062	15/16-16	RH	2	0.510	STEEL	8105-448-011	190-9096	8105-448-002	8105-101-002	51
0.500	0.500	RD	R-0502	2	2.750	1.060	15/16-16	RH	2	0.510	STEEL	8105-448-014	190-9096	8105-448-002	8105-101-002	51
0.500	0.500	RD	R-0502	2	2.750	1.062	15/16-16	RH	2	0.510	SS	8105-448-016	190-9010	8105-448-002	8105-101-002	51
0.500	0.500	RD	RS0502	2	2.750	1.062	15/16-16	RH	2	0.510	SS	8105-448-016	190-9010	8105-448-002	8105-101-002	
0.500	0.500	SQ	Thomson	2	1.875	1.000	15/16-16	RH	2	0.490	STEEL	5709582	5706740	5707570	N/A	
0.500	0.500	SQ	Thomson	2	1.875	1.000	15/16-16	RH	2	0.490	SS	5709584	5706846	N/A	N/A	
0.631	0.200	RD	RC0605	2	1.710	1.125	15/16-16	RH	1	0.610	STEEL	8106-448-006	190-9098	8105-448-002	8106-101-002	
0.631	1.000	RD	Thomson	2	1.710	1.125	15/16-16	RH	2	0.620	STEEL	7826713	7826712	5707570	7827527	55
0.750	0.500	RD	Thomson	2	2.995	1.300	1.25-18	RH	2	0.729	STEEL	7824358	7824361	7823336	7824337	
0.750	0.500	RD	R-0702	2	2.930	1.312	1-1/4-16	RH	2	0.765	STEEL	8107-448-014	190-9100	8107-448-002	8107-101-002	51
0.750	0.500	RD	R-0702	2	2.930	1.312	1.25-18	RH	2	0.765	STEEL	8107-448-048	190-9100	N/A	N/A	59
0.750	0.500	RD	R-0702	2	2.930	1.312	1.173-18	RH	2	0.765	STEEL	8107-448-049	190-9100	8107-448-007	8107-448-002	59
0.750	0.500	RD	RS0702	2	2.930	1.312	1-1/4-16	RH	2	0.765	SS	8107-448-020	190-9006	8107-448-020	8107-101-002	59
1.000	0.500	RD	Thomson	2	3.120	1.625	1-9/16-18	RH	2	0.974	STEEL	7824286	7824290	5707571	7824292	
1.000	0.500	RD	R-1002	2	3.120	1.687	1-9/16-18	RH	2	1.015	STEEL	8110-448-022	190-9103	8110-448-002	8110-101-002	65
1.000	1.000	RD	R-1001	2	3.000	1.687	1-9/16-18	RH	4	0.985	STEEL	8110-448-020	190-9102	8110-448-002	8110-101-002	66
1.000	1.000	RD	RS1001	2	3.000	1.687	1-9/16-18	RH	4	0.985	SS	8110-448-034	190-9150	8110-448-002	8110-101-002	66
1.000	1.000	SQ	Thomson	2	3.000	1.500	1.563-18	RH	4	0.985	STEEL	5707509	7820429	5707571	5702650	
1.000	1.000	SQ	RF1001	2	3.000	1.500	1.563-18	RH	4	0.985	STEEL	8110-448-086	190-9102	8110-448-002	N/A	66
1.500	1.000	RD	R-1501	2	3.620	2.620	2-1/4-20	RH	2	1.480	STEEL	8115-448-014	190-9107	8115-448-002	8115-101-002	75
1.500	1.000	RD	RH1501	2	3.620	2.620	2-1/4-20	RH	2	1.480	STEEL	8115-448-049	190-9107	8115-448-002	8115-101-004	75
1.500	1.000	SQ	Thomson	2	3.628	2.250	2-1/4-20	LH	2	1.480	STEEL	5701995	7825925	5707777	5702657	
1.500	1.000	SQ	Thomson	2	3.628	2.250	2-1/4-20	RH	2	1.480	STEEL	5708280	7820598	5707777	5702657	
1.500	1.000	SQ	Thomson	2	3.628	2.250	2-1/4-20	RH	2	1.480	STEEL	20019711-10	7820598	5707777	5702657	
1.500	1.000	SQ	Thomson	2	3.628	2.245	2-1/4-20	RH	2	1.480	STEEL	5708280	7820598	5707777	5702657	74
1.500	1.000	SQ	Thomson	2	3.628	2.245	2-1/4-20	RH	2	1.480	STEEL	7833724	7820598	5707777	5702657	74
1.500	1.000	SQ	Thomson	2	3.628	2.245	2-1/4-20	LH	2	1.480	STEEL	5701995	7825925	5707777	5702657	74
1.500	1.875	SQ	Thomson	2	5.000	2.250	2-1/4-20	RH	4	1.480	STEEL	5707654	7820599	5707777	5702658	77
1.500	2.000	RD	R-1520	2	5.260	2.620	2-1/4-20	RH	4	1.435	STEEL	8115-448-056	190-9345	8115-448-002	8115-101-004	78
1.500	2.000	RD	RH1520 HS	2	5.260	2.620	2-1/4-20	RH	4	1.435	STEEL	8115-448-057	190-9345	8115-448-002	8115-101-004	78
2.000	1.000	RD	R-2001	2	6.380	3.250	3-12	RH	2	2.045	STEEL	8120-448-021	190-9111	8120-448-002	8120-101-002	80
2.250	1.000	RD	Thomson	2	6.688	3.375	3.137-12	RH	2	2.230	STEEL	5704555	7820604	5707574	5702659	82
2.500	1.000	RD	R-2501	2	6.750	4.000	3-5/8-12	RH	2	2.545	STEEL	8125-448-008	190-9115	8125-448-002	8125-448-002	85
3.000	1.500	RD	Thomson	2	9.313	4.750	4.325-12	RH	2	2.910	STEEL	5704986	7820609	5707575	5702661	87
4.000	1.000	RD	Thomson	3	12.593	5.875	5.497-12	RH	1	3.785	STEEL	5703258	5703262	5703307	5703306	88

Note: Manganese Phosphate coating provided as standard finish on Thomson ball screws not featured in catalog pages.

## Visual Product Reference — Precision Rolled Ball Screws — Inch Series

### Type C

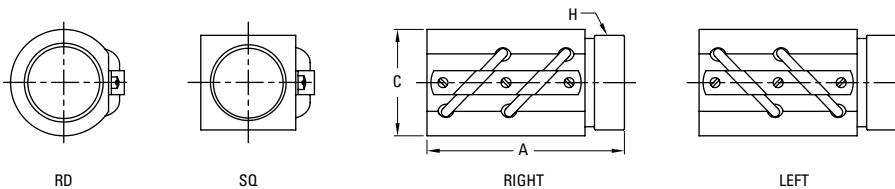

**Return:** Double Circuit  
**Shape:** Round or Square  
**Mounting:** V-Thread  
**Backlash:** Non-preloaded

BCD (in.)	Lead (in.)	Shape	Nut Model	No. of Circuits	Length (in.) "A"	Width/Dia. (in.) "C"	V-Thd. "H"	Thd. Dir.	No. of Starts	Major Screw Dia.	Mat'l	Nut P/N	Screw P/N	Flange P/N	Wiper P/N	Cat. Page
0.375	0.125	RD	Thomson	2	1.875	0.750	0.664-32	RH	1	0.365	STEEL	5707502	5707538	5706751	N/A	
0.375	0.125	RD	Thomson	2	1.875	0.750	0.664-32	RH	1	0.365	SS	5707643	5706540	N/A	N/A	
0.375	0.125	RD	Thomson	2	1.875	0.750	0.664-32	LH	1	0.365	STEEL	5708282	5708532	5706751	N/A	
0.375	0.125	RD	R-0308	2	1.880	0.781	11/16-24	RH	1	0.380	STEEL	8103-448-003	190-9217	8103-448-002	8103-101-002	47
0.375	0.125	RD	R-0308LN	2	1.875	0.781	0.664-32	RH	1	0.380	STEEL	8103-448-013	190-9217	N/A	8103-101-002	47
0.500	0.200	RD	Thomson	2	2.600	1.030	15/16-16	RH	1	0.482	STEEL	7826720	7826721	5707570	7826759	
0.500	0.200	RD	R-0505	2	2.750	1.062	15/16-16	RH	1	0.510	STEEL	8105-448-013	190-9097	8105-448-002	8105-101-002	50
0.631	0.200	SQ	R-0605	2	2.860	1.000	15/16-16	RH	1	0.610	STEEL	8106-448-036	190-9098	8105-448-002	N/A	53
0.631	0.200	SQ	R-0605	2	2.030	1.000	15/16-16	LH	1	0.610	STEEL	8106-448-037	190-9099	8105-448-002	N/A	54
0.750	0.200	RD	Thomson	2	2.635	1.300	1.25-18	RH	1	0.727	STEEL	7824297	7824298	7823336	7824337	
0.750	0.200	RD	R-0705	2	2.880	1.312	1.173-18	RH	1	0.765	STEEL	8107-448-016	190-9101	8107-448-007	8107-101-002	57
0.750	0.200	RD	R-0705	2	2.880	1.312	1.25-18	RH	1	0.765	STEEL	8107-448-046	190-9101	N/A	N/A	57
0.750	0.200	RD	R-0705STH	2	2.880	1.312	1.125-18	RH	1	0.765	STEEL	8107-448-027	190-9101	N/A	N/A	57
0.875	0.200	RD	Thomson	2	2.704	1.615	1-3/8-16	RH	1	0.852	STEEL	5708277	5708859	5708281	7831512	61
1.000	0.250	RD	R-1004	2	3.130	1.687	1-9/16-18	RH	1	0.985	STEEL	8110-448-026	190-9104	8110-448-002	8110-101-002	63
1.000	0.250	RD	RL1004	2	3.130	1.687	1-9/16-18	LH	1	0.985	STEEL	8110-448-024	190-9105	8100-448-002	8110-101-002	63
1.000	0.250	SQ	Thomson	2	3.000	1.500	1.563-18	RH	1	0.985	STEEL	5700348	7820426	5707571	5702649	
1.000	0.250	SQ	RF1004	2	3.000	1.500	1.563-18	RH	1	0.985	STEEL	8110-448-056	190-9104	8110-448-002	N/A	62
1.150	0.200	RD	Thomson	2	2.500	1.687	1-5/8-20	RH	1	1.130	STEEL	5701566	7820430	5708283	5702652	
1.150	0.200	RD	Thomson	2	2.500	1.687	1-5/8-20	LH	1	1.130	STEEL	7820207	7820431	5708283	5702652	
1.150	0.200	RD	R-1105	2	2.500	1.687	1-5/8-20	RH	1	1.130	STEEL	8111-448-006	190-9106	8111-448-002	8111-101-002	69
1.171	0.413	RD	Thomson	2	3.375	2.125	1.967-18	RH	1	1.160	STEEL	5707511	7820432	5707572	5702653	70
1.500	0.250	RD	Thomson	2	2.875	2.088	1.967-18	LH	1	1.485	STEEL	5701990	7820596	5706754	5702654	71
1.500	0.250	RD	Thomson	2	2.875	2.088	1.967-18	RH	1	1.485	STEEL	5709587	7820595	5706754	5702654	
1.500	0.250	RD	Thomson	2	2.875	2.088	1.967-18	RH	1	1.485	STEEL	7833233	7820595	5706754	5702654	71
1.500	0.250	RD	R-1504	2	3.250	2.093	1.967-18	RH	1	1.515	STEEL	8115-448-020	190-9110	8115-448-009	8115-101-006	
1.500	0.473	RD	Thomson	2	4.312	2.625	2.548-18	RH	1	1.470	STEEL	5707513	7820597	5707573	5702655	72
1.500	0.473	RD	Thomson	2	3.625	2.625	N/A	RH	1	1.470	STEEL	5708345	7820597	N/A	5702656	
1.500	0.473	RD	R-1547	2	4.307	2.620	2.548-18	RH	1	1.415	STEEL	8115-448-055	190-9328	8115-448-064	8115-101-004	
1.500	0.500	RD	Thomson	2	5.590	2.623	2.375-16	RH	1	1.470	STEEL	7824246	7824253	7824250	7824251	
1.500	0.500	RD	R-1502	2	5.565	2.620	2.360-18	RH	1	1.535	STEEL	8115-448-016	190-9108	8115-448-018	8115-101-004	73
1.500	0.500	RD	RL1502	2	5.565	2.620	2.360-18	LH	1	1.535	STEEL	8115-448-018	190-9109	8115-448-004	8115-101-004	73
2.000	0.500	RD	R-2002	2	6.380	3.250	3-12	RH	1	2.045	STEEL	8120-448-011	190-9112	8120-448-002	8120-101-002	79
2.000	0.500	RD	RL2002	2	6.380	3.250	3-12	LH	1	2.045	STEEL	8120-448-013	190-9113	8120-448-002	8120-101-002	79
2.250	0.500	RD	Thomson	2	6.688	3.375	3.137-12	LH	1	2.230	STEEL	5704000	7820602	5707574	5702659	81
2.250	0.500	RD	Thomson	2	6.688	3.375	3.137-12	RH	1	2.230	STEEL	5707516	7820600	5707574	5702659	
2.250	0.500	RD	Thomson	2	6.688	3.375	3.137-12	RH	1	2.230	STEEL	7833235	7820600	5707574	5702659	81
2.250	0.500	RD	Thomson	2	5.250	3.376	N/A	RH	1	2.230	STEEL	5708346	7820600	N/A	5702659	
2.250	0.500	RD	Thomson	2	5.250	3.376	N/A	LH	1	2.230	STEEL	7830722	7820602	N/A	5702659	
2.250	0.500	RD	R-2202	2	6.680	3.370	3.137-12	RH	1	2.180	STEEL	8122-448-005	190-9114	N/A	8122-101-002	
2.500	0.500	RD	Thomson	2	6.750	3.625	3.5-12	RH	1	2.480	STEEL	7824136	7824262	7824141	7824140	
2.500	0.500	RD	R-2502	2	6.750	4.000	3-5/8-12	RH	1	2.545	STEEL	8125-448-010	190-9116	8125-448-002	8125-101-002	84

Note: Manganese Phosphate coating provided as standard finish on Thomson ball screws not featured in catalog pages.



## Visual Product Reference — Precision Rolled Ball Screws — Inch Series

### Type D

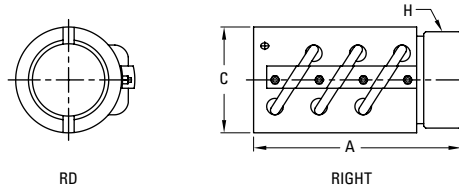

**Return:** Triple Circuit  
**Shape:** Round  
**Mounting:** V-Thread  
**Backlash:** Non-preloaded

BCD (in.)	Lead (in.)	Shape	Nut Model	No. of Circuits	Length (in.) "A"	Width/Dia. (in.) "C"	V-Thd. "H"	Thd. Dir.	No. of Starts	Major Screw Dia.	Mat'l	Nut P/N	Screw P/N	Flange P/N	Wiper P/N	Cat. Page
2.500	0.250	RD	Thomson	3	3.750	3.375	3.34-12	RH	1	2.485	STEEL	5703243	7820606	5703263	5703324	83
3.000	0.660	RD	Thomson	3	9.313	4.750	4.325-12	RH	1	2.965	STEEL	5707519	7820607	5707575	5702661	
3.000	0.660	RD	Thomson	3	7.000	4.750	N/A	RH	1	2.965	STEEL	5708347	7820607	N/A	5702662	
3.000	0.660	RD	R-3066	3	9.320	4.750	4.325-12	RH	1	2.950	STEEL	8130-448-007	190-9117	8130-448-002	8130-101-002	86
4.000	1.000	RD	Thomson	3	12.593	5.875	5.497-12	RH	1	3.795	STEEL	5703258	5703262	5703307	5703306	88
6.000	1.000	RD	Thomson	3	14.438	9.000	8.5-8	RH	1	5.795	STEEL	5704738	5704762	5704764	5704746	

### Type E

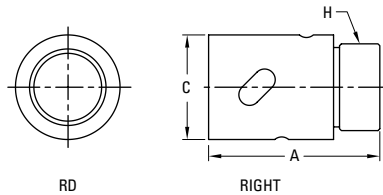

**Return:** Single-Liner  
**Shape:** Round  
**Mounting:** V-Thread  
**Backlash:** Non-preloaded

BCD (in.)	Lead (in.)	Shape	Nut Model	No. of Circuits	Length (in.) "A"	Width/Dia. (in.) "C"	V-Thd. "H"	Thd. Dir.	No. of Starts	Major Screw Dia.	Mat'l	Nut P/N	Screw P/N	Flange P/N	Wiper P/N	Cat. Page
0.375	0.125	RD	RC0308	1	0.988	0.825	11/16-24	RH	1	0.380	STEEL	8103-448-008	190-9217	N/A	8103-101-002	
0.631	0.200	RD	Thomson	3	1.850	1.130	15/16-16	RH	1	0.620	STEEL	7832872	7832873	5707570	INTEGRAL	54

### Type F

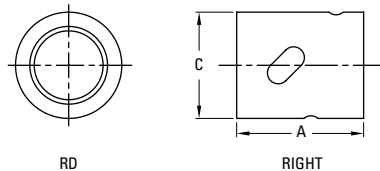

**Return:** Single-Liner  
**Shape:** Round  
**Mounting:** Cylindrical  
**Backlash:** Non-preloaded

BCD (in.)	Lead (in.)	Shape	Nut Model	No. of Circuits	Length (in.) "A"	Width/Dia. (in.) "C"	V-Thd. "H"	Thd. Dir.	No. of Starts	Major Screw Dia.	Mat'l	Nut P/N	Screw P/N	Flange P/N	Wiper P/N	Cat. Page
0.187	0.050	RD	Thomson	2	0.594	0.500	N/A	RH	1	0.178	SS	7821609	7821634	N/A	N/A	44
0.187	0.050	RD	Thomson	2	0.594	0.500	N/A	RH	1	0.178	EPOXY	7821632	7821634	N/A	N/A	
0.187	0.063	RD	Thomson	2	0.594	0.500	N/A	RH	1	0.178	SS	7821579	7821633	N/A	N/A	45
0.187	0.063	RD	Thomson	2	0.594	0.500	N/A	RH	1	0.178	EPOXY	7821631	7821633	N/A	N/A	

Note: Manganese Phosphate coating provided as standard finish on Thomson ball screws not featured in catalog pages.

## Visual Product Reference — Precision Rolled Ball Screws — Inch Series

### Type G

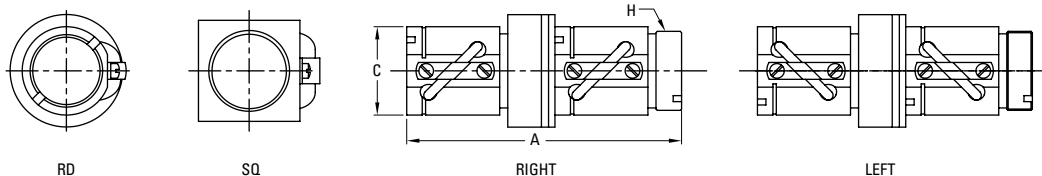

**Return:** See Table  
**Shape:** Round or Square  
**Mounting:** V-Thread  
**Backlash:** Preloaded

BCD (in.)	Lead (in.)	Shape	Nut Model	No. of Circuits	Length (in.) "A"	Width/Dia. (in.) "C"	V-Thd. "H"	Thd. Dir.	No. of Starts	Major Screw Dia.	Mat'l	Nut P/N	Screw P/N	Flange P/N	Wiper P/N	Cat. Page
0.375	0.125	RD	RP0308	2 X 2	4.130	0.781	11/16-24	RH	1	0.380	STEEL	8103-448-004	190-9217	N/A	8103-101-002	
0.500	0.200	RD	RP0505	2 X 2	5.950	1.062	15/16-16	RH	1	0.510	STEEL	8105-448-008	190-9097	8105-448-002	8105-101-002	50
0.500	0.500	RD	RP0502	2 X 2	6.000	1.060	15/16-16	RH	2	0.510	SS	8105-448-009	190-9096	8105-448-002	8105-101-002	
0.500	0.500	SQ	Thomson	2 X 2	3.875	1.000	15/16-16	RH	2	0.490	STEEL	7826767	5706740	5707570	N/A	
0.631	0.200	RD	RD0605	2 X 1	3.550	1.125	15/16-16	RH	1	0.610	STEEL	8106-448-015	190-9098	8105-448-002	8106-101-002	53
0.631	0.200	RD	RE0605	2 X 1	3.550	1.125	15/16-16	LH	1	0.610	STEEL	8106-448-019	190-9099	8105-448-002	8106-101-002	53
0.631	0.200	SQ	Thomson	2 X 1	3.510	1.000	15/16-16	RH	1	0.620	STEEL	7820955	5707540	5707570	5702647	
0.631	0.200	SQ	Thomson	2 X 1	3.510	1.000	15/16-16	LH	1	0.620	STEEL	7820956	5707541	5707570	5702647	
0.631	0.200	SQ	RDO605	2 X 1	3.825	1.000	15/16-16	RH	1	0.610	STEEL	8106-448-012	190-9098	8105-448-002	N/A	53
0.631	1.000	RD	Thomson	2 X 2	3.440	1.125	15/16-16	RH	4	0.620	STEEL	7827531	7826712	5707570	7827527	55
0.750	0.200	RD	RD0705	2 X 1	4.080	1.312	1.173-18	RH	1	0.765	STEEL	8107-448-025	190-9101	8107-448-007	8107-101-002	58
0.750	0.500	RD	Thomson	2 X 2	5.750	1.300	1.25-18	RH	2	0.729	STEEL	7826991	7824361	7823336	7824337	
0.750	0.500	RD	RP0705	2 X 2	6.180	1.312	1.250-16	RH	1	0.765	STEEL	8107-448-011	190-9100	8107-448-002	8107-101-002	60
1.000	0.250	SQ	Thomson	2 X 1	4.847	1.500	1.563-18	RH	1	0.985	STEEL	5704167	7820426	5707571	5702649	64
1.000	0.250	SQ	Thomson	2 X 1	4.847	1.500	1.563-18	LH	1	0.985	STEEL	5704168	7820428	5707571	5702649	64
1.000	0.500	RD	RP1002	2 X 2	6.640	1.687	1.563-18	RH	2	1.015	STEEL	8110-448-016	190-9103	8110-448-002	8110-101-002	65
1.000	1.000	SQ	Thomson	2	6.000	1.500	1.563-18	RH	4	0.985	STEEL	7829720	7820429	5707571	5702650	
1.150	0.200	RD	Thomson	2 X 1	3.704	1.687	1-5/8-20	RH	1	1.130	STEEL	5704270	7820430	5708283	5702652	
1.150	0.200	RD	Thomson	2 X 1	3.704	1.687	1-5/8-20	LH	1	1.130	STEEL	7820206	7820431	5708283	5702652	
1.150	0.200	RD	RP1105	2 X 2	5.500	1.687	1.625-20	RH	1	1.130	STEEL	8111-448-004	190-9106	8111-448-002	8111-101-002	69
1.500	0.250	RD	Thomson	2 X 2	6.375	2.088	1.967-18	RH	1	1.485	STEEL	5704271	7820595	5706754	5702654	
1.500	0.250	RD	Thomson	2 X 2	6.375	2.088	1.967-18	RH	1	1.485	STEEL	7833234	7820595	5706754	5702654	71
1.500	0.250	RD	Thomson	2 X 2	6.375	2.088	1.967-18	LH	1	1.485	STEEL	5704573	7820596	5706754	5702654	71
1.500	0.500	RD	RP1502	2 X 2	12.100	2.620	2.360-18	RH	1	1.535	STEEL	8115-448-006	190-9108	8115-448-004	8115-101-004	73
1.500	1.000	RD	RP1501	2 X 2	8.160	2.620	2-1/4-20	RH	2	1.480	STEEL	8115-448-011	190-9107	8115-448-002	8115-101-004	75
1.500	1.000	SQ	Thomson	2 X 2	7.628	2.250	2-1/4-20	RH	2	1.480	STEEL	5700698	7820598	5707777	5702657	76
1.500	1.875	SQ	Thomson	2 X 2	10.625	2.245	2-1/4-20	RH	4	1.480	STEEL	5704272	7820599	5707777	5702658	77
2.000	0.500	RD	RP2002	2 X 2	13.920	3.250	3-12	RH	1	2.045	STEEL	8120-448-006	190-9112	8120-448-002	8120-101-002	79
2.000	0.500	RD	RT2002	2 X 2	13.920	3.250	3-12	LH	1	2.045	STEEL	8120-448-007	190-9113	8120-448-002	8120-101-002	79
2.000	1.000	RD	RP2001	2 X 2	13.900	3.250	3-12	RH	2	2.045	STEEL	8120-448-019	190-9111	8120-448-002	8120-101-002	80

Note: Manganese Phosphate coating provided as standard finish on Thomson ball screws not featured in catalog pages.

## Visual Product Reference — Precision Rolled Ball Screws — Inch Series

### Type H

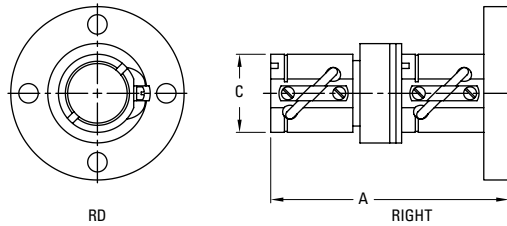

**Return:** See Table  
**Shape:** Round  
**Mounting:** Flange  
**Backlash:** Preloaded

BCD (in.)	Lead (in.)	Shape	Nut Model	No. of Circuits	Length (in.) "A"	Width/ Dia. (in.) "C"	V-Thd. "H"	Thd. Dir.	No. of Starts	Major Screw Dia.	Mat'l	Nut P/N	Screw P/N	Flange P/N	Wiper P/N	Cat. Page
0.631	0.200	RD	Thomson	2 X 1	3.775	1.130	N/A	RH	1	0.620	STEEL	7823584	5707540	INTEGRAL	INTEGRAL	
0.875	0.200	RD	Thomson	2 X 1	3.835	1.250	N/A	RH	1	0.852	STEEL	7823585	5708859	INTEGRAL	INTEGRAL	
0.875	0.200	RD	Thomson	2 X 1	3.835	1.250	N/A	RH	1	0.852	STEEL	7833677	5708859	INTEGRAL	INTEGRAL	61
1.000	0.250	RD	Thomson	2 X 1	4.438	1.620	N/A	RH	1	0.985	STEEL	7823586	7820426	INTEGRAL	INTEGRAL	64
1.150	0.200	RD	Thomson	2 X 1	3.821	1.688	N/A	RH	4	1.130	STEEL	7823587	7820430	INTEGRAL	INTEGRAL	68
1.500	0.250	RD	Thomson	2 X 2	6.845	2.088	N/A	RH	1	1.485	STEEL	7823588	7820595	INTEGRAL	INTEGRAL	
2.250	0.500	RD	Thomson	2 X 2	13.787	3.375	N/A	RH	1	2.230	STEEL	7823589	7820600	INTEGRAL	INTEGRAL	
2.500	0.250	RD	Thomson	2 X 3	7.490	3.375	N/A	RH	1	2.485	STEEL	7823590	7820606	INTEGRAL	INTEGRAL	83
3.000	0.660	RD	Thomson	2 X 3	18.549	4.750	N/A	RH	1	2.965	STEEL	5703045	7820607	INTEGRAL	INTEGRAL	

### Type J

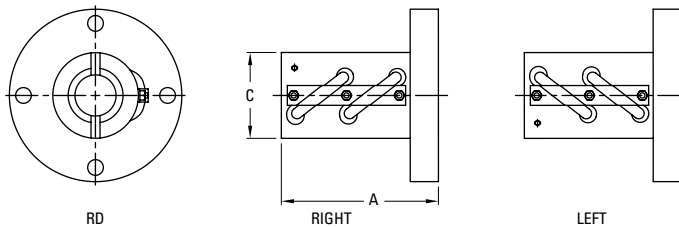

**Return:** Double Circuit  
**Shape:** Round  
**Mounting:** Flange  
**Backlash:** Non-preloaded

BCD (in.)	Lead (in.)	Shape	Nut Model	No. of Circuits	Length (in.) "A"	Width/ Dia. (in.) "C"	V-Thd. "H"	Thd. Dir.	No. of Starts	Major Screw Dia.	Mat'l	Nut P/N	Screw P/N	Flange P/N	Wiper P/N	Cat. Page
1.000	0.250	RD	Thomson	2	3.000	1.625	N/A	RH	1	0.985	STEEL	5708278	7820426	INTEGRAL	5702651	
1.000	0.250	RD	Thomson	2	3.000	1.625	N/A	LH	1	0.985	STEEL	5708284	7820428	INTEGRAL	5702651	
1.000	0.250	RD	R-1004F	2	3.000	1.625	N/A	RH	1	0.985	STEEL	8110-448-087	190-9104	INTEGRAL	5702651	63
1.000	0.250	RD	RL1004F	2	3.000	1.625	N/A	LH	1	0.985	STEEL	8110-448-088	190-9105	INTEGRAL	5702651	63

Note: Manganese Phosphate coating provided as standard finish on Thomson ball screws not featured in catalog pages.



## Visual Product Reference — Precision Rolled Ball Screws — Inch Series

### Type Other



**Return:** See Table

**Shape:** Miscellaneous

**Mounting:** Miscellaneous

**Backlash:** Miscellaneous

BCD (in.)	Lead (in.)	Shape	Nut Model	No. of Circuits	Length (in.) "A"	Width/ Dia. (in.) "C"	V-Thd. "H"	Thd. Dir.	No. of Starts	Major Screw Dia.	Mat'l	Nut P/N	Screw P/N	Flange P/N	Wiper P/N	Cat. Page
0.312	0.100	RD	Thomson	4	1.180	0.625	0.586-32	RH	1	0.292	STEEL	<b>7832875</b>	<b>7832897</b>	N/A	N/A	
0.375	0.063	RD	Thomson	8	1.180	0.750	11/16-32	RH	1	0.3685	STEEL	<b>7832874</b>	<b>7832894</b>	N/A	N/A	
0.375	0.125	RD	Thomson	1	0.677	0.749	N/A	RH	1	0.482	STEEL	<b>7824973</b>	<b>7824974</b>	N/A	N/A	
0.500	0.200	RD	Thomson	3	1.660	0.943	N/A	RH	1	0.482	STEEL	<b>7826763</b>	<b>7826721</b>	N/A	<b>INTEGRAL</b>	
0.500	0.500	RD	Thomson	2	1.500	1.320	N/A	RH	2	0.490	STEEL	<b>5707506</b>	<b>5706740</b>	N/A	N/A	
0.500	0.500	RD	Thomson	2	1.500	1.320	N/A	RH	2	0.490	SS	<b>5707644</b>	<b>5706846</b>	N/A	N/A	
0.750	0.200	RD	Thomson	4	1.800	1.297	N/A	RH	1	0.734	STEEL	<b>7826768</b>	<b>7826770</b>	N/A	<b>INTEGRAL</b>	
1.500	1.875	SQ	Thomson	4	5.000	2.290	2 1/4-20	RH	1	1.480	STEEL	<b>7833714</b>	<b>7820599</b>	N/A	N/A	77

Note: Manganese Phosphate coating provided as standard finish on Thomson ball screws not featured in catalog pages.

Note: These ball nuts available for high quantity purchase only (100 piece minimum order required).

**NOTES:**



**Precision Plus Ball Screws — Inch Series**

**High accuracy and stiffness with zero backlash, for stringent applications where ball screw performance is critical.**

Thomson Precision Plus Ball Screw Assemblies provide the positioning accuracy and repeatability required for the most stringent positioning applications. Thomson assemblies are designed and manufactured to provide 8 times the lead accuracy of conventional ball screws ( $\pm .0005$  in/ft), and provide consistent, zero-backlash, preload for high repeatability. All ball nuts feature an integral flange for optimal precision and mounting ease, and specially designed seals/wipers that provide superior lubricant retention while keeping out harmful contaminants. Precision Plus Assemblies are ideal for machine tools, robots, semi-conductor/electronic assembly systems, and many more applications where high-level ball screw performance is required.

Need a quote or have a question about an application?  
Contact us in North America at:

Phone: 540-633-3549

Fax: 540-639-4162

Email: [thomson@thomsonlinear.com](mailto:thomson@thomsonlinear.com)

## Precision Plus Ball Screws — Inch Series

Lead Accuracy:  $\pm .0005$  in/ft



### Preloaded, Round Ball Nut with Integral Flange and Wiper

- Precision machined for highly accurate and smooth running performance
- Long-lasting preload for minimal backlash and consistent stiffness
- Standard sizes stocked for quick delivery. Additional sizes are available as custom product.

Nominal Diameter (size)	Lead	Ball Screw and Nut Assembly P/N <sup>(1)(2)(3)</sup>	Ball Nut Details		Performance Data			Screw Specifications			
			Direction	No. of Return Tubes	Dynamic Load Capacity (C <sub>am</sub> )	Static Load Capacity (C <sub>0</sub> )	Max. Axial Backlash	Major Diameter (max.)	Minor Diameter	Standard Length	Screw Weight
(in.)	(in.)				(lbf)	(lbf)	(in.)	(in.)	(in.)	(in.)	(lb/ft)
0.631	0.200	<b>7820396</b>	Right Hand	2	440	2,110	0.00	0.611	0.496	42	0.90
0.750	0.200	<b>5700974</b>	Right Hand	2	1,473	9,916	0.00	0.750	0.599	42	1.45
0.875	0.200	<b>7820397</b>	Right Hand	2	1,375	10,780	0.00	0.875	0.740	60	1.78
1.000	0.200	<b>5700975</b>	Right Hand	2	1,565	13,073	0.00	1.000	0.865	72	2.20
1.000	0.250	<b>7820477</b>	Right Hand	2	2,285	15,815	0.00	1.000	0.833	72	2.20
1.150	0.200	<b>5700976</b>	Right Hand	2	1,680	14,886	0.00	1.130	1.015	72	3.18
1.250	0.200	<b>5700977</b>	Right Hand	2	1,800	16,625	0.00	1.250	1.115	72	3.75
1.250	0.200	<b>7820830</b>	Left Hand	2	1,800	16,625	0.00	1.235	1.115	72	3.75
1.250	0.500	<b>7820399</b>	Right Hand	2	1,765	11,080	0.00	1.250	1.050	96	3.77
1.500	0.200	<b>7820375</b>	Right Hand	4	4,745	45,073	0.00	1.500	1.349	120	5.18
1.500	0.250	<b>7820965</b>	Right Hand	4	4,250	27,250	0.00	1.500	1.333	120	5.18
1.500	0.500	<b>7820401</b>	Right Hand	2	5,075	35,770	0.00	1.500	1.236	120	4.79
1.750	0.200	<b>5700979</b>	Right Hand	4	4,464	47,446	0.00	1.750	1.615	96	7.56
2.000	0.200	<b>7820402</b>	Right Hand	6	6,181	65,903	0.00	2.000	1.849	120	9.81
2.250	0.500	<b>7820484</b>	Right Hand	2	20,160	108,325	0.00	2.250	1.858	120	10.87
2.500	0.250	<b>7820483</b>	Right Hand	6	8,945	93,165	0.00	2.500	2.333	120	15.46

(1) All Precision Plus product is sold in matched sets as ball screw and nut assemblies.

(2) Dimensional information on bearing supports and standard end machining is available on page 148.

(3) Information on required lubrication is on page 225.

**Precision Plus Ball Screws — Inch Series**

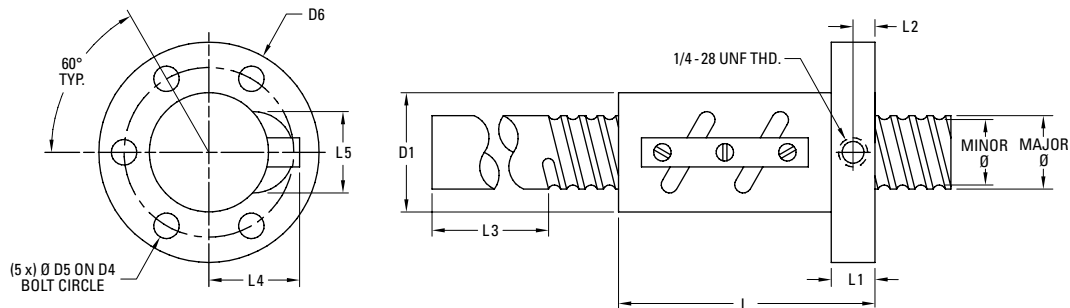

Ball Screws - Inch Series

Nominal Diameter (size)	Lead	Nut Specifications											
		D1	D4	D5	D6	L	L1	L2	L3	L4 (max.)	L5 (max.)	Nut Weight	Ball Diameter
(in.)	(in.)	(in.)	(in.)	(in.)	(in.)	(in.)	(in.)	(in.)	(in.)	(in.)	(in.)	(lb)	(in.)
0.631	0.200	1.130	1.562	0.281	2.000	2.200	0.375	0.200	2.750	0.849	0.710	0.66	0.125
0.750	0.200	1.370	1.875	0.281	2.320	3.000	0.500	0.312	2.750	0.996	0.855	1.26	0.141
0.875	0.200	1.250	1.750	0.281	2.250	3.000	0.500	0.312	2.750	0.891	1.024	0.92	0.125
1.000	0.200	1.620	2.250	0.281	2.750	3.000	0.500	0.312	3.750	1.042	1.134	1.63	0.125
1.000	0.250	1.685	2.250	0.344	2.875	3.370	0.500	0.312	3.750	1.100	1.203	1.98	0.156
1.150	0.200	1.685	2.280	0.344	2.875	3.000	0.500	0.312	3.750	1.067	1.287	1.61	0.125
1.250	0.200	1.645	2.312	0.344	2.770	3.000	0.500	0.312	3.750	1.109	1.248	1.31	0.125
1.250	0.200	1.650	2.312	0.344	2.770	3.000	0.500	0.312	3.750	1.109	1.248	1.31	0.125
1.250	0.500	1.990	3.124	0.406	3.865	3.580	0.625	0.410	3.750	1.356	1.531	3.43	0.188
1.500	0.200	2.020	2.750	0.344	3.500	5.000	0.625	0.375	3.750	1.273	1.758	3.17	0.141
1.500	0.250	2.020	2.750	0.344	3.500	5.000	0.625	0.375	3.750	1.290	1.520	3.17	0.156
1.500	0.500	2.250	3.125	0.406	3.875	4.625	0.625	0.410	3.750	1.575	1.900	4.27	0.250
1.750	0.200	2.265	3.250	0.406	4.000	5.000	0.625	0.375	4.750	1.352	1.878	3.81	0.125
2.000	0.200	2.500	3.250	0.406	4.000	5.750	0.700	0.438	4.750	1.550	1.900	4.39	0.141
2.250	0.500	3.375	4.375	0.656	5.375	8.125	1.250	0.812	4.750	2.259	2.535	16.29	0.375
2.500	0.250	3.375	4.000	0.344	4.625	6.250	0.750	0.500	4.750	2.010	2.609	8.81	0.156

**NOTES:**



# Metric Ball Screws



## Table of Contents

<b>Description</b>	<b>Page</b>
Product Overview .....	104
Miniature Rolled Ball Screws — Metric Series .....	111
Thomson NEFF Rolled Ball Screws — Metric Series .....	115
Precision Plus Ball Screws — Metric Series .....	129

Need a quote or have a question about an application?  
Contact us in North America at:

Phone: 540-633-3549

Fax: 540-639-4162

Email: [thomson@thomsonlinear.com](mailto:thomson@thomsonlinear.com)

## Metric Ball Screws Product Overview

### Superior performance for today's most stringent positioning requirements.

Thomson has a wide range of internal return metric ball screw products, featuring four distinct product families — Miniature, Thomson NEFF and Precision Plus. Each family is designed to meet unique application requirements.

#### Miniature Rolled Ball Screws (page 111)

Miniature Rolled Ball Screw Assemblies are an efficient, cost-effective solution in a small envelope. Ball screw assemblies range from 4mm to 14mm in diameter, with standard lead accuracies of 52 microns/300mm.

Compact ball nuts are available with body diameters as small as 11mm and overall lengths as short as 17mm. Miniature Rolled Ball Screws are ideal for laboratory, semiconductor, and medical applications.

Miniature ball screws are available in two nut styles.



#### Precision Plus Ball Screws (page 129)

Precision Plus Ball Screw Assemblies are our highest precision product, with standard lead accuracies of 12 microns/300mm. These ball screw assemblies feature our FL-style ball nut, precisely preloaded to customer specifications. This unique nut design provides high repeatability and high stiffness for the most demanding ball screw applications. Each nut comes standard with an integral plastic wiper to protect against chips and other debris. Precision Plus Ball Screws are ideal for applications requiring high repeatability and high stiffness (e.g., high precision machine tool).

Precision Plus screws are available with our FL style nut.



#### Thomson NEFF Rolled Ball Screws (page 115)

Thomson NEFF Rolled Ball Screw Assemblies are designed and manufactured to provide high level performance at an affordable price. Ball screws are manufactured using Thomson's patented, German-engineered Precision Screw Forming (PST) Technology, which provides high accuracy (23 microns/300mm standard) with the manufacturing efficiency of rolled processes. Ball Screw Assemblies are available in a wide range of diameters, leads, and nut styles - all designed to provide quiet, smooth running, and efficient performance. Ball nuts include one of three unique ball return systems (depending on the diameter and lead of the screw used) providing perfect guidance, low wear, and smooth running performance. Thomson NEFF Rolled Ball Screw Assemblies are ideal for machining centers, factory automation, packaging, injection molding, wood working, water jet cutting, electronic assembly, and medical applications.

Thomson NEFF ball screws are available in seven nut styles.





## Metric Ball Screws Product Overview

An overview of ball screw sizes available within each product family is shown below. Refer to individual product family sections for additional details.

### Miniature Rolled Ball Screws — Product Availability (page 111)

	1mm	2mm	4mm	5mm	6mm	8mm	10mm	12mm	15mm	20mm	25mm	32mm	40mm	50mm
4mm	●													
5mm			●											
6mm	●				●									
8mm	●	●		●		●		●						
10mm		●					●		●	●				
12mm		●												
13mm								●		●				
14mm		●	●											

### Thomson NEFF Rolled Ball Screws — Product Availability (page 115)

	1mm	2mm	4mm	5mm	6mm	8mm	10mm	12mm	15mm	20mm	25mm	32mm	40mm	50mm
12mm			●	●			●							
16mm				●			●							
20mm				●						●				●
25mm				●			●			●	●			●
32mm				●			●			●		●	●	
40mm				●			●			●			●	
50mm							●			●				
63mm							●			●				
80mm							●							

### Precision Plus Ball Screws — Product Availability\* (page 129)

	1mm	2mm	4mm	5mm	6mm	8mm	10mm	12mm	15mm	20mm	25mm	32mm	40mm	50mm
16mm				●										
20mm				●										
25mm				●										
32mm				●			●							
40mm				●										
50mm							●							
63mm							●							

\* Additional ground ball screw sizes are available in diameters up to 200mm. Contact us for more details.

## Metric Ball Screws Product Overview

The Thomson series of metric ball screws includes two families of rolled ball screws (Miniature, Thomson NEFF) with four nut styles — Miniature, Cylindrical, Threaded and Flanged. An overview of our rolled product offering is organized by nut style, below. Refer to individual product family sections for additional details.

### Miniature Ball Nuts

#### Miniature: Type A, Type B

**Return:** Internal

**Style:** Miniature

**Mounting:** Flanged

**Backlash:** Non-preloaded

**Thread Direction:** Right Hand

#### Type A

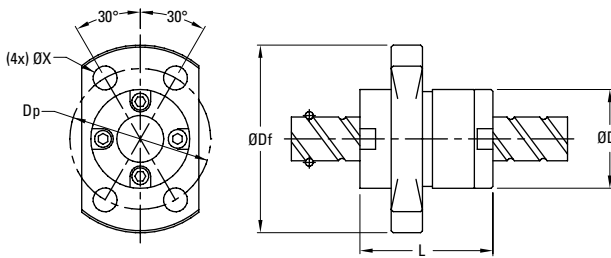

#### Type B

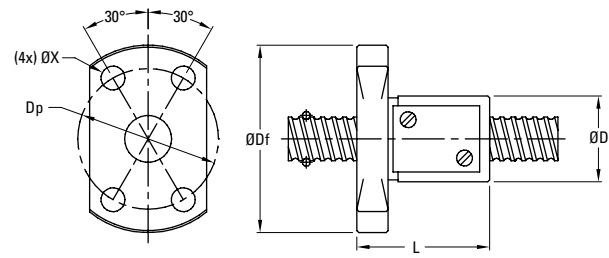

Nominal Diameter	Lead	Dynamic Load Capacity (C <sub>am</sub> )	Length L	Width/Diameter D	Ball Nut Form	Flange Diameter D <sub>f</sub>	Bolt Hole Circle D <sub>p</sub>	Hole Diameter X	Ball Nut	Screw and Nut Assembly P/N	Catalog Page
(mm)	(mm)	(kN)	(mm)	(mm)		(mm)	(mm)	(mm)			
4	1	0.6	17.0	11.0	Type B	24.0	18.0	3.4	Type B	<b>PRM0401</b>	112
5	4	0.5	22.0	12.0	Type B	24.0	18.0	3.4	Type B	<b>PRM0504</b>	112
6	1	0.7	17.0	13.0	Type B	26.0	20.0	3.4	Type B	<b>PRM0601</b>	112
6	6	0.9	17.0	14.0	Type A	27.0	21.0	3.4	Type A	<b>PRM0606</b>	112
8	1	0.8	17.0	16.0	Type B	29.0	23.0	3.4	Type B	<b>PRM0801</b>	112
8	2	2.4	24.0	20.0	Type B	37.0	29.0	4.5	Type B	<b>PRM0802</b>	112
8	5	1.9	28.0	18.0	Type B	31.0	25.0	3.4	Type B	<b>PRM0805</b>	112
8	8	2.2	20.0	18.0	Type A	31.0	25.0	3.4	Type A	<b>PRM0808</b>	112
8	12	2.2	27.0	18.0	Type A	31.0	25.0	3.4	Type A	<b>PRM0812</b>	112
10	2	2.7	24.0	23.0	Type B	40.0	32.0	4.5	Type B	<b>PRM1002</b>	112
10	10	3.3	24.0	23.0	Type A	40.0	32.0	4.5	Type A	<b>PRM1010</b>	112
10	15	3.3	33.0	23.0	Type A	40.0	32.0	4.5	Type A	<b>PRM1015</b>	112
10	20	2.1	23.0	20.0	Type A	37.0	29.0	4.5	Type A	<b>PRM1020</b>	112
12	2	3.0	24.0	25.0	Type B	42.0	34.0	4.5	Type B	<b>PRM1202</b>	112
13	12	5.0	30.0	28.0	Type A	45.0	37.0	4.5	Type A	<b>PRM1312</b>	112
13	20	5.0	43.0	28.0	Type A	45.0	37.0	4.5	Type A	<b>PRM1320</b>	112
14	2	3.2	25.0	26.0	Type B	45.0	36.0	5.5	Type B	<b>PRM1402</b>	112
14	4	5.7	33.0	30.0	Type B	49.0	40.0	5.5	Type B	<b>PRM1404</b>	112

## Metric Ball Screws Product Overview

### Cylindrical Ball Nuts

**Model:** ZG, KGM-D, KGM-N

**Return:** Internal

**Style:** Cylindrical

**Mounting:** Threaded

**Backlash:** Z1, Z2 and Z3

**Thread Direction:** Right Hand

ZG

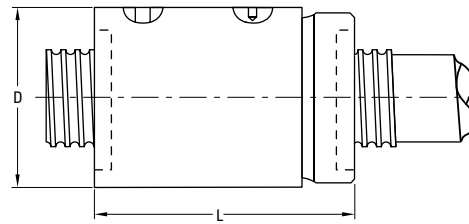

KGM-N, KGM-D

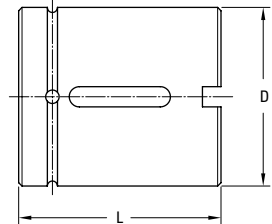

Nominal Diameter	Lead	Dynamic Load Capacity (C <sub>am</sub> )	Length L	Width/Diameter D	Ball Nut Form	Flange Diameter D <sub>f</sub>	Bolt Hole Circle D <sub>p</sub>	Hole Diameter X	Ball Nut	Nut P/N	Screw P/N	Catalog Page
(mm)	(mm)	(kN)	(mm)	(mm)		(mm)	(mm)	(mm)				
12	4	3.5	34.0	25.0	Threaded	n/a	n/a	n/a	ZG	7832771	7832770-P5	116
12	5	4.4	24.0	20.0	Keyway	n/a	n/a	n/a	KGM-N	KGM-N-1205-RH-00	KGS-1205-023-RH	126
12	10	4.9	27.5	24.0	Keyway	n/a	n/a	n/a	KGM-D	KGM-D-1210-RH-EE	KGS-1210-023-RH	124
16	5	9.3	34.0	28.0	Keyway	n/a	n/a	n/a	KGM-D	KGM-D-1605-RH-EE	KGS-1605-023-RH	124
16	5	12.1	57.5	32.0	Threaded	n/a	n/a	n/a	ZG	7832778	7832776-P5	116
16	10	15.4	50.0	28.0	Keyway	n/a	n/a	n/a	KGM-D	KGM-D-1610-RH-EE	KGS-1610-023-RH	124
20	5	10.5	34.0	36.0	Keyway	n/a	n/a	n/a	KGM-D	KGM-D-2005-RH-EE	KGS-2005-023-RH	124
20	5	10.5	34.0	32.0	Keyway	n/a	n/a	n/a	KGM-N	KGM-N-2005-RH-EE	KGS-2005-023-RH	126
20	5	14.8	57.5	38.0	Threaded	n/a	n/a	n/a	ZG	7832781	7832779-P5	116
20	20	11.6	30.0	35.0	Keyway	n/a	n/a	n/a	KGM-N	KGM-N-2020-RH-EE	KGS-2020-023-RH	126
20	50	13.0	56.0	35.0	Keyway	n/a	n/a	n/a	KGM-N	KGM-N-2050-RH-EE	KGS-2050-023-RH	126
25	5	12.3	34.0	40.0	Keyway	n/a	n/a	n/a	KGM-D	KGM-D-2505-RH-EE	KGS-2505-023-RH	124
25	5	12.3	34.0	38.0	Keyway	n/a	n/a	n/a	KGM-N	KGM-N-2505-RH-EE	KGS-2505-023-RH	126
25	5	20.4	63.5	42.0	Threaded	n/a	n/a	n/a	ZG	7832788	7832786-P5	116
25	10	13.2	45.0	40.0	Keyway	n/a	n/a	n/a	KGM-D	KGM-D-2510-RH-EE	KGS-2510-023-RH	124
25	10	19.9	61.0	42.0	Threaded	n/a	n/a	n/a	ZG	7832792	7832790-P5	116
25	20	13.0	35.0	40.0	Keyway	n/a	n/a	n/a	KGM-D	KGM-D-2520-RH-EE	KGS-2520-023-RH	124
25	25	16.7	35.0	40.0	Keyway	n/a	n/a	n/a	KGM-D	KGM-D-2525-RH-EE	KGS-2525-023-RH	124
25	50	15.4	58.0	40.0	Keyway	n/a	n/a	n/a	KGM-D	KGM-D-2550-RH-EE	KGS-2550-023-RH	124
32	5	21.5	45.0	50.0	Keyway	n/a	n/a	n/a	KGM-D	KGM-D-3205-RH-EE	KGS-3205-023-RH	124
32	5	21.5	45.0	45.0	Keyway	n/a	n/a	n/a	KGM-N	KGM-N-3205-RH-EE	KGS-3205-023-RH	126
32	5	23.3	65.5	52.0	Threaded	n/a	n/a	n/a	ZG	7832797	7832795-P5	116
32	10	33.4	60.0	53.0	Keyway	n/a	n/a	n/a	KGM-N	KGM-N-3210-RH-EE	KGS-3210-023-RH	126
32	10	33.8	85.0	52.0	Threaded	n/a	n/a	n/a	ZG	7832800	7832798-P5	116
32	20	29.7	70.0	53.0	Keyway	n/a	n/a	n/a	KGM-N	KGM-N-3220-RH-EE	KGS-3220-023-RH	126
32	40	14.9	45.0	53.0	Keyway	n/a	n/a	n/a	KGM-N	KGM-N-3240-RH-EE	KGS-3240-023-RH	126
40	5	23.8	45.0	63.0	Keyway	n/a	n/a	n/a	KGM-D	KGM-D-4005-RH-EE	KGS-4005-023-RH	124
40	5	23.8	45.0	53.0	Keyway	n/a	n/a	n/a	KGM-N	KGM-N-4005-RH-EE	KGS-4005-023-RH	126
40	5	26.3	67.5	58.0	Threaded	n/a	n/a	n/a	ZG	7832806	7832804-P5	116
40	10	38.0	60.0	63.0	Keyway	n/a	n/a	n/a	KGM-D	KGM-D-4010-RH-EE	KGS-4010-023-RH	124
40	10	78.6	105.5	65.0	Threaded	n/a	n/a	n/a	ZG	7832810	7832808-P5	116
40	20	33.3	70.0	63.0	Keyway	n/a	n/a	n/a	KGM-D	KGM-D-4020-RH-EE	KGS-4020-023-RH	128
40	20	34.2	83.0	65.0	Threaded	n/a	n/a	n/a	ZG	7833723	7832811-P5	116
40	40	35.0	85.0	63.0	Keyway	n/a	n/a	n/a	KGM-D	KGM-D-4040-RH-EE	KGS-4040-023-RH	124
50	10	68.7	82.0	72.0	Keyway	n/a	n/a	n/a	KGM-N	KGM-N-5010-RH-EE	KGS-5010-023-RH	126
50	10	82.0	82.0	75.0	Keyway	n/a	n/a	n/a	KGM-D	KGM-D-5010-RH-EE	KGS-5010-023-RH	124
50	10	97.8	118.0	78.0	Threaded	n/a	n/a	n/a	ZG	7832819	7832817-P5	116
50	20	60.0	82.0	85.0	Keyway	n/a	n/a	n/a	KGM-N	KGM-N-5020-RH-EE	KGS-5020-023-RH	126
63	10	76.0	82.0	85.0	Keyway	n/a	n/a	n/a	KGM-N	KGM-N-6310-RH-EE	KGS-6310-023-RH	126
63	10	90.0	82.0	90.0	Keyway	n/a	n/a	n/a	KGM-D	KGM-D-6310-RH-EE	KGS-6310-023-RH	124
63	10	109.7	118.0	92.0	Threaded	n/a	n/a	n/a	ZG	7832824	7832822-P5	116
80	10	86.3	82.0	105.0	Keyway	n/a	n/a	n/a	KGM-N	KGM-N-8010-RH-EE	KGS-8010-023-RH	126
80	10	121.9	126.0	120.0	Threaded	n/a	n/a	n/a	ZG	7832829	7832827-T7	116

# Metric Ball Screws Product Overview

## Flanged Ball Nuts

- Model:** FK, FH, KGF-D
- Return:** Internal
- Style:** Flanged
- Mounting:** Flanged
- Backlash:** Z1, Z2 and Z3
- Thread Direction:** Right Hand

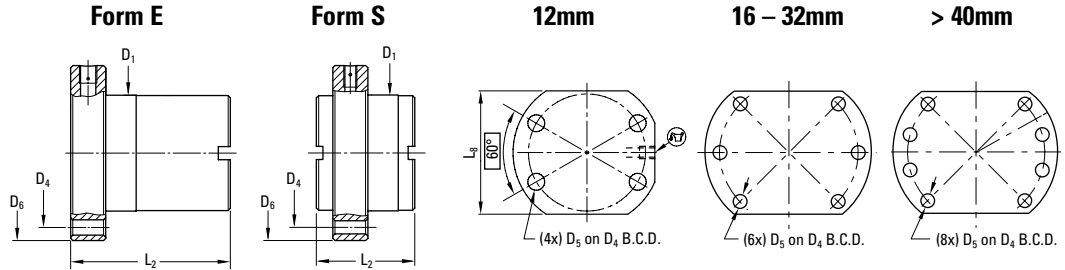

Note: KGF-D 2525 and 4040 models have round flanges.

Nominal Diameter (mm)	Lead (mm)	Dynamic Load Capacity (C <sub>am</sub> ) (kN)	Length L <sub>2</sub> (mm)	Width/ Diameter D <sub>1</sub> (mm)	Ball Nut Form	Flange Diameter D <sub>6</sub>	Bolt Hole Circle D <sub>4</sub>	Hole Diameter D <sub>5</sub>	Ball Nut	Nut P/N	Screw P/N	Catalog Page
						(mm)	(mm)	(mm)				
12	10	4.9	27.5	24.0	Form S	40.0	32.0	4.5	KGF-D	KGF-D-1210-RH-EE	KGS-1210-023-RH	120
16	5	9.5	48.5	28.0	Form S	48.0	38.0	5.5	FK	7832777	7832776-P5	118
16	5	9.3	42.0	28.0	Form E	48.0	38.0	5.5	KGF-D	KGF-D-1605-RH-EE	KGS-1605-023-RH	120
16	10	15.4	55.0	28.0	Form E	48.0	38.0	5.5	KGF-D	KGF-D-1610-RH-EE	KGS-1610-023-RH	120
20	5	11.5	48.5	36.0	Form S	58.0	47.0	6.6	FK	7832780	7832779-P5	118
20	5	10.5	42.0	36.0	Form E	58.0	47.0	6.6	KGF-D	KGF-D-2005-RH-EE	KGS-2005-023-RH	120
20	20	10.8	36.0	36.0	Form S	58.0	47.0	6.6	FH	7832784	7832783-P5	118
25	5	13.1	49.0	40.0	Form S	62.0	51.0	6.6	FK	7832787	7832786-P5	118
25	5	12.3	42.0	40.0	Form E	62.0	51.0	6.6	KGF-D	KGF-D-2505-RH-EE	KGS-2505-023-RH	120
25	10	22.9	51.0	40.0	Form S	62.0	51.0	6.6	FH	7832791	7832790-P5	118
25	10	13.2	55.0	40.0	Form E	62.0	51.0	6.6	KGF-D	KGF-D-2510-RH-EE	KGS-2510-023-RH	120
25	20	13.0	35.0	40.0	Form S	62.0	51.0	6.6	KGF-D	KGF-D-2520-RH-EE	KGS-2520-023-RH	120
25	25	13.1	39.0	40.0	Form S	62.0	51.0	6.6	FH	7832794	7832793-P5	118
25	25	16.7	35.0	40.0	Form S	62.0	51.0	6.6	KGF-D	KGF-D-2525-RH-EE	KGS-2525-023-RH	120
25	50	15.4	58.0	40.0	Form S	62.0	51.0	6.6	KGF-D	KGF-D-2550-RH-EE	KGS-2550-023-RH	120
32	5	19.3	57.0	50.0	Form S	80.0	65.0	9.0	FK	7832796	7832795-P5	118
32	5	21.5	55.0	50.0	Form E	80.0	65.0	9.0	KGF-D	KGF-D-3205-RH-EE	KGS-3205-023-RH	120
32	10	26.4	73.0	50.0	Form S	80.0	65.0	9.0	FK	7832799	7832798-P5	118
32	10	33.4	69.0	53.0	Form E	80.0	65.0	9.0	KGF-D	KGF-D-3210-RH-EE	KGS-3210-023-RH	120
32	20	47.2	83.0	56.0	Form S	86.0	71.0	9.0	FH	7832803	7832802-P5	118
32	20	29.7	80.0	53.0	Form E	80.0	65.0	9.0	KGF-D	KGF-D-3220-RH-EE	KGS-3220-023-RH	120
32	32	19.7	42.0	56.0	Form S	86.0	71.0	9.0	FH	7833300	7833301-P5	118
32	32	18.0	42.0	50.0	Form S	80.0	65.0	9.0	KGF-D	KGF-D-3232-RH-EE	KGS-3232-023-RH	120
40	5	26.3	66.0	63.0	Form S	93.0	78.0	9.0	FK	7832805	7832804-P5	118
40	5	23.8	57.0	63.0	Form E	93.0	78.0	9.0	KGF-D	KGF-D-4005-RH-EE	KGS-4005-023-RH	120
40	10	64.9	88.5	63.0	Form S	93.0	78.0	9.0	FK	7832809	7832808-P5	118
40	10	38.0	71.0	63.0	Form E	93.0	78.0	9.0	KGF-D	KGF-D-4010-RH-EE	KGS-4010-023-RH	120
40	20	52.2	83.0	63.0	Form S	93.0	78.0	9.0	FH	7832812	7832811-P5	118
40	20	33.3	80.0	63.0	Form E	93.0	78.0	9.0	KGF-D	KGF-D-4020-RH-EE	KGS-4020-023-RH	120
40	40	59.7	104.0	70.0	Form S	100.0	85.0	9.0	FH	7832815	7832814-P5	118
40	40	35.0	85.0	63.0	Form S	93.0	78.0	9.0	KGF-D	KGF-D-4040-RH-EE	KGS-4040-023-RH	120
50	10	66.4	92.0	75.0	Form S	110.0	93.0	11.0	FK	7832818	7832817-P5	118
50	10	68.7	95.0	75.0	Form E	110.0	93.0	11.0	KGF-D	KGF-D-5010-RH-EE	KGS-5010-023-RH	120
50	20	78.8	85.0	75.0	Form S	110.0	93.0	11.0	FH	7832821	7832820-P5	118
50	20	60.0	95.0	85.0	Form E	125.0	103.0	11.0	KGF-D	KGF-D-5020-RH-EE	KGS-5020-023-RH	120
63	10	76.0	97.0	90.0	Form E	125.0	108.0	11.0	KGF-D	KGF-D-6310-RH-EE	KGS-6310-023-RH	120
63	10	93.8	103.5	90.0	Form S	125.0	108.0	11.0	FK	7832823	7832822-P5	118
63	20	103.1	86.0	95.0	Form S	135.0	115.0	13.5	FK	7832826	7832825-P5	118
80	10	121.9	121.0	105.0	Form S	145.0	125.0	13.5	FK	7832828	7832827-T7	118

## Metric Ball Screws Product Overview

### Flanged Ball Nuts

**Model:** KGF-N

**Return:** Internal

**Style:** Flanged

**Mounting:** Flanged

**Backlash:** Z1, Z2 and Z3

**Thread Direction:** Right Hand

**Form E**

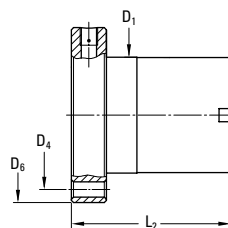

**Form S**

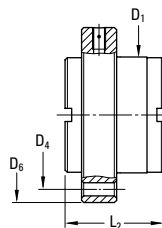

**KGF-N**

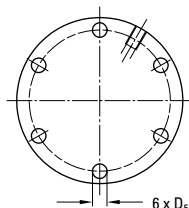

Nominal Diameter	Lead	Dynamic Load Capacity ( $C_{am}$ )	Length $L_2$	Width/Diameter $D_1$	Ball Nut Form	Flange Diameter $D_6$	Bolt Hole Circle $D_4$	Hole Diameter $D_5$	Ball Nut	Nut P/N	Screw P/N	Catalog Page
						(mm)	(mm)	(mm)				
16	5	9.3	44.0	28.0	Form E	48.0	38.0	5.5	KGF-N	<b>KGF-N-1605-RH-EE</b>	<b>KGS-1605-050-RH</b>	122
20	5	10.5	44.0	32.0	Form E	55.0	45.0	7.0	KGF-N	<b>KGF-N-2005-RH-EE</b>	<b>KGS-2005-050-RH</b>	122
20	20	11.6	30.0	35.0	Form S	62.0	50.0	7.0	KGF-N	<b>KGF-N-2020-RH-EE</b>	<b>KGS-2020-050-RH</b>	122
20	50	13.0	56.0	35.0	Form S	62.0	50.0	7.0	KGF-N	<b>KGF-N-2050-RH-EE</b>	<b>KGS-2050-050-RH</b>	122
25	5	12.3	46.0	38.0	Form E	62.0	50.0	7.0	KGF-N	<b>KGF-N-2505-RH-EE</b>	<b>KGS-2505-050-RH</b>	122
32	5	21.5	59.0	45.0	Form E	70.0	58.0	7.0	KGF-N	<b>KGF-N-3205-RH-EE</b>	<b>KGS-3205-050-RH</b>	122
32	10	33.4	73.0	53.0	Form E	80.0	68.0	7.0	KGF-N	<b>KGF-N-3210-RH-EE</b>	<b>KGS-3210-050-RH</b>	122
32	40	14.9	45.0	53.0	Form S	80.0	68.0	7.0	KGF-N	<b>KGF-N-3240-RH-EE</b>	<b>KGS-3240-050-RH</b>	122
40	5	23.8	59.0	53.0	Form E	80.0	68.0	7.0	KGF-N	<b>KGF-N-4005-RH-EE</b>	<b>KGS-4005-050-RH</b>	122
40	10	38.0	73.0	63.0	Form E	95.0	78.0	9.0	KGF-N	<b>KGF-N-4010-RH-EE</b>	<b>KGS-4010-050-RH</b>	122
50	10	68.7	97.0	72.0	Form E	110.0	90.0	11.0	KGF-N	<b>KGF-N-5010-RH-EE</b>	<b>KGS-5010-050-RH</b>	122
63	10	76.0	99.0	85.0	Form E	125.0	105.0	11.0	KGF-N	<b>KGF-N-6310-RH-EE</b>	<b>KGS-6310-050-RH</b>	122
80	10	86.3	101.0	105.0	Form E	145.0	125.0	14.0	KGF-N	<b>KGF-N-8010-RH-EE</b>	<b>KGS-8010-023-RH</b>	122

**NOTES:**



## Miniature Rolled Ball Screws — Metric Series



**Miniature Rolled Ball Screw Assemblies** are an efficient, cost-effective solution in a small envelope. Ball screw assemblies range from 4mm to 14mm in diameter, with standard lead accuracies of 52 microns/300mm. Compact ball nuts are available with body diameters as small as 11mm and overall lengths as short as 17mm. Miniature Rolled Ball Screws are ideal for laboratory, semiconductor, and medical applications.

Need a quote or have a question about an application?  
Contact us in North America at:

Phone: 540-633-3549

Fax: 540-639-4162

Email: [thomson@thomsonlinear.com](mailto:thomson@thomsonlinear.com)

## Miniature Rolled Ball Screws — Metric Series

4mm to 14mm Diameter, Lead Accuracy:  $\pm 52\mu\text{m}/300\text{mm}$



Type A



Type B

### Non-Preloaded, Rolled Ball Screw Assemblies

- Cost-effective solution in a small envelope, ideal for use in small spaces
- Clearance held to max .02mm
- Two nut styles (Type A & B) provide optimum performance in low and high lead assemblies

Nominal Diameter (size)	Lead	Nut Type	Ball Screw and Nut Assembly P/N <sup>(1)</sup>	Suggested Bearing Size	Performance Data						
					Dynamic Load Capacity		Static Load Capacity		Max. Axial Backlash	Minor Diameter	Max. Length
(mm)	(mm)			(mm)	(kN)	(lbf)	(kN)	(lbf)	(mm)	(mm)	(mm)
4	1	B	PRM0401	N/A	0.6	126	0.8	178	0.02	3.3	100
5	4	B	PRM0504	N/A	0.5	106	0.7	162	0.02	4.3	220
6	1	B	PRM0601	4	0.7	153	1.2	270	0.02	5.3	265
6	6	A	PRM0606	4	0.9	196	1.5	326	0.02	5.2	265
8	1	B	PRM0801	6	0.8	175	1.7	371	0.02	7.3	360
8	2	B	PRM0802	6	2.4	540	4.1	922	0.02	6.6	360
8	5	B	PRM0805	6	1.9	416	3.0	674	0.02	6.6	360
8	8	A	PRM0808	6	2.2	495	3.8	854	0.02	6.7	360
8	12	A	PRM0812	6	2.2	495	4.0	899	0.02	6.7	360
10	2	B	PRM1002	6	2.7	607	5.3	1,191	0.02	8.6	355
10	10	A	PRM1010	6	3.3	742	5.9	1,326	0.02	8.4	405
10	15	A	PRM1015	6	3.3	742	6.4	1,439	0.02	8.4	405
10	20	A	PRM1020	6	2.1	472	4.0	899	0.02	8.7	405
12	2	B	PRM1202	8	3.0	674	6.4	1,439	0.02	10.6	395
13	12	A	PRM1312	8	5.0	1,124	9.9	2,226	0.02	11.0	700
13	20	A	PRM1320	8	5.0	1,124	10.7	2,405	0.02	11.0	700
14	2	B	PRM1402	8	3.2	719	7.5	1,686	0.02	12.6	445
14	4	B	PRM1404	8	5.7	1,281	11.6	2,608	0.02	11.8	445

(1) All Miniature Rolled product is sold in matched sets as ball screw and nut assemblies. Please contact factory for sizes not listed.



## Miniature Rolled Ball Screws — Metric Series

### Type A — End Cap Design

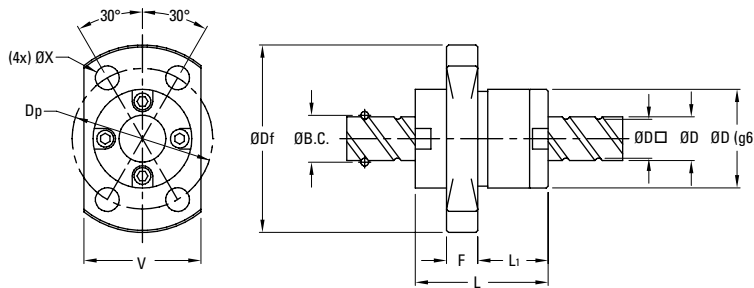

### Type B — Return Plate Design

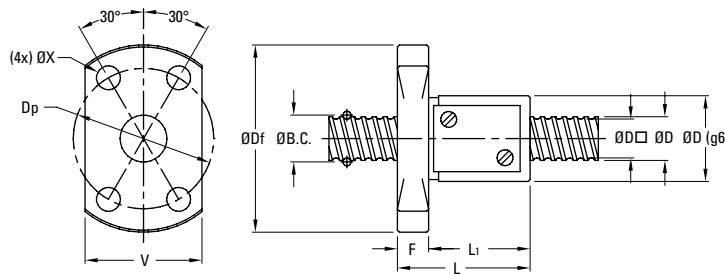

Nominal Diameter (size)	Lead	Nut Type	Nut Specifications								
			Outside Diameter D	Flange Outside Diameter Df	Overall Length L	Body Length L1	Flange Width F	Flange Flat Width V	Bolt Circle Diameter Dp	Mounting Hole Diameter X	Ball Diameter
			(mm)	(mm)	(mm)	(mm)	(mm)	(mm)	(mm)	(mm)	(mm)
4	1	B	11.0	24.0	17.0	13.0	4.0	15.0	18.0	3.4	0.80
5	4	B	12.0	24.0	22.0	18.0	4.0	16.0	18.0	3.4	0.80
6	1	B	13.0	26.0	17.0	13.0	4.0	16.0	20.0	3.4	0.80
6	6	A	14.0	27.0	17.0	8.0	4.0	16.0	21.0	3.4	1.00
8	1	B	16.0	29.0	17.0	13.0	4.0	18.0	23.0	3.4	0.80
8	2	B	20.0	37.0	24.0	19.0	5.0	22.0	29.0	4.5	1.59
8	5	B	18.0	31.0	28.0	24.0	4.0	20.0	25.0	3.4	1.59
8	8	A	18.0	31.0	20.0	10.0	4.0	20.0	25.0	3.4	1.59
8	12	A	18.0	31.0	27.0	17.0	4.0	20.0	25.0	3.4	1.59
10	2	B	23.0	40.0	24.0	19.0	5.0	25.0	32.0	4.5	1.59
10	10	A	23.0	40.0	24.0	13.0	5.0	25.0	32.0	4.5	2.00
10	15	A	23.0	40.0	33.0	22.0	5.0	25.0	32.0	4.5	2.00
10	20	A	20.0	37.0	23.0	13.0	5.0	22.0	29.0	4.5	1.59
12	2	B	25.0	42.0	24.0	19.0	5.0	27.0	34.0	4.5	1.59
13	12	A	28.0	45.0	30.0	17.0	5.0	30.0	37.0	4.5	2.38
13	20	A	28.0	45.0	43.0	29.0	5.0	30.0	37.0	4.5	2.38
14	2	B	26.0	45.0	25.0	19.0	6.0	28.0	36.0	5.5	1.59
14	4	B	30.0	49.0	33.0	27.0	6.0	32.0	40.0	5.5	2.38



## Thomson Neff Rolled Ball Screws — Metric Series



**Thomson NEFF Rolled Ball Screw Assemblies** are designed and manufactured to provide high level performance at an affordable price. Ball screws are manufactured using Thomson's patented, German-engineered Precision Screw Forming (PST) Technology, which provides high accuracy (23 microns/300mm standard) with the manufacturing efficiency of rolled processes. Ball Screw Assemblies are available in a wide range of diameters, leads, and nut styles - all designed to provide quiet, smooth running, and efficient performance. Ball nuts include one of three unique ball return systems (depending on the diameter and lead of the screw used) providing perfect guidance, low wear, and smooth running performance. Thomson NEFF Rolled Ball Screw Assemblies are ideal for machining centers, factory automation, packaging, injection molding, wood working, water jet cutting, electronic assembly, and medical applications.

Need a quote or have a question about an application?  
Contact us in North America at:

Phone: 540-633-3549

Fax: 540-639-4162

Email: [thomson@thomsonlinear.com](mailto:thomson@thomsonlinear.com)

## Thomson NEFF Rolled Ball Screws — ZG Style Ball Nuts

Standard Lead Accuracy:  $\pm 23\mu\text{m}/300\text{mm}$



**ZG Style Nut**



**Quick Install**  
Available for Select Nuts

### Internal Return Threaded Ball Nut and Screw

- Flexible solution for non-standard mounting
- Integral wiper<sup>(4)</sup> included as standard
- Available in three preload classes (Type Z1, Z2, Z3)
  - Z1 – light preload to 1-2%
  - Z2 – no preload, clearance held to max indicated in table
  - Z3 – no preload, clearance held to max .05mm

Nominal Diameter (size)	Lead	Ball Screw P/N <sup>(1)</sup> (2) (6)	Ball Nut P/N	Available Preload Types	Performance Data					Screw Specifications <sup>(5)</sup>			
					Dynamic Load Capacity ( $C_{am}$ )		Static Load Capacity ( $C_o$ )		Max. Axial Backlash	Major Diameter	Minor Diameter	Max. Length <sup>(5)</sup>	Screw Weight
					(kN)	(lbf)	(kN)	(lbf)					
12	4	<b>7832770-P5</b>	<b>7832771</b>	Z1, Z2, Z3	3.5	787	4.0	899	0.07	11.6	9.7	3000	0.7
16	5	<b>7832776-P5</b>	<b>7832778</b>	Z1, Z2, Z3	12.1	2,720	14.5	3,260	0.09	15.6	12.7	3000	1.2
20	5	<b>7832779-P5</b>	<b>7832781</b>	Z1, Z2, Z3	14.8	3,327	20.7	4,654	0.09	19.6	16.7	4000	2.0
25	5	<b>7832786-P5</b>	<b>7832788</b>	Z1, Z2, Z3	20.4	4,586	33.7	7,576	0.09	24.6	21.7	5000	3.3
25	10	<b>7832790-P5</b>	<b>7832792</b>	Z1, Z2, Z3	19.9	4,474	31.8	7,149	0.09	24.6	21.7	5000	3.3
32	5	<b>7832795-P5</b>	<b>7832797</b>	Z1, Z2, Z3	23.3	5,238	45.5	10,229	0.09	31.6	28.7	6000	5.6
32	10	<b>7832798-P5</b>	<b>7832800</b>	Z1, Z2, Z3	33.8	7,599	52.0	11,690	0.15	31.6	27.1	6000	5.3
40	5	<b>7832804-P5</b>	<b>7832806</b>	Z1, Z2, Z3	26.3	5,912	59.2	13,309	0.09	39.6	36.7	6000	9.0
40	10	<b>7832808-P5</b>	<b>7832810</b>	Z1, Z2, Z3	78.6	17,670	136.2	30,619	0.18	39.6	34.0	6000	8.3
40	20	<b>7832811-P5</b>	<b>7833723</b>	Z1, Z2, Z3	34.2	7,689	57.2	12,860	0.18	40.0	35.7	6000	8.9
50	10	<b>7832817-P5</b>	<b>7832819</b>	Z1, Z2, Z3	97.8	21,986	213.2	47,929	0.18	49.5	43.0	6000	13.5
63	10	<b>7832822-P5</b>	<b>7832824</b>	Z1, Z2, Z3	109.7	24,662	275.6	61,957	0.18	62.5	56.9	6000	22.0
80	10	<b>7832827-T7</b>	<b>7832829</b>	Z2	121.9	27,404	375.0	84,303	0.18	79.5	73.9	6000	36.4

(1) Thomson NEFF Ball Screws, Ball Nuts and End Blocks can be sold together as assemblies or separately as components (preloaded ball nuts sold only as an assembly).

(2) All ball screws and nuts are right-hand thread.

(3) Dimensional information on bearing supports and standard end machining is available on page 148.

(4) Wiper not included on 12 x 4 ball nut.

(5) Max. length includes 150mm on each end usable for end machining only. Max. travel length equals table value minus 300mm. Ends are hardened.

(6) -P5 Accuracy Class is  $\pm 23\mu\text{m}/300\text{mm}$ . -T7 Accuracy Class is  $\pm 52\mu\text{m}/300\text{mm}$

(7) -P3 Accuracy Class is  $\pm 12\mu\text{m}/300\text{mm}$ . and is available upon request for most sizes.

## Thomson NEFF Rolled Ball Screws — ZG Style Ball Nuts

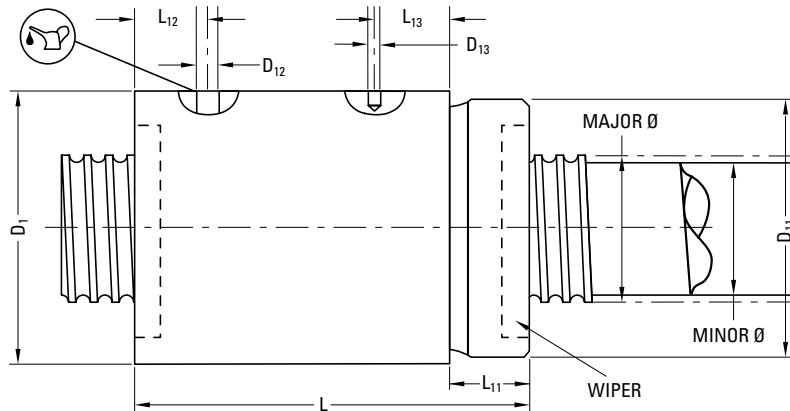

Nominal Diameter (size)	Lead	Nut Specifications (mm)									
		D <sub>1</sub>	D <sub>11</sub>	D <sub>12</sub>	D <sub>13</sub>	L	L <sub>11</sub>	L <sub>12</sub>	L <sub>13</sub>	Nut Weight	Ball Diameter
(mm)	(mm)	h12				-0.2				(kg)	(mm)
12	4	25.0	M 20 x 1.0	3.0	—	34.0	10.0	5.0	—	0.10	1.984
16	5	32.0	M 30 x 1.5	M 6 x 1	4	57.5	16.5	10.5	22.0	0.22	3.500
20	5	38.0	M 35 x 1.5	M 6 x 1	4	57.5	16.5	10.5	22.0	0.30	3.500
25	5	42.0	M 40 x 1.5	M 6 x 1	4	63.5	17.0	10.5	23.0	0.37	3.500
25	10	42.0	M 40 x 1.5	M 6 x 1	4	61.0	17.0	10.0	21.0	0.38	3.500
32	5	52.0	M 48 x 1.5	M 6 x 1	5	65.5	19.0	10.5	23.0	0.55	3.500
32	10	52.0	M 48 x 1.5	M 6 x 1	5	85.0	19.0	12.0	43.0	0.65	5.556
40	5	58.0	M 56 x 1.5	M 8 x 1	5	67.5	19.0	12.0	22.5	0.60	3.500
40	10	65.0	M 60 x 2.0	M 8 x 1	6	105.5	27.0	13.0	43.0	1.25	7.144
40	20	65.0	M 60 x 2.0	M 6 x 1	6	83.0	27.0	10.0	33.0	0.80	5.556
50	10	78.0	M 72 x 2.0	M 8 x 1	6	118.0	29.0	13.0	53.0	1.95	7.144
63	10	92.0	M 85 x 2.0	M 8 x 1	6	118.0	29.0	13.0	53.0	2.40	7.144
80	10	120.0	M 110 x 2.0	M 8 x 1	8	126.0	34.0	15.5	53.0	4.90	7.144

## Thomson NEFF Rolled Ball Screws — FK/FH Style Ball Nuts

Standard Lead Accuracy:  $\pm 23\mu\text{m}/300\text{mm}^{(1)}$



**FK Style Nut**



**FH Style Nut**

### Internal Return Flanged Ball Nut and Screw

- Two nut styles (FK & FH) provide optimal performance in low and high lead assemblies
- Integral wiper and flange included as standard
- Available in three preload classes (Type Z1, Z2, Z3)  
Z1 – light preload to 1-2%  
Z2 – no preload, clearance held to max indicated in table  
Z3 – no preload, clearance held to max .05mm

Nominal Diameter (size)	Lead	Nut Type	Ball Screw P/N <sup>(2) (3) (6)</sup>	Ball Nut P/N	Available Preload Types	Performance Data				Screw Specifications <sup>(4)</sup>				
						Dynamic Load Capacity ( $C_{am}$ )		Static Load Capacity ( $C_o$ )		Max. Axial Backlash	Major Diameter	Minor Diameter	Max. Length <sup>(5)</sup>	Screw Weight
						(kN)	(lbf)	(kN)	(lbf)					
16	5	FK	7832776-P5	7832777	Z1, Z2, Z3	9.5	2,136	10.9	2,450	0.09	15.6	12.7	3000	1.2
20	5	FK	7832779-P5	7832780	Z1, Z2, Z3	11.5	2,585	15.5	3,485	0.09	19.6	16.7	4000	2.0
20	20	FH	7832783-P5	7832784	Z2, Z3	10.8	2,428	18.6	4,181	0.08	19.6	16.7	4000	1.9
25	5	FK	7832786-P5	7832787	Z1, Z2, Z3	13.1	2,945	20.2	4,541	0.09	24.6	21.7	5000	3.3
25	10	FH	7832790-P5	7832791	Z2, Z3	22.9	5,148	141.2	31,743	0.09	24.6	21.7	5000	3.3
25	25	FH	7832793-P5	7832794	Z2, Z3	13.1	2,945	26.0	5,845	0.08	24.6	22.0	5000	3.3
32	5	FK	7832795-P5	7832796	Z1, Z2, Z3	19.3	4,339	36.3	8,161	0.09	31.6	28.7	6000	5.6
32	10	FK	7832798-P5	7832799	Z1, Z2, Z3	26.4	5,935	39.0	8,768	0.15	31.6	27.1	6000	5.3
32	20	FH	7832802-P5	7832803	Z2, Z3	47.2	10,611	83.2	18,704	0.15	31.6	27.1	6000	5.3
32	32	FH	7833301-P5	7833300	Z2, Z3	19.7	4,429	37.4	8,408	0.08	31.3	28.3	6000	5.3
40	5	FK	7832804-P5	7832805	Z1, Z2, Z3	26.3	5,912	59.2	13,309	0.09	39.6	36.7	6000	9.0
40	10	FK	7832808-P5	7832809	Z1, Z2, Z3	64.9	14,590	109.0	24,504	0.18	39.6	34.0	6000	8.3
40	20	FH	7832811-P5	7832812	Z2, Z3	52.2	11,735	103.6	23,290	0.15	39.6	35.2	6000	7.6
40	40	FH	7832814-P5	7832815	Z2, Z3	59.7	13,421	108.9	24,482	0.18	39.6	34.0	6000	8.4
50	10	FK	7832817-P5	7832818	Z1, Z2, Z3	66.4	14,927	134.3	30,192	0.18	49.5	43.0	6000	13.5
50	20	FH	7832820-P5	7832821	Z2, Z3	78.8	17,715	188.7	42,421	0.16	49.5	44.6	6000	13.6
63	10	FK	7832822-P5	7832823	Z1, Z2, Z3	93.8	21,087	229.7	51,639	0.18	62.5	56.9	6000	22.0
63	20	FH	7832825-P5	7832826	Z2, Z3	103.1	23,178	270.8	60,878	0.18	62.5	56.9	6000	22.0
80	10	FK	7832827-T7	7832828	Z1, Z2, Z3	121.9	27,404	374.9	84,281	0.18	79.5	73.9	6000	36.4

(1) 80mm nominal diameter screws are  $\pm 52\mu\text{m}/300\text{mm}$ .

(2) Thomson NEFF Ball Screws, Ball Nuts and End Blocks can be sold together as assemblies or separately as components (preloaded ball nuts sold only as an assembly).

(3) All ball screws and nuts are right-hand thread.

(4) Dimensional information on bearing supports and standard end machining is available on page 148.

(5) Max. length includes 150mm on each end usable for end machining only. Max. travel length equals table value minus 300mm. Ends are hardened.

(6) -P5 Accuracy Class is  $\pm 23\mu\text{m}/300\text{mm}$ . -T7 Accuracy Class is  $\pm 52\mu\text{m}/300\text{mm}$

(7) -P3 Accuracy Class is  $\pm 12\mu\text{m}/300\text{mm}$ . and is available upon request for most sizes.

**Thomson NEFF Rolled Ball Screws — FK/FH Style Ball Nuts**

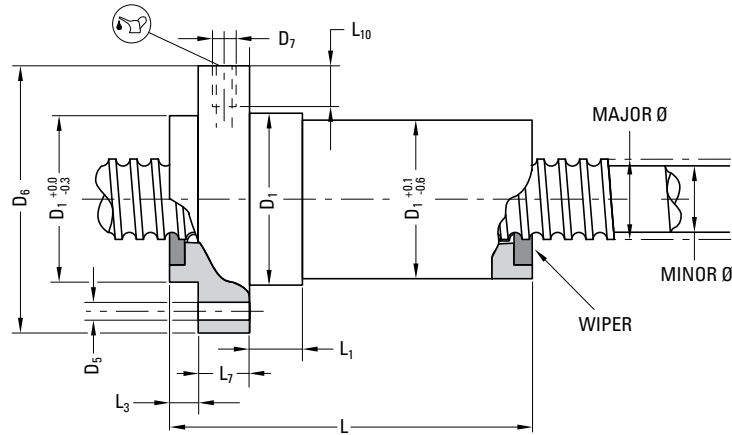

	D <sub>7</sub>	L <sub>10</sub>
d <sub>0</sub> < 40mm	M6 x 1	8
d <sub>0</sub> ≥ 40mm	M8 x 1	10

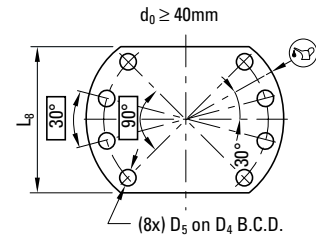
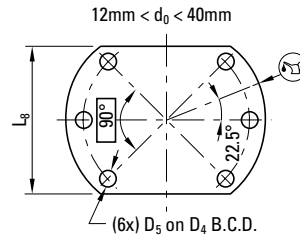
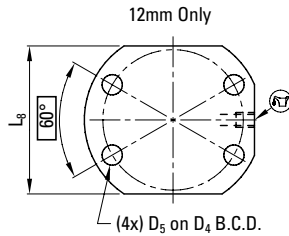

Ball Screws - Metric Series

Nominal Diameter (size)	Lead	Nut Specifications (mm)										
		D <sub>1</sub>	D <sub>4</sub>	D <sub>5</sub>	D <sub>6</sub>	L	L <sub>1</sub>	L <sub>3</sub>	L <sub>7</sub>	L <sub>8</sub>	Nut Weight	Ball Diameter
(mm)	(mm)	g6		H13	h13				h13	h13	(kg)	(mm)
16	5	28.0	38.0	5.5	48.0	48.5	10.0	5.5	10.0	40.0	0.3	3.500
20	5	36.0	47.0	6.6	58.0	48.5	10.0	5.5	10.0	44.0	0.4	3.500
20	20	36.0	47.0	6.6	58.0	36.0	4.0	11.0	10.0	44.0	0.5	3.500
25	5	40.0	51.0	6.6	62.0	49.0	10.0	6.0	10.0	48.0	0.4	3.500
25	10	40.0	51.0	6.6	62.0	51.0	9.0	16.0	10.0	48.0	0.5	3.500
25	25	40.0	51.0	6.6	62.0	39.0	9.0	10.0	10.0	48.0	0.6	3.500
32	5	50.0	65.0	9.0	80.0	57.0	10.0	6.0	12.0	62.0	0.7	3.500
32	10	50.0	65.0	9.0	80.0	73.0	16.0	6.0	12.0	62.0	0.8	5.556
32	20	56.0	71.0	9.0	86.0	83.0	25.0	19.0	12.0	68.0	1.4	5.556
32	32	56.0	71.0	9.0	86.0	42.0	12.0	9.0	12.0	68.0	0.8	3.969
40	5	63.0	78.0	9.0	93.0	66.0	10.0	7.0	14.0	70.0	1.2	3.500
40	10	63.0	78.0	9.0	93.0	88.5	16.0	7.0	14.0	70.0	1.4	7.144
40	20	63.0	78.0	9.0	93.0	83.0	25.0	19.5	14.0	70.0	1.6	5.556
40	40	70.0	85.0	9.0	100.0	104.0	25.0	21.0	14.0	77.0	2.4	7.144
50	10	75.0	93.0	11.0	110.0	92.0	16.0	7.0	16.0	85.0	2.0	7.144
50	20	75.0	93.0	11.0	110.0	85.0	16.0	22.0	16.0	85.0	2.2	6.400
63	10	90.0	108.0	11.0	125.0	103.5	16.0	7.0	18.0	95.0	3.0	7.144
63	20	95.0	115.0	13.5	135.0	86.0	18.0	24.0	20.0	100.0	3.8	7.144
80	10	105.0	125.0	13.5	145.0	121.0	16.0	9.0	20.0	110.0	3.9	7.144



## Thomson NEFF Rolled Ball Screws — KGF-D Style Ball Nuts

Standard Lead Accuracy:  $\pm 23\mu\text{m}/300\text{mm}^{(1)}$



**KGF-D Style Nut**

**p141** *Quick Install Available for Select Nuts*

### Internal Return Flanged Ball Nut and Screw

- Flexible solution for standard mounting
- Integral wiper and flange included as standard
- Available in three preload classes (Type Z1, Z2, Z3)
  - Z1 – light preload to 1 – 2%
  - Z2 – no preload, clearance held to max indicated in table
  - Z3 – no preload, clearance held to max .05mm

Nominal Diameter (size)	Lead	Nut Type	Ball Screw P/N <sup>(1) (2) (3)</sup>	Ball Nut P/N	Available Preload Types <sup>(4)</sup>	Performance Data				Screw Specifications <sup>(6)</sup>				
						Dynamic Load Capacity (C <sub>am</sub> )		Static Load Capacity (C <sub>o</sub> )		Max. Axial Backlash	Major Diameter	Minor Diameter	Max. Length <sup>(7)</sup>	Screw Weight
						(kN)	(lbf)	(kN)	(lbf)					
12	10	S	KGS-1210-023-RH	KGF-D-1210-RH-EE	Z1, Z2, Z3	4.9	1,102	8.0	1,800	0.08	11.5	10.1	3000	0.8
16	5	E	KGS-1605-023-RH	KGF-D-1605-RH-EE	Z1, Z2, Z3	9.3	2,091	13.1	2,945	0.08	15.3	12.9	6000	1.3
16	10	E	KGS-1610-023-RH	KGF-D-1610-RH-EE	Z1, Z2, Z3	15.4	3,462	26.5	5,957	0.08	15.2	13.0	6000	1.3
20	5	E	KGS-2005-023-RH	KGF-D-2005-RH-EE	Z1, Z2, Z3	10.5	2,361	16.6	3,732	0.08	19.3	16.9	6000	2.0
25	5	E	KGS-2505-023-RH	KGF-D-2505-RH-EE	Z1, Z2, Z3	12.3	2,766	22.5	5,058	0.08	24.3	21.9	6000	3.3
25	10	E	KGS-2510-023-RH	KGF-D-2510-RH-EE	Z1, Z2, Z3	13.2	2,968	25.3	5,688	0.08	24.3	21.9	6000	3.3
25	20	S	KGS-2520-023-RH	KGF-D-2520-RH-EE	Z2, Z3	13.0	2,921	23.3	5,238	0.15	24.4	22.0	6000	3.3
25	25	S	KGS-2525-023-RH	KGF-D-2525-RH-EE	Z2, Z3	16.7	3,755	32.2	7,239	0.08	24.3	22.0	6000	3.3
25	50	S	KGS-2550-023-RH	KGF-D-2550-RH-EE	Z2, Z3	15.4	3,463	31.7	7,126	0.15	23.9	21.5	6000	3.3
32	5	E	KGS-3205-023-RH	KGF-D-3205-RH-EE	Z1, Z2, Z3	21.5	4,834	49.3	11,083	0.08	31.3	28.9	6000	5.6
32	10	E	KGS-3210-023-RH	KGF-D-3210-RH-EE	Z1, Z2, Z3	33.4	7,509	54.5	12,252	0.08	32.5	27.3	6000	5.6
32	20	E	KGS-3220-023-RH	KGF-D-3220-RH-EE	Z2, Z3	29.7	6,678	59.8	13,444	0.08	31.5	27.9	6000	5.6
32	32	S	KGS-3232-023-RH	KGF-D-3232-RH-EE	Z2, Z3	18.0	4,047	34.7	7,800	0.15	31.6	27.1	6000	5.3
40	5	E	KGS-4005-023-RH	KGF-D-4005-RH-EE	Z1, Z2, Z3	23.8	5,351	63.1	14,185	0.08	39.3	36.9	6000	9.0
40	10	E	KGS-4010-023-RH	KGF-D-4010-RH-EE	Z1, Z2, Z3	38.0	8,544	69.1	15,534	0.08	39.3	34.1	6000	8.4
40	20	E	KGS-4020-023-RH	KGF-D-4020-RH-EE	Z2, Z3	33.3	7,487	76.1	17,108	0.08	39.5	35.9	6000	9.0
40	40	S	KGS-4040-023-RH	KGF-D-4040-RH-EE	Z2, Z3	35.0	7,869	101.9	22,908	0.08	38.7	36.3	6000	9.0
50	10	E	KGS-5010-023-RH	KGF-D-5010-RH-EE	Z1, Z2, Z3	68.7	15,446	155.8	35,025	0.08	49.3	44.1	6000	13.5
50	20	E	KGS-5020-023-RH	KGF-D-5020-RH-EE	Z2, Z3	60.0	13,490	136.3	30,641	0.08	49.3	44.1	6000	13.5
63	10	E	KGS-6310-023-RH	KGF-D-6310-RH-EE	Z2, Z3	76.0	17,086	197.0	44,290	0.08	62.6	57.2	6000	22.0
63	20	E	KGS-6320-023-RH	KGF-D-6320-RH-EE	Z2, Z3	65.1	14,635	169.5	38,105	0.08	62.6	57.2	6000	22.0

(1) -P3 Accuracy Class is  $\pm 12\mu\text{m}/300\text{mm}$ . and is available upon request for most sizes.

(2) Thomson NEFF Rolled Ball Screws, Ball Nuts and End Blocks can be sold together as assemblies or separately as components (preloaded ball nuts sold only as an assembly).

(3) All ball screws and nuts are right-hand thread.

(4) Double nut pre-load systems (for up to 10% of dynamic load rating) are also available for all sizes. Contact customer service for more details.

(5) Round flange.

(6) Dimensional information on bearing supports and standard end machining is available on page 148.

(7) Max. length includes 200mm on each end usable for end machining only. Max. travel length equals table value minus 400mm. Ends are soft annealed.



## Thomson NEFF Rolled Ball Screws — KGF-D Style Ball Nuts

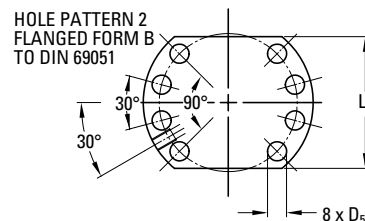
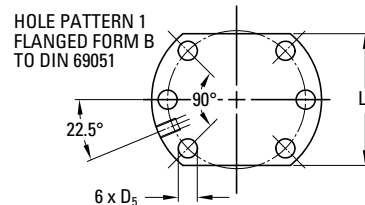
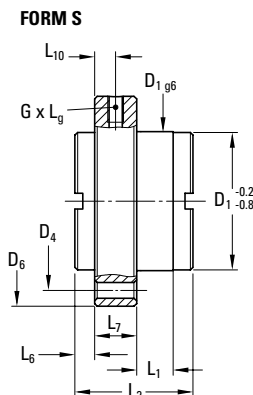
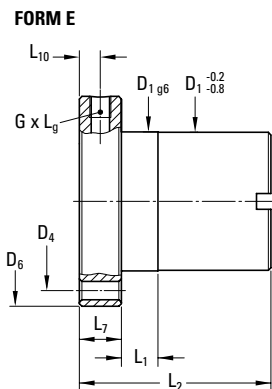

**MATERIAL:** 1.7131 (ESP65) / 1.3505 (100 Cr 6)

Nominal Diameter (size)	Lead	Hole Pattern	Nut Specifications (mm)														
			D <sub>1</sub>	D <sub>4</sub>	D <sub>5</sub>	D <sub>6</sub>	L <sub>1</sub>	L <sub>2</sub>	L <sub>6</sub>	L <sub>7</sub>	L <sub>8</sub>	L <sub>9</sub>	L <sub>10</sub>	Lube Hole (G)	No. of Circuits	Nut Weight (kg)	Ball Diameter (mm)
(mm)	(mm)		g6														
12	10	1	24.0	32.0	4.5	40.0	9.5	27.5	5.0	8.0	26.0	6.0	4.0	M 5x.8	3	0.10	2.000
16	5	1	28.0	38.0	5.5	48.0	10.0	42.0	—	10.0	40.0	10.0	5.0	M 6	3	0.20	3.500
16	10	1	28.0	38.0	5.5	48.0	10.0	55.0	—	10.0	40.0	10.0	5.0	M 6	6	0.30	3.000
20	5	1	36.0	47.0	6.6	58.0	10.0	42.0	—	10.0	44.0	10.0	5.0	M 6	3	0.25	3.500
25	5	1	40.0	51.0	6.6	62.0	10.0	42.0	—	10.0	48.0	10.0	5.0	M 6	3	0.35	3.500
25	10	1	40.0	51.0	6.6	62.0	16.0	55.0	—	10.0	48.0	10.0	5.0	M 6	3	0.45	3.500
25	20	1	40.0	51.0	6.6	62.0	4.0	35.0	10.5	10.0	48.0	8.0	5.0	M 6	4	0.30	3.500
25	25	1	40.0	51.0	6.6	62.0	9.0	35.0	8.0	10.0	N/A <sup>(5)</sup>	8.0	5.0	M 6	5	0.65	3.500
25	50	1	40.0	51.0	6.6	62.0	10.0	58.0	10.0	10.0	48.0	8.0	5.0	M 6	5	0.40	3.500
32	5	1	50.0	65.0	9.0	80.0	10.0	55.0	—	12.0	62.0	10.0	6.0	M 6	5	0.55	3.500
32	10	1	53.0	65.0	9.0	80.0	16.0	69.0	—	12.0	62.0	10.0	6.0	M 8x1	3	0.90	7.140
32	20	1	53.0	65.0	9.0	80.0	16.0	80.0	—	12.0	62.0	10.0	6.0	M 6	4	1.10	5.000
32	32	1	50.0	65.0	9.0	80.0	12.0	42.0	9.0	12.0	62.0	8.0	6.0	M6	3	0.80	3.969
40	5	2	63.0	78.0	9.0	93.0	10.0	57.0	—	14.0	70.0	10.0	7.0	M 6	5	0.70	3.500
40	10	2	63.0	78.0	9.0	93.0	16.0	71.0	—	14.0	70.0	10.0	7.0	M 8x1	3	1.20	7.140
40	20	2	63.0	78.0	9.0	93.0	16.0	80.0	—	14.0	70.0	10.0	7.0	M 8x1	4	1.50	5.000
40	40	2	63.0	78.0	9.0	93.0	16.0	85.0	7.5	14.0	N/A <sup>(5)</sup>	10.0	7.0	M 8x1	8	1.20	3.500
50	10	2	75.0	93.0	11.0	110.0	16.0	95.0	—	16.0	85.0	10.0	8.0	M 8x1	5	2.00	7.140
50	20	2	85.0	103.0	11.0	125.0	22.0	95.0	—	18.0	95.0	10.0	9.0	M 8x1	4	2.50	7.140
63	10	2	90.0	108.0	11.0	125.0	16.0	97.0	—	18.0	95.0	10.0	9.0	M 8x1	5	2.95	7.140
63	20	2	95.0	115.0	14.0	135.0	25.0	99.0	—	20.0	100.0	10.0	10.0	M 8x1	4	2.95	7.140

## Thomson NEFF Rolled Ball Screws — KGF-N Style Ball Nuts

Standard Lead Accuracy:  $\pm 23\mu\text{m}/300\text{mm}^{(1)}$



**KGF-N Style Nut**



**Quick Install**  
Available for 32x40 Only

### Internal Return Flanged Ball Nut and Screw

- Flexible solution for non-standard mounting
- Integral wiper and flange included as standard
- Available in three preload classes (Type Z1, Z2, Z3)
  - Z1 – light preload to 1 – 2%
  - Z2 – no preload, clearance held to max indicated in table
  - Z3 – no preload, clearance held to max .05mm

Nominal Diameter (size)	Lead	Nut Type	Ball Screw P/N <sup>(1) (2) (3)</sup>	Ball Nut P/N	Available Preload Types <sup>(4)</sup>	Performance Data				Screw Specifications <sup>(5)</sup>				
						Z2 Standard	Dynamic Load Capacity (C <sub>am</sub> )		Static Load Capacity (C <sub>o</sub> )		Max. Axial Backlash	Major Diameter	Minor Diameter	Max. Length <sup>(6)</sup>
				(kN)			(lbf)	(kN)	(lbf)	(mm)				
16	5	E	KGS-1605-023-RH	KGF-N-1605-RH-EE	Z1, Z2, Z3	9.3	2,091	13.1	2,945	0.08	15.3	12.9	6000	1.3
20	5	E	KGS-2005-023-RH	KGF-N-2005-RH-EE	Z1, Z2, Z3	10.5	2,361	16.6	3,732	0.08	19.3	16.9	6000	2.0
20	20	S	KGS-2020-023-RH	KGF-N-2020-RH-EE	Z2, Z3	11.6	2,608	18.4	4,136	0.08	19.3	16.9	6000	2.0
20	50	S	KGS-2050-023-RH	KGF-N-2050-RH-EE	Z2, Z3	13.0	2,923	24.6	5,530	0.15	18.9	16.5	6000	2.0
25	5	E	KGS-2505-023-RH	KGF-N-2505-RH-EE	Z1, Z2, Z3	12.3	2,766	22.5	5,058	0.08	24.3	21.9	6000	3.3
32	5	E	KGS-3205-023-RH	KGF-N-3205-RH-EE	Z1, Z2, Z3	21.5	4,834	49.3	11,083	0.08	31.3	28.9	6000	5.6
32	10	E	KGS-3210-023-RH	KGF-N-3210-RH-EE	Z1, Z2, Z3	33.4	7,509	54.5	12,252	0.08	32.5	27.3	6000	5.6
32	40	S	KGS-3240-023-RH	KGF-N-3240-RH-EE	Z2, Z3	14.9	3,350	32.4	7,284	0.08	30.7	28.3	6000	5.6
40	5	E	KGS-4005-023-RH	KGF-N-4005-RH-EE	Z1, Z2, Z3	23.8	5,351	63.1	14,185	0.08	39.3	36.9	6000	9.0
40	10	E	KGS-4010-023-RH	KGF-N-4010-RH-EE	Z1, Z2, Z3	38.0	8,544	69.1	15,534	0.08	39.3	34.1	6000	8.4
50	10	E	KGS-5010-023-RH	KGF-N-5010-RH-EE	Z1, Z2, Z3	68.7	15,446	155.8	35,025	0.08	49.3	44.1	6000	13.5
63	10	E	KGS-6310-023-RH	KGF-N-6310-RH-EE	Z1, Z2, Z3	76.0	17,087	197.0	44,287	0.08	62.3	57.1	6000	22.0
80	10	E	KGS-8010-023-RH	KGF-N-8010-RH-EE	Z2, Z3	86.3	19,390	262.4	58,993	0.08	79.7	74.2	6000	36.4

(1) -P3 Accuracy Class is  $\pm 12\mu\text{m}/300\text{mm}$ . and is available upon request for most sizes.

(2) Thomson NEFF Rolled Ball Screws, Ball Nuts and End Blocks can be sold together as assemblies or separately as components (preloaded ball nuts sold only as an assembly).

(3) All ball screws and nuts are right-hand thread.

(4) Double nut pre-load systems (for up to 10% of dynamic load rating) are also available for all sizes. Contact customer service for more details.

(5) Dimensional information on bearing supports and standard end machining is available on page 148.

(6) Max. length includes 200mm on each end usable for end machining only. Max. travel length equals table value minus 400mm. Ends are soft annealed.

## Thomson NEFF Rolled Ball Screws — KGF-N Style Ball Nuts

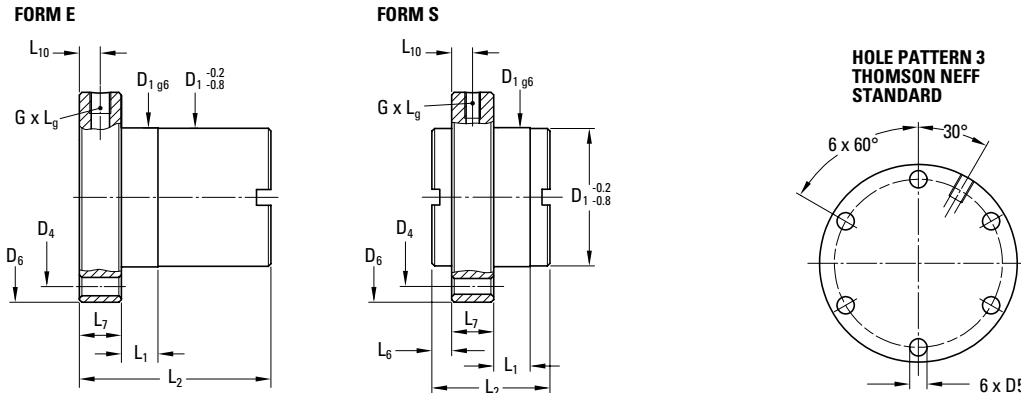

**MATERIAL:** 1.7131 (ESP65) / 1.3505 (100 Cr 6)

Nominal Diameter (size)	Lead	Nut Specifications (mm)													
		D <sub>1</sub>	D <sub>4</sub>	D <sub>5</sub>	D <sub>6</sub>	L <sub>1</sub>	L <sub>2</sub>	L <sub>6</sub>	L <sub>7</sub>	L <sub>9</sub>	L <sub>10</sub>	Lube Hole (G)	No. of Circuits	Nut Weight (kg)	Ball Diameter (mm)
(mm)	(mm)	g6													
16	5	28.0	38.0	5.5	48.0	8.0	44.0	—	12.0	8.0	6.0	M 6	3	0.20	3.500
20	5	32.0	45.0	7.0	55.0	8.0	44.0	—	12.0	8.0	6.0	M 6	3	0.25	3.500
20	20	35.0	50.0	7.0	62.0	4.0	30.0	8.0	10.0	8.0	5.0	M 6	4	0.25	3.500
20	50	35.0	50.0	7.0	62.0	10.0	56.0	9.0	10.0	8.0	5.0	M 6	5	0.40	3.500
25	5	38.0	50.0	7.0	62.0	8.0	46.0	—	14.0	8.0	7.0	M 6	3	0.35	3.500
32	5	45.0	58.0	7.0	70.0	10.0	59.0	—	16.0	8.0	8.0	M 6	5	0.55	3.500
32	10	53.0	68.0	7.0	80.0	10.0	73.0	—	16.0	8.0	8.0	M 8x1	3	0.90	7.140
32	40	53.0	68.0	7.0	80.0	14.0	45.0	7.5	16.0	10.0	8.0	M 6	4	0.45	3.500
40	5	53.0	68.0	7.0	80.0	10.0	59.0	—	16.0	8.0	8.0	M 6	5	0.70	3.500
40	10	63.0	78.0	9.0	95.0	10.0	73.0	—	16.0	8.0	8.0	M 8x1	3	1.20	7.140
50	10	72.0	90.0	11.0	110.0	10.0	97.0	—	18.0	8.0	9.0	M 8x1	5	2.00	7.140
63	10	85.0	105.0	11.0	125.0	10.0	99.0	—	20.0	8.0	10.0	M 8x1	5	2.80	7.140
80	10	105.0	125.0	14.0	145.0	10.0	101.0	—	22.0	8.0	11.0	M 8x1	5	3.90	7.144

## Thomson NEFF Rolled Ball Screws — KGM-D Style Ball Nuts

Standard Lead Accuracy:  $\pm 23\mu\text{m}/300\text{mm}^{(1)}$

Threaded ball nut and screw, offering low cost, high precision performance in applications typically requiring ground product.



**KGM-D Style Nut**

**p141**  
**Quick Install**  
**Available for Select Nuts**

### Internal Return Cylindrical Ball Nut and Screw

- Flexible solution for standard mounting
- Integral wiper included as standard
- Available in three preload classes (Type Z1, Z2, Z3)
  - Z1 – light preload to 1-2%
  - Z2 – no preload, clearance held to max indicated in table
  - Z3 – no preload, clearance held to max .05mm

Nominal Diameter (size)	Lead	Nut Type	Ball Screw P/N <sup>(1) (2) (3)</sup>	Ball Nut P/N	Available Preload Types <sup>(4)</sup>	Performance Data				Screw Specifications <sup>(5)</sup>				
						Dynamic Load Capacity ( $C_{am}$ )		Static Load Capacity ( $C_o$ )		Max. Axial Backlash	Major Diameter	Minor Diameter	Max. Length <sup>(6)</sup>	Screw Weight
						(kN)	(lbf)	(kN)	(lbf)					
12	10	S	KGS-1210-023-RH	KGM-D-1210-RH-EE	Z1, Z2, Z3	4.9	1,102	8.0	1,799	0.08	11.5	10.1	3000	0.8
16	5	E	KGS-1605-023-RH	KGM-D-1605-RH-EE	Z1, Z2, Z3	9.3	2,091	13.1	2,945	0.08	15.3	12.9	6000	1.3
16	10	E	KGS-1610-023-RH	KGM-D-1610-RH-EE	Z1, Z2, Z3	15.4	3,463	26.5	5,957	0.08	15.2	13.0	6000	1.3
20	5	E	KGS-2005-023-RH	KGM-D-2005-RH-EE	Z1, Z2, Z3	10.5	2,361	16.6	3,732	0.08	19.3	16.9	6000	2.0
25	5	E	KGS-2505-023-RH	KGM-D-2505-RH-EE	Z1, Z2, Z3	12.3	2,766	22.5	5,058	0.08	24.3	21.9	6000	3.3
25	10	E	KGS-2510-023-RH	KGM-D-2510-RH-EE	Z1, Z2, Z3	13.2	2,947	25.3	5,688	0.08	24.3	21.9	6000	3.3
25	20	S	KGS-2520-023-RH	KGM-D-2520-RH-EE	Z2, Z3	13.0	2,923	23.3	5,238	0.15	24.4	22.0	6000	3.3
25	25	S	KGS-2525-023-RH	KGM-D-2525-RH-EE	Z2, Z3	16.7	3,755	32.2	7,239	0.08	24.3	22.0	6000	3.3
25	50	S	KGS-2550-023-RH	KGM-D-2550-RH-EE	Z2, Z3	15.4	3,463	31.7	7,126	0.15	23.9	21.5	6000	3.3
32	5	E	KGS-3205-023-RH	KGM-D-3205-RH-EE	Z1, Z2, Z3	21.5	4,834	49.3	11,083	0.08	31.3	28.9	6000	5.6
40	5	E	KGS-4005-023-RH	KGM-D-4005-RH-EE	Z1, Z2, Z3	23.8	5,351	63.1	14,185	0.08	39.3	36.9	6000	9.0
40	10	E	KGS-4010-023-RH	KGM-D-4010-RH-EE	Z1, Z2, Z3	38.0	8,544	69.1	15,534	0.08	39.3	34.1	6000	8.4
40	20	E	KGS-4020-023-RH	KGM-D-4020-RH-EE	Z1, Z2, Z3	33.3	7,487	76.1	17,108	0.08	39.5	35.9	6000	9.0
40	40	S	KGS-4040-023-RH	KGM-D-4040-RH-EE	Z2, Z3	35.0	7,869	101.9	22,908	0.08	38.7	36.3	6000	9.0
50	10	E	KGS-5010-023-RH	KGM-D-5010-RH-EE	Z2, Z3	82.0	18,435	153.0	34,398	0.08	49.6	44.1	6000	13.5
63	10	E	KGS-6310-023-RH	KGM-D-6310-RH-EE	Z2, Z3	90.0	20,234	200.0	44,964	0.08	62.6	57.2	6000	22.1
63	20	E	KGS-6320-023-RH	KGM-D-6320-RH-EE	Z2, Z3	65.1	14,635	169.5	38,105	0.08	62.6	57.2	6000	22.0

(1) -P3 Accuracy Class is  $\pm 12\mu\text{m}/300\text{mm}$ . and is available upon request for most sizes.

(2) Thomson NEFF Rolled Ball Screws, Ball Nuts and End Blocks can be sold together as assemblies or separately as components (preloaded ball nuts sold only as an assembly).

(3) All ball screws and nuts are right-hand thread.

(4) Double nut pre-load systems (for up to 10% of dynamic load rating) are also available for all sizes. Contact customer service for more details.

(5) Dimensional information on bearing supports and standard end machining is available on page 148.

(6) Max. length includes 200mm on each end usable for end machining only. Max. travel length equals table value minus 400mm. Ends are soft annealed.

## Thomson NEFF Rolled Ball Screws — KGM-D Style Ball Nuts

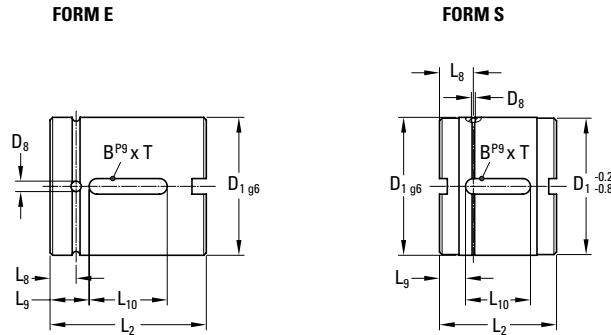

**MATERIAL:** 1.7131 (ESP65) / 1.3505 (100 Cr 6)

Nominal Diameter (size)	Lead	Nut Specifications (mm)									
		D <sub>1</sub>	D <sub>8</sub>	L <sub>2</sub>	L <sub>8</sub>	L <sub>9</sub>	L <sub>10</sub>	BxT	No. of Circuits	Nut Weight	Ball Diameter
(mm)	(mm)	g6								(kg)	(mm)
12	10	24.0	2.0	27.5	7.0	8.75	10.0	3x1.8	4	0.10	2.000
16	5	28.0	3.0	34.0	7.0	7.0	20.0	5x2	3	0.10	3.500
16	10	28.0	3.0	50.0	7.0	15.0	20.0	5x2	6	0.20	3.000
20	5	36.0	3.0	34.0	7.0	7.0	20.0	5x2	3	0.20	3.500
25	5	40.0	3.0	34.0	7.0	7.0	20.0	5x2	3	0.20	3.500
25	10	40.0	3.0	45.0	7.5	12.5	20.0	5x2	3	0.24	3.500
25	20	40.0	1.5	35.0	14.0	11.5	12.0	5x3	4	0.20	3.500
25	25	40.0	1.5	35.0	11.5	11.0	13.0	5x3	5	0.45	3.500
25	50	40.0	1.5	58.0	17.0	19.0	20.0	5x3	5	0.30	3.500
32	5	50.0	3.0	45.0	7.5	8.0	30.0	6x2.5	5	0.50	3.500
40	5	63.0	3.0	45.0	7.5	8.0	30.0	6x2.5	5	0.80	3.500
40	10	63.0	4.0	60.0	10.0	15.0	30.0	6x2.5	3	1.00	7.140
40	20	63.0	3.0	70.0	7.5	20.0	30.0	6x2.5	4	1.20	5.000
40	40	63.0	1.5	85.0	15.0	27.5	30.0	6x3.5	8	0.90	3.500
50	10	75.0	4.0	82.0	11.0	23.0	36.0	6x2.5	5	0.90	7.144
63	10	90.0	4.0	82.0	11.0	23.0	36.0	6x2.5	5	0.90	7.144
63	20	95.0	4.0	82.0	10.0	23.0	36.0	6x2.5	4	1.95	7.140

## Thomson NEFF Rolled Ball Screws — KGM-N Style Ball Nuts

Standard Lead Accuracy:  $\pm 23\mu\text{m}/300\text{mm}^{(1)}$

Threaded ball nut and screw, offering low cost, high precision performance in applications typically requiring ground product.



**p141**  
**Quick Install**  
**Available for Select Nuts**

**KGM-N Style Nut**

### Internal Return Cylindrical Ball Nut and Screw

- Flexible solution for non-standard mounting
- Integral wiper included as standard<sup>(5)</sup>
- Available in three preload classes (Type Z1, Z2, Z3)
  - Z1 – light preload to 1 – 2%
  - Z2 – no preload, clearance held to max indicated in table
  - Z3 – no preload, clearance held to max .05mm

Nominal Diameter (size)	Lead	Nut Type	Ball Screw P/N <sup>(1) (2) (3)</sup>	Ball Nut P/N	Available Preload Types <sup>(4)</sup>	Performance Data				Screw Specifications <sup>(7)</sup>				
						Dynamic Load Capacity (C <sub>am</sub> )		Static Load Capacity (C <sub>o</sub> )		Max. Axial Backlash	Major Diameter	Minor Diameter	Max. Length <sup>(8)</sup>	Screw Weight
						(kN)	(lbf)	(kN)	(lbf)					
12	5	E	KGS-1205-023-RH	KGM-N-1205-RH-00	Z1, Z2, Z3	4.4	990	6.8	1,529	0.08	11.3	10.1	1500 <sup>(9)</sup>	0.8
20	5	E	KGS-2005-023-RH	KGM-N-2005-RH-EE	Z1, Z2, Z3	10.5	2,361	16.6	3,732	0.08	19.3	16.9	6000	2.0
20	20	S	KGS-2020-023-RH	KGM-N-2020-RH-EE	Z2, Z3	11.6	2,608	18.4	4,136	0.08	19.3	16.9	6000	2.0
20	50	S	KGS-2050-023-RH	KGM-N-2050-RH-EE	Z2, Z3	13.0	2,923	24.6	5,530	0.15	18.9	16.5	6000	2.0
25	5	E	KGS-2505-023-RH	KGM-N-2505-RH-EE	Z1, Z2, Z3	12.3	2,766	22.5	5,058	0.08	24.3	21.9	6000	3.3
32	5	E	KGS-3205-023-RH	KGM-N-3205-RH-EE	Z1, Z2, Z3	21.5	4,834	49.3	11,083	0.08	31.3	28.9	6000	5.6
32	10	E	KGS-3210-023-RH	KGM-N-3210-RH-EE	Z1, Z2, Z3	33.4	7,509	54.5	12,252	0.08	32.5	27.3	6000	5.6
32	20	E	KGS-3220-023-RH	KGM-N-3220-RH-EE	Z1, Z2, Z3	29.7	6,678	59.8	13,444	0.08	31.5	27.9	6000	5.6
32	40	S	KGS-3240-023-RH	KGM-N-3240-RH-EE	Z2, Z3	14.9	3,350	32.4	7,284	0.08	30.7	28.3	6000	5.6
40	5	E	KGS-4005-023-RH	KGM-N-4005-RH-EE	Z1, Z2, Z3	23.8	5,351	63.1	14,185	0.08	39.3	36.9	6000	9.0
50	10	E	KGS-5010-023-RH	KGM-N-5010-RH-EE	Z1, Z2, Z3	68.7	15,446	155.8	35,025	0.08	49.3	44.1	6000	13.5
50	20	E	KGS-5020-023-RH	KGM-N-5020-RH-EE	Z1, Z2, Z3	60.0	13,490	136.3	30,641	0.08	49.3	44.1	6000	13.5
63	10	E	KGS-6310-023-RH	KGM-N-6310-RH-EE	Z1, Z2, Z3	76.0	17,087	197.0	44,287	0.08	62.3	57.1	6000	22.0
80	10	E	KGS-8010-023-RH	KGM-N-8010-RH-EE	Z2, Z3	86.3	19,402	262.4	58,993	0.08	79.7	74.2	6000	36.4

(1) -P3 Accuracy Class is  $\pm 12\mu\text{m}/300\text{mm}$ . and is available upon request for most sizes.

(2) Ball screws, ball nuts and end blocks can be sold together as assemblies or separately as components (preloaded ball nuts sold only as an assembly).

(3) All ball screws and nuts are right-hand thread.

(4) Double nut pre-load systems (for up to 10% of dynamic load rating) are also available for all sizes. Contact customer service for more details.

(5) 12x5 nut does not include wiper.

(6) D1 -0.2/-0.8 does not apply, therefore D1 -1.0/-1.5.

(7) Dimensional information on bearing supports and standard end machining is available on page 148.

(8) Max. length includes 200mm on each end usable for end machining only. Max. travel length equals table value minus 400mm. Ends are soft annealed.

(9) Max. length includes 100mm on each end usable for end machining only. Max. travel length equals table value minus 200mm. Ends are soft annealed.

## Thomson NEFF Rolled Ball Screws — KGM-N Style Ball Nuts

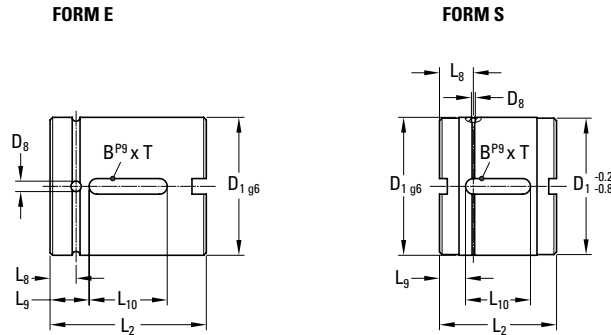

**MATERIAL:** 1.7131 (ESP65) / 1.3505 (100 Cr 6)

Nominal Diameter (size)	Lead	Nut Specifications (mm)									
		D <sub>1</sub>	D <sub>8</sub>	L <sub>2</sub>	L <sub>8</sub>	L <sub>9</sub>	L <sub>10</sub>	BxT	No. of Circuits	Nut Weight	Ball Diameter
(mm)	(mm)	g6								(kg)	(mm)
12	5	20.0 <sup>(5)</sup>	—	24.0	—	5.0	14.0	3x1.8	3	0.03	2.000
20	5	32.0	3.0	34.0	7.0	7.0	20.0	5x2	3	0.10	3.500
20	20	35.0	1.5	30.0	11.5	9.0	12.0	5x3	4	0.14	3.500
20	50	35.0	1.5	56.0	16.0	18.0	20.0	5x3	5	0.30	3.500
25	5	38.0	3.0	34.0	7.0	7.0	20.0	5x2	3	0.15	3.500
32	5	45.0	3.0	45.0	7.5	8.0	30.0	6x2.5	5	0.30	3.500
32	10	53.0	4.0	60.0	10.0	15.0	30.0	6x2.5	3	0.55	7.140
32	20	53.0	3.0	70.0	7.5	20.0	30.0	6x2.5	4	0.80	5.000
32	40	53.0 <sup>(6)</sup>	1.5	45.0	13.0	10.0	25.0	6x4	4	0.46	3.500
40	5	53.0	3.0	45.0	7.5	8.0	30.0	6x2.5	5	0.60	3.500
50	10	72.0	4.0	82.0	11.0	23.0	36.0	6x2.5	5	1.10	7.140
50	20	85.0	4.0	82.0	10.0	23.0	36.0	6x2.5	4	1.40	7.140
63	10	85.0	4.0	82.0	11.0	23.0	36.0	6x2.5	5	1.45	7.140
80	10	105.0	4.0	82.0	11.0	23.0	36.0	8x3	5	3.90	7.144

**NOTES:**





**Precision Plus Ball Screws — Metric Series**

**Precision Plus Ball Screw Assemblies** are our highest precision product, with standard lead accuracies of 12 microns/ 300mm. These ball screw assemblies feature our FL-style ball nut, precisely preloaded to customer specifications. This unique nut design provides high repeatability and high stiffness for the most demanding ball screw applications. Each nut comes standard with an integral plastic wiper to protect against chips and other debris. Precision Plus Ball Screws are ideal for applications requiring high repeatability and high stiffness (e.g., high precision machine tool).

Need a quote or have a question about an application?  
Contact us in North America at:

Phone: 540-633-3549

Fax: 540-639-4162

Email: [thomson@thomsonlinear.com](mailto:thomson@thomsonlinear.com)

## Precision Plus Ball Screws — Metric Series

Standard Lead Accuracy:  $\pm 12\mu\text{m}/300\text{mm}$

Flanged ball nut and screw assembly, offering the highest level of accuracy, repeatability and stiffness.



**FL Style Nut**

### Internal Return Flanged Ball Nut and Screw

- Excellent accuracy, repeatability and stiffness
- Features Z0 Type preload (range from 2% to 13%, to customer specification)
- Nut stiffness based on 10% preload ( $F = 10\% \times C_{am}$ )
- Integral wiper and flange included as standard
- Additional sizes available in diameters up to 160mm. Contact us for more details.

Nominal Diameter (size)	Lead	Nut Type	Ball Screw and Nut Assembly P/N <sup>(1) (2)</sup>	Performance Data							Screw Specifications <sup>(3)</sup>			
				Dynamic Load Capacity ( $C_{am}$ )		Static Load Capacity ( $C_o$ )		Minimum Stiffness	Max. Axial Backlash	No. of Loaded Turns	Major Diameter	Minor Diameter	Max. <sup>(4)</sup> Length	Screw Weight
				(kN)	(lbf)	(kN)	(lbf)	(kN/ $\mu\text{m}$ )	(mm)	(turns)	(mm)	(mm)	(mm)	(kg/m)
16	5	FL	<b>7832835</b>	6.7	1,506	7.2	1,619	0.16	0.00	2 + 2	15.6	12.7	3000	1.2
20	5	FL	<b>7832838</b>	11.5	2,585	15.5	3,485	0.30	0.00	3 + 3	19.6	16.7	4000	2.0
25	5	FL	<b>7832841</b>	12.6	2,833	19.1	4,294	0.38	0.00	3 + 3	24.5	21.7	4100	3.3
32	5	FL	<b>7832862</b>	19.3	4,339	36.4	8,183	0.60	0.00	4 + 4	31.6	28.7	4100	5.6
32	10	FL	<b>7832844</b>	26.4	5,935	39.0	8,768	0.49	0.00	3 + 3	31.6	27.1	4100	5.3
40	5	FL	<b>7832847</b>	26.3	5,912	59.2	13,309	0.89	0.00	5 + 5	39.6	36.7	4100	9.0
40	10	FL	<b>7832850</b>	64.9	14,590	109.0	24,504	0.94	0.00	4 + 4	39.6	34.0	4100	8.3
50	10	FL	<b>7832853</b>	69.0	15,511	142.2	31,966	1.18	0.00	4 + 4	49.5	43.0	4100	13.5
63	10	FL	<b>7832856</b>	93.8	21,087	229.7	51,639	1.74	0.00	5 + 5	62.5	56.9	4100	22.0

(1) End Blocks can be sold together as assemblies or separately as components (preloaded ball nuts sold only as an assembly).

(2) All ball screws and nuts are right-hand thread.

(3) Dimensional information on bearing supports and standard end machining is available on page 148.

(4) Longer screws are available (up to 11000) for some sizes at P5 Accuracy Class (23 $\mu\text{m}/300\text{mm}$ ).

**Precision Plus Ball Screws — Metric Series**

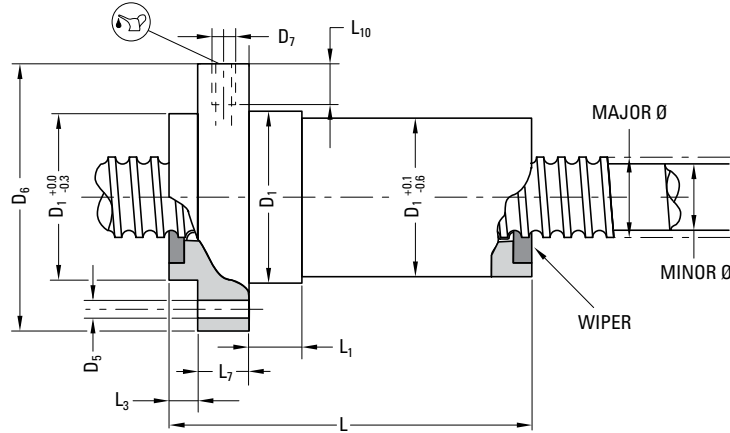

	$D_7$	$L_{10}$
$d_0 < 40\text{mm}$	M6 x 1	8
$d_0 \geq 40\text{mm}$	M8 x 1	10

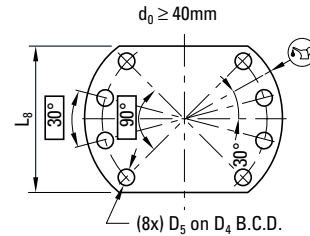
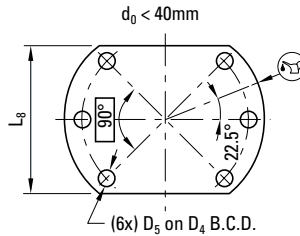

Nominal Diameter (size)	Lead	Nut Specifications (mm)										Nut Weight (kg)	Ball Diameter (mm)
		$D_1$	$D_4$	$D_5$	$D_6$	L	$L_1$	$L_3$	$L_7$	$L_8$			
(mm)	(mm)	g6		H13	h13				h13	h13			
16	5	28.0	38.0	5.5	48.0	55.0	10.0	5.5	10.0	40.0	0.3	3.500	
20	5	36.0	47.0	6.6	58.0	68.5	10.0	5.5	10.0	44.0	0.4	3.500	
25	5	40.0	51.0	6.6	62.0	69.5	10.0	6.0	10.0	48.0	0.4	3.500	
32	5	50.0	65.0	9.0	80.0	83.0	12.0	6.0	12.0	62.0	0.7	3.500	
32	10	50.0	65.0	9.0	80.0	105.5	12.0	6.0	12.0	62.0	0.8	3.500	
40	5	63.0	78.0	9.0	93.0	97.0	14.0	7.0	14.0	70.0	1.3	3.500	
40	10	63.0	78.0	9.0	93.0	142.0	14.0	7.0	14.0	70.0	1.5	7.144	
50	10	75.0	93.0	11.0	110.0	144.0	16.0	7.0	16.0	85.0	2.2	7.144	
63	10	90.0	108.0	11.0	125.0	166.0	18.0	7.0	18.0	95.0	3.3	7.144	

**NOTES:**



# Ball Splines



A Thomson Precision ball spline consists of mating inner and outer races containing concave axial races and a complement of bearing balls. The balls provide the only physical contact between the inner and outer races. Unlimited rolling travel is achieved by diverting the path of the balls at the extremes of the outer race into the end cap return circuit. This provides a closed loop through which the balls recirculate when the races are displaced axially relative to each other. The bearing balls resist radial displacement resulting from torque loads.

- Efficiency — coefficient of friction .007 maximum
- Hardness — minimum of RC 56 in ball race
- Lash — .005 inch maximum standard play perpendicular to rotational axis

Need a quote or have a question about an application?  
Contact us in North America at:

Phone: 540-633-3549

Fax: 540-639-4162

Email: [thomson@thomsonlinear.com](mailto:thomson@thomsonlinear.com)

## Precision Rolled Ball Splines

0.375 in to 6.000 in Diameter



### Inner and Outer Spline Races

- Offers high speed, anti-friction linear motion under high torsional loads
- All units available with and without keyway
- **All sizes stocked for quick delivery**

Nominal Diameter	Active Races <sup>(1)(2)</sup>	Inner Race P/N	Outer Race P/N (w/o keyway)	Outer Race P/N (w/ keyway)	Performance Data				Inner Race Specifications		
					Dynamic Load Capacity (C <sub>am</sub> )	Static Torque Capacity (C <sub>o</sub> )	Max. Diametral Backlash	Max. Angular Backlash	Root Diameter	Standard Length	Inner Weight
(in.)					(in-lb)	(in-lb)	(in.)	(radians)	(in.)	(in.)	(lb/in)
0.375	3	5707547	5706900	7828127	200	626	0.005	0.0266	0.200	24	0.02
0.625	3	5707548	5707445	7828128	585	1,770	0.005	0.0160	0.425	48	0.06
0.625	6	5707548	5708943	7828129	1,170	3,540	0.005	0.0160	0.425	48	0.06
1.000	3	5706084	5707472	7828130	1,300	3,900	0.005	0.0100	0.800	144	0.17
1.000	6	5706084	5708944	7828131	2,600	7,800	0.005	0.0100	0.800	144	0.17
1.500	3	5706388	5707528	7828132	4,200	11,588	0.005	0.0067	1.230	144	0.4
1.500	6	5706388	5708945	7828133	8,400	23,176	0.005	0.0067	1.230	144	0.4
2.000	3	5706436	5707530	7828134	8,000	20,138	0.005	0.0050	1.670	144	0.75
2.000	6	5706436	5708946	7828135	16,000	40,276	0.005	0.0050	1.670	144	0.75
2.500	3	5706484	5707532	7828136	13,500	36,625	0.005	0.0040	2.100	144	1.17
2.500	6	5706484	5708947	7828137	27,000	62,250	0.005	0.0040	2.100	144	1.17
4.062	6	5702204	5708330	7828138	57,000	140,000	0.005	0.0025	3.660	144	3.13
6.000	8	5704982	5704798	7828140	214,700	584,000	0.007	0.0023	5.470	72	7.01

(1) Dimensional information on bearing supports and standard end machining is available on page 148.

(2) Information on required lubrication is on page 225.

## Precision Rolled Ball Splines

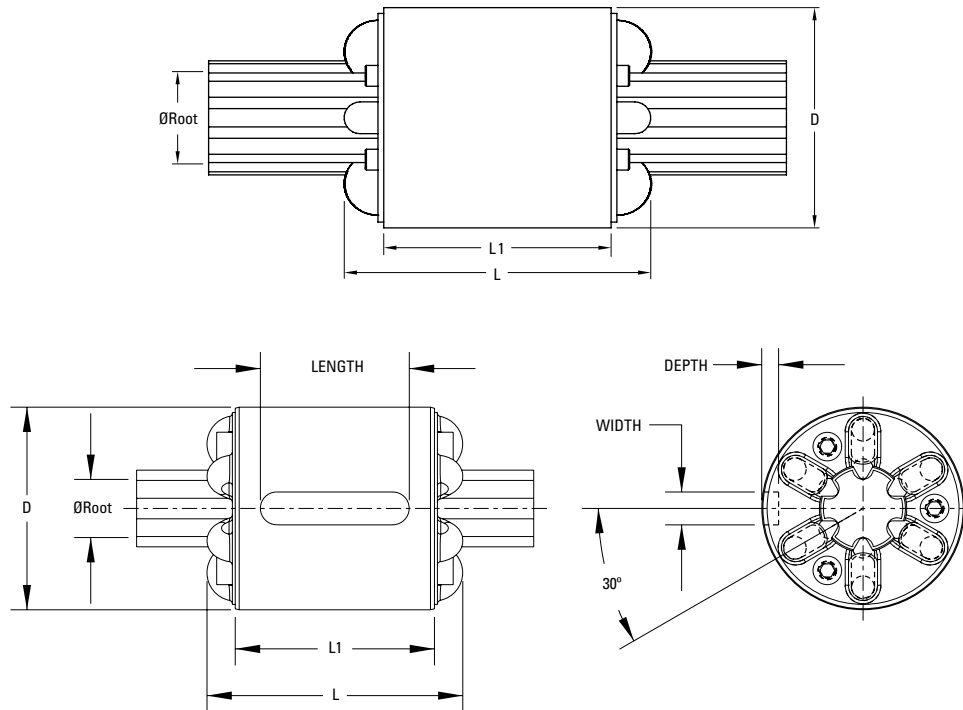

Nominal Diameter	Active Races	Outer Race Specifications					
		D (max.)	L	L1	Keyway Dimensions (Optional) (Width x Depth x Length)	Outer Weight	Ball Diameter
(in.)		(in.)	(in.)	(in.)	(in.)	(lb)	(in.)
0.375	3	1.161	1.589	1.099	0.187 x 0.093 x 1.000	0.25	0.156
0.625	3	1.531	2.035	1.505	0.250 x 0.125 x 1.125	0.37	0.187
0.625	6	1.531	2.035	1.505	0.250 x 0.125 x 1.125	0.37	0.187
1.000	3	1.906	2.598	2.068	0.250 x 0.125 x 1.625	0.92	0.187
1.000	6	1.906	2.598	2.068	0.250 x 0.125 x 1.625	0.92	0.187
1.500	3	2.693	3.719	3.005	0.250 x 0.125 x 2.000	3.33	0.250
1.500	6	2.693	3.719	3.005	0.375 x 0.187 x 2.000	3.33	0.250
2.000	3	3.427	4.022	3.130	0.250 x 0.125 x 2.500	5.42	0.312
2.000	6	3.427	4.022	3.130	0.500 x 0.219 x 2.500	5.42	0.312
2.500	3	4.170	4.426	3.380	0.250 x 0.125 x 3.000	7.50	0.375
2.500	6	4.170	4.426	3.380	0.500 x 0.250 x 3.000	7.50	0.375
4.062	6	5.6245	5.495	4.500	1.000 x 0.500 x 3.500	14.50	0.375
6.000	8	8.625	7.495	5.995	1.000 x 0.500 x 5.500	51.52	0.500

**NOTES:**





# Bearing Supports/End Machining



## Table of Contents

<b>Description</b>	<b>Page</b>
Product Overview .....	138
Quick Install Assemblies .....	141
BK/BF Supports .....	148
FK/FF Supports .....	154
MK Supports .....	160
WK Supports .....	162
QK/QF Supports .....	166

Need a quote or have a question about an application? Contact us in North America at:

Phone: 540-633-3549

Fax: 540-639-4162

Email: [thomson@thomsonlinear.com](mailto:thomson@thomsonlinear.com)

## Bearing Supports/End Machining Product Overview

**Thomson Bearing Supports — complete package for simple mounting of Thomson ball screw and ball spline assemblies. Flange and Base mounts available with dual angular contact bearings or floating radial bearing.**

- Rugged steel construction
- Low profile, compact design
- Base or Flange mounting configurations
- Pre-assembled and ready for installation
- Available off-the-shelf

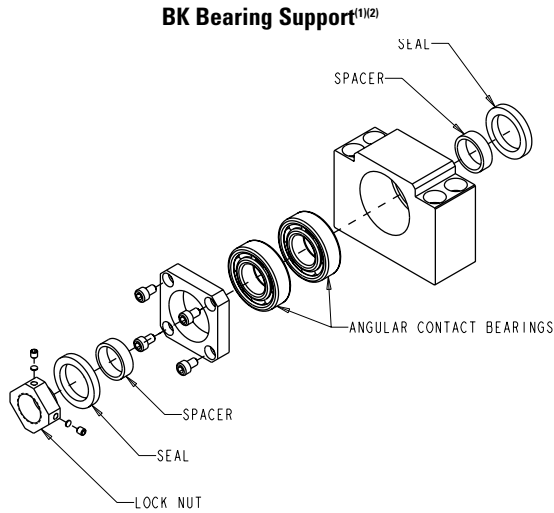

The base mounted BK Bearing Support contains an angular contact bearing pair for increased stiffness and axial load capacity. Design dimensions fit standard Type BK or BK1 end machining.

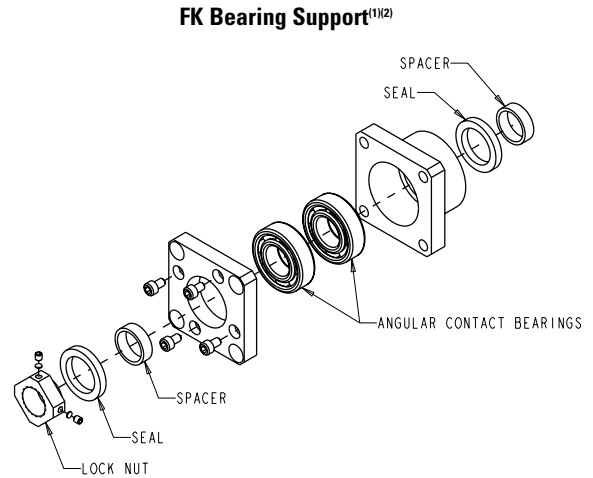

The flange mounted FK Bearing Support contains an angular contact bearing pair for increased stiffness and axial load capacity. Design dimensions fit standard Type FK or FK1 end machining.

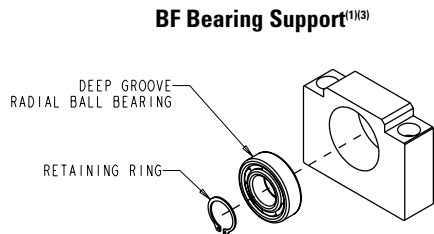

Base mounted BF Bearing Support contains a floating radial bearing to allow axial shaft movement. Design dimensions fit standard Type BF or BF1 end machining.

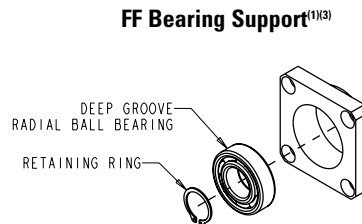

The flange mounted FF Bearing Support contains a floating radial bearing to allow axial shaft movement. Design dimensions fit standard Type FF or FF1 end machining.

(1) BK and FK supports are classified as “fixed” and BF and FF supports are classified as “simple” for purposes of critical speed and column strength calculations.

(2) Locknut included in assembly

(3) Retaining ring included in assembly

## Bearing Supports/End Machining Product Overview

**Thomson Bearing Supports** — a unitized package for simple mounting of Thomson ball screw and ball spline assemblies. Both “Floating” and “Fixed” style bearing supports are available.

- Rugged steel construction
- Low profile, compact design
- Foot or face mounting
- Pre-assembled and ready for installation
- Available off-the-shelf for quick building convenience

### QF Bearing Support<sup>(1)(2)</sup>

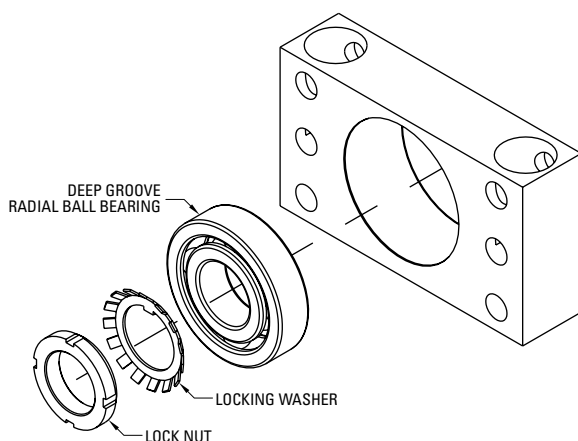

The QF Bearing Support provides a single deep groove radial ball bearing. Design dimensions fit standard Type QF or QF1 end machining.

### QK Bearing Support<sup>(1)(2)</sup>

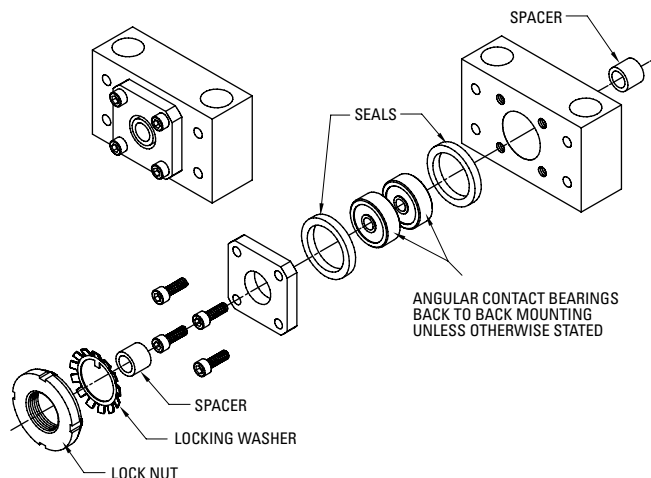

The QK Bearing Support contains high angular contact bearings arranged in a back-to-back (DB) configuration for high stiffness. Design dimensions fit standard Type QK or QK1 end machining.

### MK Bearing Support<sup>(3)</sup>

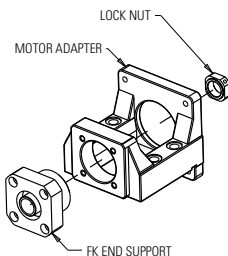

Base mounted NEMA 23 or 34 motor mount. Design dimensions fit standard Type FK end machining.

### WK Bearing Support<sup>(3)</sup>

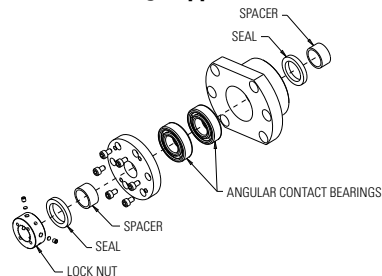

Heavy duty flange mounted WK support contains higher load capacity bearings. Design dimensions fit standard WK or WK1 end machining.

(1) QK, MK, and WK supports are classified as “fixed” and QF supports are classified as “simple” for purposes of critical speed and column strength calculations.

(2) Installation accessories (locknut and washer) included for complete assembly.

(3) Locknut included in assembly

## Bearing Supports Overview

Inch Series Ball Screws								
Dia. x Lead	BK	BF	FK	FF	QK	QF	MK	WK
0.500	7833360	7833368	7833377	7833384	7828282	7833291	7833685	-
0.631	7833361	7833369	7833378	7833385	7824154	7833256	7833686	-
0.750	7833362	7833370	7833379	7833386	7824155	7833259	7833687	-
0.875	7833363	7833371	7833380	7833387	7824156	7833262	-	7833595
1.000	7833364	7833372	7833381	7833388	7824157	7833265	7833690	7833596
1.171	7833364	7833372	7833381	7833388	7824157	7833265	7833690	7833596
1.150	7833365	7833373	7833382	7833389	7824158	7833268	-	7833597
1.250	7833365	7833373	7833382	7833389	7824158	7833268	-	7833597
1.500 x 0.473 & 1.000	7833365	7833373	7833382	7833389	7824158	7833268	-	7833597
1.500	7833366	7833374	7833383	7833390	7824159	7833270	-	7833599
1.750	7833367	7833375	-	-	7829554	7833273	-	7833602
2.000	7833367	7833375	-	-	7824160	7833276	-	-
2.250					7824160	7833276	-	-
2.500	-	-	-	-	7824161	7833279	-	-

Metric Ball Screws								
Dia. x Lead	BK	BF	FK	FF	QK	QF	MK	WK
12	7833391	7833398	7833405	7833411	7829546	7833292	7833700	-
16	7833392	7833399	7833406	7833412	7829547	7833282	7833701	-
20	7833393	7833400	7833407	7833413	7829548	7833283	7833702	-
25	7833394	7833401	7833408	7833414	7829549	7833284	7833703	7833614
32	7833395	7833402	7833409	7833415	7829550	7833285	-	7833615
40	7833396	7833403	7833410	7833416	7829551	7833286	-	7833617
50	7833397	7833404	-	-	7829552	7833287	-	7833621
63	-	-	-	-	7829553	7833288	-	-

Ball Splines								
Nominal Size	BK	BF	FK	FF	QK	QF	MK	WK
0.625	7833360	7833368	7833377	7833384	7828282	7833291	7833685	-
1.000	7833364	7833372	7833381	7833388	7824157	7833265	7833690	7833596
1.500	7833365	7833373	7833382	7833389	7824159	7833270	-	7833597
2.000	7833367	7833375	-	-	7829554	7833273	-	7833602
2.500	-	-	-	-	7824161	7833279	-	-

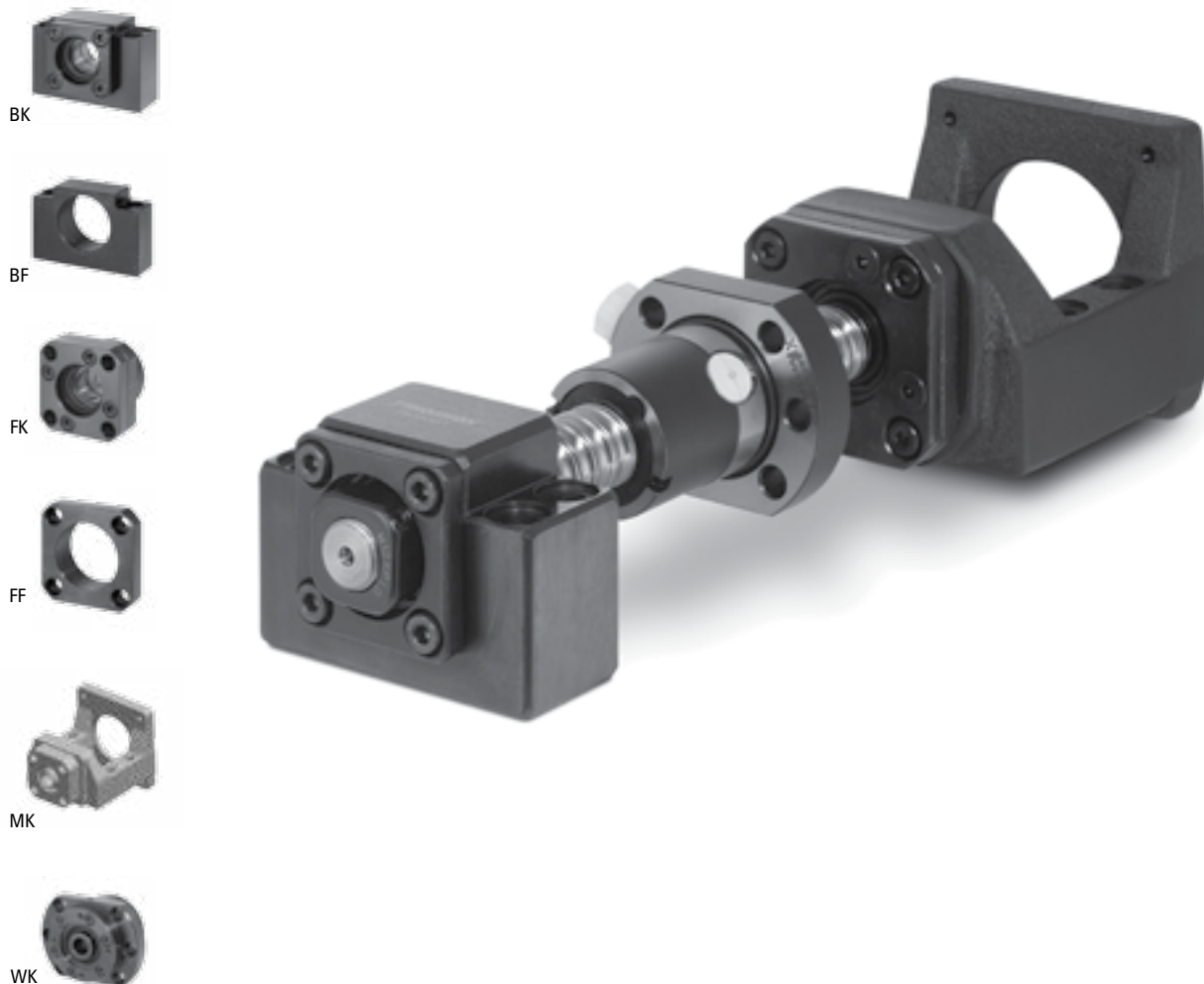

## Quick-Install Engineered Ball Screw Assemblies

### Get the 'just-right' fit

- Step by step selection assistance based on application parameters
- New configurations available
  - MK Supports - NEMA motor supports (Size 23 and 34)
  - WK Supports - Heavy duty supports for demanding applications

### Speed and simplify installation

- Pre-engineered assemblies to meet your system requirements
- Integrated ball screw and supports with motor ready mounting option

### Drop in replacements, fast delivery

- Popular ball screw assemblies and accessories available fast for replacement installations
- Additional configurations and sizes available upon request
- Industry-leading delivery times on all ball screw assemblies

## How to Select an Inch Series Ball Screw Assembly

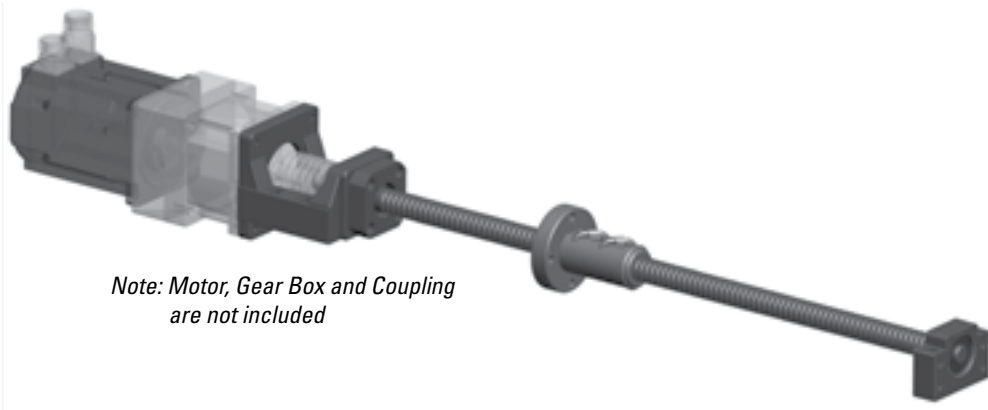

Note: Motor, Gear Box and Coupling are not included

### Step 1 - Select ball screw diameter based on load capacity and mounting configuration

- Table below indicates maximum axial load that selected ball nut diameter and end configuration can support
- Select a ball screw diameter / end support configuration with a load capacity exceeding application requirement

**Table 1 - End Support Axial Load Capacity**

Ball Screw Dia.	BK - BK	BK - BF	FK - FK	FK - FF	MK - BK	MK - BF	WK - WK
0.500 in	600 lb	300 lb	600 lb	300 lb	600 lb	300 lb	-
0.631 in	675 lb	338 lb	675 lb	338 lb	675 lb	338 lb	-
0.750 in	775 lb	388 lb	775 lb	388 lb	775 lb	388 lb	-
0.875 in	1,350 lb	675 lb	1,350 lb	675 lb	-	-	11,950 lb
1.000 in	1,475 lb	738 lb	1,875 lb	938 lb	1,675 lb	938 lb	11,950 lb
1.150 in	2,325 lb	1,163 lb	2,325 lb	1,163 lb	-	-	18,300 lb
1.500 in	3,325 lb	1,663 lb	3,325 lb	1,663 lb	-	-	19,400 lb
2.000 in	6,650 lb	3,325 lb	-	-	-	-	23,370 lb

### Step 2 - Select lead

- Select preload if zero lash is required
- Select lead based on required speed
- Linear speed (in/min) = (RPM) x (Lead)

### Step 3 - Verify life requirement of ball nut and end support

- Calculate life of ball screw assembly using  $L_{10} = (C_{am} / \text{Load})^3$  million inches
  - Calculate life of end supports using  $L_{10} = (C_{am} / \text{Load per support})^3$  million revolutions
- i.e. : Divide load by 2 if using 2 BK-BK, FK-FK, MK-BK, or WK-WK.*

**Table 2 - Ball Nut Part Number**

Dia. x Lead	Standard Nut Part Number	Preload Nut Part Number	Maximum Screw Length (in)
.500 x .200	8105-448-013	8105-448-008	72.000
.500 x .500	8105-448-014	-	72.000
.631 x .200	8106-448-022	8106-448-012	144.000
.631 x 1.000	7826713	7827531	96.000
.750 x .200	8107-448-018	8107-448-025	144.000
.750 x .500	8107-448-014	8107-448-011	144.000
.875 x .200	5708277	-	144.000
1.000 x .250	8110-448-055	7824167	288 / 240
1.000 x .500	8110-448-022	8110-448-016	288.000
1.000 x 1.000	8110-448-086	-	288.000
1.150 x .200	8111-448-006	8111-448-004	288.000
1.500 x .250	7833233	7833234	240.000
1.500 x .473	5707513	-	240.000
1.500 x .500	8115-448-016	8115-448-006	288.000
1.500 x 1.000	5708280	5700698	240.000
1.500 x 1.875	5707654	5704272	240.000
1.500 x 2.000	8115-448-056	-	288.000
2.000 x .500	8120-448-011	8120-448-006	288.000
2.000 x 1.000	8120-448-021	8120-448-019	288.000

**Table 3 - Component Dynamic Capacity**

Dia. x Lead	Standard Nut $C_{am}$ (lb)	Preload Nut $C_{am}$ (lb)	BK Support $C_{am}$ (lb)	FK / MK Support $C_{am}$ (lb)	WK Support $C_{am}$ (lb)
.500 x .200	1,200	1,200	430	430	-
.500 x .500	929	-	430	430	-
.631 x .200	800	800	478	478	-
.631 x 1.000	578	578	478	478	-
.750 x .200	950	950	529	529	-
.750 x .500	3,450	3,450	529	529	-
.875 x .200	1,942	-	910	910	5,980
1.000 x .250	1,612	1,612	1,656	2,270	5,980
1.000 x .500	3,950	3,950	1,656	2,270	5,980
1.000 x 1.000	2,400	-	1,656	2,270	5,980
1.150 x .200	2,400	2,400	2,742	2,742	9,105
1.500 x .250	4,198	4,198	3,632	3,632	9,667
1.500 x .473	10,050	-	3,632	3,632	9,667
1.500 x .500	14,513	14,513	3,632	3,632	9,667
1.500 x 1.000	8,250	8,250	3,632	3,632	9,667
1.500 x 1.875	7,242	7,242	3,632	3,632	9,667
1.500 x 2.000	7,600	-	3,632	3,632	9,667
2.000 x .500	18,500	18,500	7,093	-	11,691
2.000 x 1.000	21,200	21,200	7,093	-	11,691

**Step 4 - Verify screw meets critical speed limitation**

- Acceptable length / speed combinations are below and left of the selected curve (screw diameter)

**Figure 1 - Critical Speed Graph**

**Speed vs Length (Inch Series)  
BK-BF, FK-FF, MK-BF**

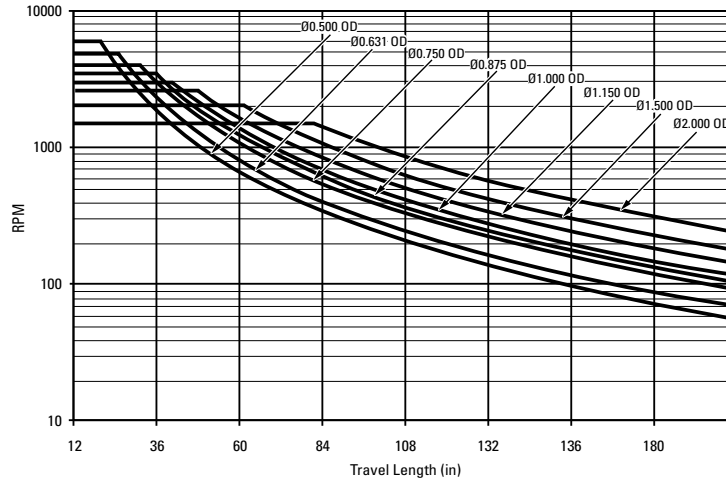

**Speed vs Length (Inch Series)  
BK-BK, FK-FK, MK-BK, WK-WK**

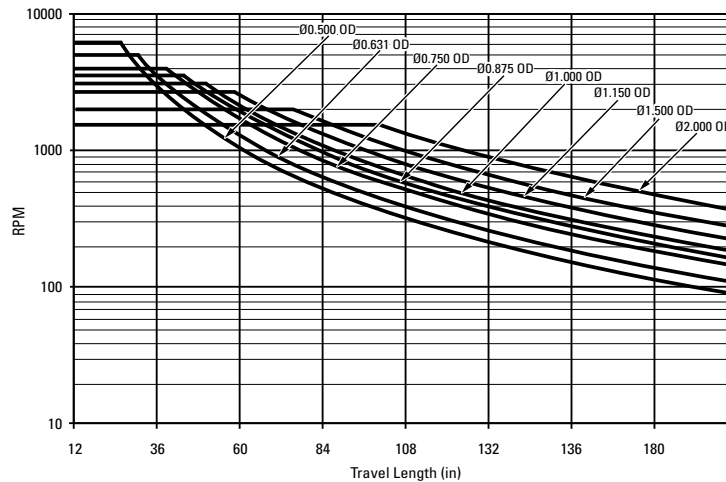

**Step 5 - Build Quick-Install Engineered Ball Screw Part Number - Inch Series Example**

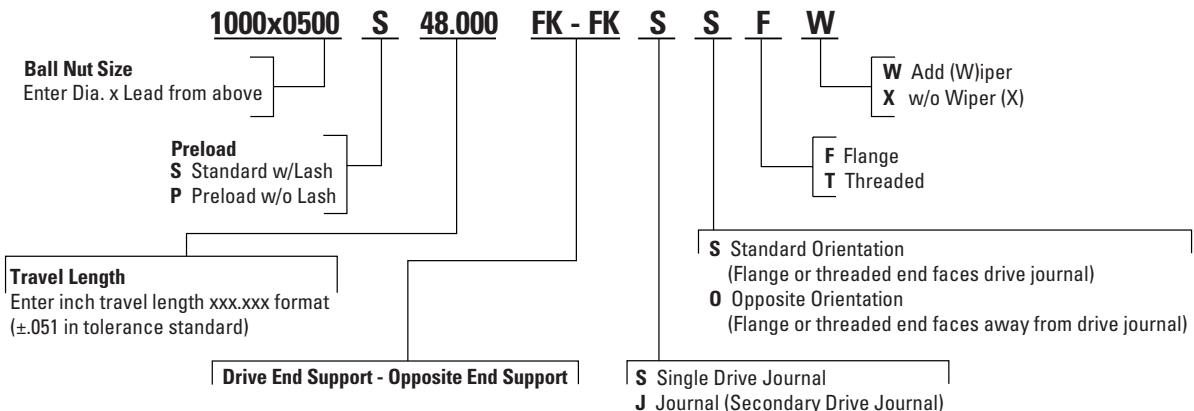

**Step 6 - Contact Thomson Customer Support (Call 540-633-3549) or thomson@thomsonlinear.com or your local Thomson Distributor to order**



## How to Select an Metric Series Ball Screw Assembly

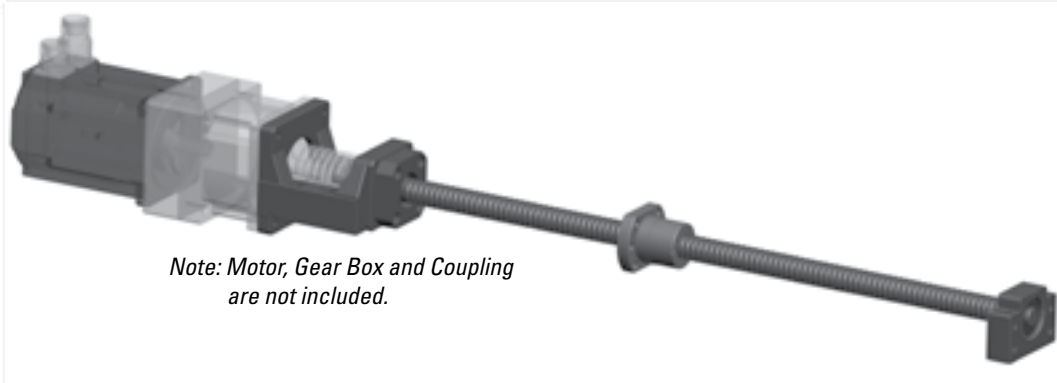

Note: Motor, Gear Box and Coupling are not included.

### Step 1 - Select system based on load capacity and mounting configuration

- Table below indicates maximum axial load that selected ball nut diameter and end configuration can support
- Select a ball screw diameter / end support configuration with a load capacity exceeding application requirement

**Table 1 - End Support Axial Load Capacity**

Ball Screw Dia.	BK - BK	BK - BF	FK - FK	FK - FF	MK - BK	MK - BF	WK - WK
12mm	2,600 N	1,300 N	2,600 N	1,300 N	2,600 N	1,300 N	-
16mm	3,000 N	1,500 N	3,000 N	1,500 N	3,000 N	1,500 N	-
20mm	3,450 N	1,725 N	3,450 N	1,725 N	3,450 N	1,725 N	-
25mm	6,575 N	3,288 N	8,300 N	4,150 N	7,438 N	4,150 N	26,600 N
32mm	10,300 N	5,150 N	10,300 N	5,150 N	-	-	26,600 N
40mm	14,800 N	7,400 N	14,800 N	7,400 N	-	-	40,500 N
50mm	29,500 N	14,750 N	-	-	-	-	52,000 N

### Step 2 - Select lead

- Select preload if zero lash is required
- Select lead based on required speed
- Linear speed (in/min) = (RPM) x (Lead)

**Table 2 - Ball Nut Part Number**

Flanged Nut	Cylindrical Nut	Threaded Nut	Maximum Screw Length (mm)
12 x 5	-	-	1,500
16 x 5	KGF-D-1605-RH-EE	KGM-D-1605-RH-EE	7832778
16 x 10	KGF-D-1610-RH-EE	KGM-D-1610-RH-EE	-
20 x 5	KGF-D-2005-RH-EE	KGM-D-2005-RH-EE	7832781
25 x 5	KGF-D-2505-RH-EE	KGM-D-2505-RH-EE	7832788
25 x 10	KGF-D-2510-RH-EE	KGM-D-2510-RH-EE	7832792
25 x 20	KGF-D-2520-RH-EE	KGM-D-2520-RH-EE	-
25 x 25	KGF-D-2525-RH-EE	KGM-D-2525-RH-EE	-
25 x 50	KGF-D-2550-RH-EE	KGM-D-2550-RH-EE	-
32 x 5	KGF-D-3205-RH-EE	KGM-D-3205-RH-EE	7832797
32 x 10	KGF-D-3210-RH-EE	KGM-N-3210-RH-EE	-
32 x 20	KGF-D-3220-RH-EE	KGM-N-3220-RH-EE	-
32 x 32	KGF-D-3232-RH-EE	-	-
32 X 40	KGF-N-3240-RH-EE	KGM-N-3240-RH-EE	-
40 x 5	KGF-D-4005-RH-EE	KGM-D-4005-RH-EE	7832806
40 x 10	KGF-D-4010-RH-EE	KGM-D-4010-RH-EE	7832810
40 x 20	KGF-D-4020-RH-EE	KGM-D-4020-RH-EE	-
40 x 40	KGF-D-4040-RH-EE	KGM-D-4040-RH-EE	-
50 x 10	KGF-D-5010-RH-EE	KGM-N-5010-RH-EE	7832819
50 x 20	KGF-D-5020-RH-EE	KGM-N-5020-RH-EE	-

### Step 3 - Verify life requirement of ball nut and end support

- Calculate life of ball screw assembly using  $L_{10} = (C_{am} / \text{Load})^3$  million revolutions
- Calculate life of end supports using  $L_{10} = (C_{am} / \text{Load per support})^3$  million revolutions  
*i.e. : Divide load by 2 if using 2 BK-BK, FK-FK, MK-BK, or WK-WK.*

**Table 3 - Component Dynamic Capacity**

Flanged Nut	Cylindrical Nut	Threaded Nut	BK Support	FK / MK Support	WK Support
12 x 5	-	-	1.9	1.9	-
16 x 5	9.3	9.3	2.1	2.1	-
16 x 10	15.4	15.4	2.1	2.1	-
20 x 5	10.5	10.5	2.4	2.4	-
25 x 5	12.3	12.3	4.2	10.2	26.6
25 x 10	13.2	13.2	4.2	10.2	26.6
25 x 20	13.0	13.0	4.2	10.2	26.6
25 x 25	16.7	16.7	4.2	10.2	26.6
25 x 50	15.4	15.4	4.2	10.2	26.6
32 x 5	21.5	21.5	7.0	12.3	40.5
32 x 10	33.4	33.4	7.0	12.3	40.5
32 x 20	29.7	29.7	7.0	12.3	40.5
32 x 32	18.0	-	7.0	12.3	40.5
32 X 40	14.9	14.9	7.0	12.3	40.5
40 x 5	23.8	23.8	9.2	16.1	43.0
40 x 10	38.0	38.0	78.6	9.2	16.1
40 x 20	33.3	33.3	-	9.2	16.1
40 x 40	35.0	35.0	-	9.2	16.1
50 x 10	68.7	68.7	97.8	18.0	-
50 x 20	60.0	60.0	-	18.0	-



**Step 4 - Verify screw meets critical speed limitation**

- Acceptable length / speed combinations are below and left of the selected curve (screw diameter)

**Figure 1 - Critical Speed Graph**

**Speed vs Length (Metric Series)  
BF-FF, MK-BF, FK-BK**

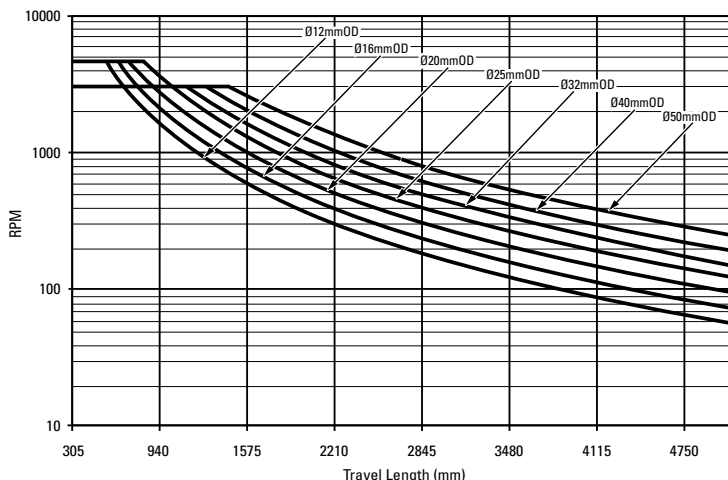

**Speed vs Length (Metric Series)  
BK-BK, FK-FK, MK-BK, WK-WK**

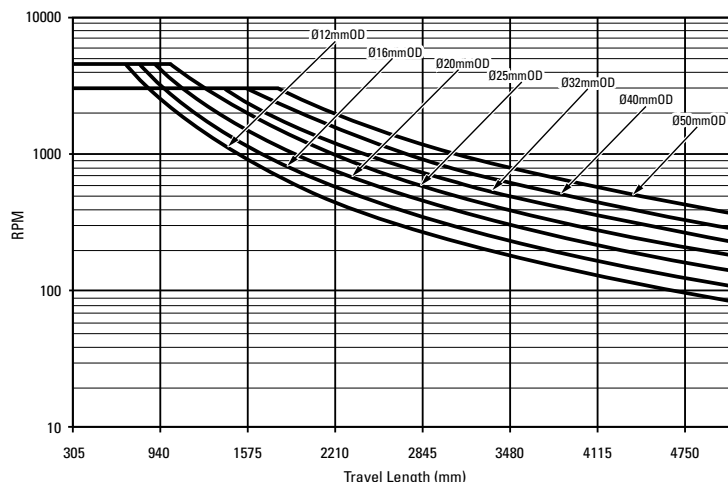

**Step 5 - Build Quick-Install Engineered Ball Screw Part Number - Metric Series Example**

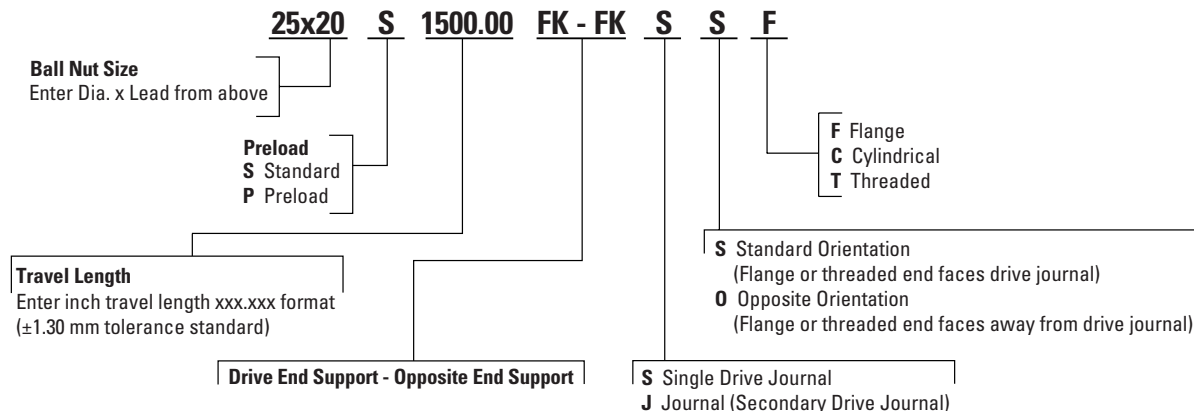









**Step 6 - Contact Thomson Customer Support (Call 540-633-3549) or thomson@thomsonlinear.com or your local Thomson Distributor to order**

## How to Install a Ball Screw Assembly

### Step 1 - Determine Extended Ball Nut Length







- Determine the overall length of the ball nut including accessories
- Extended Ball Nut Length = Ball Nut Length + Flange Adder + Wiper Adder

 Dia x Lead	 Standard Nut P/N	Standard Ball Nut Length (in)	 Preload Nut P/N	Preload Ball Nut Length (in)	 Flange Adder (in)	 Wiper Adder (in)
.500 x .200	8105-448-013	2.750	8105-448-008	5.950	0.150	0.287
.500 x .500	8105-448-014	1.750	-	-	0.150	0.287
.631 x .200	8106-448-022	1.710	8106-448-012	3.875	0.030	-
.631 x 1.000	7826713	1.710	7827531	3.440	0.030	0.287
.750 x .200	8107-448-018	1.880	8107-448-025	4.080	0.030	0.306
.750 x .500	8107-448-014	2.930	8107-448-011	6.180	0.030	0.306
.875 x .200	5708277	2.704	-	-	0.020	0.242
1.000 x .250	8110-448-055	2.347	5704167	4.847	0.030	- / 0.344
1.000 x .500	8110-448-022	3.120	8110-448-016	6.640	0.005	0.306
1.000 x 1.000	8110-448-086	3.000	-	-	0.030	-
1.150 x .200	8111-448-006	2.500	8111-448-004	5.500	0.015	0.306
1.500 x .250	7833233	2.875	7833234	6.375	0.020	0.287
1.500 x .473	5707513	4.312	-	-	0.020	0.287
1.500 x .500	8115-448-016	5.565	8115-448-006	12.100	0.030	-
1.500 x 1.000	5708280	3.628	5700698	7.628	0.020	0.328
1.500 x 1.875	5707654	5.000	5704272	10.625	0.020	0.328
1.500 x 2.000	8115-448-056	5.250	-	-	0.020	-
2.000 x .500	8120-448-011	6.380	8120-448-006	13.920	0.031	-
2.000 x 1.000	8120-448-021	6.380	8120-448-019	13.900	0.031	-

 Dia x Lead	 Flanged Nut P/N	Ball Nut Length (in)	 Cylindrical Nut P/N	Ball Nut Length (in)	 Threaded Nut P/N	Ball Nut Length (in)
12 x 5	-	-	KGM-N-1205-RH-00	0.945	-	-
16 x 5	KGF-D-1605-RH-EE	1.654	KGM-D-1605-RH-EE	1.339	7832778	2.264
16 x 10	KGF-D-1610-RH-EE	2.165	KGM-D-1610-RH-EE	1.969	-	-
20 x 5	KGF-D-2005-RH-EE	1.654	KGM-D-2005-RH-EE	1.339	7832781	2.264
25 x 5	KGF-D-2505-RH-EE	1.654	KGM-D-2505-RH-EE	1.339	7832788	2.500
25 x 10	KGF-D-2510-RH-EE	2.165	KGM-D-2510-RH-EE	1.772	7832792	2.402
25 x 20	KGF-D-2520-RH-EE	1.378	KGM-D-2520-RH-EE	1.378	-	-
25 x 25	KGF-D-2525-RH-EE	1.378	KGM-D-2525-RH-EE	1.378	-	-
25 x 50	KGF-D-2550-RH-EE	2.283	KGM-D-2550-RH-EE	2.283	-	-
32 x 5	KGF-D-3205-RH-EE	2.165	KGM-D-3205-RH-EE	1.772	7832797	2.579
32 x 10	KGF-D-3210-RH-EE	2.717	KGM-N-3210-RH-EE	2.362	-	-
32 x 20	KGF-D-3220-RH-EE	3.150	KGM-N-3220-RH-EE	2.756	-	-
32 x 32	KGF-D-3232-RH-EE	1.654	-	-	-	-
32 X 40	KGF-N-3240-RH-EE	1.772	KGM-N-3240-RH-EE	1.772	-	-
40 x 5	KGF-D-4005-RH-EE	2.244	KGM-D-4005-RH-EE	1.772	7832806	2.657
40 x 10	KGF-D-4010-RH-EE	2.795	KGM-D-4010-RH-EE	2.362	7832810	4.154
40 x 20	KGF-D-4020-RH-EE	3.150	KGM-D-4020-RH-EE	2.756	-	-
40 x 40	KGF-D-4040-RH-EE	3.346	KGM-D-4040-RH-EE	3.346	-	-
50 x 10	KGF-D-5010-RH-EE	3.740	KGM-N-5010-RH-EE	3.228	7832819	4.646
50 x 20	KGF-D-5020-RH-EE	3.740	KGM-N-5020-RH-EE	3.228	-	-

### Step 2 - Determine Screw Length

- Determine overall length of ball screw (OAL)
- OAL = Travel + Extended Ball Nut Length + End Support Configuration (Table Below)

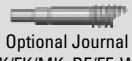
Ball Nut Dia	 BK - BK	 BK - BF	 FK - FK	 FK - FF	 MK - BK	 MK - BF	 WK - WK	 Optional Journal BK/FK/MK, BF/FF, WK
0.500 in / 12mm	3.425	2.658	3.425	2.500	3.425	2.658	-	0.591 / 0.591 / -
0.631 in / 16mm	3.425	2.677	3.425	2.579	3.425	2.677	-	0.591 / 0.591 / -
0.750 in / 20mm	3.937	3.091	4.488	3.307	4.213	3.367	-	0.787 / 0.787 / -
0.875 in	5.079	3.839	5.472	3.976	-	-	7.717	0.905 / 0.905 / 1.339
1.000 in / 25mm	5.158	3.977	5.866	4.291	5.512	4.331	7.717	0.984 / 0.866 / 1.339
1.150 in / 32mm	6.299	4.822	7.165	5.137	6.732	5.255	8.543	1.181 / 1.181 / 1.535
1.500 x .473 & 1.000 in	6.299	4.822	7.165	5.137	6.732	5.255	8.543	1.181 / 1.181 / 1.535
1.500 x .200, .250, .500 in	7.166	5.473	7.166	5.375	7.166	5.473	8.819	1.496 / 1.496 / 1.811
1.500 x 1.875 & 2.000 in / 40mm	7.166	5.473	7.166	5.375	7.166	5.473	8.819	1.496 / 1.496 / 1.811
2.000 in / 50mm	9.291	6.910	-	-	-	-	9.409	1.969 / 1.969 / 2.165

**Step 3 - Determine Mounting Pattern**

- Table below indicates mounting interface ("A" = Travel Length + Nut Length)

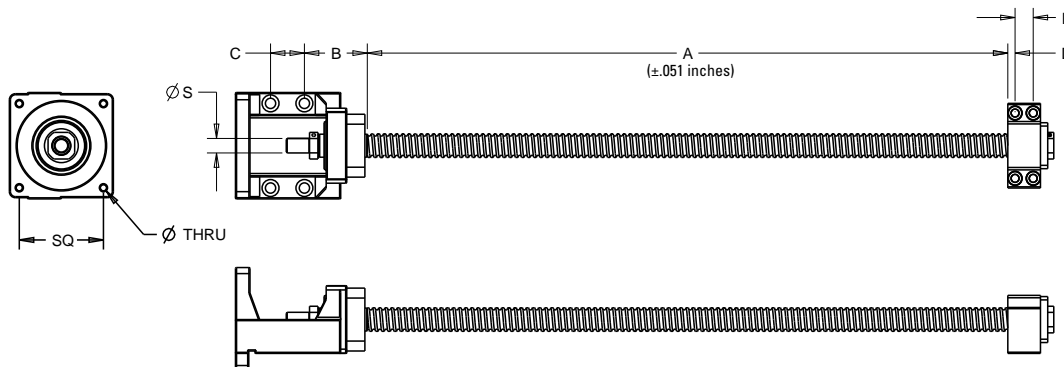

Ball Nut Dia	BK - BK	BK - BF	MK - BK	MK - BF	Motor Interface	Mounting Pattern "SQ" (in)	"THRU" Hole "S" (in)	Drive Shaft "S" (in)
	B/C/D/E (±.005 in)	B/C/D/E (±.005 in)	B/C/D/E (±.005 in)	B/C/D/E (±.005 in)				
0.500 in / 12mm	.256 / .512 / .256 / .512	.256 / .512 / .394 / -	1.339 / .787 / .256 / .512	1.339 / .787 / .394 / -	NEMA 23	1.856	M4 x .7	.3150 / .3144
0.631 in / 16mm	.256 / .512 / .256 / .512	.256 / .512 / .394 / -	1.339 / .787 / .256 / .512	1.339 / .787 / .394 / -	NEMA 23	1.856	M4 x .7	.3937 / .3931
0.750 in 20mm	.236 / .591 / .236 / .591	.236 / .591 / .394 / -	1.536 / 1.102 / .236 / .591	1.536 / 1.102 / .394 / -	NEMA 23	1.856	M4 x .7	.4724 / .4717
0.875 in	.315 / .748 / .315 / .748	.315 / .748 / .453 / -	-	-	-	-	-	.5906 / .5898
1.000 in / 25mm	.315 / .748 / .315 / .748	.315 / .748 / .512 / -	2.008 / 1.654 / .315 / .748	2.008 / 1.654 / .512 / -	NEMA 34	2.740	M6 x 1.0	.6693 / .6686
1.150 in / 32mm	.394 / .866 / .394 / .866	.394 / .866 / .591 / -	-	-	-	-	-	.7874 / .7866
1.500 x .473 & 1.000 in	.394 / .866 / .394 / .866	.394 / .866 / .591 / -	-	-	-	-	-	.7874 / .7866
1.500 x .200, .250, .500 in	.433 / .906 / .433 / .906	.433 / .906 / .630 / -	-	-	-	-	-	.9843 / .9834
1.500 x 1.875 & 2.000 in / 40mm	.433 / .906 / .433 / .906	.433 / .906 / .630 / -	-	-	-	-	-	.9843 / .9834
2.000 in / 50mm	.551 / 1.299 / .551 / 1.299	.551 / 1.299 / .728 / -	-	-	-	-	-	1.3780 / 1.3771

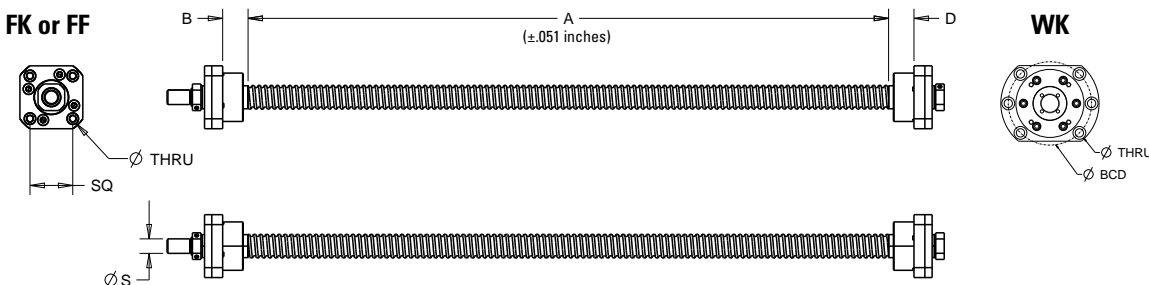

Ball Nut Dia	FK - FK	FK - FF	FK / FF		WK - WK		"THRU" Hole (in) Clearance & C'bore for given screw	Drive Shaft "S" (in)
	B/D (±.005 in)	B/D (±.005 in)	Mounting Pattern "SQ" (in)	"THRU" Hole Clearance & C'bore for given screw	B/D (±.005 in)	Mounting Pattern "BCD" (in)		
0.500 in / 12mm	0.689 / .689	.669 / .196	1.170 / 0.974	M4 / M3	-	-	-	.3150 / .3144
0.631 in / 16mm	0.689 / .689	.669 / .315	1.225 / 1.170	M4 / M4	-	-	-	.3937 / .3931
0.750 in 20mm	0.827 / .827	.827 / .315	1.392 / 1.392	M5 / M5	-	-	-	.4724 / .4717
0.875 in	0.945 / .945	.945 / .354	1.726 / 1.726	M6 / M6	1.260 / 1.260	3.465	M8	.5906 / .5898
1.000 in / 25mm	1.220 / 1.220	1.220 / .354	1.949 / 1.949	M6 / M6	1.260 / 1.260	3.465	M8	.6693 / .6686
1.150 in / 32mm	1.378 / 1.378	1.378 / .394	2.228 / 2.228	M8 / M8	1.300 / 1.300	4.331	M10	.7874 / .7866
1.500 x .473 & 1.000 in	1.378 / 1.378	1.378 / .394	2.228 / 2.228	M8 / M8	1.300 / 1.300	4.331	M10	.7874 / .7866
1.500 x .200, .250, .500 in	1.142 / 1.142	1.142 / .354	2.645 / 2.645	M10 / M10	1.300 / 1.300	4.331	M10	.9843 / .9834
1.500 x 1.875 & 2.000 in / 40mm	1.142 / 1.142	1.142 / .354	2.645 / 2.645	M10 / M10	1.300 / 1.300	4.331	M10	.9843 / .9834
2.000 in / 50mm	-	-	-	-	1.300 / 1.300	4.764	M10	1.3780 / 1.3771

## Bearing Supports/End Machining — Ball Screws

BK

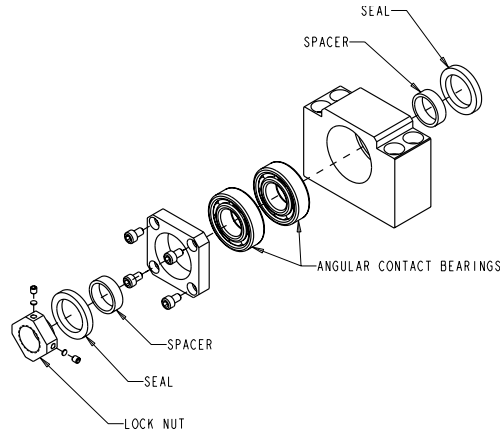

### Bearing Supports / End Machining - Inch Series Ball Screw

BK Bearing Supports

Standard P/N	Dia. X Lead (inch)	Bearing Rating				Lock Nut Type	Block Weight (lbs)
		Static Rating $C_0$		Dynamic Rating $C_{am}$			
		(lbs)	(N)	(lbs)	(N)		
7833360	0.5	1168	5195	430	1913	RN10	0.9
7833361	0.631	1345	5983	478	2126	RN12	1.0
7833362	0.75	1543	6863	529	2353	RN15	1.3
7833363	0.875	2690	11965	910	4048	RN17	2.9
7833364	1.000 / 1.171	3726	16573	944	4199	RN20	2.8
7833365	1.150 / 1.250	4608	20496	1563	6952	RN25	5.3
7833366	1.500 x 0.473 & 1.000 1.500 x 0.200 & 0.250 1.500 x 0.500 & 1.875 1.500 x 2.000	6614	29419	2070	9207	RN30	7.5
7833367	1.750 / 2.000	10362	46090	4043	17983	RN40	15.0

### Bearing Supports / End Machining - Metric Series Ball Screw

BK Bearing Supports

Standard P/N	Dia. X Lead (mm)	Bearing Rating				Lock Nut Type	Block Weight (kg)
		Static Rating $C_0$		Dynamic Rating $C_{am}$			
		(lbs)	(N)	(lbs)	(N)		
7833391	12	1168	5195	430	1913	RN10	0.4
7833392	16	1345	5983	478	2126	RN12	0.5
7833393	20	1543	6863	529	2353	RN15	0.6
7833394	25	3726	16573	944	4199	RN20	1.3
7833395	32	4608	20496	1563	6952	RN25	2.4
7833396	40	6614	29419	2070	9207	RN30	3.4
7833397	50	10362	46090	4043	17983	RN40	6.8

### Bearing Supports / End Machining - Ball Splines

BK Bearing Supports

Standard P/N	Spline Size (inch)	Bearing Rating				Lock Nut Type	Block Weight (lbs)
		Static Rating $C_0$		Dynamic Rating $C_{am}$			
		(lbs)	(N)	(lbs)	(N)		
7833360	0.625	1168	5195	430	1913	RN10	0.9
7833364	1.000	3726	16573	944	4199	RN20	2.8
7833365	1.500	4608	20496	1563	6952	RN25	5.3
7833367	2.000	10362	46090	4043	17983	RN40	15.0

## Bearing Supports/End Machining — Ball Screws

BK

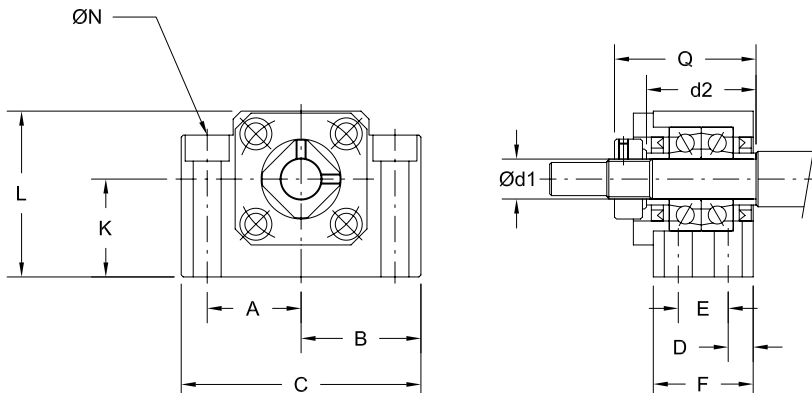

### Bearing Supports / End Machining - Inch Series Ball Screw

BK Bearing Supports

Standard P/N	Bearing Block Dimensions (inch)											
	d1 (mm)	d2	A	B	C	D	E	F	K ±0.001	L	N	Q
7833360	10	1.063	0.906	1.181	2.362	0.236	0.512	0.984	0.866	1.535	4x .260 Thru, .425 C-Bore x .197 Dp	1.339
7833361	12	1.063	0.906	1.181	2.362	0.236	0.512	0.984	0.984	1.693	4x .260 Thru, .425 C-Bore x .059 Dp	1.339
7833362	15	1.181	1.063	1.378	2.756	0.236	0.591	1.063	1.102	1.890	4x .260 Thru, .433 C-Bore x .256 Dp	1.496
7833363	17	1.496	1.339	1.693	3.386	0.315	0.748	1.378	1.535	2.520	4x .354 Thru, .551 C-Bore x .335 Dp	2.008
7833364	20	1.575	1.378	1.732	3.465	0.315	0.748	1.378	1.339	2.362	4x .354 Thru, .551 C-Bore x .335 Dp	2.008
7833365	25	1.890	1.673	2.087	4.173	0.394	0.866	1.654	1.890	3.150	4x .433 Thru, .699 C-Bore x .433 Dp	2.480
7833366	30	1.969	2.008	2.520	5.039	0.433	0.906	1.772	2.008	3.504	4x .551 Thru, .787 C-Bore x .512 Dp	2.756
7833367	40	2.598	2.559	3.150	6.299	0.551	1.299	2.402	2.362	4.331	4x .709 Thru, 1.024 C-Bore x .689 Dp	3.583

### Bearing Supports / End Machining - Metric Series Ball Screw

BK Bearing Supports

Standard P/N	Bearing Block Dimensions (mm)											
	d1 (mm)	d2	A	B	C	D	E	F	K ±0.02	L	N	Q
7833391	10	27.0	23.0	30.0	60.0	6.0	13.0	25.0	22.00	39.0	4x 6.6 Thru, 10.8 C-Bore x 5.0 Dp	34.0
7833392	12	27.0	23.0	30.0	60.0	6.0	13.0	25.0	25.00	43.0	4x 6.6 Thru, 10.8 C-Bore x 1.5 Dp	34.0
7833393	15	30.0	27.0	35.0	70.0	6.0	15.0	27.0	28.00	48.0	4x 6.6 Thru, 11.0 C-Bore x 6.5 Dp	38.0
7833394	20	40.0	35.0	44.0	88.0	8.0	19.0	35.0	34.00	60.0	4x 9.0 Thru, 14.0 C-Bore x 8.5 Dp	51.0
7833395	25	48.0	42.5	53.0	106.0	10.0	22.0	42.0	48.00	80.0	4x 11.0 Thru, 17.0 C-Bore x 11.0 Dp	63.0
7833396	30	50.0	51.0	64.0	128.0	11.0	23.0	45.0	51.00	89.0	4x 14.0 Thru, 20.0 C-Bore x 13.0 Dp	70.0
7833397	40	66.0	65.0	80.0	160.0	14.0	33.0	61.0	60.00	110.0	4x 18.0 Thru, 26.0 C-Bore x 17.5 Dp	91.0

### Bearing Supports / End Machining - Ball Splines

BK Bearing Supports

Standard P/N	Bearing Block Dimensions (inch)											
	d1 (mm)	d2	A	B	C	D	E	F	K ±0.001	L	N	Q
7833360	10	1.063	0.906	1.181	2.362	0.236	0.512	0.984	0.866	1.535	4x .260 Thru, .425 C-Bore x .197 Dp	1.339
7833364	20	1.575	1.378	1.732	3.465	0.315	0.748	1.378	1.339	2.362	4x .354 Thru, .551 C-Bore x .335 Dp	2.008
7833365	25	1.890	1.673	2.087	4.173	0.394	0.866	1.654	1.890	3.150	4x .433 Thru, .699 C-Bore x .433 Dp	2.480
7833367	40	2.598	2.559	3.150	6.299	0.551	1.299	2.402	2.362	4.331	4x .709 Thru, 1.024 C-Bore x .689 Dp	3.583

## Bearing Supports/End Machining — Ball Screws

BF

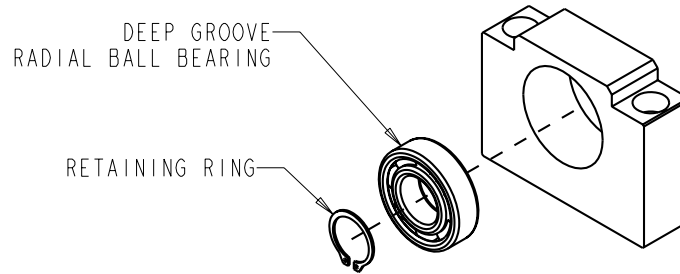

### Bearing Supports / End Machining - Inch Series Ball Screw

BF Bearing Supports

Standard P/N	Dia. X Lead (inch)	*Snap Ring (mm)	Block Weight (lbs)
7833368	0.5	8	0.7
7833369	0.631	10	0.8
7833370	0.75	15	0.9
7833371	0.875	17	1.7
7833372	1.000 / 1.171	20	1.7
7833373	1.150 / 1.250	25	3.2
	1.500 x 0.473 & 1.000		
7833374	1.500 x 0.200 & 0.250	30	4.3
	1.500 x 0.500 & 1.875		
	1.500 x 2.000		
7833375	1.750 / 2.000	40	7.3

### Bearing Supports / End Machining - Metric Series Ball Screw

BF Bearing Supports

Standard P/N	Dia. X Lead (mm)	*Snap Ring (mm)	Block Weight (kg)
7833398	12	8	0.3
7833399	16	10	0.4
7833400	20	15	0.4
7833401	25	20	0.8
7833402	32	25	1.5
7833403	40	30	2.0
7833404	50	40	3.3

### Bearing Supports / End Machining - Ball Splines

BF Bearing Supports

Standard P/N	Spline Size (inch)	*Snap Ring (mm)	Block Weight (lbs)
7833368	0.625	8	0.7
7833372	1.000	20	1.7
7833373	1.500	25	3.2
7833375	2.000	40	7.3

## Bearing Supports/End Machining — Ball Screws

BF

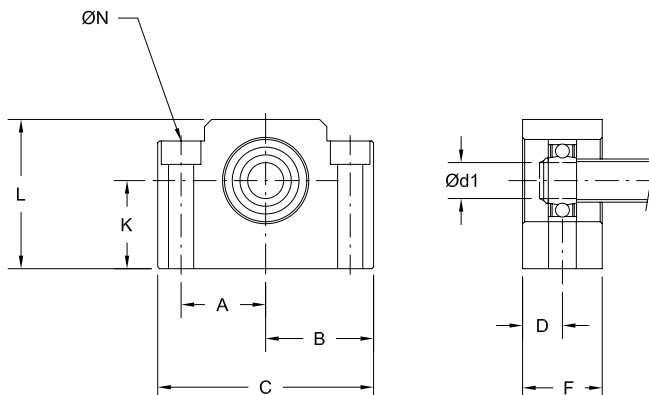

### Bearing Supports / End Machining - Inch Series Ball Screw

BF Bearing Supports

Standard P/N	Bearing Block Dimensions (inch)								
	d1 (mm)	A	B	C	D	F	K ±0.001	L	N
7833368	8	0.906	1.181	2.362	0.394	0.787	0.866	1.535	2x .260 Thru, .425 C-Bore x .197 Dp
7833369	10	0.906	1.181	2.362	0.394	0.787	0.984	1.693	2x .260 Thru, .425 C-Bore x .059 Dp
7833370	15	2.244	1.378	2.756	0.394	0.787	1.102	1.890	2x .260 Thru, .433 C-Bore x .256 Dp
7833371	17	1.339	1.693	3.386	0.453	0.906	1.535	2.520	2x .354 Thru, .551 C-Bore x .335 Dp
7833372	20	1.378	1.732	3.465	0.512	1.024	1.339	2.362	2x .354 Thru, .551 C-Bore x .335 Dp
7833373	25	1.673	2.087	4.173	0.591	1.181	1.890	3.150	2x .433 Thru, .699 C-Bore x .433 Dp
7833374	30	2.008	2.520	5.039	0.630	1.260	2.008	3.504	2x .551 Thru, .787 C-Bore x .512 Dp
7833375	40	2.559	3.150	6.299	0.728	1.457	2.362	4.331	2x .709 Thru, 1.024 C-Bore x .689 Dp

### Bearing Supports / End Machining - Metric Series Ball Screw

BF Bearing Supports

Standard P/N	Bearing Block Dimensions (mm)								
	d1 (mm)	A	B	C	D	F	K ±0.02	L	N
7833398	8	23.0	30.0	60.0	10.0	20.0	22.00	39.0	4x 6.6 Thru, 10.8 C-Bore x 5.0 Dp
7833399	10	23.0	30.0	60.0	10.0	20.0	25.00	43.0	4x 6.6 Thru, 10.8 C-Bore x 1.5 Dp
7833400	15	57.0	35.0	70.0	10.0	20.0	28.00	48.0	4x 6.6 Thru, 11.0 C-Bore x 6.5 Dp
7833401	20	35.0	44.0	88.0	13.0	26.0	34.00	60.0	4x 9.0 Thru, 14.0 C-Bore x 8.5 Dp
7833402	25	42.5	53.0	106.0	15.0	30.0	48.00	80.0	4x 11.0 Thru, 17.0 C-Bore x 11.0 Dp
7833403	30	51.0	64.0	128.0	16.0	32.0	51.00	89.0	4x 14.0 Thru, 20.0 C-Bore x 13.0 Dp
7833404	40	65.0	80.0	160.0	18.5	37.0	60.00	110.0	4x 18.0 Thru, 26.0 C-Bore x 17.5 Dp

### Bearing Supports / End Machining - Ball Splines

BF Bearing Supports

Standard P/N	Bearing Block Dimensions (inch)								
	d1 (mm)	A	B	C	D	F	K ±0.001	L	N
7833368	8	0.906	1.181	2.362	0.394	0.787	0.866	1.535	4x .260 Thru, .425 C-Bore x .197 Dp
7833372	20	1.378	1.732	3.465	0.512	1.024	1.339	2.362	4x .354 Thru, .551 C-Bore x .335 Dp
7833373	25	1.673	2.087	4.173	0.591	1.181	1.890	3.150	4x .433 Thru, .699 C-Bore x .433 Dp
7833375	40	2.559	3.150	6.299	0.728	1.457	2.362	4.331	4x .709 Thru, 1.024 C-Bore x .689 Dp

## Bearing Supports/End Machining — Ball Screws

BK

TYPE BK, REQUIRED FOR BK SUPPORT

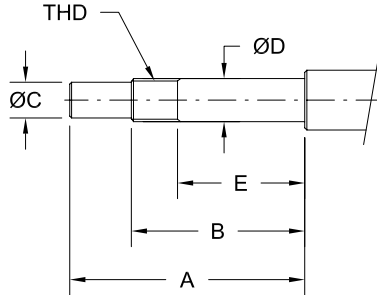

TYPE BK1, REQUIRED FOR BK SUPPORT

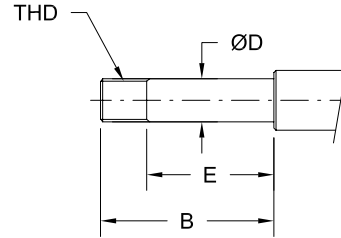

### Bearing Supports / End Machining - Inch Series Ball Screw

BK Standard End Machining

Dia x Lead (inch)	Standard P/N	Type BK / BK1 (inch)						Bearing Trade No.
		A	B	C	D	E	THD	
0.500	7833360	2.008	1.417	.3150/.3144	.3935/.3932	0.787	M10x1	7000
0.631	7833361	2.008	1.417	.3937/.3931	.4722/.4720	0.866	M12x1	7001
0.750	7833362	2.362	1.575	.4724/.4717	.5904/.5900	1.102	M15x1	7002
0.875	7833363	2.992	2.087	.5906/.5898	.6691/.6687	1.417	M17x1	7203
1.000 / 1.171	7833364	3.071	2.087	.6693/.6686	.7872/.7869	1.496	M20x1	7004
1.150 / 1.250	7833365	3.740	2.559	.7874/.7866	.9841/.9837	1.850	M25x1.5	7205
1.500 x 0.473 & 1.000	7833366	4.331	2.835	.9843/.9834	1.1809/1.18105	1.850	M30x1.5	7206
1.500 x 0.200 & 0.250								
1.500 x 0.500 & 1.875								
1.500 x 2.000	7833367	5.630	3.661	1.3780/1.3771	1.5746/1.5742	2.283	M40x1.5	7208

### Bearing Supports / End Machining - Metric Series Ball Screw

BK Standard End Machining

Dia x Lead (mm)	Standard P/N	Type BK / BK1 (mm)						Bearing Trade No.
		A	B	C	D	E	THD	
12	7833391	51.0	36.0	8.0	9.995/9.988	20.0	M10x1	7000
16	7833392	51.0	36.0	10.0	11.995/11.988	22.0	M12x1	7001
20	7833393	60.0	40.0	12.0	14.995/14.986	28.0	M15x1	7002
25	7833394	78.0	53.0	17.0	19.995/19.986	38.0	M20x1	7004
32	7833395	95.0	65.0	20.0	24.995/24.985	47.0	M25x1.5	7205
40	7833396	110.0	72.0	25.0	29.995/29.985	47.0	M30x1.5	7206
50	7833397	143.0	93.0	35.0	39.995/39.985	58.0	M40x1.5	7208

### Bearing Supports / End Machining - Ball Splines

BK Standard End Machining

Spline Size (inch)	Standard P/N	Type BK / BK1 (inch)						Bearing Trade No.
		A	B	C	D	E	THD	
0.625	7833360	2.008	1.417	.3150/.3144	.3935/.3932	0.787	M10x1	7000
1.000	7833364	3.071	2.087	.6693/.6686	.7872/.7869	1.496	M20x1	7004
1.500	7833365	3.740	2.559	.7874/.7866	.9841/.9837	1.850	M25x1.5	7205
2.000	7833367	5.630	3.661	1.3780/1.3771	1.5746/1.5742	2.283	M40x1.5	7208



## Bearing Supports/End Machining — Ball Screws

BF

TYPE BF, REQUIRED FOR BF SUPPORT

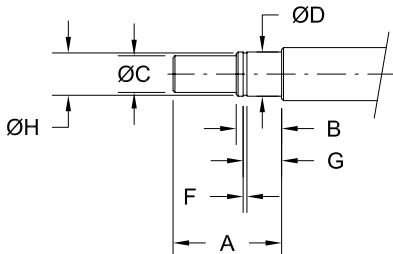

TYPE BF1, REQUIRED FOR BF SUPPORT

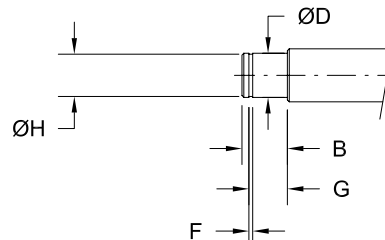

### Bearing Supports / End Machining - Inch Series Ball Screw

BF Standard End Machining

Standard P/N	Type BF / BF1 (inch)							*Snap Ring (mm)	Bearing Trade No.
	A	B	C h7	D	F +0.006/-0.000	G +0.008/-0.000	H +0.000/-0.008		
7833368	0.984	0.394	0.236	.3148/.3145	0.035	0.311	0.299	8	608
7833369	1.024	0.433	0.394	.3935/.3932	0.045	0.360	0.378	10	6000
7833370	1.299	0.512	0.472	.5904/.5900	0.045	0.400	0.563	15	6002
7833371	1.535	0.630	0.591	.6691/.6687	0.045	0.518	0.638	17	6203
7833372	1.614	0.630	0.669	.7872/.7869	0.053	0.526	0.748	20	6004
7833373	1.969	0.787	0.787	.9841/.9837	0.053	0.644	0.941	25	6205
7833374	2.323	0.827	0.984	1.1809/1.1805	0.069	0.699	1.126	30	6206
7833375	2.874	0.906	1.378	1.5746/1.5742	0.077	0.785	1.496	40	6208

### Bearing Supports / End Machining - Metric Series Ball Screw

BF Standard End Machining

Standard P/N	Type BF / BF1 (mm)							*Snap Ring (mm)	Bearing Trade No.
	A	B	C h7	D	F +0.140/-0.000	G +0.200/-0.000	H +0.000/-0.200		
7833398	25.0	10.0	6.0	7.995/7.988	0.90	7.90	7.60	8	608
7833399	26.0	11.0	10.0	9.995/9.988	1.15	9.15	9.60	10	6000
7833400	33.0	13.0	12.0	14.995/14.986	1.15	10.15	14.30	15	6002
7833401	41.0	16.0	17.0	19.995/19.986	1.35	13.35	19.00	20	6004
7833402	50.0	20.0	20.0	24.995/24.986	1.35	16.35	23.90	25	6205
7833403	59.0	21.0	25.0	29.995/29.985	1.75	17.75	28.60	30	6206
7833404	73.0	23.0	35.0	39.995/39.985	1.95	19.95	38.00	40	6208

### Bearing Supports / End Machining - Ball Splines

BF Standard End Machining

Standard P/N	Type BF / BF1 (inch)							*Snap Ring (mm)	Bearing Trade No.
	A	B	C h7	D	F +0.006/-0.000	G +0.008/-0.000	H +0.000/-0.008		
7833368	0.984	0.394	0.236	0.3148	0.035	0.311	0.299	8	608
7833372	1.614	0.630	0.669	0.7872	0.053	0.526	0.748	20	6004
7833373	1.969	0.787	0.787	0.9841	0.053	0.644	0.941	25	6205
7833375	2.874	0.906	1.378	1.5746	0.077	0.785	1.496	40	6208

\*DIN 471

## Bearing Supports/End Machining — Ball Screws

FK

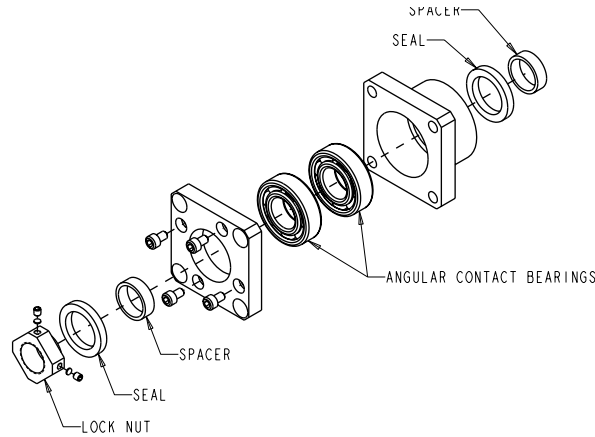

### Bearing Supports / End Machining - Inch Series Ball Screw

FK Bearing Supports

Standard P/N	Dia. X Lead (inch)	Bearing Rating				Lock Nut Type	Block Weight (lbs)
		Static Rating $C_0$		Dynamic Rating $C_{am}$			
		(lbs)	(N)	(lbs)	(N)		
7833377	0.5	1168	5195	430	1913	RN10	0.6
7833378	0.631	1345	5983	478	2126	RN12	0.6
7833379	0.75	1543	6863	529	2353	RN15	0.9
7833380	0.875	2690	11965	910	4048	RN17	1.9
7833381	1.000 / 1.171	3726	16573	1294	5756	RN20	2.5
7833382	1.150 / 1.250	4608	20496	1563	6952	RN25	3.5
7833383	1.500 x 0.473 & 1.000 1.500 x 0.200 & 0.250 1.500 x 0.500 & 1.875 1.500 x 2.000	6614	29419	2070	9207	RN30	5.2

### Bearing Supports / End Machining - Metric Series Ball Screw

FK Bearing Supports

Standard P/N	Dia. X Lead (mm)	Bearing Rating				Lock Nut Type	Block Weight (kg)
		Static Rating $C_0$		Dynamic Rating $C_{am}$			
		(lbs)	(N)	(lbs)	(N)		
7833405	12	1168	5195	430	1913	RN10	0.3
7833406	16	1345	5983	478	2126	RN12	0.3
7833407	20	1543	6863	529	2353	RN15	0.4
7833408	25	3726	16573	1294	5756	RN20	1.2
7833409	32	4608	20496	1563	6952	RN25	1.6
7833410	40	6614	29419	2070	9207	RN30	2.4

### Bearing Supports / End Machining - Ball Splines

FK Bearing Supports

Standard P/N	Spline Size (inch)	Bearing Rating				Lock Nut Type	Block Weight (lbs)
		Static Rating $C_0$		Dynamic Rating $C_{am}$			
		(lbs)	(N)	(lbs)	(N)		
7833377	0.625	1168	5195	430	1913	RN10	0.6
7833381	1.000	3726	16573	1294	5756	RN20	2.5
7833382	1.500	4608	20496	1563	6952	RN25	3.5

## Bearing Supports/End Machining — Ball Screws

FK

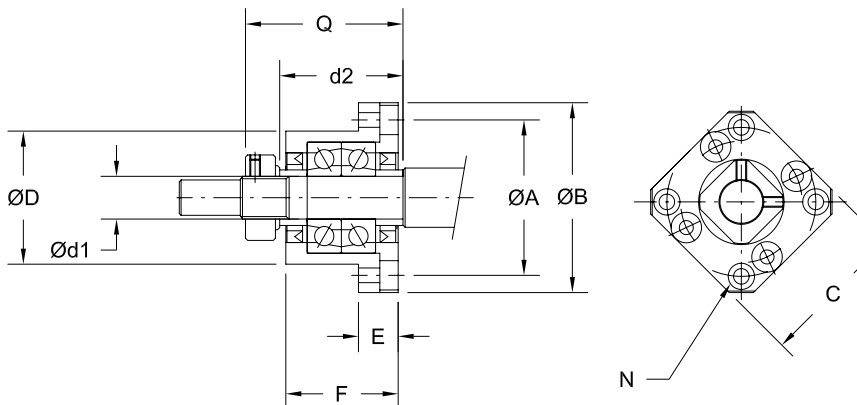

### Bearing Supports / End Machining - Inch Series Ball Screw

FK Bearing Supports

Standard P/N	Bearing Block Dimensions (inch)									
	d1 (mm)	d2	A	B	C	D	E	F	N	Q
7833377	10	1.063	1.654	2.047	1.654	1.3382/1.3376	0.394	1.063	4x .177 Thru, .315 C-Bore x .157 Dp	1.299
7833378	12	1.063	1.732	2.126	1.732	1.4170/1.4163	0.394	1.063	4x .177 Thru, .315 C-Bore x .157 Dp	1.299
7833379	15	1.496	1.969	2.480	2.047	1.5744/1.5738	0.591	1.260	4x .217 Thru, .374 C-Bore x .236 Dp	1.575
7833380	17	1.732	2.441	3.031	2.402	1.9681/1.9675	0.866	1.772	4x .260 Thru, .433 C-Bore x .394 Dp	2.244
7833381	20	1.969	2.756	3.346	2.677	2.2437/2.2430	0.866	2.047	4x .260 Thru, .433 C-Bore x .394 Dp	2.598
7833382	25	2.362	3.150	3.858	3.110	2.4799/2.4792	1.063	2.244	4x .354 Thru, .591 C-Bore x .512 Dp	2.913
7833383	30	1.969	3.740	4.606	3.661	2.9524/2.9516	1.181	2.441	4x .433 Thru, .689 C-Bore x .591 Dp	3.150

### Bearing Supports / End Machining - Metric Series Ball Screw

FK Bearing Supports

Standard P/N	Bearing Block Dimensions (mm)									
	d1 (mm)	d2	A	B	C	D g6	E	F	N	Q
7833405	10	27.0	42.0	52.0	42.0	34.0	10.0	27.0	4x 4.5 Thru, 8.0 C-Bore x 4.0 Dp	33.0
7833406	12	27.0	44.0	54.0	44.0	36.0	10.0	27.0	4x 4.5 Thru, 8.0 C-Bore x 4.0 Dp	33.0
7833407	15	38.0	50.0	63.0	52.0	40.0	15.0	32.0	4x 5.5 Thru, 9.5 C-Bore x 6.0 Dp	40.0
7833408	20	50.0	70.0	85.0	68.0	57.0	22.0	52.0	4x 6.6 Thru, 11.0 C-Bore x 10.0 Dp	66.0
7833409	25	60.0	80.0	98.0	79.0	63.0	27.0	57.0	4x 9.0 Thru, 15.0 C-Bore x 13.0 Dp	74.0
7833410	30	50.0	95.0	117.0	93.0	75.0	30.0	62.0	4x 11.0 Thru, 17.5 C-Bore x 15.0 Dp	80.0

### Bearing Supports / End Machining - Ball Splines

FK Bearing Supports

Standard P/N	Bearing Block Dimensions (inch)									
	d1 (mm)	d2	A	B	C	D	E	F	N	Q
7833377	10	1.063	1.654	2.047	1.654	1.3382/1.3376	0.394	1.063	4x .177 Thru, .315 C-Bore x .157 Dp	1.339
7833381	20	1.969	2.756	3.346	2.677	2.2437/2.2430	0.866	2.047	4x .260 Thru, .433 C-Bore x .394 Dp	2.008
7833382	25	2.362	3.150	3.858	3.110	2.4799/2.4792	1.063	2.244	4x .354 Thru, .591 C-Bore x .512 Dp	2.480

## Bearing Supports/End Machining — Ball Screws

FF

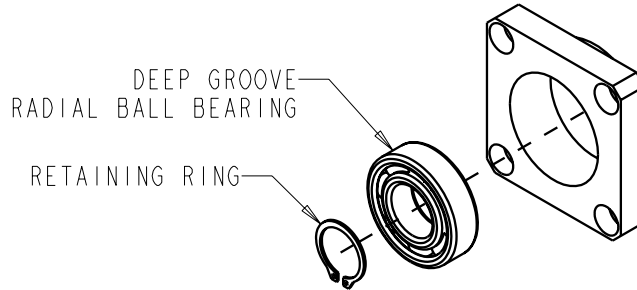

### Bearing Supports / End Machining - Inch Series Ball Screw

FF Bearing Supports

Standard P/N	Dia. X Lead (inch)	*Snap Ring (mm)	Block Weight (lbs)
7833384	0.5	8	0.2
7833385	0.631	10	0.3
7833386	0.75	15	0.5
7833387	0.875	17	0.8
7833388	1.000 / 1.171	20	1.0
7833389	1.150 / 1.250	25	1.5
7833390	1.500 x 0.473 & 1.000	30	2.3
	1.500 x 0.200 & 0.250		
	1.500 x 0.500 & 1.875		
	1.500 x 2.000		

### Bearing Supports / End Machining - Metric Series Ball Screw

FF Bearing Supports

Standard P/N	Dia. X Lead (mm)	*Snap Ring (mm)	Block Weight (kg)
7833411	12	8	0.1
7833412	16	10	0.2
7833413	20	15	0.2
7833414	25	20	0.5
7833415	32	25	0.7
7833416	40	30	1.1

### Bearing Supports / End Machining - Ball Splines

FF Bearing Supports

Standard P/N	Spline Size (inch)	*Snap Ring (mm)	Block Weight (lbs)
7833384	0.625	8	0.2
7833388	1.000	20	1.0
7833389	1.500	25	1.5

\*DIN 471

## Bearing Supports/End Machining — Ball Screws

FF

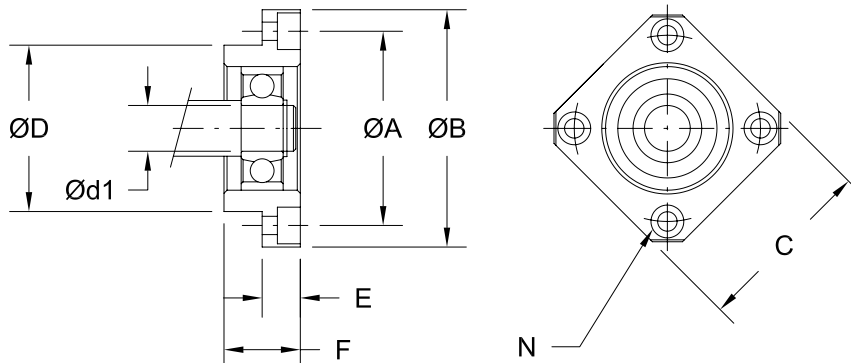

### Bearing Supports / End Machining - Inch Series Ball Screw

FF Bearing Supports

Standard P/N	Bearing Block Dimensions (inch)							
	d1 (mm)	A	B	C	D	E	F	N
7833384	8	1.378	1.693	1.378	1.1021/1.1016	0.276	0.472	4x .134 Thru, .256 C-Bore x .157 Dp
7833385	10	1.654	2.047	1.654	1.3382/1.3376	0.276	0.591	4x .177 Thru, .315 C-Bore x .157 Dp
7833386	15	1.969	2.480	2.047	1.5744/1.5738	0.354	0.669	4x .217 Thru, .374 C-Bore x .217 Dp
7833387	17	2.441	3.031	2.402	1.9681/1.9675	0.433	0.787	4x .260 Thru, .433 C-Bore x .256 Dp
7833388	20	2.756	3.346	2.677	2.2437/2.2430	0.433	0.787	4x .260 Thru, .433 C-Bore x .256 Dp
7833389	25	3.150	3.858	3.110	2.4799/2.4792	0.551	0.945	4x .354 Thru, .551 C-Bore x .335 Dp
7833390	30	3.740	4.606	3.661	2.9524/2.9516	0.709	1.063	4x .433 Thru, .669 C-Bore x .433 Dp

### Bearing Supports / End Machining - Metric Series Ball Screw

FF Bearing Supports

Standard P/N	Bearing Block Dimensions (mm)							
	d1 (mm)	A	B	C	D	E	F	N
7833411	8	35.0	43.0	35.0	28.0	7.0	12.0	4x 3.4 Thru, 6.5 C-Bore x 4.0 Dp
7833412	10	42.0	52.0	42.0	34.0	7.0	15.0	4x 4.5 dia Thru, 8.0 C-Bore x 4.0 Dp
7833413	15	50.0	63.0	52.0	40.0	9.0	17.0	4x 5.5 Thru, 9.5 C-Bore x 5.5 Dp
7833414	20	70.0	85.0	68.0	57.0	11.0	20.0	4x 6.6 Thru, 11.0 C-Bore x 6.5 Dp
7833415	25	80.0	98.0	79.0	63.0	14.0	24.0	4x 9.0 Thru, 14.0 C-Bore x 8.5 Dp
7833416	30	95.0	117.0	93.0	75.0	18.0	27.0	4x 11.0 Thru, 17.0 C-Bore x 11.0 Dp

### Bearing Supports / End Machining - Ball Splines

FF Bearing Supports

Standard P/N	Bearing Block Dimensions (inch)							
	d1 (mm)	A	B	C	D	E	F	N
7833384	8	1.378	1.693	1.378	1.1021/1.1016	0.276	0.472	4x .134 Thru, .256 C-Bore x .157 Dp
7833388	20	2.756	3.346	2.677	2.2437/2.2430	0.433	0.787	4x .260 Thru, .433 C-Bore x .256 Dp
7833389	25	3.150	3.858	3.110	2.4799/2.4792	0.551	0.945	4x .354 Thru, .551 C-Bore x .335 Dp

## Bearing Supports/End Machining — Ball Screws

FK

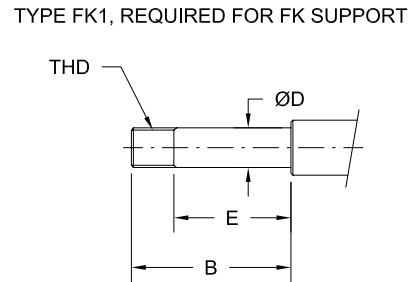
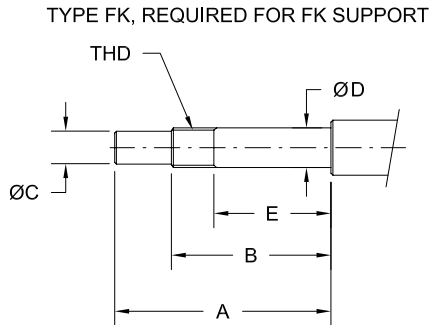

### Bearing Supports / End Machining - Inch Series Ball Screw

FK Standard End Machining

Dia x Lead (inch)	Standard P/N	Type FK / FK1 (inch)						Bearing Trade No.
		A	B	C	D	E	THD	
0.500	7833377	2.008	1.417	.3150/.3144	.3935/.3932	0.984	M10x1	7000
0.631	7833378	2.008	1.417	.3937/.3931	.4722/.4720	0.984	M12x1	7001
0.750	7833379	2.638	1.850	.4724/.4717	.5904/.5900	1.339	M15x1	7002
0.875	7833380	3.189	2.283	.5906/.5898	.6691/.6687	1.693	M17x1	7203
1.000 / 1.171	7833381	3.425	2.441	.6693/.6686	.7872/.7869	1.772	M20x1	7204
1.150 / 1.250	7833382	4.173	2.992	.7874/.7866	.9841/.9837	2.205	M25x1.5	7205
1.500 x 0.473 & 1.000	7833383	4.331	2.835	.9843/.9834	1.1809/1.1805	1.850	M30x1.5	7206
1.500 x 0.200 & 0.250								
1.500 x 0.500 & 1.875								
1.500 x 2.000								

### Bearing Supports / End Machining - Metric Series Ball Screw

FK Standard End Machining

Dia x Lead (mm)	Standard P/N	Type FK / FK1 (mm)						Bearing Trade No.
		A	B	C	D	E	THD	
12	7833405	51.0	36.0	8.0	9.995/9.988	25.0	M10x1	7000
16	7833406	51.0	36.0	10.0	11.995/11.988	25.0	M12x1	7001
20	7833407	67.0	47.0	12.0	14.995/14.986	34.0	M15x1	7002
25	7833408	87.0	62.0	17.0	19.995/19.986	45.0	M20x1	7204
32	7833409	106.0	76.0	20.0	24.995/24.985	56.0	M25x1.5	7205
40	7833410	110.0	72.0	25.0	29.995/29.985	47.0	M30x1.5	7206

### Bearing Supports / End Machining - Ball Splines

FK Standard End Machining

Spline Size (inch)	Standard P/N	Type FK / FK1 (inch)						Bearing Trade No.
		A	B	C	D	E	THD	
0.625	7833377	2.008	1.417	.3150/.3144	.3935/.3932	0.984	M10x1	7000
1.000	7833381	3.425	2.441	.6693/.6686	.7872/.7869	1.772	M20x1	7204
1.500	7833382	4.173	2.992	.7874/.7866	.9841/.9837	2.205	M25x1.5	7205

## Bearing Supports/End Machining — Ball Screws

FF

TYPE FF, REQUIRED FOR FF SUPPORT

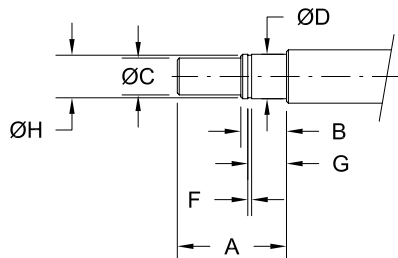

TYPE FF1, REQUIRED FOR FF SUPPORT

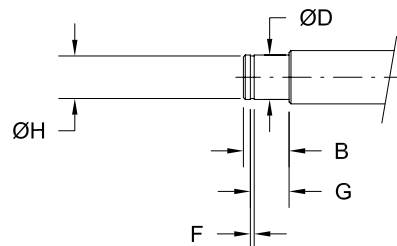

### Bearing Supports / End Machining - Inch Series Ball Screw

FF Standard End Machining

Standard P/N	Type FF / FF1 (inch)							*Snap Ring (mm)	Bearing Trade No.
	A	B	C h7	D	F +0.006/-0.000	G +0.008/-0.000	H +0.000/-0.008		
7833384	0.984	0.394	0.236	.3148/.3145	0.035	0.311	0.299	8	608
7833385	1.024	0.433	0.394	.3935/.3932	0.045	0.360	0.378	10	6000
7833386	1.299	0.512	0.472	.5904/.5900	0.045	0.400	0.563	15	6002
7833387	1.535	0.630	0.591	.6991/.6687	0.045	0.518	0.638	17	6203
7833388	1.614	0.748	0.669	.7872/.7869	0.053	0.604	0.748	20	6004
7833389	1.969	0.787	0.787	.9841/.9837	0.053	0.644	0.941	25	6205
7833390	2.323	0.827	0.984	1.1809/1.1805	0.069	0.699	1.126	30	6206

### Bearing Supports / End Machining - Metric Series Ball Screw

FF Standard End Machining

Standard P/N	Type FF / FF1 (mm)							*Snap Ring (mm)	Bearing Trade No.
	A	B	C h7	D	F +0.140/-0.000	G +0.200/-0.000	H +0.000/-0.200		
7833411	25.0	10.0	6.0	7.995/7.988	0.90	7.90	7.60	8	608
7833412	26.0	11.0	10.0	9.995/9.988	1.15	9.15	9.60	10	6000
7833413	33.0	13.0	12.0	14.995/14.986	1.15	10.15	14.30	15	6002
7833414	41.0	19.0	17.0	19.995/19.986	1.35	15.35	19.00	20	6004
7833415	50.0	20.0	20.0	24.995/24.986	1.35	16.35	23.90	25	6205
7833416	59.0	21.0	25.0	29.995/29.985	1.75	17.75	28.60	30	6206

### Bearing Supports / End Machining - Ball Splines

FF Standard End Machining

Standard P/N	Type FF / FF1 (inch)							*Snap Ring (mm)	Bearing Trade No.
	A	B	C h7	D	F +0.006/-0.000	G +0.008/-0.000	H +0.000/-0.008		
7833384	0.984	0.394	0.236	.3148/.3145	0.035	0.311	0.299	8	608
7833388	1.614	0.748	0.669	.7872/.7869	0.053	0.604	0.748	20	6004
7833389	1.969	0.787	0.787	.9841/.9837	0.053	0.644	0.941	25	6205

\*DIN 471

## Motor Supports

MK

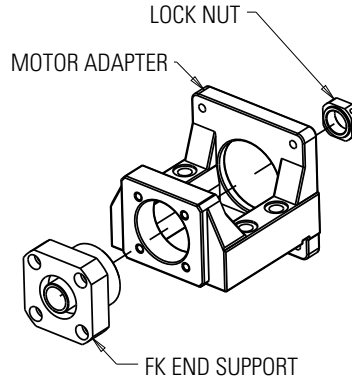

### Motor Supports - Inch Series Ball Screw

MK Motor Supports

Standard P/N	Dia. X Lead (inch)	Bearing Rating				Lock Nut Type
		Static Rating $C_0$		Dynamic Rating $C_{am}$		
		(lbs)	(N)	(lbs)	(N)	
7833685	0.5	1168	5195	430	1913	RN10
7833686	0.631	1345	5983	478	2126	RN12
7833687	0.75	1543	6863	529	2353	RN15
7833690	1.000 / 1.171	3726	16573	1294	5756	RN20

### Motor Supports - Metric Series Ball Screw

MK Motor Supports

Standard P/N	Dia. X Lead (mm)	Bearing Rating				Lock Nut Type
		Static Rating $C_0$		Dynamic Rating $C_{am}$		
		(lbs)	(N)	(lbs)	(N)	
7833700	12	1168	5195	430	1913	RN10
7833701	16	1345	5983	478	2126	RN12
7833702	20	1543	6863	529	2353	RN15
7833703	25	3726	16573	1294	5756	RN20



## Motor Supports

MK

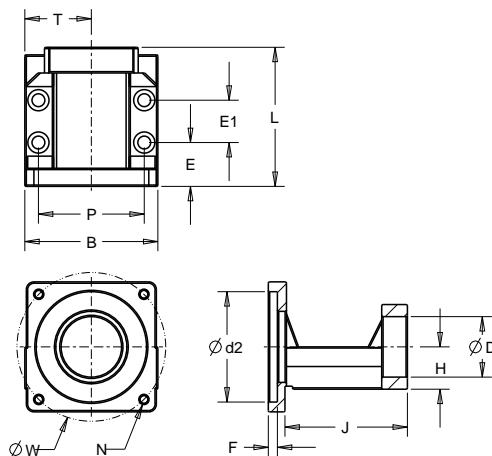

### Motor Supports - Inch Series Ball Screw

MK Motor Supports

Standard P/N	Bearing Block Dimensions (mm)														Support Unit	Frame Size	N
	d1 (mm)	d2	W	N	D	L	H ±0.001	B	P	T	E	E1	F				
7833685	10	1.500	2.626	M4	1.339	2.913	0.866	2.559	1.969	1.280	0.945	0.787	0.157	FK10	NEMA 23	4x .260 Thru, .441 C-Bore x .236 Dp	
7833686	12	1.500	2.626	M4	1.417	2.913	0.984	2.559	1.969	1.280	0.945	0.787	0.157	FK12	NEMA 23	4x .260 Thru, .441 C-Bore x .236 Dp	
7833687	15	1.500	2.626	M4	1.575	3.228	1.102	2.756	2.165	1.378	0.945	1.102	0.157	FK15	NEMA 23	4x .260 Thru, .441 C-Bore x .236 Dp	
7833690	20	2.874	3.874	M6	2.244	4.449	1.339	3.465	2.756	1.732	1.142	1.654	0.236	FKA20	NEMA 34	4x .335 Thru, .571 C-Bore x .315 Dp	

### Motor Supports - Metric Series Ball Screw

MK Motor Supports

Standard P/N	Bearing Block Dimensions (mm)														Support Unit	Frame Size	N
	d1 (mm)	d2	W1	Y	D	L	H ±0.02	B	P	T	E	E1	F				
7833700	10	38.1	66.7	M4	34	74	22.00	65	50	32.5	24	20	4	FK10	NEMA 23	4x 6.6 Thru, 11.2 C-Bore x 6.0 Dp	
7833701	12	38.1	66.7	M4	36	74	25.00	65	50	32.5	24	20	4	FK12	NEMA 23	4x 6.6 Thru, 11.2 C-Bore x 6.0 Dp	
7833702	15	38.1	66.7	M4	40	82	28.00	70	55	35.0	24	28	4	FK15	NEMA 23	4x 6.6 Thru, 11.2 C-Bore x 6.0 Dp	
7833703	20	73.0	98.4	M6	57	113	34.00	88	70	44.0	29	42	6	FKA20	NEMA 34	4x 8.5 Thru, 14.5 C-Bore x 8.0 Dp	

## Bearing Supports/End Machining — Ball Screws

WK

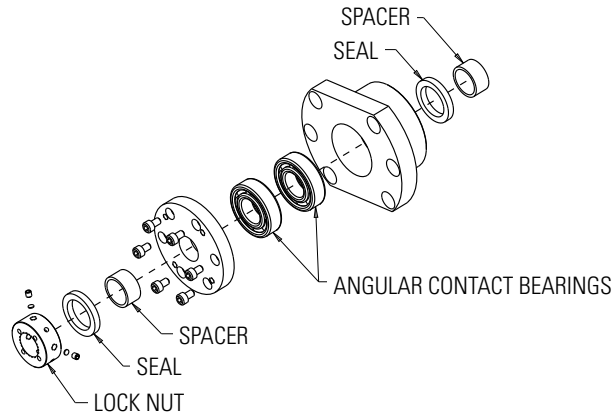

## Bearing Supports / End Machining - Inch Series Ball Screw

WK Bearing Supports

Standard P/N	Dia. X Lead (inch)	Bearing Rating				Lock Nut Type	Block Weight (lbs)
		Static Rating $C_0$		Dynamic Rating $C_{am}$			
		(lbs)	(N)	(lbs)	(N)		
7833595	0.875	4938	21964	5980	26600	M17x1	4.2
7833596	1.000 / 1.171	4938	21964	5980	26600	M20x1	4.2
7833597	1.150 / 1.250	6415	28534	9105	40500	M25x1.5	6.8
7833599	1.500 x 0.473 & 1.000 1.500 x 0.200 & 0.250 1.500 x 0.500 & 1.875 1.500 x 2.000	6570	29223	9667	43000	M30x1.5	6.6
7833602	1.750 / 2.000	7165	31870	11691	52000	M40x1.5	7.9

## Bearing Supports / End Machining - Metric Series Ball Screw

WK Bearing Supports

Standard P/N	Dia. X Lead (mm)	Bearing Rating				Lock Nut Type	Block Weight (kg)
		Static Rating $C_0$		Dynamic Rating $C_{am}$			
		(lbs)	(N)	(lbs)	(N)		
7833614	25	4938	21964	5980	26600	M20x1	1.9
7833615	32	6415	28534	9105	40500	M25x1.5	3.1
7833617	40	6570	29223	9667	43000	M30x1.5	3.0
7833621	50	7165	31870	11691	52000	M40x1.5	3.6

## Bearing Supports / End Machining - Ball Splines

WK Bearing Supports

Standard P/N	Spline Size (inch)	Bearing Rating				Lock Nut Type	Block Weight (lbs)
		Static Rating $C_0$		Dynamic Rating $C_{am}$			
		(lbs)	(N)	(lbs)	(N)		
7833596	1.000	4938	21964	5980	26600	M20x1	4.2
7833597	1.500	6415	28534	9105	40500	M25x1.5	6.8
7833602	2.000	7165	31870	11691	52000	M40x1.5	7.9

## Bearing Supports/End Machining — Ball Screws

WK

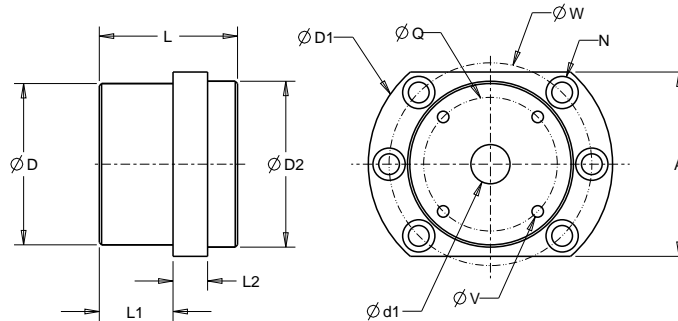

### Bearing Supports / End Machining - Inch Series Ball Screw

WK Bearing Supports

Standard P/N	Bearing Block Dimensions (inch)											
	d1 (mm)	D g6	D1	D2	L	L1	L2	A	W	N	V	Q
7833595	17	2.756	4.173	2.835	2.362	1.260	0.591	3.150	3.465	6x .354 Thru, .551 C-Bore x .335 Dp	2.283	4x M5 THD, x .394 Dp
7833596	20	2.756	4.173	2.835	2.362	1.260	0.591	3.150	3.465	6x .433 Thru, .669 C-Bore x .433 Dp	2.283	4x M5 THD, x .472 Dp
7833597	25	3.346	5.118	3.543	2.598	1.299	0.709	3.937	4.331	6x .433 Thru, .669 C-Bore x .433 Dp	2.756	4x M6 THD, x .472 Dp
7833599	30	3.346	5.118	3.543	2.598	1.299	0.709	3.937	4.331	6x .433 Thru, .669 C-Bore x .433 Dp	2.756	4x M6 THD, x .472 Dp
7833602	40	3.740	5.591	4.016	2.598	1.299	0.709	4.173	4.764	8x .433 Thru, .669 C-Bore x .433 Dp	3.150	4x M6 THD, x .472 Dp

### Bearing Supports / End Machining - Metric Series Ball Screw

WK Bearing Supports

Standard P/N	Bearing Block Dimensions (mm)											
	d1 (mm)	D g6	D1	D2	L	L1	L2	A	W	N	V	Q
7833614	20	70.0	106.0	72.0	60.0	32.0	15.0	80.0	88.00	6x 9.0 Thru, 14.0 C-Bore x 8.5 Dp	58	4x M5 THD, x 10 Dp
7833615	25	85.0	130.0	90.0	66.0	33.0	18.0	100.0	110.00	6x 11.0 Thru, 17.0 C-Bore x 11 Dp	70	4x M6 THD, x 12 Dp
7833617	30	85.0	130.0	90.0	66.0	33.0	18.0	100.0	110.00	6x 11.0 Thru, 17.0 C-Bore x 11 Dp	70	4x M6 THD, x 12 Dp
7833621	40	95.0	142.0	102.0	66.0	33.0	18.0	106.0	121.00	8x 11.0 Thru, 17.0 C-Bore x 11 Dp	80	4x M6 THD, x 12 Dp

### Bearing Supports / End Machining - Ball Splines

WK Bearing Supports

Standard P/N	Bearing Block Dimensions (inch)											
	d1 (mm)	D g6	D1	D2	L	L1	L2	A	W	N	V	Q
7833596	20	2.756	4.173	2.835	2.362	1.2598	0.591	3.150	3.465	6x .433 Thru, .669 C-Bore x .433 Dp	2.283464567	4x M5 THD, x .472 Dp
7833597	25	3.346	5.118	3.543	2.598	1.2992	0.709	3.937	4.331	6x .433 Thru, .669 C-Bore x .433 Dp	2.755905512	4x M6 THD, x .472 Dp
7833602	40	3.740	5.591	4.016	2.598	1.2992	0.709	4.173	4.764	8x .433 Thru, .669 C-Bore x .433 Dp	3.149606299	4x M6 THD, x .472 Dp

## Bearing Supports/End Machining — Ball Screws

MK

TYPE MK, REQUIRED FOR MK SUPPORT

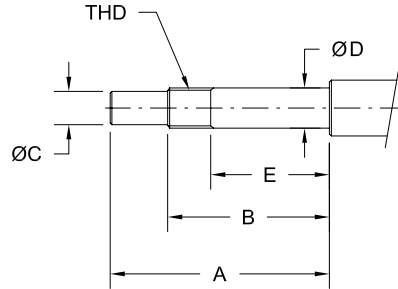

### Bearing Supports / End Machining - Inch Series Ball Screw

MK Standard End Machining

Dia x Lead (inch)	Standard P/N	Type MK (inch)						Bearing Trade No.
		A	B	C	D	E	THD	
0.500	7833685	2.008	1.417	.3150/.3144	.3935/.3932	0.984	M10x1	7000
0.631	7833686	2.008	1.417	.3937/.3931	.4722/.4720	0.984	M12x1	7001
0.750	7833687	2.638	1.850	.4724/.4717	.5904/.5900	1.339	M15x1	7002
1.000 / 1.171	7833690	3.425	2.441	.6693/.6686	.7872/.7869	1.772	M20x1	7204

### Bearing Supports / End Machining - Metric Series Ball Screw

MK Standard End Machining

Dia x Lead (mm)	Standard P/N	Type MK (mm)						Bearing Trade No.
		A	B	C h7	D	E	THD	
12	7833700	51.0	36.0	8.0	9.995/9.988	25.0	M10x1	7000
16	7833701	51.0	36.0	10.0	11.995/11.988	25.0	M12x1	7001
20	7833702	67.0	47.0	12.0	14.995/14.986	34.0	M15x1	7002
25	7833703	87.0	62.0	17.0	19.995/19.986	45.0	M20x1	7204

**Bearing Supports/End Machining — Ball Screws**

WK

TYPE WK, REQUIRED FOR WK SUPPORT

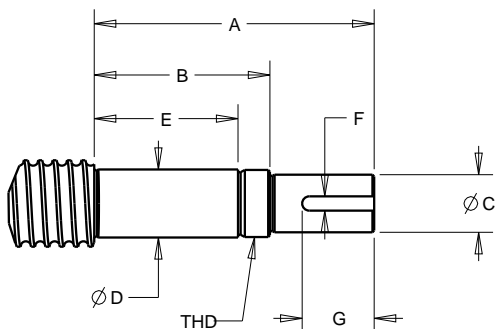

TYPE WK1, REQUIRED FOR WK SUPPORT

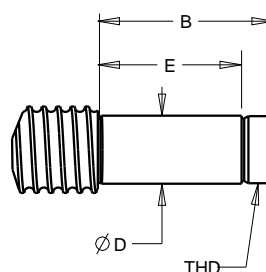

**Bearing Supports / End Machining - Inch Series Ball Screw**

WK Standard End Machining

Dia x Lead (inch)	Standard P/N	Type WK / WK1 (inch)							
		A	B	C	D	E	F	G	THD
0.875	7833595	4.528	3.189	.5906/.5898	.6691/.6687	2.283	0.197	1.181	M17x1
1.000 / 1.171	7833596	4.528	3.189	.6693/.6686	.7872/.7869	2.283	0.197	1.181	M20x1
1.150 / 1.250	7833597	5.039	3.504	.7874/.7866	.9841/.9837	2.480	0.197	1.260	M25x1.5
1.500 x 0.473 & 1.000	7833599	5.315	3.504	.9843/.9834	1.1809/1.18105	2.480	0.315	1.339	M30x1.5
1.500 x 0.200 & 0.250									
1.500 x 0.500 & 1.875									
1.500 x 2.000	7833602	5.787	3.622	1.3780/1.3771	1.5746/1.5742	2.441	0.315	1.850	M40x1.5
1.750 / 2.000									

**Bearing Supports / End Machining - Metric Series Ball Screw**

WK Standard End Machining

Dia x Lead (mm)	Standard P/N	Type WK / WK1 (mm)							
		A	B	C	D	E	F	G	THD
25	7833614	115.0	81.0	17.0	19.995/19.986	58.0	5.0	30.0	M20x1
32	7833615	128.0	89.0	20.0	24.995/24.985	63.0	5.0	32.0	M25x1.5
40	7833617	135.0	89.0	25.0	29.995/29.985	63.0	8.0	34.0	M30x1.5
50	7833621	147.0	92.0	35.0	39.995/39.985	62.0	8.0	47.0	M40x1.5

Bearing Supports/  
End Machining

**Bearing Supports / End Machining - Ball Splines**

WK Standard End Machining

Spline Size (inch)	Standard P/N	Type WK / WK1 (inch)							
		A	B	C	D	E	F	G	THD
1.000	7833596	4.528	3.189	.6693/.6686	.7872/.7869	2.283	0.197	1.181	M20x1
1.500	7833597	5.039	3.504	.7874/.7866	.9841/.9837	2.480	0.197	1.260	M25x1.5
2.000	7833602	5.787	3.622	1.3780/1.3771	1.5746/1.5742	2.441	0.315	1.850	M40x1.5

## Bearing Supports/End Machining — Ball Screws

QK

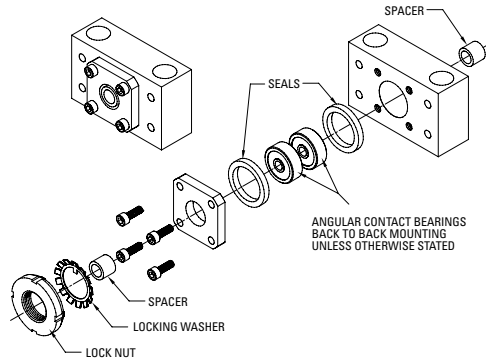

### Bearing Supports / End Machining - Inch Series Ball Screw

QK Bearing Supports

Standard P/N	Dia. X Lead (inch)	Bearing Rating				Lock Nut Type	Block Weight (lbs)
		Static Rating $C_0$		Dynamic Rating $C_{am}$			
		(lbs)	(N)	(lbs)	(N)		
7828282	0.500 x 0.200 & 0.500	440	1960	1030	4550	5/16-24	2.0
7824154	0.631 x 0.200 & 1.000	630	2790	1600	7100	N-01	1.5
7824155	0.750 x 0.200 & 0.500	1060	4700	2320	10300	N-02	3.5
7824156	0.875 x 0.200	1560	6930	3200	14200	N-03	3.5
7824157	1.000 x .200 & 0.250 1.000 x 0.500 & 1.000 1.171 x 0.413	1838	8150	3225	14300	N-04	5.5
7824158	1.150 x 0.200 1.250 x 0.200 & 0.500 1.500 x 0.473 & 1.000	2120	9400	3750	16600	N-05	9.5
7824159	1.500 x 0.200 & 0.250 1.500 x 0.500 & 1.875 1.500 x 2.000	3050	13500	5200	23000	N-06	11.5
7829554	1.750 x 0.200	6800	30200	11400	50600	N-08	21.5
7824160	2.000 X 0.200 & 0.500 & 1.000 2.250 X 0.500 & 1.000	9000	39900	15000	66600	N-09	35.0
7824161	2.500 X 0.250 & 0.500 & 1.000	10800	47900	17300	76800	N-10	39.0

### Bearing Supports / End Machining - Metric Series Ball Screw

QK Bearing Supports

Standard P/N	Dia. X Lead (mm)	Bearing Rating				Lock Nut Type	Block Weight (kg)
		Static Rating $C_0$		Dynamic Rating $C_{am}$			
		(lbs)	(N)	(lbs)	(N)		
7829546	12	440	1960	1030	4550	M8-1.25	0.9
7829547	16	630	2790	1600	7100	KM-01	0.7
7829548	20	1060	4700	2320	10300	KM-02	1.6
7829549	25	1838	8150	3225	14300	KM-03	2.5
7839550	32	2120	9400	3750	16600	KM-05	4.3
7829551	40	3050	13500	5200	23000	KM-06	5.2
7829552	50	6800	30200	11400	50600	KM-08	9.8
7829553	63	10800	47900	17300	76800	KM-10	17.7

### Bearing Supports / End Machining - Ball Splines

QK Bearing Supports

Standard P/N	Spline Size (inch)	Bearing Rating				Lock Nut Type	Block Weight (lbs)
		Static Rating $C_0$		Dynamic Rating $C_{am}$			
		(lbs)	(N)	(lbs)	(N)		
7828282	0.625	440	1960	1030	4550	5/16-24	2.0
7824157	1.000	1838	8150	3225	14300	N-04	5.5
7824159	1.500	3050	13500	5200	23000	N-06	11.5
7829554	2.000	6800	30200	11400	50600	N-08	21.5
7824161	2.500	10800	47900	17300	76800	N-10	39.0

## Bearing Supports/End Machining — Ball Screws

QK

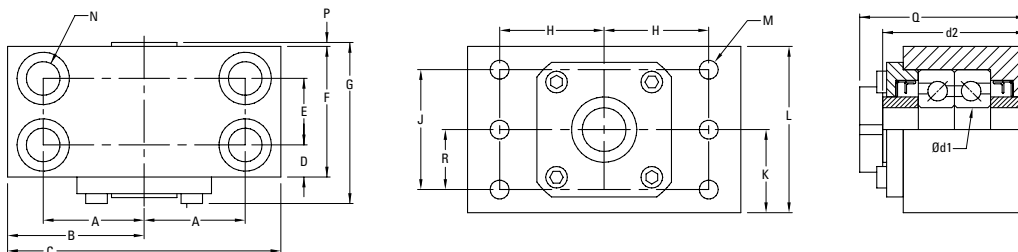

### Bearing Supports / End Machining - Inch Series Ball Screw

QK Bearing Supports

Standard P/N	Bearing Block Dimensions (inch)																
	d1 (mm)	d2	A & H	B	C	D	E	F	G	J	K	L	M	N	P	Q	R
7828282	9	1.530	1.000	1.380	2.750	0.630	-	1.190	1.645	1.375	1.000	2.000	4x .281 dia	2x .281 Thru, .50 C-Bore x .56 Dp	-	1.8	0.688
7824154	12	1.260	1.125	1.500	3.000	0.670	-	1.340	1.700	1.125	1.000	1.880	4x .281 dia	2x .406 Thru, .625 C-Bore x .875 Dp	0.02	1.6	0.625
7824155	15	1.730	1.250	1.750	3.500	0.750	-	1.500	1.900	1.375	1.125	2.130	4x .281 dia	2x .406 Thru, .625 C-Bore x .875 Dp	0.02	2.1	0.750
7824156	17	1.890	1.437	2.000	4.000	0.830	-	1.660	2.000	1.375	1.250	2.380	4x .406 dia	2x .531 Thru, .812 C-Bore x 1.125 Dp	0.02	2.3	0.750
7824157	20	2.200	1.625	2.250	4.500	0.940	-	1.870	2.400	1.750	1.438	2.750	4x .469 dia	2x .656 Thru, 1.00 C-Bore x 1.312 Dp	0.04	2.7	0.938
7824158	25	2.360	2.125	3.000	6.000	0.970	-	1.940	2.600	2.000	1.750	3.380	4x .656 dia	2x .906 Thru, 1.375 C-Bore x 2.00 Dp	0.03	2.9	1.000
7824159	30	2.520	2.375	3.250	6.500	1.030	-	2.060	2.700	2.000	1.875	3.630	4x .656 dia	2x .906 Thru, 1.375 C-Bore x 2.062 Dp	0.05	3	1.000
7829554	40	3.620	2.937	3.750	7.500	0.760	1.630	3.150	3.800	3.000	2.250	4.250	6x .656 dia	4x .906 Thru, 1.375 C-Bore x 2.25 Dp	0.05	4.2	1.500
7824160	45	3.940	3.313	4.250	8.500	0.870	1.720	3.470	4.200	3.625	2.813	5.630	6x .812 dia	4x 1.031 Thru, 1.625 C-Bore x 3.50 Dp	0.05	4.5	1.813
7824161	50	4.250	3.563	4.500	9.000	0.920	1.720	3.560	4.500	3.625	2.813	5.630	6x .812 dia	4x 1.031 Thru, 1.625 C-Bore x 3.50 Dp	0.05	4.9	1.813

### Bearing Supports / End Machining - Metric Series Ball Screw

QK Bearing Supports

Standard P/N	Bearing Block Dimensions (mm)																
	d1 (mm)	d2	A & H	B	C	D	E	F	G	J	K	L	M	N	P	Q	R
7829546	9	37.0	25.4	35.0	70.0	16.0	-	30.2	35.0	35.0	25.40	50.8	4x 7.13 dia	2x 7.13 Thru, 12.7 C-Bore x 14.22 Dp	-	46.25	17.5
7829547	12	32.0	28.6	38.0	76.0	17.0	-	34.0	43.0	29.0	25.40	47.8	4x 7.13 dia	2x 10.31 Thru, 15.88 C-Bore x 22.23 Dp	0.51	40.64	15.9
7829548	15	44.0	31.8	45.0	89.0	19.0	-	38.0	47.0	35.0	28.58	54.1	4x 7.13 dia	2x 10.31 Thru, 15.88 C-Bore x 25.40 Dp	0.51	53.34	19.1
7829549	20	56.0	41.3	57.0	114.0	24.0	-	48.0	60.0	44.0	36.53	69.9	4x 11.91 dia	2x 16.66 Thru, 25.40 C-Bore x 33.33 Dp	1	68.58	23.8
7839550	25	60.0	54.0	76.0	152.0	24.5	-	49.0	65.0	51.0	44.45	85.9	4x 16.66 dia	2x 23.01 Thru, 34.93 C-Bore x 50.80 Dp	0.76	73.66	25.4
7829551	30	64.0	60.3	83.0	165.0	26.0	-	52.0	68.0	51.0	47.63	92.2	4x 6.66 dia	2x 23.01 Thru, 34.93 C-Bore x 52.38 Dp	1.14	76.2	25.4
7829552	40	92.0	74.6	96.0	192.0	19.2	41.5	80.0	96.0	76.0	57.15	108.0	6x 16.66 dia	4x 23.01 Thru, 34.93 C-Bore x 57.15 Dp	1.27	106.68	38.1
7829553	50	108.0	90.5	115.0	230.0	23.5	43.8	90.8	113.0	92.0	71.45	143.0	6x 20.63 dia	4x 26.19 Thru, 41.28 C-Bore x 88.90 Dp	2.29	124.46	46.1

### Bearing Supports / End Machining - Ball Splines

QK Bearing Supports

Standard P/N	Bearing Block Dimensions (inch)																
	d1 (mm)	d2	A & H	B	C	D	E	F	G	J	K	L	M	N	P	Q	R
7828282	9	1.440	1.000	1.380	2.750	0.630	-	1.190	1.400	1.375	1.000	2.000	4x .281 dia	2x .281 Thru, .50 C-Bore x .56 Dp	-	1.8	0.688
7824157	20	2.200	1.625	2.250	4.500	0.940	-	1.870	2.400	1.750	1.438	2.750	4x .469 dia	2x .656 Thru, 1.00 C-Bore x 1.312 Dp	0.04	2.7	0.938
7824159	30	2.520	2.375	3.250	6.500	1.030	-	2.060	2.700	2.000	1.875	3.630	4x .656 dia	2x .906 Thru, 1.375 C-Bore x 2.062 Dp	0.05	3	1.000
7829554	40	3.620	2.937	3.750	7.500	0.760	1.630	3.150	3.800	3.000	2.250	4.250	6x .656 dia	4x .906 Thru, 1.375 C-Bore x 2.25 Dp	0.05	4.2	1.500
7824161	50	4.250	3.563	4.500	9.000	0.920	1.720	3.560	4.500	3.625	2.813	5.630	6x .812 dia	4x 1.031 Thru, 1.625 C-Bore x 3.50 Dp	0.05	4.9	1.813

## Bearing Supports/End Machining — Ball Screws

QF

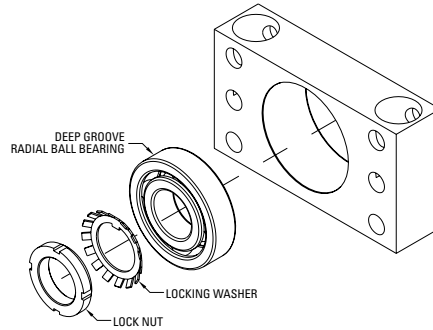

### Bearing Supports / End Machining - Inch Series Ball Screw

QF Bearing Supports

Standard P/N	Dia. X Lead (inch)	Lock Nut Type	Block Weight (lbs)
7833291	0.500 x 0.200 & 0.500	5/16-24	0.8
7833256	0.631 x 0.200 & 1.000	N-01	1.3
7833259	0.750 x 0.200 & 0.500	N-02	1.6
7833262	0.875 x 0.200	N-03	2.3
7833265	1.000 x .200 & 0.250	N-04	5.8
	1.000 x 0.500 & 1.000		
	1.171 x 0.413		
7833268	1.150 x 0.200	N-05	6.8
	1.250 x 0.200 & 0.500		
	1.500 x 0.473 & 1.000		
7833270	1.500 x 0.200 & 0.250	N-06	8.7
	1.500 x 0.500 & 1.875		
	1.500 x 2.000		
7833273	1.750 x 0.200	N-08	9.7
7833276	2.000 X 0.200 & 0.500 & 1.000	N-09	16.2
	2.250 X 0.500 & 1.000		
7833279	2.500 X 0.250 & 0.500 & 1.000	N-10	18.5

### Bearing Supports / End Machining - Metric Series Ball Screw

QF Bearing Supports

Standard P/N	Dia. X Lead (mm)	Lock Nut Type	Block Weight (kg)
7833292	12	M8-1.25	0.2
7833282	16	KM-01	0.3
7833283	20	KM-02	0.3
7833284	25	KM-03	1.2
7833285	32	KM-05	1.4
7833286	40	KM-06	1.8
7833287	50	KM-08	2.0
7833288	63	KM-10	3.8

### Bearing Supports / End Machining - Ball Splines

QF Bearing Supports

Standard P/N	Spline Size (inch)	Lock Nut Type	Block Weight (lbs)
7833291	0.625	5/16-24	0.8
7833265	1.000	N-04	5.8
7833270	1.500	N-06	8.7
7833273	2.000	N-08	9.7
7833279	2.500	N-10	18.5



## Bearing Supports/End Machining — Ball Screws

QF

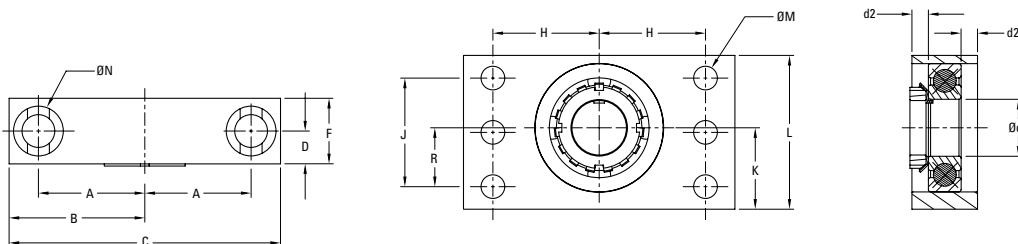

### Bearing Supports / End Machining - Inch Series Ball Screw

QF Bearing Supports

Standard P/N	Bearing Block Dimensions (inch)													Q	R
	d1 (mm)	d2	A & H	B	C	D	F	J	K	L	M	N			
7833291	9	0.118	1.000	1.380	2.750	0.276	0.551	1.375	1.000	2.000	4x .281 dia	2x .281 Thru, .50 C-Bore x .56 Dp	0.757	0.688	
7833256	12	0.197	1.125	1.500	3.000	0.394	0.787	1.125	1.000	1.880	4x .281 dia	2x .406 Thru, .625 C-Bore x .875 Dp	0.96	0.625	
7833259	15	0.217	1.250	1.750	3.500	0.433	0.866	1.375	1.125	2.130	4x .281 dia	2x .406 Thru, .625 C-Bore x .875 Dp	1.019	0.750	
7833262	17	0.236	1.437	2.000	4.000	0.473	0.945	1.375	1.250	2.380	4x .406 dia	2x .531 Thru, .812 C-Bore x 1.125 Dp	1.109	0.750	
7833265	20	0.276	1.625	2.250	4.500	0.551	1.102	1.750	1.438	2.750	4x .469 dia	2x .656 Thru, 1.00 C-Bore x 1.312 Dp	1.258	0.938	
7833268	25	0.531	2.125	3.000	6.000	0.827	1.654	2.000	1.750	3.380	4x .656 dia	2x .906 Thru, 1.375 C-Bore x 2.00 Dp	1.654	1.000	
7833270	30	0.512	2.375	3.250	6.500	0.827	1.654	2.000	1.875	3.630	4x .656 dia	2x .906 Thru, 1.375 C-Bore x 2.062 Dp	1.654	1.000	
7833273	40	0.453	2.937	3.750	7.500	0.906	1.811	3.000	2.250	4.250	6x .656 dia	4x .906 Thru, 1.375 C-Bore x 2.25 Dp	1.869	1.500	
7833276	45	0.492	3.313	4.250	8.500	0.985	1.969	3.625	2.813	5.630	6x .812 dia	4x 1.031 Thru, 1.625 C-Bore x 3.50 Dp	1.987	1.813	
7833279	50	0.531	3.563	4.500	9.000	1.063	2.126	3.625	2.813	5.630	6x .812 dia	4x 1.031 Thru, 1.625 C-Bore x 3.50 Dp	2.167	1.813	

### Bearing Supports / End Machining - Metric Series Ball Screw

QF Bearing Supports

Standard P/N	Bearing Block Dimensions (mm)													Q	R
	d1 (mm)	d2	A & H	B	C	D	F	J	K	L	M	N			
7833292	9	3.0	25.4	35.0	70.0	7.0	14.0	35.0	25.40	50.8	4x 7.13 dia	2x 7.13 Thru, 12.7 C-Bore x 14.22 Dp	18.5	17.5	
7833282	12	5.0	28.6	38.0	76.0	10.0	20.0	29.0	25.40	47.8	4x 7.13 dia	2x 10.31 Thru, 15.88 C-Bore x 22.23 Dp	20	15.9	
7833283	15	5.5	31.8	45.0	89.0	11.0	22.0	35.0	28.58	54.1	4x 7.13 dia	2x 10.31 Thru, 15.88 C-Bore x 25.40 Dp	22	19.1	
7833284	20	7.0	41.3	57.0	114.0	14.0	28.0	44.0	36.53	69.9	4x 11.91 dia	2x 16.66 Thru, 25.40 C-Bore x 33.33 Dp	28	23.8	
7833285	25	13.5	54.0	76.0	152.0	21.0	42.0	51.0	44.45	85.9	4x 16.66 dia	2x 23.01 Thru, 34.93 C-Bore x 50.80 Dp	42	25.4	
7833286	30	13.0	60.3	83.0	165.0	21.0	42.0	51.0	47.63	92.2	4x 6.66 dia	2x 23.01 Thru, 34.93 C-Bore x 52.38 Dp	42	25.4	
7833287	40	11.5	74.6	96.0	192.0	23.0	46.0	76.0	57.15	108.0	6x 16.66 dia	4x 23.01 Thru, 34.93 C-Bore x 57.15 Dp	46	38.1	
7833288	50	13.5	90.5	115.0	230.0	27.0	54.0	92.0	71.45	143.0	6x 20.63 dia	4x 26.19 Thru, 41.28 C-Bore x 88.90 Dp	54	46.1	

### Bearing Supports / End Machining - Ball Splines

QF Bearing Supports

Standard P/N	Bearing Block Dimensions (inch)													Q	R
	d1 (mm)	d2	A & H	B	C	D	F	J	K	L	M	N			
7833291	9	0.118	1.000	1.380	2.750	0.276	0.551	1.375	1.000	2.000	4x .281 dia	2x .281 Thru, .50 C-Bore x .56 Dp	0.757	0.688	
7833265	20	0.276	1.625	2.250	4.500	0.551	1.102	1.750	1.438	2.750	4x .469 dia	2x .656 Thru, 1.00 C-Bore x 1.312 Dp	1.258	0.938	
7833270	30	0.512	2.375	3.250	6.500	0.827	1.654	2.000	1.875	3.630	4x .656 dia	2x .906 Thru, 1.375 C-Bore x 2.062 Dp	1.654	1.000	
7833273	40	0.453	2.937	3.750	7.500	0.906	1.811	3.000	2.250	4.250	6x .656 dia	4x .906 Thru, 1.375 C-Bore x 2.25 Dp	1.869	1.500	
7833279	50	0.531	3.563	4.500	9.000	1.063	2.126	3.625	2.813	5.630	6x .812 dia	4x 1.031 Thru, 1.625 C-Bore x 3.50 Dp	2.167	1.813	

## Bearing Supports/End Machining — Ball Screws

QK

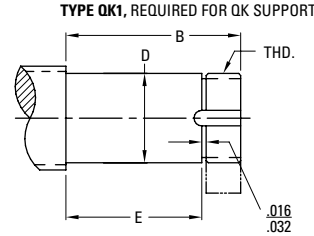
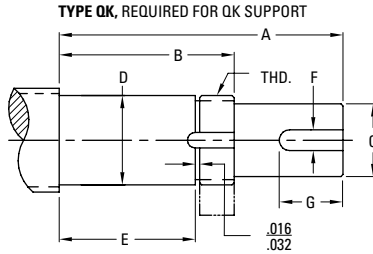

### Bearing Supports / End Machining - Inch Series Ball Screw

QK Standard End Machining

Dia x Lead (inch)	Standard P/N	Type QK / QK1 (inch)								Bearing Trade No.
		A	B	C	D	E	F	G	THD	
0.500 x 0.200 & 0.500	7828282	2.915	1.665	.2500/.2490	.3544/.3541	1.260	0.094	1.000	5/16-24	609
0.631 x 0.200 & 1.000	7824154	3.292	1.992	.4060/.4050	.4726/.4723	1.576	0.125	1.250	N-01	7201
0.750 x 0.200 & 0.500	7824155	3.180	2.180	.5000/.4990	.5908/.5905	1.732	0.125	0.875	N-02	7202
0.875 x 0.200	7824156	3.649	2.334	.5620/.5610	.6695/.6692	1.888	0.125	1.250	N-03	7203
1.000 x .200 & 0.250	7824157	4.028	2.713	.6250/.6240	.7877/.7873	2.204	0.188	1.250	N-04	7204
1.000 x 0.500 & 1.000										
1.171 x 0.413										
1.150 x 0.200	7824158	4.453	2.893	.7500/.7490	.9846/.9842	2.364	0.188	1.250	N-05	7205
1.250 x 0.200 & 0.500										
1.500 x 0.473 & 1.000										
1.500 x 0.200 & 0.250	7824159	4.860	3.050	1.000/.9990	1.1814/1.1810	2.520	0.250	1.250	N-06	7206
1.500 x 0.500 & 1.875										
1.500 x 2.000										
1.750 x 0.200	7829554	6.368	4.178	1.3750/1.3740	1.5752/1.5747	3.624	0.313	1.875	N-08	7308
2.000 x 0.200 & 0.500 & 1.000	7824160	6.682	4.492	1.3750/1.3740	1.7721/1.7716	3.936	0.313	1.875	N-09	7309
2.250 x 0.500										
2.250 x 1.000										
2.500 x 0.250	7824161	7.749	4.872	1.7500/1.7490	1.9689/1.9684	4.252	0.375	2.750	N-10	7310
2.500 x 0.500										
2.500 x 1.000										

### Bearing Supports / End Machining - Metric Series Ball Screw

QK Standard End Machining

Dia x Lead (mm)	Standard P/N	Type QK / QK1 (mm)								Bearing Trade No.
		A	B	C	D	E	F	G	THD	
12	7829546	73.0	46.0	6.000/5.987	9.001/8.994	36.0	-	-	M8-1.25	609
16	7829547	84.0	51.0	10.000/9.987	12.006/11.999	40.0	3.0	30.0	KM-01	7201
20	7829548	80.0	55.0	12.000/11.984	15.006/14.999	44.0	4.0	22.0	KM-02	7202
25	7829549	103.0	69.0	16.000/15.984	20.007/19.997	56.0	5.0	30.0	KM-04	7204
32	7829550	113.0	74.0	20.000/19.980	25.008/24.996	60.0	5.0	32.0	KM-05	7205
40	7829551	124.0	78.0	25.000/24.980	30.007/29.997	64.0	8.0	34.0	KM-06	7206
50	7829552	164.0	109.0	32.000/31.976	40.010/39.997	92.0	8.0	47.0	KM-08	7308
63	7829553	197.0	124.0	40.000/39.977	50.010/49.997	108.0	10.0	65.0	KM-10	7310

### Bearing Supports / End Machining - Ball Splines

QK Standard End Machining

Spline Size (inch)	Standard P/N	Type QK / QK1 (inch)								Bearing Trade No.
		A	B	C	D	E	F	G	THD	
0.625	7828282	2.915	1.665	.2500/.2490	.3544/.3541	1.260	0.094	1.000	5/16-24	609
1.000	7824157	4.028	2.713	.6250/.6240	.7877/.7873	2.204	0.188	1.250	N-04	7204
1.500	7824159	4.860	3.050	1.000/.9990	1.1814/1.1810	2.520	0.250	1.250	N-06	7206
2.000	7829554	6.368	4.178	1.3750/1.3740	1.5752/1.5747	3.624	0.313	1.875	N-08	7308
2.500	7824161	7.749	4.872	1.7500/1.7490	1.9689/1.9684	4.252	0.375	2.750	N-10	7310

## Bearing Supports/End Machining — Ball Screws

QF

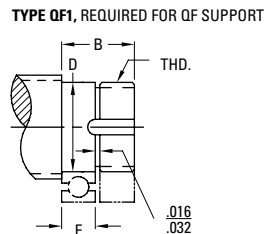
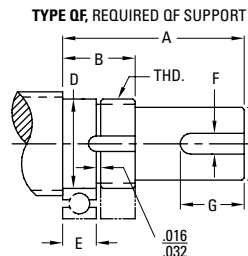

### Bearing Supports / End Machining - Inch Series Ball Screw

QF Standard End Machining

Standard P/N	Type QF / QF1 (inch)								Bearing Trade No.
	A	B	C	D	E	F	G	THD	
7833291	1.970	0.720	.2500/.2490	.3544/.3541	0.315	0.094	1.000	5/16-24	609
7833256	2.110	0.810	.4060/.4050	.4726/.4723	0.394	0.125	1.250	N-01	6201
7833259	1.870	0.870	.5000/.4990	.5908/.5905	0.433	0.125	0.875	N-02	6202
7833262	2.233	0.918	.5620/.5610	.6695/.6692	0.472	0.125	1.250	N-03	6203
7833265	2.375	1.060	.6250/.6240	.7877/.7873	0.551	0.188	1.250	N-04	6204
7833268	2.680	1.120	.7500/.7490	.9846/.9842	0.591	0.188	1.250	N-05	6205
7833270	2.970	1.160	1.0000/.9990	1.1814/1.1810	0.630	0.250	1.250	N-06	6206
7833273	3.650	1.460	1.3750/1.3740	1.5752/1.5747	0.906	0.313	1.875	N-08	6308
7833276	3.730	1.540	1.3750/1.3740	1.7721/1.7716	0.984	0.313	1.875	N-09	6309
7833279	4.560	1.680	1.7500/1.7490	1.9689/1.9684	1.063	0.375	2.750	N-10	6310

### Bearing Supports / End Machining - Metric Series Ball Screw

QF Standard End Machining

Standard P/N	Type QF / QF1 (mm)								Bearing Trade No.
	A	B	C	D	E	F	G	THD	
7833292	46.0	19.0	6.000/5.987	9.001/8.994	7.0	-	-	M8-1.25	609
7833282	54.0	21.0	10.000/9.987	12.006/11.999	10.0	3.0	30.0	KM-01	6201
7833283	47.0	22.0	12.000/11.984	15.006/14.999	11.0	4.0	22.0	KM-02	6202
7833284	61.0	27.0	16.000/15.984	20.007/19.997	14.0	5.0	30.0	KM-04	6204
7833285	68.0	29.0	20.000/19.980	25.008/24.996	15.0	5.0	32.0	KM-05	6205
7833286	76.0	30.0	25.000/24.980	30.007/29.997	16.0	8.0	34.0	KM-06	6206
7833287	95.0	40.0	32.000/31.976	40.010/39.997	23.0	8.0	47.0	KM-08	6308
7833288	116.0	43.0	40.000/39.977	50.010/49.997	27.0	10.0	65.0	KM-10	6310

### Bearing Supports / End Machining - Ball Splines

QF Standard End Machining

Standard P/N	Type QF / QF1 (inch)								Bearing Trade No.
	A	B	C	D	E	F	G	THD	
7833291	1.970	0.720	.2500/.2490	.3544/.3541	0.315	0.094	1.000	5/16-24	609
7833265	2.375	1.060	.6250/.6240	.7877/.7873	0.551	0.188	1.250	N-04	6204
7833270	2.970	1.160	1.0000/.9990	1.1814/1.1810	0.630	0.250	1.250	N-06	6206
7833273	3.650	1.460	1.3750/1.3740	1.5752/1.5747	0.906	0.313	1.875	N-08	6308
7833279	4.560	1.680	1.7500/1.7490	1.9689/1.9684	1.063	0.375	2.750	N-10	6310

**NOTES:**



# Engineering



## Table of Contents

<b>Description</b>	<b>Page</b>
Lead Screws.....	175
Ball Screws — Inch Series.....	179
Ball Screws — Metric Series.....	193
Ball Splines.....	203
Bearing Supports.....	207
Installation.....	209
Maintenance and Service.....	219
Lubrication.....	225
Glossary/Formulas.....	226

Need a quote or have a question about an application? Contact us in North America at:

Phone: 540-633-3400

Fax: 540-639-4162

Email: [thomson@thomsonlinear.com](mailto:thomson@thomsonlinear.com)



## Lead Screws — Engineering



Need a quote or have a question about an application? Contact us in North America at:

Phone: 800-882-8857

Email: [thomsonbsa@thomsonlinear.com](mailto:thomsonbsa@thomsonlinear.com)

Web: [www.thomsonbsa.com](http://www.thomsonbsa.com)

# Lead Screws Engineering Overview

## Precision Lead Screws & Supernuts®

### Features/Advantages

#### Low Cost

Considerable savings when compared to ball screw assemblies.

#### Variety

Largest range of leads and diameters 3/16" to 3" to match your requirements.

#### Lubrication

Internally lubricated plastic nuts will operate without lubrication. However, additional lubrication or PTFE coating of the screw is recommended to optimize efficiency and life. See page 243.

#### Vibration and Noise

No ball recirculating vibration and often less audible noise compared to ball screws.

### Design Considerations

#### Load

Supernuts provide a cost effective solution for moderate to light loads. For vertical applications, anti backlash supernuts should be mounted with thread/flange on the bottom.

#### Cantilevered Loads

Cantilevered loads that might cause a moment on the nut will cause premature failure.

#### Column Loading

Refer to column loading chart on page 196.

#### Critical Speed

Refer to critical speed chart on page 195.

#### Self-Locking

Lead screws can be self locking at low leads. Generally, the lead of the screw should be more than 1/3 of the diameter to satisfactorily backdrive.

#### Custom

Option of custom designs to fit into your design envelope.

#### Non-Corrosive\*

Stainless Steel and internally lubricated acetal.

#### Environment

Less susceptible to particulate contamination compared to ball screws.

#### Lightweight

Less mass to move.

#### Temperature

Ambient and friction generated heat are the primary causes of premature plastic nut failure. Observe the temperature limits below and discuss your design with our application engineers for continuous duty, high load and high speed applications. Thomson BSA recommends bronze nuts for very high temperature environments or can aid in your selection of high temperature plastic for a custom assembly.

#### Efficiency

Except at very high leads, efficiency increases as lead increases. Although the internally lubricated acetal provides excellent lubricity, Ball Screw Assemblies remain significantly more efficient than any Acme design.

#### Length Limitations

3/16" to 1/4"	3'
5/16" to 10mm	4'
7/16" to 5/8"	6'
>5/8"	12'

#### Lead Accuracy

Standard Grade (SRA)	.010 in/ft
Precision Grade (SPR)	.003 in/ft

Assembly		Screws	Nuts**			
Maximum Temperature	Friction Coefficient	Material	Material	Tensile Strength	Water Absorption (24 HRS %)	Thermal Expansion Coefficient
180°F	0.08 – 0.14	Stainless Steel*	Acetal with PTFE	8,000 psi	0.15	5.4 x 10-5 in. /in. /°F

\* Other materials available on a custom basis.

\*\* Plastic nuts only. See bronze nut section for information on our bronze nut products, page 32.



## Engineering Guidelines for Lead Screws

### Critical Speed Limits Chart for Lead Screws and Miniature Rolled Ball Screws

Every screw shaft has a rotational speed limit. That is the point at which the rotational speed sets up excessive vibration. This critical point is modified by the type of end bearing support used.

To use this chart, determine the required rpm and the maximum length between bearing supports. Next, select one of the four types of end support shown below. The critical speed limit can be found by locating the point at which rpm (horizontal lines) intersects with the unsupported screw length (vertical lines) as modified by the type of supports selected below. We recommend operating at no more than 80% of the critical speed limit to allow for misalignment and/or lack of screw straightness. If speed falls into dotted line, consult factory.

**Warning: Curves for the screw diameters shown are based on the smallest root (minor) diameter of the standard screws within the nominal size range and truncated at the maximum ball nut rotational speed. DO NOT EXCEED this rpm regardless of screw length.**

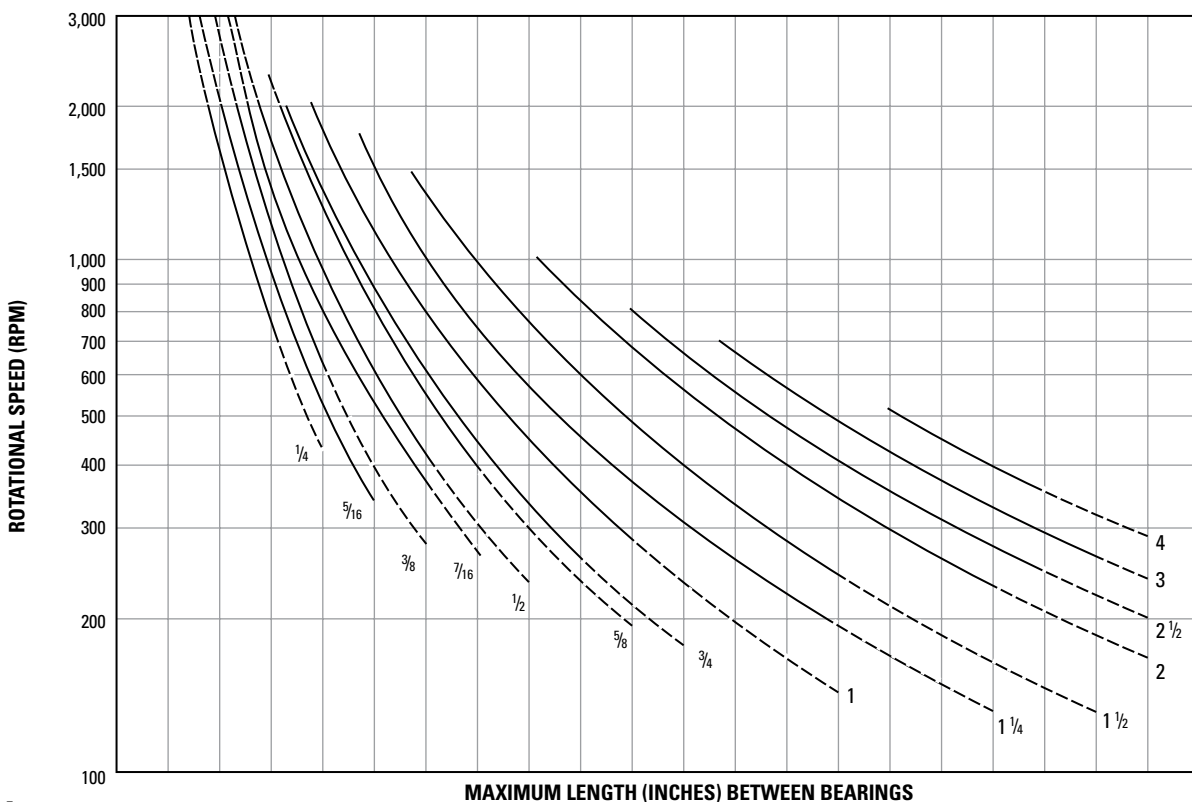

		MAXIMUM LENGTH (INCHES) BETWEEN BEARINGS																				
A	Fixed-Free	Inches	6	12	18	24	30	36	42	48	54	60	66	72	78	84	90	96	102	108	120	126
		mm	152	304	457	609	762	914	1056	1219	1371	1524	1676	1828	1981	2133	2286	2438	2590	2743	3048	3200
B	Simple-Simple	Inches	10	20	30	40	50	60	70	80	90	100	110	120	130	140	150	160	170	180	190	200
		mm	254	508	762	1016	1270	1524	1778	2032	2286	2540	2794	3048	3302	3556	3810	4064	4318	4572	4826	5080
C	Fixed-Simple	Inches	12	24	36	48	61	73	85	97	109	121	133	145	158	170	182	194	206	218	230	242
		mm	304	609	914	1219	1549	1854	2159	2463	2768	3073	3378	3683	4013	4318	4622	4927	5232	5537	5842	6146
D	Fixed-Fixed	Inches	15	30	45	60	75	90	105	119	134	149	164	179	194	209	224	239	254	269	284	298
		mm	381	762	1143	1524	1905	2286	2667	3022	3403	3784	4165	4546	4927	5308	5689	6070	6451	6832	7213	7569

# Engineering Guidelines for Lead Screws

## Column Loading Capacities Chart for Lead Screws and Miniature Rolled Ball Screws

Use the chart below to determine the Maximum Compression Load for Screw Shaft. Usually, screw operated in tension can handle loads up to the rated capacity of the nut, providing the screw length is within standard lengths. End supports have an effect on the load capacity of screws. The four standard variations are shown below with corresponding rating adjustments. Find the point of intersecting lines of load (horizontal) and length (vertical) to determine the minimum safe diameter of screw. If loads fall into dotted lines, consult factory.

**Warning: DO NOT EXCEED ball nut capacity. Curves for the screw diameters shown are based on the smallest root (minor) diameter of the standard screws within the nominal size range.**

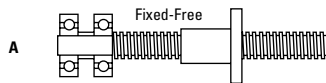
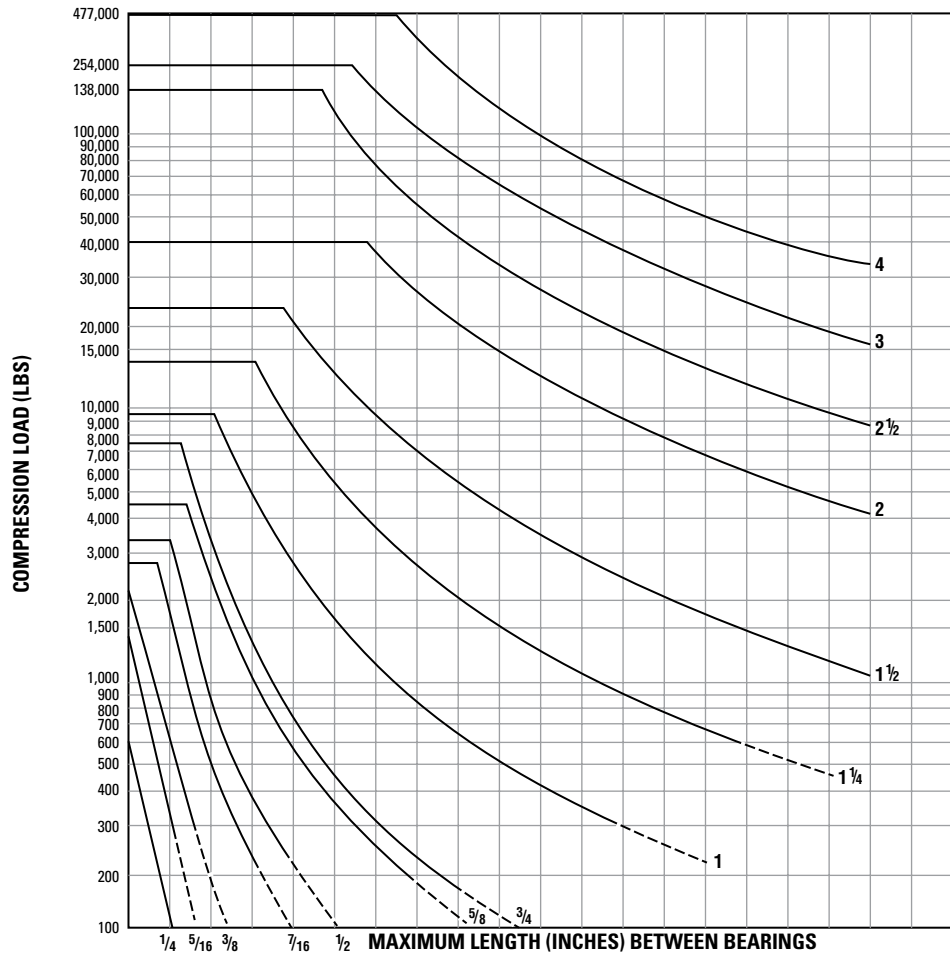

Inches	5	10	15	20	25	30	35	40	45	50	55	60	65	70	75	80	85	90	95
mm	127	254	381	508	635	762	889	1016	1143	1270	1397	1524	1651	1778	1905	2032	2159	2286	2413

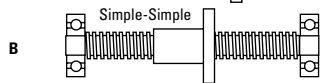

Inches	10	20	30	40	50	60	70	80	90	100	110	120	130	140	150	160	170	180	190
mm	254	508	762	1016	1270	1524	1778	2032	2286	2540	2794	3048	3302	3556	3810	4064	4318	4572	4826

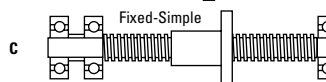

Inches	14	28	42	57	71	85	99	113	127	141	156	170	184	198	212	226	240	255	270
mm	356	711	1067	1448	1803	2159	2515	2870	3226	3581	3962	4318	4674	5029	5385	5740	6096	6477	6858

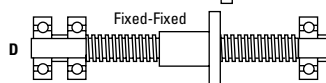

Inches	20	40	60	80	100	120	140	160	180	200	220	240	260	280	300	320	340	360	380
mm	508	1016	1524	2032	2540	3048	3556	4064	4572	5080	5588	6096	6604	7112	7620	8128	8636	9144	9652

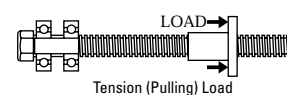
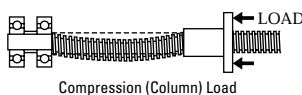

## **Ball Screws — Inch Series Engineering**



Need a quote or have a question about an application? Contact us in North America at:

Phone: 540-633-3549

Fax: 540-639-4162

Email: [thomson@thomsonlinear.com](mailto:thomson@thomsonlinear.com)

## Engineering Guidelines for Inch Series Ball Screws

### Selecting a Ball Screw Assembly for Your Application — Inch Series

A ball screw assembly is a mechanical device for translating rotational motion to linear motion. As well as being able to apply or withstand high thrust loads, they can do so with minimum internal friction. They are made to close tolerances and are therefore suitable for use in situations in which high precision is necessary. The selection of the correct ball screw assembly for a specific application is an iterative process to determine the smallest envelope and most cost-effective solution. Below is a list of the most common (but not complete) design considerations used to select a ball screw assembly.

- Compression or Tension Load
- Linear Velocity
- Positional Accuracy and Repeatability
- Required Life Expectancy
- Mounting Configuration
- Dimensional Constraints
- Input Power Requirements
- Environmental Condition

At a minimum, the design load, linear velocity, and positional accuracy should be the known inputs and are used to calculate the diameter, lead, and load capacity of the ball screw assembly. Individual ball screw components are then selected based on life, dimensional constraints, mounting configuration, and environmental conditions.

The following procedure will take you through the most common application-based selection of a ball screw assembly. As no two applications are the same, so the determination process is never the same.

1. Determine the required positional accuracy and repeatability that your application requires (page 184). Backlash is the linear independent motion between the ball screw and the ball nut and can be controlled by preloading the ball nut (page 185). The manufacturing process, rolled screws versus ground screws, dictates the accuracy (page 185).
2. Determine how you plan to mount the ball screw assembly into your machine (see page 187). The configuration of the end supports and the travel distance (Max L) will dictate the load and speed limitations of the ball screw.
3. A ball nut in tension can handle loads up to the rated capacity of the nut. For a ball nut in compression, calculate the Permissible Compression Loading (page 183) or use the Compression Loading Chart (page 191) to select a ball screw diameter that meets or exceeds your design load.
4. Calculate the lead of the ball screw that will produce the speed requirement (page 182).
5. The ball nut life can then be calculated using the Dynamic Load Rating ( $C_{am}$ ) provided in the catalog detail pages or use the Life Expectancy Charts (pages 189 or 190).
6. Every ball screw has a rotation speed limit, which is the point of excessive vibration/harmonics in the screw. The critical speed is dependent on the end support configuration. Calculate the Critical Screw Speed of the chosen ball screw (page 183) or use the Acceptable Speed Chart (page 188) to determine the critical speed.
7. If the load, life and speed calculations confirm that the selected ball screw assembly meets or exceeds the design requirements, then proceed to the next step. If not... Larger diameter screws will increase the load capacity and increase the speed rating. Smaller lead screws will decrease the linear speed (assuming constant input motor speed), increase the motor speed (assuming constant linear speed), and decrease the input torque required. Higher lead screws will increase the linear speed (assuming constant input motor speed), decrease the input motor speed (assuming constant linear speed), and increase the input torque required. Repeat steps 3 thru 5 until the correct solution is obtained.
8. Determine how the ball nut will interface into your application. A ball nut flange is the typical method of attaching the ball nut to the load. Threaded ball nuts and cylindrical ball nuts are alternative ways to provide the interface.
9. Additional design considerations and features are also available. Preloaded ball nuts are available to eliminate system backlash and increase stiffness. Wiper kits to protect the assembly from contaminants and to contain lubrication are standard on some units and optional on most others. Bearing supports and end machining are also available as options for most ball screws.
10. The final considerations are system mounting and lubrication. The ball nut should be loaded axially only as any radial loading significantly reduces the performance of the assembly (page 186). The assembly should also be properly aligned with the drive system, bearing supports, and load to achieve optimal performance and life (page 186). The ball screw assembly should never be run without proper lubrication. Many lubricants are available depending on the application and environment (page 186).

Note: Application and customer service support is available to assist in the selection of your ball screw assembly. Please contact your local Thomson representative or the customer support center (1-540-633-3549 — TCS) for any additional assistance.

### Engineering Guidelines for Inch Series Ball Screws

#### Ball Screw Assembly Selection Example:

Inputs:

Load: 30,000 lb. Compression Maximum  
10,000 lb. dynamic

Linear Speed: 200 in./min.

Input Speed: 400 rpm

Travel: 85 in.

Life:  $2 \times 10^6$  inches

#### 1. Accuracy (pages 184 and 185)

No Preload and Standard Rolled ( $\pm 0.004$  in./12 in.)

#### 2. End Supports (page 187)

Fixed/Supported

#### 3. Determine Screw Diameter

From Chart (page 191):  $\varnothing 2.000$  in.

From Equation (page 183):  $30,000 / .8 = \frac{2.0 \times 1.405 \times 10^7 \times d_r^4}{(85)^2}$

therefore,  $d_r = 1.762$  in.

#### 4. Determine Lead (page 182)

Lead =  $\frac{200 \text{ in./min.}}{400 \text{ rpm}}$  therefore, Lead = .500 in.

#### 5. Determine Life

From Catalog (page 81): Dynamic Load = 21,306 lbs.

From Equation (page 182): Life (inches) =  $\left[ \frac{21,306}{10,000} \right]^3 \times 10^6$

therefore, Life =  $9.7 \times 10^6$  inches

Verified via Chart (page 189)

#### 6. Determine Critical Speed

From Catalog (page 84): Screw Root Diameter is 1.85 in.

From Equation (page 183):  $.8 \times 1.47 \times 4.76 \times 10^6 \times \frac{d_r}{l^2}$

therefore, Speed = 1,433 rpm

Verified via Chart (page 188)

#### 7. Design Verification

OK per load, speed and life.

#### 8. Load Interface

Flanged connection preferred.

#### 9. Additional Requirements

- Wipers required
- Bearing Supports required
- End Machining needed
- Right Hand Thread
- Carbon Steel

#### 10. Mounting and Lubrication

System will require motor interface and linear rails for alignment.  
TriGel 450R

Product Selection (page 79):

Ball Nut: P/N 7833235

Ball Screw: P/N 7820600

Wiper Kit: P/N 5702659 (included)

Flange: P/N 5707574

# Engineering Guidelines for Inch Series Ball Screws

## Design Formulas

These formulas allow you to calculate a number of important factors which govern the application of Thomson ball screws.

### 1. Ball Screw Life (L)

The ball screw assembly's useful life will vary according to load and speed. Life is typically rated at 90% confidence, L10 (which represents time at which 90% of assemblies still perform).

Functional life should be determined by approximating equivalent rotational speed and loading force over typical performance cycles.

#### Simple rotational speed profile

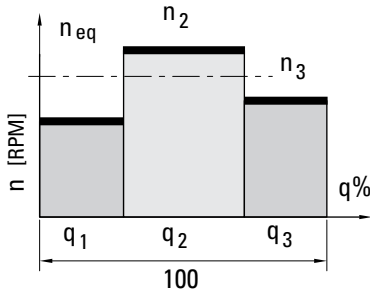

$$n_{eq} [\text{min}^{-1}] = \sum_{i=1}^n n_i \times \frac{q_i}{100}$$

#### Simple loading profile (1)

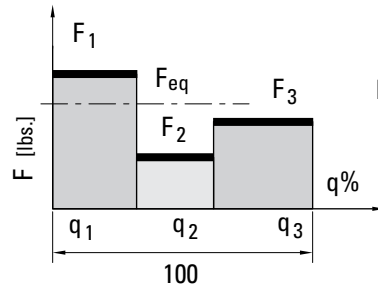

$$F_{eq} [\text{lbs.}] = \left( \sum_{i=1}^n F_i^3 \times \frac{n_i}{n_{eq}} \times \frac{q_i}{100} \right)^{1/3}$$

#### Simple loading profile (2)

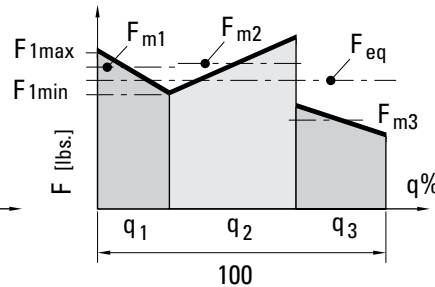

$$F_{eq} [\text{lbs.}] = \left( \sum_{i=1}^n F_{mi}^3 \times \frac{n_i}{n_{eq}} \times \frac{q_i}{100} \right)^{1/3}$$

#### Modified Life

$$L_{10} [\text{inches}] = \left[ \frac{C_{am}}{F_{eq}} \right]^3 \times 10^6$$

$$L_{h10} [\text{hours}] = \frac{L_{10}}{n_{eq} \times 60}$$

#### Parameters:

- $n_{eq}$  = Travel Rate (inches/min)
- $F_{eq}$  = equivalent operating load [lbs.]
- $C_{am}$  = dynamic load rating [lbs.]  
(see product detail pages)  
(Based on 1.0 million inches)

### 2. Rotational Speed Required for a Specific Linear Velocity

$$n = \frac{\text{Travel Rate (in. x min.}^{-1}\text{)}}{\text{Lead (in.)}} \quad n = \text{rpm}$$

### 3. Machine Service Life

After ball screw life (L) is calculated, apply it to the following formula to determine machine service life.

$$\text{Machine Service Life (in years)} = \frac{L_{h10} [\text{hours}]}{(\text{machine operating hours}) \cdot (\text{days/year}) \cdot \left( \frac{\text{ball screw operating hours}}{\text{machine operating hours}} \right)}$$

## Engineering Guidelines for Inch Series Ball Screws

### 4. Torque

$$a. \text{ Driving torque: } T_d (\text{lb}_f\text{-in.}) = \frac{F_{eq} \times P}{2\pi e} = 0.177 \times F_{eq} \times P$$

$$b. \text{ Backdrive torque: } T_b (\text{lb}_f\text{-in.}) = \frac{F_{eq} \times P \times e}{2\pi} = 0.143 \times F_{eq} \times P$$

(conversion of linear to rotational motion)

$F_{eq}$  = Equivalent Operating Load (lb<sub>f</sub>)

$P$  = Lead (in.)

$e$  = Efficiency = 0.90

$T_d$  = Driving Torque (lb<sub>f</sub>-in.)

$T_b$  = Backdrive Torque (lb<sub>f</sub>-in.)

1 lb<sub>f</sub>-in. = 0.113 (N•m)

### 5. Power

$$P_d (\text{hp}) = \frac{F_{eq} \times P}{(2\pi) e} \times \frac{n}{6.3021 \times 10^4} = \frac{F_{eq} \times P \times n}{3.564 \times 10^5}$$

$P_d$  = Power (hp)

$n$  = rpm

1 hp = 746 W

### 6. Permissible Rotational Speed

The permissible rotational speed depends on two factors: critical screw speed and critical nut speed.

#### 6a. Critical Screw Speed

The critical screw speed is related to the natural frequency of the screw shaft. Exceeding this value may result in excessive vibration. The critical screw speed may be found using the following equations or the chart on page 188.

$$n_c = C_s \times 4.76 \times 10^5 \times \frac{d_r}{l^2}$$

$n_c$  = Critical Speed (rpm)  
 $n_s$  = Safe Drive Speed  
 $d_r$  = Root Diameter (in.)  
 $l$  = Length between Bearing Supports (in.)  
 $S$  = Safety Factor (0.8 maximum)  
 $C_s$  = End Fixity Factor

$$n_s = n_c \times S$$

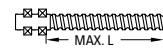
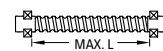
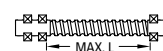
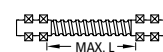
End Fixity Factor - Critical Screw Speed		
End Supports		$C_s$
A	 One end fixed, one end free	0.36
B	 Both ends supported	1.00
C	 One end fixed, one end supported	1.47
D	 Both ends fixed	2.23

#### 6b. Critical Nut Speed

The critical nut speed is related to the velocity of the ball bearings rotating around the screw shaft. Exceeding this value may result in permanent damage to the ball recirculation components. Thomson recommends a maximum DN value of 3000 for standard tube transfer designs with a lead to diameter ratio less than 2/3. Thomson recommends a maximum DN value of 5250 for high speed nuts equipped with deflectors.

$$DN = d_0 n$$

where

$d_0$  = nominal shaft diameter (in)

$n$  = rotational speed of shaft (rpm)

### 7. Permissible Compression Loading

Exceeding the recommended maximum compression force may result in buckling of the screw shaft.

$$F_c = \frac{C_s \times 1.405 \times 10^7 \times d_r^4}{l^2}$$

$F_c$  = Critical Buckling Force (lbs.)  
 $F_s$  = Safe Compression Force (lbs.)  
 $d_r$  = Root Diameter (in.)  
 $l$  = Max Unsupported Length (in.)  
 $S$  = Safety Factor (0.8 maximum)  
 $C_s$  = End Fixity Factor

$$F_s = F_c \times S$$

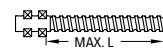
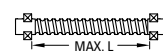
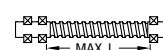
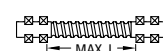
End Fixity Factor - Permissible Compression Loading		
End Supports		$C_s$
A	 One end fixed, one end free	0.25
B	 Both ends supported	1.00
C	 One end fixed, one end supported	2.00
D	 Both ends fixed	4.00

# Engineering Guidelines for Inch Series Ball Screws

## Accuracy Classes

Accuracy is a measure of how closely a motion system will approach a command position. Perfect accuracy, for example, means that advancing a ball nut a precise amount from a given point on the screw always requires exactly the theoretically predicted number of revolutions.

Inch ball screws are produced in two main tolerance classes: Precision and Precision Plus. Precision grade ball screws are used in applications requiring only coarse movement or those utilizing linear feedback for position location. As such, most Precision grade screws are provided with nuts having backlash. Precision Plus grade ball screws are used where repeatable positioning within microns is critical, without the use of a linear feedback device.

Differences between Precision and Precision Plus grades are highlighted in the graph. Precision grade screws allow greater cumulative variation over the useful length of the screw. Precision Plus grade screws contain accumulation of lead error to provide precise positioning over the screw's entire useful length.

### Precision Plus Ball Screws

Maximum error over useful length =  $e_p + 1/2V_{up} + C$

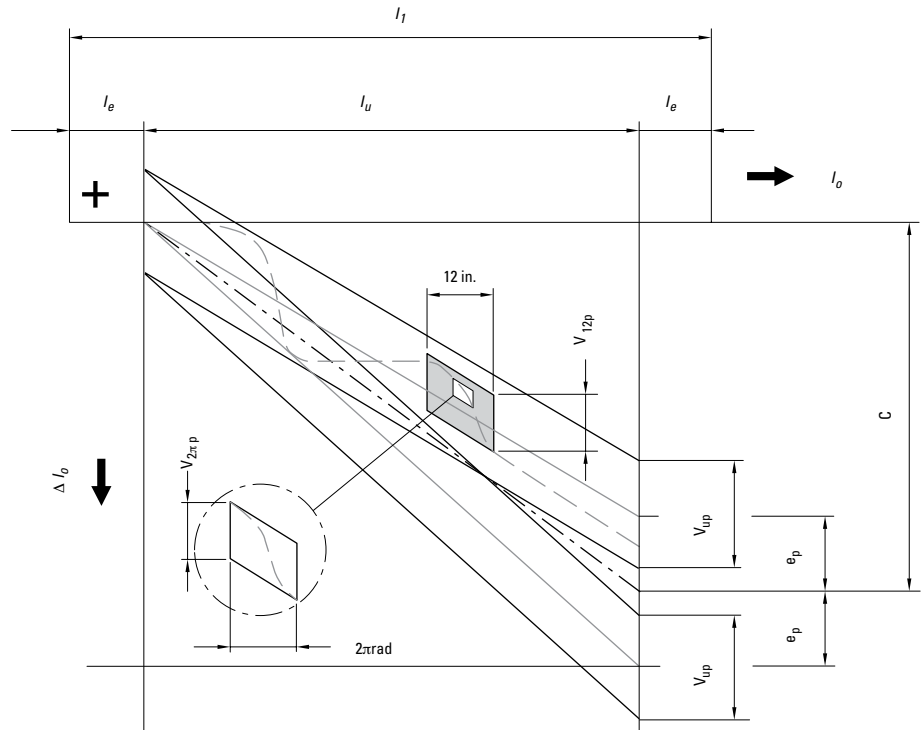

### Precision Ball Screws

Maximum error over useful length =  $e_p$

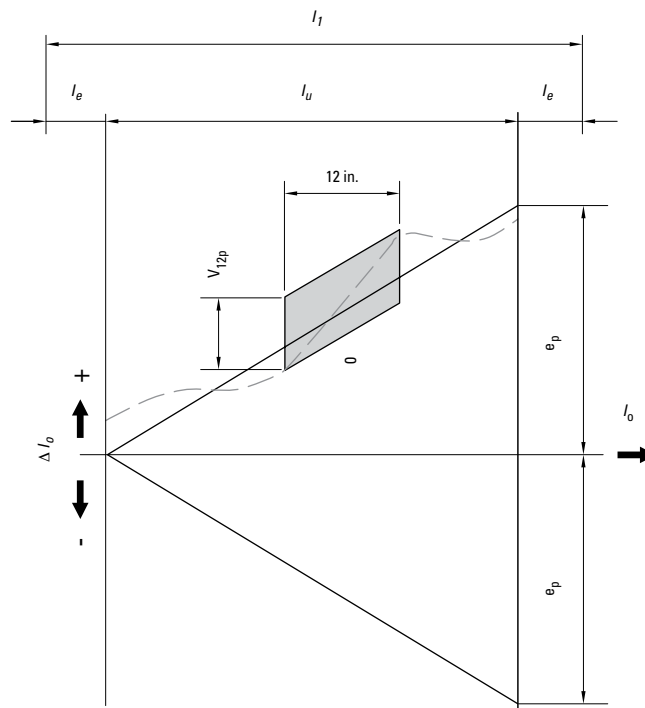

- $I_o$  = nominal travel
- $I_1$  = thread length
- $I_o$  = travel deviation
- $I_u$  = useful travel
- $I_e$  = excess travel
- $C$  = travel compensation for useful travel (std. = 0)
- $e_p$  = tolerance for actual mean travel deviation (the difference between the maximum and minimum values of the permissible actual mean travel)
- $V_{up}$  = permissible travel variation within useful travel,  $I_u$
- $V_{12p}$  = permissible travel deviation within 12 inch travel
- $V_{2\pi p}$  = permissible travel deviation within 1 revolution



## Engineering Guidelines for Inch Series Ball Screws

### Permissible Travel Variation Over Usable Length

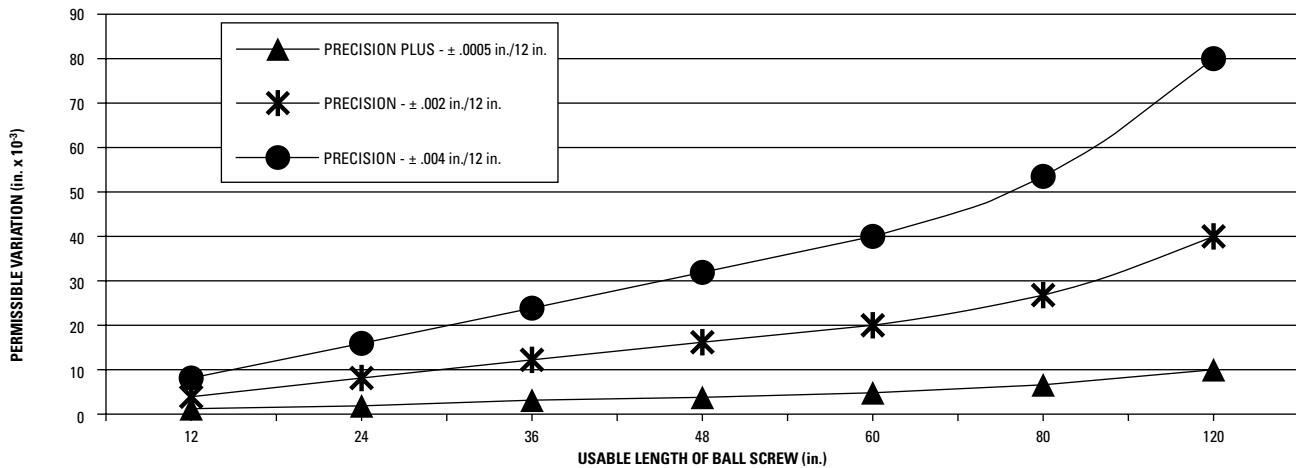

Tolerance Class	Lead Accuracy $V_{300p}$	Permissible Travel Deviation $V_{up}$ (in. x $10^{-3}$ ) Over Screw Length $l_u$ (in.)							
		$l_u =$	12	24	36	48	60	80	120
Precision Plus*	±.0005 in./12 in.	$V_{up}$ (in.)	1	2	3	4	5	6.67	10
Precision	±.002 in./12 in.	$V_{up}$ (in.)	4	8	12	16	20	26.7	40
Precision*	±.004 in./12 in.	$V_{up}$ (in.)	8	16	24	32	40	53.3	80

\* Standard product tolerances

### Preload Types

#### Skip-Lead Preload

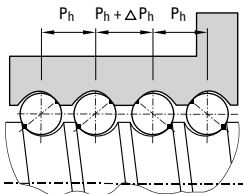

- The lead is offset within the ball nut to provide a precise preload.
- Typically used where both repeatability and high stiffness are required.

#### Double-Nut Adjustable Preload

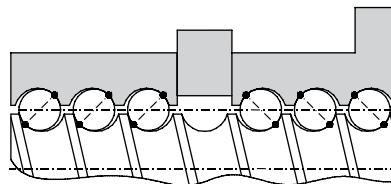

- A compression spring is used to axially load two ball nuts against each other.
- Typically used for positioning applications where repeatability is critical.

#### No Preload

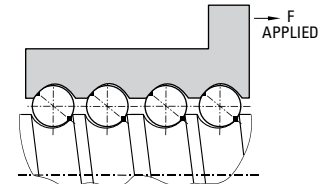

- Axial play is present between screw and nut (typically .002"-.008" depending on size).
- Typically used for transport or vertical applications.

## Engineering Guidelines for Inch Series Ball Screws

### Lubrication Guidelines

Ball screws must be lubricated to operate properly and achieve the rated life. We recommend using TriGEL-450R or TriGEL-1800RC for lubricating ball screws. Other oils and greases may be applicable but have not been evaluated.

The TriGEL grease can be applied directly to the screw threads near the root of the ball track. Some ball nut sizes are available with threaded lube holes for mounting lubrication fittings. For these ball nuts, the TriGEL grease can be pumped directly into the nut. Please refer to the catalog detail views to verify which ball nuts have the threaded lube holes. It is recommended to use these nuts in conjunction with a wiper kit to contain the lubricant in the body of the nut.

Ball screws may require lubrication frequently depending on both environmental and operating conditions. If the lubricant appears to be dispersed before this point or has become dry or crusted, the maintenance

interval should be reduced. Before adding additional grease, wipe the screw clean, removing the old grease and any particulate

contamination seen on the screw. If oil is being used, the best results may be obtained by utilizing a continuous-drip type applicator.



### Nut Loading

Axial loading (on nut or screw) is optimal for performance and life. For applications requiring radial loads, please contact us.

Axial Loading: optimal

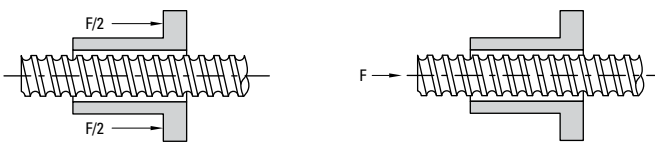

Radial Loading: detrimental\*

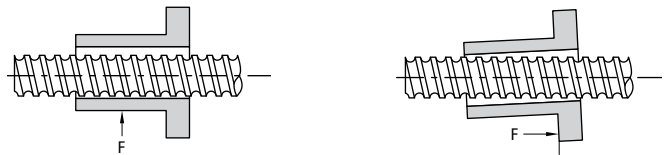

\* Minimize radial loading to less than 5% of the axial load.

### Nut Mounting

Use the following guidelines to achieve optimal performance

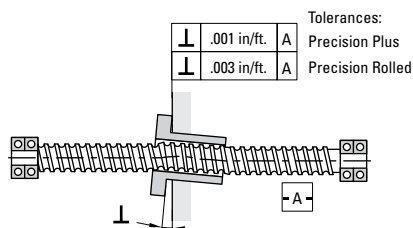
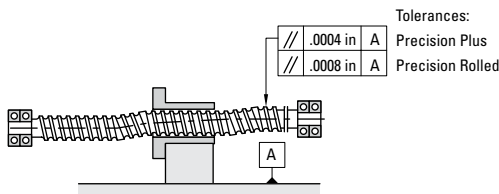

## Engineering Guidelines for Inch Series Ball Screws

### Bearing Support Reference Drawings (End Fixity)

**Critical Speed** — That condition where the rotary speed of the assembly sets up harmonic vibrations. (Refer to Figure 1.) These vibrations are the result of shaft diameter, unsupported length, type of bearing support, position of the ball nut in the stroke, how the ball nut is mounted, the shaft or ball nut rpm, etc. (Note: Shaft vibrations may also be caused by a bent screw or faulty installation alignment.) The four end fixity drawings (A, B, C, and D) show the bearing configurations for supporting a rotating shaft. The selection chart for Travel Rate vs. Length on page 188, shows these same configurations at the bottom of the chart and factors in their effect on critical shaft speed for the unsupported screw length.

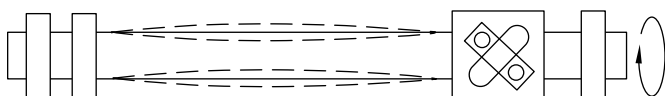
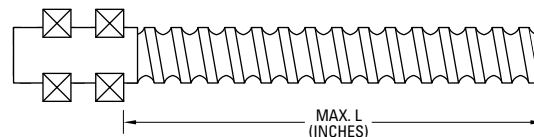

Figure 1

### Bearing Support vs. Speed (travel rate or rpm)

A – One end fixed, other end free



B – Both ends supported

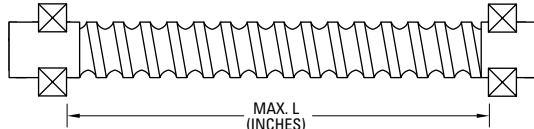

C – One end fixed, other end supported

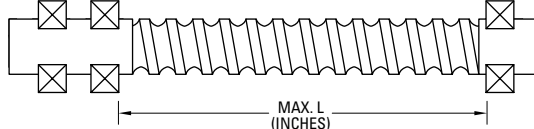

D – Both ends fixed

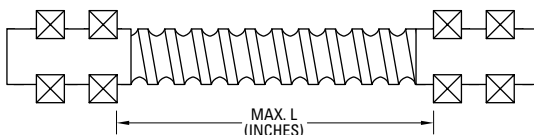

**Tension Loads** — Those loads where the force pulls on the bearing and its support. (Refer to Figure 2.) Where practical, applications should be designed to function with the load in tension to achieve the widest possible selection of screw sizes. Ball screws operating in both tension and compression may be preloaded between the support bearings or mounted per the guidelines under Compression Loads.

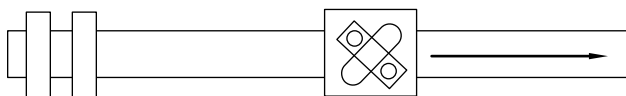

Figure 2

**Compression Loads** — Those loads where the force pushes on the bearing and its support. (Refer to Figure 3.) Compression loads tend to cause the screw shaft to bend. This normally requires a ball screw with a larger diameter than one for tension loading only. The four end fixity drawings (A, B, C and D) show the bearing configurations for supporting a shaft subject to compression loads. The selection chart for Compression Load vs. Length, on page 191, shows these same configurations at the bottom of the chart and factors in their effect on the unsupported length of the screw for compression loads.

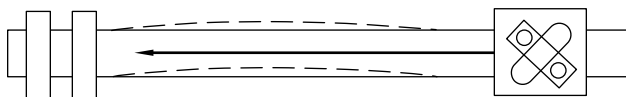
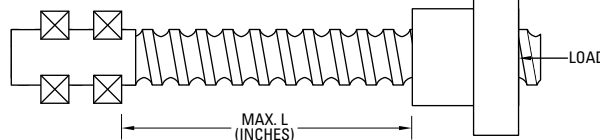

Figure 3

### Bearing Support vs. Compression Load on Screws

A – One end fixed, other end free



B – Both ends supported

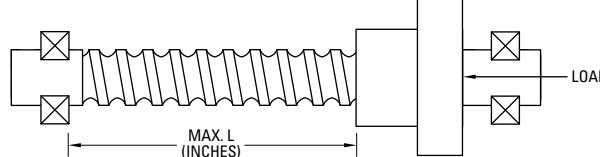

C – One end fixed, other end supported

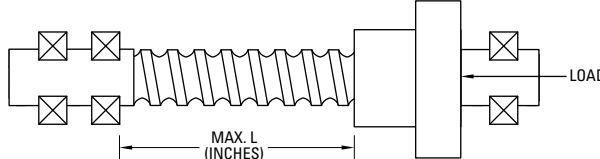

D – Both ends fixed

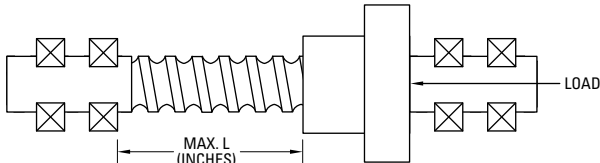

# Engineering Guidelines for Inch Series Ball Screws

## Acceptable Speed† vs. Length for Screws

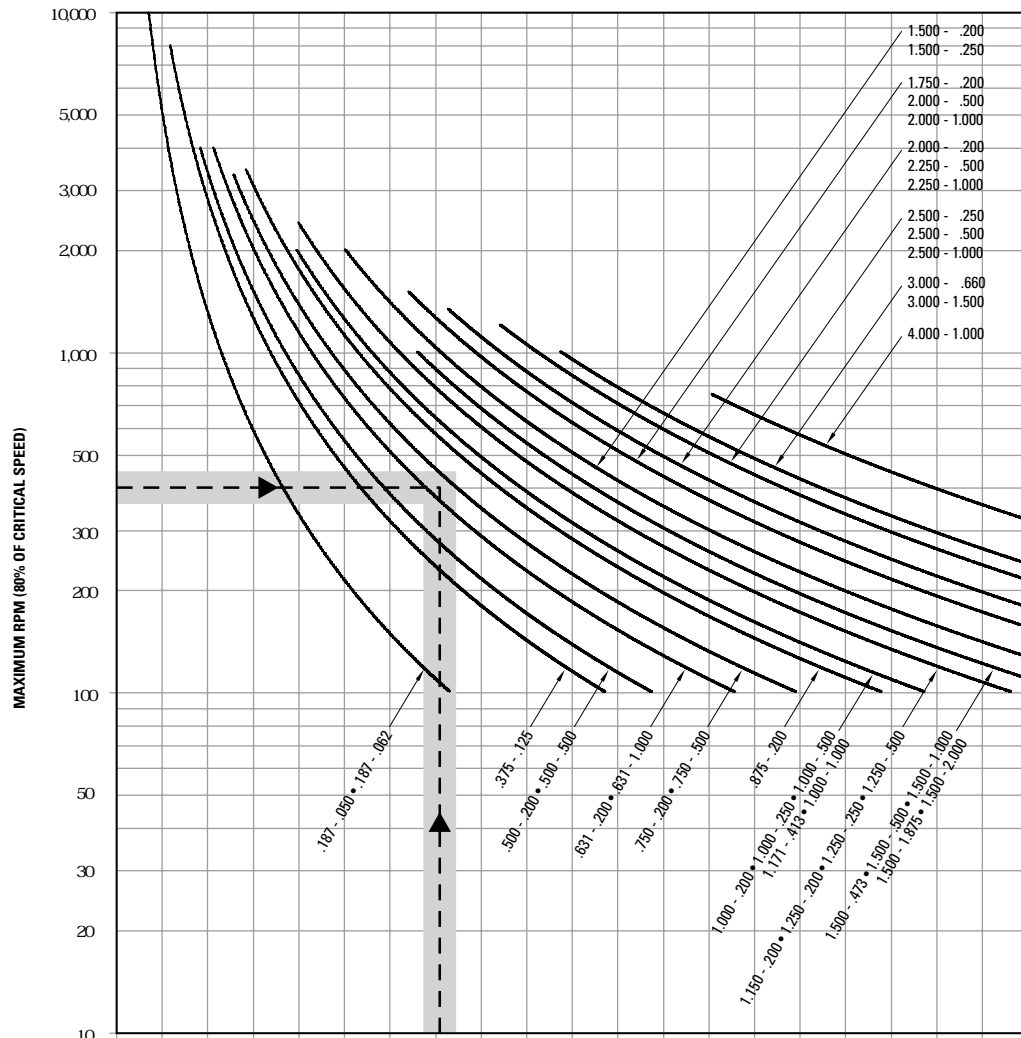

**END SUPPORT TYPE**

Support Type	Diagram	Inches	6	12	18	24	30	36	42	48	54	60	66	72	78	84	90	96	102	108	114	120
A	One end fixed, other end free	mm	152	304	457	609	762	914	1066	1219	1371	1524	1676	1828	1981	2133	2286	2438	2590	2743	2895	3048
B	Both ends supported	Inches	10	20	30	40	50	60	70	80	90	100	110	120	130	140	150	160	170	180	190	200
		mm	254	508	762	1016	1270	1524	1778	2032	2286	2540	2794	3048	3302	3556	3810	4064	4318	4572	4826	5080
C	One end fixed, other end supported	Inches	12	24	36	48	61	73	85	97	109	121	133	145	158	170	182	194	206	218	230	242
		mm	304	609	914	1219	1549	1854	2159	2463	2768	3073	3378	3683	4013	4318	4622	4927	5232	5537	5842	6146
D	Both ends fixed	Inches	15	30	45	60	75	90	105	119	134	149	164	179	194	209	224	239	254	269	284	298
		mm	381	762	1143	1524	1905	2286	2667	3022	3403	3784	4165	4546	4927	5308	5689	6070	6451	6832	7213	7594

Example: Travel rate of 400 rpm.  
 Unsupported length of 85 in. (2159mm).  
 End fixity of one end fixed, other end supported.

All screws with curves which pass through or above and to the right of the plotted point are suitable for the example. The acceptable velocities shown by this graph apply to the screw shaft selected and are not indicative of the velocities attainable of all of the associated ball nut assemblies. Consult Thomson engineering for high speed applications.

†80% of critical speed

# Engineering Guidelines for Inch Series Ball Screws

## Life Expectancy for Precision Ball Screw Assemblies

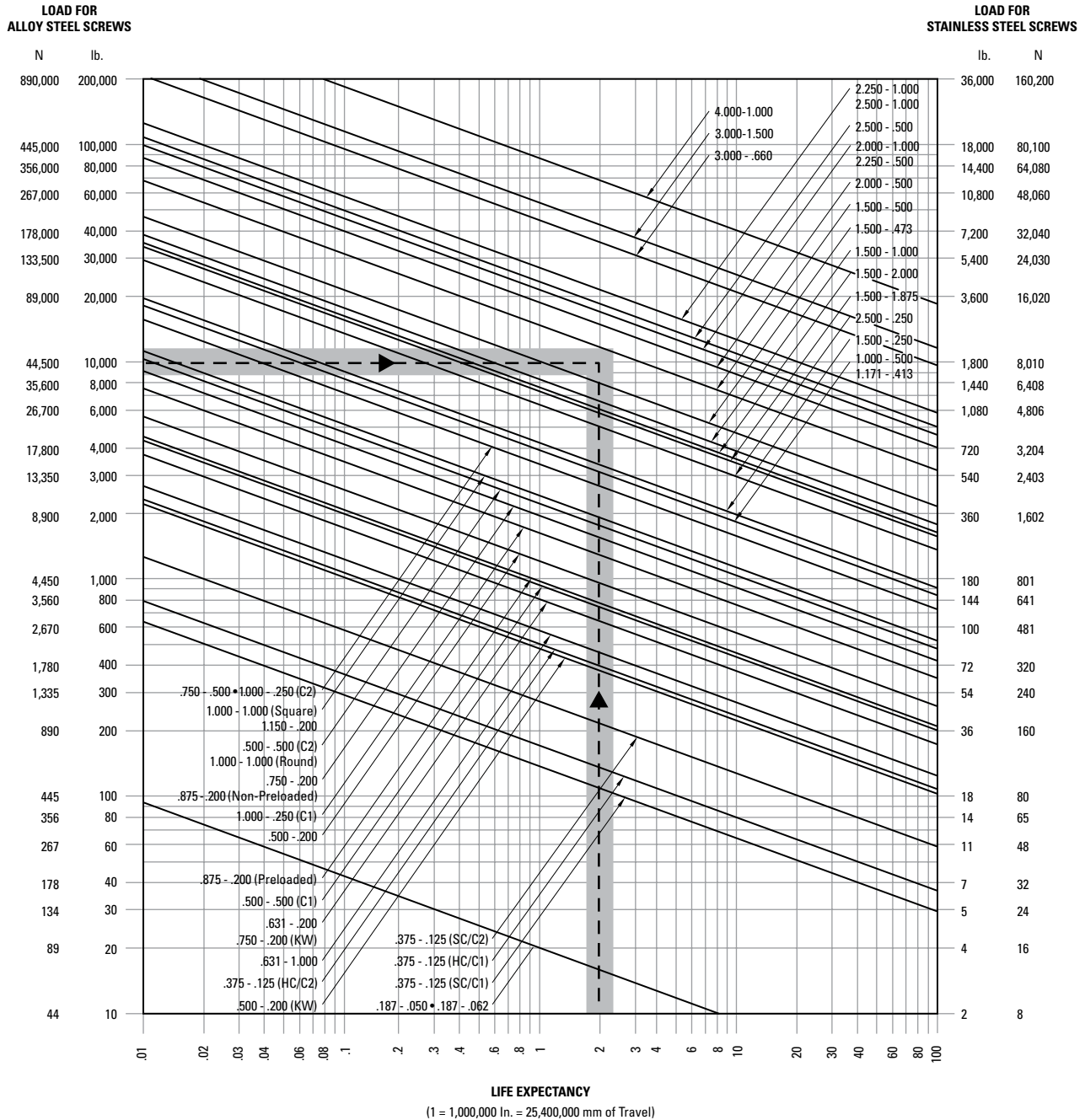

C1 = Single Circuit      C2 = Double Circuit      SC = Standard Capacity      HC = High Capacity

Example: Application life expectancy (total travel) desired is 2 million in. (50.8 million mm).

Normal operating load is 10,000 lb. (44,500 N).

All screws with curves which pass through or are above and to the right of the plotted point are suitable for the example. The suitable dynamic life expectancies shown in this graph are not to exceed the maximum static load capacity as given in the rating table for the individual ball nut assembly.

# Engineering Guidelines for Inch Series Ball Screws

## Life Expectancy for Precision Plus Preloaded Ball Screw Assemblies

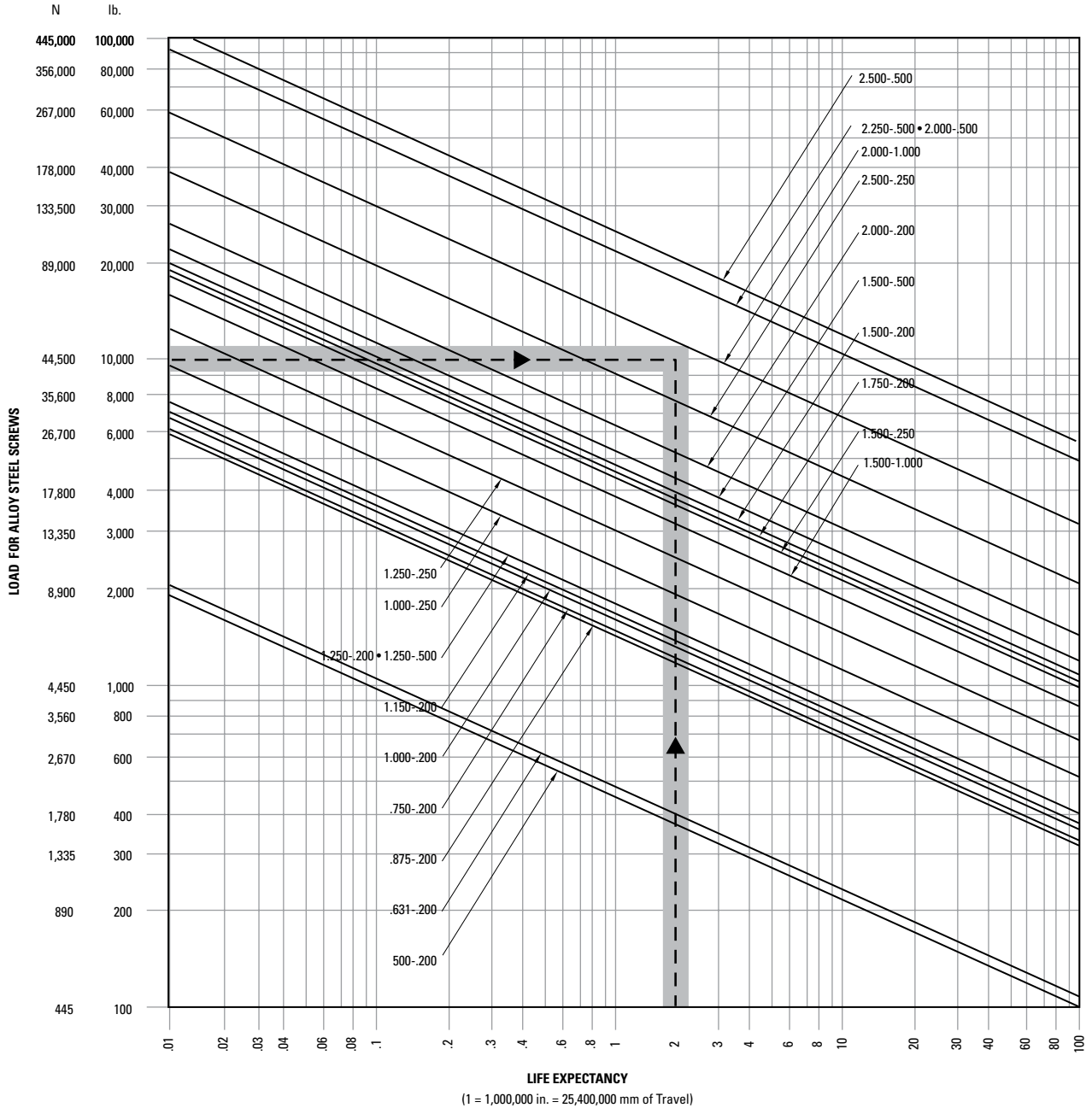

Example: Application life expectancy (total travel) desired is 2 million in. (50.8 million mm).  
Normal operating load is 10,000 lb. (44,500 N).

All screws with curves which pass through or are above and to the right of the plotted point are suitable for the example. The suitable dynamic life expectancies shown in this graph are not to exceed the maximum static load capacity as given in the rating table for the individual ball nut assembly.

## Engineering Guidelines for Inch Series Ball Screws

### Compression Load vs. Length for Designated Ball Screws

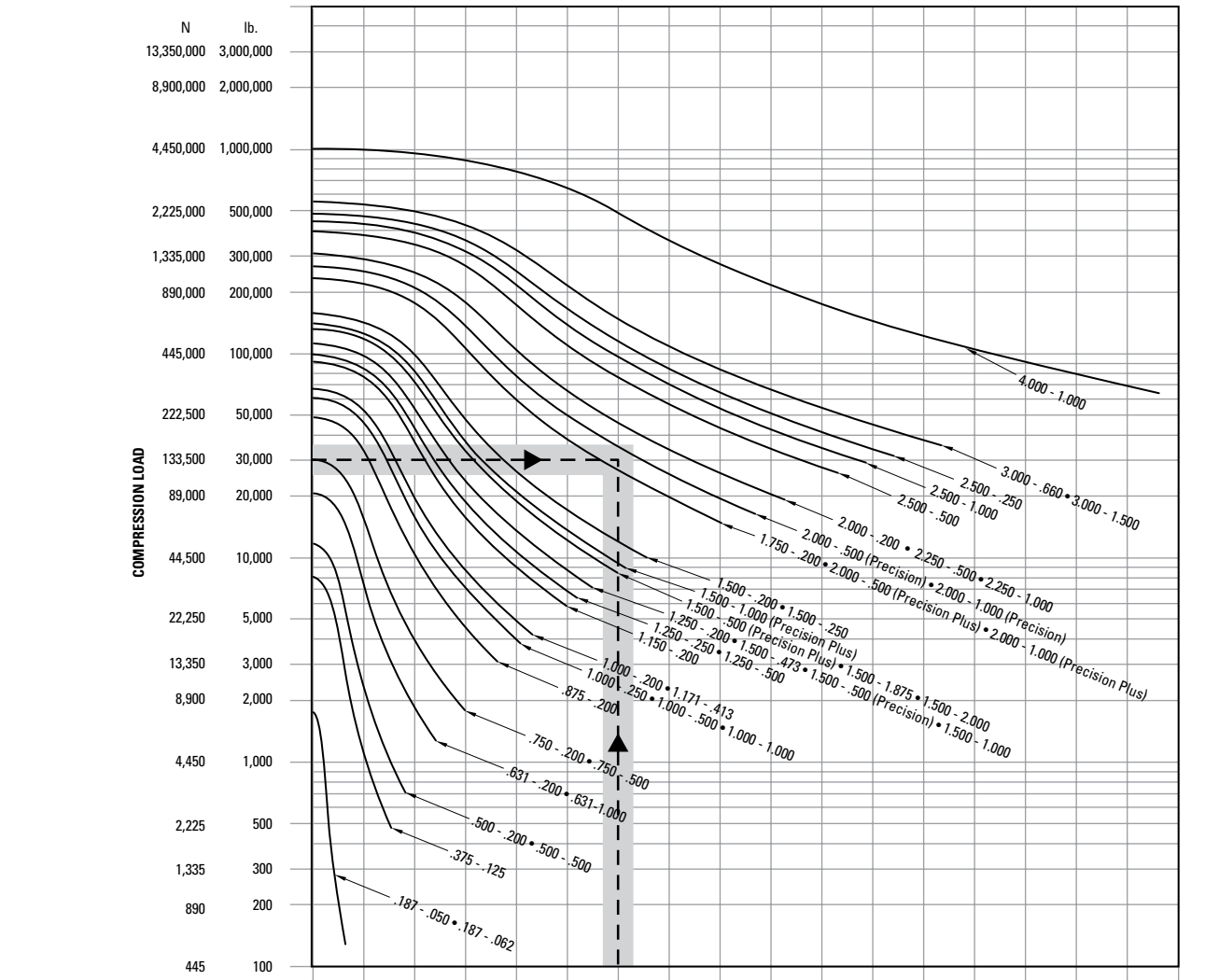

**END SUPPORT TYPE**

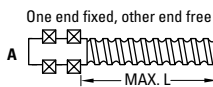

Inches	5	10	15	20	25	30	35	40	45	50	55	60	65	70	75	80	85
mm	127	254	381	508	635	762	889	1016	1143	1270	1397	1524	1651	1778	1905	2032	2159

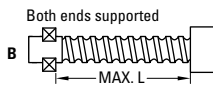

Inches	10	20	30	40	50	60	70	80	90	100	110	120	130	140	150	160	170
mm	254	508	762	1016	1270	1524	1778	2032	2286	2540	2794	3048	3302	3556	3810	4064	4318

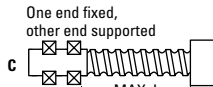

Inches	14	28	42	57	71	85	99	113	127	141	156	170	184	198	212	226	240
mm	356	711	1067	1448	1803	2159	2515	2870	3226	3581	3962	4318	4674	5029	5385	5740	6096

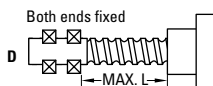

Inches	20	40	60	80	100	120	140	160	180	200	220	240	260	280	300	320	340
mm	508	1016	1524	2032	2540	3048	3556	4064	4572	5080	5588	6096	6604	7112	7620	8128	8636

Example: Maximum system load is 30,000 lb. (133,500 N).  
Length of 85 in. (2159mm).  
End fixity of one end fixed, other end supported.

All screws with curves which pass through or above and to the right of the plotted point are suitable for the example.

The suitable compression loads shown in this graph are not to exceed the maximum static load capacity as given in the rating table for the individual ball nut assembly.

**NOTES:**





## **Ball Screws — Metric Series Engineering**



Need a quote or have a question about an application? Contact us in North America at:

Phone: 540-633-3549

Fax: 540-639-4162

Email: [thomson@thomsonlinear.com](mailto:thomson@thomsonlinear.com)

## Engineering Guidelines for Metric Series Ball Screws

### Selecting a Ball Screw Assembly for Your Application — Metric Series

A ball screw assembly is a mechanical device for translating rotational motion to linear motion. As well as being able to apply or withstand high thrust loads, they can do so with minimum internal friction. They are made to close tolerances and are therefore suitable for use in situations in which high precision is necessary. The selection of the correct ball screw assembly for a specific application is an iterative process to determine the smallest envelope and most cost-effective solution. Below is a list of the most common (but not complete) design considerations used to select a ball screw assembly.

- Compression or Tension Load
- Linear Velocity
- Positional Accuracy and Repeatability
- Required Life Expectancy
- Mounting Configuration
- Dimensional Constraints
- Input Power Requirements
- Environmental Condition

At a minimum, the design load, linear velocity, and positional accuracy should be the known inputs and are used to calculate the diameter, lead, and load capacity of the ball screw assembly. Individual ball screw components are then selected based on life, dimensional constraints, mounting configuration, and environmental conditions.

The following procedure will take you through the most common application-based selection of a ball screw assembly. As no two applications are the same, so the determination process is never the same.

1. Determine the required positional accuracy and repeatability that your application requires (page 198). Backlash is the linear independent motion between the ball screw and the ball nut and can be controlled by preloading the ball nut (page 199). The manufacturing process, rolled screws versus ground screws, dictates the accuracy (page 199).
2. Determine how you plan to mount the ball screw assembly into your machine (see page 187). The configuration of the end supports and the travel distance (Max L) will dictate the load and speed limitations of the ball screw.
3. A ball nut in tension can handle loads up to the rated capacity of the nut. For a ball nut in compression, calculate the Permissible Compression Loading (page 197) or use the Compression Loading Chart (page 202) to select a ball screw diameter that meets or exceeds your design load.
4. Calculate the lead of the ball screw that will produce the speed requirement (page 196).
5. The ball nut life can then be calculated using the Dynamic Load Rating ( $C_{am}$ ) provided in the catalog detail pages. Since multiple ball nuts may be available for a given diameter and lead, use the chart on page 105 to select available styles.
6. Every ball screw has a rotation speed limit, which is the point of excessive vibration/harmonics in the screw. The critical speed is dependent on the end support configuration. Calculate the Critical Screw Speed of the chosen ball screw (page 197) or use the Acceptable Speed Chart (page 201) to determine the critical speed.
7. If the load, life and speed calculations confirm that the selected ball screw assembly meets or exceeds the design requirements, then proceed to the next step. If not... Larger diameter screws will increase the load capacity and increase the speed rating. Smaller lead screws will decrease the linear speed (assuming constant input motor speed), increase the motor speed (assuming constant linear speed), and decrease the input torque required. Higher lead screws will increase the linear speed (assuming constant input motor speed), decrease the input motor speed (assuming constant linear speed), and increase the input torque required. Repeat steps 3 thru 5 until the correct solution is obtained.
8. Determine how the ball nut will interface into your application. A ball nut flange is the typical method of attaching the ball nut to the load. Threaded ball nuts and cylindrical ball nuts are alternative ways to provide the interface.
9. Additional design considerations and features are also available. Preloaded ball nuts are available to reduce system backlash and increase positional accuracy. Wiper kits to protect the assembly from contaminants and to contain lubrication are standard on some units and optional on most others. Bearing supports and end machining are also available as options for all ball screws.
10. The final considerations are system mounting and lubrication. The ball nut should be loaded axially only as any radial loading significantly reduces the performance of the assembly (page 200). The assembly should also be properly aligned with the drive system, bearing supports, and load to achieve optimal performance (page 200). The ball screw assembly should never be run without proper lubrication. Many lubricants are available depending on the application and environment (page 200).

Note: Application and customer service support is available to assist in the selection of your ball screw assembly. Please contact your local Thomson representative or the customer support center (1-540-633-3549 — TCS) for any additional assistance.

## Engineering Guidelines for Metric Series Ball Screws

### Ball Screw Assembly Selection Example:

Inputs:

Load: 133,440 N Compression Maximum

44,480 N dynamic

Linear Speed: 5.08 meter/min.

Input Speed: 400 rpm

Travel: 2159 mm

Life:  $2.5 \times 10^4$  meters

#### 1. Accuracy (pages 198 and 199)

No Preload and Standard Rolled ( $\pm 50 \mu\text{m}$  per 300mm)

#### 2. End Supports (page 187)

Fixed/Supported

#### 3. Determine Screw Diameter

From Chart (page 202):  $\varnothing 50\text{mm}$

From Equation (page 197):  $133,440 / .8 = \frac{1.47 \times 9.687 \times 10^4 \times d_r^4}{(2159)^2}$

therefore,  $d_r = 44.8\text{mm}$

#### 4. Determine Lead (pages 196 and 105)

Lead =  $\frac{5.08 \text{ meter/min.}}{400 \text{ rpm}}$  therefore, Lead = 12.7mm, Use 10mm

#### 5. Determine Life

From Catalog (page 118): Dynamic Load = 66,400 N

Life (revolutions) =  $\left[ \frac{66,400}{44,480} \right]^3 \times 10^6$

therefore, Life =  $3.3 \times 10^6$  revs ( $3.3 \times 10^4$  meters)

#### 6. Determine Critical Speed

From Catalog (page 118): Screw Root Diameter is 43.0mm

From Equation (page 197):  $.8 \times 1.47 \times 1.2 \times 10^6 \times \frac{d_r}{l^2}$

therefore, Speed = 1,301.8 rpm

Verified via Chart (page 201)

#### 7. Design Verification

OK per load, speed and life.

#### 8. Load Interface

Flanged connection preferred.

#### 9. Additional Requirements

- Wipers required
- Bearing Supports required
- End Machining needed
- Right Hand Thread
- Carbon Steel

#### 10. Mounting and Lubrication

System will require motor interface and linear rails for alignment.  
TriGel 450R

Product Selection (page 118):

Ball Nut: P/N 7832818

Ball Screw: P/N 7832817-P5

# Engineering Guidelines for Metric Series Ball Screws

## Design Formulas

These formulas allow you to calculate a number of important factors which govern the application of Thomson ball screws.

### 1. Ball Screw Life (L)

The ball screw assembly's useful life will vary according to load and speed. Life is typically rated at 90% confidence, L10 (which represents time at which 90% of assemblies still perform).

Functional life should be determined by approximating equivalent rotational speed and loading force over typical performance cycles.

#### Simple rotational speed profile

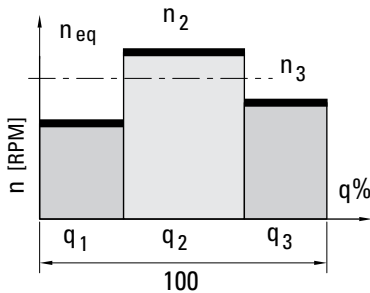

$$n_{eq} [\text{min}^{-1}] = \sum_{i=1}^n n_i \times \frac{q_i}{100}$$

#### Simple loading profile (1)

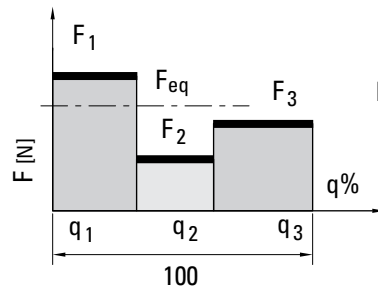

$$F_{eq} [N] = \left( \sum_{i=1}^n F_i^3 \times \frac{n_i}{n_{eq}} \times \frac{q_i}{100} \right)^{1/3}$$

#### Simple loading profile (2)

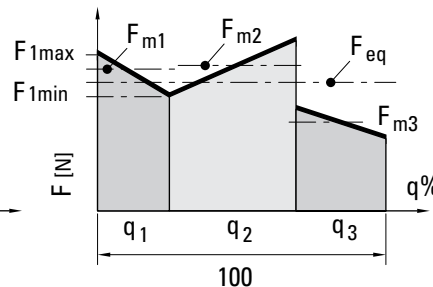

$$F_{eq} [N] = \left( \sum_{i=1}^n F_{mi}^3 \times \frac{n_i}{n_{eq}} \times \frac{q_i}{100} \right)^{1/3}$$

#### Modified Life

$$L_{10} [\text{revolutions}] = \left[ \frac{C_{am}}{F_{eq}} \right]^3 \times 10^6$$

$$L_{h10} [\text{hours}] = \frac{L_{10}}{n_{eq} \times 60}$$

#### Parameters:

- $n_{eq}$  = equivalent operating rotational speed [rpm]
- $F_{eq}$  = equivalent operating load [N]
- $C_{am}$  = dynamic load rating [N] (see specification tables) (Based on 1.0 million revolutions)

### 2. Rotational Speed Required for a Specific Linear Velocity

$$n = \frac{\text{Travel Rate (mm x min.}^{-1}\text{)}}{\text{Lead (mm)}}$$

$n = \text{rpm}$

### 3. Machine Service Life

After ball screw life (L) is calculated, apply it to the following formula to determine machine service life.

$$\text{Machine Service Life (in years)} = \frac{L_{h10} [\text{hours}]}{(\text{machine operating hours}) \cdot (\text{days/year}) \cdot \left( \frac{\text{ball screw operating hours}}{\text{machine operating hours}} \right)}$$

## Engineering Guidelines for Metric Series Ball Screws

### 4. Torque

$$a. \text{ Driving torque: } T_d (\text{N}\cdot\text{m}) = \frac{F_{eq} \times P}{2\pi e} = 1.77 \times 10^{-4} \times F_{eq} \times P$$

$$b. \text{ Backdrive torque: } T_b (\text{N}\cdot\text{m}) = \frac{F_{eq} \times P \times e}{2\pi} = 1.43 \times 10^{-4} \times F_{eq} \times P$$

(conversion of linear to rotational motion)

$F_{eq}$  = Equivalent Operating Load (N)

$P$  = Lead (mm)

$e$  = Efficiency = 0.90

$T_d$  = Driving Torque (N•m)

$T_b$  = Backdrive Torque (N•m)

1 lb-in. = 0.113 N•m

### 5. Power

$$P_d (\text{W}) = \frac{F_{eq} \times P}{(2\pi) e} \times \frac{n}{9.546 \times 10^3} = \frac{F_{eq} \times P \times n}{5.398 \times 10^4}$$

$P_d$  = Power (W)

$n$  = rpm

1 hp = 746 W

### 6. Permissible Rotational Speed

The permissible rotational speed depends on two factors: critical screw speed and critical nut speed.



#### 6a. Critical Screw Speed

The critical screw speed is related to the natural frequency of the screw shaft. Exceeding this value may result in excessive vibration. The critical screw speed may be found using the following equations or the chart on page 201.

$$n_c = C_s \times 1.2 \times 10^6 \times \frac{d_r}{l^2}$$

$n_c$  = Critical Speed (rpm)  
 $n_s$  = Safe Drive Speed  
 $d_r$  = Root Diameter (mm)  
 $l$  = Length between Bearing Supports (mm)  
 $S$  = Safety Factor (0.8 maximum)  
 $C_s$  = End Fixity Factor

$$n_s = n_c \times S$$

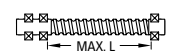
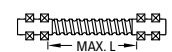
End Fixity Factor - Critical Screw Speed		
End Supports		$C_s$
A	 One end fixed, one end free	0.36
B	 Both ends supported	1.00
C	 One end fixed, one end supported	1.47
D	 Both ends fixed	2.23

#### 6b. Critical Nut Speed

The critical nut speed is related to the velocity of the ball bearings rotating around the screw shaft. Exceeding this value may result in permanent damage to the ball recirculation components. Thomson recommends a maximum DN value of 140,000 for standard internal transfer designs, which encompass the majority of the Metric products. Higher values may be accommodated by special design (consult with applications engineering).

$$DN = d_0 n$$

where

$d_0$  = nominal shaft diameter (mm)

$n$  = rotational speed of shaft (rpm)

### 7. Permissible Compression Loading

Exceeding the recommended maximum compression force may result in buckling of the screw shaft.

$$F_c = \frac{C_s \times 9.687 \times 10^4 \times d_r^4}{l^2}$$

$F_c$  = Critical Buckling Force (N)  
 $F_s$  = Safe Compression Force (N)  
 $d_r$  = Root Diameter (mm)  
 $l$  = Max Unsupported Length (mm)  
 $S$  = Safety Factor (0.8 maximum)  
 $C_s$  = End Fixity Factor

$$F_s = F_c \times S$$

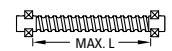
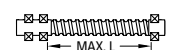
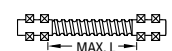
End Fixity Factor - Permissible Compression Loading		
End Supports		$C_s$
A	 One end fixed, one end free	0.25
B	 Both ends supported	1.00
C	 One end fixed, one end supported	2.00
D	 Both ends fixed	4.00

# Engineering Guidelines for Metric Series Ball Screws

## Accuracy Classes

Accuracy is a measure of how closely a motion system will approach a command position. Perfect accuracy, for example, means that advancing a ball nut a precise amount from a given point on the screw always requires exactly the theoretically predicted number of revolutions.

Metric ball screws are produced in two main tolerance classes: T (transport) and P (positioning). Transport grade ball screws are used in applications requiring only coarse movement or those utilizing linear feedback for position location. As such, most transport grade screws are provided with nuts having backlash (T7 grade screws cannot be supplied with preloaded nuts). Precision grade ball screws are used where repeatable positioning within microns is critical, without the use of a linear feedback device.

Differences between P & T grades are highlighted in the graph. T grade transport screws allow greater cumulative variation over the useful length of the screw. P grade positioning screws contain accumulation of lead error to provide precise positioning over the screw's entire useful length.

### P — Positioning Class Ball Screws

$$\text{Maximum error over useful length} = e_p + 1/2V_{up} + C$$

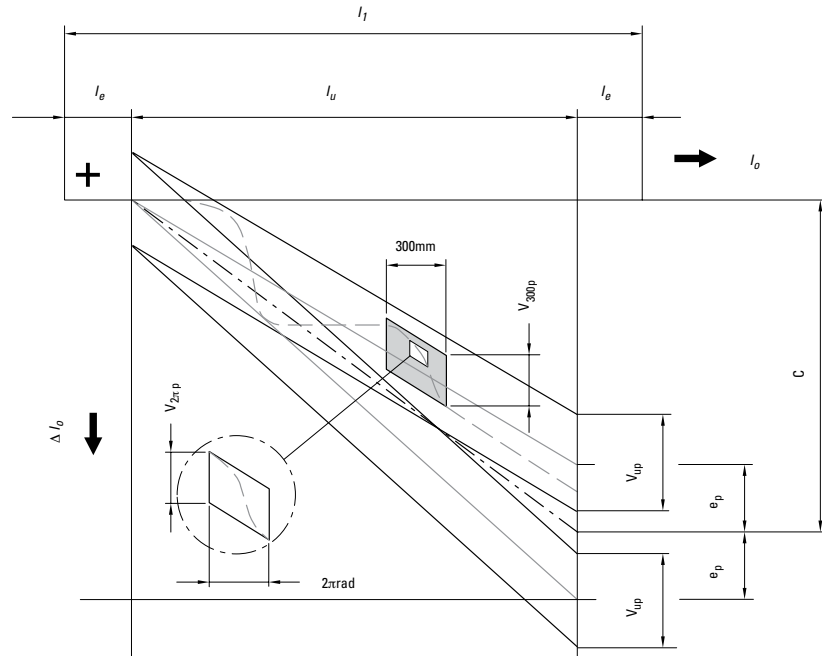

### T — Transport Class Ball Screws

$$\text{Maximum error over useful length} = e_p$$

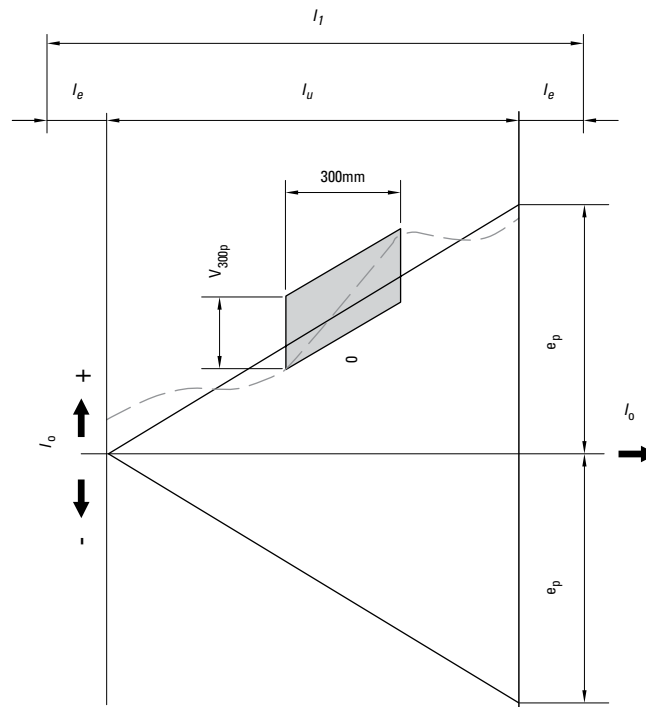

- $l_0$  = nominal travel
- $l_1$  = thread length
- $l_o$  = travel deviation
- $l_u$  = useful travel
- $l_e$  = excess travel
- $C$  = travel compensation for useful travel (std. = 0)
- $e_p$  = tolerance for actual mean travel deviation (the difference between the maximum and minimum values of the permissible actual mean travel)
- $V_{up}$  = permissible travel variation within useful travel,  $l_u$
- $V_{300p}$  = permissible travel deviation within 300mm travel
- $V_{2\pi p}$  = permissible travel deviation within 1 revolution

## Engineering Guidelines for Metric Series Ball Screws

### Permissible Travel Variation Over Usable Length

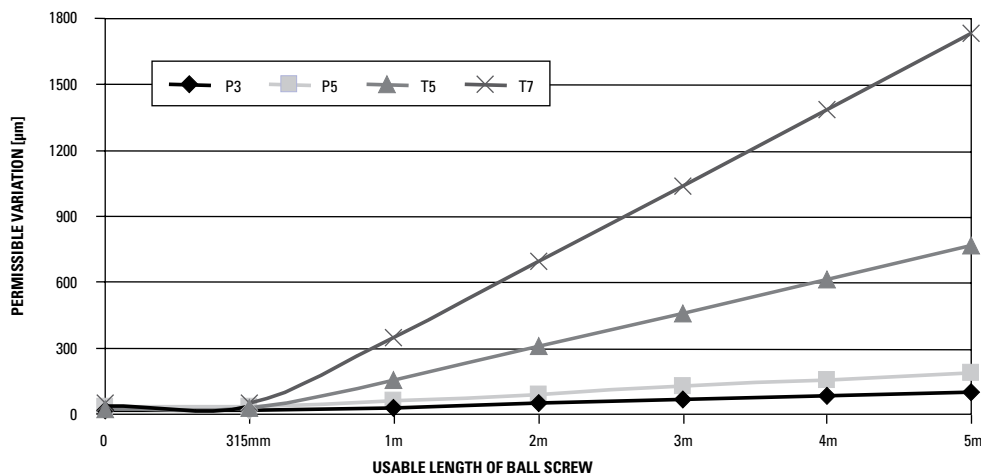

Tolerance Class	Lead Accuracy $V_{300p}$	Permissible Travel Deviation $V_{up}$ ( $\mu\text{m}$ ) Over Screw Length $l_u$ (mm)															
		$l_u$	>		315	400	500	630	800	1000	1250	1600	2000	2500	3150	4000	5000
		(mm)	?	315	400	500	630	800	1000	1250	1600	2000	2500	3150	4000	5000	6300
P3	$\pm 12 \mu\text{m}/300\text{mm}$	$e_p$ ( $\mu\text{m}$ )	12	13	15	16	18	21	24	29	35	41	50	62	76	—	—
		$V_{up}$ ( $\mu\text{m}$ )	12	12	13	14	16	17	19	22	25	29	34	41	49	—	—
P5	$\pm 23 \mu\text{m}/300\text{mm}$	$e_p$ ( $\mu\text{m}$ )	23	25	27	30	35	40	46	54	65	77	93	115	140	170	—
		$V_{up}$ ( $\mu\text{m}$ )	23	25	26	29	31	35	39	44	51	59	69	82	99	119	—
T5	$\pm 23 \mu\text{m}/300\text{mm}$	$V_{up}$ ( $\mu\text{m}$ )	23	$= 2 \times l_u / 300 \times V_{300p}$													
T7	$\pm 52 \mu\text{m}/300\text{mm}$	$V_{up}$ ( $\mu\text{m}$ )	52	$= 2 \times l_u / 300 \times V_{300p}$													

### Preload Types

#### Precise Preload (Type Z0)

(Available with FL nut only)

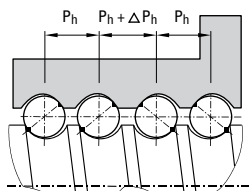

- The lead is offset within the ball nut to provide a precise preload.
- The preload is approximately 10% of dynamic load capacity, but can range from 2% to 13% as specified by customers.
- Typically used where both repeatability and high stiffness are required.

#### Preload (Type Z1)

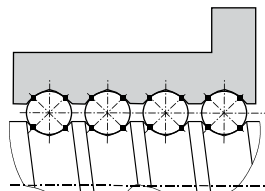

- Oversized balls slightly larger than the ball groove space are used to provide zero backlash between the screw and nut.
- The preload is approximately 1% to 2% of dynamic load capacity.
- Typically used for positioning applications where higher-level repeatability is desired.

#### No Preload (Type Z2)

(Standard lash)

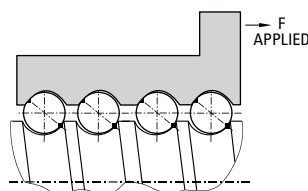

- Axial play is present between screw and nut.
- Typically used for transport or vertical applications.

#### No Preload (Type Z3)

(Minimum lash)

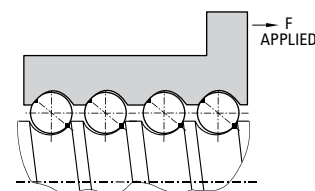

- Axial play is present between screw and nut (held to .05mm maximum).
- Typically used for transport or vertical applications.

# Engineering Guidelines for Metric Series Ball Screws

## Lubrication Guidelines

Ball screws must be lubricated to operate properly and achieve the rated life. We recommend using TriGEL-450R or TriGEL-1800RC for lubricating ball screws. Other oils and greases may be applicable but have not been evaluated.

The TriGEL grease can be applied directly to the screw threads near the root of the ball track. Some ball nut sizes are available with threaded lube holes for mounting lubrication fittings. For these ball nuts, the TriGEL grease can be pumped directly into the nut. Please refer to the catalog detail views to verify which ball nuts have the threaded lube holes. It is recommended to use these nuts in conjunction with a wiper kit to contain the lubricant in the body of the nut.

Ball screws may require lubrication frequently depending on both environmental and operating conditions. If the lubricant appears to be dispersed before this point or has become dry or crusted, the maintenance



interval should be reduced. Before adding additional grease, wipe the screw clean, removing the old grease and any particulate contamination seen on the screw. If oil is

being used, the best results may be obtained by utilizing a continuous-drip type applicator.

## Nut Loading

Axial loading (on nut or screw) is optimal for performance and life. For applications requiring radial loads, please contact us.

Axial Loading: optimal

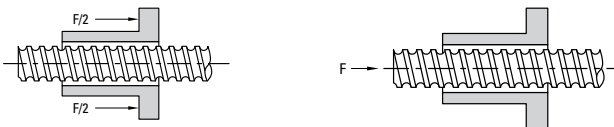

Radial Loading: detrimental\*



\* Minimize radial loading to less than 5% of the axial load.

## Nut Mounting

Use the following guidelines to achieve optimal performance. (All units are mm)

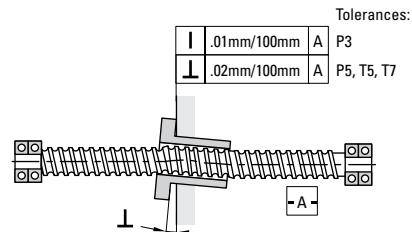
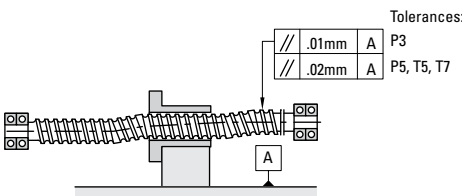



## Engineering Guidelines for Metric Series Ball Screws

### Acceptable Speed† vs. Length for Screws

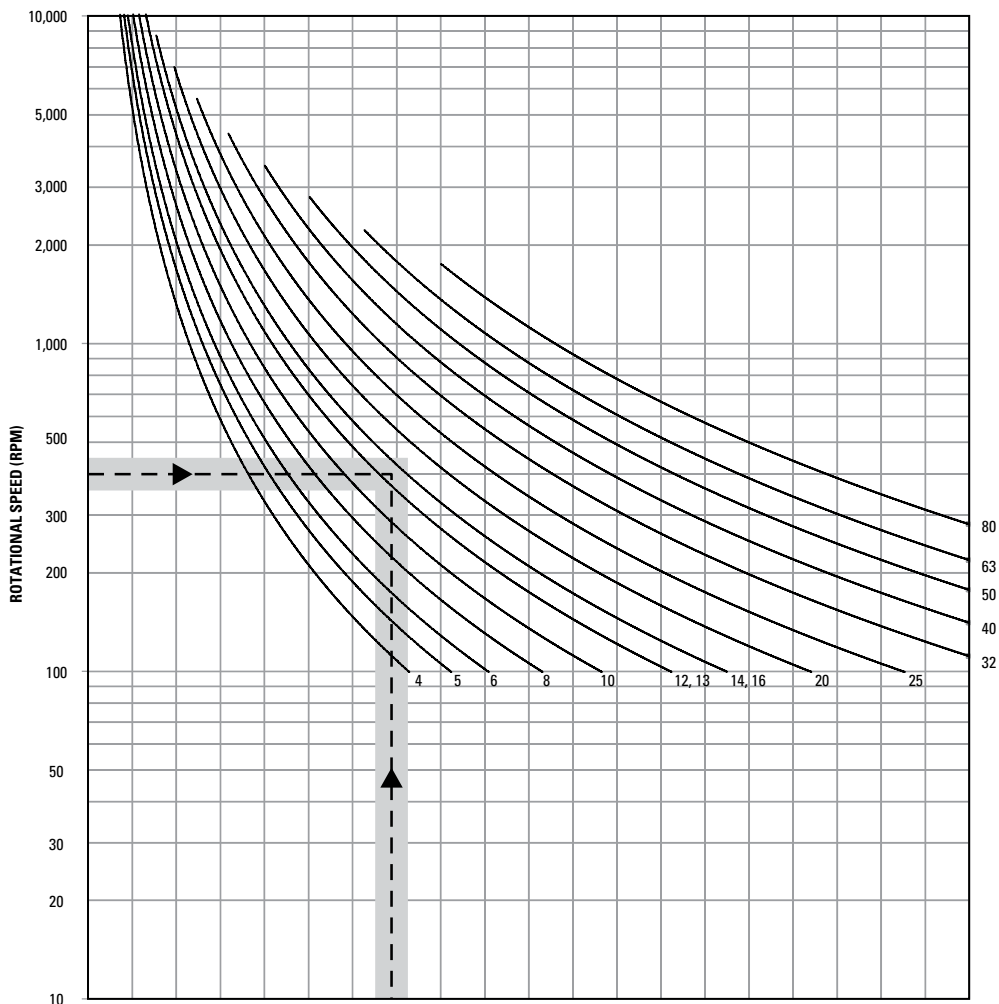

**END SUPPORT TYPE**

Support Type	End Condition	6 in	12 in	18 in	24 in	30 in	36 in	42 in	48 in	54 in	60 in	66 in	72 in	78 in	84 in	90 in	96 in	102 in	108 in	114 in	120 in
A	One end fixed, other end free	152	304	457	609	762	914	1056	1219	1371	1524	1676	1828	1981	2133	2286	2438	2590	2743	2895	3048
	Both ends supported	254	508	762	1016	1270	1524	1778	2032	2286	2540	2794	3048	3302	3556	3810	4064	4318	4572	4826	5080
C	One end fixed, other end supported	304	609	914	1219	1524	1828	2133	2438	2743	3048	3353	3658	3963	4268	4573	4878	5183	5488	5793	6098
	Both ends fixed	381	762	1143	1524	1905	2286	2667	3048	3429	3810	4191	4572	4953	5334	5715	6096	6477	6858	7239	7620

Example: Travel rate of 400 rpm.  
 Unsupported length of 85 in. (2159mm).  
 End fixity of one end fixed, other end supported.

All screws with curves which pass through or above and to the right of the plotted point are suitable for the example. The acceptable velocities shown by this graph apply to the screw shaft selected and are not indicative of the velocities attainable of all of the associated ball nut assemblies. Consult Thomson engineering for high speed applications.

†80% of critical speed

# Engineering Guidelines for Metric Series Ball Screws

## Compression Load vs. Length for Designated Ball Screws

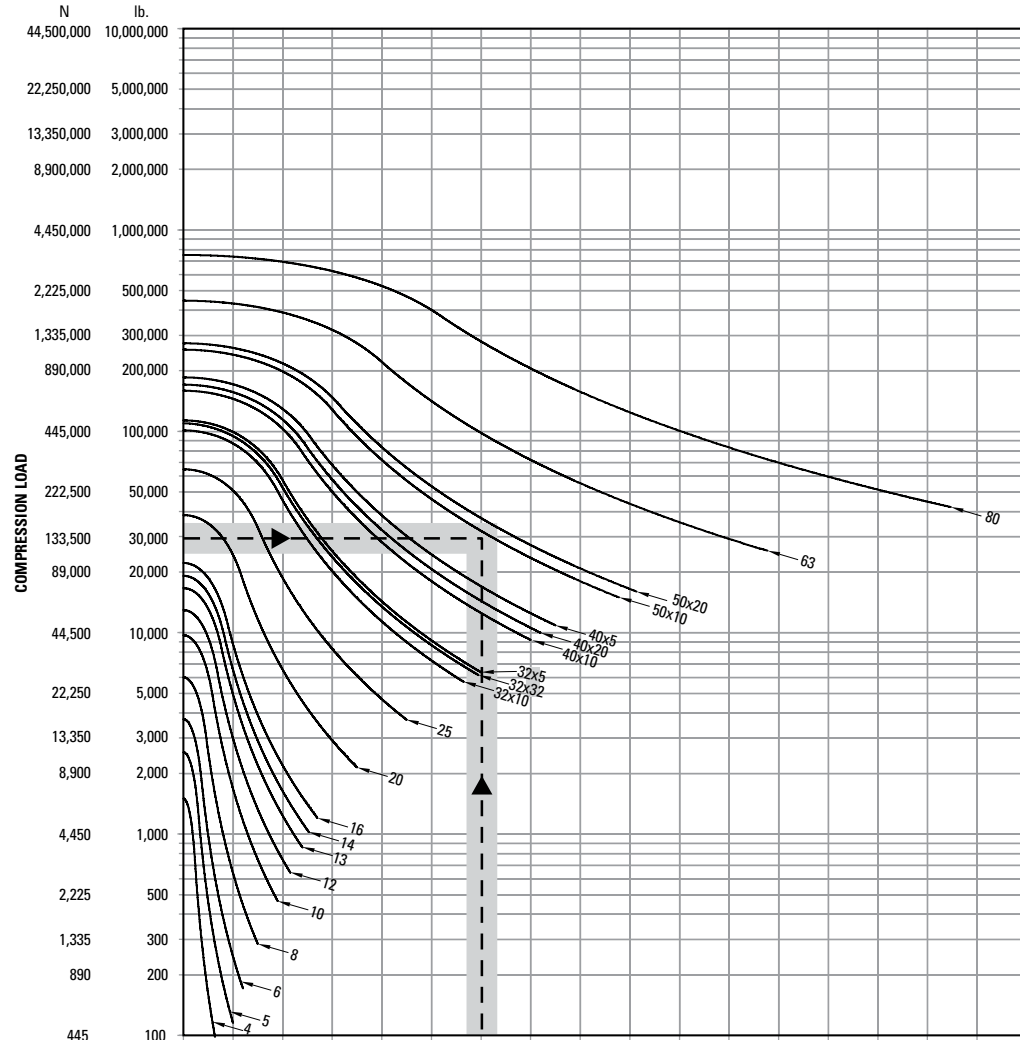

**END SUPPORT TYPE**

Support Type	Inches	5	10	15	20	25	30	35	40	45	50	55	60	65	70	75	80	85
<b>A</b> One end fixed, other end free	mm	127	254	381	508	635	762	889	1016	1143	1270	1397	1524	1651	1778	1905	2032	2159
<b>B</b> Both ends supported	Inches	10	20	30	40	50	60	70	80	90	100	110	120	130	140	150	160	170
	mm	254	508	762	1016	1270	1524	1778	2032	2286	2540	2794	3048	3302	3556	3810	4064	4318
<b>C</b> One end fixed, other end supported	Inches	14	28	42	57	71	85	99	113	127	141	156	170	184	198	212	226	240
	mm	356	711	1067	1448	1803	2159	2515	2870	3226	3581	3962	4318	4674	5029	5385	5740	6096
<b>D</b> Both ends fixed	Inches	20	40	60	80	100	120	140	160	180	200	220	240	260	280	300	320	340
	mm	508	1016	1524	2032	2540	3048	3556	4064	4572	5080	5588	6096	6604	7112	7620	8128	8636

Example: Maximum system load is 30,000 lb. (133,500 N).  
 Length of 85 in. (2159mm).  
 End fixity of one end fixed, other end supported.

All screws with curves which pass through or above and to the right of the plotted point are suitable for the example.

The suitable compression loads shown in this graph are not to exceed the maximum static load capacity as given in the rating table for the individual ball nut assembly.

## **Ball Splines — Engineering**



Need a quote or have a question about an application? Contact us in North America at:

Phone: 540-633-3549

Fax: 540-639-4162

Email: [thomson@thomsonlinear.com](mailto:thomson@thomsonlinear.com)

# Engineering Guidelines for Ball Splines

## Selection Procedures

**Applications Analysis** — Follow this step-by-step procedure to determine the ball spline best suited for your application. It is suggested you analyze the requirements of your application using a work pad for easy reference.

**Maximum Static Load** — Determine the maximum static torque loads encountered in the application. This must include shock loads. Using the table on page 134, note the ball spline sizes and race combinations which have capacities in excess of the application requirements.

**Rated Load** — In many ball spline applications, freedom of axial movement is essential while actual travel is negligible. For example, a spline used on a jet engine accessory gear box drive moves less than 1/10 inch. This axial freedom is essential to eliminate damaging stress forces to the engine and gear box housings, but total daily travel may be less than 2 inches. Select the size and race combination with a rated load that will meet your application requirement from the table.

**Life Expectancy** — On occasion, it is important to plan for a specific life expectancy. These applications usually are designed to use the smallest practical ball spline at the maximum possible torque or where considerable translation occurs. For these applications, use the Life Expectancy chart on page 205. Contact Thomson if light weight and small size are considerations.

Determine the following:

- life expectancy — total inches of travel desired during the life of the application
- application load — the normal operating load for the application in inch-pounds (Newton-millimeters) of torque

**Speed vs. Length** — Determine the following:

- Speed — determine the maximum revolutions per minute (rpm) required
- Maximum length — determine the maximum unsupported length
- End fixity — determine the type of configuration (refer to the Bearing Support reference drawings on page 187). Quick Mount bearing support blocks can be used on diameters 5/8 inch through 2-1/2 inch. Using the example at the bottom of the Speed vs. Length chart on page 206, plot the point for your specific application.

## Design Formulas

### Life Ratings





$$L_{10} [\text{in.}] = \left[ \frac{C_{am}}{T} \right]^3 \times 10^6$$

Parameters:

T = dynamic equivalent torque  
 (A constant torque under the influence of which a ball spline assembly would have the same life as it will attain under the actual applied torque condition.)

C<sub>am</sub> = dynamic load rating [lbs.]  
 (based on 1.0 million inches)

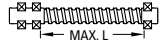
$n_c = C_s \times 4.76 \times 10^6 \times \frac{d_r}{l^2}$     n<sub>c</sub> = Critical Speed (rpm)  
 n<sub>s</sub> = Safe Drive Speed  
 d<sub>r</sub> = Root Diameter (in.)  
 l = Length between Bearing Supports (in.)  
 S = Safety Factor (0.8 maximum)  
 C<sub>s</sub> = End Fixity Factor

End Fixity Factor		
End Supports		C <sub>s</sub>
A		0.36
B		1.00
C		1.47
D		2.23

## Engineering Guidelines for Ball Splines

### Life Expectancy for Precision Ball Splines

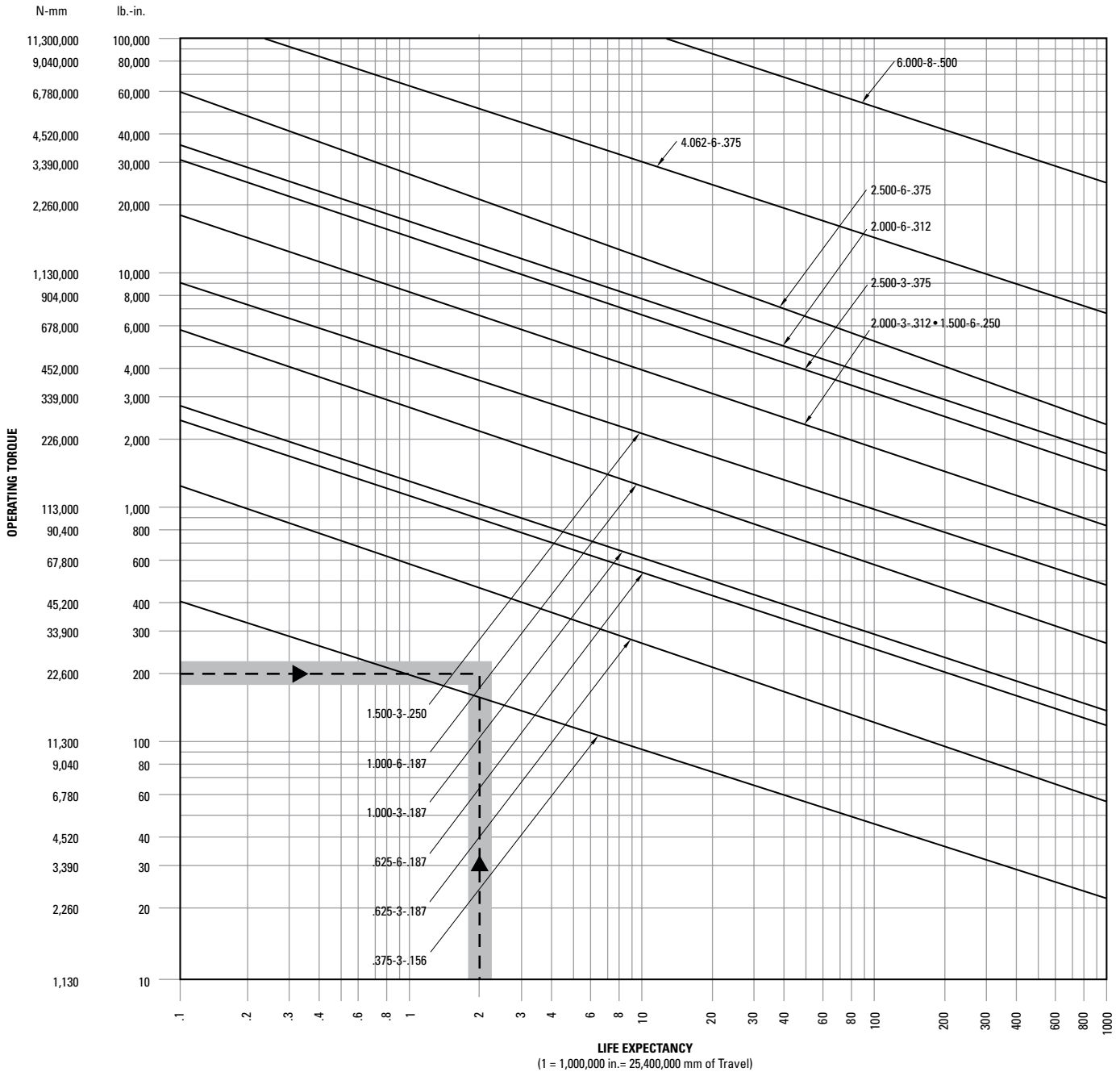

Example: Desired life of 2 million in.  
 (50.8 million mm).  
 Operating torque is 200 lb.-in.  
 (22.6 N · mm)

All splines with curves which pass through or are above and to the right of the plotted point are suitable for the example.

# Engineering Guidelines for Ball Splines

## Speed vs. Length for Precision Ball Splines

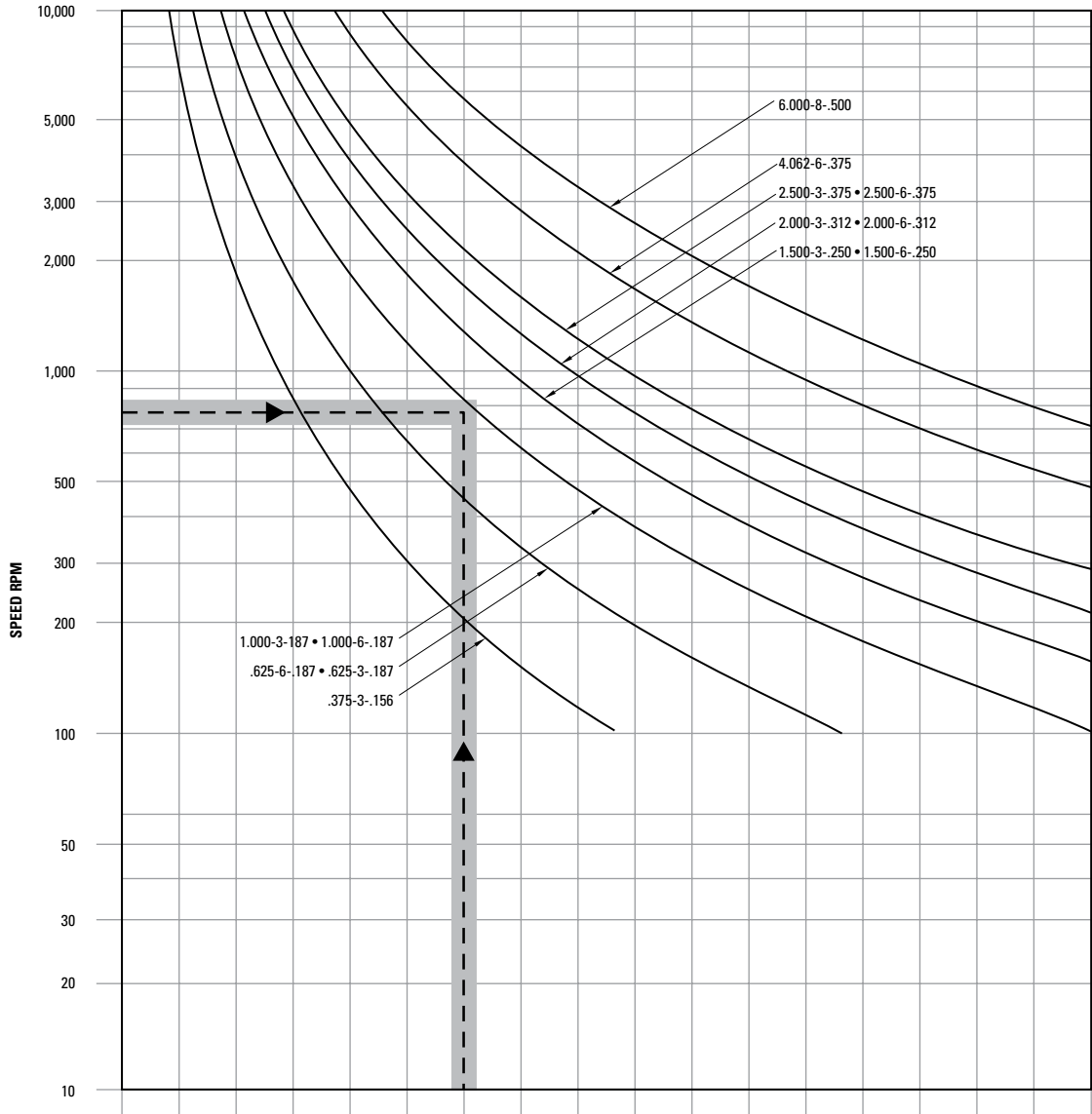

### END SUPPORT TYPE

Support Type	Length (Inches)	Length (mm)	6	12	18	24	30	36	42	48	54	60	66	72	78	84	90	96	102
A: One end fixed, other end free	Inches		6	12	18	24	30	36	42	48	54	60	66	72	78	84	90	96	102
	mm		152	304	457	609	762	914	1056	1219	1371	1524	1676	1828	1981	2133	2286	2438	2590
B: Both ends supported	Inches		10	20	30	40	50	60	70	80	90	100	110	120	130	140	150	160	170
	mm		254	508	762	1016	1270	1524	1778	2032	2286	2743	2794	3048	3302	3556	3810	4064	4318
C: One end fixed, other end supported	Inches		12	24	36	48	61	73	85	97	109	121	133	145	158	170	182	194	206
	mm		304	609	914	1219	1549	1854	2159	2463	2768	3073	3378	3683	4013	4318	4622	4927	5232
D: Both ends fixed	Inches		15	30	45	60	75	90	105	119	134	149	164	179	194	209	224	239	254
	mm		381	762	1143	1524	1905	2286	2667	3022	3403	3784	4165	4546	4927	5308	5689	6070	6451

Example: Maximum shaft speed is 800 rpm.  
 Unsupported length is 60 in. (1524mm).  
 End fixity is both ends supported.

All splines with curves which pass through or are above and to the right of the plotted point are suitable for the example.

**Bearing Supports — Engineering**



Need a quote or have a question about an application? Contact us in North America at:

Phone: 540-633-3549

Fax: 540-639-4162

Email: [thomson@thomsonlinear.com](mailto:thomson@thomsonlinear.com)

# Engineering Guidelines for Bearing Supports

## Design Formulas

These formulas allow you to determine the life of the Thomson QK bearing supports.

### 1. Dynamic Equivalent Radial Load (P<sub>r</sub>)

$$P_r = X * F_r + Y_1 * F_a$$

$$KT = \frac{F_a}{(\# \text{ of Bearings}) * C_o}$$

$$P_r = 0.56 * F_r + Y_1 * F_a \quad (\text{Deep Groove Radial Ball Bearings})$$

$$P_r = 0.43 * F_r + F_a \quad (\text{Angular Contact Ball Bearings, Contact Angle} = 20^\circ)$$

$$P_r = 0.35 * F_r + 0.57 * F_a \quad (\text{Angular Contact Ball Bearings, Contact Angle} = 40^\circ)$$

P<sub>r</sub> = Dynamic equivalent radial load

F<sub>r</sub> = Applied radial load

F<sub>a</sub> = Applied axial load

X = Dynamic radial load factor

Y<sub>1</sub> = Dynamic axial load factor

C<sub>o</sub> = Radial static load rating

C<sub>am</sub> = Radial dynamic load rating

n = rpm

**Table 1 — Load Factor**

KT	Y <sub>1</sub>
0.015	2.30
0.020	2.22
0.025	2.10
0.030	2.00
0.040	1.86
0.050	1.76
0.060	1.68
0.080	1.57
0.100	1.48
0.120	1.42
0.150	1.34
0.200	1.25
0.250	1.18
0.300	1.13
0.400	1.05
0.500	1.00
0.600	—
0.800	—
1.000	—
1.200	—

**Table 2 — Contact Angle**

Bearing Trade No.	Inch End Blocks	Metric End Blocks	Contact Angle
609	7828282	7829546	Radial
7201	7824154	7829547	20°
7202	7824155	7829548	20°
7203	7824156	—	20°
7204	7824157	7829549	40°
7205	7824158	7829550	40°
7206	7824159	7829551	40°
7308	7829554	7829552	40°
7309	7824160	—	40°
7310	7824161	7829553	40°

### 2. Bearing Support Life (L)

$$L_{10} \text{ (revolutions)} = \left( \frac{C_{am}}{P_r} \right)^3 * (1 \times 10^6)$$

$$L_{10} \text{ (hours)} = \left( \frac{C_{am}}{P_r} \right)^3 * \left( \frac{1 \times 10^6}{60 * n} \right)$$

### Example:

F<sub>a</sub> = P = axial load

Part Number: 7828282

F<sub>r</sub> = 0 (typical ball screw application)

C<sub>am</sub> = 930 lbs    C<sub>o</sub> = 320 lbs

P<sub>r</sub> = Y<sub>1</sub>F<sub>a</sub> (radial)

P<sub>r</sub> = Y<sub>1</sub>F<sub>a</sub>

P<sub>r</sub> = F<sub>a</sub> (20° contact angle)

$$KT = \frac{100}{(2)(320)} = .156$$

P<sub>r</sub> = .57 F<sub>a</sub> (40° contact angle)

Ball Screw: .500 x .200

Y<sub>1</sub> = 1.329

Quick Mount Bearing Support:  
7828282 (2x radial bearings)

P<sub>r</sub> = (1.329)(100) = 132.9

F<sub>a</sub> = 100 lbs

P<sub>r</sub> < C<sub>o</sub>

F<sub>r</sub> = 0 lbs

$$L_{10} = \left( \frac{930}{132.9} \right)^3 \text{ million revs} = 342 \text{ million revs}$$

Floating Bearing Support: 7833291

F<sub>a</sub> = 0

F<sub>r</sub> = 0



## Installation

This section is organized so that the installer can follow step by step instructions to prepare and install a new ball screw assembly. Ball screw assemblies are offered in several variations, so all of the installation steps may not be followed for a specific type. The Glossary of Terms will define any terms with which the user may not be familiar. All product specifications and dimensions are found in this catalog.

### Installation Can Be Completed in Six Easy Steps

- STEP ONE: Mounting the Flange to the Ball Nut  
 STEP TWO: Mount Front End of Wiper to the Screw (brush type wipers only)  
 STEP THREE: Install Ball Nut onto the Ball Screw  
 STEP FOUR: Complete Installation of the Wiper Kit  
 STEP FIVE: Lubricate the Ball Nut and Screw  
 STEP SIX: Install Ball Screw Assembly into Your Machine

Ball screws are delivered to the user in one of four ways:

1. Finished ends with assembled ball nut, ready to mount in a machine. No further preparation is required.
2. Screw ends machined and ball nut supplied on an arbor ready for transfer.
3. Screw cut and annealed ready for machining and ball nut supplied on an arbor ready for transfer.
4. Hardened screw in bulk length with ball nut supplied on an arbor ready for transfer.

Ball nuts are delivered without flanges attached and without lubrication. **Ball screw assemblies must not be run without proper lubrication.**

### STEP ONE: Mounting the Flange to the Ball Nut

*If flange is not used, proceed to STEP TWO.*

#### Preparation of Ball Nut

A ball nut flange is the recommended means of attaching a ball nut to a load. A flange should be tightened firmly against the ball nut on its threads and secured by one of the methods described below. Take care not to grasp and damage the return tubes when tightening the flange. Ball circulation will be impaired if the return tubes are damaged.

Flanges are provided loose from the factory unless otherwise specified. The standard method to secure the flange to the ball nut is shown in Method "A" (retain with pins). Smaller ball screw assemblies may be assembled using Method "B" (retain with set screws). Flanges can be pinned at the factory upon request.

#### Flange Installation Method A

##### Retain with pins (recommended)

1. Remove the ball nut from the transfer arbor. Catch and save the balls for reassembly.
2. Apply Loctite grade 271 (red in color) to the ball nut V-threads.
3. Thread the flange onto the ball nut until it contacts the ball nut shoulder.
4. Loosen the flange until the required machine bolts can be inserted into the flange mounting holes without interfering with the ball return guides (see Figure 1).
5. Drill two holes approximately 90° apart, as shown in Figure 1. Note: the pin circle diameter is also the V-thread pitch diameter.
6. Press two groove type pins to the bottom of the drilled holes.
7. Stake the pin holes to prevent the pins from disengaging.
8. Remove all chips from the ball nut, and clean it thoroughly to remove potential contaminants.
9. Reassemble the flanged ball nut and components on the transfer arbor or ball screw.

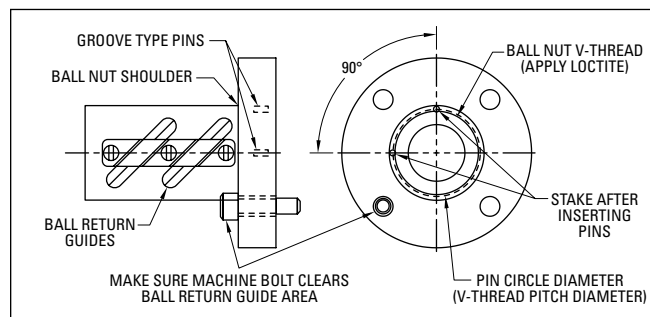

Figure 1

## Installation

### Flange Installation Method B

#### Retain with set screws (optional for flanges with set screws)

1. Apply Loctite grade 271 (red in color) to the ball nut V-threads.
2. Thread the flange onto the ball nut until it contacts the ball nut shoulder.
3. Loosen the flange until the required machine bolts can be inserted into the flange mounting holes without interfering with the ball return guides (see Figure 2).
4. Apply Loctite grade 271 (red in color) to the radial threaded hole in the flange.
5. Select a cup point set screw with a length of one half the threaded hole depth. Install two set screws, tightening to the manufacturer's recommended torque (see Figure 2).

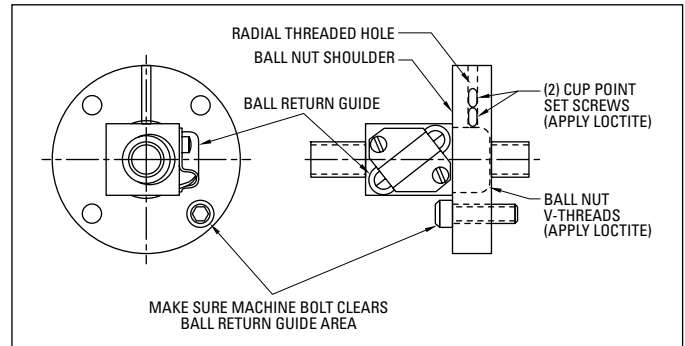

Figure 2

### Method B Dimensions

V-Thread	Reference			Pin Circle Diameter	Drill		Pin						
	BCD	Lead	Ball Diameter		Diameter	Depth	Diameter	Length					
.664-32 UNS	0.375	0.125	0.063	Use Method A — Retain with set screws									
0.6875-24 UNEF	0.375	0.125	0.063										
0.9375-16 UN	0.500	0.200	0.125										
0.9375-16 UN	0.500	0.500	0.125										
0.9375-16 UN	0.631	0.200	0.125										
0.9375-16 UN	0.631	1.000	0.125										
1.173-18 UNS	0.750	0.200	0.125										
1.125-18 UNEF	0.750	0.200	0.125										
1.250-18 UNEF	0.750	0.200	0.125										
1.173-18 UNS	0.750	0.500	0.156										
1.250-16 UN	0.750	0.500	0.156										
1.375-16 UN	0.875	0.200	0.125						1.332	0.094	0.312	0.094	0.250
1.563-18 UNEF	1.000	0.250	0.156						1.527	0.125	0.438	0.125	0.375
1.563-18 UNEF	1.000	0.500	0.156	1.527	0.125	0.438	0.125	0.375					
1.563-18 UNEF	1.000	1.000	0.156	1.527	0.125	0.438	0.125	0.375					
1.625-20 UN	1.150	0.200	0.125	1.591	0.094	0.312	0.094	0.250					
1.967-18 UNS	1.171	0.413	0.281	1.929	0.188	0.438	0.188	0.375					
1.967-18 UNS	1.500	0.250	0.156	1.929	0.125	0.312	0.125	0.250					
2.548-18 UNS	1.500	0.473	0.344	2.509	0.250	0.438	0.250	0.375					
2.360-18 UNS	1.500	0.500	0.312	2.337	0.250	0.438	0.250	0.375					
2.250-20 UN	1.500	1.000	0.344	2.215	0.250	0.562	0.250	0.500					
2.250-20 UN	1.500	1.875	0.281	2.215	0.188	0.562	0.188	0.500					
2.250-20 UN	1.500	2.000	0.281	2.215	0.188	0.562	0.188	0.500					
3.000-12 UN	2.000	0.500	0.375	2.944	0.250	1.000	0.250	0.625					
3.000-12 UN	2.000	1.000	0.375	2.944	0.250	1.000	0.250	0.625					
3.137-12 UNS	2.250	0.500	0.375	3.080	0.250	1.000	0.250	0.625					
3.137-12 UNS	2.250	1.000	0.375	3.080	0.250	1.000	0.250	0.625					
3.340-12 UNS	2.500	0.250	0.156	3.283	0.125	0.750	0.125	0.500					
3.625-12 UN	2.500	0.500	0.375	3.443	0.250	1.000	0.250	0.625					
3.625-12 UN	2.500	1.000	0.375	3.443	0.250	1.000	0.250	0.625					
4.325-12 UNS	3.000	0.660	0.500	4.267	0.250	1.188	0.250	0.750					
4.325-12 UNS	3.000	1.500	0.500	4.267	0.250	1.188	0.250	0.750					
5.497-12 UNS	4.000	1.000	0.625	5.439	0.375	1.250	0.375	0.750					

## Installation

### STEP TWO: Mount Front End of Wiper to the Screw

If wiper is not included or integral to ball nut, then proceed to STEP THREE.

#### Wipers

Wipers are available for most units as optional items. Precision inch ball nuts typically do not include wipers but they may be added as an option. Precision Plus inch ball nuts and all metric ball nuts include wipers as standard. Wipers generally fall into two categories: one style is internally mounted inside the extreme ends of the ball nut; the other is a wiper and retainer kit combination mounted on the exterior end of the ball nut. In some applications, one or the other may be used or a combination of both. Visual inspection will reveal the style used.

To obtain maximum service from a ball screw assembly, the ball nut should be protected from metal chips and dirt. Foreign material entering the ball nut may be rolled into the ball race, causing high localized loading, abrasion and spalling of the balls, resulting in premature failure. The wiper helps prohibit contaminants from entering the nut as it translates along the screw. These wipers are effective in most industrial applications.

For wipers with flange retainer: 1) Select end of screw to install ball nut (typically end with shortest journal length). 2) Orient ball nut with flange facing desired direction. 3) Install wiper holder and wiper for leading end of ball nut to ball screw. Then follow the ball nut installation procedure, STEP THREE, page 212 4) Install wiper holder onto trailing end of ball nut once the ball nut is installed on the ball screw.

## Lead Screws, Ball Screws and Ball Splines



Brush Wiper

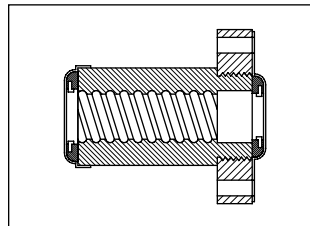

Wiper with Flange Retainer

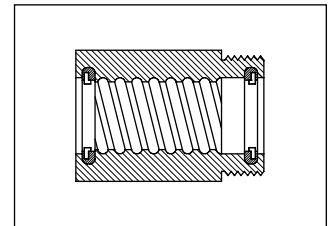

Internal Snap Ring

### Typical Methods of Attaching Wipers to V-Thread End

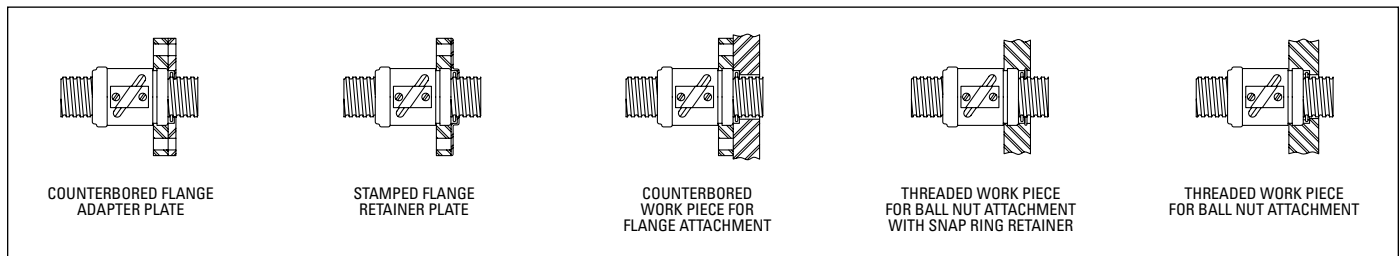

Wiper without Flange Retainer

## Installation

### STEP THREE: Install Ball Nut onto the Ball Screw

#### Installing Ball Nut onto Ball Screw

Each ball nut is completely assembled and loaded with bearing balls before it leaves the factory. The balls are held in place by a shipping arbor/mandrel.

**CAUTION: If the arbor is removed without turning the nut onto the screw, the bearing balls will fall out of the nut and will require reloading.**

**Method A:** Install Ball Nut without Preload onto Ball Screw

**Method B:** Install Ball Nut with Preload onto Ball Screw Using Gap Technique (required on part numbers listed in Table B)

**Method C:** Install Ball Nut with Preload onto Ball Screw Using Turn Technique (required on part numbers listed in Table C)

#### Method A: Install Ball Nut without Preload onto Ball Screw

To transfer the ball nut to the screw, proceed as follows:

1. Remove any ball nut retainer from the arbor. Hold the arbor firmly end to end with the screw. Make certain the arbor end is centered on the screw shaft end. (See Figure 3.)

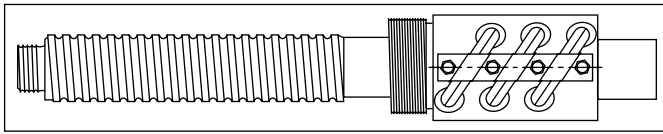

Figure 3

2. Slide the ball nut down to the screw shaft and rotate to the thread until you feel the balls drop into the screw thread. Then rotate with the screw thread until the ball nut completely clears the end of the screw shaft adjacent to the arbor. (See Figure 4.)

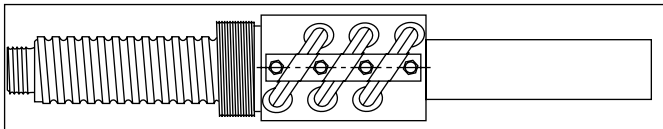

Figure 4

3. Remove the arbor. (See Figure 5.)

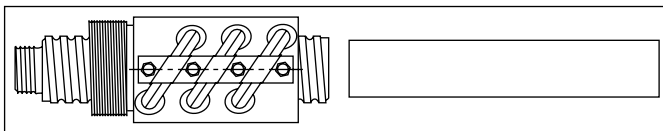

Figure 5

To transfer the ball nut to the arbor, reverse these steps.

**CAUTION: When end machining makes it impossible to bring the arbor adjacent to the shaft ball grooves, wrap the machined portion with tape to the nominal O.D. of the arbor. The tape will permit the ball nut to slide over the machined area without the balls dropping into machined irregularities in the shaft.**

**CAUTION: Extreme care must be taken to prevent the ball nut from sliding off the end of the screw shaft during installation and handling. Temporary stops can be made by wrapping tape around the shaft ball grooves at each end. Be sure to remove the tape and any residual adhesive after the ball screw assembly is properly installed.**

#### Notes regarding installation of Preloaded Ball Nuts (Applicable to Methods B and C):

##### Installing Preloaded Double Nut Preloaded Ball Screws (Double Nut Design)

General Description: The two primary reasons for preloading ball screws are to: eliminate backlash and obtain maximum system stiffness.

Preload for units having a compensating spring feature should be established in excess of the normal operating load whenever possible. Further adjustment is not normally required during the life expectancy. Units of this type are used in many specific applications requiring special considerations.

##### Transferring Ball Nuts from Arbor

Double nut design ball nuts are supplied on arbors. Care must be used not to lose any of the bearing balls, or trap balls between circuits when rotating the ball nut onto the screw.

##### Method B: Install Ball Nut with Preload onto Ball Screw Using Gap Technique (required on part numbers listed in Table B)

Use this procedure for assemblies having part numbers indicated in Table B.

##### Preloading Double Nuts Using Gap Technique

Ball nuts are transferred from arbor without a preload. Before preloading these ball nuts, oil the coupling threads, spring washers, ball nut bearing surfaces and the ball grooves of the screw shaft.

Be sure to keep the ball return tubes of the two ball nuts aligned (see Figure 6). Also, make sure the coupling tangs line up with the slots in the ball nut if they have become disengaged.

Position the ball nut midway on the screw shaft. Place retainers on screw to prevent the ball nut from accidentally running off the screw shaft. With the ball return tubes facing upwards, tighten the spanner nut against the spring washer "finger tight", plus 1/4 turn. Rotate the screw shaft through several turns in both directions while holding the ball nut with the ball return tubes on top. Continue to tighten the spanner nut with spanner or channel locks until the .003" (075mm) average gap is obtained resulting in the preload as indicated by the chart. Rotate the screw in both directions several times and check for smoothness. Be sure the spring washer of the coupling is centralized (not protruding in any direction). Use a plastic or brass mallet, if necessary, to help seat the coupling system. Tap lightly. Recheck torque and re-average gap as necessary.

Check the torque by rotating screw shaft with a torque wrench. Secure the spanner nut with the set screw(s) provided.

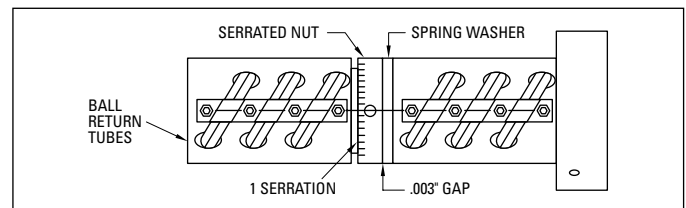

Figure 6

## Installation

**Table B. Preload Using Gap Technique**

Ball Nut Nominal Size & Lead	Ball Nut P/N	Preload Lbs (Newtons) at .003" Gap	Torque In-Lbs (N-mm) at .003" Gap
.500 x .500	7826767	150 (667)	1.0 (113)
.631 x .200	7820955 / 7820956 7823584	150 (667)	1.0 (113)
.631 x 1.000	7827531	50 (222)	50 (222)
.750 x .500	7826991	220 (979)	1.5 (170)
.875 x .200	7823585/7833677	220 (979)	1.5 (170)
1.000 x .250	5704167 / 5704168	330 (1468)	2.0 (226)
1.000 x .250	7820428	330 (1468)	2.0 (226)
1.000 x .250	7820426	330 (1468)	2.0 (226)
1.000 x .250	7823586	330 (1468)	2.0 (226)
1.000 x 1.000	7829720	330 (1468)	2.0 (226)
1.150 x .200	5704270 / 7820206 7823587	240 (1068)	1.5 (170)
1.500 x .250	5704271 / 7823588 7833234 / 5704573	920 (4092)	5.5 (622)
1.500 x 1.000	5700698	1550 (6894)	10.0 (1130)
1.500 x 1.875	5704272	1550 (6894)	10.0 (1130)
2.250 x .500	7823589	5000 (22240)	30.0 (3390)
2.500 x .250	7823590	1300 (5782)	10.0 (1130)
3.000 x .660	5703045	12400 (55155)	75.0 (8475)

### Method C: Install Ball Nut with Preload onto Ball Screw Using Turn Technique (required on part numbers listed in Table C)

Use this procedure for assemblies having part numbers indicated in Table C.

#### Preloading Double Nuts Using Turn Technique

Turn the locknut onto the V-threads of the rear nut until it shoulders against the nut (Figure 7). Do not tighten the set screws yet.

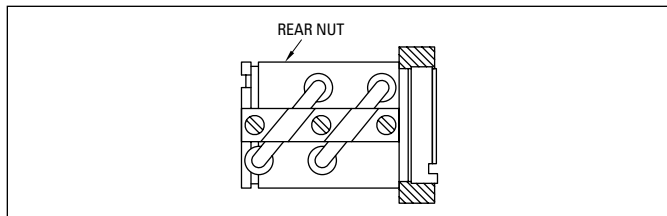

Figure 7. Assembly of locknut to rear nut.

## Lead Screws, Ball Screws and Ball Splines

Turn the front nut onto the screw as shown in Figure 10. Insert the tanged sleeve into position against the front nut with preload springs oriented as shown in Figure 8.

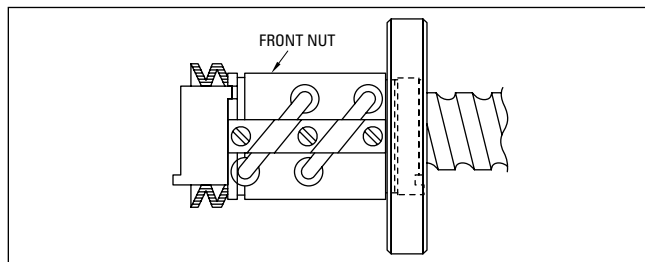

Figure 8. Preload spring orientation.

Insert the slots of the rear nut (lock nut end) into the tangs of the preload sleeve and turn the rear nut onto the screw. Both nuts now turn as an assembly with the tangs in full engagement to prevent the two nuts from rotating separately. The return tubes of the two nuts should be in line with one another. The adjuster nut must be loose at this point, not compressing the bellville springs. (See Figure 9.)

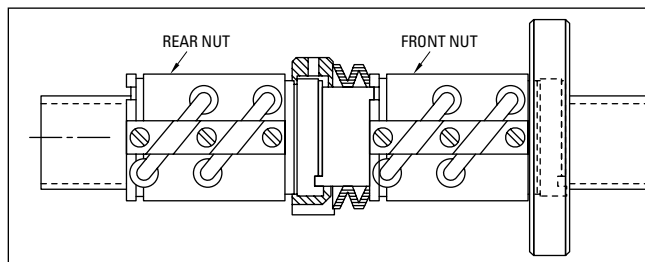

Figure 9. Assembly of rear nut to preload spring.

Hand turn the locknut until all freeplay is just removed. At this point, further turning will begin compressing the preload springs and begin to set the preload force.

#### Assembly

Transfer the front nut, with flange attached, onto the ball screw as shown in Figure 10. The nut should be turned onto the screw only far enough to avoid loss of bearing balls upon removing the mandrel.

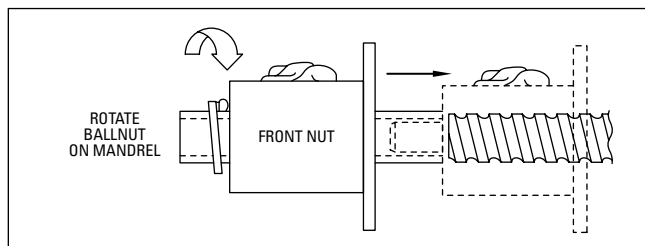

Figure 10. Transfer of front nut to screw.

## Installation

### Method C (Continued)

Bring the rear nut on its mandrel to position for turning onto the screw. (See Figure 11.)

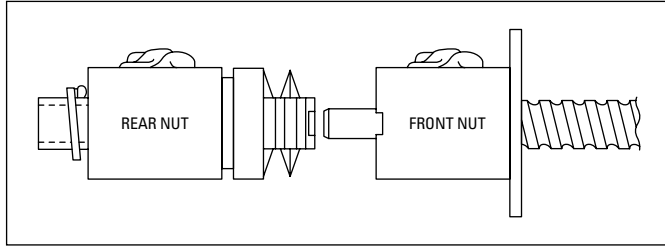

Figure 11. Positioning rear nut for mounting.

**NOTE:** Normally the rear nut for preloading is shipped fully assembled from the factory. If the spring package is not assembled to the rear nut as shown in Figure 12, review Preload Components Assembly for assembly instructions.

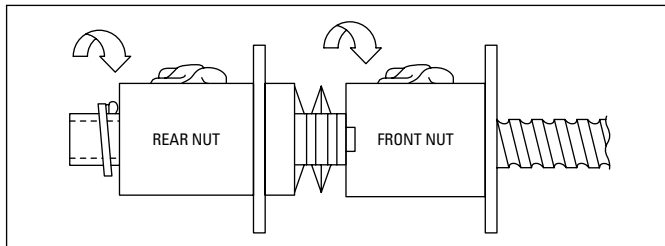

Figure 12. Mounting rear nut.

Insert the tabs of the preload sleeve into the slots of the front nut and then turn the rear nut onto the screw. Both nuts now turn as an assembly with the tangs in full engagement to prevent the two nuts from rotating separately. The return tubes of the two nuts should be in line with one another. The adjuster nut must be loose at this point, not compressing the belleville springs. (See Figure 13.)

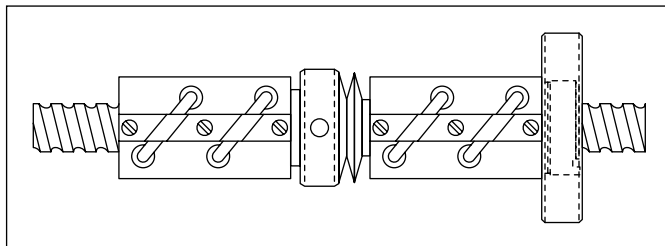

Figure 13. Assembled preload ready for setting.

Turn the locknut until all freeplay is just removed. At this point further turning will begin compressing the preload springs and set the preload force.

### Setting the Preload

#### Amount of Preload

Refer to Table C on page 215 for the number of turns, after freeplay is removed, required for the desired preload. The approximate preload per rotation is also given for preloads between recommended and maximum.

#### Methods of Setting the Preload

1. Small ball screws with light loads may often be set by hand-turning the adjuster nut to position while preventing rotation of the ball nuts.
2. Ball screws of medium size often require a spanner wrench to turn the adjuster nut to position.
3. Large size units sometimes require a spanner wrench with a pipe extension.

Rotation of the ball nuts during preload setting can be prevented by securing the flange in a fixture or installing the ball screw in its end use application.

**CAUTION:** Clamping the O.D. of the ball nuts in a vise or similar gripping system to prevent rotation during preload setting is unacceptable due to damage that may be caused to the balls or return tubes of the ball nut.

After setting the preload to the desired preload force, tighten the set screws into the adjuster nut to secure the preload setting.

#### Preload Components Assembly

Use in conjunction with Assembly instructions on page 213 if assembly of resilient preload components to rear nut is necessary.

Turn the locknut onto the V-threads of the rear nut until the spanner wrench holes line up with the pin holes on the nut. (See Figure 14.)

Do not tighten the set screws at this point.

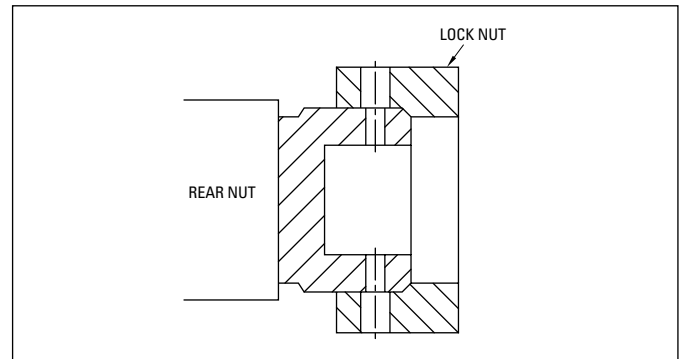

Figure 14. Assembly of locknut to rear nut.

## Installation

### Method C (Continued)

Insert the sleeve into position with preload springs oriented as shown in Figure 15. Align the sleeve holes for insertion of the spring pins.

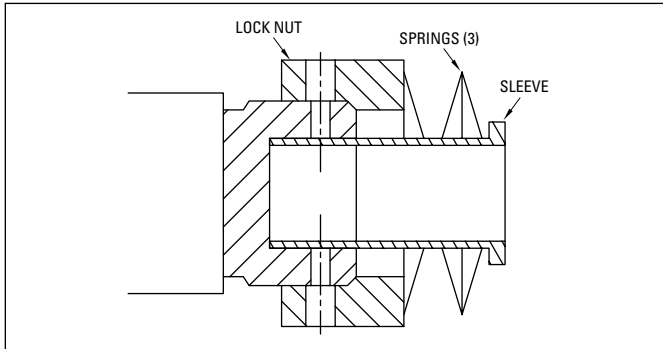

Figure 15. Assembly of sleeve and preload springs.

Press the pins to a depth just below the root of the V-threads in the locknut to allow the locknut to turn freely (see Figure 16). The pins must not be inserted deeper, as they may interfere with the ball screw grooves.

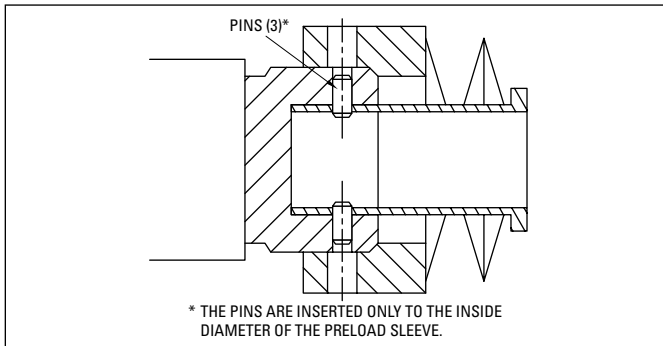

Figure 16. Inserting retainer pin.

### Table C. Preload Using Turn Technique

Ball Nut Nominal Size & Lead	Ball Nut P/N	Preload Lbs (Newtons)	Turns
.375 x .125	8103-448-004	50	0.29
.375 x .125	8103-448-005	50	0.29
.500 x .200	8105-448-008	120	0.24
.500 x .500	8105-448-009	220	0.46
.500 x .500	8105-448-012	190	0.33
.631 x .200	8106-448-015	80	0.25
.631 x .200	8106-448-019	80	0.25
.750 x .500	8107-448-011	345	0.58
.750 x .200	8107-448-012	190	0.33
.750 x .200	8107-448-025	190	0.33
1.000 x 1.000	8110-448-015	225	0.43
1.000 x .500	8110-448-016	395	0.77
1.000 x .250	8110-448-017	335	0.64
1.000 x .250	8110-448-018	335	0.64
1.150 x .200	8111-448-004	240	0.59
1.500 x .500	8115-448-006	1290	0.65
1.500 x .500	8115-448-007	1290	0.65
1.500 x 1.000	8115-448-011	825	0.49
1.500 x .250	8115-448-012	405	0.62
1.500 x .500	8115-448-029	1290	0.65
1.500 x 1.000	8115-448-032	825	0.49
1.500 X 2.000	8115-448-059	760	0.40
2.000 x .500	8120-448-006	1915	0.26
2.000 x .500	8120-448-007	1915	0.26
2.000 x 1.000	8120-448-019	2195	0.30
2.250 x .500	8122-448-003	1930	0.51
2.250 x .500	8122-448-008	1930	0.51
2.500 x 1.000	8125-448-004	2690	0.51
2.500 x .500	8125-448-006	2120	0.40
2.500 x .500	8125-448-015	2120	0.40
3.000 x .660	8130-448-004	3800	0.34
3.000 x .660	8130-448-010	3800	0.34



## Installation

### STEP FOUR: Complete Installation of the Wiper Kit

If applicable, complete wiper kit installation.

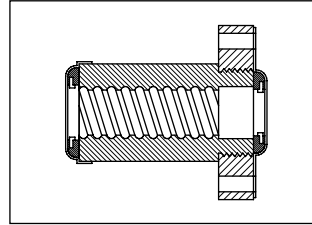

**Wiper with Flange Retainer**

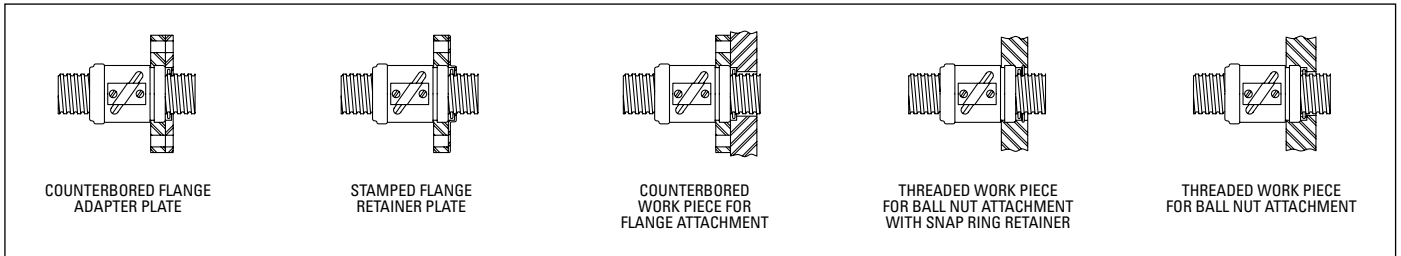

**Wiper without Flange Retainer**



### Installation

#### STEP FIVE: Lubricate the Ball Nut and Screw

##### Lubrication

Ball screw components are coated with a light oil for shipping and storage and must be properly lubricated upon assembly.



We recommend using TriGEL-450R or TriGEL-1800RC for lubricating ball screws every 500,000 to 1 million inches of travel or every six months. Other lubricants may be applicable but have not been evaluated.

The TriGEL grease can be applied directly to the screw threads near the root of the ball track. Some ball nut sizes are available with threaded lube holes for mounting lubrication fittings. For these ball nuts, the TriGEL grease can be pumped directly into the nut. Please refer to the catalog to verify which ball nuts have the threaded lube holes. It is recommended to use these nuts in conjunction with a wiper kit to contain the lubricant within the body of the nut.

Ball screws may require lubrication more frequently than 500,000 inches depending on both environmental and operating conditions. If the lubricant appears to be dispersed before this point or has become dry or crusted, the maintenance interval should be reduced. Before adding additional lubrication, wipe the screw clean, removing the old grease and any particular contamination seen on the screw.

##### Initial Lubrication

As with ball bearings, ball screws can be lubricated using either oils, greases or solid lubricants. Oils are recommended for systems which operate at high speeds, in aggressive environments, or in high ambient temperatures. Greases are recommended for ball screws where an oil circulation lubrication system cannot be applied, or areas where a lubricated-for-life situation is possible. Solid lubricants are typically applied to adverse operating conditions where oils and greases are not suitable.

##### Grease Lubrication Quantity

The nut can be filled to as much as 70% but no lower than 30% of its free space, depending upon operating speed and nDm. Nuts which are not fitted with wipers can be filled completely.

##### Grease Relubrication

In general, ball screws should be relubricated every 500,000 revolutions or every six months. Ball screws which operate above 70°C should be relubricated more often (1/2 the relubrication period for every 15°C increment above 70°C). Use of synthetic lubricants can increase the relubrication interval up to four times, depending on formulation and operating conditions.

Relubrication quantities should equal 30% of the nut free space. When possible, relubrication should be performed while the screw is operating.

##### Run-In

In order to distribute the grease throughout the ball screw elements, it is recommended that the screw be run two to ten times over its complete operating stroke. Run-in should be performed at initial start-up and after every subsequent relubrication.

##### Grease Operating Life

When relubricated with the proper frequency, ball screws should achieve their rated fatigue life. When no relubrication is possible, actual grease operating life will be affected by operating speed, running temperature, and the extent of environmental contamination.

Relubrication intervals can best be determined by experience. Changes in grease consistency, grease color, operating torque and operating temperature can indicate the need for lubrication replenishment.

## Installation

### STEP SIX: Install Ball Screw Assembly into Your Machine

#### Installation of Ball Screw Assembly

A ball nut flange is the recommended means of attaching a ball nut to a load. The ball screw assembly should be mounted into a system or machine as shown in the figures below. Axial loading of the nut is optimal for performance and life and side loading installations or applications should be avoided.

Typical ball screw installations are combined with linear slides to provide support and guidance. Linear rails and ball screws must then be aligned parallel to prevent binding, increased system torque and a decrease in life. Typical installation practice consists of “floating” the ball screw or the linear rail into alignment. To “float” a screw into alignment, secure the linear rail into position and adjust the mounting blocks or nut to minimize the error from parallel.

#### Nut Loading

Axial loading (on nut or screw) is optimal for performance and life. For applications requiring radial loads, please contact us.

#### Axial Loading: optimal

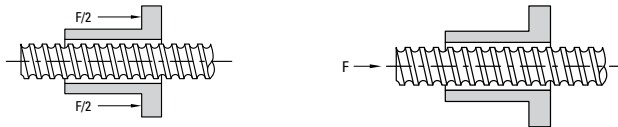

#### Radial Loading: detrimental\*



\* Minimize radial loading to less than 5% of the axial load.

#### Nut Mounting (Inch)

Use the following guidelines to achieve optimal performance.

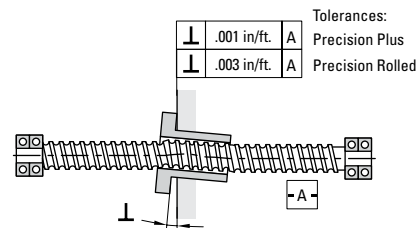
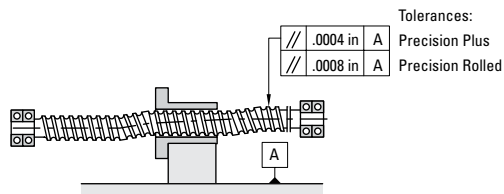

#### Nut Mounting (Metric)

Use the following guidelines to achieve optimal performance.

(All units are mm)

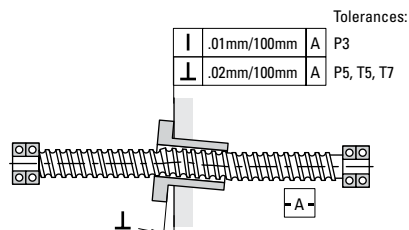
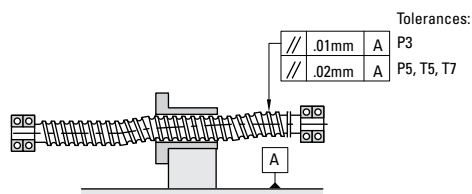

## Maintenance and Service

If proper attention is paid to ball bearing screw selection and installation, virtually no maintenance will be required except for routine lubrication.

All Thomson ball screw assemblies are designed for maximum life and trouble-free operation when adequately serviced and maintained. Ball screw disassembly should be attempted only after complying with the general inspection and maintenance instructions outlined in this section. Be positive that the ball screw is at fault. Disassembly should be done only by persons familiar with ball screw assembly principles. In any unusual circumstances, contact Thomson.

### Troubleshooting

Misalignment is one of the most common problems. Evidence of misalignment can generally be detected by one of the following situations:

- Squealing noise caused by the balls sliding in one or more of the circuits.
- Roughness in the form of vibrations or slightly erratic operation. This can normally be detected by “feel” when placing your hand on the return circuits.
- Excessive heat at the ball nut. Any appreciable temperature above the ambient of adjacent components should be considered excessive.

Gouging or scoring marks on the ball contact area of the screw may be caused by trapped balls between the circuits, broken balls, broken pick-up fingers or deflectors, or foreign objects which may have been digested by the ball nut.

When any of these conditions are encountered, examine the installation and, if necessary, immediately take corrective action to eliminate the cause and prevent further damage.

### General Inspection of the Screw Shaft

Inspect the shaft ball grooves for signs of excessive wear, pitting, gouges, corrosion, or brinelling. Normally, where any of these conditions exist on most Thomson Precision units, it may be more economical and advisable to replace the screw shaft.

### Backlash

Secure the screw shaft rigidly in a table clamp or similar device. Make sure it cannot rotate. Push firmly on the ball nut, first in one direction, then in the opposite direction. The axial movement of the ball nut is the backlash. This measurement can be taken with a dial indicator. Make sure that neither member rotates while the readings are taken.

Backlash with the following limits is considered acceptable:

Ball Diameter	Max. Permissible <sup>†</sup> Lash (used unit)	Max. Lash (new unit)
0 - 1/8"	.008	.005
5/32" - 1/4"	.014	.007
9/32" - 15/32"	.025	.010
1/2" and up	.050	.015

<sup>†</sup> Values based on wear resulting from foreign material contamination and/or lack of lubrication.

If, after inspection, the screw shaft appears to be usable but has excessive backlash, proceed with further disassembly and component inspection.

### Disassembly

General Instructions: Have a clean container, such as a tote tray or cardboard box, handy for each ball return circuit of the ball nut assembly. A piece of clean cloth should be placed on the work table and gathered around the edge to form a pocket to retain the balls. Place the ball nut assembly over the cloth and remove the clamp.

Where more than one guide is held in place by a single clamp, secure each remaining guide with a strip of tape around the diameter of the ball nut to prevent accidental guide removal before you are ready for that circuit.

Remove both halves of the guide simultaneously to prevent distortion to either half. Catch all the balls from this circuit on the cloth by rotating the screw or ball nut slowly. Place the removed components into a container. Identify the container, the guide, and the circuit of the ball nut so the components can be reassembled in the same circuit from which they were removed. Repeat for each circuit.

## Maintenance and Service

### General Description

A Thomson ball screw is a force and motion transfer device belonging to the family of power transmission screws. It replaces sliding friction of the conventional power screw with the rolling friction of bearing balls. The balls circulate in hardened steel races formed by concave helical grooves in the screw and nut. All reactive loads between the screw and nut are carried by the balls which provide the only physical contact between these members.

As the screw and the nut rotate relative to each other, the balls are diverted from one end and carried by ball guides to the opposite end of the nut. This recirculation permits unrestricted travel of the nut in relation to the screw.

**Method I:** Ball nuts using a deflector return system are identified by threaded deflector studs extending through holes in the nut and the guide clamp. Lock nuts on the deflector studs are used to secure the clamps that hold the guides in place.

**Method II:** Ball nuts with pick-up fingers are identified by the finger projections integral with the guide. In this method, capscrew fasteners are used to fasten the clamp that holds the guide in place.

**Pick-up Finger Method:** Refer to the Component Inspection section.

**Deflector Method:** To remove the deflectors from the ball nut assembly, remove the ball nut from the screw shaft. The ball nut must be rotated since the deflectors engage loosely in the screw ball grooves and act as a thread. The deflectors now can be removed from the opposite ends of the ball nut so that you can use them for reference during component inspection.

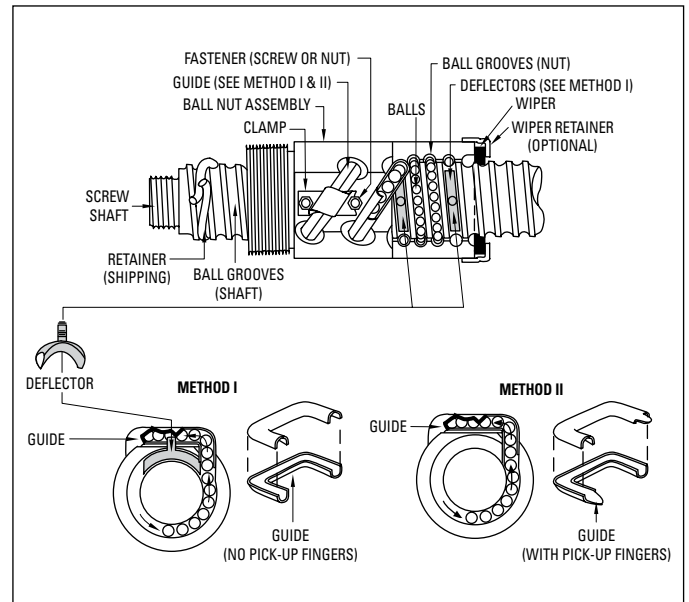

Figure 17

## Maintenance and Service

### Component Inspection and Replacement

**Balls:** If there is more than one circuit in the ball nut, count the balls in each of the separate containers to be sure each has the same number (within a variation of three balls). Check random samples (about 1/4 of the balls for a circuit) for the following:

- True roundness, with a .0001 in. maximum variation.
- Signs of scuffing or fish scaling.
- More than .0001 in. diameter variation between balls of the same circuit.

Where the random sampling shows balls out of round, signs of scuffing or variation of diameter in excess of .0001 in., or short count in any circuit, all balls in the unit must be replaced with a complete set of new balls. Ball kits are available from Thomson.

To ensure proper operation and long life of the serviced assembly, it is imperative that the diameters of all the replacement balls do not vary in excess of .00005 in. If Thomson kits are not used for service, make sure the balls meet the above specification. (Note: Use only chrome alloy steel balls, Grade 25 or better. Carburized balls or carbon steel balls will not provide adequate life.) See Ball Chart table.

**Deflectors:** Examine the ends of the deflectors for wear or brinelling. Wear can be determined by comparison with the unused ends of the two outside deflectors. Since these ends have not been subjected to wear from balls, they are in a like-new condition. Where wear or brinelling is evident, it is best to replace the deflectors with new ones.

**Pick-up Fingers:** Inspect the pick-up fingers, which consist of short extensions at the end of the guides. Replace with new guides if a ball brinell impression appears on the tip. Remove any burrs on the fingers. If the guides were distorted during removal, replace with new guides.

**Ball Nut:** Inspect the internal threads of the ball nut for signs of excessive wear, pitting, gouges, corrosion, spalling, or brinelling in the ball groove area. On large ball nuts, running the tip of your finger along the groove which is accessible will enable you to detect a secondary ridge in the ball groove area when wear is excessive or brinelling has occurred. (The extended lead of a mechanical pencil can also be used as a groove probe.) If inspection indicates any of these flaws, the ball nut assembly should be replaced.

**Wipers:** Prolonged use and environmental conditions will generally determine the condition of wipers. After cleaning wipers, reassemble over the screw shaft to determine whether a snug fit is maintained over the complete contour of the screw shaft. Any loose fitting or worn wipers should be replaced. Wiper kits are available for Thomson ball screws.

Note: If the assemblies have had extended use, it is recommended that all low cost items be replaced with new parts (i.e., balls, guides, deflectors, clamps). These can be ordered by simply referring to the assembly part number purchased.

### Reassembly

**Cleaning:** Clean all components with a commercial solvent and dry thoroughly before reassembly.

**Deflector Method:** Where the ball nut is equipped with deflectors, install these and secure temporarily by running the lock nuts down the studs and tightening.

**General Instructions:** Position the ball nut on the screw shaft. Ball nuts with deflectors have to be screwed on. Other ball nuts will slide on.

Using dowels with an O.D. approximately equal to the diameter of the balls, center the ball nut grooves with the shaft grooves by inserting dowels into each of the ball nut return circuit holes.

Remove the second dowel from one end. With the ball return holes up, fill the circuit with balls from the container corresponding to that circuit. Turning the screw in the ball nut will help to feed the balls into the groove. When the circuit is full, the balls will begin to lift the end dowel from its position. To be sure there are no voids, lightly tap the top bearing ball and see if the end dowel moves.

The remaining ball in the container should fit into one of the halves of the return guide with space for about three to six left.

Note: There must be some free space in the ball circuit so the balls will roll and not skid. Do not try to add extra balls into the circuit.

Place a dab of bearing grease at each end of the half return guide to hold the balls in place. Now, take the other half of the return guide and place it over the half guide you have filled with balls and insert two ends of the ball guide into the respective hole in the ball nut. Seat by tapping gently with a rawhide or plastic mallet.

Note: Where more than one ball circuit must be filled in the ball nut, tape the ball return circuit to the ball nut to prevent accidental removal. Repeat the filling procedure for the remaining circuits.

With all ball circuits filled and all return guides in place, secure the return guides with the retaining clamp.

**CAUTION:** Care should be taken to ensure that balls are not accidentally trapped between circuits in units having pick-up fingers. In deflector units, the deflectors will fill this space.

**Inspection:** Wrap tape around the ball grooves at the ends of the screw shaft to prevent the ball nut from rolling off. Now inspect the assembly for free movement of the ball nut along the entire stroke. There should be no binding, squeal, or roughness at any point.

**Reducing Backlash:** Backlash can be reduced by replacing all the balls with a larger size. If the diameters of the bearing balls are increased by .001 in., backlash is decreased by .003 in. (Ball kits are available for these applications.)

## Maintenance and Service

### Ball Chart (Grade 25 or Better)

Size (Inches)	Part Number	Nominal Diameter (Inches)	Number of Balls
.187 x .050	<b>7821609</b>	0.039	30
.187 x .062	<b>7821579</b>	0.039	30
.375 x .125	<b>5709574</b>	0.063	62
.375 x .125	<b>5709576</b>	0.063	62
.375 x .125	<b>5709578</b>	0.063	62
.375 x .125	<b>8103-448-017</b>	0.078	49
.375 x .125	<b>8103-448-018</b>	0.078	49
.375 x .125	<b>8103-448-003</b>	0.078	108
.375 x .125	<b>8103-448-013</b>	0.078	108
.500 x .200	<b>8105-448-013</b>	0.125	96
.500 x .200	<b>8105-448-008</b>	0.125	192
.500 x .200	<b>8105-448-023</b>	0.125	46
.500 x .500	<b>8105-448-014</b>	0.125	108
.500 x .500	<b>8105-448-011</b>	0.125	146
.500 x .500	<b>8105-448-016</b>	0.125	146
.631 x .200	<b>8106-448-022</b>	0.125	68
.631 x .200	<b>8106-448-026</b>	0.125	68
.631 x .200	<b>5707645</b>	0.125	67
.631 x .200	<b>8106-448-009</b>	0.125	70
.631 x .200	<b>8106-448-008</b>	0.125	70
.631 x .200	<b>8106-448-036</b>	0.125	136
.631 x .200	<b>8106-448-012</b>	0.125	140
.631 x .200	<b>8106-448-015</b>	0.125	140
.631 x .200	<b>8106-448-019</b>	0.125	140
.631 x .200	<b>7832872</b>	0.138	42
.631 x 1.000	<b>7826713</b>	0.125	46
.631 x 1.000	<b>7827531</b>	0.125	92
.750 x .200	<b>8107-448-018</b>	0.125	86
.750 x .200	<b>8107-448-026</b>	0.125	86
.750 x .200	<b>8107-448-016</b>	0.125	86
.750 x .200	<b>8107-448-027</b>	0.125	172
.750 x .200	<b>8107-448-046</b>	0.125	172
.750 x .200	<b>8107-448-025</b>	0.125	172
.750 x .500	<b>8107-448-014</b>	0.156	152
.750 x .500	<b>8107-448-020</b>	0.156	152
.750 x .500	<b>8107-448-049</b>	0.156	152
.750 x .500	<b>8107-448-048</b>	0.156	152
.750 x .500	<b>8107-448-011</b>	0.156	304
.875 x .200	<b>7833677</b>	0.125	168
.875 x .200	<b>5708277</b>	0.125	184
1.000 x .250	<b>8110-448-091</b>	0.156	86
1.000 x .250	<b>8110-448-055</b>	0.156	86
1.000 x .250	<b>8110-448-032</b>	0.156	89
1.000 x .250	<b>8110-448-030</b>	0.156	89
1.000 x .250	<b>8110-448-056</b>	0.156	171
1.000 x .250	<b>8110-448-026</b>	0.156	182
1.000 x .250	<b>8110-448-024</b>	0.156	182
1.000 x .250	<b>8110-448-087</b>	0.156	182
1.000 x .250	<b>8110-448-088</b>	0.156	182
1.000 x .250	<b>7820426</b>	0.156	168
1.000 x .250	<b>7820428</b>	0.156	168
1.000 x .250	<b>7823586</b>	0.156	170
1.000 x .500	<b>8110-448-022</b>	0.156	196
1.000 x .500	<b>8110-448-016</b>	0.156	392
1.000 x 1.000	<b>8110-448-086</b>	0.156	100
1.000 x 1.000	<b>8110-448-020</b>	0.156	152
1.000 x 1.000	<b>8110-448-034</b>	0.156	152

Size (Inches)	Part Number	Nominal Diameter (Inches)	Number of Balls
1.150 x .200	<b>8111-448-006</b>	0.125	252
1.150 x .200	<b>7823587</b>	0.125	224
1.150 x .200	<b>8111-448-004</b>	0.125	504
1.171 x .413	<b>5707511</b>	0.281	60
1.500 x .250	<b>7833233</b>	0.156	230
1.500 x .250	<b>5701990</b>	0.156	230
1.500 x .250	<b>7833234</b>	0.156	464
1.500 x .250	<b>5704573</b>	0.156	464
1.500 x .473	<b>5707513</b>	0.344	86
1.500 x .500	<b>8115-448-016</b>	0.312	140
1.500 x .500	<b>8115-448-018</b>	0.312	140
1.500 x .500	<b>8115-448-006</b>	0.312	280
1.500 x 1.000	<b>5708280</b>	0.344	60
1.500 x 1.000	<b>5701995</b>	0.344	60
1.500 x 1.000	<b>7833724</b>	0.344	60
1.500 x 1.000	<b>8115-448-014</b>	0.344	68
1.500 x 1.000	<b>8115-448-049</b>	0.344	68
1.500 x 1.000	<b>5700698</b>	0.344	120
1.500 x 1.000	<b>8115-448-011</b>	0.344	136
1.500 x 1.875	<b>5707654</b>	0.281	84
1.500 x 1.875	<b>5704272</b>	0.281	168
1.500 x 2.000	<b>8115-448-056</b>	0.281	96
1.500 x 2.000	<b>8115-448-057</b>	0.281	96
2.000 x .500	<b>8120-448-011</b>	0.375	150
2.000 x .500	<b>8120-448-013</b>	0.375	150
2.000 x .500	<b>8120-448-006</b>	0.375	300
2.000 x .500	<b>8120-448-007</b>	0.375	300
2.000 x 1.000	<b>8120-448-021</b>	0.375	160
2.000 x 1.000	<b>8120-448-019</b>	0.375	320
2.250 x .500	<b>7833235</b>	0.375	154
2.250 x 1.000	<b>5704555</b>	0.375	164
2.500 x .250	<b>5703243</b>	0.156	468
2.500 x .250	<b>7823590</b>	0.156	936
2.500 x .500	<b>8125-448-010</b>	0.375	184
2.500 x 1.000	<b>8125-448-008</b>	0.375	194
3.000 x .660	<b>8130-448-007</b>	0.500	180
3.000 x 1.500	<b>5704986</b>	0.500	166
4.000 x 1.000	<b>5703258</b>	0.625	186
.375 x 3	<b>5706900 / 7828127</b>	0.156	54
.625 x 3	<b>5707445 / 7828128</b>	0.187	60
.625 x 6	<b>5708943 / 7828129</b>	0.187	120
1.000 x 3	<b>5707472 / 7828130</b>	0.187	78
1.000 x 6	<b>5708944 / 7828131</b>	0.187	156
1.500 x 3	<b>5707528 / 7828132</b>	0.250	84
1.500 x 6	<b>5708945 / 7828133</b>	0.250	168
2.000 x 3	<b>5707530 / 7828134</b>	0.312	72
2.000 x 6	<b>5708946 / 7828135</b>	0.312	144
2.500 x 3	<b>5707532 / 7828136</b>	0.375	66
2.500 x 6	<b>5708947 / 7828137</b>	0.375	132
4.062 x 6	<b>5708330 / 7828138</b>	0.375	180
6.000 x 8	<b>5704798 / 7828140</b>	0.500	224



## Maintenance and Service

Size (mm)	Part Number	Nominal Diameter (mm)	Number of Balls
16 x 5	7832777	3.500	42
20 x 5	7832780	3.500	54
20 x 20	7832784	3.500	100
25 x 5	7832787	3.500	66
25 x 10	7832791	3.500	164
25 x 25	7832794	3.500	120
32 x 5	7832796	3.500	116
32 x 10	7832799	5.556	54
32 x 20	7832803	5.556	136
32 x 32	7833300	3.969	124
40 x 5	7832805	3.500	180
40 x 10	7832809	7.144	72
40 x 20	7832812	5.556	156
40 x 40	7832815	7.144	96
50 x 10	7832818	7.144	88
50 x 20	7832821	6.350	164
63 x 10	7832823	7.144	140
63 x 20	7832826	7.144	186
80 x 10	7832828	7.144	210
16 x 5	7832835	3.500	56
20 x 5	7832838	3.500	108
25 x 5	7832841	3.500	132
32 x 5	7832862	3.500	232
32 x 10	7832844	5.500	108
40 x 5	7832847	3.500	360
40 x 10	7832850	6.350	160
50 x 10	7832853	7.144	176
63 x 10	7832856	7.144	280
80 x 10	7832859	7.144	420
12 x 10	KGF-D-1210-RH-EE	2.000	63
16 x 5	KGF-D-1605-RH-EE	3.500	45
16 x 10	KGF-D-1610-RH-EE	3.000	102
20 x 5	KGF-D-2005-RH-EE	3.500	48
25 x 5	KGF-D-2505-RH-EE	3.500	63
25 x 10	KGF-D-2510-RH-EE	3.500	75
25 x 20	KGF-D-2520-RH-EE	3.500	80
25 x 25	KGF-D-2525-RH-EE	3.500	130
25 x 50	KGF-D-2550-RH-EE	3.500	130
32 x 5	KGF-D-3205-RH-EE	3.500	140
32 x 10	KGF-D-3210-RH-EE	7.140	42
32 x 20	KGF-D-3220-RH-EE	5.000	84
32 x 32	KGF-D-3232-RH-EE	3.969	124
40 x 5	KGF-D-4005-RH-EE	3.500	180
40 x 10	KGF-D-4010-RH-EE	7.140	54
40 x 20	KGF-D-4020-RH-EE	5.000	104
40 x 40	KGF-D-4040-RH-EE	3.500	360
50 x 10	KGF-D-5010-RH-EE	7.140	115
50 x 20	KGF-D-5020-RH-EE	7.140	100
63 x 10	KGF-D-6310-RH-EE	7.144	140
63 x 20	KGF-D-6320-RH-EE	7.140	96

Size (mm)	Part Number	Nominal Diameter (mm)	Number of Balls
16 x 5	KGF-N-1605-RH-EE	3.500	45
20 x 5	KGF-N-2005-RH-EE	3.500	48
20 x 20	KGF-N-2020-RH-EE	3.500	100
20 x 50	KGF-N-2050-RH-EE	3.500	140
25 x 5	KGF-N-2505-RH-EE	3.500	63
32 x 5	KGF-N-3205-RH-EE	3.500	140
32 x 10	KGF-N-3210-RH-EE	7.140	42
32 x 40	KGF-N-3240-RH-EE	3.500	168
40 x 5	KGF-N-4005-RH-EE	3.500	180
40 x 10	KGF-N-4010-RH-EE	7.140	54
50 x 10	KGF-N-5010-RH-EE	7.140	115
63 x 10	KGF-N-6310-RH-EE	7.140	140
80 x 10	KGF-D-8010-RH-EE	7.144	175
12 x 10	KGM-D-1210-RH-EE	2.000	63
16 x 5	KGM-D-1605-RH-EE	3.500	45
16 x 10	KGM-D-1610-RH-EE	3.000	102
20 x 5	KGM-D-2005-RH-EE	3.500	48
25 x 5	KGM-D-2505-RH-EE	3.500	63
25 x 10	KGM-D-2510-RH-EE	3.500	75
25 x 20	KGM-D-2520-RH-EE	3.500	80
25 x 25	KGM-D-2525-RH-EE	3.500	130
25 x 50	KGM-D-2550-RH-EE	3.500	130
32 x 5	KGM-D-3205-RH-EE	3.500	140
40 x 5	KGM-D-4005-RH-EE	3.500	180
40 x 10	KGM-D-4010-RH-EE	7.140	54
40 x 20	KGM-D-4020-RH-EE	5.000	104
40 x 40	KGM-D-4040-RH-EE	3.500	360
50 x 10	KGM-D-5010-RH-EE	7.144	155
63 x 10	KGM-D-6310-RH-EE	7.144	140
63 x 20	KGM-D-6320-RH-EE	7.140	96
12 x 5	KGM-N-1205-RH-OO	2.000	60
20 x 5	KGM-N-2005-RH-EE	3.500	48
20 x 20	KGM-N-2020-RH-EE	3.500	100
20 x 50	KGM-N-2050-RH-EE	3.500	140
25 x 5	KGM-N-2505-RH-EE	3.500	63
32 x 5	KGM-N-3205-RH-EE	3.500	140
32 x 10	KGM-N-3210-RH-EE	7.140	42
32 x 20	KGM-N-3220-RH-EE	5.000	84
32 x 40	KGM-N-3240-RH-EE	3.500	168
40 x 5	KGM-N-4005-RH-EE	3.500	180
50 x 10	KGM-N-5010-RH-EE	7.140	115
50 x 20	KGM-N-5020-RH-EE	7.140	100
63 x 10	KGM-D-6310-RH-EE	7.144	140
80 x 10	KGM-D-8010-RH-EE	7.144	175
12 x 4	7832771	1.984	57
16 x 5	7832778	3.500	56
20 x 5	7832781	3.500	72
25 x 5	7832788	3.500	110
25 x 10	7832792	3.500	55
32 x 5	7832797	3.500	145
32 x 10	7832800	5.556	72
40 x 5	7832806	3.500	180
40 x 10	7832810	7.144	90
40 x 20	7833723	5.556	80
50 x 10	7832819	7.144	132
63 x 10	7832824	7.144	168
80 x 10	7832829	7.144	210

## Maintenance and Service

**Inspection and Existing Preload Check:** Whenever possible, the complete ball screw assembly should be removed from the machine prior to a thorough inspection. Preliminary screw inspection can be made while the unit is still in the machine. Preload can be determined by measuring movement of the nut in respect to the screw shaft. Clamp an indicator to the screw shaft with its probe resting on the face of the nut. Apply a load to the machine carriage in both directions. Be sure that the screw cannot rotate or move axially. Any measurable backlash between the ball nut and screw is an indication that preload does not exist. (See Figure 18.)

If no backlash exists, proceed further as outlined to determine whether proper preload remains in the unit. Existing preload,  $W_p$ , can be determined by measuring torque,  $T_p$ , using the following formula:

$$W_p = \frac{T_p}{.007}$$

where:  $W_p$  = Preload force, in lb.  
 $T_p$  = Torque, in lb-in. (due to preload only)

**Note:** The above check is to determine preload only, and does not take into account torque due to seal drag or operating load.

Torque can be measured by means of a spring scale mounted to any projection on the ball nut or by means of a lever or rod secured to the ball nut. In taking this measurement, be sure the exact lever arm distance is measured. (See Figure 18.) This measurement (inch) multiplied by the scale reading (lb.) equals  $T_p$  (torque lb-in.). Existing preload can now be determined using the above formula.

Preload adjustment of a Precision ball screw (Figure 18) requires no disassembly. Possible removal of the ball nut from the machine housing may be necessary to expose the adjusting nut.

**Disassembly:** If in doubt about disassembly of preloaded ball nuts, contact Thomson Application Engineering. If the unit is to be disassembled for general repair, follow the steps previously outlined in this section.

If being disassembled for preload adjustment, follow the guidelines except remove only one-half of the ball nut assembly to an arbor. If a standard arbor is not available, one can be made from a piece of shafting or tubing with a diameter approximately .005 inch less than the root diameter of the ball grooves in the screw shaft. Both halves of the ball nut will come apart as soon as the last ball in the nut is free of the grooves in the screw shaft. It is not necessary to remove the other half from the screw.

**Preload Adjustment:** The adjusting nut unit in Figure 18 can be adjusted to the desired preload with the use of additional shims. To make further adjustment, loosen the set screw lock located on the periphery of the lock nut. Use a spanner wrench to rotate the adjusting nut to the desired setting. Recheck the preload.

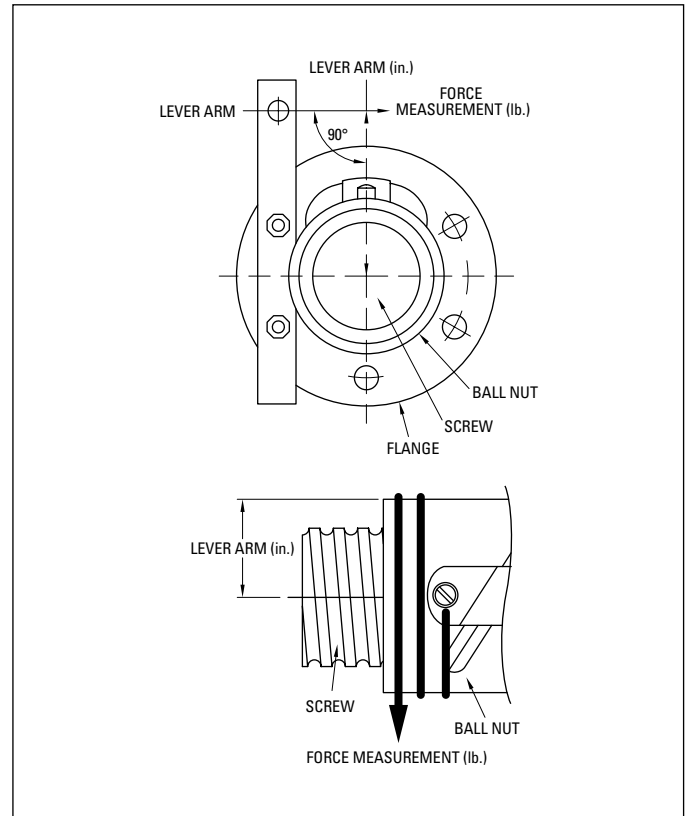

Figure 18

For all other standard units in Figure 18, a shim increase of .001 inch will, as a general rule, increase preload by 500 to 1,000 lb. This varies depending upon screw size; therefore, some judgement and trial and error may be necessary before the desired preload is achieved.

Preload force,  $W_p$ , can be determined by measuring torque,  $T_p$ , after the desired preload has been established using the following formula:

$$T_p = .007 \times W_p$$

where:  $T_p$  = torque, lb-in. (due to preload only)  
 $W_p$  = preload force, lb.

This section is intended to provide basic necessary information to properly service and maintain Thomson ball screws. Other forms of preloaded units may be encountered which have been designed for particular applications. Please contact Thomson Application Engineering for other specific information.



## Lubrication

### Guidelines

Ball screws must be lubricated to operate properly and achieve the rated life. We recommend using TriGEL-450R or TriGEL-1800RC for lubricating ball screws. Other oils and greases may be applicable but have not been evaluated.

The TriGEL® grease can be applied directly to the screw threads near the root of the ball track. Some ball nut sizes are available with threaded lube holes for mounting lubrication fittings. For these ball nuts, the TriGEL grease can be pumped directly into the nut. Please refer to the catalog detail views to verify which ball nuts have the threaded lube holes. It is recommended to use these nuts in conjunction with a wiper kit to contain the lubricant in the body of the nut.

### Lubrication

**Inspection Prior to Lubrication:** All ball screw assemblies should run smoothly throughout the entire stroke. If the torque is not uniform over the entire stroke:

- Visually inspect the screw shaft for accumulations of foreign matter.
- Using cleaning fluid or solvent, remove dirt from the ball grooves. Be sure to flush the ball nut assembly thoroughly.
- Cycle the ball nut along the screw shaft several times. Wipe with a dry, lintless cloth and lubricate immediately.
- If the assembly continues to operate erratically after cleaning, contact Thomson for further instructions.

**Lubrication:** The operating environment primarily determines the frequency and type of lubrication required by ball screws. The screw shaft should be inspected frequently and lubricated as required by the environmental conditions present. Lubricants can vary from instrument grade oil for dirty and heavy-dust environments to a good grade ball bearing grease for protected or clean environments. For most



applications, a good 10W30 oil periodically wiped on the screw shaft with a damp cloth or applied by a drip or mist lubricator will suffice.

**CAUTION:** Where the screw is unprotected from airborne dirt, dust, etc., do not leave a heavy film of lubricant on the screw. Keep the screw shaft barely damp with lubricant. Inspect at regular intervals to be certain lubricating film is present. Where the application requires operation at temperatures below 0° F, an instrument grade oil is recommended. Operating environments from 0° F to 180° F will require a good grade 10W30 oil. For assemblies with balls larger than 3/8 in. diameter, MIL G 3278 grease is recommended. Bearing grease is recommended for operating environments at nominally higher temperatures. Again, in unprotected conditions, the lubricant is best applied with a lubricant-dampened cloth, taking care not to leave an excessive film thickness on the screw. Ball screws should never be run dry.

### Lubrication Selection Chart for Ball & Lead Screw Assemblies

Thomson Gel Type	TriGel-300S	TriGel-450R	TriGel-600SM	TriGel-1200SC	TriGel-1800RC
Application	Acme Screws Supernuts, Plastic Nuts	Ball Screws, Linear Bearings	Bronze Nuts	Acme Plastic Nuts, Clean Room, High Vacuum	Ball Screws, Linear Bearings, Bronze Nuts, Clean Room, Vacuum
Maximum Temperature*	200°C (392°F)	125°C (257°F)	125°C (257°F)	250°C (482°F)	125°C (257°F)
Mechanism Materials	Plastic on Plastic or Metal	Metal on Metal	Metal on Metal Bronze on Steel	Plastic or Metals, Combination	Metal on Metal
Mechanical Load	Light	Moderate	Moderate to Heavy	Light to Moderate	Moderate
Very Low Torque Variation over Temperature	Yes	—	—	Yes	—
Very Low Starting Torque	Yes	Yes	—	Yes	Yes
Compatibility with Reactive Chemicals	Not recommended w/o OEM testing	Not recommended w/o OEM testing	Not recommended w/o OEM testing	Usually OK	Not recommended w/o OEM testing
Compatibility with Plastics and Elastomers	May cause silicon rubber seals to swell	May cause EPDM seals to swell	May cause EPDM seals to swell	Usually OK	May cause EPDM seals to swell
Clean Room Use	Not recommended	Not recommended	Not recommended	Usually OK	Usually OK
High Vacuum Use	Not recommended	Not recommended	Not recommended	Usually OK	Usually OK
Vapor Pressure (25°C)	Varies with lot	Varies with lot	Varies with lot	8x10 <sup>-3</sup> torr	4x10 <sup>-3</sup> torr
Order Number 10cc Syringe 1 Pound Tube 4oz Tube	TriGel-300S TriGel-300S-1 NA	TriGel-450R TriGel-450R-1 NA	NA NA TriGel-600SM	TriGel-1200SC NA NA	TriGel-1800RC NA NA

\* Maximum temperature for continuous exposure. Higher surge temperatures may be permissible but should be validated in the actual end use by the OEM. Low temperature limits are -15°C or lower. Consult Thomson for specifics.

## Glossary/Formulas

### Accuracy

A measurement of precision. Perfect accuracy, for example, means advancing a ball nut 1 in. from any point on a screw will always require the exact same number of revolutions.

### Annealed Ends

A manufacturing process which removes brittleness while softening screw stock to allow for machining of end journals.

### Arbor or Mandrel

Temporary shaft used to support ball nut during shipping assembly/disassembly.

### Axial Lash/Backlash

The axial free motion between the ball nut and ball screw; a measure of system stiffness and repeatability.

### Backdrive

Application of a force on a ball nut to cause rotation of the screw shaft; in essence, converting linear to rotary motion.

### Ball Bearing Spline

A linear motion device using the rolling contact principle. In a spline, the path of the bearings is parallel to the shaft to allow axial freedom and to provide torque transmitting capacity.

### Ball Circle Diameter

The distance between the centerlines of two exactly opposing recirculating balls when they are in contact with the screw. The basic point of reference used by Thomson when dealing with ball screws.

### Ball Nut

A nut compatible with a ball screw. The nut contains a series of bearing balls which are carried from one end of the nut to the other by a return tube.

### Ball Screw

A ball bearing screw is a screw that runs on bearing balls. The primary function of a ball bearing screw is to convert rotary motion to linear motion or torque to thrust.

### Bearing Ball Circuit

The closed path of recirculating balls within the ball nut assembly. A multiple circuits has a greater load carrying capability than a single circuit ball nut assembly of the same.

### Compression Load

Compression load is a load which would tend to compress or buckle the ball screw shaft.

### Conformity Ratio

Ratio of the ball track radius to the ball diameter.

### Contact Angle

Nominal angle between a plane perpendicular to the screw and a line drawn between a ball and the ball tracks and projected on a plane passing through the screw axis and the center of the ball. The angle at which the ball contacts the groove.

### Column Load

Column loading is the compression load on the screw. This load has a tendency to buckle the screw and is dependent on screw diameter, screw length and type of mounting.

### Critical Speed

The condition where the rotary speed of the assembly sets up harmonic vibrations. These vibrations are the result of shaft diameter, unsupported length, type of bearing support, ball nut mounting method, or the shaft or ball nut rpm. Vibrations may also be caused by a bent screw or faulty installation alignment.

### Cycle

The complete forward and reverse motion of the screw (or nut) when moving the load. One cycle is equivalent to two load carrying strokes (one forward and one backward).

### Diameter — Major

The outside diameter of the ball bearing screw shaft. In dealing with ball bearing screws, this is the basic measurement.

### Diameter — Minor (Root)

Diameter of the screw measured at the bottom of the ball track.

### Diameter — Pitch

The nominal diameter of a theoretical cylinder passing through the centers of the balls when they are in contact with the ball bearing screw and ball nut tracks.

### Driving Torque

The amount of effort, measured in pound-inches, required to turn the ball screw and move the load.

### Dynamic Load Rating

Dynamic load rating is the maximum load which a ball bearing screw assembly can maintain for 1.0 million inches of travel (Inch Series) or 1.0 million revolutions (Metric Series).

### Efficiency

Expressed as a percentage, the ability of a ball screw assembly to convert torque to thrust with minimal mechanical loss. Thomson ball screws operate at over 90% efficiency.

### End Bearing Support (End Fixity)

The three basic bearing configurations that are commonly used to support the ends of a ball screw are.

- a) A single journal or ball type bearing (simple support).
- b) A pair of back-to-back, angular contact bearings to control end play (simple support).
- c) A pair of spaced bearings for added rigidity (rigid support)

Four combinations of bearing supports are used throughout this catalog for selection purposes.

### Flange

A metal mounting plate attached to a ball nut.

### Gothic (or Ogival) Groove

A ball track cross-section shaped like a Gothic arch.

### Journal

1. A machined cylindrical surface.
2. End journals are machined ends of ball bearing screws which allow for bearing mounting.

### Land Area

The area on the outside diameter of a ball bearing screw between ball grooves.

### Lead

The axial distance a screw travels during one revolution.

### Lead Error

The amount of positional error per foot (Inch Series) or per 300mm (Metric Series) that is inherent in linear motion on ball screws.

### Glossary/Formulas

#### Lead Tolerance

The maximum variation from nominal, measured in inches per foot, cumulative.

#### Left (Right) Hand Threads

The direction of threads on a shaft or in a nut. Left hand means that the nut will move away if rotated counterclockwise. Right hand means the nut will move away if rotated clockwise.

#### Linear Expansion

Ball screw and spline inner races have a coefficient of linear expansion of 0.0000065 for each degree of change (F) and for each inch of race length.

#### Load Carrying Balls

The balls in contact with the ball grooves of both the nut and the screw for load carrying purposes.

#### Load/Life Rating

The usable life of a ball bearing screw assembly measured in inches of travel under a specific load. The length of travel that 90 percent of a group of ball bearing screws will complete, or exceed, before the first evidence of fatigue develops.

#### Lubrication

To provide the maximum useful life, ball splines and ball screws require lubrication. In general, standard ball bearing lubrication practices are acceptable.

#### Off Center Load (Eccentric)

A load tending to cock the ball nut on the screw, reducing the rated life. This must be considered in the selection of the ball screw assembly.

#### Operating Loads

The normal operating force in pounds (lb.) or Newtons (N) which the ball spline or ball screw will experience is considered the operating load. Contact us for assistance in applications subject to widely fluctuating loads or to optimize design.

#### Preload

The use of one group of bearing balls set in opposition to another to remove axial lash or backlash and increase ball bearing screw stiffness. All axial backlash is eliminated in preloading.

#### Protective Coatings

Standard outer races are supplied with a black oxide coating. Inner races are furnished with a phosphate coating. Contact Application Engineering for additional options.

#### Repeatability

A measure of constancy that is directly related to axial backlash. Higher backlash equates to lower repeatability and may be corrected by preloading the ball nut if required.

#### Root Diameter

The diameter of the screw shaft as measured at the bottom of the ball track.

#### Screw Diameter (land diameter)

The outside diameter of the screw shaft.

#### Screw Starts

The integral number of independent threads on the screw shaft; typically one, two, or four.

#### Side Load (radial)

A load from the side that will reduce the rated life and must be considered in the selection of the ball bearing screw.

#### Spring Rate

A ratio of load versus deflection of a component or of a total system. System stiffness will always be less than its most compliant member. Thus, in any system where a ball screw is used and where high system stiffness is a primary design requirement, Thomson should be contacted for recommendations based on the specifics of the application.

#### Static Load

Static load is the maximum non-operating load capacity above which brinelling of the ball track occurs.

#### Straightness

The linearity of a screw shaft. Precision screw stock is .010 in/ft. with .040 inch max. Precision Plus stock is typically .003 inch over the entire length of the screw.

#### Stroke

The maximum length of extension of a ball nut on the screw shaft.

#### Temperature (operating)

With suitable lubricants, ball splines and ball screws will operate with a minimum loss of efficiency between temperatures of -65° to +300°F (-53° to +149°C). Contact our application engineers for assistance in applications with extreme temperatures.

#### Tension Load

Tension load is a load which would tend to stretch the ball screw shaft.

#### Thrust Load

Thrust load is loading parallel to and concentric with the centerline of the screw shaft which acts continuously in one direction. Thrust loading is the proper method of attaching the load to the ball bearing screw assembly.

#### Travel and Travel Rate

The distance a ball nut moves relative to the screw shaft. Travel rate is the distance traveled in a specific time period.

## Glossary/Formulas

### Some Useful Formulas for Ball Screw Assemblies

#### Torque, Rotary to Linear

Rotating the screw to translate the nut, or rotating the nut to translate the screw.

##### Ball Screw Assemblies

$$\text{Torque (in lbs)} = .177 \times \text{Load (lbs)} \times \text{Lead (inches)}$$

##### Lead Screw Assemblies

$$\text{Torque (in lbs)} = \frac{\text{Load (lbs)} \times \text{Lead (inches)}}{2\pi \times \text{efficiency}^*}$$

\* Acme screw efficiency is variable with the helix angle of the threads, the friction of the material and the finish. See the efficiency formula below.

#### Torque, Linear to Rotary

Translating the screw to rotate the nut, or translating the nut to rotate the screw.

##### Ball Screw Assemblies

$$\text{Torque (in lbs)} = .143 \times \text{Load (lbs)} \times \text{Lead (inches)}$$

##### Lead Screw Assemblies

$$\text{Torque (in lbs)} = \frac{\text{Load} \times \text{Lead} \times \text{Efficiency}}{2\pi}$$

The higher the lead of the screw the less effort required to backdrive either the screw or the nut.  
 As a rule, the lead of the screw should be more than 1/3 the diameter of the screw to satisfactorily backdrive.

#### Efficiency

##### Ball Screw Assemblies

Most ball screw assemblies are better than 90% efficient.

##### Lead Screw Assemblies

$$\% \text{ Efficiency} = \frac{\tan(\text{helix angle})}{\tan(\text{helix angle} + \arctan f)} \times 100$$

f = coefficient of friction

#### Horsepower

##### Torque to Horsepower

$$\text{hp} = \frac{\text{Torque (in lbs)} \times \text{rpm}}{63,000}$$

##### Horsepower to Torque

$$\text{Torque} = \frac{63,000 \times \text{hp}}{\text{rpm}}$$

#### Column Load Strength\*

(Based on Eulers Formula)

$$P_{cr} = \frac{1.405 \times 10^7 \times F_c \times d^4}{L^2}$$

$P_{cr}$  = maximum loads (lbs)

$F_c$  = end support factor

.25 one end fixed, other free

1.00 both ends supported

2.00 one end fixed, other supported

4.00 both ends fixed

d = root diameter of screw (in.)

L = distance between nut and load carrying bearing (in.)

When possible, design for tension loads to eliminate the buckling factor and reduce the required screw size

#### Critical Screw Shaft Speed

(Maximum rotational speed of screw)

$$C_s = F_c \times 4.76 \times 10^6 \times \frac{d}{L^2}$$

$C_s$  = critical speed (rpm)

d = root diameter of screw (in.)

L = length between supports (in.)

$F_c$  = end support factor

.36 one end fixed, other free

1.00 both ends supported

1.47 one end fixed, other supported

2.23 both ends fixed

Critical shaft speed should be reduced to 80% to allow for other factors such as alignment and straightness

\* Formula only valid if  $L/d \geq 18.25$ .

**NOTES:**



**NOTES:**

