

Temposonics®

Magnetostrictive, Absolute, Non-contact
Linear-Position Sensors



R-Series Models RP and RH
EtherNet/IP™ Industrial Ethernet Interface

Document Part Number
551253 Revision A

Data Sheet



Model RP Profile-style position sensor



Model RH Rod-style position sensor

EtherNet/IP™
conformance tested

FEATURES

- Linear, Absolute Measurement
- LEDs For Sensor Diagnostics
- Superior Accuracy, Resolution down to 1 μm
- Non-Contact Sensing Technology
- Linearity Deviation Less Than 0.01%
- Repeatability Within 0.001%
- Direct EtherNet/IP Interface, Position + Velocity

BENEFITS

- Rugged Industrial Sensor
- Position + Velocity Measurements For Up to 20 Magnets

APPLICATIONS

- Continuous Operation In Harsh Industrial Conditions
- High Pressure Conditions
- For Accurate, Simultaneous Multi-Position and Velocity Measurements

TYPICAL INDUSTRIES

- Factory Automation
- Fluid Power
- Plastic Injection and Blow Molding
- Material Handling and Packaging

Time-based Magnetostrictive position sensing principle

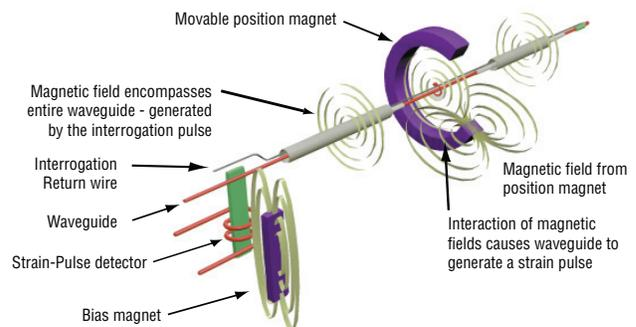

Benefits of Magnetostriction

Temposonics linear-position sensors use the time-based magnetostrictive position sensing principle developed by MTS. Within the sensing element, a sonic-strain pulse is induced in a specially designed magnetostrictive waveguide by the momentary interaction of two magnetic fields. One field comes from a movable permanent magnet that passes along the outside of the sensor. The other field comes from an “interrogation” current pulse applied along the waveguide. The resulting strain pulse travels at sonic speed along the waveguide and is detected at the head of the sensing element.

The position of the magnet is determined with high precision and speed by accurately measuring the elapsed time between the application of the interrogation pulse and the arrival of the resulting strain pulse with a high-speed counter. The elapsed time measurement is directly proportional to the position of the permanent magnet and is an absolute value. Therefore, the sensor's output signal corresponds to absolute position, instead of incremental, and never requires recalibration or re-homing after a power loss. Absolute, non-contact sensing eliminates wear, and guarantees the best durability and output repeatability.

EtherNet/IP™ is a trademark used under license by ODVA.
EtherNet/IP CONFORMANCE TESTED™ is a certification mark of ODVA.

Sold & Serviced By:

ELECTROMATE

Toll Free Phone (877) SERV098
Toll Free Fax (877) SERV099
www.electromate.com
sales@electromate.com

Product Overview and Specifications

Product overview

Temposonics R-Series EtherNet/IP™ sensors represent MTS Sensors' development and product offering in networked position feedback. EtherNet/IP™ systems require only a single point of connection for both configuration and control, because EtherNet/IP supports both I/O (or implicit) messages—those that typically contain time-critical control data—and explicit messages—those in which the data field carries both protocol information and instructions for service perfor-

mance. And, as a producer-consumer network that supports multiple communication hierarchies and message prioritization, EtherNet/IP™ provides more efficient use of bandwidth than a device network based on a source-destination model. EtherNet/IP systems can be configured to operate either in a master/slave or distributed control architecture using peer-to-peer communication.

Product specifications

Parameters	Specifications
OUTPUT	
Measured output variables:	Simultaneous multi-position and velocity measurements up to 20 magnets.
Resolution:	1 to 1000 µm selectable
Update time:	2.0 ms up to 4800 mm, 4.0 ms up to 7600 mm stroke length
Linearity deviation:	< ± 0.01% full stroke (minimum ± 50 µm)
Repeatability:	< ± 0.001% full stroke (minimum ± 2.5 µm)
Hysteresis:	< 4 µm
Outputs:	Interface: EtherNet/IP™ Data transmission rate: 100 Mbit/s max.
Stroke length:	Range (Profile style): 25 mm to 5080 mm (1 in. to 200 in.) Range (Rod style): 25 mm to 7620 mm (1 in. to 300 in.)
ELECTRONICS	
Operating voltage:	+24 Vdc nominal: -15% or +20% Polarity protection: up to -30 Vdc Over voltage protection: up to 36 Vdc Current drain: 110 mA typical Dielectric withstand voltage: 500 Vdc (DC ground to machine ground)

Parameters	Specifications
ENVIRONMENTAL	
Operating conditions:	Operating temperature: 0 °C (32 °F) to +75 °C (+167 °F) Relative humidity: 90% no condensation Temperature coefficient: < 15 ppm/ °C
EMC test:	Electromagnetic emission: EN 61000-6-4, CISPR 16 Electromagnetic susceptibility: EN 61000-6-2, EN 61000-4-2/3/4/6 CE qualified
Shock rating:	100 g (single hit)/IEC standard 68-2-27 (survivability)
Vibration rating:	15 g / 10 to 2000 Hz / IEC standard 68-2-6
WIRING	
Connection type:	D56 option: Two female 4-pin (M12-D) plus one 4-pin male (M8) connector
PROFILE STYLE SENSOR (MODEL RP)	
Electronic head:	Aluminum housing with diagnostic LED display (LEDs located beside connectors)
Sealing:	IP 65
Sensor extrusion:	Aluminum (Temposonics profile style)
Mounting:	Any orientation. Adjustable mounting feet or T-slot nut (M5 threads) in bottom groove
Magnet types:	Captive-sliding magnet or open-ring magnet
ROD STYLE SENSOR (MODEL RH)	
Electronic head:	Aluminum housing with diagnostic LED display (LEDs located beside connectors)
Sealing:	IP 67
Sensor rod:	304L stainless steel
Operating pressure:	350 bar static, 690 bar peak (5000 psi static, 10,000 psi peak)
Mounting:	Any orientation. Threaded flange M18 x 1.5 or 3/4 - 16 UNF-3A
Typical mounting torque:	45 N-m (33 ft. - lbs.)
Magnet types:	Ring magnet, open-ring magnet, or magnet float

Sold & Serviced By:



Toll Free Phone (877) SERV098
Toll Free Fax (877) SERV099
www.electromate.com
sales@electromate.com

Enhanced monitoring and diagnostics

SENSOR STATUS AND DIAGNOSTIC DISPLAY



Integrated green and red diagnostic LEDs are located beside the sensor's connectors as shown in 'Figure 1'; the LEDs provide basic visual monitoring for normal sensor operation and troubleshooting. These diagnostic display LEDs indicate four modes as described in 'Table 1. Diagnostic display indicator modes'

1. Diagnostic display indicator modes'

Figure 1. R-Series sensor Integrated diagnostic LEDs

EtherNet Port 1		
Green	On:	Ethernet connection established
Green	Flickering:	Data activity
Red	On:	Magnet not detected or wrong quantity of magnets
EtherNet Port 2		
Green	On:	Ethernet connection established
Green	Flickering:	Data activity
Network Status		
Green	On:	At least one connection established
Green	Flashing:	No connection established
Red	On:	Unrecoverable fault detected
Red	Flashing:	Recoverable fault detected
Module Status		
Green	On:	IP address configured
Green	Flashing:	IP address not configured
Red	Flashing:	Duplicate IP address detected

Table 1. Diagnostic display indicator modes

EtherNet/IP™ interface

EtherNet/IP™ is an Industrial Ethernet implementation of the Common Industrial Protocol (CIP), managed by the Open DeviceNet Vendors Association (ODVA), which defines communication services for automation. Ethernet/IP uses standard IEEE 802.3 technology at both the Physical Layer and Data Layers for compatibility with other applications and protocols. The protocol is also compliant with IEC 61158-2 for the physical layer and IEC 61784-1, -2 for measurement and control profiles.

Note:

Go to www.mtssensors.com to download latest EDS file.

This Ethernet/IP device also offers Device-Level-Ring (DLR) capability to directly connect devices to a ring topology without the use of external switches. DLR provides device-level network re-routing and failure point identification to improve reliability and network recovery time.

Operation modes and output

N101 Single and Multi-magnet position and velocity:

Up to 20 simultaneous magnet measurements are possible when using multiple magnets. The minimum allowed distance between magnets is 75 mm (3 in.) to maintain proper sensor output (see 'Figure 2').

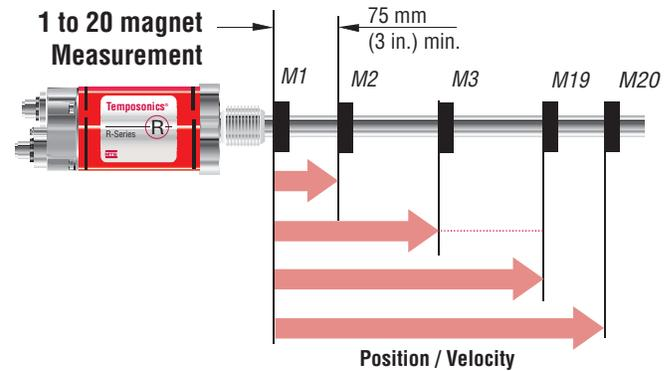

Figure 2. Single to multi-magnet output diagram

Model RP Profile-Style Sensor
Sensor Dimension References

Model RP profile-style sensor dimension references

MODEL RP, PROFILE-STYLE SENSOR WITH CAPTIVE-SLIDING MAGNET

Drawing is for reference only, contact applications engineering for tolerance specific information.

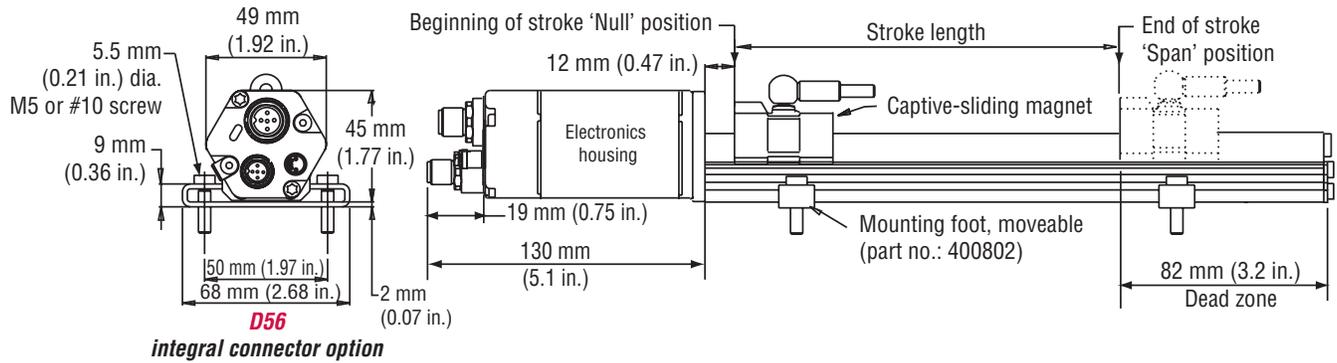

Figure 3. R-Series Model RP Profile-style sensor dimension reference (Shown with the **D56** connector option)

MODEL RP, PROFILE-STYLE SENSOR WITH OPEN-RING MAGNET

Drawing is for reference only, contact applications engineering for tolerance specific information.

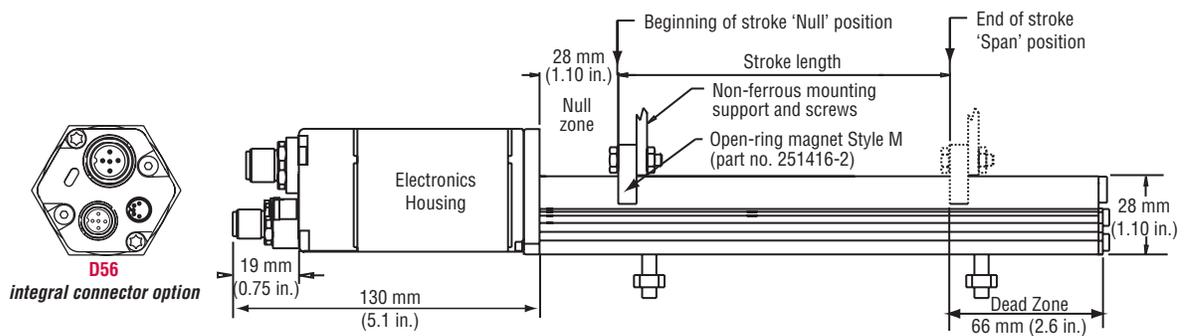

Figure 4. R-Series Model RP Profile-style sensor dimension reference (Shown with the **D56** connector option)

Standard magnet selections (Model RP)

SELECTION OF POSITION MAGNETS

A choice of two magnet mounting configurations are available with the profile-style sensor; A 'captive-sliding' magnet, *Styles S or V* or an 'open-ring' magnet, *Style M*. Captive-sliding magnets utilize slide bearings of special material that reduce friction, and if required, help mitigate dirt build up. The slide bearings are designed to operate dry, requiring no external lubrication or maintenance.

The *Style M 'open-ring'* magnet mounts on the moving machine part and travels just above the sensor's profile extrusion. The open-ring magnet requires a minimum distance away from ferrous metals to allow proper sensor output. It must be mounted using non-ferrous screws and a non-ferrous support bracket, or utilize a non-ferrous spacer of at least 5 mm (0.2 in.) thickness.

POSITION MAGNET SELECTIONS *(Drawing dimensions are for reference only)*

Magnet dimensions and mounted magnet dimensions	Description	Part number
	<p>Captive-sliding magnet, Style S For Model RP profile-style sensor</p>	<p>252182</p>
	<p>Captive-sliding magnet, Style V For Model RP profile-style sensor</p>	<p>252184</p>
	<p>Open-ring magnet, Style M I.D.: 13.5 mm (0.53 in.) O.D.: 33 mm (1.29 in.) Thickness: 8 mm (0.31 in.) Operating temperature: - 40 °C to 100 °C</p> <p>This magnet may influence the sensor performance specifications for some applications.</p>	<p>251416-2</p>

**Model RP Profile-Style Sensor
Sensor Mounting Reference**

Sensor mounting

Model RP profile-style sensor mounting flexible installation in any position!

Temposonics Model RP profile-style sensors offer two basic mounting methods; side grooves for use with mounting feet or a bottom groove that accepts special T-Slot nuts. Both the mounting feet and T-Slot nuts can be positioned along the sensor extrusion to best secure the sensor for each particular application.

Notes:

1. Model RP sensors include two mounting feet (part no. 400802) for sensors stroke lengths up to 1250 mm (50 in.)
2. One additional mounting foot is included for stroke lengths over 1250 mm (50 in.) and for each additional 500 mm (20 in.), thereafter.
3. MTS recommends using 10-32 cap screws (*customer supplied*) at a maximum torque of 44 in. lbs. when fastening mounting feet.

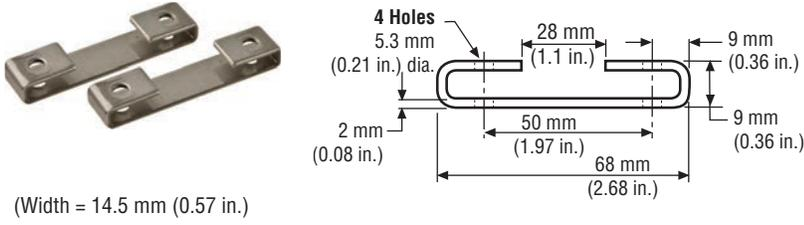
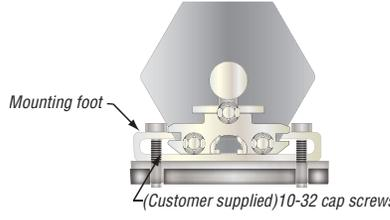
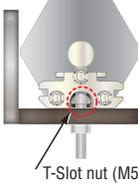
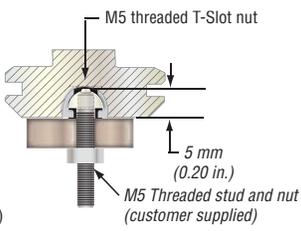
Profile-Style sensor mounting and installation reference	Mounting method	Part number
 <p>(Width = 14.5 mm (0.57 in.))</p>	<p>Mounting feet, standard (304 SS) Profile-style sensor mounting for sensor model RP</p>	<p>400802</p>
<p>10 - 32 Cap screws Recommended (Customer supplied)</p>  <p>Mounting foot (Customer supplied) 10-32 cap screws</p>	<p>Mounting feet and screws Profile-style sensor foot installation</p>	<p>See Mounting Feet part number: 400802</p>
   <p>T-Slot nut (M5 threaded) M5 threaded T-Slot nut 5 mm (0.20 in.) M5 Threaded stud and nut (customer supplied)</p>	<p>T-Slot nut Nut for mounting model RP sensor. M5 thread (Optional, ordered separately)</p>	<p>401602</p>

Model RH rod-style sensor dimension reference

The Temposonics R-Series rod-style sensor (Model RH) offers modular construction, flexible mounting configurations, and easy installation. The Model RH sensor is designed for mounting in applications where high pressure conditions exist (5000 psi continuous, 10,000 psi spike) such as inside hydraulic cylinders. The Model RH sensor (see 'Figure 5') may also be mounted externally in many applications.

Stroke-dependent Dead Zones:	
Stroke length:	Dead zone:
25 mm (1 in.) - 5000 mm (197 in.)	63.5 mm (2.5 in.)
5005 mm (197 in.) - 7620 mm (300 in.)	66 mm (2.6 in.)

MODEL RH, ROD-STYLE SENSOR WITH RING MAGNET (MAGNET ORDERED SEPARATELY)

Drawing is for reference only, contact applications engineering for tolerance specific information.

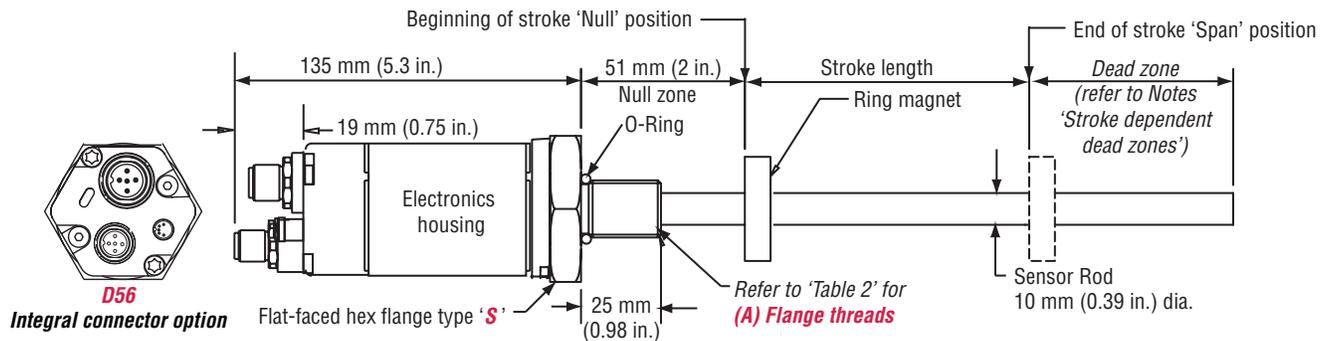

Figure 5. Model RH Rod-style sensor dimension reference (shown with **D56** integral connector options)

MODEL RH, ROD-STYLE SENSOR WITH RING MAGNET (MAGNET ORDERED SEPARATELY)

Drawing is for reference only, contact applications engineering for tolerance specific information.

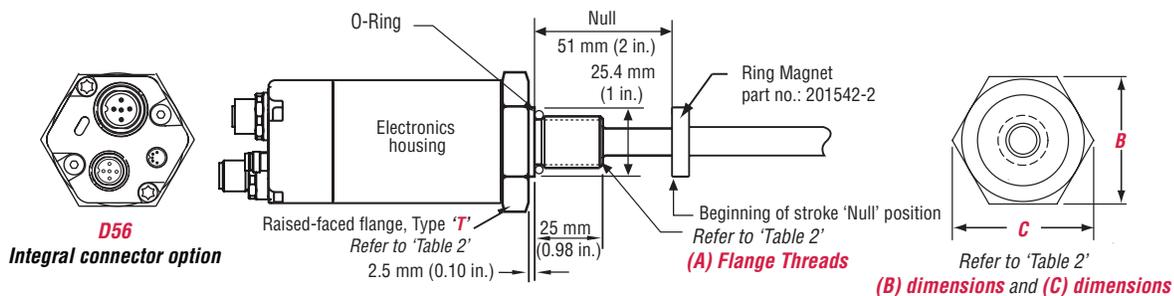

Figure 6. Model RH Rod-style sensor dimension reference (Shown with the **D56** Integral cable connection type option)

Housing style Flange type	Description	(A) Flange threads	(B) Dimensions	(C) Dimensions
T	US customary threads with raised-face flange	3/4" - 16 UNF-3A	1.75 in.	2 in.
S	US customary threads with flat-faced flange	3/4" - 16 UNF-3A	1.75 in.	2 in.
M	Metric threads with flat-faced flange	M18 x 1.5	46 mm	53 mm

Table 2. Model RH Rod-style sensor housing style and flange type references

**Model RH Rod-Style Sensor
Standard Magnet Selections**

Standard magnet selections (Model RH)

Magnets must be ordered separately with Model RH position sensors. The standard ring magnet (part number 201542-2) is suitable for most applications.

POSITION MAGNET SELECTIONS (Magnet must be ordered separately) *(Drawing dimensions are for reference only)*

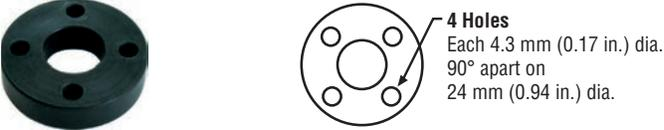
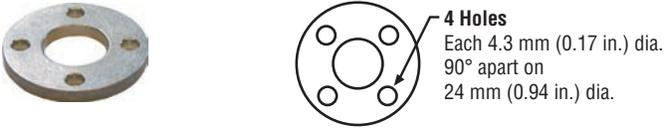
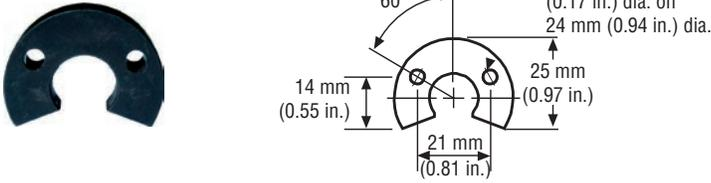
Magnet and magnet dimensions	Description	Part number
 <p>4 Holes Each 4.3 mm (0.17 in.) dia. 90° apart on 24 mm (0.94 in.) dia.</p>	<p>Standard ring magnet I.D.: 13.5 mm (0.53 in.) O.D.: 33 mm (1.3 in.) Thickness: 8 mm (0.3 in.) Operating temperature: - 40 °C to 100 °C</p>	201542-2
 <p>4 Holes Each 4.3 mm (0.17 in.) dia. 90° apart on 24 mm (0.94 in.) dia.</p>	<p>Magnet spacer (Non-ferrous, use with ring magnet Part number: 201542-2) I.D.: 14 mm (0.56 in.) O.D.: 32 mm (1.25 in.) Thickness: 3.2 mm (0.125 in.)</p>	400633
	<p>Ring magnet I.D.: 13.5 mm (0.53 in.) O.D.: 25.4 mm (1 in.) Thickness: 8 mm (0.3 in.) Operating temperature: - 40 °C to 100 °C</p>	400533
 <p>2 Holes Each 4.3 mm (0.17 in.) dia. on 24 mm (0.94 in.) dia. 60° 14 mm (0.55 in.) 25 mm (0.97 in.) 21 mm (0.81 in.)</p>	<p>Open-ring magnet, Style M I.D.: 13.5 mm (0.53 in.) O.D.: 33 mm (1.3 in.) Thickness: 8 mm (0.3 in.) Operating temperature: - 40 °C to 100 °C</p> <p>This magnet may influence the sensor performance specifications for some applications.</p>	251416-2

MAGNET FLOAT SELECTION *(Drawing dimensions are for reference only)*

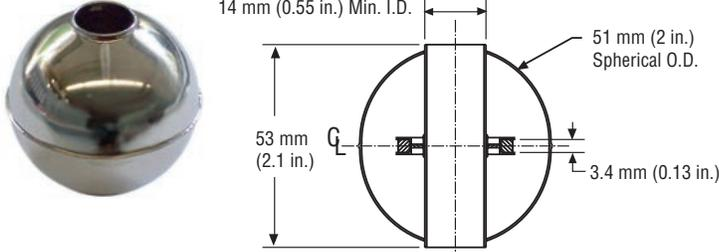
 <p>14 mm (0.55 in.) Min. I.D. 53 mm (2.1 in.) 51 mm (2 in.) Spherical O.D. 3.4 mm (0.13 in.)</p>	<p>Magnet float (Level sensing applications) Specific gravity: 0.70 maximum Pressure: 870 psi maximum</p> <p>(This float is used with Model RH rod-style sensors for hydraulic fluid or fresh water applications only). Collar (part no.: 560777) is recommended for end of stroke stops.</p>	251447
--	--	--------

Sold & Serviced By:

 **ELECTROMATE**

Toll Free Phone (877) SERV098

Toll Free Fax (877) SERV099

www.electromate.com

sales@electromate.com

Model RH Rod-Style Sensor Mounting Cylinder Installation and Connections

Model RH Rod-Style sensor mounting

The position magnet requires minimum distances away from ferrous metals to allow proper sensor output. The minimum distance from the front of the magnet to the cylinder end cap is 15 mm (0.6 in.).

The minimum distance from the back of the magnet to the piston head is 3.2 mm (0.125 in.). However, a minimum distance of at least 5 mm (0.197 in.) is preferred for added performance margin. The non-ferrous spacer (part no.: 400633) provides this minimum distance when used along with the standard ring magnet (part no.: 201542-2), as shown in 'Figure 7'.

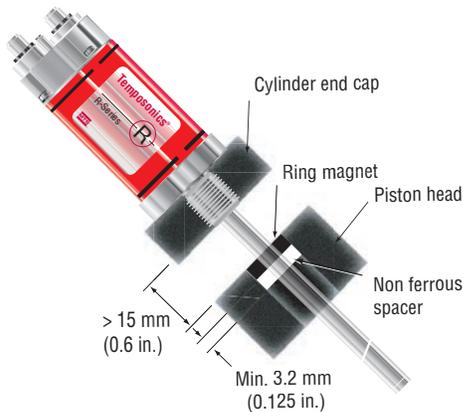

Figure 7. Model RH rod-style mounting

Cylinder installation

When used for direct-stroke measurement in fluid cylinders, the sensor's high pressure, stainless steel rod installs into a bore in the piston head/rod assembly as shown in 'Figure 8'. This method guarantees a long-life and trouble-free operation.

The sensor cartridge can be removed from the flange and rod housing while still installed in the cylinder. This procedure allows quick and easy sensor cartridge replacement without the loss of hydraulic pressure.

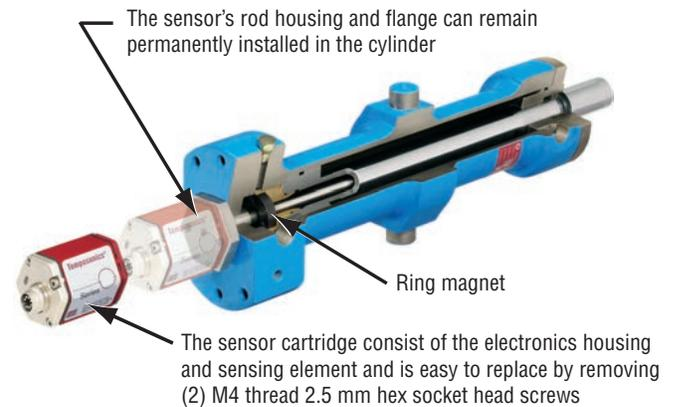
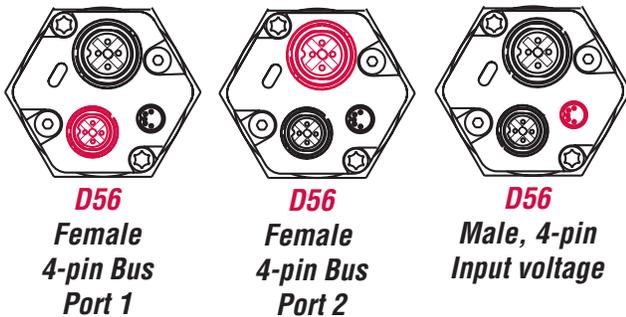

Figure 8. Fluid cylinder installation

Connections and wiring

(D56) BUS CONNECTOR OPTION

D56 connector option for 'daisy chain' topologies. A separate cable is used for the supply voltage. Unused connectors should be covered by a protective cap (part no.: 370537).



BUS CONNECTIONS PORTS 1 AND 2



Female, 4-pin (M12-D) Integral connector pin-out as viewed from the end of the sensor

Pin number	Cable color	Function
1	Yellow	Tx+
2	White	Rx+
3	Orange	Tx-
4	Blue	Rx-

INPUT VOLTAGE



Input voltage, male, 4-pin (M8) integral connector pin-out as viewed from the end of the sensor

Pin number	Cable color	Supply voltage
1	Brown	+24 Vdc (-15/+20%)
2	White	No connection
3	Blue	DC ground (for supply)
4	Black	No connection

Sold & Serviced By:

ELECTROMATE

Toll Free Phone (877) SERV098

Toll Free Fax (877) SERV099

www.electromate.com

sales@electromate.com

Model RP and RH Sensors

Ordering Information; Connector and Cable Assembly Options

(D56) CABLE CONNECTOR OPTIONS (Drawing dimensions are for reference only)

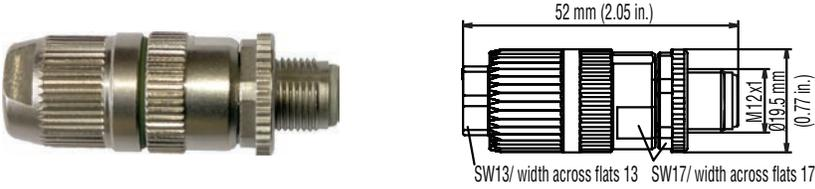
Connector and connector dimensions	Description	Part number
	<p>Bus Cable Connector, Male 4-pin (M12), D-coded with insulation displacement technology</p>	<p>370523</p>
	<p>Connector, Female 4-pin (M8) and cable with pigtail termination</p> <p>For 24 Vdc input. Wire gage 4x0.25 mm2 shielded, PUR cable jacket</p>	<p>5 m length = 530066 10 m length = 530096 15 m length = 530093</p>
	<p>Connector end cap</p> <p>(Unused connectors should be covered by this protective cap)</p>	<p>370537</p>

BUS CABLE WITH CONNECTORS (Drawing dimensions are for reference only)

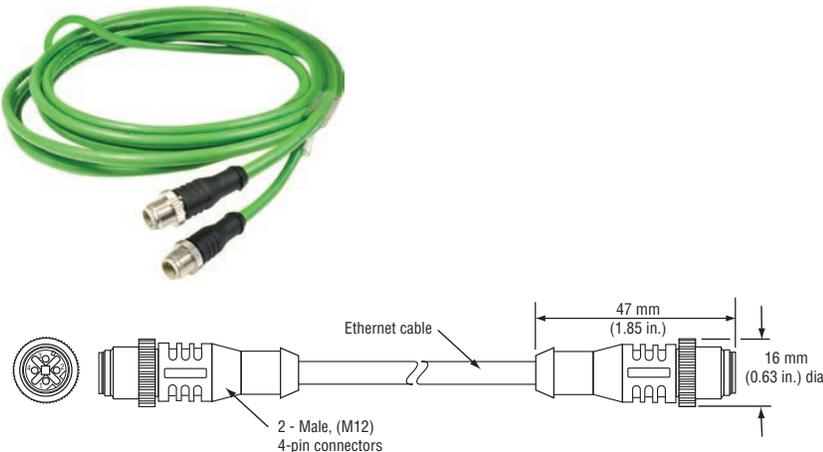
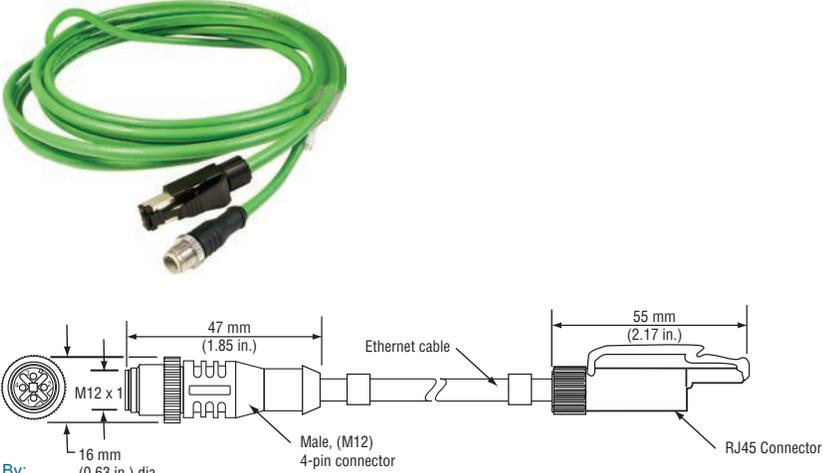
Bus cable and connector assemblies	Description	Part number
	<p>Industrial Ethernet Bus Cable, 5 m length (Cat 5e ES)</p> <p>Assembly Includes two 4-pin (M12) connectors (D-coded) and PUR cable jacket (green)</p>	<p>530064</p>
	<p>Industrial Ethernet Bus Cable, 5 m length (Cat 5e ES)</p> <p>Assembly Includes one RJ45 connector and one 4-pin (M12) connector (D-coded) with PUR cable jacket (green) Cables using the RJ45 connector provide convenient sensor connection to a PC for setup and programming but are not recommended for factory floor installations.</p>	<p>530065</p>

Sold & Serviced By: **ELECTROMATE**

Toll Free Phone (877) SERV098
Toll Free Fax (877) SERV099
www.electromate.com
sales@electromate.com

