

MOTION DESIGN GUIDE

LINEAR POSITION SENSORS

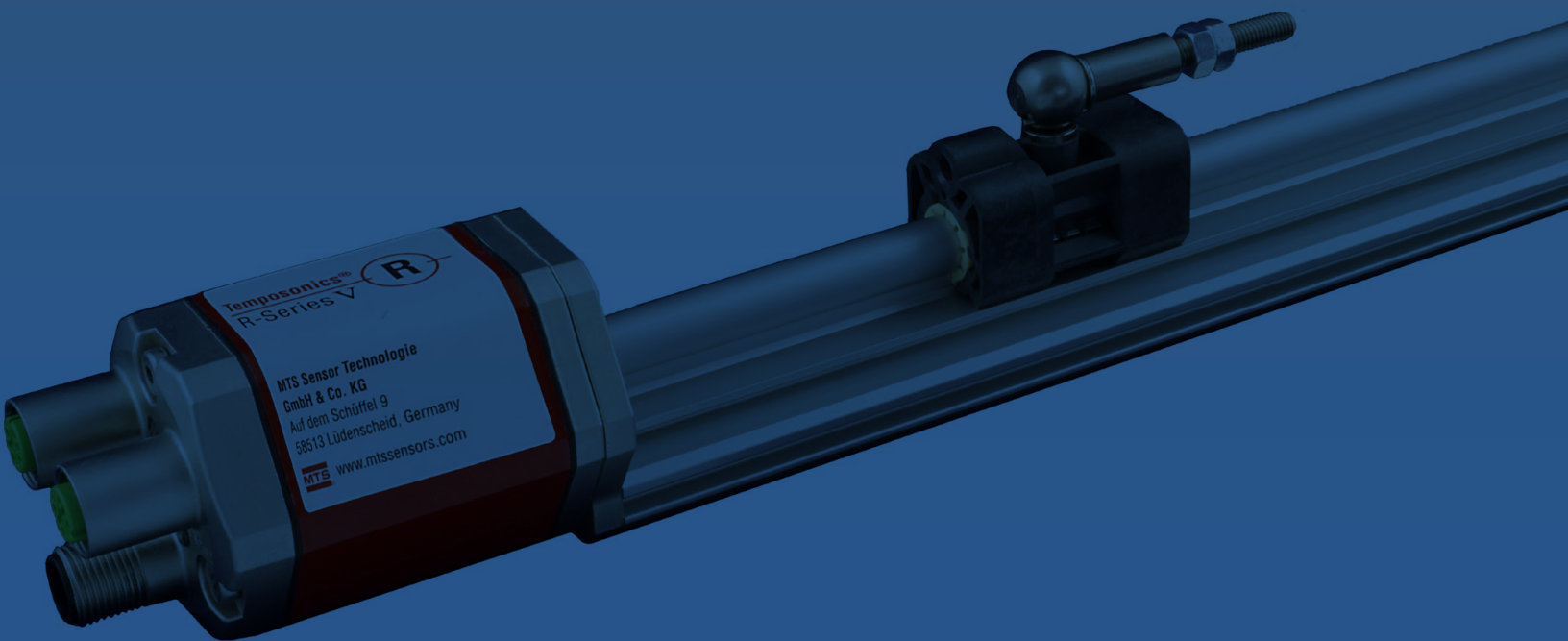

SPONSORED BY:



BROUGHT TO YOU BY:



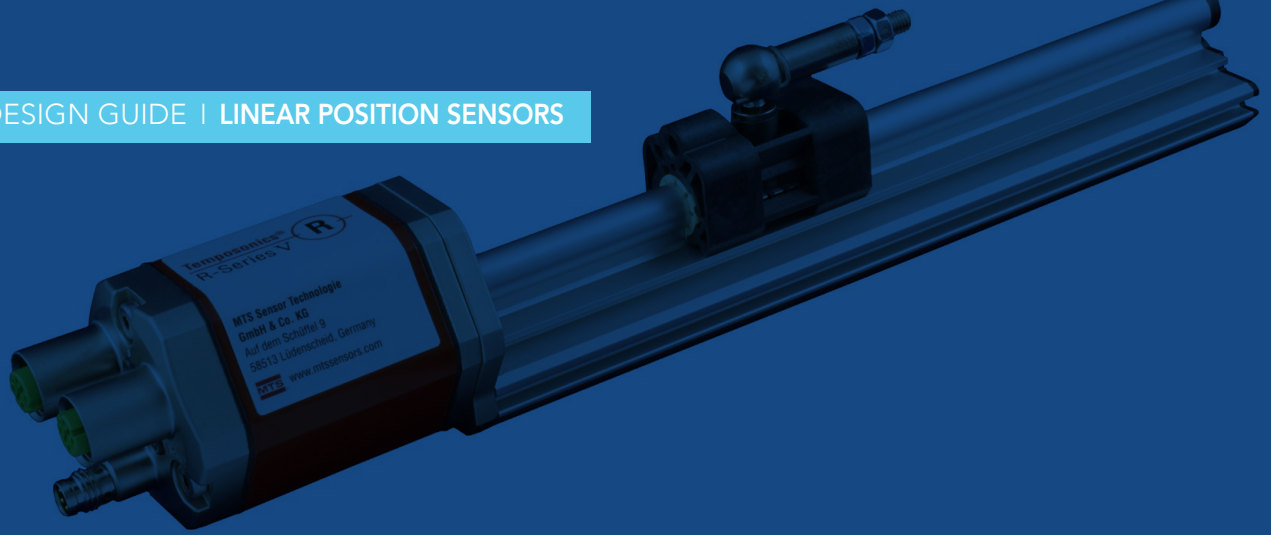

All sensors for use in automated machine designs are at their core *transducers* — devices that *transduce* (convert) one form of energy (typically electromagnetic or mechanical kinetic) to another. Measurements can be incremental (expressing relative values referencing a floating or arbitrary start point) or absolute — expressing values referencing some fixed location or value. What’s more, sensor output can be analog (with an electrical signal format that’s continuous and proportional to the measured condition) or digital (with an electrical signal format that changes incrementally vary in response to the measured condition).

No matter the output, sensors in motion systems track speeds, angles, vibrations, accelerations, object presences, and (the primary focus of this Design Guide) distance traveled, and positions as referenced by rotational and translational (linear) planes. Options abound for measuring all these mechanical quantifications.

In this Design Guide, the editors of Design World detail some of the most common sensing options for tracking linear position and travel ... including variations based on capacitive, eddy current, Hall effect, and inductive technologies. Also covered will be rotary as well as linear variable differential transformers (RVDTs and LVDTs) and how industry differentiates these technologies from those classified as encoder technologies.

TABLE OF CONTENTS

Industrial linear-position sensors in context	3
Quantifying industrial linear-position sensor performance.....	7
Linear-position sensing with magnetostrictive sensors	9
Linear-position sensing with potentiometers and string pots	11
Linear-position sensing with draw-wire transducers.....	12
Linear position encoding and the special case of capacitive technologies.....	14
Linear sensors employing the Hall effect.....	17
Linear-position sensing with linear variable differential transformers (LVDTs)	19
Linear-position sensing based on inductive technology	21

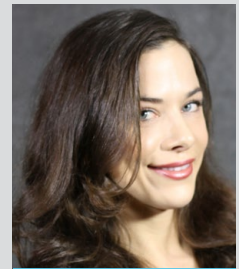

LISA EITEL
Executive editor



DANIELLE COLLINS
Senior editor

Sold & Serviced By:



Toll Free Phone (877) SERV098
www.electromate.com
sales@electromate.com

SPONSORED BY:





INDUSTRIAL LINEAR-POSITION SENSORS IN CONTEXT

All sensors in machine designs and automation at their core are *transducers* — devices that *transduce* or convert one form of energy (typically electromagnetic or mechanical) to another. Transducers qualify as sensors when their primary function is to detect some physical condition in space, transduce electrically or mechanically collected information about that condition into some other electrical signal, and then send that signal onward to a controller.

Process-automation sensor technologies generally include those to track temperature, pressure, and flow. Discrete-automation sensor technologies generally include those to track speed, angle, torque, force and torque (F/T), vibration, acceleration, object presence or proximity, and (the primary focus of this Design Guide) distances. All these sensor types have advanced over the last two decades ... as has their programmability and connectivity to support IoT functions. After all, sensors are core to the IIoT so very reliant on data collection and systems monitoring for predictive maintenance and integration with enterprise-level operations. No matter their format or special features, sensor measurements can be:

- Relative or incremental — expressing values that relate to a floating or arbitrary start point
- Absolute — expressing values in relation to some fixed reference.

What's more, sensor output can be analog (with an electrical signal format that's continuous and proportional to the measured condition) or digital (with an electrical signal format that changes incrementally value in response to the measured condition).

Discrete-automation sensor technologies specific to motion are further classified by what exactly they track. Sensing rotary speed is usually via tachometers, sensors, or rotary encoders. Sensing linear speed is usually via rotary encoders (employing controls capable of estimating position based on motor-shaft actions) or the direct measurements of linear encoders. Sensing rotary or linear position is usually via encoders or position sensors. These devices track axes or objects in translational (linear) planes by indicating positions related to a reference ... and position at any given time depends on the distance traversed by an object or axis. Also called linear displacement, this is a vector value, as it defines both a distances quantity and a direction of movement.

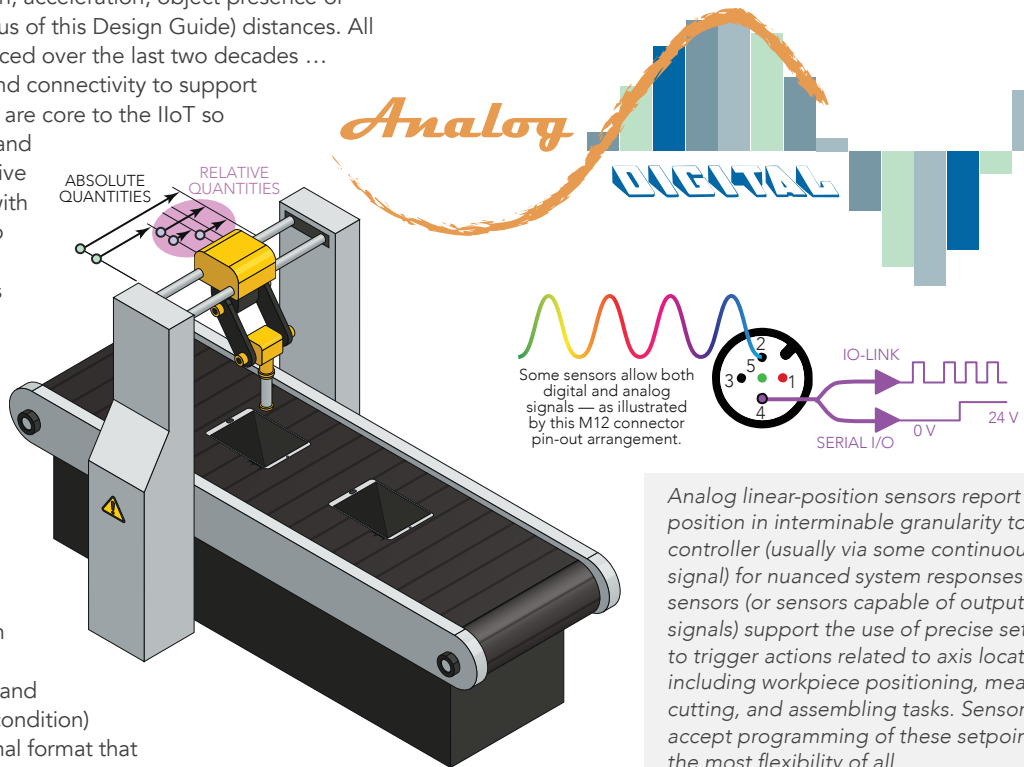

Analog linear-position sensors report axis position in interminable granularity to a motion controller (usually via some continuous voltage signal) for nuanced system responses. Discrete sensors (or sensors capable of outputting discrete signals) support the use of precise setpoints to trigger actions related to axis location — including workpiece positioning, measuring, cutting, and assembling tasks. Sensors that accept programming of these setpoints provide the most flexibility of all.

(continued)

INDUSTRIAL LINEAR-POSITION SENSORS IN CONTEXT

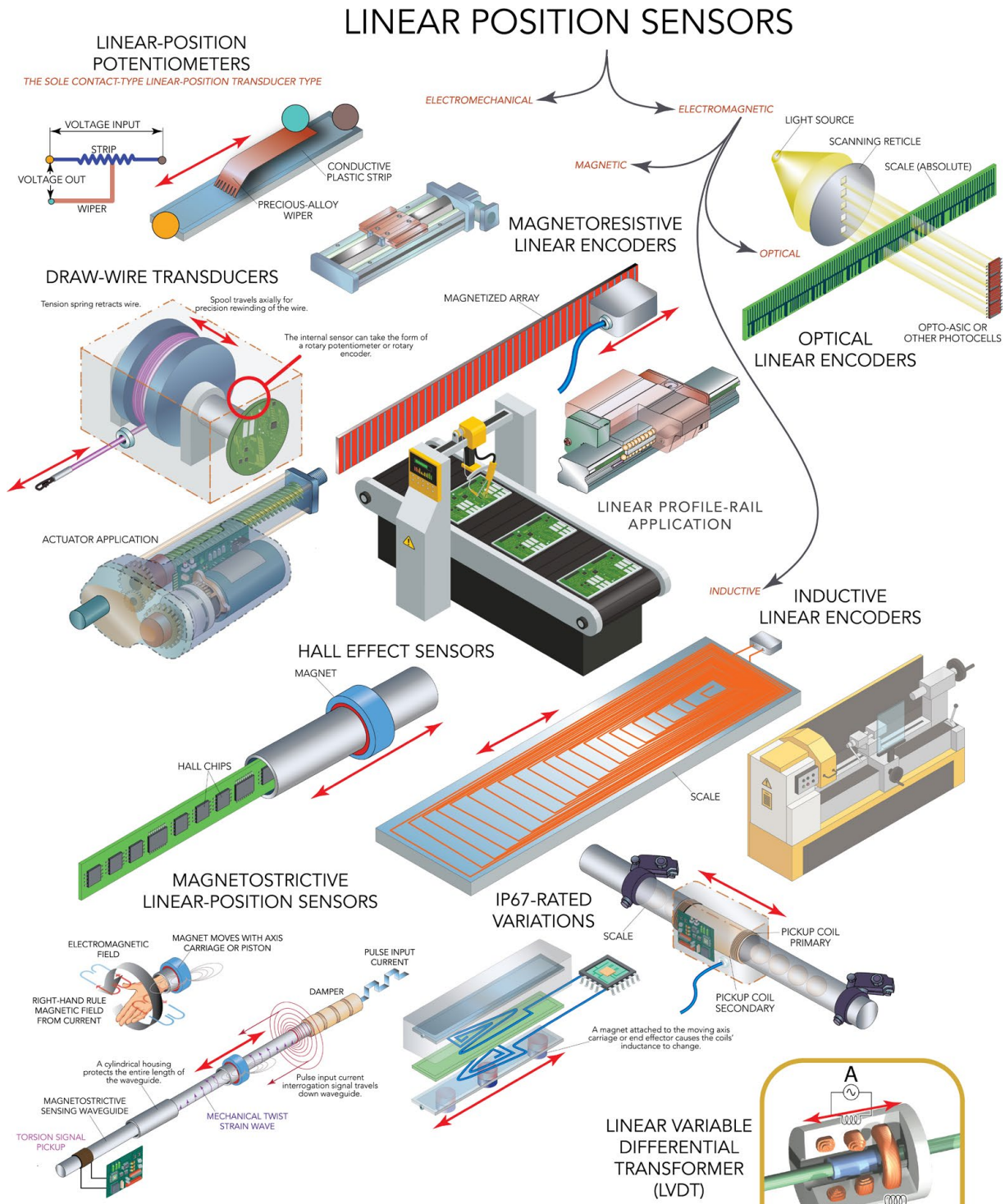

For axes only needing a signal at a given position, switches are the suitable feedback choice. However, if the axis stroke occasionally changes or requires tracking along its whole length, linear position sensors are required. Linear position sensors (whether analog or digital) can report the location of an axis' carriage or other reference element from various points. They also let end users adjust the response location if (for a machine changeover) an axis needs to trigger feedback at a new position. Such linear-position sensors can use mechanical or electromagnetic means of feedback. For the latter, sensors (much like electric motors) can employ either induction or magnetism to close the loop on an axis' position or travel.

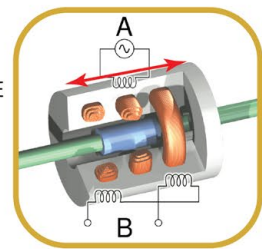

Image via Wikipedia Commons • Wapcaplet

(continued)

INDUSTRIAL LINEAR-POSITION SENSORS IN CONTEXT

Encoder and sensor technologies applied to track linear position — whether based on optical, capacitive, inductive, or magnetic operation — are the focus of this Design Guide.

DIFFERENCE BETWEEN LINEAR-POSITION SENSORS AND ENCODERS

Note that automated industries differentiate linear encoders and linear position sensors in a few ways. In many contexts, linear encoder refers to any component employing a graduated tape or marked scale. After all, the meaning of *encode* is to convert some message or other information into a coded format that the receiver (in automation, a controller) can understand. Of course, there are all sorts of encoding processes related to other industries beyond ours of automation — including the encoding of data related to audio and video (in the film industry) and programming systems.

It's particularly common for linear encoders to encode position as a quadrature signal pairs — whether analog (sinewave) or digital (squarewave). Because the position-data-conversion process essentially takes place within a linear encoder's scale-reading subcomponent, it's logical that such technologies are called encoders.

In contrast, the term *linear position sensor* often indicates some device employing an analog or digital signal-generating assembly based on electromechanical potentiometric, electrolytic, capacitive, inductive, or magnetic operation — with the latter including various

Linear position sensors facilitate two system capabilities — continuous position feedback as well as the ability to program machine controls to respond when the tracked axis reaches a key location.

magnetostrictive, Hall effect, and magnetostrictive permutations. Where the term linear position sensor is used without any other context, it usually implies a linear variable differential transformer (LVDT) — one particularly common and useful technology covered later in this Design Guide. Elsewhere, the term *linear displacement transducer* (abbreviated LDT) is used. This usually refers to magnetostrictive-based linear sensors that compete with potentiometric-based sensors in the machine tool, office automation, and paper-printing industries. That said, some technical sources use LDT to also refer to linear potentiometers as well as draw-wire linear transducers containing rotary potentiometers.

In fact, most suppliers of linear position sensors for industrial applications also supply sensors to track angular position, acceleration, object tilt, and (relative to process control) fluid-level sensors. That's because these components leverage many of the

same core technologies (based on induction, magnetism, and so on) as linear-motion sensors.

There are variations in how specific industries (such as packaging and 3D printing) use the terminology described above. Where motion system design isn't core to an industry's systems, engineers may simply consider encoders (especially incremental encoders) to be a subtype of position sensor specifically relating to motion control. That's especially true for autonomous designs also employing vehicle-position sensing based on light amplification by stimulated emission of radiation (laser) and light detection and ranging (lidar) technologies with time-of-flight, triangulation, or other forms of tracking. Elsewhere, engineers use encoders to refer to those components associated with a given motor or linear actuator in the design ... and position sensors to refer to feedback components associated with functions at the furthest reaches of the design's axes.

Note: Linear-position sensors and linear encoders always add to the cost of linear systems, but it's usually a justified expenditure. For example, adding linear encoders to ballscrew-driven axes can often let design engineers specify screws of a lower accuracy class. After all, the linear encoder feedback on such an axis can help the controller compensate for any ballscrew positioning errors. Of course, the top benefit of linear-position feedback though is how it vastly improves the quality of cutting, dispensing, and other positioning-related machine operations. For example, without linear-feedback components, many laboratory-automation installations today wouldn't be able to successfully employ the low-cost stepper-motor actuators so common to this industry. In these designs, linear-position sensors aid in precise positioning and prevent damage to the machine as well as expensive (and often irreplaceable) test samples.

DIFFERENCE BETWEEN LINEAR POSITION SENSORS AND SWITCHES

Another linear-motion feedback option besides linear-position sensors covered in this Design Guide are limit switches. At their core, switches on linear axes (such as limit switches on electric actuators or reed switches in pneumatic cylinders) are devices that essentially predetermine the control response to a given axis or load position. That response may take the form of automatically triggering the axis to stop driving or return to a home position for the next machine cycle. Mechanical limit switches on actuated axes are the simplest — usually closing electrical contacts on a control circuit when a moving carriage pushes into its lever. But note how that switch function contrasts with the continuous-feedback function of a position sensor — which may prompt controls to command a whole host of machine behaviors based on the location of the axis' end effector, carriage, or other payload being tracked.

(continued)

INDUSTRIAL LINEAR-POSITION SENSORS IN CONTEXT

DIFFERENCE BETWEEN LINEAR POSITION SENSORS AND PROXIMITY SENSORS

Linear-position sensors also have a bit in common with proximity sensors used in so many industrial and manufacturing applications. After all, proximity sensors detect the positioning of objects or materials into a monitored volume in space ... and then trigger some action or simply confirm the objects' presence via feedback to the controller. Key is their noncontact operation that doesn't require physical touching with the tracked axis elements or objects. In addition, some of the applied physics of linear-position sensors and encoders (photoelectric, ultrasonic, capacitive, and inductive) are common to those employed in many proximity sensors. As we'll explore in more detail, photoelectric sensors monitor light levels

in a given volume. Capacitive sensors track the dielectric constant between its detector and nearby objects. Inductive sensors employ electromagnetic induction to track metallic objects. We don't cover the technology any further in this Design Guide (as its relatively rare for linear-positioning uses) but ultrasonic sensors emit and [then scan for the return of](#) high-frequency sound waves.

Despite their operational similarities, note how the event-feedback proximity-sensor function contrasts with the continuous-feedback function of position sensors.

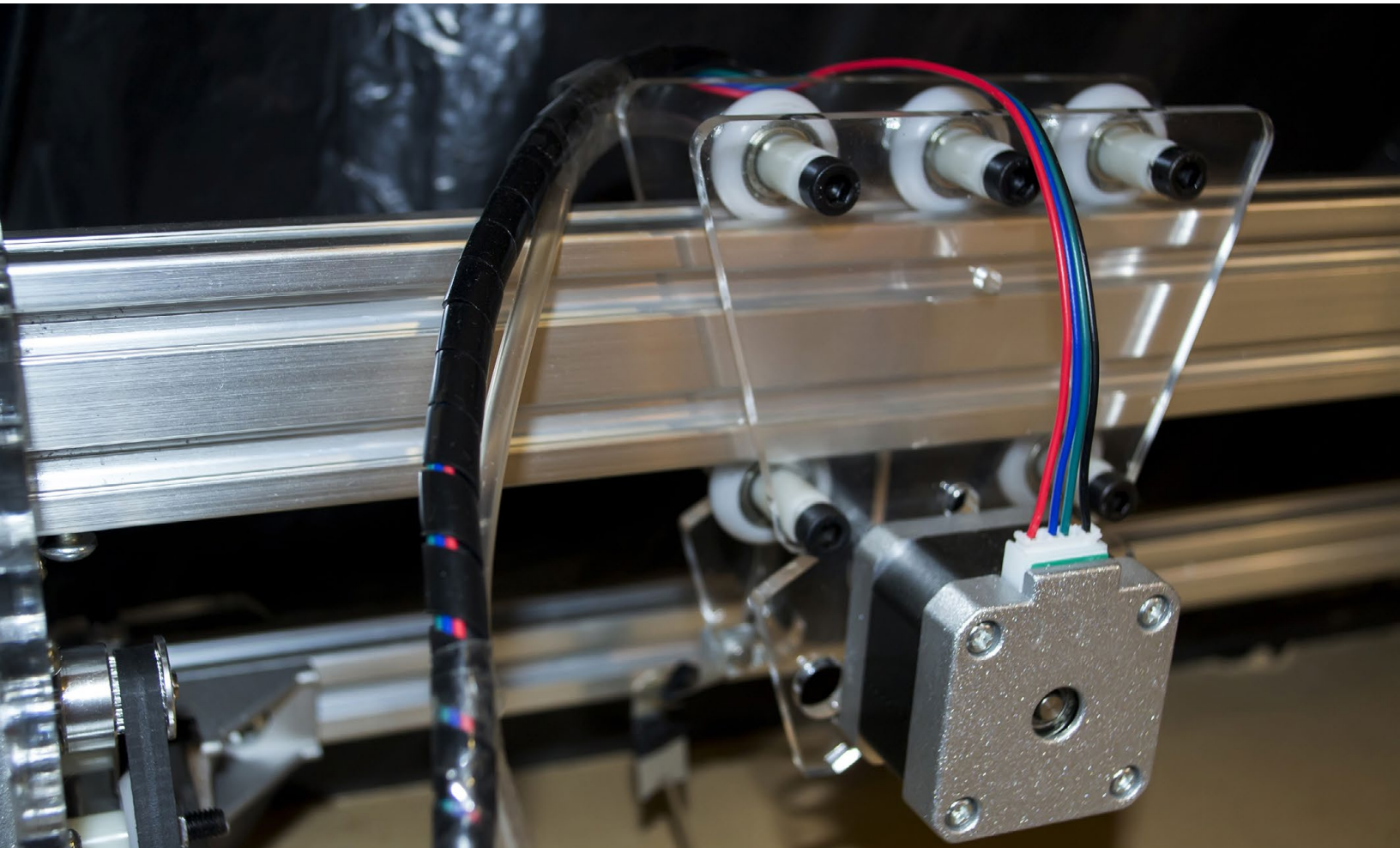

Sold & Serviced By:



Toll Free Phone (877) SERV098
www.electromate.com
sales@electromate.com

SPONSORED BY:



QUANTIFYING INDUSTRIAL LINEAR-POSITION SENSOR PERFORMANCE

One of the most important factors for selecting a linear-position sensor is the stroke length of the axis in question — whether that's measured in nanometers, millimeters, or meters. Of course, all sensors have some extra length (to accommodate electronics, mounting flanges, and other subcomponents) not included in the readable stroke range. This might add a few dozen millimeters to the design.

Besides stroke length, other important factors for selecting a linear-position sensor or encoder include the application's requirements for:

- Sensor-subcomponent alignment requirements if applicable — as in feedback components with a read head that rides above a scale at some distance away
- System power supplies available for the sensor — such as 15 Vdc or (more common) 24 Vdc, for example
- Feedback accuracy and resolution — and maximum allowable hysteresis
- Repeatability and linearity (as illustrated in the figure accompanying this Design Guide section)
- Maintenance-free design life
- Design size as well as sensor-installation restrictions
- Linear position-sensor output type — whether analog (0 to 20 mA, 4 to 20 mA, or 0 to 10 V) or digital

WAYS TO EXPRESS SENSOR SIGNAL-OUTPUT LINEARITY

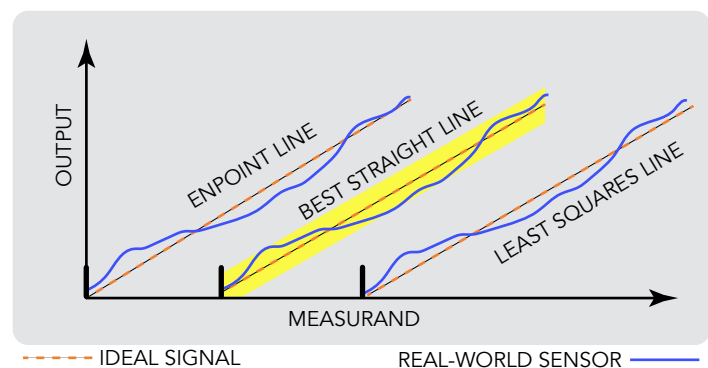

Linearity is often expressed as a percent — for example $\pm 0.01\%$ of the ideal signal.

Linearity in the context of linear-position sensors shouldn't be confused with some quantification of a physical element. Rather, linearity quantifies how steadily proportional the sensor's output signal is to the position it's tracking.

(continued)

QUANTIFYING INDUSTRIAL LINEAR-POSITION SENSOR PERFORMANCE

For the latter, additional output formats that a system's PLC or other controller may require from the linear encoder or sensor include serial synchronous interface (SSI), bidirectional serial synchronous (BiSS-C), and IO-Link signals. Otherwise, the sensor may need to connect to EtherCAT, CANopen, DeviceNet, or Profibus DP network.

Generally speaking, linear-position sensors capable of outputting high-precision signals are costlier than those capable of moderate precision. That's why knowing an application's actual required precision is key to incurring reasonable (not excessive) design costs.



Temposonics R-Series
V Connector Front



Temposonics with
EtherNet/IP Protocol



Challenges for which to account when specifying a linear position sensor or linear encoder include:

- Environmental factors such as exposure to water, chemicals, and extreme temperatures
- Electromagnetic interference (EMI) and radio-frequency interference (RFI)
- Unavoidable axis movement (including lateral movement) that may necessitate pivoting sensor attachments
- Unavoidable machine vibrations

For particularly challenging settings, linear-position sensors and encoders that embed into the linear components they monitor — whether fluid-power cylinders or electric-motor-driven actuators — are a top choice. Otherwise, linear-position sensors and encoders with ruggedized housings are in order. In some cases, modular sensor cartridges let end users swap out portions of the sensor assembly if they get damaged. In linear-position sensors and encoders bolt to a machine axes, extruded-profile housings are common.

Sold & Serviced By:



Toll Free Phone (877) SERV098
www.electromate.com
sales@electromate.com

SPONSORED BY:



LINEAR-POSITION SENSING WITH MAGNETOSTRICTIVE SENSORS

Magnetostriction is the tendency of some ferromagnetic materials to shapeshift when magnetized. More specifically, when a ferromagnetic material such as iron, nickel, or cobalt is exposed to an external magnetic field, the magnetic domains within the material align. That in turn creates stresses in the material that prompt a change in shape or dimension. Conversely, [when a magnetostrictive material is subjected to a stress, its magnetic properties will change](#). This is known as the Villari effect.

Another manifestation of magnetostriction is the Wiedemann effect: When a wire is subjected to a magnetic field oriented parallel to its length, and a current is passed through the wire, the wire experiences torsional strain at the location where the magnetic field occurs. The Wiedemann and Villari effects form the basis of linear magnetostrictive sensors.

In fact, all ferromagnetic materials experience magnetostriction ... but in some materials, the magnitude of the dimensional change is too small to be of practical use. For example, when a magnetostrictive bar or rod is placed in a magnetic field oriented parallel to the length of the bar, the bar will change length. However, the length change for materials used in linear magnetostrictive sensors is very small — typically on the order of 10⁻⁶ m/m.

Magnetostrictive linear-position sensors include a wire or bar called a waveguide. This waveguide (typically made of iron alloy) mounts to a stationary part of the machine. The magnetic field is provided by a position magnet attached to the moving part being positionally tracked. Short pulses of current (of 1 to 3 μsec)

are applied to a conductor attached to the waveguide. Then the Wiedemann effect arises from the interaction of:

- The magnetic field caused by the current and
- The magnetic field caused by the position magnet ...

... and that in turn induces torsional strain (twist) in the waveguide. Because the current is applied as a pulse (called an interrogation pulse) the twist travels down the wire as an ultrasonic wave moving at approximately 2,850 m/sec. This twist or mechanical pulse is detected by a signal converter (also called a strain pulse converter) which relies on the Villari effect to create a voltage pulse indicating receipt of the mechanical strain wave.

MAGNETOSTRICTIVE LINEAR-POSITION SENSORS

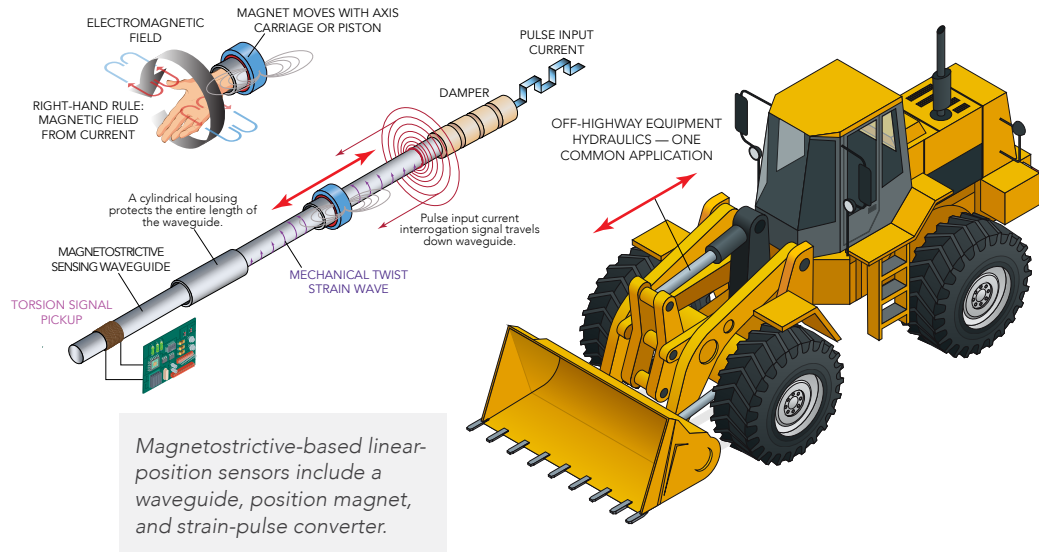

HOW MAGNETOSTRICTIVE LINEAR POSITION SENSING TECHNOLOGY WORKS

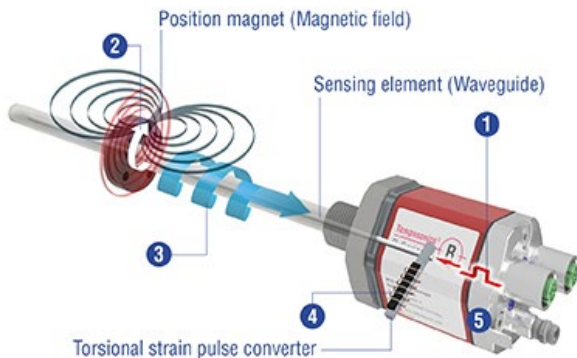

Measurement Cycle

- 1 Current pulse generates magnetic field
- 2 Interaction with position magnet field generates torsional strain pulse
- 3 Torsional strain pulse propagates
- 4 Strain pulse detected by converter
- 5 Time-of-flight converted into position

(continued)

LINEAR-POSITION SENSING WITH MAGNETOSTRICTIVE SENSORS

CURRENT PULSE AND WAVE PROPAGATION IN MAGNETOSTRICTIVE LINEAR SENSORS

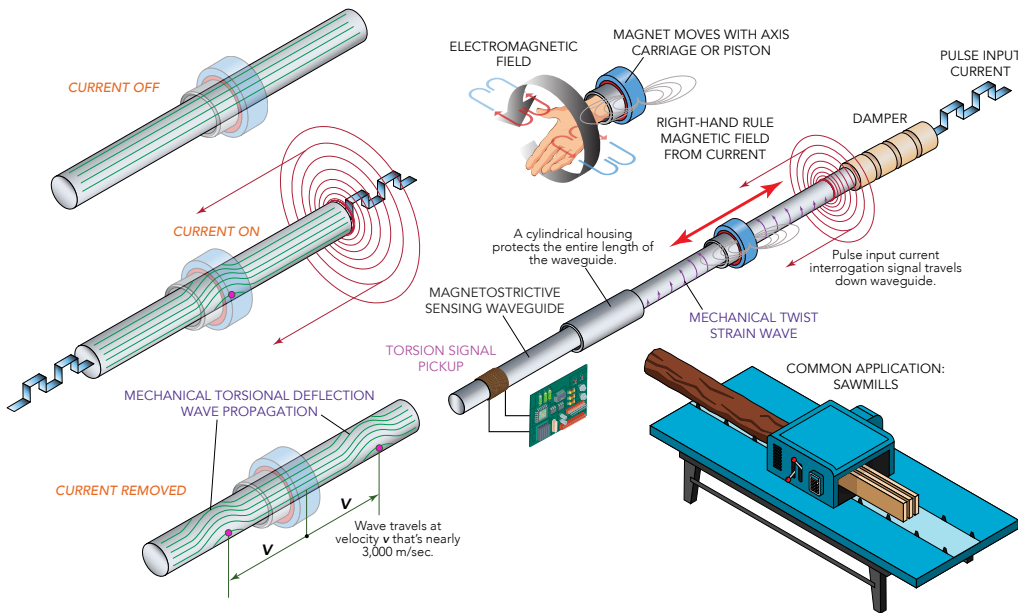

Application of current pulse prompts a magnetic field with which a position magnet interacts — and causes waveguide torsional deflection. When the current is turned off the strain relaxes, and a mechanical wave begins propagating. The wave propagates in both directions along the sensor's waveguide length. In one direction, it is detected by the signal (pulse) converter. In the other direction, it's eliminated by a damping device to avoid interference.

The time between the initial current pulse and the detection of the mechanical pulse indicates the location of the position magnet and therefore the position of the moving part being measured. The interrogation rate or *update rate* can range from one time per second to more than 4,000 times per second — with the maximum update rate determined by the length of the waveguide.

Magnetostrictive-based linear sensors come with various housing styles.

MAGNETOSTRICTIVE PROFILE-RAIL HOUSING STYLES

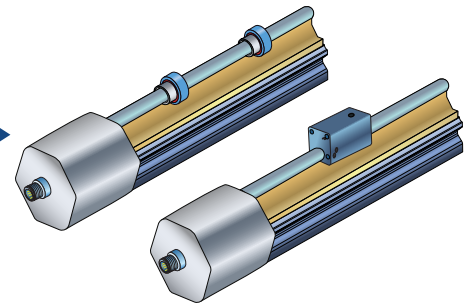

The waveguide of a magnetostrictive position sensor carries the sonic wave of the sensor's response to a magnetic field.

Magnetostrictive sensors provide absolute position information and (unlike incremental linear encoders) don't need to be rehomed upon restart after loss of power. They can also use multiple position magnets with one waveguide ... so are suitable for applications needing position information for multiple components along the same axis — as with the knives of a web-slitting machine, for example.

In addition to being noncontact, magnetostrictive designs enclose the waveguide in an extruded aluminum housing or stainless steel tube. That makes these linear position sensors virtually impervious to contamination. The sensors can also operate through a barrier between the position magnet and the waveguide — as long as that barrier is a nonmagnetic ceramic, plastic, aluminum, or stainless-steel material.

In paper-web processing, magnetostrictive-based linear sensors can track the distance between position magnets at the ends of ganged rollers. This feedback then informs servomotor-driven adjustments of the gap between those ganged rollers.

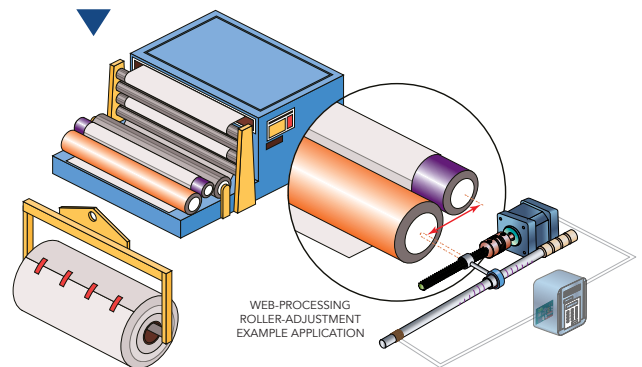

SPONSORED BY:



LINEAR-POSITION SENSING WITH POTENTIOMETERS AND STRING POTS



Another traditional option for linear-position feedback — especially on linear actuators — is the electromechanical contact device known as a potentiometer or *linear pot* for short. In the most common version of these linear-position sensors, a contact wiper attaches to the axis end effector (whether actuator carriage, ballscrew nut, or fluid-power cylinder piston) and drags along on a long resistive strip made of specially coated plastic. (Other more rugged cylindrical versions include a wire-wound resistance element and different construction.) Potentiometer wiring — which should be separate from any wiring to the axis' electric motor — can be a simple three-lead arrangement. Excitation dc (or less commonly ac) voltage into the sensor is read at an output voltage-sensing circuit — with output voltage varying linearly and ratiometrically with the wiper's location along this strip's length.

Benefits of potentiometric linear-position sensors include unbeatably simple integration, flexible control response, relatively low cost, compactness (especially lengthwise), and an infinitely variable position feedback.

Drawbacks of potentiometer linear-position sensing include mechanical wear of the contact wiper over time; the potential for strip-wiper separation (and signal interruption) if the sensor is subject to vibration; and degraded performance should the sensor housing fail to prevent dust ingress. In addition, feedback repeatability tends to be low (and hysteresis high) compared to that of other linear-position sensing technologies.

Though the incredible advances in motion-control electronics have in recent years simplified various forms of feedback integration, basic motion systems are sometimes to deliver excitation dc voltage into the potentiometer that's some multiple of the axis stroke for easy scaling of the output voltage signal.

Sold & Serviced By:

 **ELECTROMATE**

Toll Free Phone (877) SERV098
www.electromate.com
sales@electromate.com

SPONSORED BY:

 **Temposonics**
AN AMPHENOL COMPANY

LINEAR-POSITION SENSING WITH DRAW-WIRE TRANSDUCERS

DRAW-WIRE TRANSDUCERS

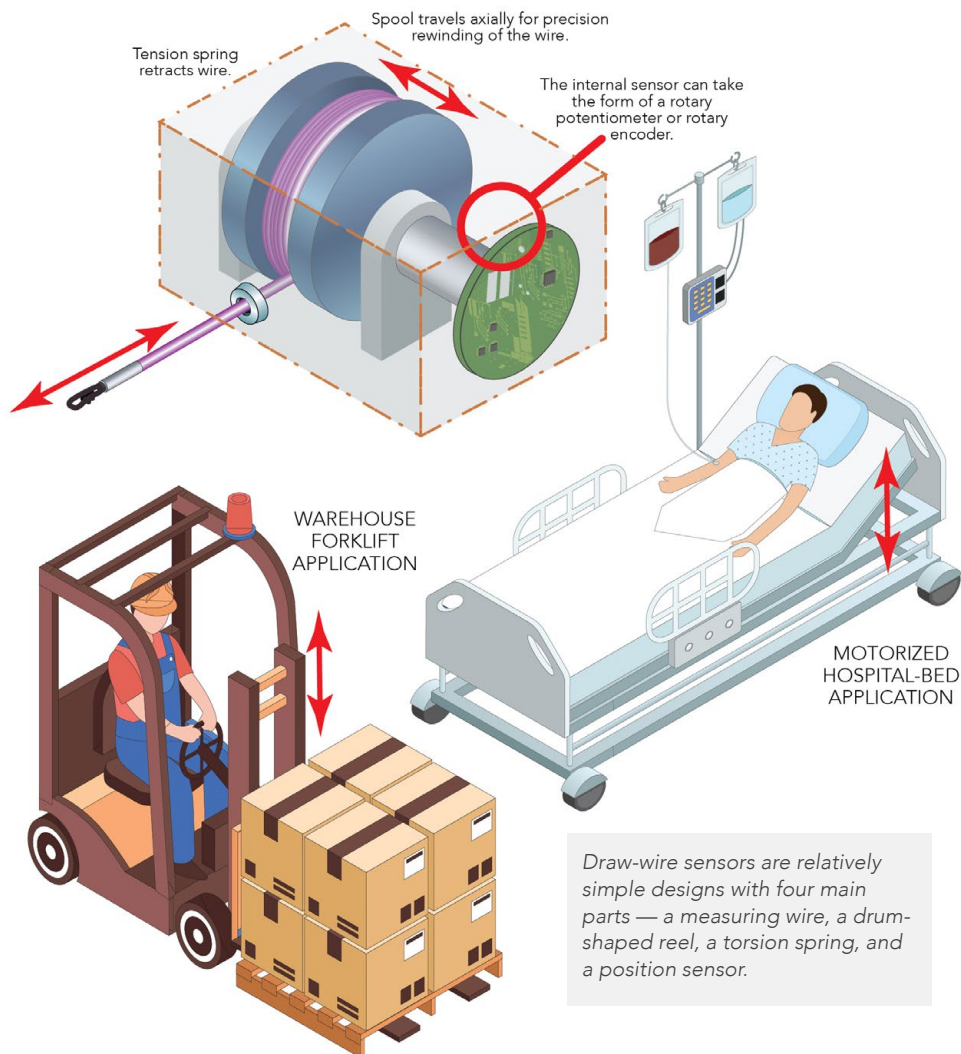

Many of the linear-position sensing technologies covered in this Design Guide require that some critical measuring-system subcomponent — whether read head, push rod, or magnet — attach to the axis end effector or payload being tracked. So what if the environment, application, or installation space doesn't permit the attachment of this subcomponent to the target object? Another type of linear measuring device called draw-wire sensor solves this problem.

Some other names for draw-wire sensors include cable-extension transducers, draw-wire transducers, wire-actuated encoders, cable linear transducers, string potentiometers, string encoders, linear-position string pots, and yo-yo pots or yo-yo encoders — due to the way the spring-set drum retracts the wire back into the sensor body (and rewinds it on the drum) when the axis returns from its furthest-most stroke reach. As we'll explore, the term *string potentiometer* may in some cases be least accurate ... because while many draw-wire linear sensors contain a rotary potentiometer for conversion of mechanical to electrical signal, many others actually rely on a rotary encoder of some type to perform that task.

SPONSORED BY:

 **Temposonics**
AN AMPHENOL COMPANY

(continued)

LINEAR-POSITION SENSING WITH DRAW-WIRE TRANSDUCERS

Draw-wire sensors are relatively simple in construction, with four main parts:

- Thin wire cable
- Wire-take-up drum — also called a spool or wheel reel
- Radial torsion spring to provide (via the drum) retracting take-up torque
- Position sensor

The measuring wire is commonly made of braided steel or stainless steel and covered with nylon or polyamide, although wires can be made of plastic and other materials for harsh environments or special application requirements. The passive wire connects to the object being measured by a clevis or loop, and the wire is mechanically attached to and single-wrapped around a precision-machined drum. Threading on the drum guides the wire to ensure consistent unwrapping and retraction without overlap ... maintaining the exact relationship between the wire's motion and the linear distance traveled. A coiled spring maintains tension in the wire to prevent sagging, especially in horizontal applications. A sensor with one portion attached to the drum axle serves to measure the drum's rotation — and convert mechanical rotation into an electrical signal.

When the target object moves, the wire is extended (or retracted) and the drum rotates. The sensor measures this rotation and outputs a position signal proportional to the drum's rotation — and therefore the wire's linear movement with it.

DRAW-WIRE LINEARITY

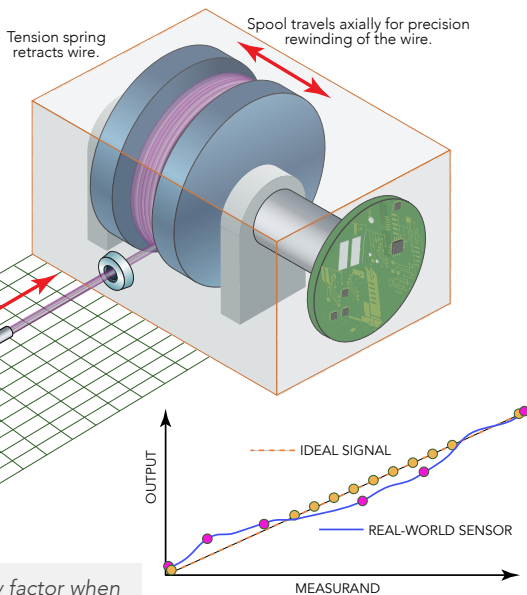

Linearity is a key factor when choosing a draw-wire sensor, with some designs achieving linearity of $\pm 0.01\%$ of the measuring range.

DRAW-WIRE TRANSDUCER DIVERSIONS

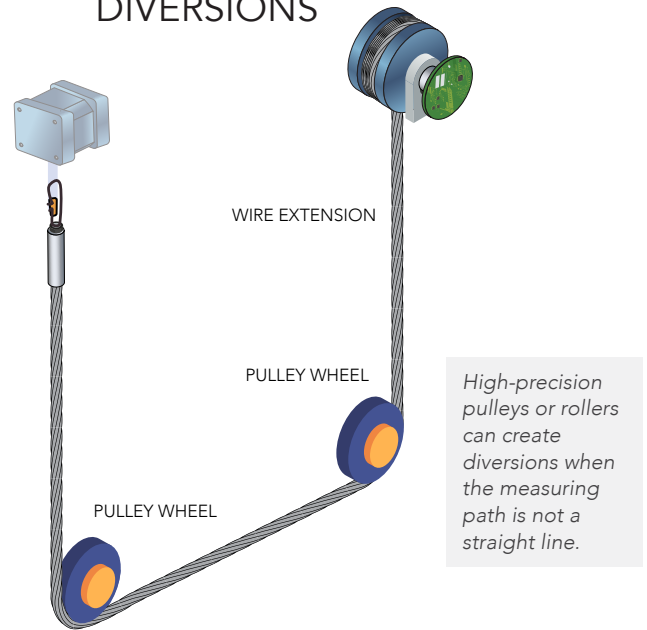

The type of sensor used depends on the application requirements. Common choices are optical or magnetic encoders, with incremental or (for longer measuring lengths) absolute output. For applications that require an analog signal, rotary potentiometers can also be used. Draw-wire sensors incorporating encoders for the electromechanical measurement function are most reliable.

Draw-wire sensors can measure distances up to 50 km (50,000 m) and can operate with wire extension and retraction speeds up to 10 m/sec and acceleration rates up to 5 g. One of the most important specifications when choosing a draw-wire sensor is linearity, which refers to the difference between the suitable output-position plot (a straight line) and the sensor's actual output-position plot. Draw-wire sensors typically range in linearity from $\pm 1\%$ to $\pm 0.05\%$ of the measuring range, but designs are available with linearity of $\pm 0.01\%$ of the measuring range.

A unique property of draw-wire sensors is that they can measure linear distance even with indirect measuring paths. When the measuring path isn't a straight line, draw-wire sensors can be used in conjunction with low-friction high-precision pulleys or guide rollers that divert to wire around obstructions — all without jeopardizing the measurement's integrity.

Draw-wire sensors are simple low-cost components that are also quite rugged — available in IP67, IP68, and IP69K-rated variations. They're suitable for applications with intermittent measuring requirements, but generally aren't recommended for applications with high or continuous duty cycles. Typical applications include patient beds, hydraulic and pneumatic actuators, lifting devices, and mobile equipment such as forklifts and construction machinery.

LINEAR POSITION ENCODING AND THE SPECIAL CASE OF CAPACITIVE TECHNOLOGIES

Whether a linear system uses servo or stepper motors, adding a [linear encoder](#) can improve the performance of the machine and the quality of the process. In servo applications, the motor's rotary encoder monitors its speed and direction, but a linear encoder monitors the load's actual position. When stepper motors are used, position monitoring is especially important, as steppers typically run in open-loop configuration ... making it difficult to unequivocally verify that the system moved to the correct position.

The two most common types of linear encoders are optical and magnetic. Traditionally, optical scales were the sole option for resolutions below 5 μm . But improvements in magnetic scale technology now allow them to compete with optical scales at resolutions down to 1 μm .

The first consideration when choosing a linear encoder is whether the application requires incremental or absolute feedback. Here, design engineers should consider whether they need to know the actuator's position after a power loss. If so, an absolute encoder is necessary — because an incremental encoder will lose its reference when the power supply is interrupted ... requiring a rehoming sequence to determine the load's actual position.

Another way to decide whether an application requires an incremental or an absolute encoder is to consider whether rehoming is feasible after a power loss. Knowing the actuator's exact position may be noncritical, but if the travel distance is long relative to the machine's speed (as is common with machine tools) an absolute encoder can help avoid downtime and productivity due to lengthy rehoming sequences.

Whether incremental or absolute, the next factor to consider is what technology the application requires.

OPTICAL LINEAR ENCODERS FOR POSITION TRACKING

Optical linear encoders use a light source that shines through a linear scale and photodetectors on the scale's other side to determine position. Optical linear encoders excel on motion axes requiring sub- μm resolution. But because their operation is based on detecting reflection or refraction of light, they are very sensitive to dirt and debris — as such contaminants can disrupt the light signal. For optical encoders, it's also key to ensuring signal integrity that the proper gap between the sensor and scale is maintained.

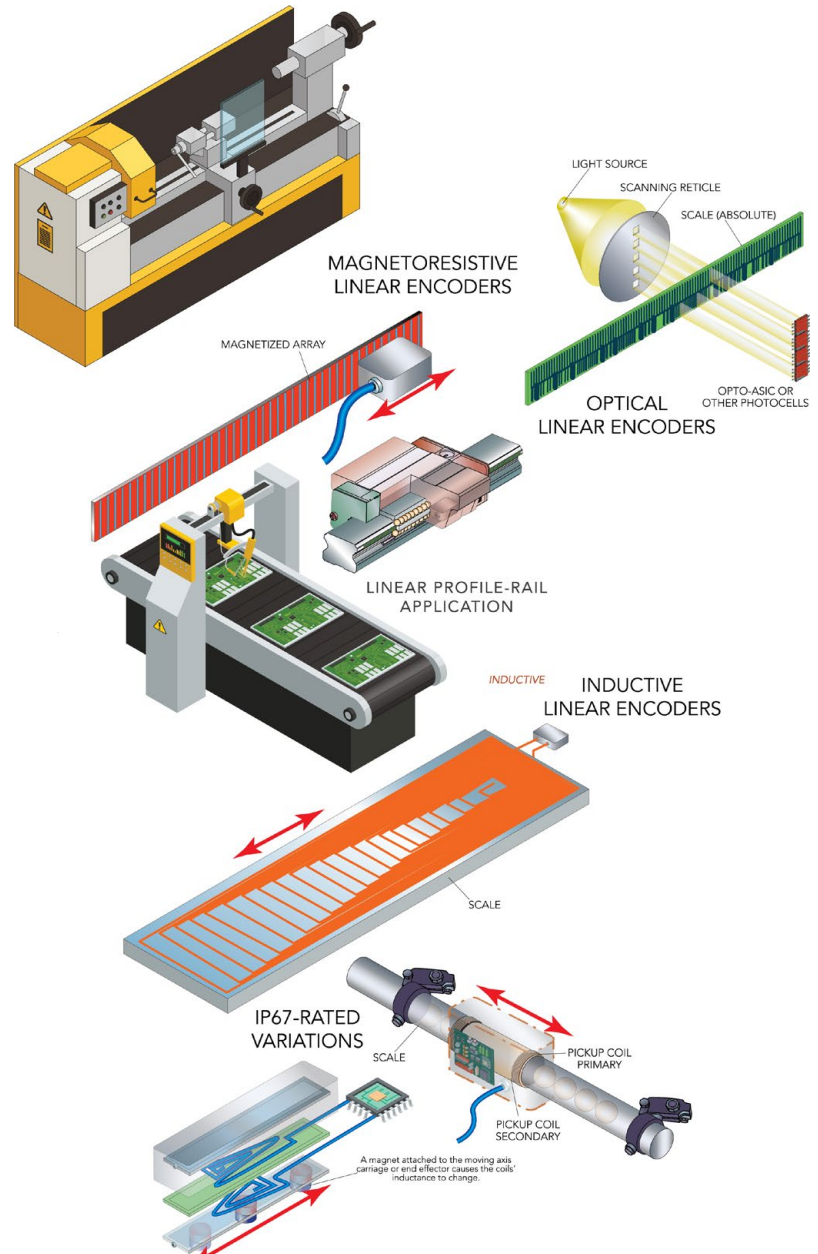

Encoder technology generally falls into three categories — [optical](#), [magnetic](#), and [capacitive](#). Optical and magnetic encoders make up the bulk of the industrial automation encoder market. Not very long ago, the choice between optical and magnetic technologies was primarily a matter of resolution. If encoder resolution below 5 μm was required, optical was the only choice. But improvements in manufacturing and signal processing now allow magnetic linear encoders to operate at resolutions down to 1 μm .

(continued)

LINEAR POSITION ENCODING – AND THE SPECIAL CASE OF CAPACITIVE TECHNOLOGIES

Shock and vibration can knock this sensor gap out of specification — and can damage the encoder — especially those with glass scales or delicate sensor ASICs.

MAGNETIC LINEAR ENCODERS FOR POSITION TRACKING

As their name implies, magnetic encoders use a magnetic reader head and a magnetic scale to determine position. Because they rely on a magnetic field rather than light detection, these encoders are mostly unaffected by dust, debris, or oil contamination. That's in contrast with optical linear-encoder designs. Shocks and vibrations are also less likely to affect magnetic linear encoders.

One caveat though: Magnetic-based linear encoders are challenged by magnetic chips and steel or iron shavings, as these can interfere with the magnetic fields upon which the encoder relies for operation.

Consider the most common variation of magnetic linear encoders. These have a read-head sensing element that rides along a magnetically coded scale. The scale coding consists of regions of alternating polarity. These alternating north and south magnetic poles are spaced at a precise distance called the pole pitch.

PROPER AIRGAP IS KEY TO RELIABLE ENCODER OPERATION

Regardless of encoder type, maintaining the correct gap between the sensor and the scale is paramount in maintaining linear-encoder performance, as that gap affects measurement accuracy.

Linear encoders that employ magnetic modes of operation (explored later in this Design-Guide section) don't require particularly tight control over the gap between the scale and detector read head. In contrast, optical encoders require tight control over a very small and precise air gap — typically in the range of 0.25 mm. Magnetic encoders can operate with gaps up to several millimeters and are more tolerant of gap-distance variations.

Another airgap item of note: Many linear-sensor and encoder manufacturers state encoder accuracy at the minimum gap, and some state linear encoder accuracy at the maximum gap. Using the latter value ensures that even if there's variability in the gap distance along the linear-encoder travel length, as long as the gap stay below the maximum allowable value, the encoder will always deliver its published accuracy. In most cases, actual accuracy will be better than published values.

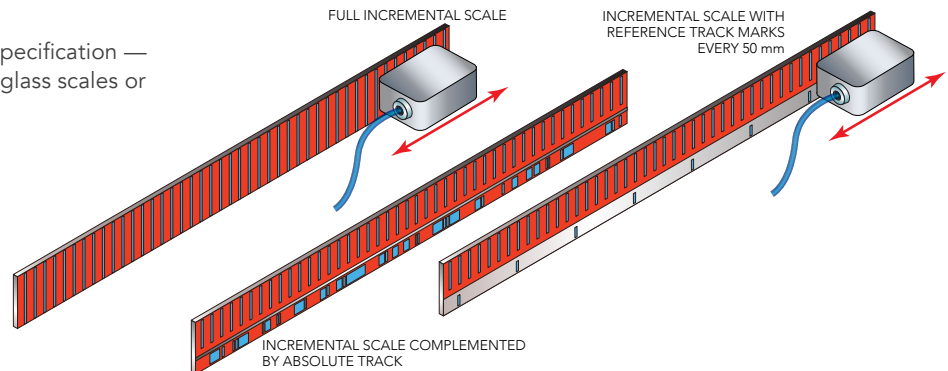

Shown here is a method for applying distance-coded reference marks, where the even numbered reference marks shift by one grating period, and any two consecutive reference marks that are detected allows the machine control to calculate where the reader head is across the length of encoder scale upon startup. To provide absolute position measurement, magnetic encoders typically employ two magnetic tracks on the same scale — an incremental track and an absolute track. The absolute track is coded with a specific pattern that gives each position a unique "word" that is read by the sensor. The read head contains two sensors — one for each track. The common setup uses a Hall sensor to read the absolute track and a magnetostrictive sensor to read the incremental track. On startup, the encoder reads the absolute track to determine its position, and then during movement, it reads the incremental track for position tracking and measurement.

The read head of a magnetic linear encoder contains either Hall or magnetoresistive sensors. These two technologies offer similar strengths and drawbacks, and in fact both quantify magnetic fields as well. However:

- Magnetoresistive linear-encoder read heads track magnetic-field direction
- Hall effect linear-encoder read heads track magnetic-field strength

As the read head moves over the tape, it detects the magnetic poles on the scale through either a change in voltage or a change in magnetic resistance.

The linear scales of magnetic linear encoders are flexible multi-layered strips having an adhesive backing and the magnetic scale — topped off (in some cases) with a plastic or stainless-steel cover strip to protect the magnetic scale. Because it's flexible and has an adhesive backing, the scale assembly is sometimes called a magnetic tape.

One advantage of magnetic linear encoders over optical versions is that the magnetic tape can be provided in very long lengths. In fact, real-world application examples include magnetic scales upwards

(continued)

LINEAR POSITION ENCODING – AND THE SPECIAL CASE OF CAPACITIVE TECHNOLOGIES

of 50 meters long. But for incremental encoding, this means the homing sequence to a single reference mark could require traversing the entire length of the encoder. This is why magnetic linear encoders often include distance-coded reference marks. These extra marks are magnetic poles on the scale in addition to the standard magnetic poles. The reference marks are individually spaced — in other words, in a distinctive irregular pattern along the length of the tape that's independent of the standard magnetic poles.

After traversing two reference marks, linear encoders with such scales can report absolute position as well as the distance between the two marks and the direction of travel as well as the length of each magnetic pole and the basic increment — the distance between odd reference marks.

CAPACITIVE-BASED DISPLACEMENT TRACKING: WHERE DOES IT MAKE SENSE?

As we've explored, linear-position feedback devices classified as linear encoders typically measure travel distances ranging from a few dozen millimeters to several meters. But when a positioning system has a very short travel — a few millimeters or less — traditional linear encoders are often too bulky or don't provide the needed measuring resolution. For these applications, [capacitive sensors offer a compact solution](#) that can measure position with nanometer-level resolution.

Rather than a scale and a read head used in typical optical and magnetic linear encoders, capacitive displacement sensors are typically made from two metal plates with a dielectric or insulating layer between them — a design called a parallel-plate capacitor.

A capacitor is a device that stores electrical energy, and capacitance is a measure of how much charge the capacitor can hold. For parallel-plate capacitors, capacitance depends on three factors: the overlapping area of the plates, the permittivity of the dielectric (typically air) between them, and the distance between the plates:

$$C = \frac{\epsilon A}{d}$$

Where C = Capacitance in farads F

ϵ = Permittivity of the dielectric in F/m

A = Area of overlap between the plates in m²

d = Distance between the plates in m

When a voltage is applied to a parallel-plate capacitor, a positive charge accumulates on one plate, and a corresponding negative charge accumulates on the other plate, creating an electric field between the plates. This field is monitored for changes, which indicate a change in capacitance.

Because the dielectric separating the plates doesn't change, any change in capacitance is due to a change in geometry — either a change in the overlapping area of the plates or a change in the distance between them. Any change in the overlapping area A indicates a change in planar displacement — the movement of the plates relative to one another along parallel planes — whereas a change in the distance d indicates a change in axial displacement.

In most applications, one sensor plate is fixed (stationary) and the other plate attaches to the moving axis end effector or payload. The plates are arranged so that their overlapping area doesn't change. Therefore, any change in capacitance is a result of a change in the spacing between the plates and represents the distance that the moving object has traveled.

Linear capacitive sensors (which are also called capacitive displacement sensors in some contexts) are absolute position measuring devices. Because they directly measure the position of the moving part, linear and planar errors are eliminated ... giving these linear sensors very high accuracy with resolution in the nanometer or in some cases sub-nanometer range. One example capacitive displacement-sensor application is in optical inspection equipment, where features measured are typically at the sub-micron or nanometer level. Here, capacitive sensors ensure the correct distance is maintained between the part and measuring optics.

Because they can measure small distances and have very compact dimensions, capacitive sensors are often used in micro and nanopositioning systems based on piezomotors or voice-coil actuators. However, they're unsuitable for humid or wet environments or those with significant temperature changes, because water has a different dielectric constant than air and can change the permittivity ϵ of the capacitor.

Sold & Serviced By:



Toll Free Phone (877) SERV098
www.electromate.com
sales@electromate.com

SPONSORED BY:



LINEAR SENSORS EMPLOYING THE HALL EFFECT

In the previous section of this Design Guide, we explored magnetism-based linear encoders that incorporate either Hall or magnetoresistive sensor in their read heads. In fact, these and other completely unique linear-sensor types (including those based on magnetostrictive technology — also covered earlier) are all categorized as magnetic linear sensors. Let's now do a deep dive on the Hall effect and how some magnetic linear sensors employ Hall chips to track position.

Recall from basic engineering training that the Hall effect was discovered in the late 1800s by physicist Edwin Hall. In short, the Hall effect is the tendency of current flowing on a conductor to deflect as it passes through a magnetic field. More precisely, any external magnetic field induces a transverse (sideways) force on the material's charge carriers (electrons, ions, and holes) that segregates them to the conductor sides — negative to one side and positive to the other. This deflection appears as a lopsided charge or voltage in the conductor.

Hall effect sensors work by detecting this voltage.

Most design engineers are most familiar with Hall-effect sensors (solid-state semiconductor chips sometimes called Hall chips) as they're used in brushless dc (BLDC) motors. Here, Hall-effect sensors perform the duty of what the brushes and mechanical commutator do in a brushed dc motor. After all, commutation is basically the sequenced energization of the motor's three stator windings — positive, negative, and off. Torque arises from the attraction and repulsion between the stator fields and PMDC motor's permanent-magnet fields. Torque crests when these two fields are at 90° and wanes as the fields align. Hall effect sensors track the rotor position to let the motor drive energize the correct stator winding for maximum torque.

Of course, Hall effect sensors are useful for linear-position sensing too. We've already detailed how some linear encoders contain Hall chips in their read heads to track magnetic-field strength from a magnetically banded (coded) encoder scale. But another design actually flips this arrangement around — so that the long linear scale is studded with an array of Hall chips, and a magnet (traversing the axis stroke with the payload, cylinder piston, or electric-actuator carriage) is the moving sensor element.

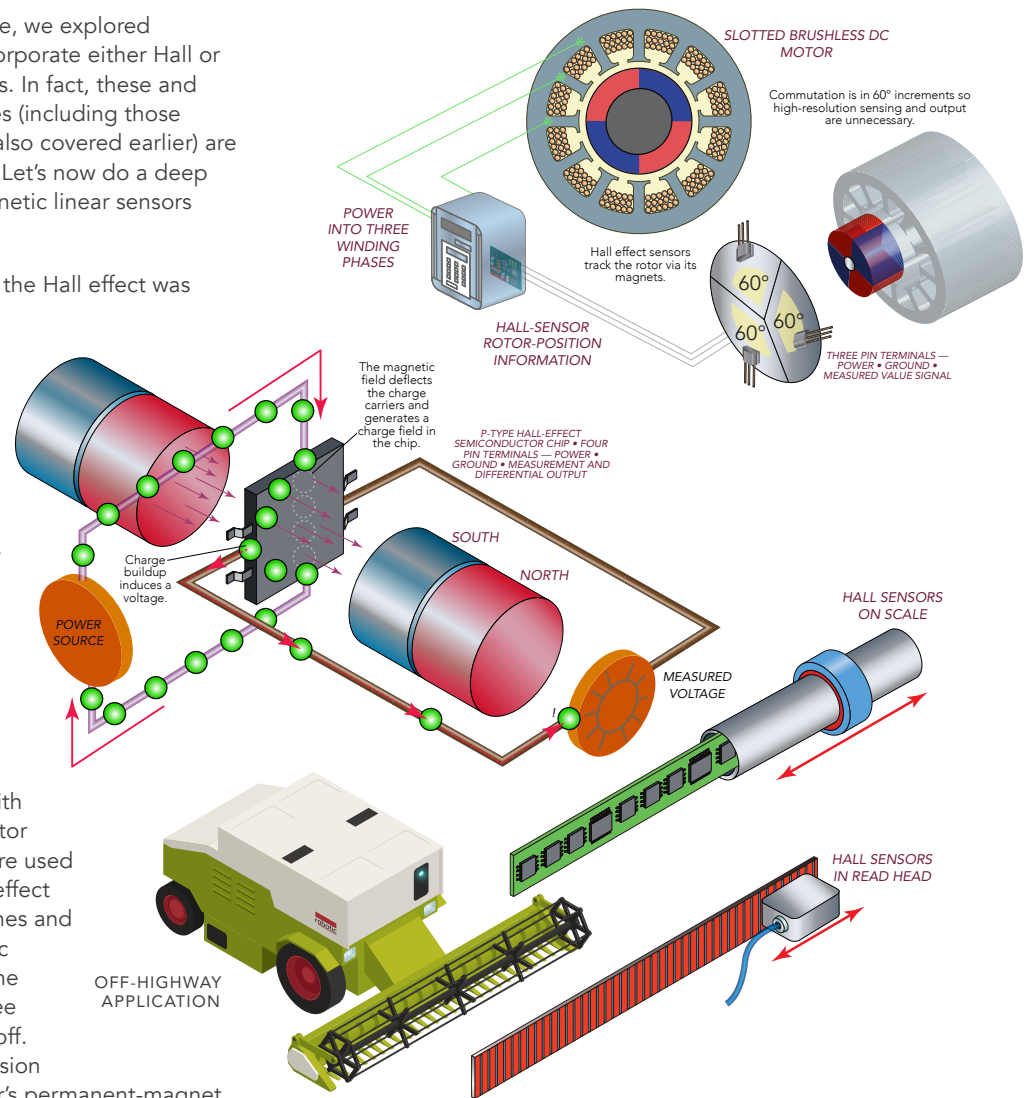

A brushless dc motor uses three Hall effect sensors to detect rotor position. Some linear-position sensors use many more.

Sold & Serviced By:
ELECTROMATE

Toll Free Phone (877) SERV098
www.electromate.com
sales@electromate.com

SPONSORED BY:
Temposonics
AN AMPHENOL COMPANY

(continued)

LINEAR SENSORS EMPLOYING THE HALL EFFECT



Such Hall-effect linear sensors place this long thin Hall-chip-studded circuit board into a stainless-steel cylindrical sheath. Then a round magnet slides along this cylinder ... and the Hall chips respond and trigger an output signal (current or a voltage or a digital output) to the system's microprocessor. That controller in turn uses the positional information to decide on response commands for the motion axis. Such linear-position sensors are quite rugged and compact, so fit into fluid-power cylinders and other actuators for off-highway equipment. In fact, some testing estimates a 60-year MTBF.

This linear-position sensor includes a long thin circuit board studded with Hall chips. A magnetic ring (in this video still a loose black element) attaches to the moving axis piston or carriage and induces response (and in turn electrical output) from the Hall chips. Image courtesy Fluid Power World

Other linear sensors employing Hall-effect sensors are programmable — and can be configured to yield an output voltage that proportionally changes with axis stroke. Such sensors let end users make in-field sensor adjustments to accommodate environmental influences (in the form of mechanical or electromagnetic factors) even while maintaining simple ratiometric signal generation. Such linear sensors are indispensable in process automation (for liquid-level monitoring) and in discrete automation involving motion axes involving precision roboticized operations.

Sold & Serviced By:

 **ELECTROMATE**

Toll Free Phone (877) SERV098
www.electromate.com
sales@electromate.com

SPONSORED BY:

 **Temposonics**
 AN AMPHENOL COMPANY

LINEAR-POSITION SENSING WITH LINEAR VARIABLE DIFFERENTIAL TRANSFORMERS (LVDTs)

Yet another technology for [measuring absolute linear position](#) is the linear variable differential transformer (LVDT). LVDTs are unlike the other linear-sensor subtypes we've already covered in this Design Guide — because unlike those magnetism-based technologies, LVDTs are an induction-based measuring system.

In short, LVDTs rely on interactions between a transformer and a core. The transformer has three coils wound on a hollow form ... typically made of glass-reinforced polymer. The primary coil is located between the two secondary coils, and the secondary coils are wound in series but in opposite directions — a configuration called *series-opposed winding*.

The core, which is made of magnetically permeable material, moves freely inside the hollow bore of the transformer. A non-ferromagnetic push rod or shaft attaches to the core and also attaches to the moving part of the object being measured.

When voltage is applied to the primary coil, magnetic flux is produced. This flux is coupled to the secondary coils by the core, causing a voltage to be induced in each of the secondary coils.

With the core located at the center of the transformer (equidistant between the two secondary coils), the series-opposed windings produce induced voltages (E_1 and E_2) that are equal in amplitude but out of phase by 180° and therefore cancel each other out. In other words, the output voltage is zero. This is often called the null point.

When the core moves away from the center of the transformer, closer to the S1 coil, for example, the S1 coil becomes more strongly coupled to the core, and the induced voltage in the S1 coil is higher than the induced voltage in the opposite (S2) secondary coil. The distance of movement is determined by the differential voltage output of the two secondary coils ($E_1 - E_2$).

The direction of motion is sensed by tracking whether the induced voltage of the secondary coil is in phase or out of phase with the primary voltage. If the core moves toward the first secondary coil (S1) the induced voltage in the S1 coil will be in phase with the primary voltage ... indicating that the core has moved in the direction of S1.

Conversely, if the core moves toward the opposite secondary coil (S2) the induced voltage in the S2 coil will be out of phase with the primary voltage, indicating that the core has moved in the direction of S2.

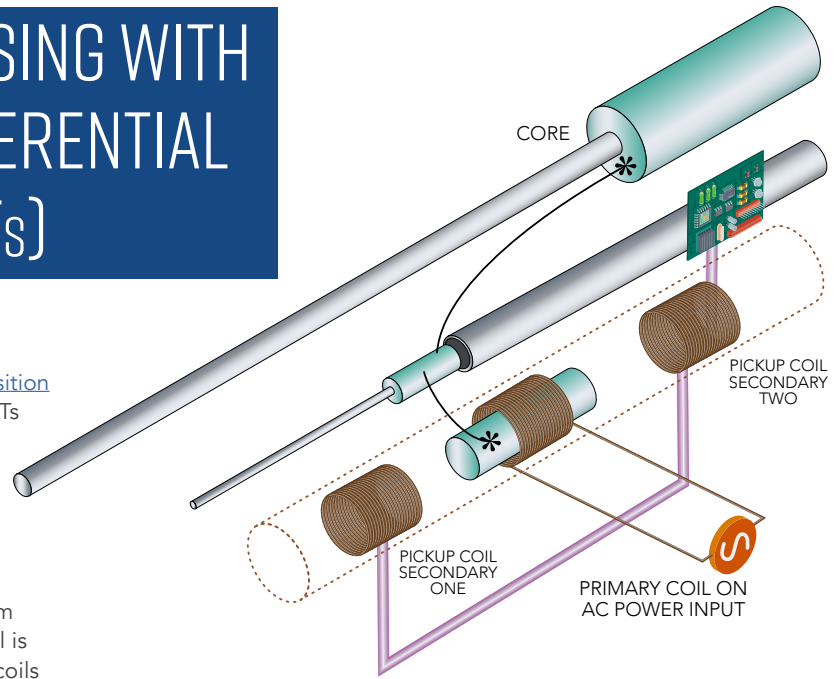

A push rod, or shaft, which is attached to the moving core, connects the LVDT to the moving part of the object to be measured.

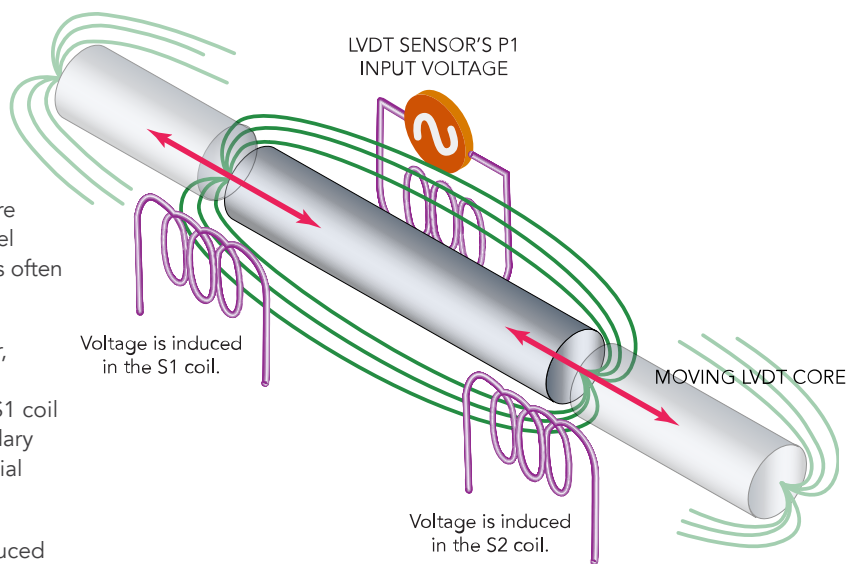

As the core moves closer to either of the secondary coils, the induced voltage in that coil increases, and the induced voltage in the opposite secondary coil decreases. The difference between the two secondary voltages ($E_1 - E_2$) indicates the distance moved. The phase of the output voltage indicates the direction moved.

Sold & Serviced By:



Toll Free Phone (877) SERV098

www.electromate.com

sales@electromate.com

SPONSORED BY:



AN AMPHENOL COMPANY

(continued)

LINEAR-POSITION SENSING WITH LINEAR VARIABLE DIFFERENTIAL TRANSFORMERS (LVDTs)

The output from a linear variable differential transformer is a direct, linear function of the input for its specified measuring range. However, it is possible to use an LVDT beyond its specified measuring range, with a predefined table or polynomial function that provides compensation for the nonlinearity. And because it relies on the coupling of magnetic flux, an LVDT has nearly infinite resolution, limited only by the signal conditioning electronics. Similarly, repeatability is extremely high — typically less than 0.1% the measurement range. Typical measurement ranges are from ± 0.25 to ± 750 mm.

The electronics required for an LVDT (called a signal conditioner) includes an oscillator to generate the drive signal, a demodulator, an amplifier, and a low-pass filter that converts the ac output voltage to a dc signal. Traditional designs keep the electronics external to the LVDT. But housing the signal-conditioning electronics within the LVDT allows the primary coil to be supplied with dc voltage, which is useful in battery-powered applications. This linear-sensor design is often called a dc LVDT. Although housing the electronics internally reduces complexity, it also reduces the device's resistance to shocks, vibrations, and temperature extremes.

Key benefits of linear variable differential transformers are their absolute output and almost infinite resolution, along with extremely high repeatability. LVDTs are extremely rugged — with no physical contact between the core and the transformer bore, there is no friction and, therefore, no wear to reduce the life of the system. And in most LVDT designs, the transformer is encapsulated in epoxy, so the internal components are protected against contamination and moisture. The housing can also be made from a variety of materials, including stainless steel, nickel alloys, or titanium to meet specific environmental requirements.

LVDT GENERATED-SIGNAL LINEARITY

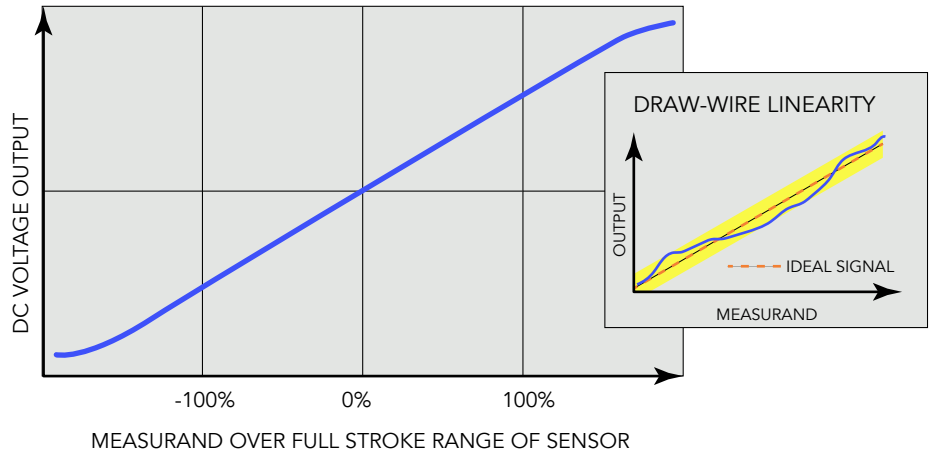

Output is almost perfectly linear across the specified measuring range. A predefined table or polynomial function in the sensor programming can compensate for slight nonlinearities at the ends of (and to some extent beyond) the measuring range.

LINEAR VARIABLE DIFFERENTIAL TRANSFORMER (LVDT)

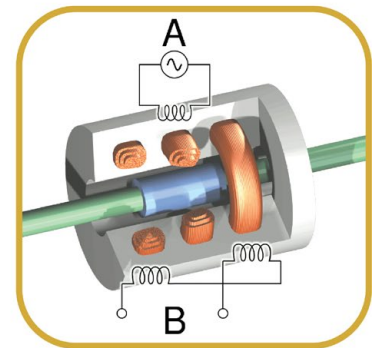
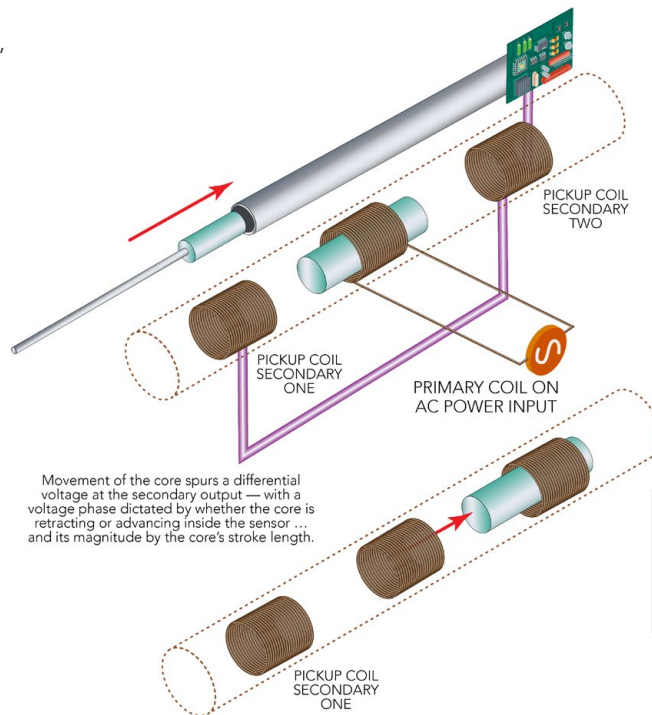

Image via Wikipedia Commons • Wapcaplet

In a dc-powered LVDT, the primary coil can be fed with dc voltage — an advantage in battery-powered applications.

Sold & Serviced By:



Toll Free Phone (877) SERV098

www.electromate.com

sales@electromate.com

SPONSORED BY:



AN AMPHENOL COMPANY

LINEAR-POSITION SENSING BASED ON INDUCTIVE TECHNOLOGY

Most design engineers involved in motion system engineering are intimately familiar with the function of induction motors. Most are also familiar with proximity sensors that use induction for metal-object presence detection. But there's a third design leveraging induction for its operation. Called inductive linear sensors, these use magnetic-field induction (in a conductive subcomponent) for linear-motion feedback.

We've covered several different magnetism-based linear-sensor technologies in this Design Guide so far ... and one induction-based variable-reluctance linear sensor (VR sensor) type as well — that of LVDTs. In fact, there are several other types of linear sensors based on induction. Two that are particularly common in motion applications are:

- Linear variable-reluctance transducers (LVRTs) — another VR sensor type — and differential variable-reluctance transducers (DVRTs) along with related variations on traditional LVDTs
- Linear-variable-inductance transducers — also called LVITs

These linear sensors actually track inductance variations — disturbances made by a conductive target through a magnetic field. The latter is made by primary winding transformer that's been energized ... sans permanent magnets needed with magnetism-based linear sensors. LVRTs resemble LVDTs but include a continuous core winding and not a segmented winding as in LVDTs. In contrast, LVITs contain an inductive sensing coil connected to onboard sensor electronics. Upon axis traversal, a conductive cylinder called a spoiler coupled to the axis' end effector travels axially through the coil — in turn changing the inductance and prompting the sensor electronics to generate an output signal proportional to axis' move.

No matter the permutation, inductive linear-sensor technologies are inherently contact-free.

INDUCTION-BASED LINEAR TRANSDUCERS

ONE LVIT VARIATION

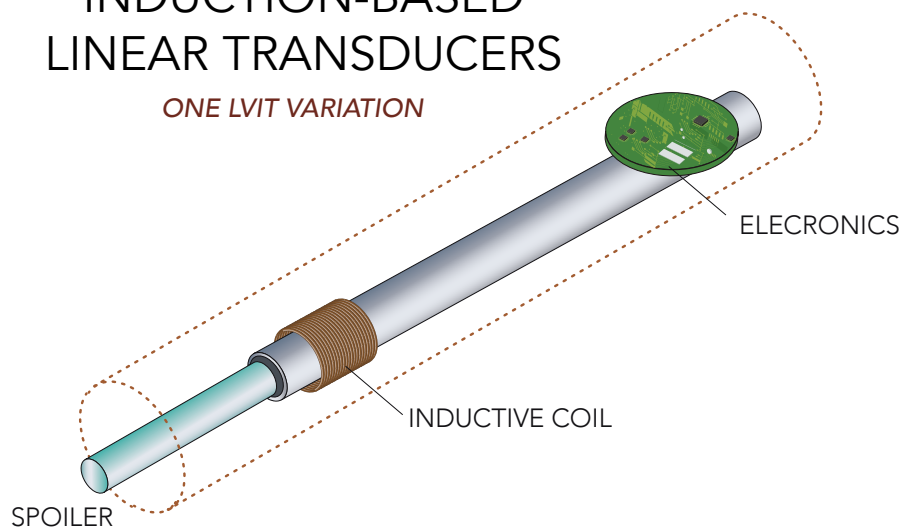

Sold & Serviced By:

 **ELECTROMATE**

Toll Free Phone (877) SERV098

www.electromate.com

sales@electromate.com

SPONSORED BY:

 **Temposonics**
AN AMPHENOL COMPANY



Temposonics

AN AMPHENOL COMPANY

Temposonics is recognized as an industry leader in sensing technologies and solutions.



I AM THE NEW GENERATION

R-SERIES V POSITION SENSORS FOR INDUSTRIAL APPLICATIONS

- Rugged & reliable
- Better performance
- Backward compatible



Temposonics

AN AMPHENOL COMPANY