



Mercury II™ 6000V Series

High Performance Encoders with Digital Output
 High Resolution and Accuracy with Linear or Rotary Glass Scales



Resolution

Linear: 5µm to 1.22nm
 Rotary: 20k to 268M CPR

Accuracy

Glass Scales:
 Linear: ± 1µm available
 ± 1.5µm to ± 5µm standard
 Rotary: Up to ± 2.1 arc-sec

Outputs

A-quad-B, Index Pulse,
 Dual Limits, and Alarm

Scales

Same Sensor for Linear or Rotary

Vacuum

10⁻⁸ Torr

The new Mercury II 6000V Encoder Series represents a breakthrough in performance, offering class-leading resolution and accuracy; digital output; the smallest sensor size; unmatched versatility, robustness, smart programmable features; easy installation and 10⁻⁸ Torr vacuum rating.

Mercury II: The Next Generation

High-Resolution Digital Output

MicroE Systems revolutionized encoder technology with the original Mercury encoder family. Smaller, faster, and smarter than anything before, it set the standard for innovation. Now Mercury II, MicroE System's newest family of reflective incremental encoders, takes another giant step forward by giving you "best-in-class" performance, unparalleled versatility, superior robustness, and unmatched ease of use. You get all of this from a single encoder system.

The MII 6000V sensor is vented and constructed with vacuum compatible materials and designed for a 48 hour bake out at 150°C. Color coded bare leads are provided for customer termination.

System Features at a Glance

- High-resolution interpolated digital output resolution from 5µm to 1.2nm
- Extremely low cyclical error - only ± 20nm - provides smooth velocity control
- Small sensor - 8.1mm tall sensor fits tight spaces
- Faster - up to 5m/s at 0.1µm resolution
- Smarter - programmable resolution in integer steps
- Linear glass scales for high accuracy
- Optical index and left / right limits

- Bi-directional optical index is repeatable to 1LSB
- Low power consumption; low heat generation at the sensor
- High tolerance to scale contamination
- Broadest alignment tolerances
- Status LED's in the connector show encoder status at a glance
- Software for setup, programmable features, monitoring and diagnostics
- RoHS and CE compliant

Optional Features

- Glass scale length or diameter:
 Linear lengths from 10mm to 1m or custom
- Rotary diameters from 44mm to 121mm or custom
- SmartPrecision™ II Software

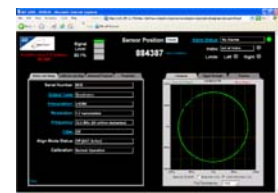

Table of Contents

System & SensorPg. 1-6
 ElectronicsPg. 7-8
 SmartPrecision II SoftwarePg. 9-10

ScalesPg. 11-12
 Ordering InformationPg. 13-14

System Configurations

Standard and Optional Equipment

Mercury II™ 6000V Series Smart Encoder Systems

Standard Equipment



The atmospheric cable is double shielded and 1m in length. The cable contains color-coded bare leads for customer termination.



Encoder Sensor
 Same sensor for linear or rotary glass scales.



Sensor Cable
 The vacuum cable is single shielded and 1.5m long.



Connector
 RS-422 compliant
 15 pin standard
 D-sub connector

Built-in status LED's show the encoder's operational status at a glance, at all times.



SmartPrecision™ Alignment Tool for Setup – ATMII5000

Provides fast and easy sensor set up. Includes setup and limit indicator LEDs, pushbutton index and limits setup, built-in SmartPrecision II Software (use is optional – not required for setup), Ethernet interface, and AC/DC power supply (not shown). The Alignment Tool is not for use while in servo control.

Mercury II 6000V Series

Optional Equipment

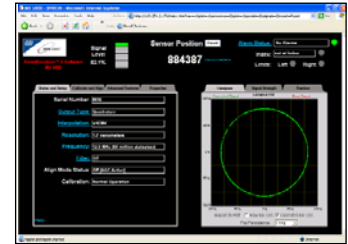

SmartPrecision II Software

The software performs setup, monitoring and diagnostics, includes displays for encoder output, multiple data plots, and is used for programmable functions. It is built into the ATMII5000 Alignment Tool; use is optional. See Page 9 for details. Requires Ethernet cable.

MII 6000V System Features at a Glance

The Mercury II™ 6000V Series is built on the field-proven Mercury technology platform. Known for being smaller, smarter and faster, Mercury II builds on the original Mercury™ series and adds increased performance, versatility, robustness, and ease-of-use.

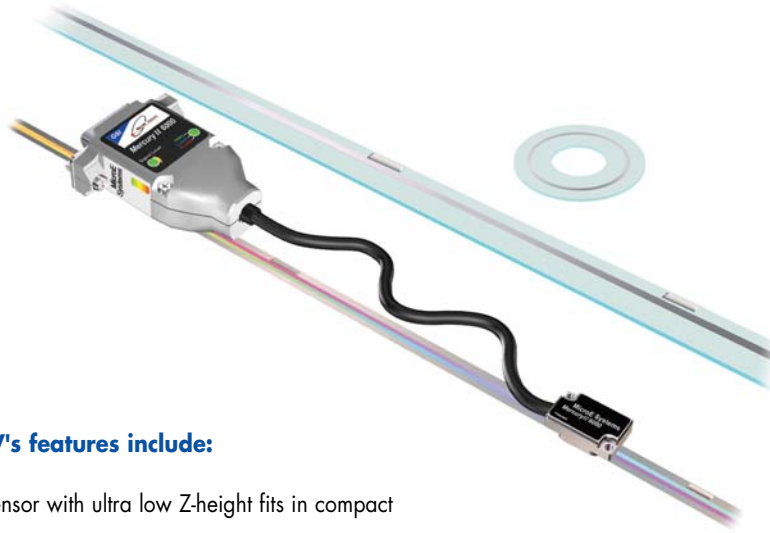

Mercury II 6000V's features include:

- Small, low-mass sensor with ultra low Z-height fits in compact motion systems
- Superior resolution and accuracy - resolutions up to 1.22nm (linear), 268M CPR (rotary); short-travel accuracy of ± 20 nm typical (linear glass scales); up to $\pm 1\mu\text{m}$ (linear glass scales up to 130mm long)
- High-speed operation - up to 5m/s at 0.1 μm resolution
- Versatility - one sensor works with linear or rotary glass scales

- Low power consumption - only 50mA at the sensor, and 180mA with A, B, I, LL and RL outputs terminated for the whole encoder system
- Status LED's in the connector show encoder signal strength and limit status at a glance
- Robustness features include all differential digital outputs, all digital signals from the sensor, and double-shielded cabling for superior EMI/RFI immunity; scale contamination resistance insures encoder operation even with fingerprints, oil, dust and other forms of contamination
- Dual optical limits have differential outputs and reduce motion system cabling; limit markers fit right on the 6mm wide scale for maximum space savings
- Included software makes setup, motoring and diagnostics easy; Ethernet connectivity allows you to use any computer

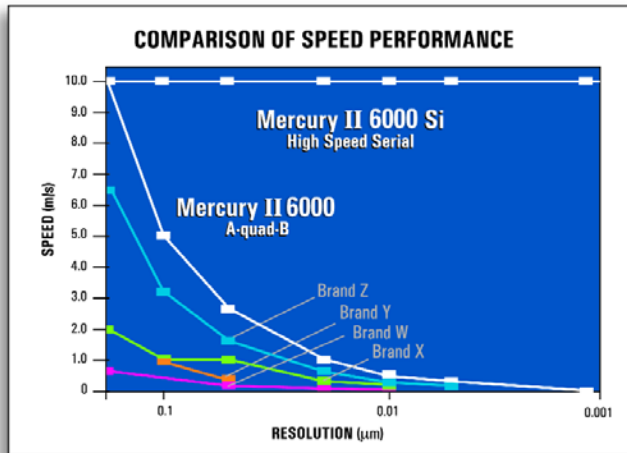

- Broad sensor alignment tolerances, and the alignment tool's built-in red/yellow/green setup LEDs and pushbutton setup, make setup fast and eliminate ancillary setup instruments
- Low sensor power consumption and heat generation – electronics in the sensor are minimized to achieve the lowest possible power consumption and associated heat generation, making the motion stage more thermally stable. Sensor power consumption is just 50mA at 5V DC.

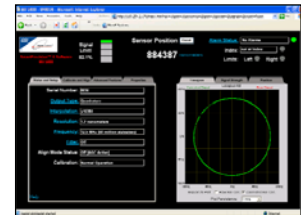

Smallest Sensor, Lowest System Height, Smallest Scale System, Broader Alignment Tolerances, and More

Why Mercury II™ Encoders Make It Easier To Design High Performance Into Your Equipment

Mercury II Can Reduce System Size and Cost

Mercury II 6000V's sensor height is 23% shorter than competitive encoders, making it easier to fit into your design. This reduction can also cut motion system weight and cost by allowing the use of smaller motors and stages.

Mercury II 6000V's optical index and limit markers are placed within the 6mm width of the scale, saving even more space by eliminating external index and limit magnets.

Lowest Sensor Height

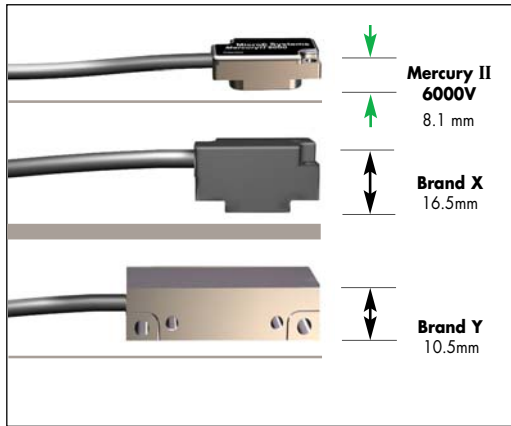

Smallest System

Mechanical Dimension Comparison*

	Mercury II 6000V	Brand X	Brand Y	Mercury II vs. Best Competitor
Sensor Z height	8.1mm	16.5mm	10.5mm	23% better
Standoff tolerance	± 0.15mm	± 0.1mm	± 0.1mm	50% better
Scale System width**	6.0mm	20.0mm	15.3mm	155% better

*Based on published specifications for encoders with digital output

**Scale system width including index and limits

Theta Z Alignment Tolerance

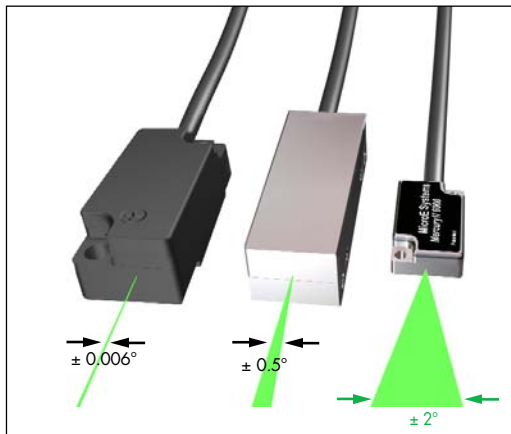

Eliminate the Frustration of Touchy Encoder Alignment

With Mercury's patented PurePrecision™ optics, you can push the sensor against your reference surface, tighten the screws and you're finished. Try that with Brand X or Y.

This performance is possible thanks to relaxed alignment tolerances, particularly in the theta Z axis. Mercury II offers a ± 2° sweet spot – that's a 300% improvement over the best competitive encoder. And that will result in dramatic savings in manufacturing costs.

No other commercially available encoder is easier to align, easier to use, or easier to integrate into your designs.

Alignment Tolerance Comparison*

	Mercury II***	Brand X	Brand Y	Mercury II vs. Best Competitor
theta Z	± 2.0°	± 0.006°	± 0.5°	Mercury is 300% better
theta Y	± 1.0°	unspecified	± 1.0°	
theta X	± 1.0°	± 0.1°	± 1.0°	

*Based on published specifications for encoders with digital output

***Measured at a constant temperature for one axis at a time with all other axes at their ideal positions

Lowest Power Consumption

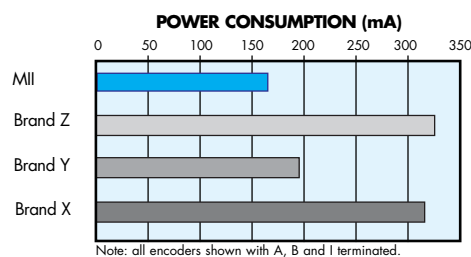

MII 6000V uses advanced electronics, giving MII 6000V the lowest power consumption of any high-performance digital-output encoder:

- Lowest heat generation / dissipation
- Cost and size savings in the controls / drives
- More system design flexibility

MII 6000V System Specifications

Resolution and Maximum Speed Tables

Mercury II™ 6000V Series systems have programmable interpolation from x4 to x16384 in integer steps. Below is a table of sample values. For applications requiring up to 10m/s at full resolution, use the MII6800Si with high speed serial interface.

Linear - 20µm grating pitch

Maximum Interpolation	Resolution	Maximum Speed*
x 4	5.000µm/count	10000mm/sec
x 10	2.000µm/count	10000mm/sec
x 20	1.000µm/count	10000mm/sec
x 40	0.500µm/count	10000mm/sec
x 80	0.250µm/count	10000mm/sec
x 100	0.200µm/count	10000mm/sec
x 200	0.100µm/count	5000mm/sec
x 400	0.050µm/count	2500mm/sec
x 1000	20.0nm/count	1000mm/sec
x 2000	10.0nm/count	500mm/sec
x 4000	5.00nm/count	250mm/sec
x 8000	2.50nm/count	125mm/sec
x 16384	1.22nm/count*	61mm/sec

† Value rounded for readability; use the formula $[20\mu\text{m}/\text{interpolation multiplier}]$ to calculate the exact resolution in units of µm/count.

Rotary - 20µm grating pitch

Rotary Glass Scale Diameter	Fundamental Resolution	Interpolation						
		x4	x20	x40	x400	x1000	x4000	x16384
44.45mm	5000 CPR							
	interpolated resolution (CPR)	20000	100000	200000	2000000	5000000	20000000	81920000
	interpolated resolution (arc-sec/count)**	64.8	12.96	6.48	0.648	0.259	0.0648	0.01582
	interpolated resolution (µrad/count)**	314	62.8	31.4	3.14	1.257	0.314	0.0767
	maximum speed* (RPM)	6000V	6000V	6000V	1500	600	150	36.6
63.50mm	8192 CPR							
	interpolated resolution (CPR)	32768	163840	327680	3276800	8192000	32768000	134217728
	interpolated resolution (arc-sec/count)**	39.6	7.91	3.96	0.396	0.1582	0.0396	0.00966
	interpolated resolution (µrad/count)**	191.7	38.3	19.17	1.917	0.767	0.1917	0.0468
	maximum speed* (RPM)	3660	3660	3660	915	366	91.5	22.3
120.65mm	16384 CPR							
	interpolated resolution (CPR)	65536	327680	655360	6553600	16384000	65536000V	268435456
	interpolated resolution (arc-sec/count)**	19.78	3.96	1.978	0.1978	0.0791	0.01978	0.00483
	interpolated resolution (µrad/count)**	95.9	19.17	9.59	0.959	0.383	0.0959	0.0234
	maximum speed* (RPM)	1830	1830	1830	457	183.1	45.7	11.17

* Maximum speed produces an encoder quadrature output of 50 million states per second (12.5MHz). See p. 8 for additional output frequencies. Maximum speeds shown above will be reduced if a lower quadrature output frequency is selected.

**Resolution values shown are approximate. To calculate exact resolution values, convert from CPR (Counts Per Revolution) to the desired units.

To calculate desired rotary interpolation multiplier, use the following equation:
 Interpolation Multiplier = Desired Resolution (CPR)/Fundamental Scale Resolution (CPR).

Note: Specifications assume XOR function which is available in all standard controllers.

MII 6000V System Specifications

System

Scales:

- Linear glass scales for high accuracy
- Rotary glass scales for rotary applications

Grating Period	20µm
Signal Period	20µm
System Resolution	5µm - 0.00122µm* in integer interpolation steps (factory set or user programmed using included SmartPrecision™ II Software)

*Value rounded for readability; use the formula $[20\mu\text{m}/\text{interpolation multiplier}]$ to calculate the exact resolution in units of µm/count.

Linear accuracy**

	Glass Scales
Short-travel Accuracy	± 20nm typical over any 20µm movement
Long-travel Accuracy	High accuracy grade: ≤ ±1µm for scales up to 130mm ≤ ±2µm for scales from 130mm to 1m
	Standard accuracy grade: ≤ ±1.5µm for scales up to 130mm ≤ ±5µm for scales from 130mm to 1m

**Maximum error over the specified movement when compared to a NIST-traceable laser interferometer standard, used at room temperature.

Rotary Accuracy*	Scale O.D.	Microradians	Arc-Seconds
	44.45mm	± 38	± 7.8
	63.50mm	± 19	± 3.9
	120.65mm	± 10	± 2.1

*Based on ideal scale mounting concentricity

Index: optical index is bi-directional and full speed. Note: after power up, the index mark must be passed once at ≤ 1 m/s for proper operation.

Limits: separate left and right limits

Sensor Size

H:	8.13mm
W:	12.70mm
L:	22.61mm

Operating and Electrical Specifications

Vacuum:	10 ⁻⁸ Torr, negligible outgassing
Bake Out:	Up to 150°C; up to 48 hours, non-operating
Power Supply:	5VDC ±5% @ 140mA (No outputs terminated) @ 180mA (A, B, I, and both limits terminated); 50mA at the sensor
Temperature	
Operating:	0 to 70°C
Storage:	-20 to 85°C
Humidity:	10 - 90% RH non-condensing
EMI:	CE Compliant
Shock:	300G 0.5 ms half sine (Sensor)
Vibration:	30G @ 17Hz
Sensor Weight:	3g (Sensor without cable)
Cable:	The 1.5m vacuum-compatible cable is EMI shielded and comes standard with color coded bare leads for customer termination at the vacuum bulkhead. Custom cable lengths and connectors are available.

Reliability Information

5 year Expected Reliability: >99.8% under normal operating conditions.

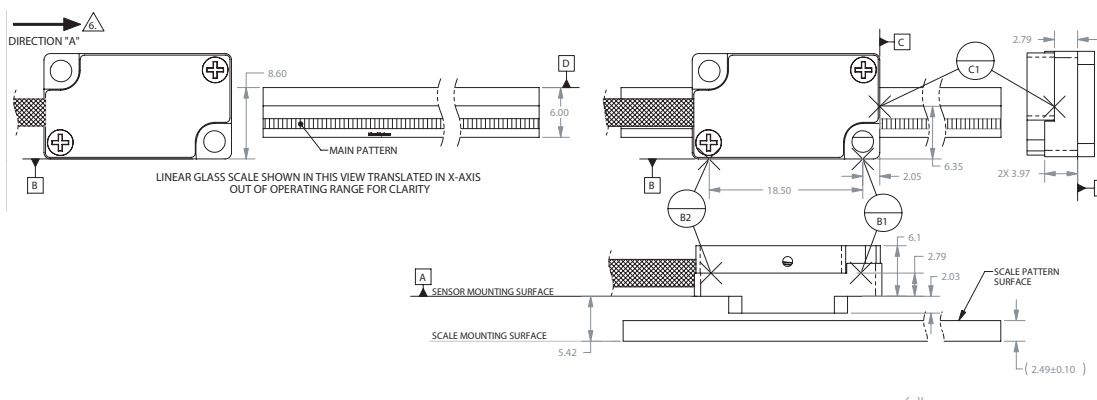

NOTE:

Sensor shown with 6mm wide glass scale. Refer to the Mercury II™ 6000V interface drawings for additional dimensional details and important notes.

Vacuum Encoder System

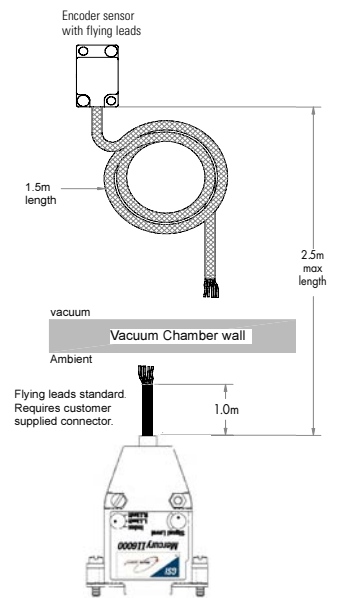

Mercury II™ 6000V Electronics



The Mercury II™ 6000V series encoders are optimized to achieve the smallest sensor with the lowest power consumption, while delivering high resolution and accuracy. This compact, versatile system includes the following features:

- Programmable interpolation level and output bandwidth
- Accuracy optimization - sensor signals are automatically optimized to improve system accuracy and maximize repeatability
- Bi-directional index output pulse with repeatability of 1LSB
- A-Quad-B tri-state output alarm for low signal
- All settings and setup parameters are stored in non-volatile memory
- Superior EMI/RFI immunity - all outputs are differential; CE compliant
- Status LED's in the connector show the encoder's operational status at a glance

Programmable Interpolation

The sensor has programmable interpolation that is selectable over the range x4 to x16,384 in integer steps (depending on model), providing output resolutions that can be matched to your application requirements. This feature allows customers to reduce inventory and field spare parts costs since one electronics module can be programmed for many different resolution requirements and different motion axes. Motion system development engineers also benefit from the flexibility of programmable interpolation by allowing them to vary the encoder's resolution during motion system loop tuning and optimization. Linear resolutions can range from 5µm to 1.2nm in convenient increments and rotary resolutions from 20k CPR to 268 million CPR. Specify the interpolation value at the time of ordering or select the interpolation at your site using SmartPrecision II Software.

Programmable Maximum Output Frequency

For encoder applications combining high resolution and high speed, the sensor supports up to 50 million quadrature state changes per second*. By specifying the maximum output frequency to match your controller's capability - ranging from approximately 0.098 to 50 million quadrature state changes per second - the Mercury II encoder system will never produce encoder counts faster than your controller can read them. Specify the encoder's maximum output frequency at the time of ordering or select the setting at your site using MicroE's SmartPrecision II Software.

Dual limits

Mercury II includes independent left and right limits with differential TTL outputs.

The limit outputs are momentary. The TTL output for limits is active-low, making them electrically fail-safe. Limit outputs can be configured for active-low or active-high at the time of ordering, or by the customer using SmartPrecision II Software, to match your controller's requirement.

* "Quadrature state changes per second" is the reciprocal of "dwell time" or "edge separation". For example, 50 million states per second = 0.02 µsec dwell time.

Programmable Low Pass Filter

The Mercury II 6000V has a programmable low-pass output filter for enhanced performance in low speed applications. The filter can be disabled for full bandwidth or set from 0.01 - 100kHz in steps of 0.01kHz, where the frequency is -3dB output roll off.

Alignment Tool



Alignment Tool Features

- Provides fast and easy sensor alignment, index setup and limit setup
- Status and setup LED's: red / yellow / green signal strength LED's assist during setup and provide diagnostics at a glance; status LED's for both limits; power-indicating LED
- Includes AC/DC power supply
- Use pushbutton or software for setup
- Built-in SmartPrecision II Software for setup, monitoring, and diagnostics; only a web browser is needed (use of software is optional)
- Ethernet software connectivity supports remote connection to the Alignment Tool and MII6000V encoder, and multiple encoders / computers

Note: Alignment Tool and software not for use while in servo control

Mercury II™ 6000V Outputs

Mercury II 6000V Series Outputs:

15-pin standard Male D-sub connector

PIN	Function
1	Right Limit+
2	Ground
3	Right Limit-
4	Index-
5	B-
6	A-
7	5V
8	5V
9	Ground
10	Left Limit+
11	Left Limit-
12	Index+
13	B+
14	A+
15	Alarm

NOTE:

Tri-state alarm: A and B are tri-stated if the encoder signal becomes too low for reliable operation

Mechanical Information - 15 pin Connector

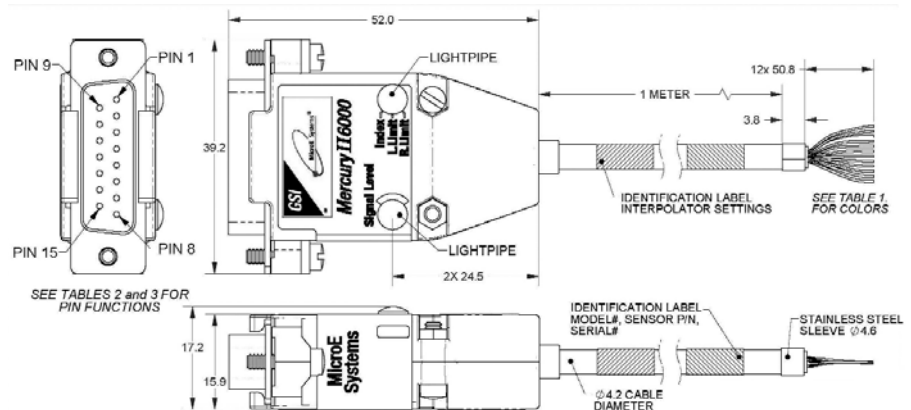

Maximum Quadrature Output Frequency

Output Frequency (MHz)	A-Quad-B Output Rate (millions of states/sec)	Dwell Time (or edge separation) (µsec)
12.50	50.00	0.02
6.25	25.00	0.04
3.125	12.50	0.08
1.563	6.25	0.16
0.781	3.125	0.32
0.391	1.5625	0.64
0.195	0.78125	1.28
0.098	0.390625	2.56
0.049	0.1953125	5.12
0.024	0.09765625	10.24

*Values shown are approximate. Exact values may be calculated as follows: Output Frequency = 12.5MHz / 2^n where n = number of steps below 12.5MHz, or Output Rate = 50 / 2^n where n = number of steps below 50 million states per second.

Output Signals

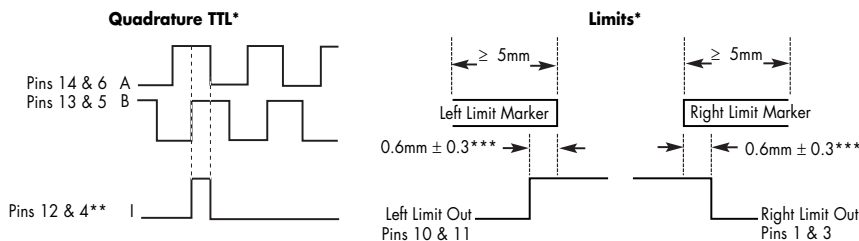

*Output signals are differential. Inverse signals are not shown for clarity.

**Note: At some interpolation values the index pulse may be aligned with other states of A or B than the ones shown.

***Above are with reference to the sensor's optical centerline (see interface drawings).

Signal Termination for A-quad-B, Index and Limits

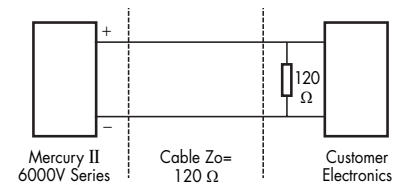

SmartPrecision™ II Software

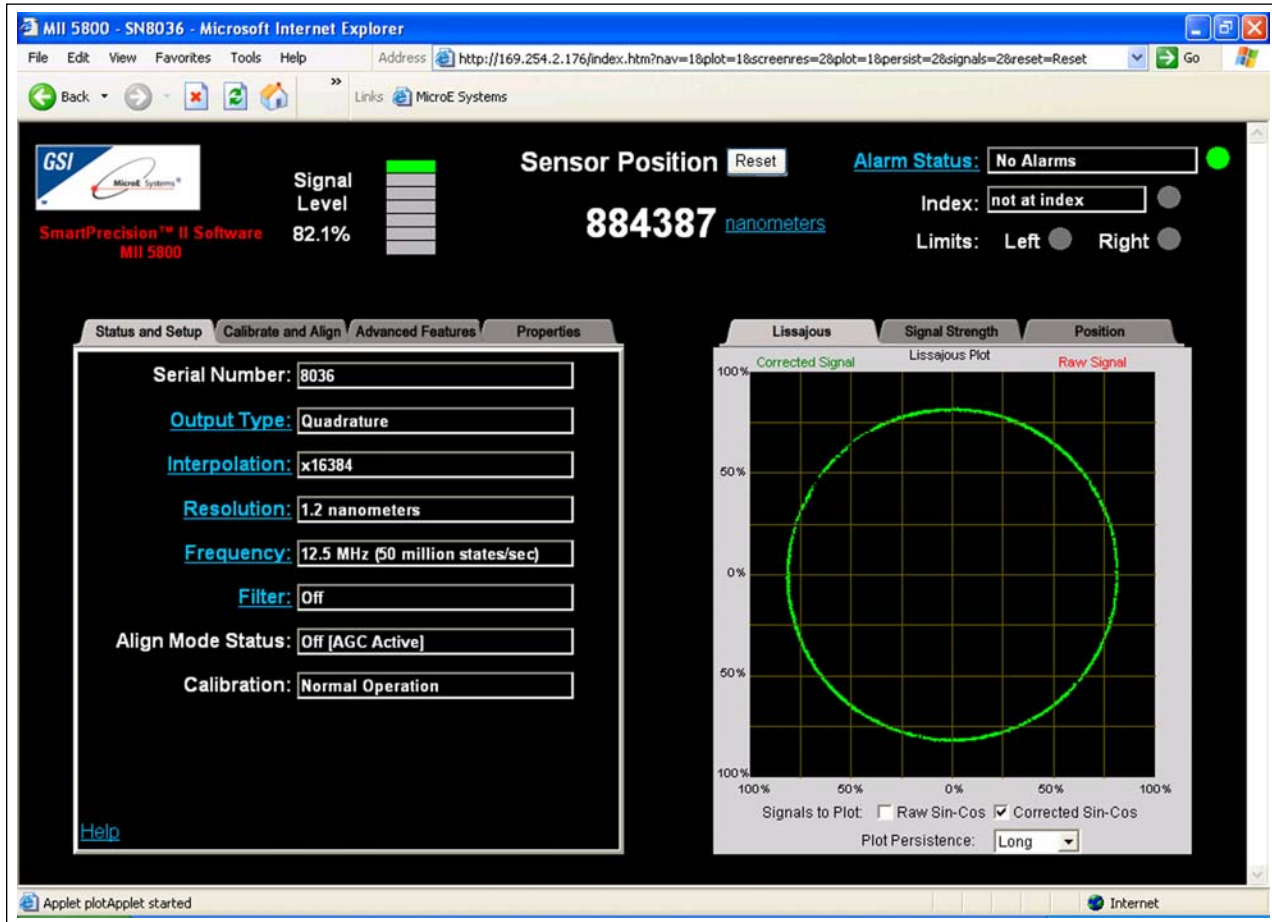

Why use software with an encoder?

Mercury II™ 6000V's Alignment Tool includes include built-in SmartPrecision II Software. The Alignment Tool's pushbutton setup process does not require use of the software, however SmartPrecision II Software adds unique functionality:

- Monitor encoder operation using digital readouts and data plots such as Lissajous
- Get support from trained MicroE Systems' support personnel for diagnosing customer equipment, no matter where the equipment is located throughout the world
- Use Mercury II's programmable features for more rapid integration and motion system optimization
- Perform encoder setup with the convenience and step-by-step prompts of a software interface

Included with every Mercury II 6000V Alignment Tool, SmartPrecision II Software can perform setup, monitoring, and diagnostic functions locally or remotely across a LAN or WAN. It operates from the encoder using simple Java commands and thus does not require any software to be installed on the computer other than a standard web browser (such as Internet Explorer). Compatible with numerous web browsers and operating systems, its features include simultaneous displays of:

- Position in engineering units
- Lissajous plot
- Encoder signal level
- Status of software alarms, index and limits
- Status of programmable encoder settings
- Encoder serial number

SmartPrecision™ II Software

Functions:

- Setting of programmable features, including interpolation in integer steps and quadrature output frequency
- Encoder Calibration
- View the Software Alarm Details

Program Mercury II™ Encoder Electronics

- Set interpolation in integer steps from x4 to x16,384 (Mercury II 6800)
- Set maximum output frequency to match your controller
- Disable / enable low-pass filter and set filter roll-off frequency
- Set limit logic when necessary to match your controller's requirements

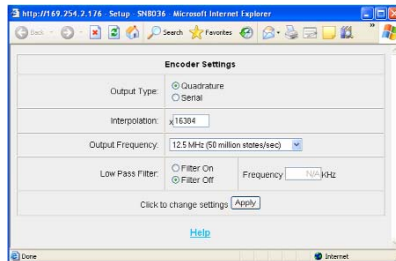

Install Mercury II 6000V Encoders

- Align sensor using Signal Level display and Lissajous data plot
- Locate index and see when sensor is over the scale's index mark
- Verify sensor output over length of scale using the Signal Strength plot

Monitor Mercury II 6000V Encoder Operation

- Read encoder position in engineering units of your choice
- View data plots (software not for use while using Mercury II 6000V in servo control)
- Monitor software alarms and programmable settings

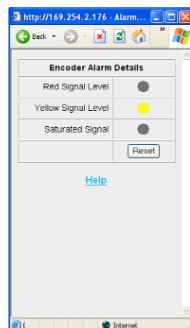

Diagnose Mercury II 6000V Encoder Performance

- Capture signal data and email it to MicroE for rapid diagnostic support
- View software alarms and programmable settings

Ethernet Connectivity Features

The software resides in the Mercury II 6000V Alignment Tool as a 'web server' and is accessed using an Ethernet connection. The computer does not need any special software to be installed, so virtually any computer can connect instantly to a Mercury II 6000V Alignment Tool. Ethernet connectivity advantages include:

- High speed, network data connection supports many configurations:
 - one encoder with one computer
 - many encoders with one computer
 - several computers and one encoder
 - multiple encoders and multiple computers
 - one-to-one (no network), LAN, WAN, or router
- Securely connect to the encoder remotely for monitoring and field support through your company's Virtual Private Network
- The software's web server architecture can
 - respond to a variety of requests (html pages, data requests, java plots, etc.)
 - take requests from most operating systems
 - take requests from a variety of sources (user with web browser, user-software, scripts, controller, etc.)
- Program your controller to communicate with the encoder using simple HTML web commands for 'observer' position data feedback or encoder status, including calibration, alarms, and limits
- Computer operating system independence and flexibility of interfacing to your own software without needing any dlls, drivers or any specific hardware or software configuration

Computer Requirements

- Any computer with a web browser (such as Internet Explorer) and Java 2.0 installed and enabled
- Ethernet connection to a computer, LAN, WAN or router

How To Order

SmartPrecision II Software is included with all Mercury II 6000V Alignment Tools and does not require any installation - just access it using your computer's web browser.

Linear and Rotary Glass Scales

MicroE Systems offers a wide array of chrome on glass scales. Easy to install, choose from standard linear and rotary scales, or customized linear, rotary, and rotary segment scales where needed. Use linear glass scales when you need the highest accuracy.

Glass Scale Options

- Standard linear: 10mm - 1m (consult MicroE for longer lengths)
- Standard rotary: 44mm - 121mm diameter, with or without hubs
- Custom linear*: special lengths, widths, thickness, index mark locations, pre-printed index and limits, and special low CTE materials
- Custom rotary*: special ID's, OD's (up to 304.8mm), index mark inside the main track and special low CTE materials
- Mounting of hubs for rotary scales: MicroE Systems can mount and align standard, custom, or customer-supplied hubs
- Rotary segments*: any angle range; wide range of radius values

*Custom scales or rotary segments are available in OEM quantities.
 Contact your local MicroE Systems sales office.

Linear Glass Scales

The index is bi-directional, operates at all encoder speeds, and is repeatable to 1LSB.

The scale length that you specify for your application must be calculated as follows.

$$\text{Glass Scale Length} = \text{Measuring Length} + 5\text{mm}$$

Example: A Measuring Length of 25mm is required, and limits will not be used. Scale Length = 25mm + 5mm = 30mm.

Index mark location and limit mark lengths can be customer-specified. Contact MicroE Systems.

Standard Short Linear Scales

130mm and Shorter

Dimensions in mm.

Specifications

Accuracy	±1.5µm standard accuracy grade ±1µm available (high accuracy grade)
Material	Soda lime glass
Typical CTE	8ppm/°C (Ultra-low CTE glass available)

Order the required Scale Length using model number MILxxxx where xxxx = Scale length in mm (10mm - 1000mm). Example: (30mm Linear Glass Scale): MIL030.

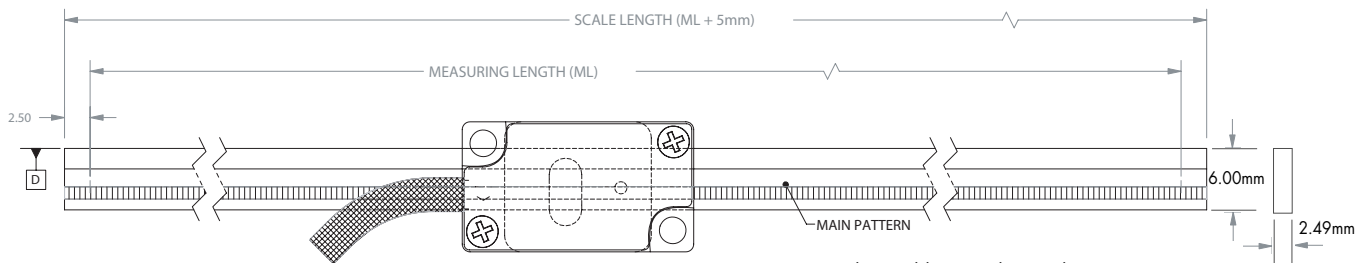

D = Mounting Surface Reference Edge

Note: The following are only examples; you can order any size.

Model	MIL018	MIL030	MIL055	MIL080	MIL105	MIL130
Scale Length	18mm	30mm	55mm	80mm	105mm	130mm
Measuring Length - Without Limits	13mm	25mm	50mm	75mm	100mm	125mm
Measuring Length - With Limits	N/A	N/A	15mm	40mm	65mm	90mm

Custom scales available, including scales with pre-printed index and limits

Linear Glass Scales

Standard Long Linear Scales

131mm and Longer (Dimensions in mm.)

Specifications

Accuracy	±5µm standard accuracy grade
	±2µm available (high accuracy grade)
Material	Soda lime glass
Typical CTE	8ppm/°C (Ultra-low CTE glass available)

Order the required Scale Length using model number MIILxxxx where xxxx = Scale length in mm (10mm - 1000mm).

Example: (225mm Linear Glass Scale): MIIL225. Contact MicroE Systems for lengths greater than 1m.

Index mark location and limit mark lengths can be customer-specified. Contact MicroE Systems.

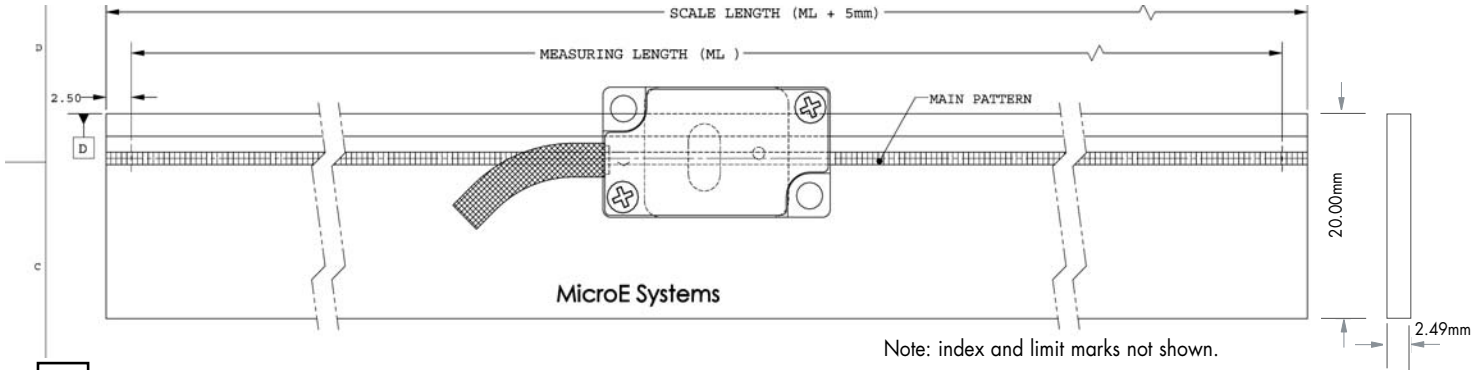

D = Mounting Surface Reference Edge

Note: The following are only examples; you can order any size.

Model	MIIL155	MIIL225	MIIL325	MIIL425	MIIL525	MIIL1000
Scale Length	155mm	225mm	325mm	425mm	525mm	1000mm
Measuring Length - Without Limits	150mm	220mm	320mm	420mm	520mm	995mm
Measuring Length - With Limits	115mm	185mm	285mm	385mm	485mm	960mm

Rotary Glass Scales with Built-in Index

Standard Rotary Scales

Specifications

Material	Soda lime glass
Typical CTE	8ppm/°C

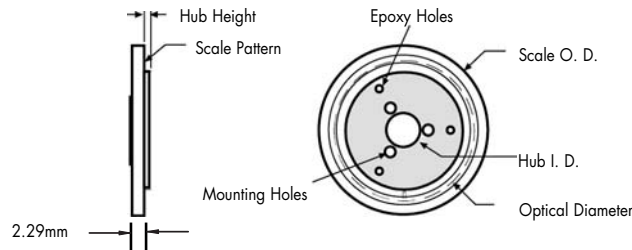

Dimensions in mm

Model No.	Fundamental CPR	Scale Outer Diameter	Scale Inner Diameter	Optical Diameter	Hub Inner Diameter +0.013mm/-0.0000	Hub Height
MIIR4513	5000	44.45mm	12.70mm	31.83mm	6.358mm	1.27mm
MIIR6425	8192	63.50mm	25.40mm	52.15mm	12.708mm	1.52mm
MIIR12151	16384	120.65mm	50.80mm	104.30mm	25.408mm	2.03mm

Custom scales are available including larger diameters

How to Order Mercury II™ 6000V Encoder Systems

To specify your Mercury II encoder with the desired encoder model, level of interpolation, maximum output frequency, and limit logic, order the required quantities for each system model number below. Order scales and additional items using their model number. Call MicroE Systems' Rapid Customer Response team for more information at 781-266-5700.

MII6800V, A-quad-B Output, with Output Resolution from 5µm to 1.2nm

Example: MII6815V-AB-16384-1-1-0

<u>MII6815V</u>	—	<u>AB</u>	—	<u>Interpolation (Integer Steps)</u>	—	<u>Maximum Output Frequency</u>	—	<u>Limit Logic</u>	—	<u>Low Pass Filter Roll Off Frequency (kHz)</u>
MII6815V = 1.5m vacuum cable, 1.0m atmospheric cable		AB = A-quad-B output		4 = x4 5 = x5 ↓ 16384 = x16384		1 = 12.50 MHz 2 = 6.25 MHz 3 = 3.125 MHz 4 = 1.563 MHz 5 = 0.781 MHz 6 = 0.391 MHz 7 = 0.195 MHz 8 = 0.098 MHz 9 = 0.049 MHz 10 = 0.024 MHz		1 = active low (fail safe) 2 = active high		0 = off (full bandwidth) 1 = 1kHz 2 = 2kHz ↓ 100 = 100kHz

How to Order SmartPrecision Alignment Tool

Required for MII6000V setup. AC / DC Power Supply is included, 100-240 VAC / 50-60 Hz.

Example (Alignment Tool for MercuryII 6000V encoders, Europlug): ATMII5000-S-EU

<u>ATMII5000</u>	—	<u>Connector</u>	—	<u>Plug Type</u>
		S = 15-pin Std. D-sub		US = Power Supply with US Standard 2-prong plug EU = Power Supply with European Standard 2-prong plug

PurePrecision Linear Glass Scales

(Standard accuracy grade)

Example (350mm Linear Glass Scale): MII350

MIIxxxx Where xxxx = Glass Scale Length in mm (10mm - 1000mm)
 (High accuracy grade scales: consult MicroE Systems)

Note: Index mark location and limit mark lengths can be customer-specified. Contact MicroE Systems.

How to Order Mercury II™ Encoder Systems

PurePrecision Rotary Glass Scales

Example (44.45mm OD Rotary Glass Scale with Hub): MIIR4513-HI

<u>MIIRxxxx*</u>	-	<u>Hub</u>
MIIR4513		NH = Without Hub
MIIR6425		HI = for R4513
MIIR12151		HJ = for R6425
		HK = for R12151

*Custom versions are available

Note: rotary glass scales are shipped not mounted to hubs; hub mounting is available from MicroE Systems - contact us for information

Mercury II Encoders Are Fully RoHS-Compliant

Mercury II is fully compliant with European Directive 2002/95/EC (Restriction of use of Hazardous Substances, "RoHS"). A Document of Compliance is available upon request. "Mercury™" is a brand name of MicroE Systems; Mercury and Mercury II encoders do not contain any mercury metal.

All specifications are subject to change.