

Kollmorgen VLM Brushless Motor Selection Guide



KOLLMORGEN

Because Motion Matters™  **ELECTROMATE**

Toll Free Phone (877) SERV098
Toll Free Fax (877) SERV099
www.electromate.com
sales@electromate.com

Kollmorgen. Every solution comes from a real understanding of OEM challenges.

The ever-escalating demands of the marketplace mean increased pressure on OEMs at every turn. Time constraints. Demands for better performance. Having to think about the next-generation machine even before the current one is built. While expectations are enormous, budgets are not. Kollmorgen's innovative motion solutions and broad range of quality products help engineers not only overcome these challenges but also build truly differentiated machines.

Because motion matters, it's our focus. Motion can distinctly differentiate a machine and deliver a marketplace advantage by improving its performance. This translates to overall increased efficiency for your application. Perfectly deployed machine motion can make your customer's machine more reliable and efficient, enhance accuracy and improve operator safety. Motion also represents endless possibilities for innovation. We've always understood this potential, and thus have kept motion at our core, relentlessly developing products that offer precision control of speed, accuracy and position in machines that rely on complex motion.

K O L L M O R G E N

Removing the Barriers of Design, Sourcing, and Time

At Kollmorgen, we know that OEM engineers can achieve a lot more when obstacles aren't in the way. So, we knock them down in three important ways:

Integrating Standard and Custom Products

The optimal solution is often not clear-cut. Our application expertise allows us to modify standard products or develop totally custom solutions across our whole product portfolio so that designs can take flight.

Providing Motion Solutions, Not Just Components

As companies reduce their supplier base and have less engineering manpower, they need a total system supplier with a wide range of integrated solutions. Kollmorgen is in full response mode with complete solutions that combine programming software, engineering services and best-in-class motion components.

Global Footprint

With direct sales, engineering support, manufacturing facilities, and distributors across North America, Europe, Middle East, and Asia, we're close to OEMs worldwide. Our proximity helps speed delivery and lend support where and when they're needed.

Financial and Operational Stability

Kollmorgen is part of Danaher Corporation, our \$13B parent company. A key driver in the growth of all Danaher divisions is the Danaher Business System, which relies on the principle of "kaizen" – or continuous improvement. Using world-class tools, cross-disciplinary teams of exceptional people evaluate processes and develop plans that result in superior performance.

Table of Contents

- ▶ **AKD Servo Drive** 4
- ▶ **VLM Series Brushless Servomotor Benefits** 8
- ▶ **VLM2x Product Overview** 10
- ▶ **VLM2x Dimensional Data** 11
- ▶ **VLM2x Performance Data** 12
- ▶ **VLM2x Performance Curves** 13
- ▶ **VLM3x Product Overview** 14
- ▶ **VLM3x Dimensional Data** 15
- ▶ **VLM3x Performance Data** 16
- ▶ **VLM3x Performance Curves** 17
- ▶ **Bearing Fatigue and Shaft Loading** 18
- ▶ **Connector Options** 19
- ▶ **Model Nomenclature** 22
- ▶ **MOTIONEERING Application Engine** 23



AKD™ Servo Drive

Our AKD series is a complete range of Ethernet-based servo drives that are fast, feature-rich, flexible and integrate quickly and easily into any application.* AKD ensures plug-and-play commissioning for instant, seamless access to everything in your machine. And, no matter what your application demands, AKD offers industry-leading servo performance, communication options, and power levels, all in a smaller footprint.

This robust, technologically advanced family of drives delivers optimized performance when paired with our best-in-class components, producing higher quality results at greater speeds and more uptime.

* Patents pending.

K O L L M O R G E N

The Benefits of AKD Servo Drive

- Optimized Performance in Seconds
 - Auto-tuning is one of the best and fastest in the industry
 - Automatically adjusts all gains, including observers
 - Immediate and adaptive response to dynamic loads
 - Precise control of all motor types
 - Compensation for stiff and compliant transmission and couplings
- Greater Throughput and Accuracy
 - Up to 27-bit-resolution feedback yields unmatched precision and excellent repeatability
 - Very fast settling times result from a powerful dual processor system that executes industry-leading and patent pending servo algorithms with high resolution
 - Advanced servo techniques such as high-order observer and bi-quad filters yield industry-leading machine performance
 - Highest bandwidth torque-and-velocity loops. Fastest digital current loop in the market
- Easy-to-Use Graphical User Interface (GUI) for Faster Commissioning and Troubleshooting
 - Six-channel real-time software oscilloscope commissions and diagnoses quickly
 - Multi-function Bode Plot allows users to quickly evaluate performance
 - Auto-complete of programmable commands saves looking up parameter names
 - One-click capture and sharing of program plots and parameter settings allow you to send machine performance data instantly
 - Widest range of programming options in the industry
- Flexible and Scalable to Meet Any Application
 - 3 to 96 Arms continuous current; 9 to 192 Arms peak
 - Very high power density enables an extremely small package
 - True plug-and-play with all standard Kollmorgen servomotors and positioners
 - Supports a variety of single and multi-turn feedback devices—Smart Feedback Device (SFD), EnDat2.2, 01, BiSS, analog Sine/Cos encoder, incremental encoder, HIPERFACE®, and resolver
 - Tightly integrated Ethernet motion buses without the need to add large hardware: EtherCAT®, SynqNet®, Modbus/TCP, and CANopen®
 - Scalable programmability from base torque-and-velocity through multi-axis master

AKD Servo Drive

The AKD servo drive delivers cutting-edge technology and performance with one of the most compact footprints in the industry. These feature-rich drives provide a solution for nearly any application, from basic torque-and-velocity applications, to indexing, to multi-axis programmable motion with embedded Kollmorgen Automation Suite. The versatile AKD sets the standard for power density and performance.



Micron™ Gearheads



AKM™ Servomotors



Cartridge Direct Drive Rotary™ Motors



Housed Direct Drive Rotary Motors



Direct Drive Linear Motors*

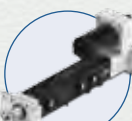

Linear Positioners



Multi-Axis Precision Tables

Best-in-Class Components

AKD works seamlessly with Kollmorgen motors and positioners - well-known for quality, reliability, and performance.



AKD™ Servo Drive



Industry-leading power density

General Specifications

120 / 240 Vac 1 & 3Ø (85 -265 V)	Continuous Current (Arms)	Peak Current (Arms)	Drive Continuous Output Power Capacity (Watts)	Internal Regen (Watts) (Ohms)		Height mm (in)	Width mm (in)	Depth mm (in)	Depth with Cable Bend Radius mm (in)
AKD-■00306	3	9	1100	0	0	168 (6.61)	57 (2.24)	153 (6.02)	184 (7.24)
AKD-■00606	6	18	2000	0	0	168 (6.61)	57 (2.24)	153 (6.02)	184 (7.24)
AKD-■01206	12	30	4000	100	15	195 (7.68)	76 (2.99)	186 (7.32)	215 (8.46)
AKD-■02406	24	48	8000	200	8	250 (9.84)	100 (3.94)	230 (9.06)	265 (10.43)
480 Vac 3Ø (342 -528 V)	Continuous Current (Arms)	Peak Current (Arms)	Drive Continuous Output Power Capacity (Watts)	Internal Regen (Watts) (Ohms)		Height mm (in)	Width mm (in)	Depth mm (in)	Depth with Cable Bend Radius mm (in)
AKD-■00307	3	9	2000	100	33	256 (10.08)	70 (2.76)	186 (7.32)	221 (8.70)
AKD-■00607	6	18	4000	100	33	256 (10.08)	70 (2.76)	186 (7.32)	221 (8.70)
AKD-■01207	12	30	8000	100	33	256 (10.08)	70 (2.76)	186 (7.32)	221 (8.70)
AKD-■02407	24	48	16,000	200	23	310 (12.20)	105 (4.13)	229 (9.02)	264 (10.39)
AKD-■04807	48	96	32,000	400		<i>Coming Soon</i>			
AKD-■09607	96	192	64,000	800		<i>Coming Soon</i>			

VLM Series Brushless Servomotor

The new VLM family of servomotors is designed for superior Torque-per-dollar for those customers looking for a low cost motor with optimal performance.

With a design targeted for the most common servomotor features and offering torque ranges from 0.5Nm to almost 16Nm, VLM is able to deliver all the torque and performance of a servo while helping customers control their application costs.

VLM is available in both NEMA (23, 34) and Metric (60, 90mm) mounting standards with multiple shaft configurations for seamless integration into any system. Similarly, multiple feedback and cable options give customers flexibility in their system configuration without adding significant cost.

The Benefits of VLM Brushless Servomotors

- Exceptional Quality and Value
 - High torque per dollar
 - Quality components
 - No need for intermediate cables
 - Low cost feedback options standard
 - Low cost design
- Standard Configurations To Fit Most Applications
 - VLM offers 6 of the most popular size motors with 12 standard windings
 - NEMA and Metric standard mounts
 - S200, AKD, Flying Leads and Molex Connector options standard
 - Good match for dynamic loads
- Ease of Use
 - Standard connector options and matching cables

VLM2x Product Overview

- NEMA 23 or 60 mm metric
- 120/240 Vac, 160-320 Vdc
- Rated speeds to 6,000 RPM
- Up to 4.2 N-m peak
- Up to 1.2 N-m continuous
- CE, UL, cUL pending
- RoHs compliant
- IP40 protection
- 1m and 3m lead lengths available
- Neodymium iron-boron magnets for maximum torque
- Standard cabling option for direct connection to S200 (Hall feedback)
- Standard cabling option for direct connection to AKD (Resolver or Encoder feedback)



VLM2x Dimensional Data

VLM2x Family Dimensional Data – Up to 320 Vdc

Shaft Mount Option	Units	"A" Shaft Diameter	"B" Shaft Length	"C" Pilot Diameter	"D" Mtg Hole	"E" Mtg Hole Diameter	"R" Key Width	"S" Key Length	"T" Shaft Diameter Over Key	Shaft Feature
A (Metric)	mm	11 ⁰ _{-0.011}	28.5	36 ⁰ _{-0.025}	70.7	4.5	4 ⁰ _{-0.03}	18 ⁰ _{-0.20}	12.5 ⁰ _{0.13}	Key 4 x 4 x 18
B (NEMA)	inch	.3750 ^{+0.0000} _{-0.0005}	0.81	1.500 ^{+0.000} _{-0.002}	2.625	.200	-	-	-	Smooth
C (Metric)	mm	14 ⁰ _{-0.011}	30	50 ⁰ _{-0.025}	70	5.5	5 ⁰ _{-0.03}	20 ⁰ _{-0.20}	16 ⁰ _{-0.13}	Key 5 x 5 x 20
D (NEMA)	inch	.2500 ^{+0.0000} _{-0.0005}	0.81	1.500 ^{+0.000} _{-0.002}	2.625	.200	-	-	-	Smooth
E (Metric)	mm	11 ⁰ _{-0.011}	28.5	36 ⁰ _{-0.025}	70.7	4.5	-	-	-	Smooth
F (NEMA)	inch	.3750 ^{+0.0000} _{-0.0005}	0.81	1.500 ^{+0.000} _{-0.002}	2.625	.200	-	-	-	Flat
G (Metric)	mm	14 ⁰ _{-0.011}	30	50 ⁰ _{-0.025}	70	5.5	-	-	-	Smooth

MODEL	Units	"X"	Z MAX
VLM21	mm	78.2	102.40
	inch	3.1	4.03
VLM22	mm	103.6	127.80
	inch	4.1	5.03
VLM23	mm	129.0	153.20
	inch	5.1	6.03

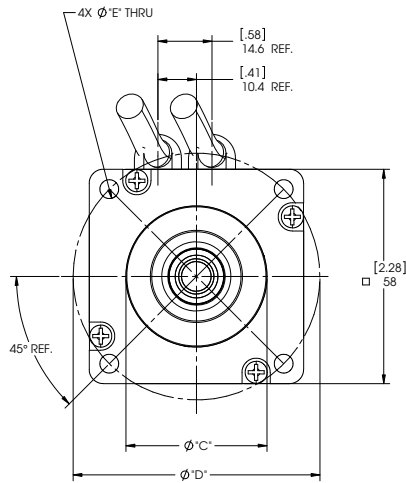

FLAT DETAIL

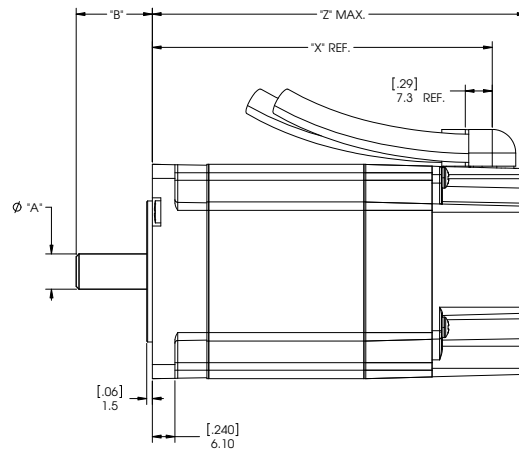

KEYWAY DETAIL

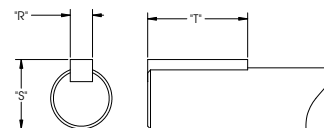
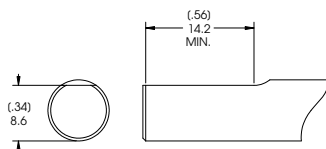

VLM2x Performance Data

VLM2x Family Performance Data – Up to 320 Vdc

VLM2x Family Performance Data – Up to 320 Vdc				VLM21		VLM22		VLM23	
Parameters	Tol	Symbol	Units	C	E	C	E	D	G
Max Rated DC Bus Voltage	Max	V _{bus}	Vdc	320	160	320	160	320	160
Continuous Torque (Stall) for ΔT winding = 100°C ①②	Nom	T _{cs}	N-m	0.48	0.47	0.81	0.83	1.18	1.18
			lb-in	4.2	4.2	7.2	7.3	10.4	10.4
Continuous Current (Stall) for ΔT winding = 100°C ①②	Nom	I _{cs}	A _{rms}	1.49	2.99	1.69	3.34	2.45	4.91
Max Mechanical Speed ③	Nom	N _{max}	rpm	6000	6000	6000	6000	6000	6000
Peak Torque ①②	Nom	T _p	N-m	1.66	1.65	2.91	2.94	4.2	4.2
			lb-in	14.7	14.6	25.8	26.0	37.2	37.2
Peak Current	Nom	I _p	A _{rms}	6	12	6.8	13.3	9.8	19.6
Rated Torque (speed) ①②		T _{rtd}	N-m	-	0.44	-	0.73	-	1.0
			lb-in	-	3.9	-	6.5	-	8.9
Rated Speed		N _{rtd}	rpm	-	3000	-	2000	-	2500
Rated Power (speed) ①②		P _{rtd}	kW	-	0.14	-	0.15	-	0.26
			Hp	-	0.19	-	0.21	-	0.35
Rated Torque (speed) ①②		T _{rtd}	N-m	0.44	0.41	0.69	0.52	0.94	0.6
			lb-in	3.9	3.6	6.1	4.6	8.3	5.3
Rated Speed		N _{rtd}	rpm	3500	6000	2500	6000	3000	6000
Rated Power (speed) ①②		P _{rtd}	kW	0.16	0.26	0.18	0.33	0.30	0.38
			Hp	0.22	0.35	0.24	0.44	0.40	0.51
Rated Torque (speed) ①②		T _{rtd}	N-m	0.41	-	0.51	-	0.6	-
			lb-in	3.6	-	4.5	-	5.3	-
Rated Speed		N _{rtd}	rpm	6000	-	6000	-	6000	-
Rated Power (speed) ①②		P _{rtd}	kW	0.26	-	0.32	-	0.38	-
			Hp	0.35	-	0.43	-	0.51	-
Torque Constant ①	±10%	K _t	N-m/A _{rms}	0.32	0.16	0.48	0.25	0.48	0.24
			lb-in/A _{rms}	2.8	1.4	4.2	2.2	4.2	2.1
Back EMF Constant ①	±10%	K _e	V/krpm	20.8	10.4	31.2	16.1	31.2	15.6
Resistance (line-line) ①	±10%	R _m	ohm	10.4	2.6	8.8	2.3	4.7	1.2
Inductance (line-line)		L	mH	12.1	3.0	12.1	3.2	7.7	1.9
Inertia (includes Resolver feedback)		J _m	kg-cm ²	0.429		0.633		0.819	
			lb-in-s ²	3.80E-04		5.60E-04		7.25E-04	
Weight		W	kg			1.9		2.3	
			lb			4.2		5.1	
Static Friction ①		T _f	N-m	0.008		0.01		0.025	
			lb-in	0.07		0.09		0.22	
Viscous Damping ①		K _{dv}	N-m/krpm	0.003		0.006		0.009	
			lb-in/krpm	0.03		0.05		0.08	
Thermal Time Constant		TCT	minutes	7.5		12.5		17.5	
Thermal Resistance		R _{thw-a}	°C/W	2.4		2		1.8	
Pole Pairs				3		3		3	
Heat Sink Size				10"x10"x1/4" Aluminum Plate		10"x10"x1/4" Aluminum Plate		10"x10"x1/4" Aluminum Plate	

Notes: ① Motor winding temperature rise, ΔT = 100°C, at 40°C ambient.

③ May be limited at some values of V_{bus}.

② All data referenced to sinusoidal commutation.

④ Measured at 25°C.

VLM2x Performance Curves

160 Vdc Windings

320 Vdc Windings

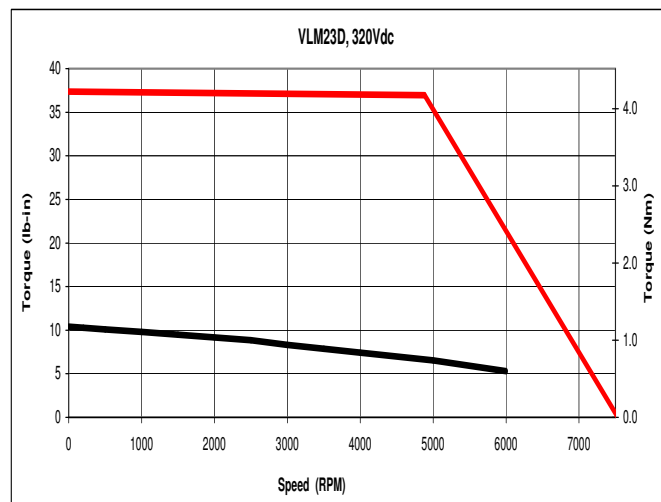
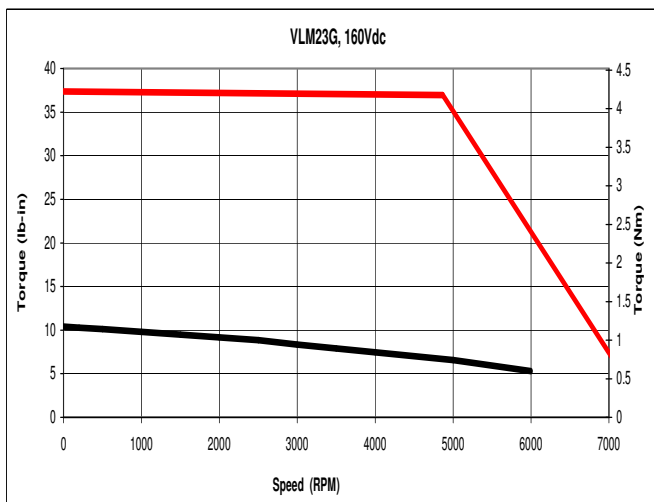
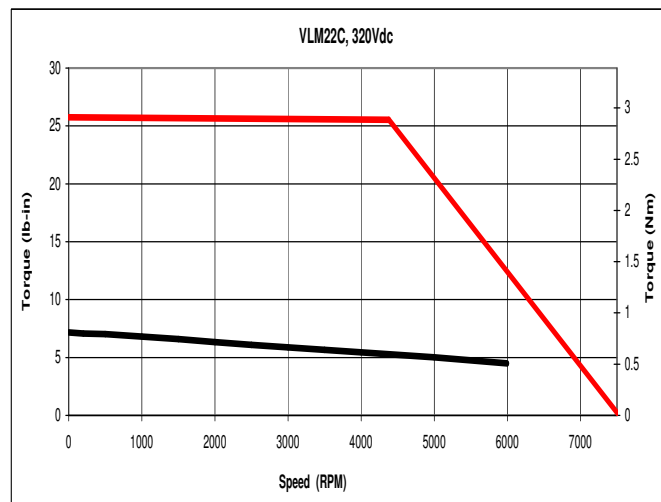
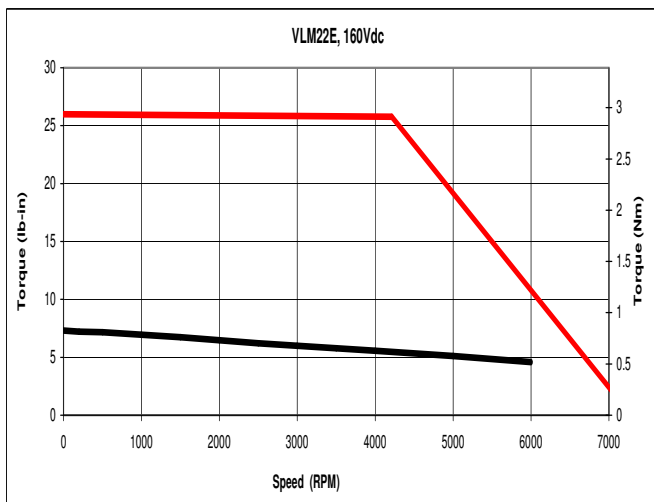
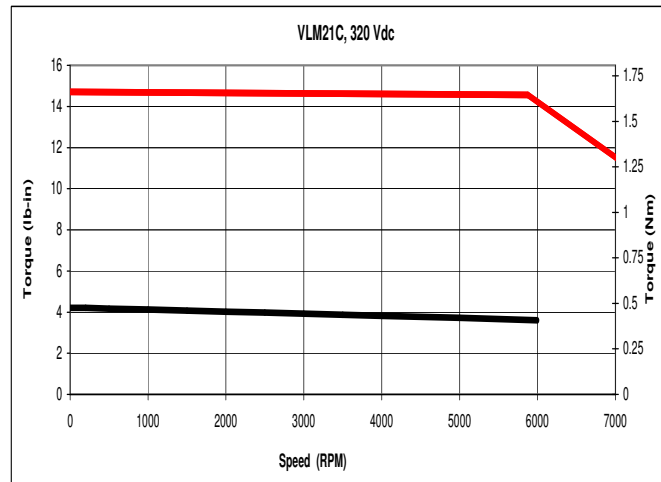
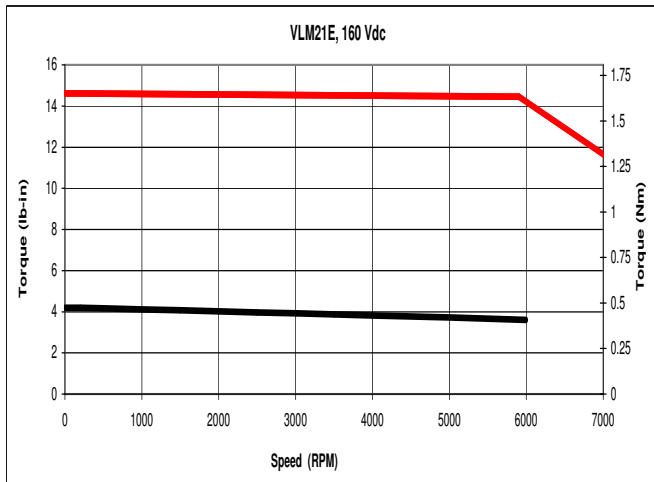

- █ - Continuous Performance
- █ - Peak Performance

VLM3x Product Overview

- NEMA 34 or 90 mm metric
- 120/240 Vac, 160-320 Vdc
- Rated speeds to 6,000 RPM
- Up to 15.9 N-m peak
- Up to 4.5 N-m continuous
- CE, UL, cUL pending
- RoHs compliant
- IP40 protection
- 1m and 3m lead lengths available
- Neodymium iron-boron magnets for maximum torque
- Standard cabling option for direct connection to S200 (Hall feedback)
- Standard cabling option for direct connection to AKD (Resolver or Encoder feedback)



VLM3x Dimensional Data

VLM3x Family Dimensional Data – Up to 320 Vdc

Shaft Mount	Units	"A" Shaft Diameter	"B" Shaft Length	"C" Pilot Diameter	"D" Mtg Hole	"E" Mtg Hole Diameter	"R" Key Width	"S" Key Length	"T" Shaft Diameter Over Key	Shaft Feature	
A (Metric)	mm	14 ⁰ _{-0.011}	30	80	+0.012 -0.007	100	7	5 ⁰ _{-0.03}	20 ⁰ _{-0.20}	16 ⁰ _{-0.13}	Key 5 x 5 x 20
B (NEMA)	inch	.5000 ^{+0.0000} _{-0.0005}	1.25	2.875	+0.000 -0.002	3.875	.218	.125 ^{+0.000} _{-0.002}	.750 +/- .010	.555 ^{+0.000} _{-0.017}	Key 1/8 x 1/8 x 3/4
C (Metric)	mm	14 ⁰ _{-0.011}	30	80	+0.012 -0.007	100	7	-	-	-	Smooth
D (NEMA)	inch	.5000 ^{+0.0000} _{-0.0005}	1.25	2.875	+0.000 -0.002	3.875	.218	-	-	-	Smooth

MODEL	Units	"X"	Z MAX
VLM31	mm	89.4	110.50
	inch	3.5	4.35
VLM32	mm	127.5	148.60
	inch	5.0	5.85
VLM33	mm	165.6	186.70
	inch	6.5	7.35

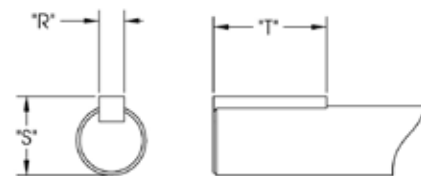
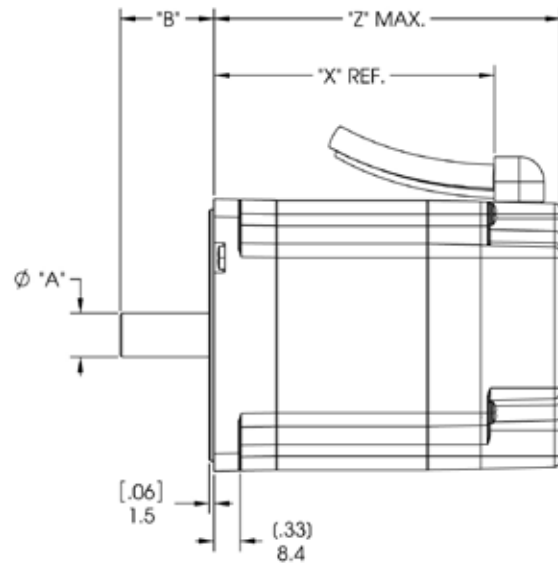
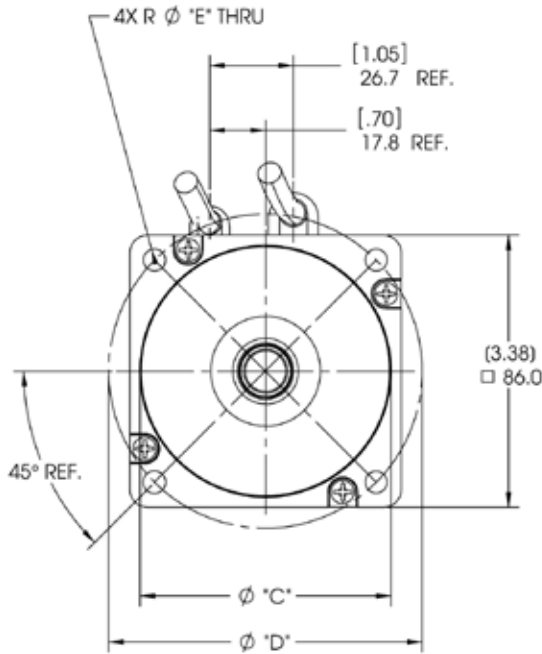

VLM3x Performance Data

VLM3x Family Performance Data – Up to 320 Vdc

Parameters	Tol	Symbol	Units	VLM31		VLM32		VLM33	
				E	H	H	J	J	
Max Rated DC Bus Voltage	Max	V _{bus}	Vdc	320	160	320	160	320	
Continuous Torque (Stall) for ΔT winding = 100°C ①②	Nom	T _{cs}	N-m	1.96	1.95	3.55	3.51	4.53	
			lb-in	17.3	17.3	31.4	31.1	40.1	
Continuous Current (Stall) for ΔT winding = 100°C ①②	Nom	I _{cs}	A _{rms}	2.84	5.72	5.26	8.43	7.23	
Max Mechanical Speed ③	Nom	N _{max}	rpm	6000	6000	6000	6000	6000	
Peak Torque ①②	Nom	T _p	N-m	6.4	6.4	12.0	11.9	15.9	
			lb-in	56.6	56.6	106.2	105.3	140.7	
Peak Current	Nom	I _p	A _{rms}	11.3	22.9	21.1	33.7	28.9	
75 Vdc		T _{rtd}	N-m	-	1.82	-	3.32	-	
			lb-in	-	16.1	-	29.4	-	
			N _{rtd}	rpm	-	1750	-	1500	-
Rated Power (speed) ①②		P _{rtd}	kW	-	0.33	-	0.52	-	
			Hp	-	0.45	-	0.70	-	
160 Vdc		T _{rtd}	N-m	1.8	1.62	3.26	3.0	3.93	
			lb-in	15.9	14.3	28.9	26.6	34.8	
		N _{rtd}	rpm	2000	4000	2000	3500	2250	
		Rated Power (speed) ①②	P _{rtd}	kW	0.38	0.68	0.68	1.10	0.93
Hp	0.51			0.91	0.92	1.47	1.24		
320 Vdc		T _{rtd}	N-m	1.63	-	2.86	-	2.37	
			lb-in	14.4	-	25.3	-	21.0	
		N _{rtd}	rpm	4000	-	4500	-	5000	
		Rated Power (speed) ①②	P _{rtd}	kW	0.68	-	1.35	-	1.24
				Hp	0.92	-	1.81	-	1.66
Torque Constant ①	±10%	K _t	N-m/A _{rms} lb-in/A _{rms}	0.71 6.3	0.35 3.1	0.70 6.2	0.43 3.8	0.65 5.8	
Back EMF Constant ①	±10%	K _e	V/krpm	45.9	22.6	45.2	27.9	41.9	
Resistance (line-line) ①	±10%	R _m	ohm	4.3	1.1	1.6	0.7	0.85	
Inductance (line-line)		L	mH	11.7	2.8	5.0	1.9	2.7	
Inertia (includes Resolver feedback)		J _m	kg-cm ²	1.79		3.37		4.84	
			lb-in-s ²	1.58E-03		2.98E-03		4.28E-05	
Weight		W	kg	3		4.7		6.3	
			lb	6.6		10.4		13.9	
Static Friction ①		T _f	N-m	0.06		0.15		0.17	
			lb-in	0.53		1.33		1.50	
Viscous Damping ①		K _{dv}	N-m/krpm	0.016		0.039		0.047	
			lb-in/krpm	0.14		0.35		0.42	
Thermal Time Constant		TCT	minutes	10.5		20.5		26	
Thermal Resistance		R _{thw-a}	°C/W	1.6		1.2		0.96	
Pole Pairs				3		3		3	
Heat Sink Size				10"x10"x1/4" Aluminum Plate		10"x10"x1/4" Aluminum Plate		10"x10"x1/4" Aluminum Plate	

Notes: ① Motor winding temperature rise, ΔT = 100°C, at 40°C ambient.
③ May be limited at some values of V_{bus}.

② All data referenced to sinusoidal commutation.
④ Measured at 25°C.

VLM3x Performance Curves

160 Vdc Windings

320 Vdc Windings

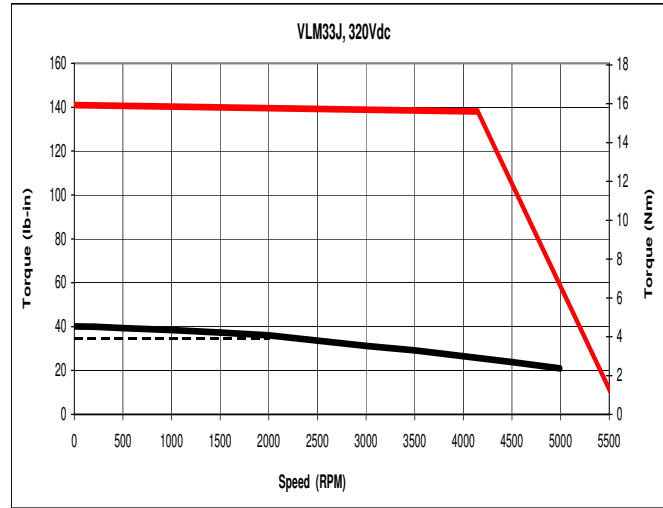
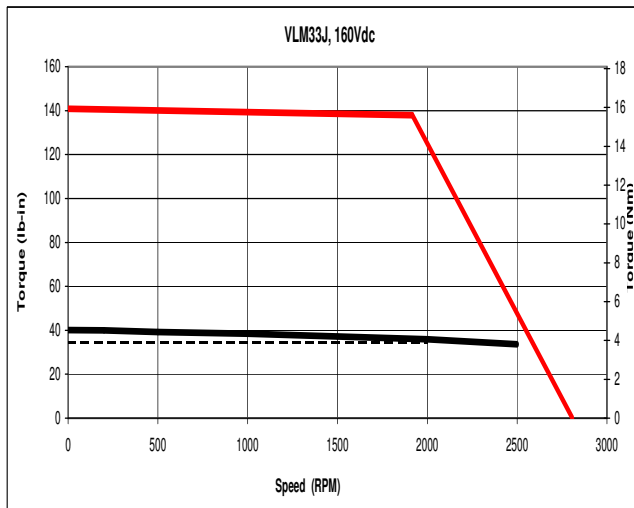
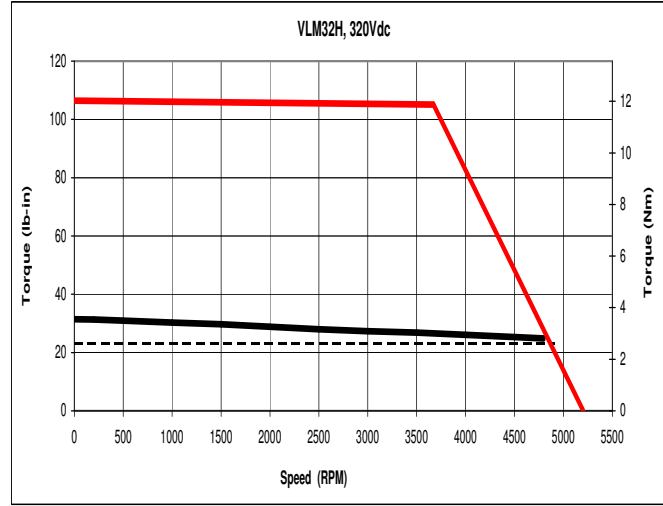
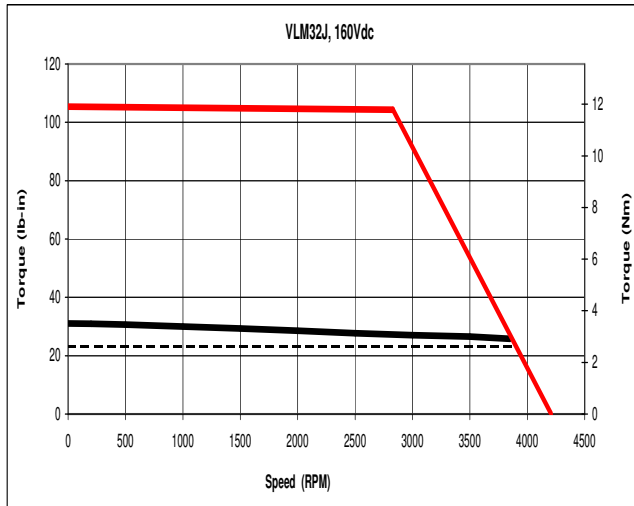
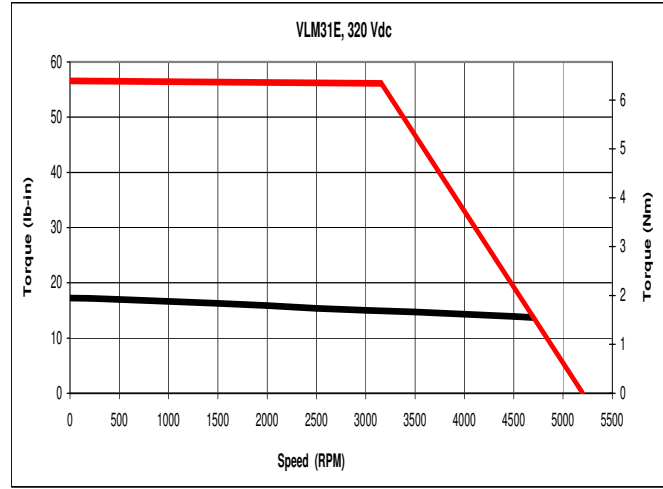
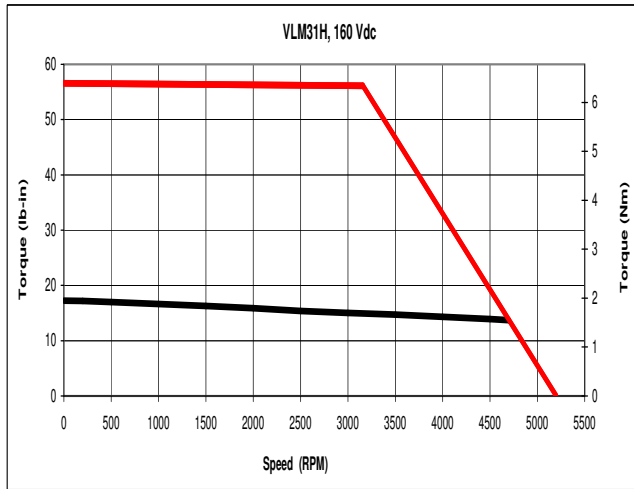

- - Continuous Performance w/Molex Connectors
- - Continuous Performance
- - Peak Performance

Bearing Fatigue and Shaft Loading

VLM2 Motors
20000 HOURS BEARING LIFE

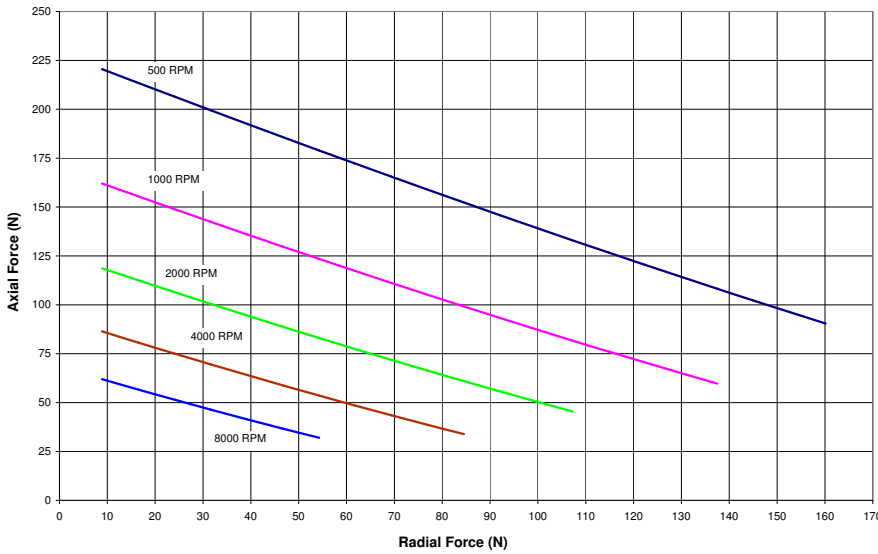

Shaft Loading

Motor	Max. Radial Force (N)	Max. Axial Force (N)
VLM2	150*	260
VLM3	280	1330

*VLM2 with "D" Shaft/Mount option is limited to 50N due to .25 inch diameter shaft.

The maximum radial load ratings reflect the following assumptions:

1. Motors are operated with peak torque of the longest member of the frame size.
2. Fully reversed load applied to the end of the smallest diameter standard mounting shaft extension.
3. Infinite life with 99% reliability.
4. Safety factor = 2.

VLM3 Motors
20000 HOURS BEARING LIFE

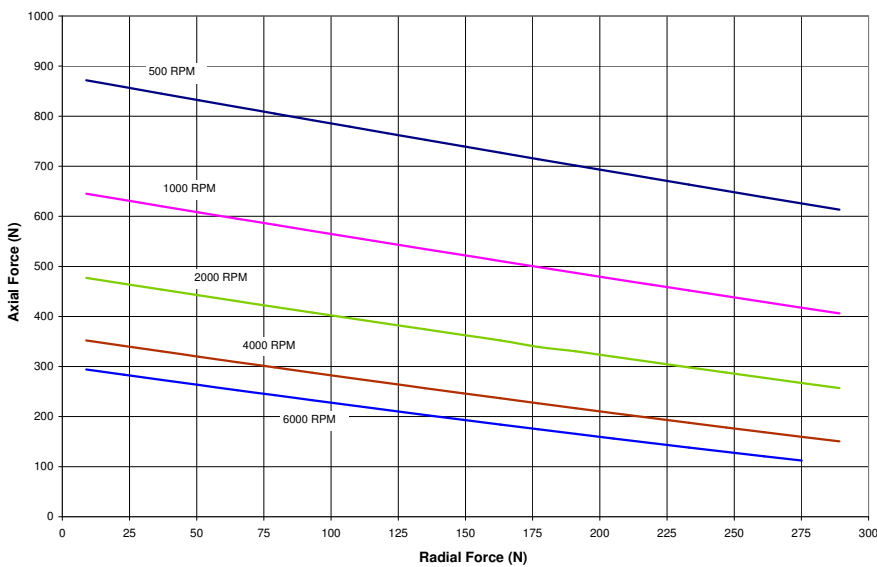

Connector Options

“M” Connector Option

Power Connector

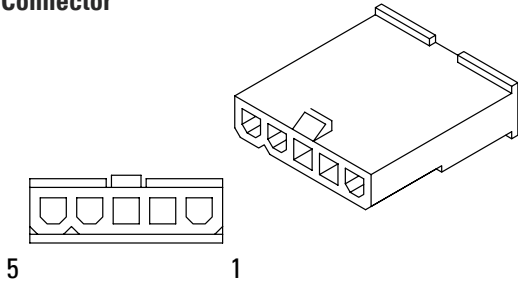

Connector Part Number: Molex 39-01-4056 (Eng No. 5559-05P3)

Pin	Function	Color
1	Phase U	Blue
2	Phase V	Brown
3	Phase W	Violet
4	Ground	Green/Yellow
5	Shield	

Shield Connected to Motor
Ground Internal to Motor

Suggested Mating Connector

Molex 39-01-4050

Halls Feedback

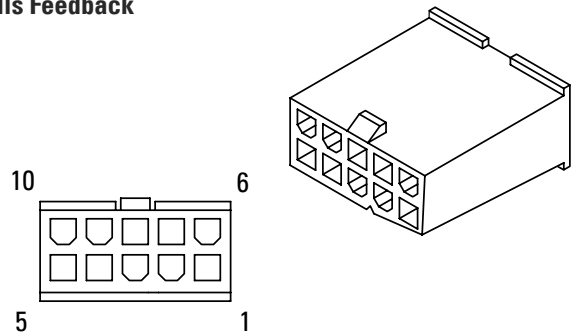

Connector Part Number: Molex 43020-1001

Pin	Function	Color
1	+5 Vdc	Red
2	Ground	Black
3		
4		
5	Shield	
6	Thermal+	Grey
7	Thermal-	Violet
8	Hall U	Green
9	Hall V	Brown
10	Hall W	White

Shield Connected to Motor
Ground Internal to Motor

Suggested Mating Connector

Molex 43025-1000

Encoder Feedback

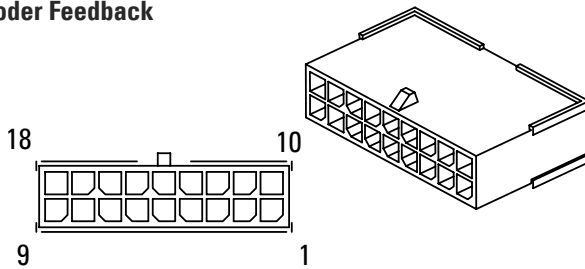

Connector Part Number: Molex 43020-1801

Pin	Function	Color
1	B+	Blue
2	B-	Blue/White
3	A+	Yellow
4	A-	Yellow/White
5	Z+	Orange
6	Z-	Orange/White
7	Ground	Black
8	Thermal+	Grey
9	Thermal-	Violet
10	+5 Vdc	Red
11		
12		
13		
14	Hall Ground	Green/White
15	Hall U	Green
16	Hall V	Brown
17	Hall W	White
18	Shield	

Shield is Not Connected at Motor End

Suggested Mating Connector

Molex 43025-1800

Resolver Feedback

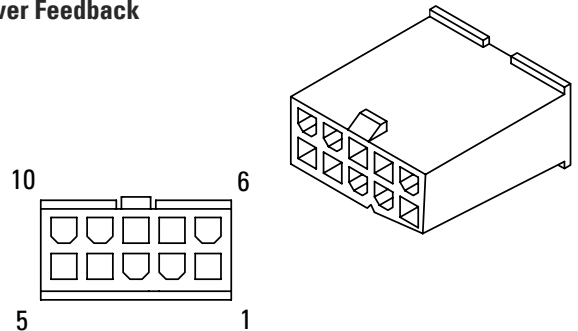

Connector Part Number: Molex 43020-1001

Pin	Function	Color
1		
2	Thermal+	Grey
3	S4 COS-	Blue
4	S3 SIN-	Black
5	Reference	Black/White
6	Thermal-	Violet
7	S2 COS+	Yellow
8	S1 SIN+	Red
9	Reference+	Red/White
10	Shield	

Shield is Not Connected at Motor End

Suggested Mating Connector

Molex 43025-1000

Connector Options

"L" Flying Lead Option (No connectors)

Power Leads

Unterminated Shielded Cable

Function	Color
Phase U	Blue
Phase V	Brown
Phase W	Violet
Ground	Green/Yellow
Shield	

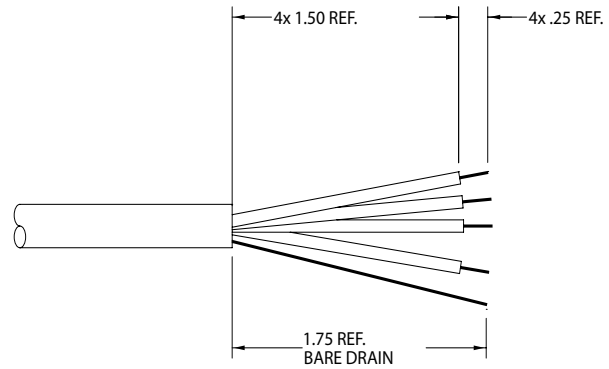

POWER CABLE

VLM2 22 AWG
VLM3 18 AWG

Encoder Feedback

Unterminated Shielded Cable

Function	Color
A+	Yellow
A-	Yellow/White
B+	Blue
B-	Blue/White
Z+	Orange
Z-	Orange/White
Thermal+	Grey
Thermal-	Violet
+5 Vdc	Red
Ground	Black
Hall Ground	Green/White
Hall U	Green
Hall V	Brown
Hall W	White
Shield	

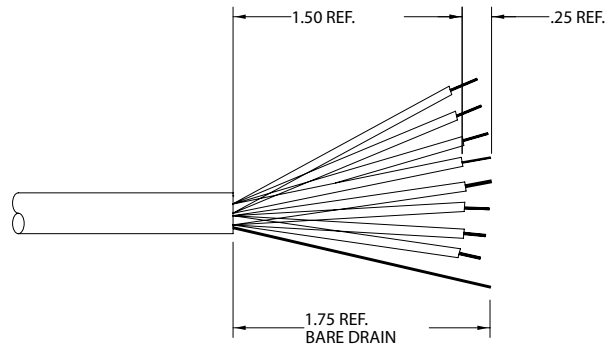

FEEDBACK CABLES

28 AWG
NUMBER OF CONDUCTORS
WILL VARY DEPENDING
ON FEEDBACK TYPE.

Hall Feedback

Unterminated Shielded Cable

Function	Color
+5 Vdc	Red
Ground	Black
Hall U	Green
Hall V	Brown
Hall W	White
Thermal+	Grey
Thermal-	Violet
Shield	

Resolver Feedback

Unterminated Shielded Cable

Function	Color
S1 SIN+	Red
S2 COS+	Yellow
S4 COS-	Blue
S3 SIN-	Black
Reference-	Black/White
Reference+	Red/White
Thermal+	Grey
Thermal-	Violet
Shield	

Connector Options

"F" Connector Option

(For Direct Connection To S200-VTS)

Power Leads

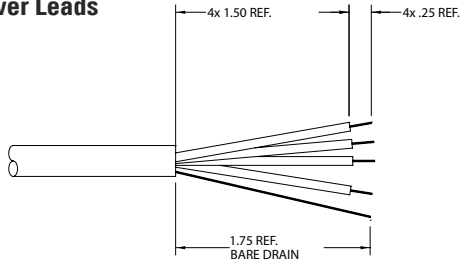

POWER CABLE
VLM2 22 AWG
VLM3 18 AWG

Unterminated Shielded Cable

Function	Color
Phase U	Blue
Phase V	Brown
Phase W	Violet
Ground	Green/Yellow
Shield	

Halls Feedback

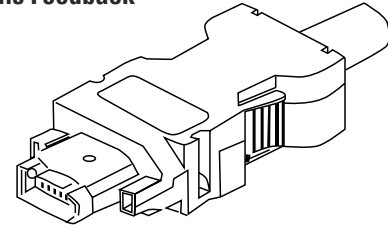

Connector Part Number: Molex 55100-0670

Pin	Function	Color
1		Red
2		Black
3		
4	Hall U	Green
5	Hall V	Brown
6	Hall W	White
	Thermal+	Grey
	Thermal-	Violet

"K" Connector Option

Power Leads

(For Direct Connection To AKD)

Unterminated Shielded Cable

Function	Color
Phase U	Blue
Phase V	Brown
Phase W	Violet
Ground	Green/Yellow
Shield	

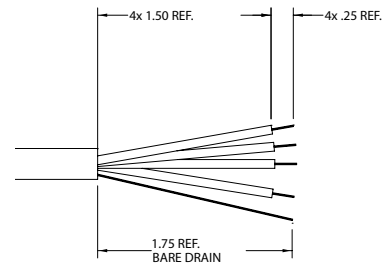

POWER CABLE
VLM2 22 AWG
VLM3 18 AWG

Resolver Feedback

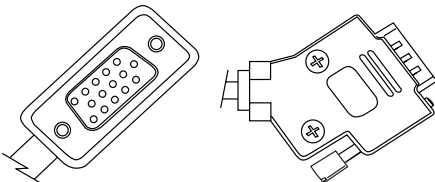

Connector Part Number: 15 PIN HD D-SUB

Pin	Function	Color
1		
2		
3		
4		
5		
6	Reference+	Red/White
7	Reference-	Black/White
8	Thermal+	Grey
9	Thermal-	Violet
10		
11		
12	S1 SIN+	Red
13	S3 SIN-	Black
14	S2 COS+	Yellow
15	S4 COS-	Blue

Encoder Feedback

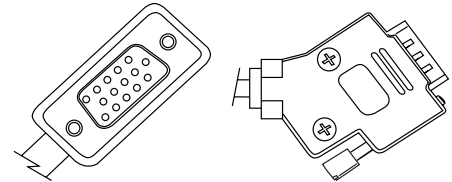

Connector Part Number: 15 PIN HD D-SUB

Pin	Function	Color
1	Hall U	Green
2	Hall V	Brown
3	Hall W	White
4		
5		
6	Z+	Orange
7	Z-	Orange/White
8	Thermal+	Grey
9	Thermal-	Violet
10	+5 Vdc	Red
11	Ground	Black & Green/White
12	A+	Yellow
13	A-	Yellow/White
14	B+	Blue
15	B-	Blue/White

Model Nomenclature

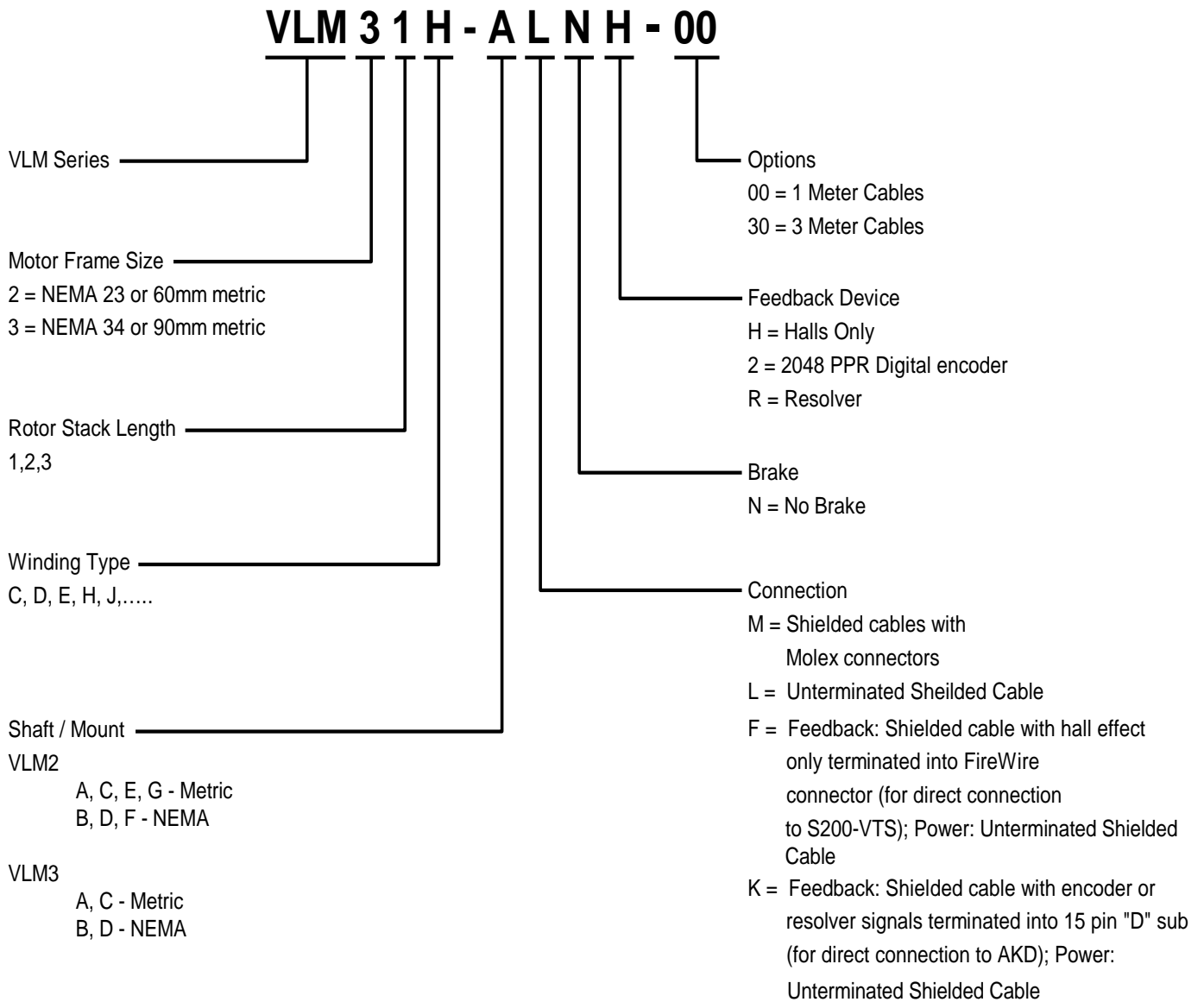

The VLM is one family of many servo motors offered by Kollmorgen. If you seek higher-performance, greater torque in a smaller package, or options not listed above, contact Kollmorgen to discuss the AKM and GoldLine servo motor families.