

ROBO NET



■ Model :RGW-□/RACON/RPCON/RABU/REXT

For RCA2/RCA/RCL/RCP3/RCP2
Network Controller

ROBONET is a new type of control unit that freely operates ROBO Cylinders via a field network. They have less wiring and are more compact than past controllers, and by DIN rail mounting make it possible to vastly reduce wiring and installation labor.

Features

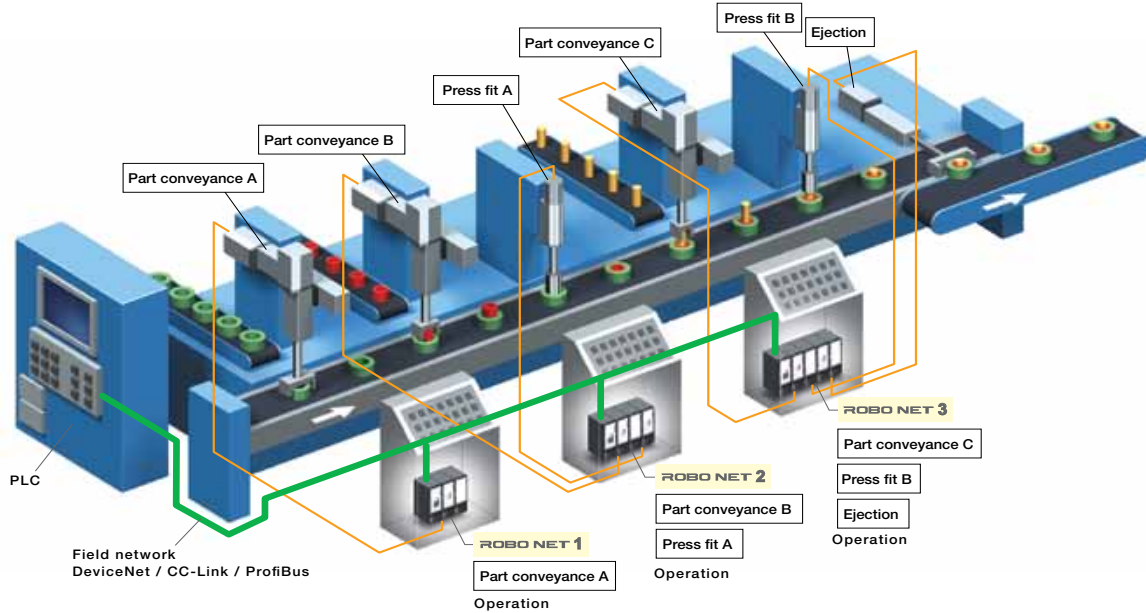

1 Reduced Wiring

By connecting each line of the I/O cables to lines wired to the PLC terminals with the field network, wiring processing is completed with one dedicated cable. Also, since the unit can be coupled by just connecting with the unit connection board, the controller wiring work is greatly simplified.

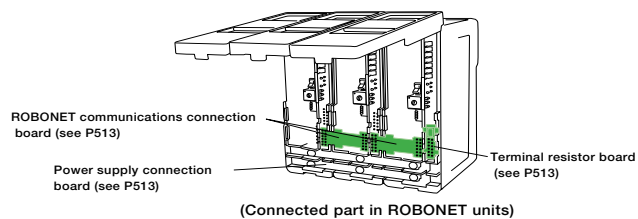
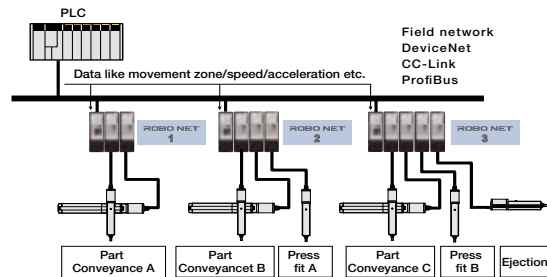

503 ROBONET

- Slider Type
- Mini
- Standard
- Controllers Integrated
- Rod Type
- Mini
- Standard
- Controllers Integrated
- Table/Arm /Flat Type
- Mini
- Standard
- Gripper/ Rotary Type
- Linear Servo Type
- Cleanroom Type
- Splash-Proof
- Controllers
- PMEC /AMEC
- PSEP /ASEP
- ROBO NET
- ERC2
- PCON
- ACON
- SCON
- PSEL
- ASEL
- SSEL
- XSEL
- Pulse Motor
- Servo Motor (24V)
- Servo Motor (200V)
- Linear Servo Motor

2 The robot can be moved by directly specifying numeric values for the move position/velocity/acceleration and other data.

Besides the conventional method of moving the robot to pre-taught positions it is also possible to operate the robot by sending information as a string of numeric data that contains position, velocity, acceleration, etc. values. This is effective for cases such as when the move position changes with each piece or when one wants to move the robot to an arbitrary position.

	ROBONET controller	Standard controller (ACON/PCON)
Movement by specifying positions	○	○
Movement by specifying direct values	○	△
Specifying speed/acceleration	○	(Not for PIO) (Connectable with serial communication)
Current value output	○	

*ROBONET operates through a field network, and the standard controller operates with PIO.

3 Ultra-compact

Each unit is an ultra-compact size of 34mm wide by 100mm high x 73mm deep. Also, since there is no base unit and the main unit is coupled with connectors, the controller takes up little space for installation even if there are many units.



4 Can operate with a maximum of 16 axes.

Up to 16 controllers can be connected to one communication unit (Gateway R unit). RACON units (controllers for RCA) and RPCON units (controllers for RCP2) can also be used together.

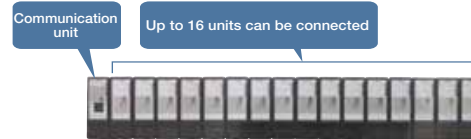

5 Controllers can be multiplexed.

Controllers can be multiplexed using an optional extension unit, so many axes can be connected even if there isn't much horizontal space.

Also, non-ROBONET controllers (SCON, PCON-CF, ERC2) can be connected to a ROBONET Gateway unit using the same extension unit.

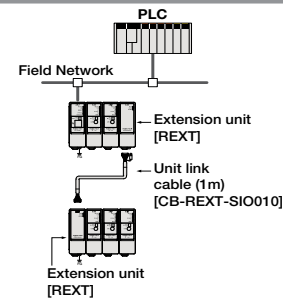

6 Simple absolute unit, when home return is not required

The simple absolute R unit allows operation for incremental specification axes without home return. Users can back up actuator encoder data even if the power is shut off, by installing a simple absolute R unit to a RACON unit (controller for RCA) or RPCON unit (controller for RCP2).



7 Mounting the DIN rail

The controller is installed with DIN rails, so it can be fastened and removed with one touch.

- Slider Type
- Mini
- Standard
- Controllers Integrated
- Rod Type
- Mini
- Standard
- Controllers Integrated
- Table/Arm/Flat Type
- Mini
- Standard
- Gripper/Rotary Type
- Linear Servo Type
- Cleanroom Type
- Splash-Proof
- Controllers
- PMEC/AMEC
- PSEP/ASEP
- ROBO NET
- ERC2
- PCON
- ACON
- SCON
- PSEL
- ASEL
- SSEL
- XSEL
- Pulse Motor
- Servo Motor (24V)
- Servo Motor (200V)
- Linear Servo Motor

System configuration

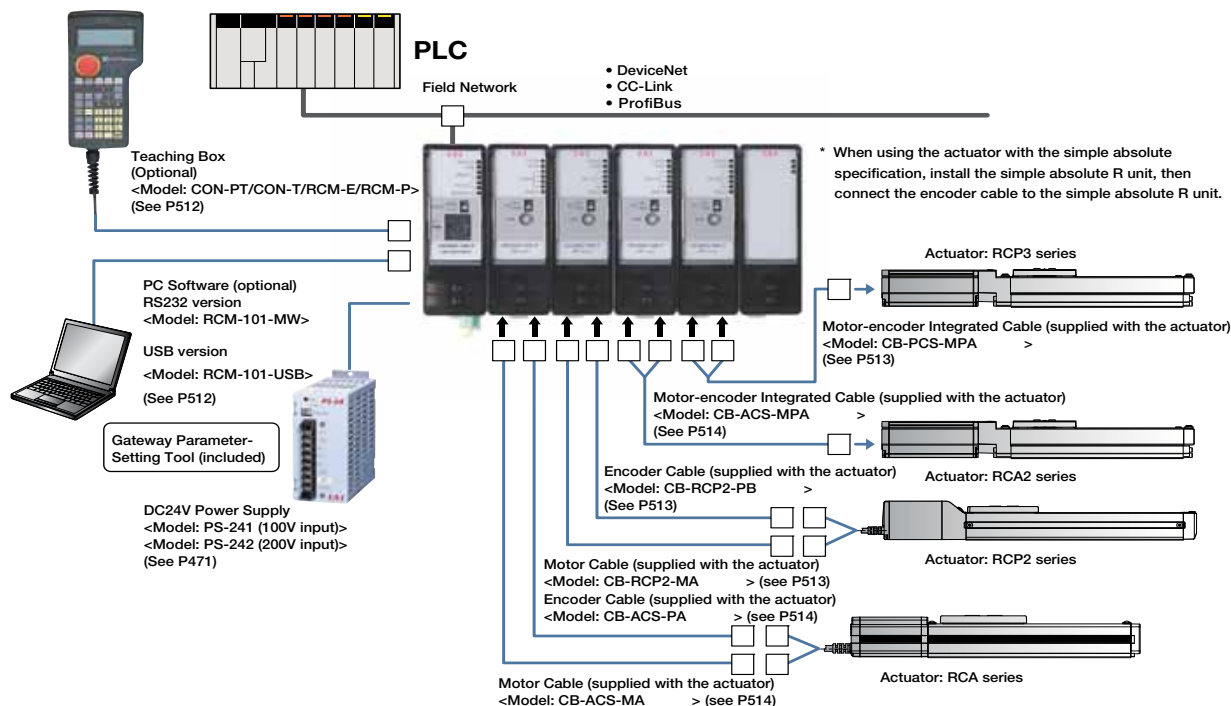

ROBONET Extension Unit

If multiple ROBONET extension units (optional) are linked together they can reduce the lateral width needed. It is also possible to connect individual controllers, such as SCON, etc. via the ROBONET.

[Unit Multiplex Set]

Model: REXT-SIO

(Set Contents)

ROBONET Extension Unit (Model: REXT) 2 pc
Unit Link Cable (Model: CB-REXT-SIO010) 1 pc

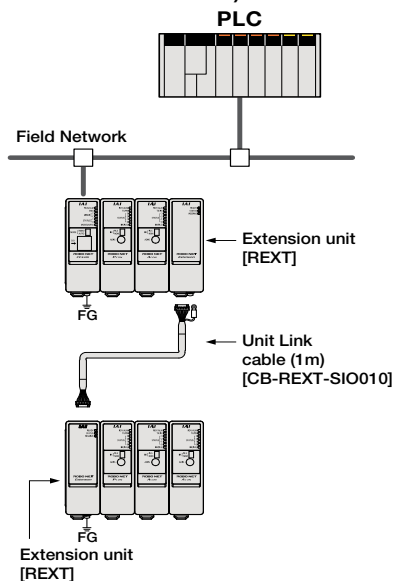

[Controller Connecting Set]

Model: REXT-CTL

(Set Contents)

ROBONET Extension Unit (Model: REXT) 1 pc
Controller Connection Cable (Model: CB-REXT-CTL010) 1 pc

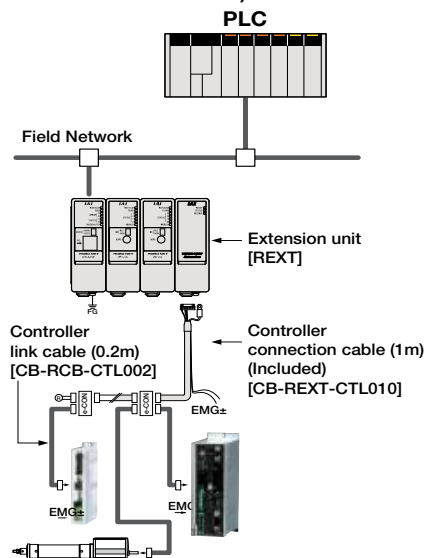

505

ROBONET

Configuration unit

Required ROBONET units are ordered individually, and assembled as you see fit. If actuators are added later, they can be easily added simply by adding a RACON/RPCON unit.



Unit Name	Description	See Page
Gateway R unit	This unit is for connecting to a field network. Users can select from 4 types: DeviceNet, CC-Link, ProfiBus, and SIO. *This unit is required for using ROBONET.	P508 P509
RACON unit	This controller operates the RCA actuator. (One unit is necessary per actuator axis.) The incremental specification is the standard, but the simple absolute specification can also be used if the simple absolute R unit is used with it.	P510
RPCON unit	This controller operates the RCP2 actuator. (One unit is necessary per actuator axis.) The incremental specification is the standard, but the simple absolute specification can also be used if the simple absolute R unit is used with it.	P510
Simple absolute R unit	This is the back-up battery unit that retains actuator encoder data when the power is turned off.	P511
Extension unit	This unit makes it possible to reverse ROBONET connections, connect unit controllers (SCON/PCON-CF) to ROBONET, and conduct operation from a network.	P511

Ordering Method/Precautions

Required ROBONET units are ordered individually and assembled by the customer. Consequently, they can be added to or changed later.

<Ordering example> The following 2 actuator axes can be operated through CC-Link. The models that would be best operated with the absolute specification are as follows.

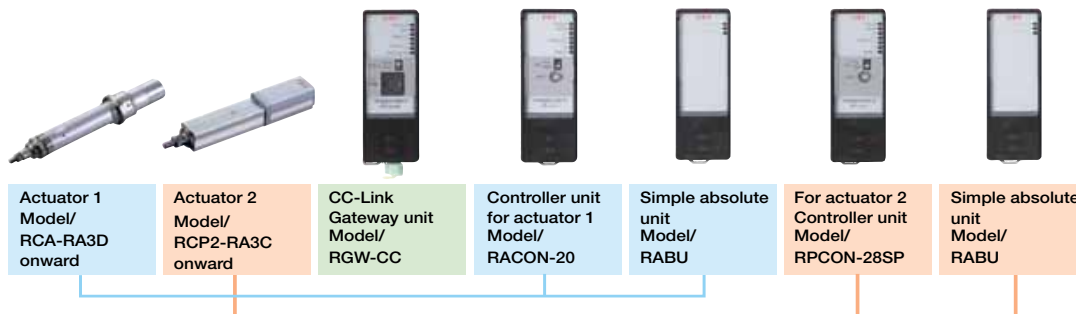

■ Gateway Parameter Setting Tool
A gateway parameter setting tool is necessary to set up the network when ROBONET is connected to a field network. This tool can be acquired at no cost.
(1) Download from the IAI website, or
(2) Acquire PC compatible software (included on CD).
A cable (cable included with PC software, model: CB-RCA-SIO050+RCB-CV-MW) is required to connect the PC to the controller when using the gateway parameter setting tool. If you do not have the PC software, please purchase a cable.

■ PC Compatible Software Teaching Pendant
Compatible PC software or a teaching pendant is required to enter position data, etc. to a ROBONET controller unit. ROBONET compatible PC software (Model: RCM-101-MW/USB) version is Ver. 6.00.04.00 or later. Teaching pendant compatible models and versions include: RCM-T and Ver. 2.06 and later, model: RCM-E/RCM-P and Ver. 2.08 and later. Model: CON-T is compatible with all versions from the earliest version. Consult with our Sales Division if the version your equipment has needs to be updated.

- Slider Type
- Mini
- Standard
- Controllers Integrated
- Rod Type
- Mini
- Standard
- Controllers Integrated
- Table/Arm /Flat Type
- Mini
- Standard
- Gripper/ Rotary Type
- Linear Servo Type
- Cleanroom Type
- Splash-Proof
- Controllers
- PMEC /AMEC
- PSEP /ASEP
- ROBO NET
- ERC2
- PCON
- ACON
- SCON
- PSEL
- ASEL
- SSEL
- XSEL
- Pulse Motor
- Servo Motor (24V)
- Servo Motor (200V)
- Linear Servo Motor

Operation Mode

ROBONET operates upon receiving commands from the PLC via the field network.

The following four operating modes are available. Select the most suitable mode for the operation or the control method.

	Name	Description
1	Positioner mode (1,2)	In this mode, operation is done by specifying position numbers, whose position data, speed, and acceleration have been entered to the position table in advance. A maximum of 768 position points can be saved.
2	Simple direct input mode	The position data is specified directly using a numerical value; the other settings, such as speed, acceleration, deceleration, positioning band, and pushing current limit are specified using a predefined position number. A maximum of 768 position points can be saved.
3	Direct input mode	The position data, speed, acceleration, deceleration, positioning band, and pushing current limit are all specified directly using numerical values. Since the settings are specified by their numerical values, there is no limit to the number of points that can be set.
4	Solenoid valve mode (1,2)	The number of positioning points is limited for a simpler operation. You can operate it using the same controls as a solenoid valve, just by sending a command with the target position number (start signal not required).

List of functions for operation modes

Item	Operation mode	Positioner 1 Mode	Simple immediate data Mode	Direct number designation mode	Positioner 2 Mode	Solenoid Valve Mode 1	Solenoid Valve Mode 2
Each axis field (both input and output)		4 words		8 words	2 words	2 words	
Fixed field (both input and output)		8 words (Command field usable)		8 words (Command field not usable)	8 words (Command field usable)	8 words (Command field usable)	
Number of set positions		768 positions/axis	768 positions/axis	-	768 positions/axis	7 positions/axis	3 positions/axis
Position No. designation operation		<input type="radio"/>	<input type="radio"/>	<input checked="" type="radio"/>	<input type="radio"/>	<input type="radio"/>	<input type="radio"/>
Position data direct designation		<input checked="" type="radio"/>	<input type="radio"/>	<input type="radio"/>	<input checked="" type="radio"/>	<input type="radio"/>	<input checked="" type="radio"/>
Direct designation of speed and acceleration/deceleration speed		<input checked="" type="radio"/>	<input checked="" type="radio"/>	<input type="radio"/>	<input checked="" type="radio"/>	<input type="radio"/>	<input checked="" type="radio"/>
Direct designation of positioning band		<input checked="" type="radio"/>	<input checked="" type="radio"/>	<input type="radio"/>	<input checked="" type="radio"/>	<input type="radio"/>	<input checked="" type="radio"/>
Pushing operation		<input type="radio"/>	<input type="radio"/>	<input type="radio"/>	<input type="radio"/>	<input type="radio"/>	<input type="radio"/>
Completed position No. monitor		<input type="radio"/>	<input type="radio"/>	<input checked="" type="radio"/>	<input type="radio"/>	<input type="radio"/>	<input type="radio"/>
Zone output monitor		<input type="radio"/>	<input type="radio"/>	<input type="radio"/>	<input type="radio"/>	<input type="radio"/>	<input type="radio"/>
Position zone output monitor		<input type="radio"/>	<input type="radio"/>	<input checked="" type="radio"/>	<input type="radio"/>	<input type="radio"/>	<input type="radio"/>
Teaching function		<input type="radio"/>	<input checked="" type="radio"/>	<input checked="" type="radio"/>	<input type="radio"/>	<input type="radio"/>	<input checked="" type="radio"/>
Jog operation		<input type="radio"/>	<input type="radio"/>	<input type="radio"/>	<input type="radio"/>	<input type="radio"/>	<input checked="" type="radio"/>
Incremental operation		<input type="radio"/>	<input type="radio"/>	<input type="radio"/>	<input type="radio"/>	<input type="radio"/>	<input checked="" type="radio"/>
Status signal monitor (*1)		<input type="radio"/>	<input type="radio"/>	<input type="radio"/>	<input type="radio"/>	<input type="radio"/>	<input checked="" type="radio"/>
Current position monitor (*1)		<input type="radio"/>	<input type="radio"/>	<input type="radio"/>	<input type="radio"/>	<input type="radio"/>	<input checked="" type="radio"/>
Alarm code monitor (*1)		<input type="radio"/>	<input type="radio"/>	<input type="radio"/>	<input type="radio"/>	<input type="radio"/>	<input checked="" type="radio"/>
Speed and current monitor (*1)		<input checked="" type="radio"/>	<input checked="" type="radio"/>	<input type="radio"/>	<input checked="" type="radio"/>	<input type="radio"/>	<input checked="" type="radio"/>
Each axis monitoring function in in AUTO mode (*2)		<input type="radio"/>	<input type="radio"/>	<input type="radio"/>	<input type="radio"/>	<input type="radio"/>	<input type="radio"/>
Command	Hand shake	<input type="radio"/>	<input type="radio"/>	<input checked="" type="radio"/>	<input type="radio"/>	<input type="radio"/>	<input type="radio"/>
	Position table Reading/writing of data	<input type="radio"/>	<input type="radio"/>	<input checked="" type="radio"/>	<input type="radio"/>	<input type="radio"/>	<input type="radio"/>
	Reading the current position	<input checked="" type="radio"/>	<input checked="" type="radio"/>	<input checked="" type="radio"/>	<input checked="" type="radio"/>	<input type="radio"/>	<input checked="" type="radio"/>
	Broadcast	<input type="radio"/>	<input checked="" type="radio"/>	<input checked="" type="radio"/>	<input type="radio"/>	<input type="radio"/>	<input type="radio"/>
Max. value for position data designation		9999.99mm (When command is used)	9999.99mm	9999.99mm	9999.99mm (When command is used)	9999.99mm (When command is used)	
Number of axes that can be connected		16	16	8	16	16	

*1: Each status signal monitor, current position monitor, alarm code monitor, and speed/current monitor can be viewed by accessing to each address of Gateway unit via PLC.

*2: Traditionally, monitoring each axis in AUTO mode is unavailable. However, monitoring each axis with Mode switch at "AUTO" is available with ROBONET by connecting the special touch panel to the TP connector.

*3: Independent acceleration and deceleration settings are not available. The setting applies to both accelerating and decelerating speeds.

507

ROBONET

Configuration unit (Gateway R unit)

Gateway R Unit for DeviceNet



A communications unit to operate ROBONET via DeviceNet.

Model RGW-DV

Specifications	Item	Specifications	Item	Specifications				
	Power		DC24V ±10%	DeviceNet Specifications	Comm. Speed	Max. network length	Max. branch length	Total branch length
Current consumption		600mA max.	500kbps		100m		39m	
DeviceNet Specifications	Comm. Standard	DeviceNet 2.0-certified interface module	Environment Requirements	Comm. cable length (*1)	250kbps	250m	6m	78m
		Group 2 only server			125kbps	500m		156m
	Insulated node operating on network power supply			Note: When using a large cable for DeviceNet				
	Comm. Spec.	Master-slave connection		Bit strobe	No. occupied nodes	1 node		
Polling			Ambient op. temperature	0~40°C				
Comm. Speed	500k/250k/125kbps (switchable by software)	Cyclic	Ambient op. humidity	95% RH or below (non-condensing)				
			Ambient op. environment	No corrosive or flammable gasses, oil mist, or dust.				
	Protection class	IP20						
	Weight	140g						
	Accessories	Terminal resistor board (model TN-1) Network connector, Emergency stop connector						

*1 If you wish to use T-junction communication, see the instructions manual for your master unit or PLC.

Network cable

Connector on Gateway Side
MSTBA2.5/5-G-5.08 ABGY AU
(Made by: Phoenix Contact)

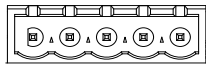

Connector on Cable Side
MSTB2.5/5-ST-5.08 ABGY AU
(Made by: Phoenix Contact)
= Standard accessory



Pin Color	Description
Black	Power cable negative (-) side
Blue	Comm. data Low side
-	Shield
White	Comm. data High side
Red	Power cable plus (+) side

Cable connector-compatible wiring

Item	Description
Wire diameter	Twisted wire: AWG24-12 (0.2~2.5mm ²)
Stripped wire length	7mm

Gateway R Unit for CC-Link



A communications unit to operate ROBONET via CC-Link.

Model RGW-CC

Specifications	Item	Specifications	Item	Specifications					
	Power Supply		DC24V ±10%	Error Control Method	CRC (X ¹⁶ +X ¹² +X ⁵ +1)				
Current consumption		600mA max.	Station occupancy		Remote device stations: x1, 4 st.; x4, 2 st.; x8, 2 st				
CC-Link Specifications	Comm. Standard	CC-Link Ver2.0 (*1)	Comm. Cable Length (*2)	Comm. Speed (bps)	10M	5M	2.5M	625k	156k
	Comm. Speed	10M/5M/2.5M/625k/156kbps (switchable by software)		Total Cable Length (m)	100	160	400	900	1200
	Comm. Method	Broadcast polling method	Comm. Cable	Dedicated CC-Link cable					
	Sync. Method	Frame synchronization method	Ambient op. temperature	0~40°C					
Encoding Method	NRZI	Ambient op. humidity	95% RH or below (non-condensing)						
Transf. Type	Bus format (EIA RS485 compliant)	Ambient op. environment	No corrosive or flammable gasses, oil mist, or dust.						
Transf. Format	HDLC compliant	Protection class	IP20						
	Weight	140g							
	Accessories	Terminal resistor board (model TN-1) Network connector, Emergency stop connector Terminal resistor cable (110Ω/130Ω)							

*1 Certification acquired

*2 If you wish to use T-junction communication, see the instruction manual for your master unit or PLC.

Network cable

Connector on Gateway Side: MSTBA2.5/5-G-5.08AU
(Made by Phoenix Contact)

Connector on Cable Side: MSTB2.5/5-ST-5.08 ABGY AU
(Made by Phoenix Contact) = Standard accessory

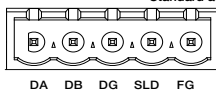

Signal Name	Description
DA	Communication line A
DB	Communication line B
DG	Ground
SLD	The shield and cable's shield are connected, then they are connected to "FG" and the chassis.
FG	Frame ground Connected to "SLD" and the chassis.

Cable connector-compatible wiring

Item	Description
Wire diameter	Twisted wire: AWG24-12 (0.2~2.5mm ²)
Stripped wire length	7mm

- Slider Type
- Mini
- Standard
- Controllers Integrated
- Rod Type
- Mini
- Standard
- Controllers Integrated
- Table/Arm /Flat Type
- Mini
- Standard
- Gripper/ Rotary Type
- Linear Servo Type
- Cleanroom Type
- Splash-Proof
- Controllers
- PMEC /AMEC
- PSEP /ASEP
- ROBO NET
- ERC2
- PCON
- ACON
- SCON
- PSEL
- ASEL
- SSEL
- XSEL
- Pulse Motor
- Servo Motor (24V)
- Servo Motor (200V)
- Linear Servo Motor

- Slider Type
- Mini
- Standard
- Controllers Integrated
- Rod Type
- Mini
- Standard
- Controllers Integrated
- Table/Arm /Flat Type
- Mini
- Standard
- Gripper/ Rotary Type
- Linear Servo Type
- Cleanroom Type
- Splash-Proof
- Controllers
- PMEC /AMEC
- PSEP /ASEP
- ROBO NET
- ERC2
- PCON
- ACON
- SCON
- PSEL
- ASEL
- SSEL
- XSEL
- Pulse Motor
- Servo Motor (24V)
- Servo Motor (200V)
- Linear Servo Motor

Gateway R Unit for ProfiBus



A communications unit to operate ROBONET via ProfiBus.

Model RGW-PR

Item	Specifications		Item	Specifications		
Power Supply	DC24V ±10%		Environment Requirements	Ambient op. temperature	0~40°C	
Current Consumption	600mA max.			Ambient op. humidity	95% RH or below (non-condensing)	
Comm. Standard	DP slave			Ambient op. environment	No corrosive or flammable gases, oil mist, or dust	
ProfiBus Specifications	Comm. Speed	9.6kbps~12Mbps		Protection class	IP20	
	Comm. Cable Length	9.6kbps	1500m	Weight	140g	
		500kbps	400m	Accessories	Terminal resistor board (model TN-1) Emergency stop connector	
		1.5Mbps	200m			
		3Mbps	200m			
12Mbps	100m					

Network cable

Connector on Gateway Side: 5 1
D-Sub connector, 9-pin socket side

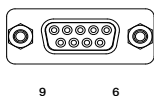

Pin No.	Signal Name	Description	Pin No.	Signal Name	Description
3	B-Line	Communication line B (RS485)	6	+5V	+5V output (insulated)
4	RTS	Request send	8	A-Line	Communication line A (RS485)
5	GND	Signal ground (insulated)	Housing	Shield	Connected to the cable's shield and the chassis.

* The matching connector (D-Sub 9-pin connector) is not included. * Pins 1, 2, 7, and 9 are not connected

Gateway R Unit for SIO



A communications unit for operating ROBONET from an XSEL controller or a Modbus-compatible communications unit, via serial communication.

Model RGW-SIO

Item	Specifications		Item	Specifications	
Power Supply	DC24V ±10%		Environment Requirements	Ambient op. temperature	0~40°C
Current consumption	600mA max.			Ambient op. humidity	95% RH or below (non-condensing)
Comm. Type	RS485-compliant (Modbus protocol) 1:1 communication connection			Ambient op. environment	No corrosive or flammable gases, oil mist, or dust.
Comm. Method	Asynchronous method, half-duplex		Protection class	IP20	
Comm. Speed	230.4kbps max.		Weight	140g	
Cable Length	100m or less		Accessories	Terminal resistor board (model TN-1) Network connector, Emergency stop connector	
Recommended cable	2 pairs of twisted pair cables (shielded)				

Network cable

Connector on Gateway Side
MC1.5/4-G-3.5
(Made by Phoenix Contact)

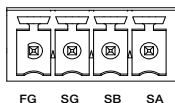

Connector on Cable Side:
MC1.5/4-ST-3.5
(Made by Phoenix Contact)
= Standard accessory

Signal Name	Description	
SA	Communication line A (+positive side)	Built-in RS485-compliant terminal resistor (220Ω)
SB	Communication line B (-negative side)	
SG	Signal ground	
FG	Frame ground connected to the chassis.	

Cable connector-compatible wiring

Item	Description
Wire diameter	Twisted wire: AWG28-16 (0.14~1.5mm ²)
Stripped wire length	7mm

509

ROBONET

Configuration unit (Controller unit)

RACON unit Controller for RCA2/RCA series



Controller unit that is used for RCA2/RCA actuator operation with ROBONET.

Model **RACON-①②-③**

* In Model ①, input a motor power output. (See the following table.)

- ② will need the code "HA" or "LA" specified when a high acceleration/deceleration or power saving actuator is to be used. (Otherwise, leave it blank.)
- ③ input "ABU" only when a simple absolute unit is used. (Otherwise, leave it blank.)

Model	Compatible actuators
RACON-2②-③	RCL-SA1L / SA4L / SM4L / RA1L
RACON-5②-③	RCL-SA2L / SA5L / SM5L / RA2L
RACON-10②-③	RCA2-SA3C / RN3N / RP3N / GS3N / GD3N / SD3N / TC3N / TW3N / TF3N / TA4 RCL-SA3L / SA6L / SM6L / RA3L
RACON-20②-③	RCA-SA4 / SS4 / SA5 / SS5 / RA4 -20 / RG 4 -20 / A4R / A5R RCACR-SA4C / SA5 RCAW-RA4 -20 RCA2-SA4 / SA5 / TA6
RACON-20S②-③	RCA-RA3 / RG 3 RCAW-RA3 RCA2-SA4 / TA5
RACON-30②-③	RCA-SA6 / SS6 / RA4 -30 / RG 4 -30 / A6R RCACR-SA6 RCAW-RA4 -30 RCA2-SA6C / TA7C

Specifications

Item	Specifications	Item	Specifications		
General Specifications	Power Supply	DC24V ±10%	Environment Requirements	Ambient op. temperature	0~50°C
	Power Supply Capacity	5.1A max. (depends on the actuator)		Ambient op. humidity	95% RH or below (non-condensing)
	Operable Actuators	RCA series		Ambient op. environment	No corrosive or flammable gases, oil mist, or dust.
	Positioning Points	768 points		Protection class	IP20
	Backup memory	EEPROM		Weight	200g
	Position Detection Method	Incremental encoder	Accessories	ROBONET connection board (model JB-1), Power connection board (model PP-1)	
	Solenoid brake force-release	Brake release switch			
	Motor Cable	Model: CB-ACS-MA			
	Encoder Cable	Model: CB-ACS-PA			

RPCON unit Controller for RCP3/RCP2 series



Controller unit that is used for RCP3/RCP2 actuator operation with ROBONET.

Model **RPCON-①-②-③**

* In Model ①, input a motor type. (See the following table.)

- ② input "ABU" only when a simple absolute unit is used. (Otherwise, leave it blank.)
- ③ should have the code "H" when an RCP3-SA4, SA5, SA6, or an RCP2(RCP2CR)-SA5 or SA6 is to be connected.

Model	Compatible actuators
RPCON-20P-②	RCP2-RA2C / GRSS / GRSL / GRS RCP3-SA2A / SA2B / RA2A / RA2B
RPCON-28P-②	RCP2-GRM / GR3LS / GR3SS / RTB / RTC / RTBL / RTCL RCP3-SA3C
RPCON-28SP-②	RCP2-RA3C / RGD3C
RPCON-35P-②-③	RCP3-SA4 / TA5
RPCON-42P-②③	RCP2-SA5 / SA6 / SS7 / BA6 / BA7 / RA4C / RG 4C / GR3LM / GR3SM RCP3-SA5 / SA6 / TA6 / TA7 RCP2CR-SA5C / SA6C / SS7C RCP2W-RA4C
RPCON-56P-②	RCP2-SA7 / SS8 / RA6C / RG 6C / RCP2CR-SA7C / SS8C RCP2W-RA6C

Specifications

Item	Specifications	Item	Specifications		
General Specifications	Power Supply	DC24V ±10%	Environment Requirements	Ambient op. temperature	0~50°C
	Power Supply Capacity	2A max.		Ambient op. humidity	95% RH or below (non-condensing)
	Operable Actuators	RCP2 series		Ambient op. environment	No corrosive or flammable gases, oil mist, or dust.
	Positioning Points	768 points		Protection class	IP20
	Backup memory	EEPROM		Weight	200g
	Position Detection Method	Incremental encoder	Accessories	ROBONET connection board (model JB-1), Power connection board (model PP-1)	
	Solenoid brake force-release	Brake release switch			
	Motor Cable	Model: CB-RCP2-MA			
	Encoder Cable	Model: CB-RCP2-PB			



ROBONET **510**

- Slider Type
- Mini
- Standard
- Controllers Integrated
- Rod Type
- Mini
- Standard
- Controllers Integrated
- Table/Arm /Flat Type
- Mini
- Standard
- Cripper/ Rotary Type
- Linear Servo Type
- Cleanroom Type
- Splash-Proof
- Controllers
- PMEC /AMEC
- PSEP /ASEP
- ROBO NET
- ERC2
- PCON
- ACON
- SCON
- PSEL
- ASEL
- SSEL
- XSEL
- Pulse Motor
- Servo Motor (24V)
- Servo Motor (200V)
- Linear Servo Motor

Simple absolute R unit



A data backup battery unit that can be attached to an RACON or RPCON controller to use an incremental actuator as an absolute type.

*1 One unit of the simple absolute R unit is required per RACON/RPCON unit.

Model **RABU** (for RACON and RPCON)

* When preparing a simple absolute R unit together with a controller unit (RACON/RPCON), write down "-ABU" to the end of the controller model, of which the simple absolute unit is installed.

Specifications		Item	Specifications				Item	Specifications	
General Specifications	Power Supply	DC24V ±10%					Environment Requirements	Ambient op. temperature	0~40°C
	Current consumption	300mA max.						Ambient op. humidity	95% RH or below (non-condensing)
	Battery used	Ni-MH battery, nickel-hydrogen cell battery						Ambient op. environment	No corrosive or flammable gases, oil mist, or dust.
	Charging time	Approx. 78 hours						Protection class	IP20
	Battery life	3 yrs						Weight	330g
	Maximum rpm for absolute data retention	800	400	200	100	Accessories		ROBONET connection board (model JB-1) simple absolute connection board (model JB-1) power connection board (model PP-1)	
	Absolute Data Retention Duration (h)	120	240	360	480				

Extension Unit



When too many ROBONET units are connected horizontally to fit into the controller board, use this unit to split them in the middle with a cable to create another row.

In addition, by attaching the extension unit to the end of the linked ROBONET units and using an external controller cable, you can operate a standalone controller SCON like any other ROBONET controller, over the network.

Model **REXT** (for RPCON and RACON)

Specifications		Item	Specifications
General Specifications	Power Supply	DC24V ±10%	
	Current consumption	100mA max.	
Environment Requirements	Ambient op. temperature	0~40°C	
	Ambient op. humidity	95% RH or below (non-condensing)	
	Ambient op. environment	No corrosive or flammable gases, oil mist, or dust.	
	Protection class	IP20	
	Weight	140g	
	Accessories	ROBONET connection board (model JB-1), Power connection board (model PP-1)	

(Note) The cable used is different depending on whether you are creating a new row of linked units, or connecting a standalone controller.

For more information, see the ROBONET extension unit on P505.

External dimensional drawing

External dimensions of Gateway R unit, RACON unit, RPCON unit, Simple Absolute R unit, and Extension unit are same.

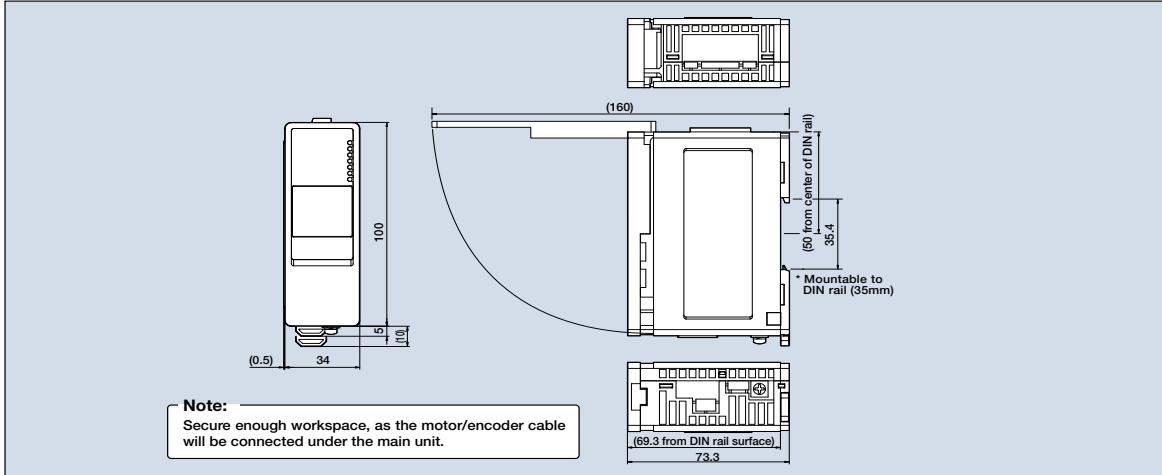

Option

Teaching Pendant

- Features A teaching device with functions for inputting positions, performing test runs, and monitoring.
- Model **CON-PT-M** (Touch panel teaching pendant)
- CON-T** (Standard type)
- RCM-E** (Simple teaching pendant)
- Configuration

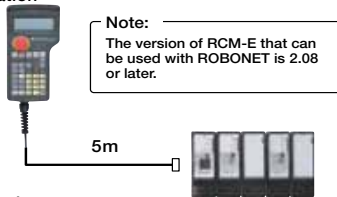

- CON-T Options
 - Wall-mounting hook Model HK-1
 - Strap Model STR-1

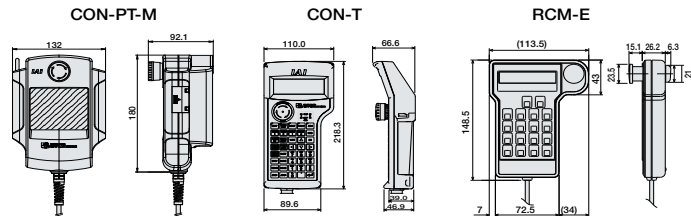

Specifications

Item	CON-PT-M	CON-T	RCM-E
Data Input	○	○	○
Actuator motion	○	○	○
Ambient Operating Temp./Humidity	Temp: 0~40°C; Humidity: 85% RH or below		
Ambient Operating Atmosphere	No corrosive gases. Especially no dust.		
Protection class	IP40	IP54	-
Weight	Approx. 750g	Approx. 400g	Approx. 400g
Cable Length	5m		
Display	3-color LED touch panel with backlight	20 char. x 4 lines LCD display	16 char. x 2 lines LCD display
Standard Price	-	-	-

PC Software (Windows Only)

- Features A startup support software for inputting positions, performing test runs, and monitoring. With enhancements for adjustment functions, the startup time is shortened.
- Model **RCM-101-MW** (with external device communications cable + RS232 conversion unit)

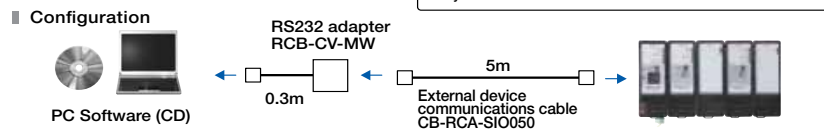

- Model **RCM-101-USB** (with external device communications cable + USB adapter + USB cable)

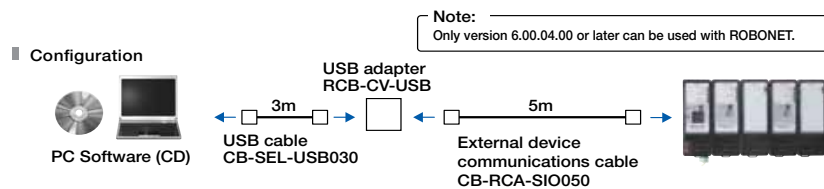

- Slider Type
- Mini
- Standard
- Controllers Integrated
- Rod Type
- Mini
- Standard
- Controllers Integrated
- Table/Arm /Flat Type
- Mini
- Standard
- Gripper/ Rotary Type
- Linear Servo Type
- Cleanroom Type
- Splash-Proof
- Controllers
- PMEC /AMEC
- PSEP /ASEP
- ROBO NET
- ERC2
- PCON
- ACON
- SCON
- PSEL
- ASEL
- SSEL
- XSEL
- Pulse Motor
- Servo Motor (24V)
- Servo Motor (200V)
- Linear Servo Motor

Option

DC24V Power Supply

Features

A 24V power supply for ROBO Cylinder that can output 17A of momentary current. Power supply units can be operated in parallel, and up to 5 units can be added if a unit runs out of capacity.

Model

PS-241

(100V input model)

PS-242

(200V input model)

Actuator vs. Power Supply Current

Controller type	Actuator type	Power Supply Current [A]		No. of connectible units for each unit of PS-24	
		Rated (= Maximum)		Simultaneous servo ON for all axes*	No simultaneous servo ON for all axes*
RPCON PCON	RCP2, all models (note)	Rated	2	8	8
	SA4, SA5 (20W)	Rated	1.3	3	6
RACON ACON	SA6 (30W)	Maximum	4.4	4	6
		Rated	1.3		
	RA3 (20W)	Maximum	4	3	5
		Rated	1.7		
	RA4 (20W)	Maximum	5.1	3	6
		Rated	1.3		
RA4 (30W)	Maximum	4.4	4	6	
	Rated	1.3			

* Refers to the first servo ON after power-up.
(Note) Excluding HS8C, HS8R, and RA10C
* For PSEL/ASEL, this is different depending on the number of axes and model.
Please inquire for details.



Spare parts

When spare parts are necessary after purchasing the product, such as when replacing a cable, refer to a list of the models below.



ROBONET connection board (simple absolute connection board)
Model JB-1



Terminal resistor board
Model TN-1



Power connection board
Model PP-1

Motor cable for RCP2

Model **CB-RCP2-MA**

* The standard cable for the motor cable is the robot cable. Selection is available.
* Enter the cable length (L) into . Compatible to maximum of 20 meters. Ex.: 080 = 8m

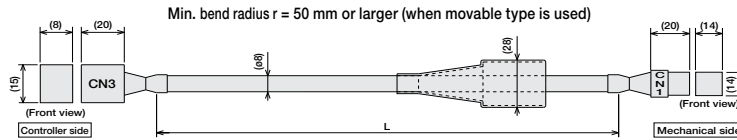

CN3		M cable		CN1		
Orange	A	A1	1	A	Yellow	SLP-06V (JST)
Gray	VMM	A2	2	VMM	Gray	
White	B	A3	3	A	Orange	
Yellow	A	B1	4	B	Yellow (Green)	
Pink	VMM	B2	5	VMM	Pink	
Yellow (Green)	B	B3	6	B	White	

Encoder Cable/Encoder Robot Cable for RCP2

Model **CB-RCP2-PB** / **CB-RCP2-PB** -**RB**

* The standard encoder cable is the normal cable. The robot cable is selectable as an option.
* Enter the cable length (L) into . Compatible to maximum of 20 meters. Ex.: 080 = 8m

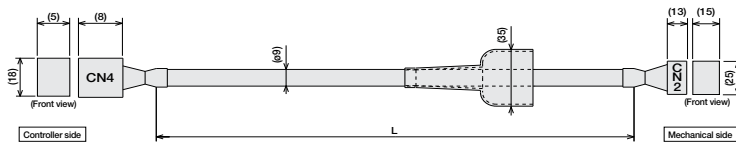

* Only the robot cable is to be used in a cable track.

Signal	Pin Number	Wire color	Pin Number	Signal
VMM	A1	Black	A1	VMM
A	A2	White	A2	A
B	B1	Red	B1	B
VMM	B2	Green	B2	VMM
B	B3	Yellow	B3	B
VMM	A3	Brown	A3	VMM
A	A1	Pink (Red ●)	A4	NC
B	B1	Pink (Blue ●)	A5	BK+
VMM	B2	White (Red ●)	A6	BK-
A	A2	White (Blue ●)	A7	LS+
B	B2	Orange (Red ●)	A8	LS-
VMM	A3	Orange (Blue ●)	A9	A+
A	A1	Gray (Red ●)	A10	A-
B	B1	Gray (Blue ●)	A11	S
VMM	B2	Orange (Blue ● Consecutive)	A12	B
A	A2	Gray (Red ● Consecutive)	A13	NC
B	B2	Gray (Blue ● Consecutive)	A14	NC
VMM	A3	Shield	A15	NC
A	A1		A16	NC
B	B1		A17	NC
VMM	B2		A18	NC
A	A2		A19	NC
B	B2		A20	NC
VMM	A3		A21	NC
A	A1		A22	NC
B	B1		A23	NC
VMM	B2		A24	NC
A	A2		A25	NC
B	B2		A26	NC
VMM	A3		A27	NC
A	A1		A28	NC
B	B1		A29	NC
VMM	B2		A30	NC
A	A2		A31	NC
B	B2		A32	NC
VMM	A3		A33	NC
A	A1		A34	NC
B	B1		A35	NC
VMM	B2		A36	NC
A	A2		A37	NC
B	B2		A38	NC
VMM	A3		A39	NC
A	A1		A40	NC
B	B1		A41	NC
VMM	B2		A42	NC
A	A2		A43	NC
B	B2		A44	NC
VMM	A3		A45	NC
A	A1		A46	NC
B	B1		A47	NC
VMM	B2		A48	NC
A	A2		A49	NC
B	B2		A50	NC
VMM	A3		A51	NC
A	A1		A52	NC
B	B1		A53	NC
VMM	B2		A54	NC
A	A2		A55	NC
B	B2		A56	NC
VMM	A3		A57	NC
A	A1		A58	NC
B	B1		A59	NC
VMM	B2		A60	NC
A	A2		A61	NC
B	B2		A62	NC
VMM	A3		A63	NC
A	A1		A64	NC
B	B1		A65	NC
VMM	B2		A66	NC
A	A2		A67	NC
B	B2		A68	NC
VMM	A3		A69	NC
A	A1		A70	NC
B	B1		A71	NC
VMM	B2		A72	NC
A	A2		A73	NC
B	B2		A74	NC
VMM	A3		A75	NC
A	A1		A76	NC
B	B1		A77	NC
VMM	B2		A78	NC
A	A2		A79	NC
B	B2		A80	NC
VMM	A3		A81	NC
A	A1		A82	NC
B	B1		A83	NC
VMM	B2		A84	NC
A	A2		A85	NC
B	B2		A86	NC
VMM	A3		A87	NC
A	A1		A88	NC
B	B1		A89	NC
VMM	B2		A90	NC
A	A2		A91	NC
B	B2		A92	NC
VMM	A3		A93	NC
A	A1		A94	NC
B	B1		A95	NC
VMM	B2		A96	NC
A	A2		A97	NC
B	B2		A98	NC
VMM	A3		A99	NC
A	A1		A100	NC

Motor-encoder integrated type cable for RCP3/RCP2 (Limited to RCP2-GRSS/GRLS/GRST/SRA4R/SRGS4R/SRGD4R types)

Model **CB-PCS-MPA**

* Enter the cable length (L) into . Compatible to a maximum of 20 meters.
Ex.: 080 = 8 m

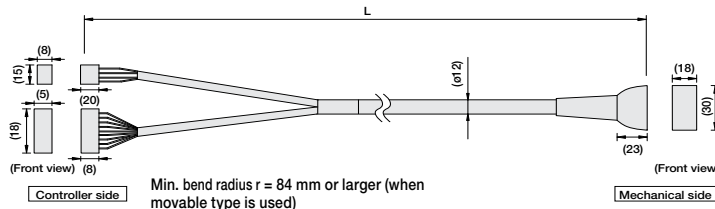

Signal	Pin Number	Wire color	Pin Number	Signal
VMM	A1	Black	A1	VMM
A	A2	White	A2	A
B	B1	Red	B1	B
VMM	B2	Green	B2	VMM
A	A1	Yellow	A3	A
B	B1	Brown	B3	B
BK+	14	Pink (Red ●)	A4	NC
BK-	15	Pink (Blue ●)	A5	BK+
LS+	16	White (Red ●)	A6	BK-
LS-	17	White (Blue ●)	A7	LS+
A+	12	Orange (Red ●)	A8	LS-
A-	11	Orange (Blue ●)	A9	A+
S+	10	Gray (Red ●)	A10	A-
S-	9	Gray (Blue ●)	A11	S+
NC	8		A12	S-
VPS	7	Orange (Blue ● Consecutive)	A13	NC
VCC	6	Gray (Red ● Consecutive)	A14	VPS
GND	5	Gray (Blue ● Consecutive)	A15	VCC
NC	4		A16	GND
FG	1	Shield	A17	NC

513

ROBONET

Spare parts

Motor Cable for RCA

Model **CB-ACS-MA**

* Enter the cable length (L) into . Compatible to a maximum of 20 meters.
Ex.: 080 = 8 m

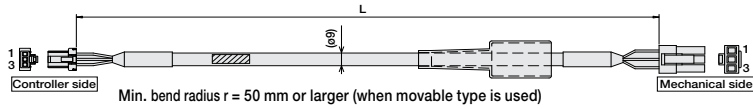

Wire	Color	Signal No.	U	No.	Signal	Color	Wire
AWG22 (crimped)	Red	U	1	1	U	Red	AWG22 (crimped)
	White	V	2	2	V	White	
	Black	W	3	3	W	Black	

Encoder Cable/Encoder Robot Cable for RCA

Model **CB-ACS-PA** / **CB-ACS-PA** -**RB**

* The standard encoder cable is the normal cable. The robot cable is selectable as an option.
* Enter the cable length (L) into . Compatible to maximum of 20 meters. Ex.: 080 = 8m

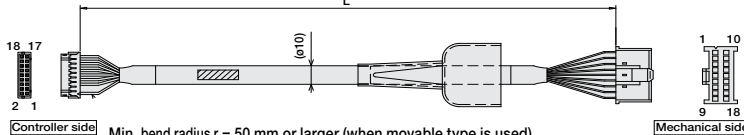

Cable color	Signal	Pin No.	Pin No.	Signal	Cable color
Robot Cable	Standard Cable	Signal	Pin No.	Signal	Robot Cable
White/Purple	Blue	LS+	18	ENZ	Blue
White/Gray	Orange	LS-	17	ENB	Red
Yellow	Green	SK+	16	ENB	Yellow
Blue	Brown	BK-	15	ENB	White/Black
White/Blue	Gray	ENA	14	ENB	White/Black
White/Red	Red	ENZ	13	ENB	White/Black
White/Black	Black	ENB	12	ENB	White/Black
Orange	Pink	ENZ	11	ENB	White/Black
Green	Purple	ENZ	9	ENB	White/Black
Purple	White	ENZ	8	ENB	White/Black
Gray	Blue/Red	VPS	7	ENB	White/Black
Red	Orange/White	SV	6	ENB	White/Black
Black	Green/White	COM2	5	ENB	White/Black
Ground	Ground	F.G.	1	ENB	White/Black

Housing: PHDR-18V (JST)
Contact: SPHD-001-P0.5 (JST)

Pin housing: XMP-18V (JST)
Socket contact: BXA-001-P0.6 (JST)
Retainer: XMS-08V (JST)

Motor-Encoder Integrated Cable for RCA2

Model **CB-ACS-MPA**

* Enter the cable length (L) into . Compatible to a maximum of 20 meters.
Ex.: 080 = 8 m

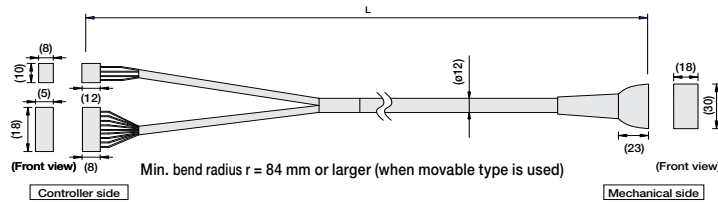

Signal	Pin No.	(Wire color)	Pin No.	Signal
U	1	Yellow	B1	V
V	2	Black	B2	W
W	3	Black	B3	NC
			A3	NC
			B3	NC
BK+	16	Yellow (Red ●)	A4	BK+
BK-	15	Yellow (Blue ●)	B4	BK-
LS+	18	Pink (Red ●)	A5	LS+
LS-	17	Pink (Blue ●)	B5	LS-
A+	14	White (Red ●)	A6	A+
A-	13	White (Blue ●)	B6	A-
B+	12	Orange (Red ●)	A7	B+
B-	11	Orange (Blue ●)	B7	B-
Z+	10	Gray (Red ●)	A8	Z+
Z-	9	Gray (Blue ●)	B8	Z-
/PS	7	Orange (Red ● Consecutive)	A9	/PS
VCC	6	Orange (Blue ● Consecutive)	A10	VCC
GND	5	Gray (Blue ● Consecutive)	B10	GND
NC			A11	NC
FG	1		B11	FG

Unit Link Cable for Extension Unit

Model **CB-REXT-SIO010**

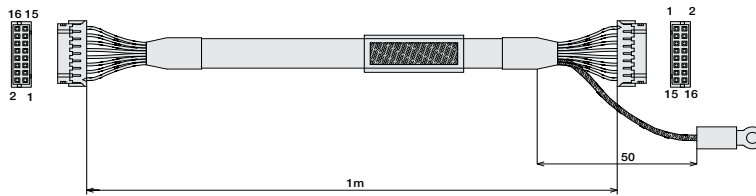

Signal	Pin No.	Black 2/White	Red 2/White	Black 2/Gray	Red 2/Gray	Black 2/Orange	Red 2/Orange	Black 1/Pink	Red 1/Pink	Black 1/Yellow	Red 1/Yellow	Black 1/White	Red 1/White	Black 1/Gray	Red 1/Gray	Black 1/Orange	Red 1/Orange
/RSV1	16																
RSV1	15																
/ROUT	14																
ROUT	13																
/RSV0	12																
RSV0	11																
/ENA	10																
ENA	9																
COM2	8																
COM1	7																
SD-	6																
SD+	5																
RD-	4																
RD+	3																
EMG-	2																
EMG+	1																

Ground: RAV1.25-3
- FG

Wire color legend: <Color of dot> / <Color of insulation>

Controller Connection Cable for Extension Unit

Model **CB-REXT-CTL010**

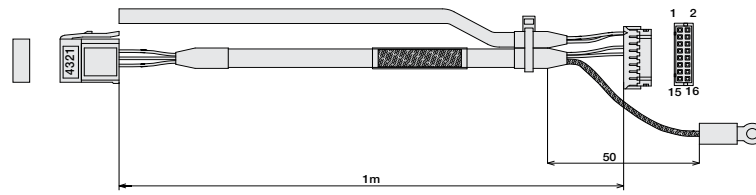

Pin No.	Signal	White	Gray	Orange	White	Gray	Orange
4	N.C.						
3	GND						
2	SD-						
1	SD+						

Shield braiding

Ground: RAV1.25-3
- FG

IAI

ROBONET **514**

- Slider Type
- Mini
- Standard
- Controllers Integrated
- Rod Type
- Mini
- Standard
- Controllers Integrated
- Table/Arm /Flat Type
- Mini
- Standard
- Gripper/ Rotary Type
- Linear Servo Type
- Cleanroom Type
- Splash-Proof
- Controllers
- PMEC /AMEC
- PSEP /ASEP
- ROBO NET
- ERC2
- PC0N
- ACON
- SCON
- PSEL
- ASEL
- SSEL
- XSEL
- Pulse Motor
- Servo Motor (24V)
- Servo Motor (200V)
- Linear Servo Motor