

RCP2-GRSS

Small Gripper, Slide Type

RCP2-GRLS

Small Gripper, Lever Type



Sold & Serviced By:

 **ELECTROMATE**

Toll Free Phone (877) SERV098

Toll Free Fax (877) SERV099

www.electromate.com

sales@electromate.com

Introducing new motorized grippers achieving high grip force and long stroke in a compact body

New

RCP2-GRSS

Small Gripper, Slide Type



New

RCP2-GRLS

Small Gripper, Lever Type



Motorized Gripper Variations

RCP2-GR3SS
RCP2-GR3SM

3-finger gripper
Slide type



RCP2-GR3LS
RCP2-GR3LM

3-finger gripper
Lever type



RCP2-GRS
RCP2-GRM

Gripper
Slide type



Features

1 Compact, Lightweight, High gripping force and long stroke

The compact, lightweight actuator of just 42mm in width, 71mm in height and 200g in weight achieves high performance of 14 N maximum gripping force and 8mm in open/close stroke.

Maximum Grip Force

14N

Open/Close Stroke

8mm

2 Slide type and Lever type

Two types are available for you to choose from. The slider type with a guide promises excellent rigidity, while the lever type ensures easy gripping of the load because the lever opens 180 degrees.

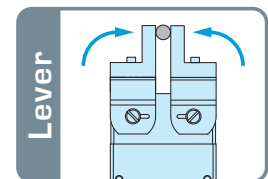
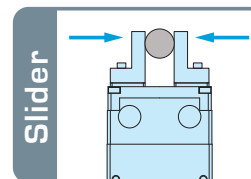

3 Multiple positioning points and adjustable gripping force

The actuator performs positioning to a maximum of 1,500 points based on servo control and the gripping force with which the actuator grabs the load is also adjustable. Accordingly, you can adjust the open/close width of the fingers to make sure loads that deform easily are gripped properly.

4 Zone signal output and simple length measurement

The zone signal function lets you set a desired zone and cause a signal to be output when the actuator enters the specified zone. This function is ideal for load discrimination and other operations. By using serial communication, you can also check the current position of the actuator. This feature can be used to perform simple length measurement.

Examples

Pick and Place

Since multiple positioning points are supported, the open/close width can be adjusted. This is perfect for those applications where the loads are positioned at a small pitch and load positions also change.

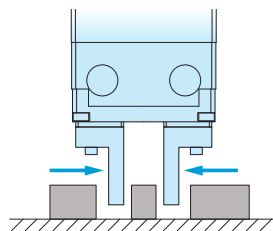

Centering

The right and left sliders or levers move simultaneously to center the load.

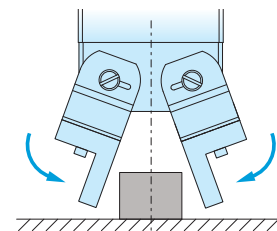

1

Sold & Serviced By:
ELECTROMATE

Toll Free Phone (877) SERV098
Toll Free Fax (877) SERV099
www.electromate.com
sales@electromate.com

Model Designation

RCP2 -	- I -	20P - 30 -	- P1 -	-
Series	Type	Encoder Type	Motor Type	Gear Ratio
	GRSS : Slide Type GRLS : Lever Type	I: Incremental	20P: Pulse Motor, 20 [] size	30: Gear ratio 1/30
			Open/Close Stroke	Applicable Controller
			B: 8mm (4mm per side) 180: 180 deg (90 deg per side)	P1: PCON PSEL
			Cable Length	Options
			N: None P: 1m S: 3m M: 5m X[]: Specified length	NM: Opposite-home specification FB: Flange bracket SB: Shaft bracket

Types

Type	Model
Slide Type	RCP2-GRSS-I-20P-30-8-P1-□
Lever Type	RCP2-GRLS-I-20P-30-180-P1-□

□ in the model names shown above indicates the cable length

Options

Name	Option Code
Opposite-home specification	NM
Flange Bracket	FB
Shaft Bracket	SB

Cable Lengths

Type	Cable code
Standard Type (Robot Cable)	P (1m)
	S (3m)
	M (5m)
Special Length	X06 (6m) - X10 (10m)
	X11 (11m) - X15 (15m)
	X16 (16m) - X20 (20m)

All small grippers come standard with robot cables.

Applicable Controllers

Name	Model
Positioner Type	PCON-C-20PI-NP-2-0
Safety Category Type	PCON-CG-20PI-NP-2-0
Solenoid Valve Type	PCON-CY-20PI-NP-2-0
Pulse Train Differential Receiver Type	PCON-PL-20PI-NP-2-0
Pulse Train Open Collector Type	PCON-PO-20PI-NP-2-0
Serial Communication Type	PCON-SE-20PI-N-0-0
Program Mode Type	PSEL-C-1-20PI-NP-2-0

Specifications

Item	Slide Type	Lever Type
Type (model)	GRSS	GRLS
Open/close stroke	8mm (4mm per side)	180 deg (90 deg per side)
Maximum grip force (N)	14	6.4
Maximum open/close speed	78mm/sec (per side)	600 deg/sec (per side)
Positioning repeatability	±0.01mm	±0.01 deg
Lost motion	0.05mm or less	0.1 deg or less
Dynamic permissible load moment (Nm)	Ma:0.5 Mb:0.5 Mc:1.5	---
Position detection method	Magnetic Encoder (incremental)	
Use environment	Temperature 0 to 40C, humidity 20 to 85% RH or below (non-condensing)	
External dimensions (mm)	24(D) × 42(W) × 71 (L)	24 (D) x 42 (W) x 73 (L)
Actuator weight (Kg)	0.2	
Controller	PCON/PSEL	

Selection Guide

The transportable load weight varies depending on the friction coefficient determined by the materials of the finger and load, as well as the shape of the load. As a guide, the transported load should normally weigh between 1/10 and 1/20 the gripping force. If the load is subject to significant acceleration/deceleration or impact during transport, a greater margin must be provided (by reducing the weight to 1/30 to 1/50 the gripping force). The distance (L) from the finger attachment surface to the gripping point must not exceed the following dimension:

RCP2-GRSS --> 40mm or less

By selecting the push operation mode, the gripping force (F) can be adjusted within a range of 20 to 70% based on the current-limiting value set in the controller

RCP2-GRLS --> 40mm or less

RCP2-GRSS Small gripper, Slide type

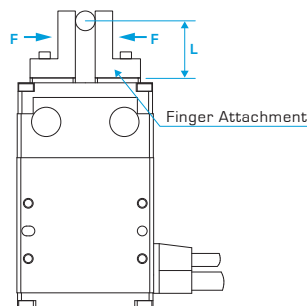
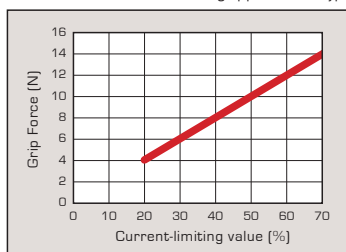

* The gripping force of the GRSS is measured with the finger attached. The actual gripping force will depend on the structural integrity of the finger attachment.

RCP2-GRLS Small gripper, Lever type

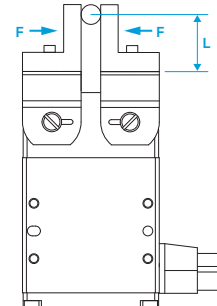
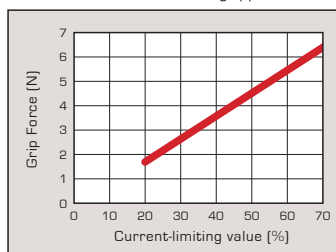

* The gripping force of the GRLS is measured on the top face of the lever. The actual gripping force decreases in inverse proportion to the distance from the open/close fulcrum. Calculate the effective gripping force using the formula below:

$$\text{Effective Grip Force (GRLS)} = F \times 15.5 / (L + 15.5)$$

External Dimensions

【 Slide Type 】

(Model: RCP2-GRSS-I-20P-30-8-P1)

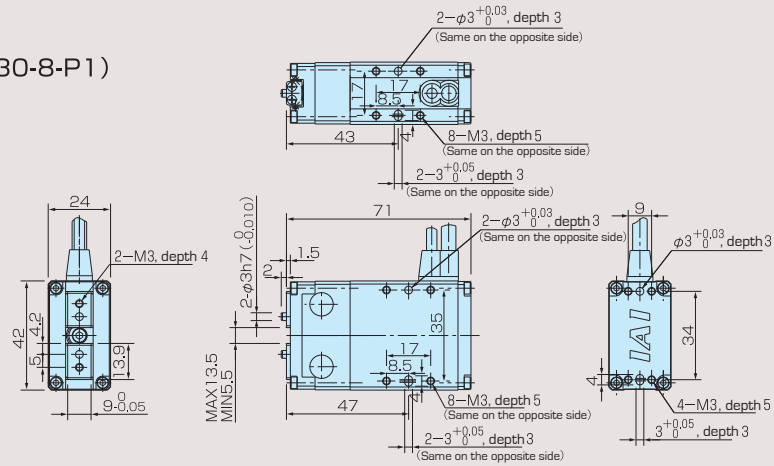

【 Lever Type 】

(Model: RCP2-GRLS-I-20P-30-180-P1)

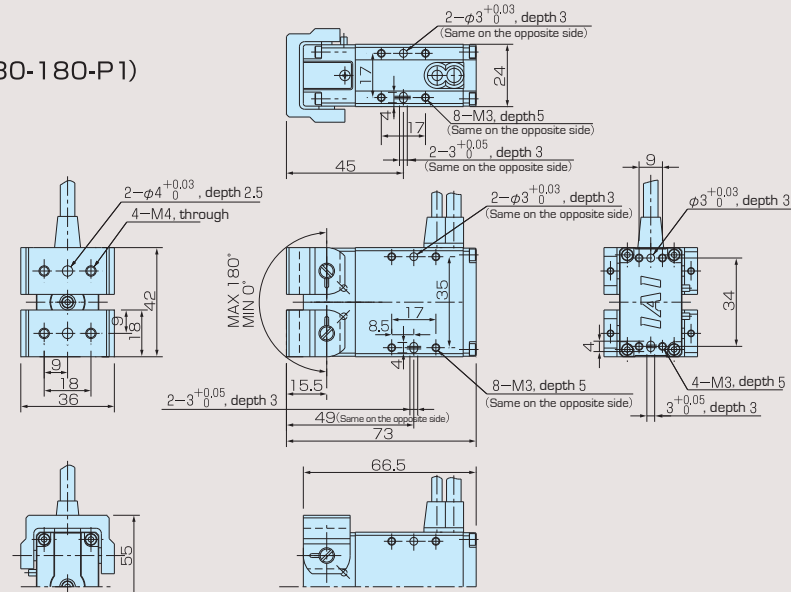

Options

【 Shaft Bracket 】

Unit Model: RCP2-SB-GRSS

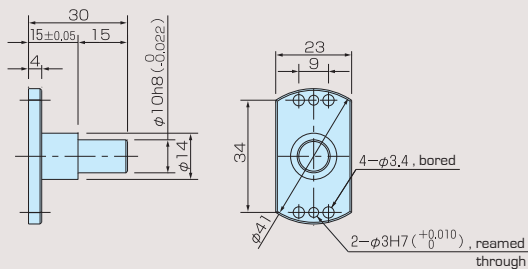

【 Flange Bracket 】

Unit Model: RCP2-FB-GRSS

