

IAI

Quality and Innovation

IS Cast

Single-axis Robot

ISB/SSPA Series



**S, M sizes added to
the SSPA Series**

Sold & Serviced By:

 **ELECTROMATE**

Toll Free Phone (877) SERV098

Toll Free Fax (877) SERV099

www.electromate.com

sales@electromate.com

A major revamp of the single-axis robot IS series with improvements all around—from preciseness, rigidity and payload capacity to speed and acceleration/deceleration.

1. Improved preciseness

- The positioning repeatability is twice as high as with a similar conventional product.
 - Due to an improved preciseness of the guide, the dynamic straightness of the slider is now 0.015 mm/m or less. (*)
- | | | |
|--------------------------------|----------------------|-------------|
| | Conventional product | ISB series |
| • Standard specification | ±0.02 mm | → ±0.01 mm |
| • High-precision specification | ±0.01 mm | → ±0.005 mm |
- * Based on the SSPA of high straightness, precision specification. Refer to P. 13 for details.

2. Improved rigidity

- The SSPA series is an iron base type. It has more than twice the allowable moment in the Mc direction in comparison to the old model of the same size.

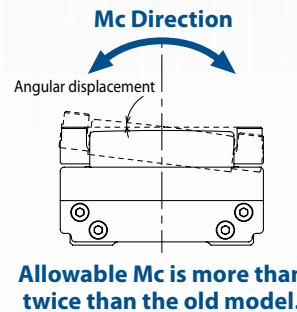
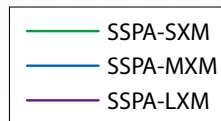
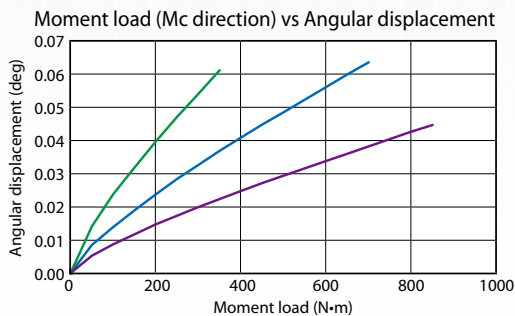

[Comparison between the large iron base type (SSPA-LXM) and the old model]

- The same payload and Mc-direction rigidity are achieved at a cross-section area of just 60% that of a conventional product of an extra-large type (ISA-WXM).

Comparison with conventional product of same payload and Mc-direction rigidity	
NEW Iron-base type SSPA-LXM	Conventional product
<p>Compact size with a cross-section area of just 60%</p>	<p>Extra-large type ISA-WXM</p>

- The long slider type has a longer slider compared to the standard model. Compared to the old model of the same size, the allowable Mc is increased by 10 to 20%. *Long slider type is only for the ISB/ISPB series.

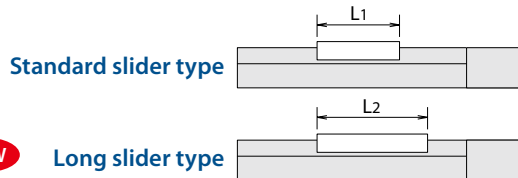
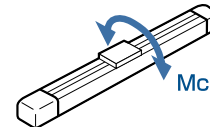

Type	Standard slider (L1)	Long slider (L2)
Small S	90mm	110mm
Medium M	120mm	150mm
Large L	150mm	180mm

1

3. Medium and small types have been added to the iron base series (IS Cast:SSPA/SSPDACR)

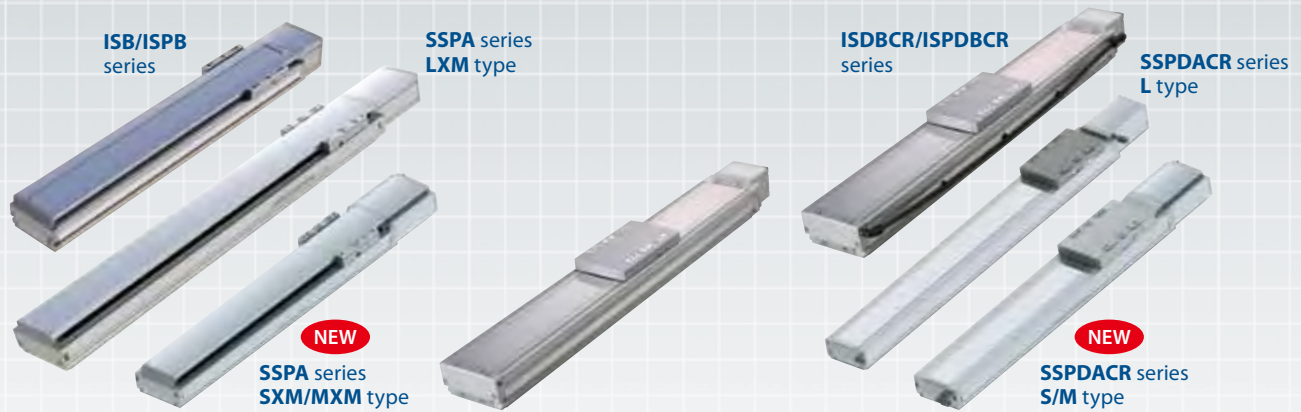

- **Standard specification**
ISB/ISPB/SSPA series
- **Simple, dustproof specification**
ISDB/ISPDB series
- **Cleanroom specification**
ISDBCR/ISPDBCR/
SSPDACR series

4. Performance Upgrade (note) Specifications will vary depending on the model and lead.

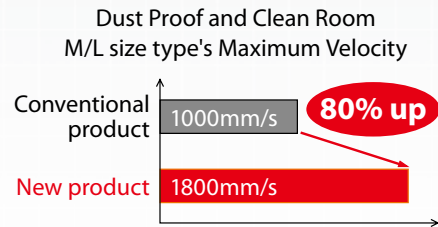

- The payload has increased by approx. 10% with all models.
- The maximum stroke has become longer with all models except for those with an intermediate support.
- The rated acceleration has increased from 0.3 G to 0.4 G, while the maximum acceleration has increased from 1.0 G to 1.2 G.
- The maximum speed of 2500 mm/s (*) is now possible.
(*) Based on the SSPA of lead 50.
- The maximum speed has increased from 1000 mm/s to 1800 mm/s with M/L-size types of the simple, dustproof specification or cleanroom specification.

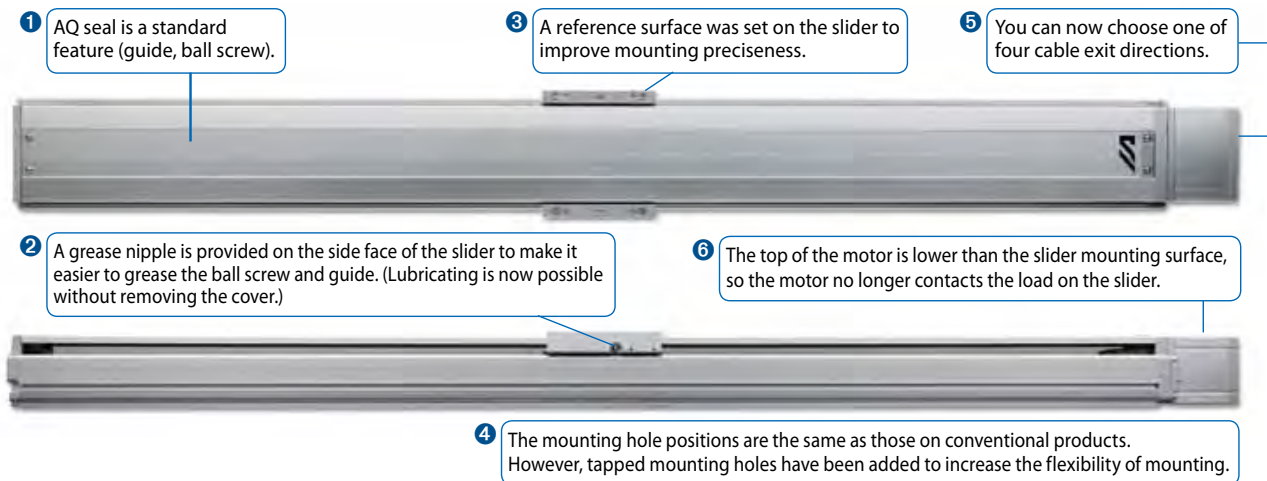

5. Easier to use

- 1 AQ seal is a standard feature.
- 4 Greater flexibility of mounting.
- 2 Easier to grease the ball screw and guide.
- 5 Four cable exit directions to choose from.
- 3 A reference surface is set on the slider.
- 6 The top of the motor does not contact the load on the slider.

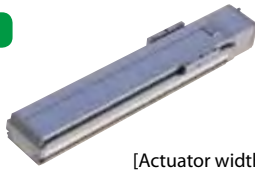

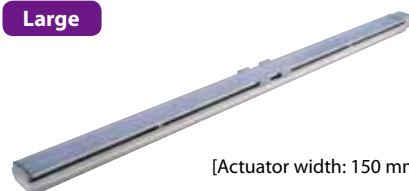



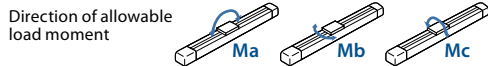

Use environment	Base material	Series name [Positioning repeatability (mm)]	Actuator size	Slider type (slider length) (Note 1)	Type
Standard	Aluminum base	ISB (Standard specification) [±0.01] ISPB (High precision specification) [±0.005]	 [Actuator width: 90 mm]	Standard [90mm]	SXM
				Long [110mm]	SXL
			 [Actuator width: 120 mm]	Standard [120mm]	MXM
				Long [150mm]	MXL
				With mid-support [120mm]	MXMX
			 [Actuator width: 150 mm]	Standard [150mm]	LXM
				Long [180mm]	LXL
				With mid-support [150mm]	LXMX
			 [Actuator width: 150 mm]	Double sliders with mid-support [250mm]	LXUWX

(Note 1) When the slider is longer, the dynamic allowable moment becomes more than that of the standard slider. When mid-support is provided, high-speed movement is possible, even over a long stroke, because deflection of the ball screw can be suppressed.
 (Note 2) If the stroke is short, the maximum speed may not be reached. When the stroke increases, the maximum speed will drop to prevent reaching a dangerous speed. For details, refer to the page explaining the specifications of each model.
 (Note 3) The maximum payload is the value when the actuator is operated at the rated acceleration. The maximum payload will drop if the acceleration is raised. For details, refer to "Table of Payload by Acceleration" on P. 9. The values in () are payloads when a guide with ball retention mechanism (RT) is used.

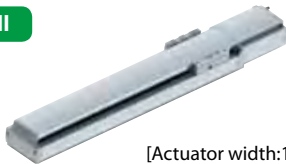
Stroke (mm)	Motor output (W)	Ball screw lead (mm)	Maximum speed (mm/s) (Note 2)	Maximum payload (kg) (Note 3)		Dynamic allowable moment (N-m) (Note 4)			Reference page
				Horizontal	Vertical	Ma	Mb	Mc	
100~900 (in 50mm increments)	60	16	960	13	3.5 (3.0)	28.4	40.2	65.7	P.17
		8	480	27	7 (6.5)				
		4	240	55	14 (13.5)				
130~880 (in 50mm increments)	60	16	960	13	3.5	39.7	56.7	76.3	P.18
		8	480	27	7				
		4	240	55	14				
100~1100 (in 50mm increments)	100	30	1800	15	2.5 (2.0)	69.6	99.0	161.7	P.19
		20	1200	23	5 (4.5)				
		10	600	45	10 (9.5)				
		5	300	85	20 (19.5)				
	200	30	1800	30	6				P.20
		20	1200	45	10				
		10	600	90	20				
120~1070 (in 50mm increments)	100	30	1800	15	2.5	105.3	150.4	193.7	P.21
		20	1200	23	5				
		10	600	45	10				
		5	300	85	20				
	200	30	1800	30	6				P.22
		20	1200	45	10				
		10	600	90	20				
800~2000 (in 100mm increments)	200	30	1800	30	Designed exclusively for horizontal use	69.6	99.0	161.7	P.23
		20	1200	45					
100~1300 (in 50mm increments)	200	40	2400	15	4 (3.0)	104.9	149.9	248.9	P.24
		20	1200	45	10 (9.0)				
		10	600	90	20 (19.0)				
	400	40	2400	40	10				P.25
		20	1200	90	20				
		10	600	120	40				
120~1270 (in 50mm increments)	200	40	2400	15	4	137.8	196.8	278.5	P.26
		20	1200	45	10				
		10	600	90	20				
	400	40	2400	40	10				P.27
		20	1200	90	20				
		10	600	120	40				
1000~2500 (in 100mm increments)	200	20	1200	45	Designed exclusively for horizontal use	104.9	149.9	248.9	P.28
		40	2400	40					P.29
	400	20	1200	90					
1000~2500 (in 100mm increments)	200	20	1200	45	Designed exclusively for horizontal use	179.3	254.8	247.0	P.30
		40	2400	40					P.31
	400	20	1200	90					

Note 4) The value of moment allowed to be applied when the traveling life of the actuator is set to 10,000 km.



Use environment	Base material	Series name [Positioning repeatability (mm)]	Actuator size	Slider type (slider length) (Note 1)	Type
Standard	Iron base	SSPA (High precision specification) [±0.005] NEW	Small  [Actuator width:100mm]	Standard (90mm)	SXM
			Medium  [Actuator width:130mm]	Standard (120mm)	MXM
			Large  [Actuator width:155mm]	Standard (150mm)	LXM
Simple, dustproof	Aluminum base	ISDB (Standard specification) [±0.01] ISPDB (High precision specification) [±0.005]	Small  [Actuator width:90mm]	Standard (154mm)	S
			Medium  [Actuator width:120mm]	Standard (194mm)	M
				With mid-support (194mm)	MX
			Large  [Actuator width:150mm]	Standard (224mm)	L
				With mid-support (224mm)	LX

(Note 1) When a mid-support is provided, high-speed movement is possible, even over a long stroke, because deflection of the ball screw can be suppressed.
 (Note 2) If the stroke is short, the maximum speed may not be reached. When the stroke increases, the maximum speed will drop to prevent reaching a dangerous speed. For details, refer to the page explaining the specifications of each model.
 (Note 3) The maximum payload is the value when the actuator is operated at the rated acceleration. The maximum payload will drop if the acceleration is raised. For details, refer to "Table of Payload by Acceleration" on P. 9. The values in () are payloads when a guide with ball retention mechanism (RT) is used.



5

	Stroke (mm)	Motor output (W)	Ball screw lead (mm)	Maximum speed (mm/s) (Note 2)	Maximum payload (kg) (Note 3)		Dynamic allowable moment (N-m) (Note 4)			Reference page
					Horizontal	Vertical	Ma	Mb	Mc	
	100~1100 (in 50mm increments)	200	30	1800	30	4	36.0	36.0	98.0	P.32
			20	1200	45	6				
			10	600	90	12				
	100~1300 (in 50mm increments)	400	40	2400	45	6	90.0	90.0	230.0	P.33
			20	1200	90	12				
			10	600	120	25				
	100~1500 (in 50mm increments)	750	50	2500	60	12 (10.0)	138.8	138.8	334.5	P.34
			25	1250	120	25 (23.0)				
	100~800 (in 50mm increments)	60	16	960	13	3 (2.5)	28.4	40.2	65.7	P.36
			8	480	27	6 (5.5)				
			4	240	55	14 (13.5)				
	100~1100 (in 50mm increments)	100	30	1800	15	2 (1.5)	69.6	99.0	161.7	P.37
			20	1200	23	4 (3.5)				
			10	600	45	10 (9.5)				
			5	300	85	20 (19.5)				
		200	30	1800	30	6				P.38
			20	1200	45	10				
			10	600	90	20				
			5	300	110	40				
	800~1600 (in 100mm increments)	200	30	1800	30	Designed exclusively for horizontal use	69.6	99.0	161.7	P.39
			20	1200	45					
	100~1300 (in 50mm increments)	200	40	1800	15	2.5 (1.5)	104.9	149.9	248.9	P.40
			20	1200	45	9 (8.0)				
			10	600	90	20 (19.0)				
		400	40	1800	40	8				P.41
			20	1200	90	20				
			10	600	120	40				
	100~1600 (in 100mm increments)	200	40	1800	15	Designed exclusively for horizontal use	104.9	149.9	248.9	P.42
			20	1200	45					
		400	40	1800	40					P.43
			20	1200	90					

(Note 4) The value of moment allowed to be applied when the traveling life of the actuator is set to 10,000 km.

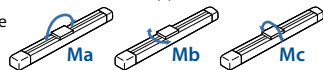
Direction of allowable load moment

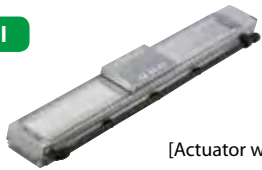

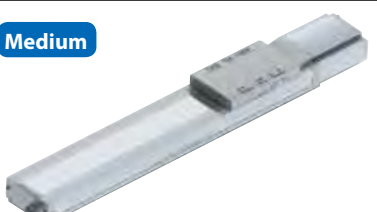
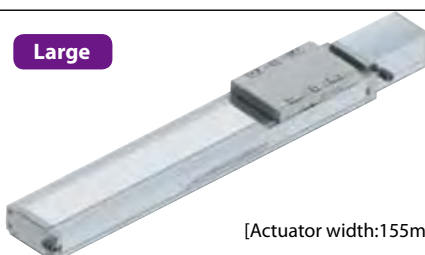
Use environment	Base material	Series name [Positioning repeatability (mm)]	Actuator size	Slider type (slider length) (Note 1)	Type
Cleanroom	Aluminum base	<p>ISDBCR (Standard specification) [±0.01]</p> <p>ISPDBCR (High precision specification) [±0.005]</p>	<p>Small</p>  <p>[Actuator width: 90mm]</p>	Standard (154mm)	S
			<p>Medium</p>  <p>[Actuator width: 120mm]</p>	Standard (194mm)	M
			<p>Large</p>  <p>[Actuator width: 150mm]</p>	With mid-support (192mm)	MX
				Standard (224mm)	L
			With mid-support (220mm)	LX	
			Iron base	Iron base	<p>SSPDACR (High precision specification) [±0.005]</p>
<p>Medium</p>  <p>[Actuator width: 130mm]</p>	Standard (200mm)	M			
<p>Large</p>  <p>[Actuator width: 155mm]</p>	Standard (230mm)	L			

(Note 1) When a mid-support is provided, high-speed movement is possible, even over a long stroke, because deflection of the ball screw can be suppressed.
 (Note 2) If the stroke is short, the maximum speed may not be reached. When the stroke increases, the maximum speed will drop to prevent reaching a dangerous speed. For details, refer to the page explaining the specifications of each model.
 (Note 3) The maximum payload is the value when the actuator is operated at the rated acceleration. The maximum payload will drop if the acceleration is raised. For details, refer to "Table of Payload by Acceleration" on P. 9. The values in () are payloads when a guide with ball retention mechanism (RT) is used.

7

	Stroke (mm)	Motor output (W)	Ball screw lead (mm)	Maximum speed (mm/s) (Note 2)	Maximum payload (kg) (Note 3)		Dynamic allowable moment (N-m) (Note 4)			Reference page
					Horizontal	Vertical	Ma	Mb	Mc	
100~800 (in 50mm increments)	60	60	16	960	13	3 (2.5)	28.4	40.2	65.7	P.45
			8	480	27	6 (5.5)				
			4	240	55	14 (13.5)				
100~1100 (in 50mm increments)	100	100	30	1800	15	2 (1.5)	69.6	99.0	161.7	P.46
			20	1200	23	4 (3.5)				
			10	600	45	10 (9.5)				
			5	300	85	20 (19.5)				
	200	200	30	1800	30	6				P.47
			20	1200	45	10				
			10	600	90	20				
800~2000 (in 100mm increments)	200	200	30	1800	30	Designed exclusively for horizontal use	69.6	99.0	161.7	P.48
			20	1200	45					
			10	600	90					
100~1300 (in 50mm increments)	200	200	40	1800	15	2.5 (1.5)	104.9	149.9	248.9	P.49
			20	1200	45	9 (8.0)				
			10	600	90	20 (19.0)				
	400	400	40	1800	40	8				P.50
			20	1200	90	20				
			10	600	120	40				
1000~2500 (in 100mm increments)	200	200	40	1800	15	Designed exclusively for horizontal use	104.9	149.9	248.9	P.51
			20	1200	45					
	400	400	40	1800	40					P.52
			20	1200	90					
100~1100 (in 50mm increments)	200	200	30	1600	30	4	36.0	36.0	98.0	P.53
			20	1100	45	6				
			10	600	90	12				
100~1300 (in 50mm increments)	400	400	40	1600	45	6	90.0	90.0	230.0	P.54
			20	1100	90	12				
			10	600	120	25				
100~1500 (in 50mm increments)	750	750	50	1600	60	12 (10.0)	138.8	138.8	334.5	P.55
			25	1100	120	25 (23.0)				

(Note 4) The value of moment allowed to be applied when the traveling life of the actuator is set to 10,000 km.

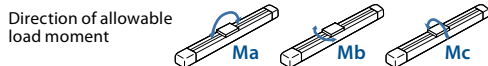

*The selections for each item vary depending on the type. For details, check the page explaining each type.

● Standard type

Example) **ISB** — **MXM** — **A** — **200** — **30** — **1100** — **T2** — **M** — **A3E**

Series — Type — Encoder type — Motor type — Lead — Stroke — Applicable controller — Cable length — Options

ISB	Aluminum base, standard specification
ISPB	Aluminum base, high precision specification
SSPA	Iron base, high precision specification

SXM	Small, X-axis, standard type	LXM	Large, X-axis, standard type
SXL	Small, X-axis, long slider type	LXL	Large, X-axis, long slider type
MXM	Medium, X-axis, standard type	LXMX	Large, X-axis, mid-support type
MXL	Medium, X-axis, long slider type	LXUWX	Large, X-axis, mid-support type, double-slider type
MXMX	Medium, X-axis, mid-support type		

A	Absolute type
I	Incremental type

60	60W
100	100W
200	200W
400	400W
750	750W

100	100mm
?	?
2500	2500mm

* Varies depending on the model.

4	4mm
5	5mm
8	8mm
10	10mm
16	16mm
20	20mm
25	25mm
30	30mm
40	40mm
50	50mm

* The selectable leads vary depending on the model.

T1	XSEL-J/K
	XSEL-P/Q
T2	SSEL
	SCON

N	None
S	3m
M	5m
X□□	Specified length

* The standard cable is a robot cable.

A1S	Cable exit from the left
A1E	Cable exit from the rear left
A3S	Cable exit from the right
A3E	Cable exit from the rear right
AQ	AQ seal (standard feature)
B	Brake
C	Creep sensor
CL	Creep sensor on the opposite side
L	Home limit switch
LL	Home limit switch on the opposite side
LM	Master axis specification
LLM	Master axis specification (sensor on opposite side)
MD	Electrolytic black coating*
NM	Non-motor side specification
RT	Guide with ball retention mechanism
S	Slave axis specification
ST	High straightness, precision specification

* Electrolytic black coating (MD) is an option only for the SSPA series.

Be sure to specify the AQ seal option (AQ). For the cable exit direction, be sure to specify an applicable code (A1S/A1E/A3S/A3E).

● Simple, dustproof type

Example) **ISDB** — **M** — **A** — **200** — **20** — **500** — **T2** — **M** — **B**

Series — Type — Encoder type — Motor type — Lead — Stroke — Applicable controller — Cable length — Options

ISDB	Standard specification
ISPDB	High precision specification

S	Small, standard type
M	Medium, standard type
MX	Medium, mid-support type
L	Large, standard type
LX	Large, mid-support type

A	Absolute type
I	Incremental type

60	60W
100	100W
200	200W
400	400W

100	100mm
?	?
1600	1600mm

* Varies depending on the model.

4	4mm
5	5mm
8	8mm
10	10mm
16	16mm
20	20mm
30	30mm
40	40mm

* The selectable leads vary depending on the model.

T1	XSEL-J/K
	XSEL-P/Q
T2	SSEL
	SCON

N	None
S	3m
M	5m
X□□	Specified length

* The standard cable is a robot cable.

A1S	Cable exit from the left
A1E	Cable exit from the rear left
A3S	Cable exit from the right
A3E	Cable exit from the rear right
AQ	AQ seal (standard feature)
B	Brake
C	Creep sensor
CL	Creep sensor on opposite side
L	Home limit switch
LL	Home limit switch on opposite side
LM	Master axis specification
LLM	Master axis specification (sensor on opposite side)
NM	Non-motor side specification
RT	Guide with ball retention mechanism
S	Slave axis specification
ST	High straightness, precision specification

Be sure to specify the AQ seal option (AQ). For the cable exit direction, be sure to specify an applicable code (A1S/A1E/A3S/A3E).

● Cleanroom type

Example) **ISDBCR** — **M** — **A** — **200** — **20** — **500** — **T2** — **M** — **RT**

Series — Type — Encoder type — Motor type — Lead — Stroke — Applicable controller — Cable length — Options

ISDBCR	Aluminum base, standard specification
ISPDBCR	Aluminum base, high precision specification
SSPDACR	Iron base, high precision specification

S	Small, standard type
M	Medium, standard type
MX	Medium, mid-support type
L	Large, standard type
LX	Large, mid-support type

A	Absolute type
I	Incremental type

60	60W
100	100W
200	200W
400	400W
750	750W

100	100mm
?	?
2500	2500mm

* Varies depending on the model.

4	4mm
5	5mm
8	8mm
10	10mm
16	16mm
20	20mm
25	25mm
30	30mm
40	40mm
50	50mm

* The selectable leads vary depending on the model.

T1	XSEL-J/K
	XSEL-P/Q
T2	SSEL
	SCON

N	None
S	3m
M	5m
X□□	Specified length

* The standard cable is a robot cable.

A1S	Cable exit from the left
A1E	Cable exit from the rear left
A3S	Cable exit from the right
A3E	Cable exit from the rear right
AQ	AQ seal (standard feature)
B	Brake
C	Creep sensor
CL	Creep sensor on opposite side
L	Home limit switch
LL	Home limit switch on opposite side
LM	Master axis specification
LLM	Master axis specification (sensor on opposite side)
NM	Non-motor side specification
RT	Guide with ball retention mechanism
S	Slave axis specification
ST	High straightness, precision specification
VR	Suction tube joint on opposite side

Be sure to specify the AQ seal option (AQ). For the cable exit direction, be sure to specify an applicable code (A1S/A1E/A3S/A3E).

Cable Exit Direction

Model number Option **A1S/A1E/A3S/A3E**

You can choose one of four cable exit directions.
 * Be sure to specify one of four model numbers.

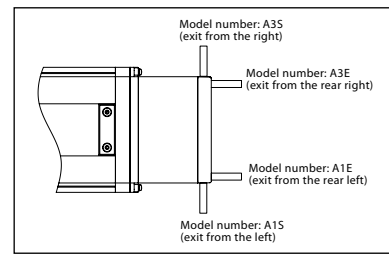

AQ seal (lubrication unit)

Model number option **AQ**

This unit prevents foreign objects from entering the ball screw and sliding part of the guide, while continuously supplying an appropriate amount of lubricating oil. (Standard feature on all models)
 * Be sure to specify the model number option.

Brake

Model number option **B**

When the actuator is used vertically, this mechanism holds the slider in place in the event that the power or servo is turned off, so that the slider will not drop and cause damage to the load. When the brake is equipped, the motor cover becomes longer than the specification without the brake. (Refer to the external view of each model.)

Creep sensor

Model number option **C (standard) /CL (opposite side)**

This sensor shortens the time required for home return. During the home return, the slider moves to the mechanical end at low speed, so actuators with a long stroke take a longer time to complete the home return. The creep sensor is installed near the mechanical end so that the slider can be moved at high speed to the sensor position and when the sensor actuates, the speed is reduced to the specified low level. This way, the time of home return can be shortened. With the standard option (C), this sensor is installed on the right side of the actuator as viewed from the motor. Select the opposite side option (CL) if you want to install the sensor on the opposite side. The external dimensions vary depending on whether or not the sensor and cover are installed. When the creep sensor alone is installed, there is an additional sensor only on the home side and the dimensions change accordingly. If the home limit switch is also used, the dimensions conform to those of the specification with home limit switch.

Home limit switch

Model number option **L (standard) /LL (opposite side)**

Normally actuators adopt the "contact" home return mechanism whereby the slider moves until it contacts the stopper at the mechanical end, upon which the slider reverses its course and moves until the Z-phase is detected, and the detected phase is set as the home. The home limit switch is a convenient option that lets you adjust the reversing position or check whether or not the slider has reversed. With the standard option (L), this switch is installed on the right side of the actuator as viewed from the motor. Select the opposite side option (LL) if you want to install the switch on the opposite side. The external dimensions vary depending on whether or not the sensor and cover are installed.
 * See reference below.

■ Dimensions with Creep Sensor and Home Limit Switch Installed

The following dimensions apply when the sensor and switch are installed.

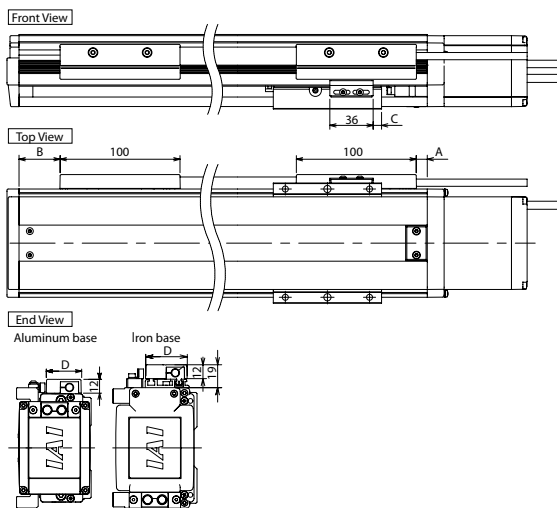

* The above dimensions apply when both the limit switch and creep sensor are installed. If the creep sensor alone is installed, the dimensions on the sensor side (home side) will vary.

Base	Series	Type	A	B	C	D
Aluminum base	ISB ISPb	SXM	9	34	7	29
		SXL	19	44	17	29
		MXM	18	78	2	34.5
		MXL	33	93	17	34.5
		MXMX	66	126	2	34.5
		LXM	36	94	17	42.5
		LXL	41	119	22	42.5
		LXXM	88	140	17	42.5
	LXUWX	83	245	12	42.5	
	ISDB ISPDB	S	10	60	37	29
		M	20	89	46	34.5
		MX	68	137	46	34.5
		L	31	119	57	42.5
		LX	77	165	57	42.5
L		31	119	57	42.5	
ISDBCR ISPDBCR	S	10	60	37	29	
	M	20	89	46	34.5	
	MX	68	137	45	34.5	
	L	31	119	57	42.5	
Iron base	SSPA	SXM	-8*	40	3	34.5
		MXM	-4*	74	3	34.5
	SSPDACR	LXM	19.5 (16.5)	86 (83)	24	42.5
		S	31.5	59.5	38	34.5
		M	40.5	91.5	43	34.5
		L	44.5 (41.5)	111 (108)	64	42.5

(Note) The values in () represent dimensions when the creep sensor alone is installed.

* The dimension A for SSPA-SXM/MXM types indicates the distance overhanging from the base cover end to the motor side.

■ Master axis specification for synchronized operation

Model number option **LM** (standard) /**LLM** (opposite side)

Synchronized operation is a function to move two actuator axes of the same specification—one master axis and one slave axis—in identical manners, with the slave axis following the master axis at very high-speed control. If you want to use synchronized operation, specify “LM” for the master axis and “S” for the slave axis.

■ Electrolytic Black Coating

Model number option **MD**

Option is only for the SSPA series.

The actuator base, side face, slider top and side face will have a rust preventative coating. Suitable in environments where rust will be an issue. It also can be used to prevent dust.

■ Non-motor side specification

Model number option **NM**

Normally the home return is implemented on the motor side, but this direction can be set to the non-motor side as well. To change the home return direction, specify it in your order because the encoder must be adjusted.

■ Guide with ball retention mechanism

Model number option **RT**

A spacer (retainer) is inserted between guide balls (made of steel) to reduce noise and for a longer operating life.

*This option is not available for long slider types (SXL/MXL/LXL).

*Take note that the payload will vary if the actuator is used vertically. (Refer to the model/specification table of each model.)

■ Slave axis specification

Model number option **S**

Enter this model number to specify the slave axis in synchronized operation.

■ Suction tube joint on the opposite side

Model number option **VR**

On standard cleanroom actuators, the vacuum joint is installed on the left side of the actuator as viewed from the motor. Specify this option if you want to have this joint on the opposite side.

High straightness, precision specification

Model number option **ST**

This specification represents a precision actuator of high traveling preciseness in terms of dynamic parallelism (horizontal/vertical) and dynamic straightness (horizontal/vertical) of the slider.

The running parallelism and squareness is based on stroke length. The values shown in the chart below is per 1m.

For calculations based on the stroke length, please use the Aluminum Base and Iron Base Calculation Examples below.

		Aluminum base		Iron base	
		Without high straightness, precision specification	With high straightness, precision specification (*)	Without high straightness, precision specification	With high straightness, precision specification (*)
1	Dynamic parallelism [mm/m or less]	0.05	0.03 [However, if the stroke is less than or equal to 500mm, the squareness will be 0.015mm.]	0.05	0.03 [However, if the stroke is less than or equal to 500mm, the squareness will be 0.015mm.]
2	Dynamic straightness [mm/m or less]	0.05	0.020 [However, if the stroke is less than or equal to 500mm, the squareness will be 0.01mm.]	0.05	0.015 [However, if the stroke is less than or equal to 500mm, the squareness will be 0.008 mm.]

(*)The method of preciseness measurement conforms to IAI's inspection standard.

Aluminum Base and Iron Base Calculation Examples.

① Aluminum Base ISB/ISPB/ISDB/ISPDB/ISDBCR/ISPDBCR series

Ex) When the stroke is 1500mm

Parallelism during motion → 0.03mm/1m (parallelism/meter) x 1.5m (stroke) = 0.045mm

Squareness during motion → 0.02mm/1m (squareness/meter) x 1.5m (stroke) = 0.03mm

*Round up to the 3rd decimal place

② Iron Base SSPA/SSPDACR Series

Ex) When the stroke is 900mm

Parallelism during motion → 0.03mm/1m (parallelism/meter) x 0.9m (stroke) = 0.027mm

Squareness during motion → 0.015mm/1m (squareness/meter) x 0.9m (stroke) = 0.014mm

*Round up to the 3rd decimal place

1 Dynamic parallelism (horizontal/vertical)

① Parallelism of the base reference surface and the slider motion (horizontal)

With the base affixed on a precision surface plate, an indicator on the slider is caused to contact a straight gauge placed in parallel with two points at both ends of the base reference surface, and then the actuator is moved over the entire stroke. The parallelism of the base reference surface and the slider motion represents the maximum difference between the measured values.

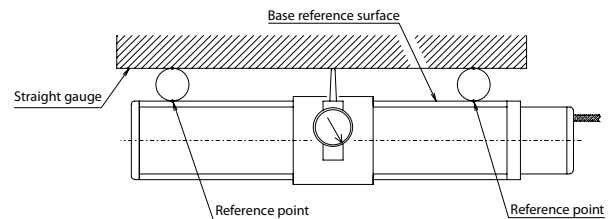

② Parallelism of the base mounting surface and the slider motion (vertical)

With the base affixed on a precision surface plate, an indicator on the slider is caused to contact the surface plate, and then the actuator is moved over the entire stroke. The parallelism of the base mounting surface and the slider motion represents the maximum difference between the measured values.

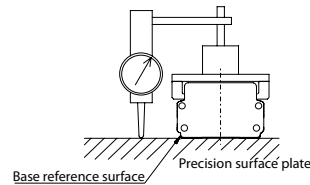

2 Dynamic straightness (horizontal/vertical)

With the base affixed on a precision surface plate, an indicator on the slider is caused to contact a straight gauge placed in parallel with two points at both ends of the base reference surface, and then the actuator is moved over the entire stroke. The parallelism of the base reference surface and the slider motion represents the maximum difference between the measured values.

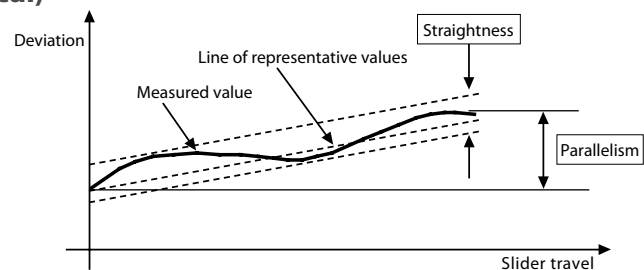

[Duty]

The duty represents the utilization ratio of the actuator (time during which the actuator is operating in each cycle). Since an estimation for applicable duty varies depending on the operating conditions (transferring mass, acceleration/deceleration, etc.), calculate the load factor LF and acceleration/deceleration time ratio t_{od} using the formula on the right and read off an appropriate duty from the graph.

$$\text{Duty} = \frac{\text{Operating time}}{\text{Operating time} + \text{Stopped time}} (\%)$$

How to calculate duty

1 Calculate the load factor LF using the formula below:

$$\text{Load factor: LF} = \frac{M \times \alpha}{M_r \times \alpha_r} (\%)$$

•Payload at rated acceleration: M_r •Actual transferring mass: M
 •Rated acceleration/deceleration: α_r •Actual acceleration/deceleration: α

(Note) Refer to the model number/specification table of each model for the payload at rated acceleration and rated acceleration/deceleration.

2 Calculate the acceleration/deceleration time ratio t_{od} using the formula below:

$$\text{Acceleration/deceleration time ratio } t_{od} = \frac{\text{Acceleration time} + \text{Deceleration time}}{\text{Operating time}} (\%)$$

$$\text{Acceleration time} = \frac{\text{Speed (mm/s)}}{\text{Acceleration (mm/s}^2\text{)}} (\text{sec})$$

$$\text{Deceleration time} = \frac{\text{Speed (mm/s)}}{\text{Deceleration (mm/s}^2\text{)}} (\text{sec})$$

Acceleration (mm/s²) = Acceleration (G) x 9,800 mm/s² Deceleration (mm/s²) = Deceleration (G) x 9,800 mm/s²

3 Read off the estimated duty from the calculated load factor LF and the acceleration/deceleration time ratio t_{od} .

Example. When the load factor LF is 80% and the acceleration/deceleration time ratio t_{od} is 80%, an estimation for duty is approx. 75%.

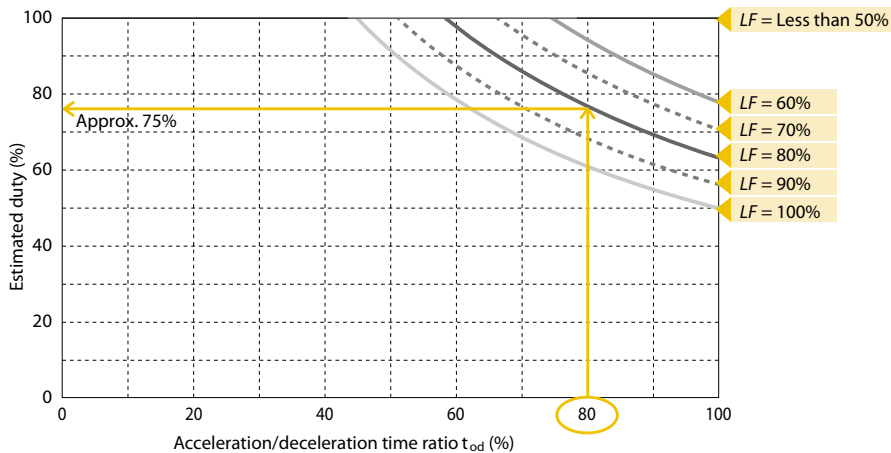

[Dynamic allowable moment and overhang load length]

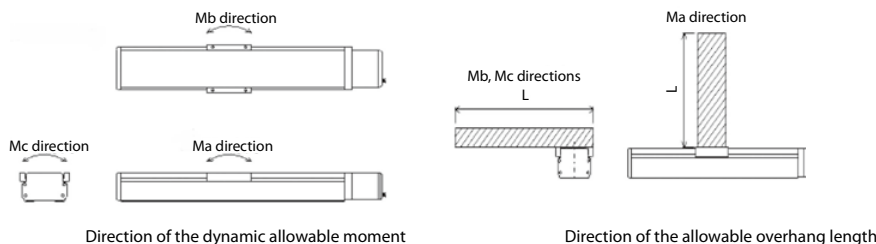

The dynamic allowable moment, calculated from the traveling life of the guide, is the maximum offset load that can be applied to the slider. The traveling life will decrease when the allowable value is exceeded, so use an auxiliary guide, etc., if it is used within the allowable value or the allowable value is exceeded. The overhang load length represents the maximum length that can overhang from the slider when the requirement for dynamic allowable moment is met. Take note that if the specified overhang load length is exceeded, vibration, etc., may occur.



[Mounting]

Check the mounting orientation of each model in the table below.

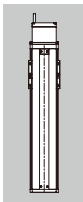
○: Installable —: Not installable

Mounting orientation		Horizontal, flat	Vertical Note 1	Side-mounted	Ceiling-mounted
					
Series	Type				
ISB ISPB	SXM, SXL, MXM, MXL, LXM, LXL	○	○	○ Note 2	○ Note 3
	MXMX, LXMX, LXUWX	○	—	—	—
SSPA	SXM, MXM, LXM	○	○	○ Note 2	○ Note 3
ISDB ISPDB	S, M, L	○	○	○ Note 4	○ Note 4
	ISDBCR ISPDBCR	MX, LX	○	—	—
SSPDACR	S, M, L	○	○	—	—

Note 1 When installing the actuator vertically, bring the motor to the top whenever possible. If the actuator is mounted with the motor at the bottom, problems won't occur during normal operation, but if the actuator is stopped for a prolonged period of time, grease may separate depending on the ambient environment (especially when the ambient temperature is high), in which case base oil may flow into the motor unit and could cause problems on rare occasions.

Note 2 The base oil may separate from the grease and can flow out from the opening on the side of the actuator. Also, foreign debris is able to fall into the actuator through the opening on the side of it.

Note 3 When the actuator with screw cover is ceiling mounted, the screw cover can bend and it may interfere with the work part. If the stroke of the ISB exceeds 600mm, or if the stroke of the SSPA exceeds 800mm, please attach the work part by an offset distance A away from the slider.

The table below shows the distance A from the slider seating surface.

Series	Stroke	Distance A
ISB ISPB	600mm or greater but less than 1000mm	5mm or greater
	1000mm or greater but less than 1300mm	10mm or greater
SSPA	800 mm or greater but less than 1500mm	5mm or greater

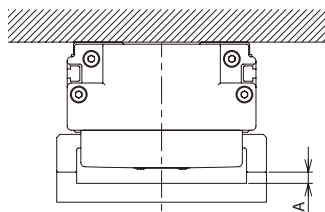

Note 4 When a 400mm stroke actuator with a stainless sheet is side mounted or ceiling mounted, the stainless sheet may be subjected to flexure and can be misaligned. If continued to be used in those conditions, the stainless sheet can be damaged. Please maintain daily and use the manual as a reference for the maintenance procedure of the stainless sheet.

Standard Type

ISB / ISPB / SSPA

ISB ISPB	Standard (High Precision) Type	Small	X-axis, Standard Type	Width: 90mm	ISB (ISPB)-SXM	P.17
			X-axis, Long Slider Type	Width: 90mm	ISB (ISPB)-SXL	P.18
		Medium	X-axis, Standard Type	Width: 120mm	ISB (ISPB)-MXM-100	P.19
				Width: 120mm	ISB (ISPB)-MXM-200	P.20
			X-axis, Long Slider Type	Width: 120mm	ISB (ISPB)-MXL-100	P.21
				Width: 120mm	ISB (ISPB)-MXL-200	P.22
			X-axis, Mid-Support Type	Width: 120mm	ISB (ISPB)-MXMX-200	P.23
			Large	X-axis, Standard Type	Width: 150mm	ISB (ISPB)-LXM-200
		Width: 150mm			ISB (ISPB)-LXM-400	P.25
		X-axis, Long Slider Type		Width: 150mm	ISB (ISPB)-LXL-200	P.26
				Width: 150mm	ISB (ISPB)-LXL-400	P.27
		X-axis, Mid-Support Type		Width: 150mm	ISB (ISPB)-LXMX-200	P.28
				Width: 150mm	ISB (ISPB)-LXMX-400	P.29
		X-axis, Mid-Support, Double-Slider Type		Width: 150mm	ISB (ISPB)-LXUWX-200	P.30
				Width: 150mm	ISB (ISPB)-LXUWX-400	P.31
		SSPA	High Precision Type	Small	X-axis, High-Rigidity, Iron-Base Type	Width: 100mm
Medium	X-axis, High-Rigidity, Iron-Base Type			Width: 130mm	SSPA-MXM-400	P.33
Large	X-axis, High-Rigidity, Iron-Base Type			Width: 155mm	SSPA-LXM-750	P.34

ISB-SXL

ISPB-SXL

Single-axis robot/Small, X-axis, long slider type/Actuator width: 90mm/60W
Straight shape

Single-axis robot/Small, X-axis, long slider type/Actuator width: 90mm/60W
Straight shape **High precision specification**



Model Specification Items

Series	SXL	Type	60	Encoder type	Motor type	Lead	Stroke	Applicable controller	Cable length	Options
ISB: Standard specification ISPB: High precision specification	A: Absolute specification I: Incremental specification	60: 60W 16: 16mm 8: 8mm 4: 4mm	130: 130mm 2: 880: 880mm (in 50mm increments)	T1: XSEL-J/K T2: SCON SSEL XSEL-P/Q	N: None S: 3m M: 5m X□□: Specified length	Refer to the options table below.				

* Refer to P. 10 for the details of items comprising the model number.

Model Number/Specification

Model number	Encoder type	Motor output (W)	Lead (mm)	Stroke in 50mm increments (mm)	Speed (mm/s)	Acceleration (Note 1)				Payload (Note 1)				Rated thrust (N)
						Horizontal (G)		Vertical (G)		Horizontal (kg)		Vertical (kg)		
						Rated	Maximum	Rated	Maximum	Rated acceleration	Maximum acceleration	Rated acceleration	Maximum acceleration	
ISB[ISPB]-SXL- 1 -60-16- 2 - 3 - 4 - 5	Absolute/Incremental	60	16	130~880	1~960	0.4	1.2	0.4	0.8	13	3.5	3.5	2	53.1
8			1~480		0.4	0.7	0.4	0.6	27	12	7	5	106.1	
4			1~240		0.2	0.5	0.2	0.4	55	30	14	12	212.3	

*In the above model numbers, **1** indicates the encoder type, **2** indicates the stroke, **3** indicates the applicable controller, **4** indicates the cable length, and **5** indicates the option(s).

Option

Name	Model number	Reference page	Name	Model number	Reference page
Cable exit from the left	A1S	→P11	Home limit switch	L	→P11
Cable exit from the rear left	A1E	→P11	Home limit switch on the opposite side	LL	→P11
Cable exit from the right	A3S	→P11	Master axis specification	LM	→P12
Cable exit from the rear right	A3E	→P11	Master axis specification (sensor on the opposite side)	LLM	→P12
AQ seal (standard feature)	AQ	→P11	Non-motor side specification	NM	→P12
Brake	B	→P11	Slave axis specification	S	→P12
Creep sensor	C	→P11	High straightness, precision specification	ST	→P13
Creep sensor on the opposite side	CL	→P11			

Common Specifications

Positioning repeatability (Note 2)	±0.01mm (±0.005mm)
Drive method (Note 3)	Ball screw Ø12mm, rolled C10 [equivalent to rolled C5]
Lost Motion (Note 4)	0.05mm [0.02mm] max.
Dynamic allowable load moment (Note 5)	Ma: 39.7N·m Mb: 56.7N·m Mc: 76.3N·m
Overhang load length	Ma direction: 550mm max. Mb, Mc directions: 550mm max.
Dynamic straightness (Note 6)	0.02mm/m max.
Base	Material: Aluminum, with white alumite treatment
Applicable controller	T1: XSEL-J/K T2: XSEL-P/Q, SSEL, SCON
Cable length (Note 7)	N: None, S: 3m, M: 5m, X□□: Specified length
Ambient operating temperature/humidity	0 to 40°C, 85%RH max. (non-condensing)

Diagram

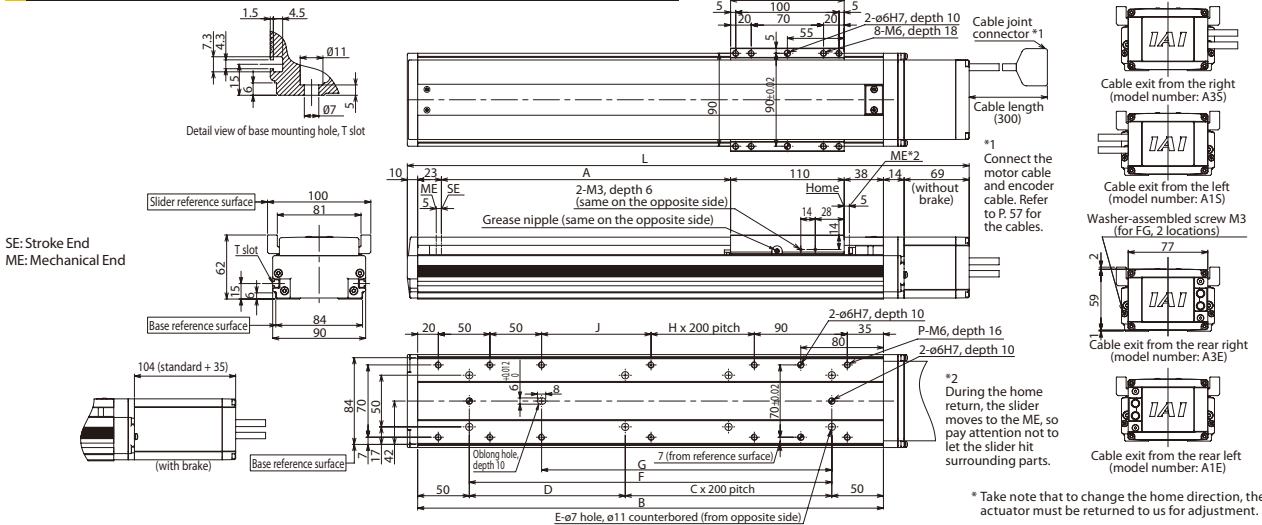

Dimensions, Mass and Maximum Speed by Stroke

Stroke	L																
	130	180	230	280	330	380	430	480	530	580	630	680	730	780	830	880	
without brake	394	444	494	544	594	644	694	744	794	844	894	944	994	1044	1094	1144	
with brake	429	479	529	579	629	679	729	779	829	879	929	979	1029	1079	1129	1179	
A	130	180	230	280	330	380	430	480	530	580	630	680	730	780	830	880	
B	301	351	401	451	501	551	601	651	701	751	801	851	901	951	1001	1051	
C	0	0	1	1	1	1	2	2	2	2	3	3	3	3	4	4	
D	201	251	301	351	401	451	501	551	601	651	701	751	801	851	901	951	
E	4	4	6	6	6	6	8	8	8	8	10	10	10	10	12	12	
F	201	251	301	351	401	451	501	551	601	651	701	751	801	851	901	951	
G	131	181	231	281	331	381	431	481	531	581	631	681	731	781	831	881	
H	0	0	0	0	0	1	1	1	1	2	2	2	2	3	3	3	
J	56	106	156	206	256	306	356	406	456	506	556	606	656	706	756	806	
P	10	10	10	10	10	12	12	12	12	14	14	14	14	16	16	16	
Mass (kg)	3.1	3.5	3.9	4.3	4.6	5.0	5.3	5.7	6.0	6.4	6.7	7.1	7.4	7.8	8.1	8.5	
Maximum speed (mm/s)	Lead 16	960															
	Lead 8	480															
	Lead 4	240															
														655		515	415
														330		260	210
														165		130	100

*If the brake is equipped, the mass increases by 0.3 kg. *The maximum speed (mm/s) varies depending on the stroke.

Applicable Controller Specifications

Applicable Controller	Maximum number of controlled axes	Connectable encoder type	Operating method	Power-supply voltage	Reference page
X-SEL-P/Q	6 axes	Absolute/Incremental	Program	Single/three-phase 200 VAC	→P56
X-SEL-J/K	4 axes			→P56	
SSEL	2 axes			Single-phase 100/200 VAC	→P56
SCON	1 axis			Positioner pulse train control	→P56



(Note 1) Refer to P. 9 for the relationship of acceleration and payload.
(Notes 2, 3, 4) The values in [] apply to the ISPB series. Other specification values apply commonly to the ISB and ISPB.
(Note 5) When the traveling life is 10,000km.
(Note 6) The value of dynamic straightness is when the high straightness, precision specification (option) is specified.
(Note 7) The maximum cable length is 30m. Specify a desired length in meters. (Example. X08 = 8m)

ISB-SXL/ISPB-SXL

18

ISB-MXM-100

Single-axis robot/Medium, X-axis, standard slider type/Actuator width: 120mm/100W Straight shape

ISPB-MXM-100

Single-axis robot/Medium, X-axis, standard slider type/Actuator width: 120mm/100W Straight shape **High precision specification**

Model Specification Items

Series	Type	Encoder type	Motor type	Lead	Stroke	Applicable controller	Cable length	Options
ISB: Standard specification ISPB: High precision specification	MXM	A: Absolute specification I: Incremental specification	100: 100W	30: 30mm 20: 20mm 10: 10mm 5: 5mm	100: 100mm 110: 110mm (in 50mm increments)	T1: XSEL-J/K T2: SCON SSEL XSEL-P/Q	N: None S: 3m M: 5m X□□: Specified length	Refer to the options table below.



* Refer to P. 10 for the details of items comprising the model number.

Model Number/Specification

Model number	Encoder type	Motor output (W)	Lead (mm)	Stroke in 50mm increments (mm)	Speed (mm/s)	Acceleration (Note 1)				Payload (Note 1)				Rated thrust (N)
						Horizontal (G)		Vertical (G)		Horizontal (kg)		Vertical (kg)**		
						Rated	Maximum	Rated	Maximum	Rated acceleration	Maximum acceleration	Rated acceleration	Maximum acceleration	
ISB[ISPB]-MXM-①-100-30-②-③-④-⑤	Absolute Incremental	100	30	100~1100	1~1800	0.4	1.2	0.4	1.2	15	3	2.5	1	56.6
ISB[ISPB]-MXM-①-100-20-②-③-④-⑤			1~1200		0.4	1.2	0.4	1	23	6	5	2.5	84.9	
ISB[ISPB]-MXM-①-100-10-②-③-④-⑤			1~600		0.4	0.7	0.4	0.6	45	20	10	7	169.8	
ISB[ISPB]-MXM-①-100-5-②-③-④-⑤			1~300		0.2	0.5	0.2	0.4	85	45	20	15	339.7	

*1.0G=9800mm/sec²
 **In the above model numbers, ① indicates the encoder type, ② indicates the stroke, ③ indicates the applicable controller, ④ indicates the cable length, and ⑤ indicates the option(s).
 **If the guide with ball retention mechanism (RT) is used, the vertical payload decreases by 0.5kg. (Please also refer to P.9).

Option

Name	Model number	Reference page	Name	Model number	Reference page
Cable exit from the left	A1S	→P11	Home limit switch	L	→P11
Cable exit from the rear left	A1E	→P11	Home limit switch on the opposite side	LL	→P11
Cable exit from the right	A3S	→P11	Master axis specification	LM	→P12
Cable exit from the rear right	A3E	→P11	Master axis specification (sensor on the opposite side)	LLM	→P12
AQ seal (standard feature)	AQ	→P11	Non-motor side specification	NM	→P12
Brake	B	→P11	Guide with ball retention mechanism	RT	→P12
Creep sensor	C	→P11	Slave axis specification	S	→P12
Creep sensor on the opposite side	CL	→P11	High straightness, precision specification	ST	→P13

Common Specifications

Positioning repeatability (Note 2)	±0.01mm [±0.005mm]
Drive method (Note 3)	Ball screw Ø16mm, rolled C10 [equivalent to rolled C5]
Lost Motion (Note 4)	0.05mm [0.02mm] max.
Dynamic allowable load moment (Note 5)	Ma: 69.6N·m Mb: 99.0N·m Mc: 161.7N·m
Overhang load length	Ma direction: 600mm max. Mb, Mc directions: 600mm max.
Dynamic straightness (Note 6)	0.02mm/m max.
Base	Material: Aluminum, with white alumite treatment
Applicable controller	T1: XSEL-J/K T2: XSEL-P/Q, SSEL, SCON
Cable length (Note 7)	N: None, S: 3m, M: 5m, X□□: Specified length
Ambient operating temperature/humidity	0 to 40°C, 85%RH max. (non-condensing)

Diagram

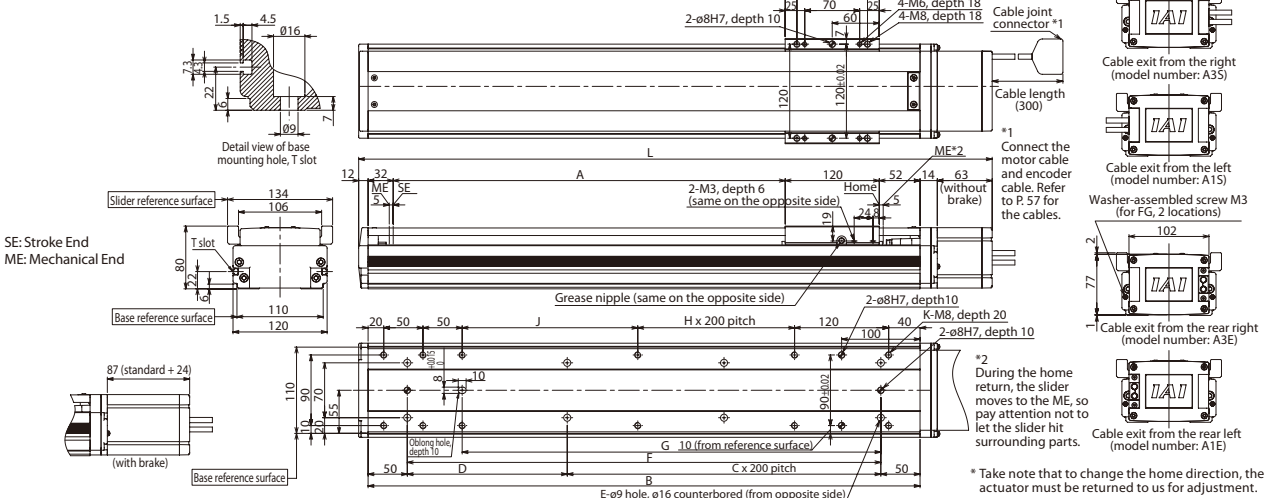

Dimensions, Mass and Maximum Speed by Stroke

Stroke	Lead (mm)											Mass (kg)											Maximum speed (mm/s)			
	100	150	200	250	300	350	400	450	500	550	600	650	700	750	800	850	900	950	1000	1050	1100	Lead 30	Lead 20	Lead 10	Lead 5	
L without brake	393	443	493	543	593	643	693	743	793	843	893	943	993	1043	1093	1143	1193	1243	1293	1343	1393	1800	1200	600	300	
L with brake	417	467	517	567	617	667	717	767	817	867	917	967	1017	1067	1117	1167	1217	1267	1317	1367	1417	1800	1200	600	300	
A	100	150	200	250	300	350	400	450	500	550	600	650	700	750	800	850	900	950	1000	1050	1100	1800	1200	600	300	
B	304	354	404	454	504	554	604	654	704	754	804	854	904	954	1004	1054	1104	1154	1204	1254	1304	1800	1200	600	300	
C	0	0	1	1	1	1	2	2	2	3	3	3	3	4	4	4	4	5	5	5	5	1800	1200	600	300	
D	204	254	304	354	404	454	504	554	604	654	704	754	804	854	904	954	1004	1054	1104	1154	1204	1800	1200	600	300	
E	4	4	6	6	6	6	8	8	8	8	10	10	10	10	12	12	12	14	14	14	14	1800	1200	600	300	
F	204	254	304	354	404	454	504	554	604	654	704	754	804	854	904	954	1004	1054	1104	1154	1204	1800	1200	600	300	
G	134	184	234	284	334	384	434	484	534	584	634	684	734	784	834	884	934	984	1034	1084	1134	1800	1200	600	300	
H	0	0	0	0	0	0	1	1	1	1	2	2	2	2	3	3	3	3	4	4	4	1800	1200	600	300	
J	24	74	124	174	224	274	324	374	424	474	524	574	624	674	724	774	824	874	924	974	1024	1800	1200	600	300	
K	10	10	10	10	10	10	12	12	12	12	14	14	14	14	16	16	16	16	18	18	18	1800	1200	600	300	
Mass (kg)	6.0	6.6	7.2	7.9	8.5	9.2	9.8	10.4	11.0	11.7	12.3	13.0	13.6	14.2	14.8	15.5	16.1	16.8	17.4	18.1	18.7	1800	1200	600	300	
Maximum speed (mm/s)																						1290	860	430	215	

*If the brake is equipped, the mass increases by 0.5kg. *The maximum speed (mm/s) varies depending on the stroke.

Applicable Controller Specifications

Applicable Controller	Maximum number of controlled axes	Connectable encoder type	Operating method	Power-supply voltage	Reference page
X-SEL-P/Q	6 axes	Absolute/incremental	Program	Single/three-phase 200 VAC	→P56
X-SEL-J/K	4 axes			Single-phase 100/200 VAC	→P56
SSEL	2 axes			→P56	
SCON	1 axis			Positioner pulse train control	→P56

CAUTION

(Note 1) Refer to P.9 for the relationship of acceleration and payload. (Notes 2, 3, 4) The values in [] apply to the ISPB series. Other specification values apply commonly to the ISB and ISPB.
 (Note 5) When the traveling life is 10,000k. (Note 6) The value of dynamic straightness is when the high straightness, precision specification (option) is specified.
 (Note 7) The maximum cable length is 30m. Specify a desired length in meters. (Example. X08 = 8m)

19

ISB-MXM-100/ISPB-MXM-100

ISB-MXM-200

Single-axis robot/Medium, X-axis, standard slider type/Actuator width: 120mm/200W Straight shape

ISPB-MXM-200

Single-axis robot/Medium, X-axis, standard slider type/Actuator width: 120mm/200W Straight shape **High precision specification**



Model Specification Items

Series	Type	Encoder type	Motor type	Lead	Stroke	Applicable controller	Cable length	Options
ISB: Standard specification ISPB: High precision specification	MXM 200	A: Absolute specification I: Incremental specification	200: 200W 30: 30mm 20: 20mm 10: 10mm 5: 5mm	100: 100mm 1100: 1100mm (in 50mm increments)	T1: XSEL-J/K T2: SCON SSEL XSEL-P/Q	N: None S: 3m M: 5m X□□: Specified length	Refer to the options table below.	

* Refer to P. 10 for the details of items comprising the model number.

Model Number/Specification

*1.0G=9800mm/sec²

Model number	Encoder type	Motor output (W)	Lead (mm)	Stroke in 50mm increments (mm)	Speed (mm/s)	Acceleration (Note 1)				Payload (Note 1)				Rated thrust (N)
						Horizontal (G)		Vertical (G)		Horizontal (kg)		Vertical (kg)		
						Rated	Maximum	Rated	Maximum	Rated acceleration	Maximum acceleration	Rated acceleration	Maximum acceleration	
ISB[ISPB]-MXM- 1 -200-30- 2 - 3 - 4 - 5	Absolute/Incremental	200	30	100~1100	1~1800	0.4	1.2	0.4	1.2	30	9	6	2	113.9
20			1~1200		0.4	1.2	0.4	1	45	12	10	5	170.9	
10			1~600		0.4	0.7	0.4	0.6	90	40	20	15	341.8	
5			1~300		0.2	0.5	0.2	0.4	110	80	40	30	683.6	

*In the above model numbers, **1** indicates the encoder type, **2** indicates the stroke, **3** indicates the applicable controller, **4** indicates the cable length, and **5** indicates the option(s).

Option

Name	Model number	Reference page	Name	Model number	Reference page
Cable exit from the left	A1S	→P11	Home limit switch	L	→P11
Cable exit from the rear left	A1E	→P11	Home limit switch on the opposite side	LL	→P11
Cable exit from the right	A3S	→P11	Master axis specification	LM	→P12
Cable exit from the rear right	A3E	→P11	Master axis specification (sensor on the opposite side)	LLM	→P12
AQ seal (standard feature)	AQ	→P11	Non-motor side specification	NM	→P12
Brake	B	→P11	Guide with ball retention mechanism	RT	→P12
Creep sensor	C	→P11	Slave axis specification	S	→P12
Creep sensor on the opposite side	CL	→P11	High straightness, precision specification	ST	→P13

Common Specifications

Positioning repeatability (Note 2)	±0.01mm [±0.005mm]
Drive method (Note 3)	Ball screw Ø16mm, rolled C10 [equivalent to rolled C5]
Lost Motion (Note 4)	0.05mm [0.02mm] max.
Dynamic allowable load moment (Note 5)	Ma: 69.6N·m Mb: 99.0N·m Mc: 161.7N·m
Overhang load length	Ma direction: 600mm max. Mb, Mc directions: 600mm max.
Dynamic straightness (Note 6)	0.02mm/m max.
Base	Material: Aluminum, with white alumite treatment
Applicable controller	T1: XSEL-J/K T2: XSEL-P/Q, SSEL, SCON
Cable length (Note 7)	N: None, S: 3m, M: 5m, X□□: Specified length
Ambient operating temperature/humidity	0 to 40°C, 85%RH max. (non-condensing)

Diagram

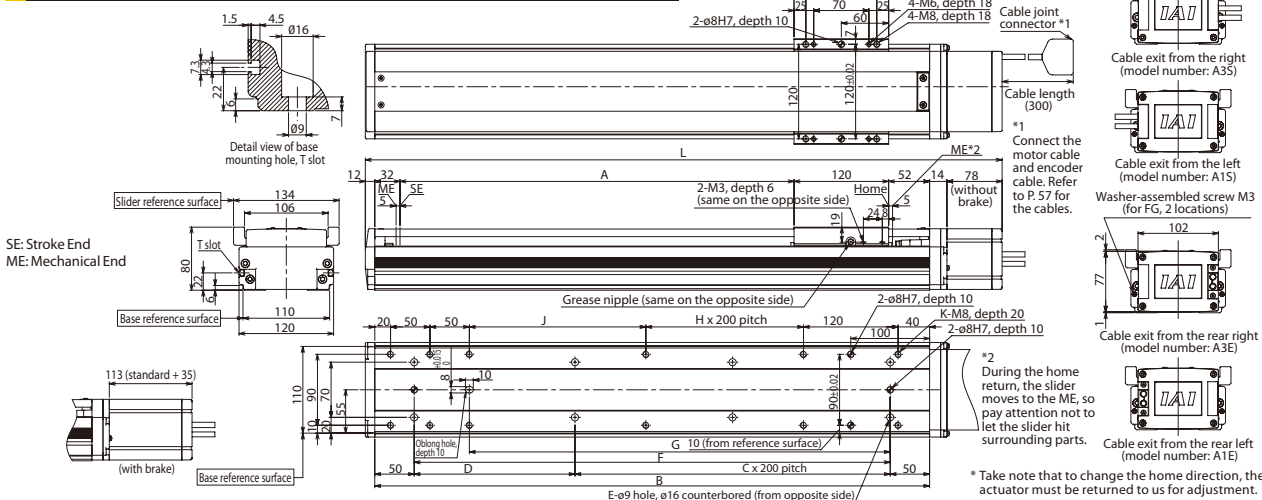

Dimensions, Mass and Maximum Speed by Stroke

*If the brake is equipped, the mass increases by 0.6kg.

*The maximum speed (mm/s) varies depending on the stroke.

L	Stroke	100	150	200	250	300	350	400	450	500	550	600	650	700	750	800	850	900	950	1000	1050	1100		
	without brake	408	458	508	558	608	658	708	758	808	858	908	958	1008	1058	1108	1158	1208	1258	1308	1358	1408		
with brake	443	493	543	593	643	693	743	793	843	893	943	993	1043	1093	1143	1193	1243	1293	1343	1393	1443			
A	100	150	200	250	300	350	400	450	500	550	600	650	700	750	800	850	900	950	1000	1050	1100			
B	304	354	404	454	504	554	604	654	704	754	804	854	904	954	1004	1054	1104	1154	1204	1254	1304			
C	0	0	1	1	1	1	2	2	2	2	3	3	3	3	4	4	4	4	5	5	5			
D	204	254	304	354	404	454	504	554	604	654	704	754	804	854	904	954	1004	1054	1104	1154	1204			
E	4	4	6	6	6	6	8	8	8	8	10	10	10	10	12	12	12	12	14	14	14			
F	204	254	304	354	404	454	504	554	604	654	704	754	804	854	904	954	1004	1054	1104	1154	1204			
G	134	184	234	284	334	384	434	484	534	584	634	684	734	784	834	884	934	984	1034	1084	1134			
H	0	0	0	0	0	0	1	1	1	1	2	2	2	2	3	3	3	3	4	4	4			
J	24	74	124	174	224	274	324	374	424	474	524	574	624	674	724	774	824	874	924	974	1024			
K	10	10	10	10	10	10	12	12	12	12	14	14	14	14	16	16	16	16	18	18	18			
Mass (kg)	6.4	7.1	7.7	8.4	9.0	9.6	10.2	10.9	11.5	12.2	12.8	13.4	14.0	14.7	15.3	16.0	16.6	17.3	17.9	18.5	19.1			
Maximum speed (mm/s)	Lead 30																				1800			
	Lead 20																				1200			
	Lead 10																				600			
	Lead 5																				300			
																					1290	1045	860	690
																					860	695	570	460
																					430	345	280	230
																					215	170	140	115

Applicable Controller Specifications

Applicable Controller	Maximum number of controlled axes	Connectable encoder type	Operating method	Power-supply voltage	Reference page
X-SEL-P/Q	6 axes	Absolute/Incremental	Program	Single/three-phase 200VAC	→P56
X-SEL-J/K	4 axes			→P56	
SSEL	2 axes			Single-phase 100/200VAC	→P56
SCON	1 axis			Positioner pulse train control	→P56



(Note 1) Refer to P. 9 for the relationship of acceleration and payload.
(Notes 2, 3, 4) The values in [] apply to the ISPB series. Other specification values apply commonly to the ISB and ISPB.
(Note 5) When the traveling life is 10,000km.
(Note 6) The value of dynamic straightness is when the high straightness, precision specification (option) is specified.
(Note 7) The maximum cable length is 30m. Specify a desired length in meters. (Example. X08 = 8m)

ISB-MXM-200/ISPB-MXM-200

20

ISB-MXL-100

Single-axis robot/Medium, X-axis, long slider type/Actuator width: 120mm/100W Straight shape

ISPB-MXL-100

Single-axis robot/Medium, X-axis, long slider type/Actuator width: 120mm/100W Straight shape **High precision specification**

Model Specification Items	Series	Type	Encoder type	Motor type	Lead	Stroke	Applicable controller	Cable length	Options
	ISB: Standard specification ISPB: High precision specification	MXL	100	A: Absolute specification I: Incremental specification	100: 100W 30: 30mm 20: 20mm 10: 10mm 5: 5mm	120: 120mm (in 5mm increments) 1070: 1070mm	T1: XSEL-J/K T2: SCON SSEL XSEL-P/Q	N: None S: 3m M: 5m X□□: Specified length	Refer to the options table below.



* Refer to P. 10 for the details of items comprising the model number.

Model Number/Specification

Model number	Encoder type	Motor output (W)	Lead (mm)	Stroke in 50mm increments (mm)	Speed (mm/s)	Acceleration (Note 1)				Payload (Note 1)				Rated thrust (N)
						Horizontal (G)		Vertical (G)		Horizontal (kg)		Vertical (kg)		
						Rated	Maximum	Rated	Maximum	Rated acceleration	Maximum acceleration	Rated acceleration	Maximum acceleration	
ISB[ISPB]-MXL-1-100-30-2-3-4-5	Absolute Incremental	100	30	120~1070	1~1800	0.4	1.2	0.4	1.2	15	3	2.5	1	56.6
ISB[ISPB]-MXL-1-100-20-2-3-4-5			1~1200		0.4	1.2	0.4	1	23	6	5	2.5	84.9	
ISB[ISPB]-MXL-1-100-10-2-3-4-5			1~600		0.4	0.7	0.4	0.6	45	20	10	7	169.8	
ISB[ISPB]-MXL-1-100-5-2-3-4-5			1~300		0.2	0.5	0.2	0.4	85	45	20	15	339.7	

* In the above model numbers, 1 indicates the encoder type, 2 indicates the stroke, 3 indicates the applicable controller, 4 indicates the cable length, and 5 indicates the option(s).

Option

Name	Model number	Reference page	Name	Model number	Reference page
Cable exit from the left	A1S	→P11	Home limit switch	L	→P11
Cable exit from the rear left	A1E	→P11	Home limit switch on the opposite side	LL	→P11
Cable exit from the right	A3S	→P11	Master axis specification	LM	→P12
Cable exit from the rear right	A3E	→P11	Master axis specification (sensor on the opposite side)	LLM	→P12
AQ seal (standard feature)	AQ	→P11	Non-motor side specification	NM	→P12
Brake	B	→P11	Slave axis specification	S	→P12
Creep sensor	C	→P11	High straightness, precision specification	ST	→P13
Creep sensor on the opposite side	CL	→P11			

Common Specifications

Positioning repeatability (Note 2)	±0.01mm (±0.005mm)
Drive method (Note 3)	Ball screw Ø16mm, rolled C10 [equivalent to rolled C5]
Lost Motion (Note 4)	0.05mm [0.02mm] max.
Dynamic allowable load moment (Note 5)	Ma: 105.3N·m Mb: 150.4N·m Mc: 193.7N·m
Overhang load length	Ma direction: 750mm max. Mb, Mc directions: 750mm max.
Dynamic straightness (Note 6)	0.02mm/m max.
Base	Material Aluminum, with white alumite treatment
Applicable controller	T1: XSEL-J/K T2: XSEL-P/Q, SSEL, SCON
Cable length (Note 7)	N: None, S: 3m, M: 5m, X□□: Specified length
Ambient operating temperature/humidity	0 to 40°C, 85%RH max. (non-condensing)

Diagram

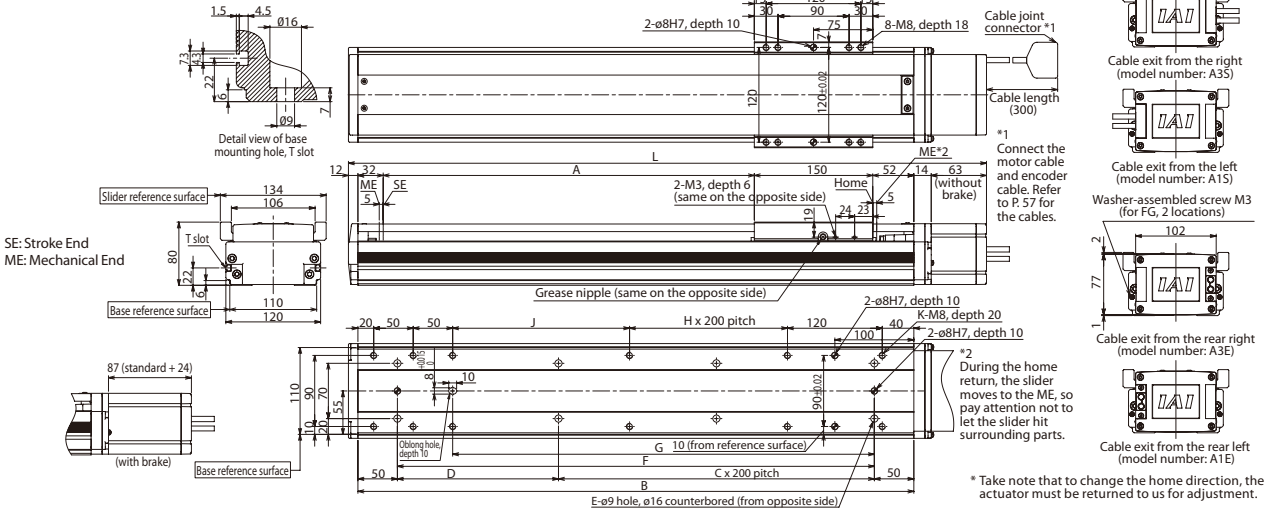

Dimensions, Mass and Maximum Speed by Stroke

Stroke	120	170	220	270	320	370	420	470	520	570	620	670	720	770	820	870	920	970	1020	1070	
L	without brake	443	493	543	593	643	693	743	793	843	893	943	993	1043	1093	1143	1193	1243	1293	1343	1393
	with brake	467	517	567	617	667	717	767	817	867	917	967	1017	1067	1117	1167	1217	1267	1317	1367	1417
A	120	170	220	270	320	370	420	470	520	570	620	670	720	770	820	870	920	970	1020	1070	
B	354	404	454	504	554	604	654	704	754	804	854	904	954	1004	1054	1104	1154	1204	1254	1304	
C	0	1	1	1	1	2	2	2	2	3	3	3	3	4	4	4	4	5	5	5	
D	254	104	154	204	254	304	354	404	454	504	554	604	654	704	754	804	854	904	954	1004	
E	4	6	6	6	6	8	8	8	8	10	10	10	10	12	12	12	12	14	14	14	
F	254	304	354	404	454	504	554	604	654	704	754	804	854	904	954	1004	1054	1104	1154	1204	
G	184	234	284	334	384	434	484	534	584	634	684	734	784	834	884	934	984	1034	1084	1134	
H	0	0	0	0	0	1	1	1	1	2	2	2	2	3	3	3	3	4	4	4	
J	74	124	174	224	274	324	374	424	474	524	574	624	674	724	774	824	874	924	974	1024	
K	10	10	10	10	10	12	12	12	12	14	14	14	14	16	16	16	16	18	18	18	
Mass (kg)	6.3	6.9	7.5	8.2	8.8	9.5	10.1	10.7	11.3	12.0	12.6	13.3	13.9	14.5	15.1	15.8	16.4	17.1	17.7	18.4	
Maximum speed (mm/s)	Lead 30	1800																			
	Lead 20	1200																			
	Lead 10	600																			
	Lead 5	300																			
															1290	1045		860		690	
															860	695		570		460	
															430	345		280		230	
															215	170		140		115	

Applicable Controller Specifications

Applicable Controller	Maximum number of controlled axes	Connectable encoder type	Operating method	Power-supply voltage	Reference page
X-SEL-P/Q	6 axes	Absolute/incremental	Program	Single/three-phase 200 VAC	→P56
X-SEL-J/K	4 axes			Single-phase 100/200 VAC	→P56
SSEL	2 axes				→P56
SCON	1 axis				→P56



(Note 1) Refer to P. 9 for the relationship of acceleration and payload. (Notes 2, 3, 4) The values in [] apply to the ISPB series. Other specification values apply commonly to the ISB and ISPB.
 (Note 5) When the traveling life is 10,000km.
 (Note 6) The value of dynamic straightness is when the high straightness, precision specification (option) is specified.
 (Note 7) The maximum cable length is 30m. Specify a desired length in meters. (Example. X08 = 8m)

21

ISB-MXL-100/ISPB-MXL-100

ISB-MXXM-200

Single-axis robot/Medium, X-axis, mid-support type/Actuator width: 120mm/200W Straight shape

ISPB-MXXM-200

Single-axis robot/Medium, X-axis, mid-support type/Actuator width: 120mm/200W Straight shape **High precision specification**

Model Specification Items

Series	Type	Encoder type	Motor type	Lead	Stroke	Applicable controller	Cable length	Options
ISB: Standard specification ISPB: High precision specification	MXMX	A: Absolute specification I: Incremental specification	200: 200W 30: 30mm 20: 20mm	30: 30mm 20: 20mm	800: 800mm 2000: 2000mm (in 100mm increments)	T1: XSEL-J/K T2: SCON SSEL XSEL-P/Q	N: None S: 3m M: 5m X□□: Specified length	Refer to the options table below.



* Refer to P. 10 for the details of items comprising the model number.

Model Number/Specification

*1.0G=9800mm/sec²

Model number	Encoder type	Motor output (W)	Lead (mm)	Stroke in 100mm increments (mm)	Speed (mm/s)	Acceleration (Note 1)				Payload (Note 1)				Rated thrust (N)
						Horizontal (G)		Vertical (G)		Horizontal (kg)		Vertical (kg)		
						Rated	Maximum	Rated	Maximum	Rated acceleration	Maximum acceleration	Rated acceleration	Maximum acceleration	
ISB[ISPB]-MXMX- 1 -200-30- 2 - 3 - 4 - 5	Absolute	200	30	800~2000	1~1800	0.4		Designed exclusively for horizontal use		30		Designed exclusively for horizontal use	113.9	
ISB[ISPB]-MXMX- 1 -200-20- 2 - 3 - 4 - 5	Incremental		20		1~1200	0.4				45			170.9	

*In the above model numbers, **1** indicates the encoder type, **2** indicates the stroke, **3** indicates the applicable controller, **4** indicates the cable length, and **5** indicates the option(s).

Option

Name	Model number	Reference page	Name	Model number	Reference page
Cable exit from the left	A1S	→P11	Home limit switch	L	→P11
Cable exit from the rear left	A1E	→P11	Home limit switch on the opposite side	LL	→P11
Cable exit from the right	A3S	→P11	Master axis specification	LM	→P12
Cable exit from the rear right	A3E	→P11	Master axis specification (sensor on the opposite side)	LLM	→P12
AQ seal (standard feature)	AQ	→P11	Non-motor side specification	NM	→P12
Brake	B	→P11	Guide with ball retention mechanism	RT	→P12
Creep sensor	C	→P11	Slave axis specification	S	→P12
Creep sensor on the opposite side	CL	→P11	High straightness, precision specification	ST	→P13

Common Specifications

Positioning repeatability (Note 2)	±0.01mm [±0.005mm]
Drive method (Note 3)	Ball screw Ø16mm, rolled C10 [equivalent to rolled C5]
Lost Motion (Note 4)	0.05mm [0.02mm] max.
Dynamic allowable load moment (Note 5)	Ma: 69.6N·m Mb: 99.0N·m Mc: 161.7N·m
Overhang load length	Ma direction: 600mm max. Mb, Mc directions: 600mm max.
Dynamic straightness (Note 6)	0.02mm/m max.
Base	Material: Aluminum, with white alumite treatment
Applicable controller	T1: XSEL-J/K T2: XSEL-P/Q, SSEL, SCON
Cable length (Note 7)	N: None, S: 3m, M: 5m, X□□: Specified length
Ambient operating temperature/humidity	0 to 40°C, 85%RH max. (non-condensing)

Diagram

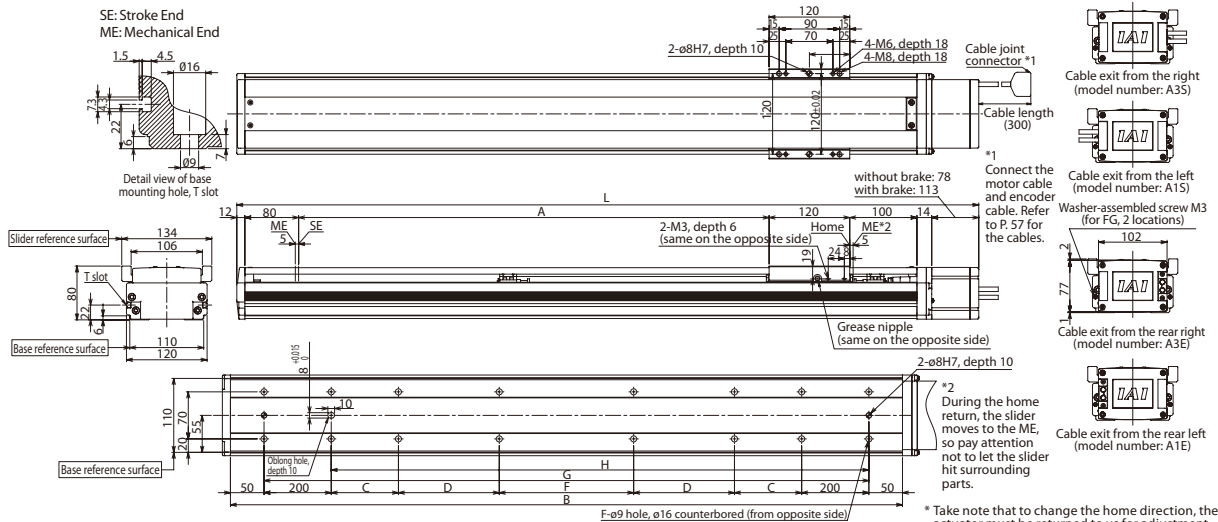

Dimensions, Mass and Maximum Speed by Stroke

*If the brake is equipped, the mass increases by 0.6kg.

*The maximum speed (mm/s) varies depending on the stroke.

Stroke	Maximum speed (mm/s)													
	800	900	1000	1100	1200	1300	1400	1500	1600	1700	1800	1900	2000	
L	without brake	1204	1304	1404	1504	1604	1704	1804	1904	2004	2104	2204	2304	2404
	with brake	1239	1339	1439	1539	1639	1739	1839	1939	2039	2139	2239	2339	2439
A	800	900	1000	1100	1200	1300	1400	1500	1600	1700	1800	1900	2000	
B	1100	1200	1300	1400	1500	1600	1700	1800	1900	2000	2100	2200	2300	
C	200	200	200	250	300	350	400	450	500	550	200	200	200	
D	0	0	0	0	0	0	0	0	0	0	400	400	500	
E	200	300	400	400	400	400	400	400	400	400	400	400	400	
F	12	12	12	12	12	12	12	12	12	12	16	16	16	
G	1000	1100	1200	1300	1400	1500	1600	1700	1800	1900	2000	2100	2200	
H	800	900	1000	1100	1200	1300	1400	1500	1600	1700	1800	1900	2000	
Mass (kg)	16.5	17.8	19.1	20.3	21.6	22.9	24.1	25.4	26.7	28.0	29.2	30.5	31.8	
Maximum speed (mm/s)	Lead 30	1800												
	Lead 20	1200												

Applicable Controller Specifications

Applicable Controller	Maximum number of controlled axes	Connectable encoder type	Operating method	Power-supply voltage	Reference page
X-SEL-P/Q	6 axes	Absolute/ incremental	Program	Single/three-phase 200 VAC	→P56
X-SEL-J/K	4 axes			Single-phase 100/200 VAC	→P56
SSEL	2 axes			Positioner pulse train control	→P56
SCON	1 axis				→P56



(Note 1) Refer to P. 9 for the relationship of acceleration and payload. (Notes 2, 3, 4) The values in [] apply to the ISPB series. Other specification values apply commonly to the ISB and ISPB.

(Note 5) When the traveling life is 10,000km.

(Note 6) The value of dynamic straightness is when the high straightness, precision specification (option) is specified.

(Note 7) The maximum cable length is 30m. Specify a desired length in meters. (Example. X08 = 8m)

23

ISB-MXXM-200/ISPB-MXXM-200

Sold & Serviced By:

ELECTROMATE

Toll Free Phone (877) SERV098

Toll Free Fax (877) SERV099

www.electromate.com

sales@electromate.com

ISB-LXM-400

Single-axis robot/Large, X-axis, standard slider type/Actuator width: 150mm/400W Straight shape

ISPB-LXM-400

Single-axis robot/Large, X-axis, standard slider type/Actuator width: 150mm/400W Straight shape **High precision specification**

Model Specification Items

Series	LXM Type	Encoder type	Motor type	Lead	Stroke	Applicable controller	Cable length	Options
ISB: Standard specification ISPB: High precision specification		A: Absolute specification I: Incremental specification	400: 400W	40: 40mm 20: 20mm 10: 10mm	100: 100mm 1300: 1300mm (in 50mm increments)	T1: XSEL-J/K T2: SCON SSEL XSEL-P/Q	N: None S: 3m M: 5m X□□: Specified length	Refer to the options table below.



* Refer to P. 10 for the details of items comprising the model number.

Model Number/Specification

Model number	Encoder type	Motor output (W)	Lead (mm)	Stroke in 50mm increments (mm)	Speed (mm/s)	Acceleration (Note 1)				Payload (Note 1)				Rated thrust (N)
						Horizontal (G)		Vertical (G)		Horizontal (kg)		Vertical (kg)		
						Rated	Maximum	Rated	Maximum	Rated acceleration	Maximum acceleration	Rated acceleration	Maximum acceleration	
ISB[ISPB]-LXM-①-400-40-②-③-④-⑤	Absolute Incremental	400	40	100~1300	1~2400	0.4	1.2	0.4	1.2	40	15	10	4	169.6
ISB[ISPB]-LXM-①-400-20-②-③-④-⑤			20		1~1200	0.4	1.2	0.4	1	90	24	20	10	339.1
ISB[ISPB]-LXM-①-400-10-②-③-④-⑤			10		1~600	0.4	0.7	0.4	0.6	120	60	40	30	678.3

* In the above model numbers, ① indicates the encoder type, ② indicates the stroke, ③ indicates the applicable controller, ④ indicates the cable length, and ⑤ indicates the option(s).

Option

Name	Model number	Reference page	Name	Model number	Reference page
Cable exit from the left	A1S	→P11	Home limit switch	L	→P11
Cable exit from the rear left	A1E	→P11	Home limit switch on the opposite side	LL	→P11
Cable exit from the right	A3S	→P11	Master axis specification	LM	→P12
Cable exit from the rear right	A3E	→P11	Master axis specification (sensor on the opposite side)	LLM	→P12
AQ seal (standard feature)	AQ	→P11	Non-motor side specification	NM	→P12
Brake	B	→P11	Guide with ball retention mechanism	RT	→P12
Creep sensor	C	→P11	Slave axis specification	S	→P12
Creep sensor on the opposite side	CL	→P11	High straightness, precision specification	ST	→P13

Common Specifications

Positioning repeatability (Note 2)	±0.01mm [±0.005mm]
Drive method (Note 3)	Ball screw Ø20mm, rolled C10 [equivalent to rolled C5]
Lost Motion (Note 4)	0.05mm (0.02mm) max.
Dynamic allowable load moment (Note 5)	Ma: 104.9N·m Mb: 149.9N·m Mc: 248.9N·m
Overhang load length	Ma direction: 750mm max. Mb, Mc directions: 750mm max.
Dynamic straightness (Note 6)	0.02mm/m max.
Base	Material: Aluminum, with white alumite treatment
Applicable controller	T1: XSEL-J/K T2: XSEL-P/Q, SSEL, SCON
Cable length (Note 7)	N: None, S: 3m, M: 5m, X□□: Specified length
Ambient operating temperature/humidity	0 to 40°C, 85%RH max. (non-condensing)

Diagram

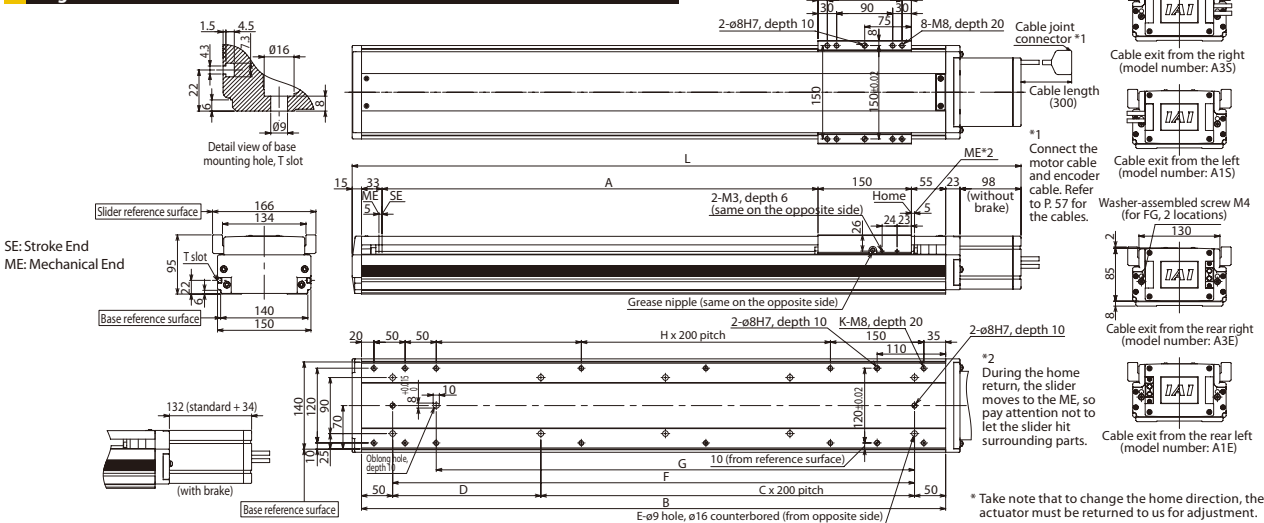

Dimensions, Mass and Maximum Speed by Stroke

Stroke	*If the brake is equipped, the mass increases by 0.6kg.																			*The maximum speed (mm/s) varies depending on the stroke.											
	100	150	200	250	300	350	400	450	500	550	600	650	700	750	800	850	900	950	1000	1050	1100	1150	1200	1250	1300						
L	without brake	474	524	574	624	674	724	774	824	874	924	974	1024	1074	1124	1174	1224	1274	1324	1374	1424	1474	1524	1574	1624	1674					
	with brake	508	558	608	658	708	758	808	858	908	958	1008	1058	1108	1158	1208	1258	1308	1358	1408	1458	1508	1558	1608	1658	1708					
A	100	150	200	250	300	350	400	450	500	550	600	650	700	750	800	850	900	950	1000	1050	1100	1150	1200	1250	1300						
B	338	388	438	488	538	588	638	688	738	788	838	888	938	988	1038	1088	1138	1188	1238	1288	1338	1388	1438	1488	1538						
C	0	0	1	1	1	1	2	2	2	2	3	3	3	3	4	4	4	4	5	5	5	5	6	6	6						
D	238	288	338	388	438	488	538	588	638	688	738	788	838	888	938	988	1038	1088	1138	1188	1238	1288	1338	1388	1438						
E	4	4	6	6	6	6	8	8	8	8	10	10	10	10	12	12	12	12	14	14	14	14	14	16	16						
F	238	288	338	388	438	488	538	588	638	688	738	788	838	888	938	988	1038	1088	1138	1188	1238	1288	1338	1388	1438						
G	168	218	268	318	368	418	468	518	568	618	668	718	768	818	868	918	968	1018	1068	1118	1168	1218	1268	1318	1368						
H	0	0	0	0	0	1	1	1	1	1	2	2	2	2	3	3	3	3	4	4	4	4	5	5	5						
J	33	83	133	183	233	283	333	383	433	483	533	583	633	683	733	783	833	883	933	983	1033	1083	1133	1183	1233						
K	10	10	10	10	10	10	12	12	12	12	14	14	14	14	16	16	16	16	18	18	18	18	20	20	20						
Mass (kg)	9.8	10.7	11.6	12.5	13.3	14.2	15.0	15.9	16.8	17.7	18.5	19.4	20.2	21.1	22.0	22.9	23.7	24.6	25.4	26.3	27.2	28.1	28.9	29.8	30.6						
Maximum speed (mm/s)	Lead 40																				2400										
	Lead 20																				1200										
	Lead 10																				600										

Applicable Controller Specifications

Applicable Controller	Maximum number of controlled axes	Connectable encoder type	Operating method	Power-supply voltage	Reference page
X-SEL-P/Q	6 axes	Absolute/ incremental	Program	Single-/three-phase 200 VAC	→P56
X-SEL-J/K	4 axes			Single-phase 100/200 VAC	→P56
SSEL	2 axes			Single-phase 200 VAC	→P56
SCON	1 axis		Positioner pulse train control	→P56	



(Note 1) Refer to P. 9 for the relationship of acceleration and payload.
(Notes 2, 3, 4) The values in [] apply to the ISPB series. Other specification values apply commonly to the ISB and ISPB.
(Note 5) When the traveling life is 10,000km.
(Note 6) The value of dynamic straightness is when the high straightness, precision specification (option) is specified.
(Note 7) The maximum cable length is 30m. Specify a desired length in meters. (Example. X08 = 8m)

25

ISB-LXM-400/ISPB-LXM-400

Sold & Serviced By:
ELECTROMATE

Toll Free Phone (877) SERV098
Toll Free Fax (877) SERV099
www.electromate.com
sales@electromate.com

ISB-LXL-200

Single-axis robot/Large, X-axis, long slider type/Actuator width: 150mm/200W Straight shape

ISPB-LXL-200

Single-axis robot/Large, X-axis, long slider type/Actuator width: 150mm/200W Straight shape **High precision specification**



Model Specification Items

Series	LXL	Type	Encoder type	Motor type	Lead	Stroke	Applicable controller	Cable length	Options
ISB: Standard specification ISPB: High precision specification			A: Absolute specification I: Incremental specification	200: 200W	40: 40mm 20: 20mm 10: 10mm	120: 120mm 1270: 1270mm (in 50mm increments)	T1: XSEL-J/K T2: SCON SSEL XSEL-P/Q	N: None S: 3m M: 5m X□: Specified length	Refer to the options table below.

* Refer to P. 10 for the details of items comprising the model number.

Model Number/Specification

*1.0G=9800mm/sec²

Model number	Encoder type	Motor output (W)	Lead (mm)	Stroke in 50mm increments (mm)	Speed (mm/s)	Acceleration (Note 1)				Payload (Note 1)				Rated thrust (N)
						Horizontal (G)		Vertical (G)		Horizontal (kg)		Vertical (kg)		
						Rated	Maximum	Rated	Maximum	Rated acceleration	Maximum acceleration	Rated acceleration	Maximum acceleration	
ISB[ISPB]-LXL-[1]-200-40-[2]-[3]-[4]-[5]	Absolute Incremental	200	40	100~1270	1~2400	0.4	1.2	0.4	1.2	15	6	4	1.6	85.5
ISB[ISPB]-LXL-[1]-200-20-[2]-[3]-[4]-[5]			20		1~1200	0.4	1.2	0.4	1	45	12	10	5	170.9
ISB[ISPB]-LXL-[1]-200-10-[2]-[3]-[4]-[5]			10		1~600	0.4	0.7	0.4	0.6	90	40	20	14	341.8

*In the above model numbers, [1] indicates the encoder type, [2] indicates the stroke, [3] indicates the applicable controller, [4] indicates the cable length, and [5] indicates the option(s).

Option

Name	Model number	Reference page	Name	Model number	Reference page
Cable exit from the left	A1S	→P11	Home limit switch	L	→P11
Cable exit from the rear left	A1E	→P11	Home limit switch on the opposite side	LL	→P11
Cable exit from the right	A3S	→P11	Master axis specification	LM	→P12
Cable exit from the rear right	A3E	→P11	Master axis specification (sensor on the opposite side)	LLM	→P12
AQ seal (standard feature)	AQ	→P11	Non-motor side specification	NM	→P12
Brake	B	→P11	Slave axis specification	S	→P12
Creep sensor	C	→P11	High straightness, precision specification	ST	→P13
Creep sensor on the opposite side	CL	→P11			

Common Specifications

Positioning repeatability (Note 2)	±0.01mm [±0.005mm]
Drive method (Note 3)	Ball screw Ø20mm, rolled C10 [equivalent to rolled C5]
Lost Motion (Note 4)	0.05mm [0.02mm] max.
Dynamic allowable load moment (Note 5)	Ma: 137.8N·m Mb: 196.8N·m Mc: 278.5N·m
Overhang load length	Ma direction: 900mm max. Mb, Mc directions: 900mm max.
Dynamic straightness (Note 6)	0.02mm/m max.
Base	Material: Aluminum, with white alumite treatment
Applicable controller	T1: XSEL-J/K T2: XSEL-P/Q, SSEL, SCON
Cable length (Note 7)	N: None, S: 3m, M: 5m, X□: Specified length
Ambient operating temperature/humidity	0 to 40°C, 85%RH max. (non-condensing)

Diagram

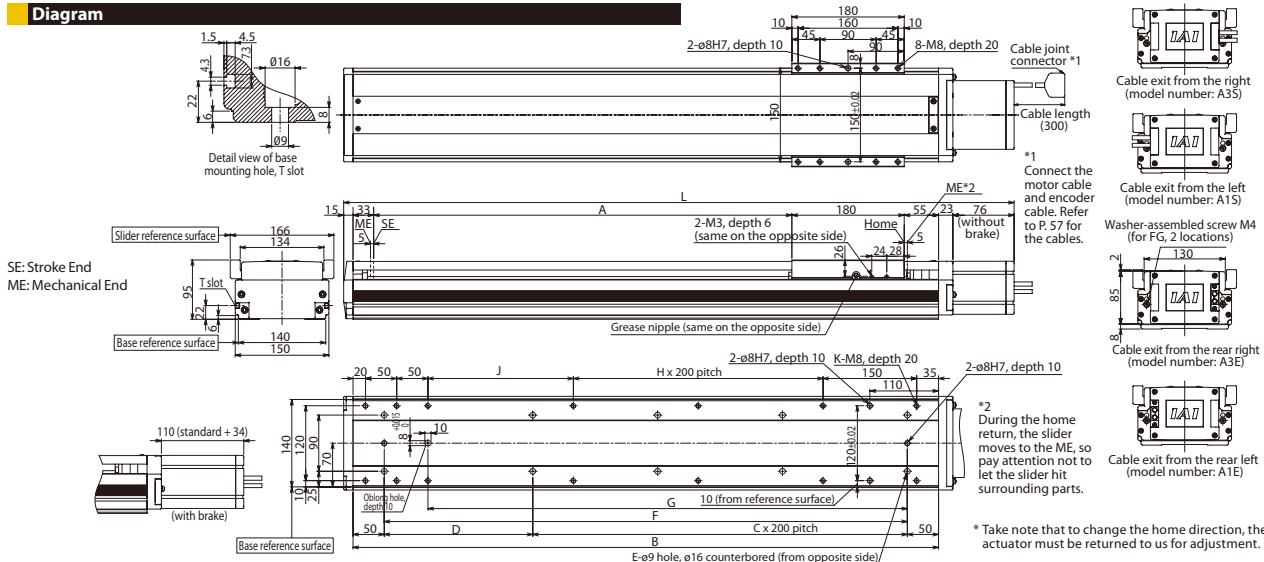

Dimensions, Mass and Maximum Speed by Stroke

Stroke	120	170	220	270	320	370	420	470	520	570	620	670	720	770	820	870	920	970	1020	1070	1120	1170	1220	1270	
L	without brake	502	552	602	652	702	752	802	852	902	952	1002	1052	1102	1152	1202	1252	1302	1352	1402	1452	1502	1552	1602	1652
	with brake	536	586	636	686	736	786	836	886	936	986	1036	1086	1136	1186	1236	1286	1336	1386	1436	1486	1536	1586	1636	1686
A	120	170	220	270	320	370	420	470	520	570	620	670	720	770	820	870	920	970	1020	1070	1120	1170	1220	1270	
B	388	438	488	538	588	638	688	738	788	838	888	938	988	1038	1088	1138	1188	1238	1288	1338	1388	1438	1488	1538	
C	0	1	1	1	1	2	2	2	2	3	3	3	3	4	4	4	4	5	5	5	5	6	6	6	
D	288	338	388	438	488	538	588	638	688	738	788	838	888	938	988	1038	1088	1138	1188	1238	1288	1338	1388	1438	
E	4	6	6	6	6	8	8	8	8	10	10	10	10	12	12	12	12	14	14	14	14	16	16	16	
F	288	338	388	438	488	538	588	638	688	738	788	838	888	938	988	1038	1088	1138	1188	1238	1288	1338	1388	1438	
G	218	268	318	368	418	468	518	568	618	668	718	768	818	868	918	968	1018	1068	1118	1168	1218	1268	1318	1368	
H	0	0	0	0	0	1	1	1	1	2	2	2	2	3	3	3	3	4	4	4	4	5	5	5	
J	83	133	183	233	283	333	383	433	483	533	583	633	683	733	783	833	883	933	983	1033	1083	1133	1183	1233	
K	10	10	10	10	10	12	12	12	12	14	14	14	14	16	16	16	16	18	18	18	18	20	20	20	
Mass (kg)	9.8	10.7	11.5	12.4	13.2	14.1	15.0	15.9	16.7	17.6	18.4	19.3	20.2	21.1	21.9	22.8	23.6	24.5	25.4	26.3	27.1	28.0	28.8	29.7	
Maximum speed (mm/s)	Lead 40	2400																							
	Lead 20	1200																							
	Lead 10	600																							

*If the brake is equipped, the mass increases by 0.6kg.

*The maximum speed (mm/s) varies depending on the stroke.

Applicable Controller Specifications

Applicable Controller	Maximum number of controlled axes	Connectable encoder type	Operating method	Power-supply voltage	Reference page
X-SEL-P/Q	6 axes	Absolute/ incremental	Program	Single/three-phase 200 VAC	→P56
X-SEL-J/K	4 axes			→P56	
SSEL	2 axes			Single-phase 100/200 VAC	→P56
SCON	1 axis			Positioner pulse train control	→P56



(Note 1) Refer to P. 9 for the relationship of acceleration and payload. The values in [] apply to the ISPB series. Other specification values apply commonly to the ISB and ISPB.

(Note 5) When the traveling life is 10,000km.

(Note 6) The value of dynamic straightness is when the high straightness, precision specification (option) is specified.

(Note 7) The maximum cable length is 30m. Specify a desired length in meters. (Example. X08 = 8m)

ISB-LXL-200/ISPB-LXL-200

ISB-LXL-400

Single-axis robot/Large, X-axis, long slider type/Actuator width: 150mm/400W

ISPB-LXL-400

Single-axis robot/Large, X-axis, long slider type/Actuator width: 150mm/400W Straight shape **High precision specification**

Model Specification Items

Series	Type	Encoder type	Motor type	Lead	Stroke	Applicable controller	Cable length	Options
ISB: Standard specification ISPB: High precision specification	LXL	A: Absolute specification I: Incremental specification	400: 400W 40: 40mm 20: 20mm 10: 10mm	120: 120mm (in 50mm increments)	T1: XSEL-J/K T2: SCON SSEL XSEL-P/Q	N: None S: 3m M: 5m X□□: Specified length	Refer to the options table below.	



* Refer to P. 10 for the details of items comprising the model number.

Model Number/Specification

Model number	Encoder type	Motor output (W)	Lead (mm)	Stroke in 50mm increments (mm)	Speed (mm/s)	Acceleration (Note 1)				Payload (Note 1)				Rated thrust (N)
						Horizontal (G)		Vertical (G)		Horizontal (kg)		Vertical (kg)		
						Rated	Maximum	Rated	Maximum	Rated acceleration	Maximum acceleration	Rated acceleration	Maximum acceleration	
ISB[ISPB]-LXL-①-400-40-②-③-④-⑤	Absolute/Incremental	400	40	100~1270	1~2400	0.4	1.2	0.4	1.2	40	15	10	4	169.6
ISB[ISPB]-LXL-①-400-20-②-③-④-⑤			20		1~1200	0.4	1.2	0.4	1	90	24	20	10	339.1
ISB[ISPB]-LXL-①-400-10-②-③-④-⑤			10		1~600	0.4	0.7	0.4	0.6	120	60	40	30	678.3

* In the above model numbers, ① indicates the encoder type, ② indicates the stroke, ③ indicates the applicable controller, ④ indicates the cable length, and ⑤ indicates the option(s).

Option

Name	Model number	Reference page	Name	Model number	Reference page
Cable exit from the left	A1S	→P11	Home limit switch	L	→P11
Cable exit from the rear left	A1E	→P11	Home limit switch on the opposite side	LL	→P11
Cable exit from the right	A3S	→P11	Master axis specification	LM	→P12
Cable exit from the rear right	A3E	→P11	Master axis specification (sensor on the opposite side)	LLM	→P12
AQ seal (standard feature)	AQ	→P11	Non-motor side specification	NM	→P12
Brake	B	→P11	Slave axis specification	S	→P12
Creep sensor	C	→P11	High straightness, precision specification	ST	→P13
Creep sensor on the opposite side	CL	→P11			

Common Specifications

Positioning repeatability (Note 2)	±0.01mm [±0.005mm]
Drive method (Note 3)	Ball screw Ø20mm, rolled C10 [equivalent to rolled C5]
Lost Motion (Note 4)	0.05mm [0.02mm] max.
Dynamic allowable load moment (Note 5)	Ma: 137.8N·m Mb: 196.8N·m Mc: 278.5N·m
Overhang load length	Ma direction: 900mm max. Mb, Mc directions: 900mm max.
Dynamic straightness (Note 6)	0.02mm/m max.
Base	Material: Aluminum, with white alumite treatment
Applicable controller	T1: XSEL-J/K T2: XSEL-P/Q, SSEL, SCON
Cable length (Note 7)	N: None, S: 3m, M: 5m, X□□: Specified length
Ambient operating temperature/humidity	0 to 40°C, 85%RH max. (non-condensing)

Diagram

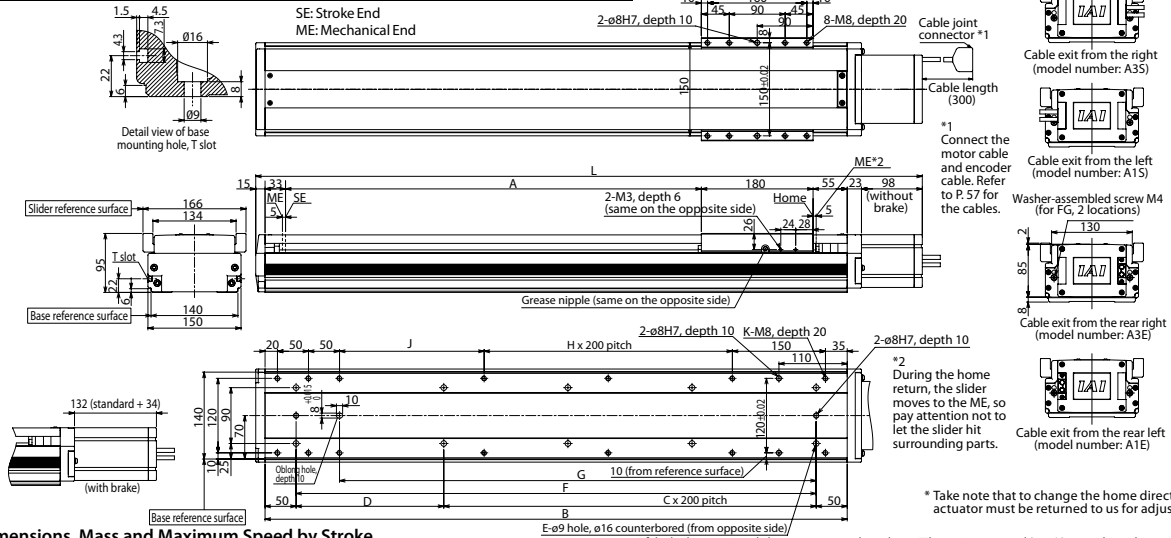

Dimensions, Mass and Maximum Speed by Stroke

Stroke	L																												
	120	170	220	270	320	370	420	470	520	570	620	670	720	770	820	870	920	970	1020	1070	1120	1170	1220	1270					
without brake	524	574	624	674	724	774	824	874	924	974	1024	1074	1124	1174	1224	1274	1324	1374	1424	1474	1524	1574	1624	1674					
with brake	558	608	658	708	758	808	858	908	958	1008	1058	1108	1158	1208	1258	1308	1358	1408	1458	1508	1558	1608	1658	1708					
A	120	170	220	270	320	370	420	470	520	570	620	670	720	770	820	870	920	970	1020	1070	1120	1170	1220	1270					
B	388	438	488	538	588	638	688	738	788	838	888	938	988	1038	1088	1138	1188	1238	1288	1338	1388	1438	1488	1538					
C	0	1	1	1	1	2	2	2	2	3	3	3	4	4	4	4	4	5	5	5	5	6	6	6					
D	288	338	388	438	488	538	588	638	688	738	788	838	888	938	988	1038	1088	1138	1188	1238	1288	1338	1388	1438					
E	4	6	6	6	6	8	8	8	8	10	10	10	10	12	12	12	12	14	14	14	14	16	16	16					
F	288	338	388	438	488	538	588	638	688	738	788	838	888	938	988	1038	1088	1138	1188	1238	1288	1338	1388	1438					
G	218	268	318	368	418	468	518	568	618	668	718	768	818	868	918	968	1018	1068	1118	1168	1218	1268	1318	1368					
H	0	0	0	0	0	1	1	1	1	2	2	2	2	3	3	3	3	4	4	4	4	5	5	5					
J	83	133	183	233	283	333	383	433	483	533	583	633	683	733	783	833	883	933	983	1033	1083	1133	1183	1233					
K	10	10	10	10	10	12	12	12	12	14	14	14	14	16	16	16	16	18	18	18	18	20	20	20					
Mass (kg)	10.2	11.1	12.0	12.9	13.7	14.6	15.4	16.3	17.2	18.1	18.9	19.8	20.6	21.5	22.4	23.3	24.1	25.0	25.8	26.7	27.6	28.5	29.3	30.2					
Maximum speed (mm/s)	Lead 40											2400										1840		1530		1100		880	
	Lead 20											1200										920		765		550		440	
	Lead 10											600										460		380		270		220	

Applicable Controller Specifications

Applicable Controller	Maximum number of controlled axes	Connectable encoder type	Operating method	Power-supply voltage	Reference page
X-SEL-P/Q	6 axes	Absolute/Incremental	Program	Single-/three-phase 200 VAC	→P56
X-SEL-J/K	4 axes			Single-phase 100/200 VAC	→P56
SSEL	2 axes			Single-phase 100/200 VAC	→P56
SCON	1 axis		Positioner pulse train control	Single-phase 200 VAC	→P56



(Note 1) Refer to P. 9 for the relationship of acceleration and payload. (Notes 2, 3, 4) The values in [] apply to the ISPB series. Other specification values apply commonly to the ISB and ISPB.
(Note 5) When the traveling life is 10,000k.
(Note 6) The value of dynamic straightness is when the high straightness, precision specification (option) is specified.
(Note 7) The maximum cable length is 30m. Specify a desired length in meters. (Example. X08 = 8m)

27

ISB-LXL-400/ISPB-LXL-400

ISB-LXMX-200

Single-axis robot/Large, X-axis, mid-support type/Actuator width: 150mm/200W Straight shape

ISPB-LXMX-200

Single-axis robot/Large, X-axis, mid-support type/Actuator width: 150mm/200W Straight shape **High precision specification**



Model Specification Items

Series	Type	Encoder type	Motor type	Lead	Stroke	Applicable controller	Cable length	Options
ISB: Standard specification ISPB: High precision specification	LXMX 200	A: Absolute specification I: Incremental specification	200: 200W 20: 20mm	1000: 1000mm 2500: 2500mm (in 100mm increments)	T1: XSEL-J/K T2: SCON SSEL XSEL-P/Q	N: None S: 3m M: 5m X□□: Specified length	Refer to the options table below.	

* Refer to P. 10 for the details of items comprising the model number.

Model Number/Specification

Model number	Encoder type	Motor output (W)	Lead (mm)	Stroke in 100mm increments (mm)	Speed (mm/s)	Acceleration (Note 1)				Payload (Note 1)				Rated thrust (N)
						Horizontal (G)		Vertical (G)		Horizontal (kg)		Vertical (kg)		
						Rated	Maximum	Rated	Maximum	Rated acceleration	Maximum acceleration	Rated acceleration	Maximum acceleration	
ISB[ISPB]-LXMX-[1]-200-20-[2]-[3]-[4]-[5]	Absolute Incremental	200	20	1000~2500	1~1200	0.4		Designed exclusively for horizontal use		45		Designed exclusively for horizontal use	170.9	

*In the above model numbers, [1] indicates the encoder type, [2] indicates the stroke, [3] indicates the applicable controller, [4] indicates the cable length, and [5] indicates the option(s).

Option

Name	Model number	Reference page	Name	Model number	Reference page
Cable exit from the left	A1S	→P11	Home limit switch	L	→P11
Cable exit from the rear left	A1E	→P11	Home limit switch on the opposite side	LL	→P11
Cable exit from the right	A3S	→P11	Master axis specification	LM	→P12
Cable exit from the rear right	A3E	→P11	Master axis specification (sensor on the opposite side)	LLM	→P12
AQ seal (standard feature)	AQ	→P11	Non-motor side specification	NM	→P12
Brake	B	→P11	Guide with ball retention mechanism	RT	→P12
Creep sensor	C	→P11	Slave axis specification	S	→P12
Creep sensor on the opposite side	CL	→P11	High straightness, precision specification	ST	→P13

Common Specifications

Positioning repeatability (Note 2)	±0.01mm (±0.005mm)
Drive method (Note 3)	Ball screw Ø20mm, rolled C10 [equivalent to rolled C5]
Lost Motion (Note 4)	0.05mm [0.02mm] max.
Dynamic allowable load moment (Note 5)	Ma: 104.9N·m Mb: 149.9N·m Mc: 248.9N·m
Overhang load length	Ma direction: 750mm max. Mb, Mc directions: 750mm max.
Dynamic straightness (Note 6)	0.02mm/m max.
Base	Material: Aluminum, with white alumite treatment
Applicable controller	T1: XSEL-J/K T2: XSEL-P/Q, SSEL, SCON
Cable length (Note 7)	N: None, S: 3m, M: 5m, X□□: Specified length
Ambient operating temperature/humidity	0 to 40°C, 85%RH max. (non-condensing)

Diagram

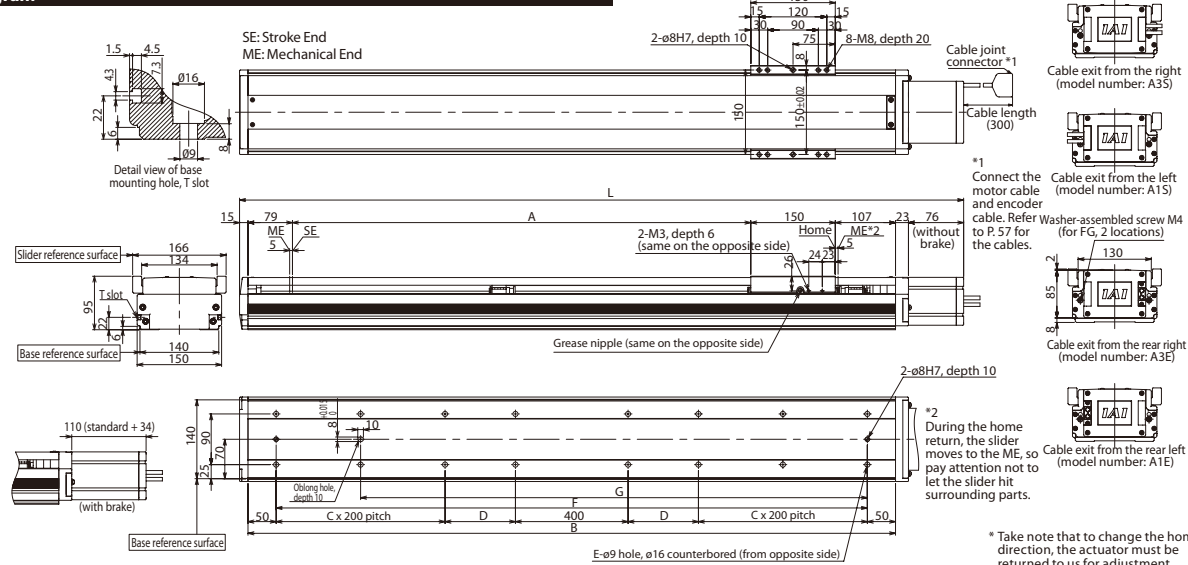

Dimensions, Mass and Maximum Speed by Stroke

*If the brake is equipped, the mass increases by 0.6kg. *The maximum speed (mm/s) varies depending on the stroke.

L	Stroke	1000	1100	1200	1300	1400	1500	1600	1700	1800	1900	2000	2100	2200	2300	2400	2500
	without brake	1464	1564	1664	1764	1864	1964	2064	2164	2264	2364	2464	2564	2664	2764	2864	2964
with brake	1498	1598	1698	1798	1898	1998	2098	2198	2298	2398	2498	2598	2698	2798	2898	2998	
A	1014	1114	1214	1314	1414	1514	1614	1714	1814	1914	2014	2114	2214	2314	2414	2514	
B	1350	1450	1550	1650	1750	1850	1950	2050	2150	2250	2350	2450	2550	2650	2750	2850	
C	1	1	1	1	1	1	1	1	2	2	2	2	3	3	3	3	
D	225	275	325	375	425	475	525	575	625	675	725	775	825	875	925	975	
E	12	12	12	12	12	12	12	12	16	16	16	16	20	20	20	20	
F	1250	1350	1450	1550	1650	1750	1850	1950	2050	2150	2250	2350	2450	2550	2650	2750	
G	1050	1150	1250	1350	1450	1550	1650	1750	1850	1950	2050	2150	2250	2350	2450	2550	
Mass (kg)	27.3	29.0	30.8	32.5	34.3	36.1	37.8	39.6	41.3	43.1	44.8	46.6	48.3	50.1	51.8	53.6	
Maximum speed (mm/s)																	
Lead 20		1200		1150	1000	950	830	740	650	590	540	490	440	410	370	340	

Applicable Controller Specifications

Applicable Controller	Maximum number of controlled axes	Connectable encoder type	Operating method	Power-supply voltage	Reference page
X-SEL-P/Q	6 axes	Absolute/incremental	Program	Single/three-phase 200 VAC	→P56
X-SEL-J/K	4 axes			Single-phase 100/200 VAC	→P56
SSEL	2 axes			Positioner pulse train control	→P56
SCON	1 axis				→P56

CAUTION

(Note 1) Refer to P. 9 for the relationship of acceleration and payload. (Notes 2, 3, 4) The values in [] apply to the ISPB series. Other specification values apply commonly to the ISB and ISPB.

(Note 5) When the traveling life is 10,000km.

(Note 6) The value of dynamic straightness is when the high straightness, precision specification (option) is specified.

(Note 7) The maximum cable length is 30m. Specify a desired length in meters. (Example. X08 = 8m)

ISB-LXMX-200/ISPB-LXMX-200

ISB-LXMX-400

Single-axis robot/Large, X-axis, mid-support type/Actuator width: 150mm/400W Straight shape

ISPB-LXMX-400

Single-axis robot/Large, X-axis, mid-support type/Actuator width: 150mm/400W Straight shape **High precision specification**



Model Specification Items	Series	Type	Encoder type	Motor type	Lead	Stroke	Applicable controller	Cable length	Options
	ISB: Standard specification ISPB: High precision specification	LXMX	400	A: Absolute specification I: Incremental specification	400: 400W 40: 40mm 20: 20mm	1000: 1000mm 2500: 2500mm (in 100mm increments)	T1: XSEL-J/K T2: SCON SSEL XSEL-P/Q	N: None S: 3m M: 5m X□□: Specified length	Refer to the options table below.

* Refer to P. 10 for the details of items comprising the model number.

Model Number/Specification

Model number	Encoder type	Motor output (W)	Lead (mm)	Stroke in 100mm increments (mm)	Speed (mm/s)	Acceleration (Note 1)				Payload (Note 1)				Rated thrust (N)
						Horizontal (G)		Vertical (G)		Horizontal (kg)		Vertical (kg)		
						Rated	Maximum	Rated	Maximum	Rated acceleration	Maximum acceleration	Rated acceleration	Maximum acceleration	
ISB[ISPB]-LXMX-①-400-40-②-③-④-⑤	Absolute	400	40	1000~2500	1~2400	0.4		Designed exclusively for horizontal use		40		Designed exclusively for horizontal use	169.6	
ISB[ISPB]-LXMX-①-400-20-②-③-④-⑤	Incremental		20		1~1200	0.4				90			339.1	

* In the above model numbers, ① indicates the encoder type, ② indicates the stroke, ③ indicates the applicable controller, ④ indicates the cable length, and ⑤ indicates the option(s).

Option

Name	Model number	Reference page	Name	Model number	Reference page
Cable exit from the left	A1S	→P11	Home limit switch	L	→P11
Cable exit from the rear left	A1E	→P11	Home limit switch on the opposite side	LL	→P11
Cable exit from the right	A3S	→P11	Master axis specification	LM	→P12
Cable exit from the rear right	A3E	→P11	Master axis specification (sensor on the opposite side)	LLM	→P12
AQ seal (standard feature)	AQ	→P11	Non-motor side specification	NM	→P12
Brake	B	→P11	Guide with ball retention mechanism	RT	→P12
Creep sensor	C	→P11	Slave axis specification	S	→P12
Creep sensor on the opposite side	CL	→P11	High straightness, precision specification	ST	→P13

Common Specifications

Positioning repeatability (Note 2)	±0.01mm [±0.005mm]
Drive method (Note 3)	Ball screw Ø20mm, rolled C10 [equivalent to rolled C5]
Lost Motion (Note 4)	0.05mm [0.02mm] max.
Dynamic allowable load moment (Note 5)	Ma: 104.9N·m Mb: 149.9N·m Mc: 248.9N·m
Overhang load length	Ma direction: 750mm max. Mb, Mc directions: 750mm max.
Dynamic straightness (Note 6)	0.02mm/m max.
Base	Material: Aluminum, with white alumite treatment
Applicable controller	T1: XSEL-J/K T2: XSEL-P/Q SSEL, SCON
Cable length (Note 7)	N: None, S: 3m, M: 5m, X□□: Specified length
Ambient operating temperature/humidity	0 to 40°C, 85%RH max. (non-condensing)

Diagram

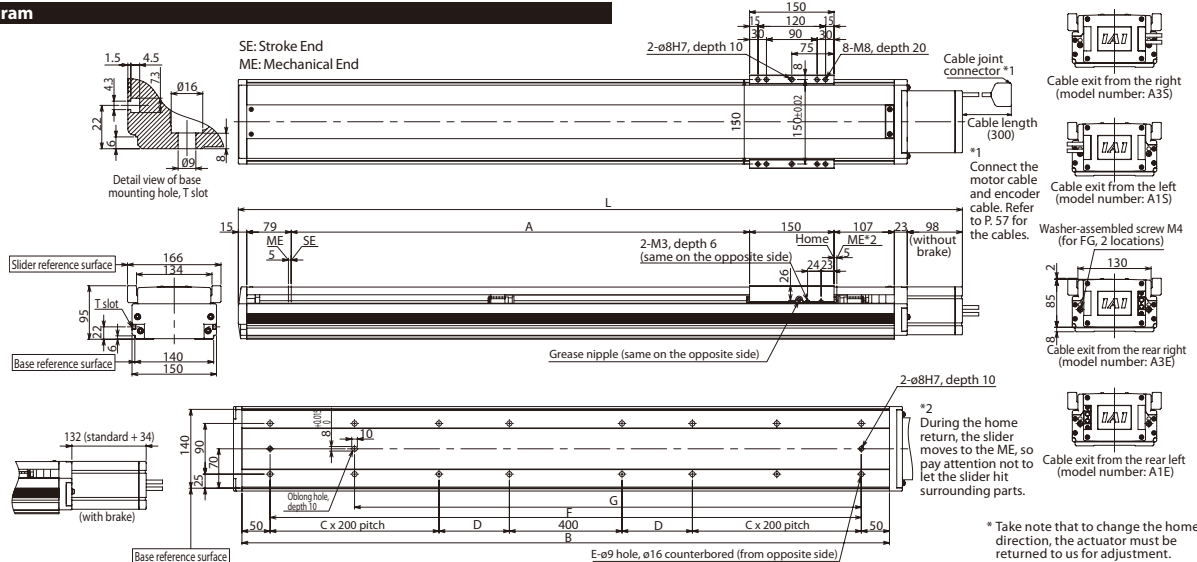

Dimensions, Mass and Maximum Speed by Stroke

*If the brake is equipped, the mass increases by 0.6kg. *The maximum speed (mm/s) varies depending on the stroke.

Stroke	Mass (kg)												Maximum speed (mm/s)						
	1000	1100	1200	1300	1400	1500	1600	1700	1800	1900	2000	2100	2200	2300	2400	2500	Lead 40	Lead 20	
L	without brake	1486	1586	1686	1786	1886	1986	2086	2186	2286	2386	2486	2586	2686	2786	2886	2986		
	with brake	1520	1620	1720	1820	1920	2020	2120	2220	2320	2420	2520	2620	2720	2820	2920	3020		
A	1014	1114	1214	1314	1414	1514	1614	1714	1814	1914	2014	2114	2214	2314	2414	2514			
B	1350	1450	1550	1650	1750	1850	1950	2050	2150	2250	2350	2450	2550	2650	2750	2850			
C	1	1	1	1	1	1	1	1	2	2	2	2	3	3	3	3			
D	225	275	325	375	425	475	525	575	625	675	725	775	825	875	925	975			
E	12	12	12	12	12	12	12	12	16	16	16	16	20	20	20	20			
F	1250	1350	1450	1550	1650	1750	1850	1950	2050	2150	2250	2350	2450	2550	2650	2750			
G	1050	1150	1250	1350	1450	1550	1650	1750	1850	1950	2050	2150	2250	2350	2450	2550			
Mass (kg)	27.7	29.5	31.3	33.0	34.8	36.5	38.3	40.0	41.8	43.5	45.3	47.0	48.8	50.6	52.3	54.1			
Maximum speed (mm/s)	Lead 40	2400		2300	2000	1900	1660	1480	1300	1180	1080	980	880	820	740	680			
	Lead 20	1200		1150	1000	950	830	740	650	590	540	490	440	410	370	340			

Applicable Controller Specifications

Applicable Controller	Maximum number of controlled axes	Connectable encoder type	Operating method	Power-supply voltage	Reference page
X-SEL-P/Q	6 axes	Absolute/ incremental	Program	Single-/three-phase 200 VAC	→P56
X-SEL-J/K	4 axes			Single-phase 100/200 VAC	→P56
SSEL	2 axes			Single-phase 200 VAC	→P56
SCON	1 axis		Positioner pulse train control	→P56	



(Note 1) Refer to P. 9 for the relationship of acceleration and payload. (Notes 2, 3, 4) The values in [] apply to the ISPB series. Other specification values apply commonly to the ISB and ISPB.

(Note 5) When the traveling life is 10,000km.

(Note 6) The value of dynamic straightness is when the high straightness, precision specification (option) is specified.

(Note 7) The maximum cable length is 30m. Specify a desired length in meters. (Example. X08 = 8m)

29

ISB-LXMX-400/ISPB-LXMX-400

Sold & Serviced By: **ELECTROMATE**

Toll Free Phone (877) SERV098
Toll Free Fax (877) SERV099
www.electromate.com
sales@electromate.com

ISB-LXUWX-200

Single-axis robot/Large, X-axis, mid-support, double-slider type/
Actuator width: 150mm/200W Straight shape

ISPB-LXUWX-200

Single-axis robot/Large, X-axis, mid-support, double-slider type/Actuator
width: 150mm/200W Straight shape **High precision specification**



Model Specification Items

Series	Type	Encoder type	Motor type	Lead	Stroke	Applicable controller	Cable length	Options
ISB: Standard specification ISPB: High precision specification	LXUWX	A: Absolute specification I: Incremental specification	200: 200W 20: 20mm	1000: 1000mm 2500: 2500mm (in 100mm increments)	T1: XSEL-J/K T2: SCON SSEL XSEL-P/Q	N: None S: 3m M: 5m X□□: Specified length	Refer to the options table below.	

* Refer to P. 10 for the details of items comprising the model number.

Model Number/Specification

Model number	Encoder type	Motor output (W)	Lead (mm)	Stroke in 100mm increments (mm)	Speed (mm/s)	Acceleration (Note 1)				Payload (Note 1)				Rated thrust (N)
						Horizontal (G)		Vertical (G)		Horizontal (kg)		Vertical (kg)		
						Rated	Maximum	Rated	Maximum	Rated acceleration	Maximum acceleration	Rated acceleration	Maximum acceleration	
ISB[ISPB]-LXUWX- [1] -200-20- [2] - [3] - [4] - [5]	Absolute Incremental	200	20	1000~2500	1~1200	0.4		Designed exclusively for horizontal use		45		Designed exclusively for horizontal use	170.1	

*In the above model numbers, [1] indicates the encoder type, [2] indicates the stroke, [3] indicates the applicable controller, [4] indicates the cable length, and [5] indicates the option(s).

Option

Name	Model number	Reference page	Name	Model number	Reference page
Cable exit from the left	A1S	→P11	Home limit switch	L	→P11
Cable exit from the rear left	A1E	→P11	Home limit switch on the opposite side	LL	→P11
Cable exit from the right	A3S	→P11	Master axis specification	LM	→P12
Cable exit from the rear right	A3E	→P11	Master axis specification (sensor on the opposite side)	LLM	→P12
AQ seal (standard feature)	AQ	→P11	Non-motor side specification	NM	→P12
Brake	B	→P11	Guide with ball retention mechanism	RT	→P12
Creep sensor	C	→P11	Slave axis specification	S	→P12
Creep sensor on the opposite side	CL	→P11	High straightness, precision specification	ST	→P13

Common Specifications

Positioning repeatability (Note 2)	±0.01mm (±0.005mm)
Drive method (Note 3)	Ball screw Ø20mm, rolled C10 [equivalent to rolled C5]
Lost Motion (Note 4)	0.05mm [0.02mm] max.
Dynamic allowable load moment (Note 5)	Ma: 179.3N·m Mb: 254.8N·m Mc: 247.0N·m
Overhang load length	Ma direction: 1250mm max. Mb, Mc directions: 1250mm max.
Dynamic straightness (Note 6)	0.02mm/m max.
Base	Material: Aluminum, with white alumite treatment
Applicable controller	T1: XSEL-J/K T2: XSEL-P/Q, SSEL, SCON
Cable length (Note 7)	N: None, S: 3m, M: 5m, X□□: Specified length
Ambient operating temperature/humidity	0 to 40°C, 85%RH max. (non-condensing)

Diagram

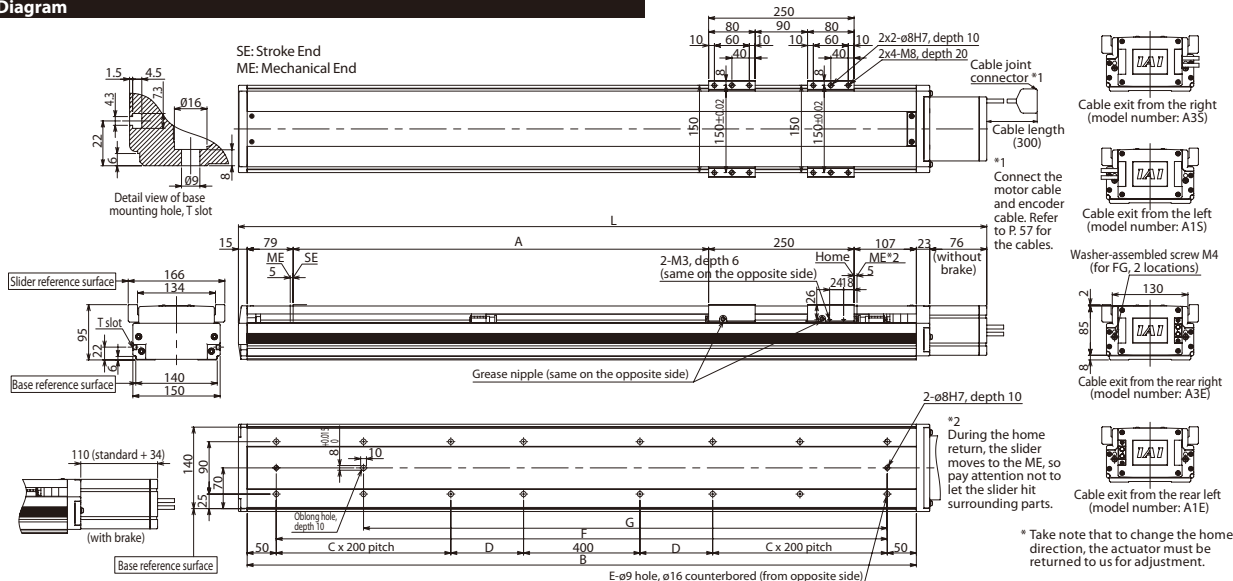

Dimensions, Mass and Maximum Speed by Stroke

Stroke	*If the brake is equipped, the mass increases by 0.6kg. *The maximum speed (mm/s) varies depending on the stroke.																
	1000	1100	1200	1300	1400	1500	1600	1700	1800	1900	2000	2100	2200	2300	2400	2500	
L	without brake	1564	1664	1764	1864	1964	2064	2164	2264	2364	2464	2564	2664	2764	2864	2964	3064
	with brake	1598	1698	1798	1898	1998	2098	2198	2298	2398	2498	2598	2698	2798	2898	2998	3098
A	1014	1114	1214	1314	1414	1514	1614	1714	1814	1914	2014	2114	2214	2314	2414	2514	
B	1450	1550	1650	1750	1850	1950	2050	2150	2250	2350	2450	2550	2650	2750	2850	2950	
C	1	1	1	1	1	1	1	2	2	2	2	3	3	3	3	3	
D	275	325	375	425	475	525	575	625	675	725	775	825	875	925	975	1025	
E	12	12	12	12	12	12	12	16	16	16	16	20	20	20	20	20	
F	1350	1450	1550	1650	1750	1850	1950	2050	2150	2250	2350	2450	2550	2650	2750	2850	
G	1150	1250	1350	1450	1550	1650	1750	1850	1950	2050	2150	2250	2350	2450	2550	2650	
Mass (kg)	30.4	32.1	33.9	35.6	37.4	39.1	40.9	42.6	44.4	46.1	47.9	49.7	51.4	53.2	54.9	56.7	
Maximum speed (mm/s) Lead 20		1200		1150	1000	950	830	740	650	590	540	490	440	410	370	340	

Applicable Controller Specifications

Applicable Controller	Maximum number of controlled axes	Connectable encoder type	Operating method	Power-supply voltage	Reference page
X-SEL-P/Q	6 axes	Absolute/ incremental	Program	Single/three-phase 200 VAC	→P56
X-SEL-J/K	4 axes			Single-phase 100/200 VAC	→P56
SSEL	2 axes			→P56	
SCON	1 axis			Positioner pulse train control	→P56



(Note 1) Refer to P. 9 for the relationship of acceleration and payload. The values in [] apply to the ISPB series. Other specification values apply commonly to the ISB and ISPB.
 (Note 2, 3, 4)
 (Note 5) When the traveling life is 10,000km.
 (Note 6) The value of dynamic straightness is when the high straightness, precision specification (option) is specified.
 (Note 7) The maximum cable length is 30m. Specify a desired length in meters. (Example. X08 = 8m)

ISB-LXUWX-200/ISPB-LXUWX-200

30

Sold & Serviced By:

ELECTROMATE

Toll Free Phone (877) SERV098

Toll Free Fax (877) SERV099

www.electromate.com

sales@electromate.com

ISB-LXUWX-400

Single-axis robot/Large, X-axis, mid-support, double-slider type/
Actuator width: 150mm/400W Straight shape

ISPB-LXUWX-400

Single-axis robot/Large, X-axis, mid-support, double-slider type/Actuator
width: 150mm/400W Straight shape **High precision specification**



Model Specification Items	Series	Type	Encoder type	Motor type	Lead	Stroke	Applicable controller	Cable length	Options
	ISB: Standard specification ISPB: High precision specification	LXUWX	400	A: Absolute specification I: Incremental specification	400: 400W 40: 40mm 20: 20mm	1000: 1000mm (in 100mm increments) 2500: 2500mm	T1: XSEL-J/K T2: SCON SSEL XSEL-P/Q	N: None S: 3m M: 5m X□□: Specified length	Refer to the options table below.

* Refer to P. 10 for the details of items comprising the model number.

Model Number/Specification

Model number	Encoder type	Motor output (W)	Lead (mm)	Stroke in 100mm increments (mm)	Speed (mm/s)	Acceleration (Note 1)				Payload (Note 1)				Rated thrust (N)
						Horizontal (G)		Vertical (G)		Horizontal (kg)		Vertical (kg)		
						Rated	Maximum	Rated	Maximum	Rated acceleration	Maximum acceleration	Rated acceleration	Maximum acceleration	
ISB[ISPB]-LXUWX-①-400-40-②-③-④-⑤	Absolute	400	40	1000~2500	1~2400	0.4		Designed exclusively for horizontal use		40		Designed exclusively for horizontal use	169.6	
ISB[ISPB]-LXUWX-①-400-20-②-③-④-⑤	Incremental		20		1~1200	0.4				90			339.1	

*1.0G=9800mm/sec²
* In the above model numbers, ① indicates the encoder type, ② indicates the stroke, ③ indicates the applicable controller, ④ indicates the cable length, and ⑤ indicates the option(s).

Option

Name	Model number	Reference page	Name	Model number	Reference page
Cable exit from the left	A1S	→P11	Home limit switch	L	→P11
Cable exit from the rear left	A1E	→P11	Home limit switch on the opposite side	LL	→P11
Cable exit from the right	A3S	→P11	Master axis specification	LM	→P12
Cable exit from the rear right	A3E	→P11	Master axis specification (sensor on the opposite side)	LLM	→P12
AQ seal (standard feature)	AQ	→P11	Non-motor side specification	NM	→P12
Brake	B	→P11	Guide with ball retention mechanism	RT	→P12
Creep sensor	C	→P11	Slave axis specification	S	→P12
Creep sensor on the opposite side	CL	→P11	High straightness, precision specification	ST	→P13

Common Specifications

Positioning repeatability (Note 2)	±0.01mm [±0.005mm]
Drive method (Note 3)	Ball screw Ø20mm, rolled C10 [equivalent to rolled C5]
Lost Motion (Note 4)	0.05mm [0.02mm] max.
Dynamic allowable load moment (Note 5)	Ma: 179.3N·m Mb: 254.8N·m Mc: 247.0N·m
Overhang load length	Ma direction: 1250mm max. Mb, Mc directions: 1250mm max.
Dynamic straightness (Note 6)	0.02mm/m max.
Base	Material: Aluminum, with white alumite treatment
Applicable controller	T1: XSEL-J/K T2: XSEL-P/Q, SSEL, SCON
Cable length (Note 7)	N: None, S: 3m, M: 5m, X□□: Specified length
Ambient operating temperature/humidity	0 to 40°C, 85%RH max. (non-condensing)

Diagram

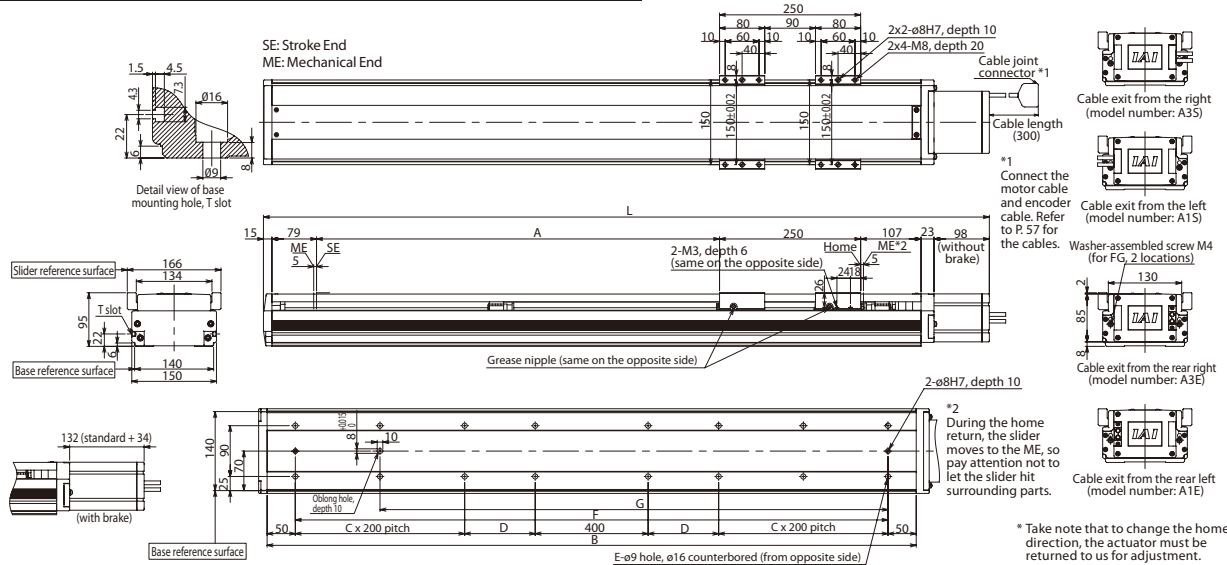

Dimensions, Mass and Maximum Speed by Stroke

Stroke	L										A									
	1000	1100	1200	1300	1400	1500	1600	1700	1800	1900	2000	2100	2200	2300	2400	2500				
without brake	1586	1686	1786	1886	1986	2086	2186	2286	2386	2486	2586	2686	2786	2886	2986	3086				
	1620	1720	1820	1920	2020	2120	2220	2320	2420	2520	2620	2720	2820	2920	3020	3120				
with brake	1620	1720	1820	1920	2020	2120	2220	2320	2420	2520	2620	2720	2820	2920	3020	3120				
A	1014	1114	1214	1314	1414	1514	1614	1714	1814	1914	2014	2114	2214	2314	2414	2514				
B	1450	1550	1650	1750	1850	1950	2050	2150	2250	2350	2450	2550	2650	2750	2850	2950				
C	1	1	1	1	1	1	1	2	2	2	2	3	3	3	3	3				
D	275	325	375	425	475	525	575	625	675	725	775	825	875	925	975	1025				
E	12	12	12	12	12	12	12	16	16	16	16	20	20	20	20	20				
F	1350	1450	1550	1650	1750	1850	1950	2050	2150	2250	2350	2450	2550	2650	2750	2850				
G	1150	1250	1350	1450	1550	1650	1750	1850	1950	2050	2150	2250	2350	2450	2550	2650				
Mass (kg)	30.8	32.6	34.3	36.1	37.8	39.6	41.4	43.1	44.9	46.6	48.4	50.1	51.9	53.6	55.4	57.1				
Maximum speed (mm/s)	Lead 40	2400		2300	2000	1900	1660	1480	1300	1180	1080	980	880	820	740	680				
	Lead 20	1200		1150	1000	950	830	740	650	590	540	490	440	410	370	340				

*If the brake is equipped, the mass increases by 0.6kg.

*The maximum speed (mm/s) varies depending on the stroke.

Applicable Controller Specifications

Applicable Controller	Maximum number of controlled axes	Connectable encoder type	Operating method	Power-supply voltage	Reference page
X-SEL-P/Q	6 axes	Absolute/ incremental	Program	Single/three-phase 200 VAC	→P56
X-SEL-J/K	4 axes			Single-phase 100/200 VAC	→P56
SSEL	2 axes			Single-phase 100/200 VAC	→P56
SCON	1 axis		Positioner pulse train control	Single-phase 200 VAC	→P56



(Note 1) Refer to P. 9 for the relationship of acceleration and payload. (Notes 2, 3, 4) The values in [] apply to the ISPB series. Other specification values apply commonly to the ISB and ISPB.
(Note 5) When the traveling life is 10,000km.
(Note 6) The value of dynamic straightness is when the high straightness, precision specification (option) is specified.
(Note 7) The maximum cable length is 30m. Specify a desired length in meters. (Example. X08 = 8m)

31

ISB-LXUWX-400/ISPB-LXUWX-400

Simple, Dustproof Type

ISDB / ISPDB

ISDB ISPDB	Simple, Dustproof Type	Small	Standard Type	Width: 90mm	ISDB (ISPDB)-S	P.36
		Medium	Standard Type	Width: 120mm	ISDB (ISPDB)-M-100	P.37
				Width: 120mm	ISDB (ISPDB)-M-200	P.38
			Mid-Support Type	Width: 120mm	ISDB (ISPDB)-MX-200	P.39
		Large	Standard Type	Width: 150mm	ISDB (ISPDB)-L-200	P.40
				Width: 150mm	ISDB (ISPDB)-L-400	P.41
			Mid-Support Type	Width: 150mm	ISDB (ISPDB)-LX-200	P.42
				Width: 150mm	ISDB (ISPDB)-LX-400	P.43

35

ISDB-S

Single-axis robot/Small, dustproof type/Actuator width: 90mm/60W
Straight shape

ISPDB-S

Single-axis robot/Small, dustproof type/Actuator width: 90mm/60W
Straight shape **High precision specification**

Model Specification Items

Series	Type	Encoder type	Motor type	Lead	Stroke	Applicable controller	Cable length	Options
ISDB: Standard specification ISPDB: High precision specification	S	A: Absolute specification I: Incremental specification	60: 60W	16: 16mm 8: 8mm 4: 4mm	100: 100mm ? : 800: 800mm (in 50mm increments)	T1: XSEL-J/K T2: SCON SSEL XSEL-P/Q	N: None S: 3m M: 5m X□□: Specified length	Refer to the options table below.



* Refer to P. 10 for the details of items comprising the model number.

Model Number/Specification

Model number	Encoder type	Motor output (W)	Lead (mm)	Stroke in 50mm increments (mm)	Speed (mm/s)	Acceleration (Note 1)				Payload (Note 1)				Rated thrust (N)
						Horizontal (G)		Vertical (G)		Horizontal (kg)		Vertical (kg)**		
						Rated	Maximum	Rated	Maximum	Rated acceleration	Maximum acceleration	Rated acceleration	Maximum acceleration	
ISDB[ISPDB]-S-[1]-60-16-[2]-[3]-[4]-[5]	Absolute Incremental	60	16	100~800	1~960	0.4	1.0	0.4	0.8	13	4.5	3	2	53.1
ISDB[ISPDB]-S-[1]-60-8-[2]-[3]-[4]-[5]			8		1~480	0.4	0.7	0.4	0.6	27	12	6	5	106.1
ISDB[ISPDB]-S-[1]-60-4-[2]-[3]-[4]-[5]			4		1~240	0.2	0.5	0.2	0.4	55	30	14	12	212.3

*In the above model numbers, [1] indicates the encoder type, [2] indicates the stroke, [3] indicates the applicable controller, [4] indicates the cable length, and [5] indicates the option(s).
**If the guide with ball retention mechanism (RT) is used, the vertical payload decreases by 0.5kg. (Please also refer to P.9).

Option

Name	Model number	Reference page	Name	Model number	Reference page
Cable exit from the left	A1S	→P11	Home limit switch	L	→P11
Cable exit from the rear left	A1E	→P11	Home limit switch on the opposite side	LL	→P11
Cable exit from the right	A3S	→P11	Master axis specification	LM	→P12
Cable exit from the rear right	A3E	→P11	Master axis specification (sensor on the opposite side)	LLM	→P12
AQ seal (standard feature)	AQ	→P11	Non-motor side specification	NM	→P12
Brake	B	→P11	Guide with ball retention mechanism	RT	→P12
Creep sensor	C	→P11	Slave axis specification	S	→P12
Creep sensor on the opposite side	CL	→P11	High straightness, precision specification	ST	→P13

Common Specifications

Positioning repeatability (Note 2)	±0.01mm [±0.005mm]
Drive method (Note 3)	Ball screw ø12mm, rolled C10 [equivalent to rolled C5]
Lost Motion (Note 4)	0.05mm [0.02mm] max.
Dynamic allowable load moment (Note 5)	Ma: 28.4N·m Mb: 40.2N·m Mc: 65.7N·m
Overhang load length	Ma direction: 450mm max. Mb, Mc directions: 450mm max.
Dynamic straightness (Note 6)	0.02mm/m max.
Base	Material: Aluminum, with white alumite treatment
Applicable controller	T1: XSEL-J/K T2: XSEL-P/Q, SSEL, SCON
Cable length (Note 7)	N: None, S: 3m, M: 5m, X□□: Specified length
Protection structure	IP30
Ambient operating temperature/humidity	0 to 40°C, 85%RH max. (non-condensing)

Diagram

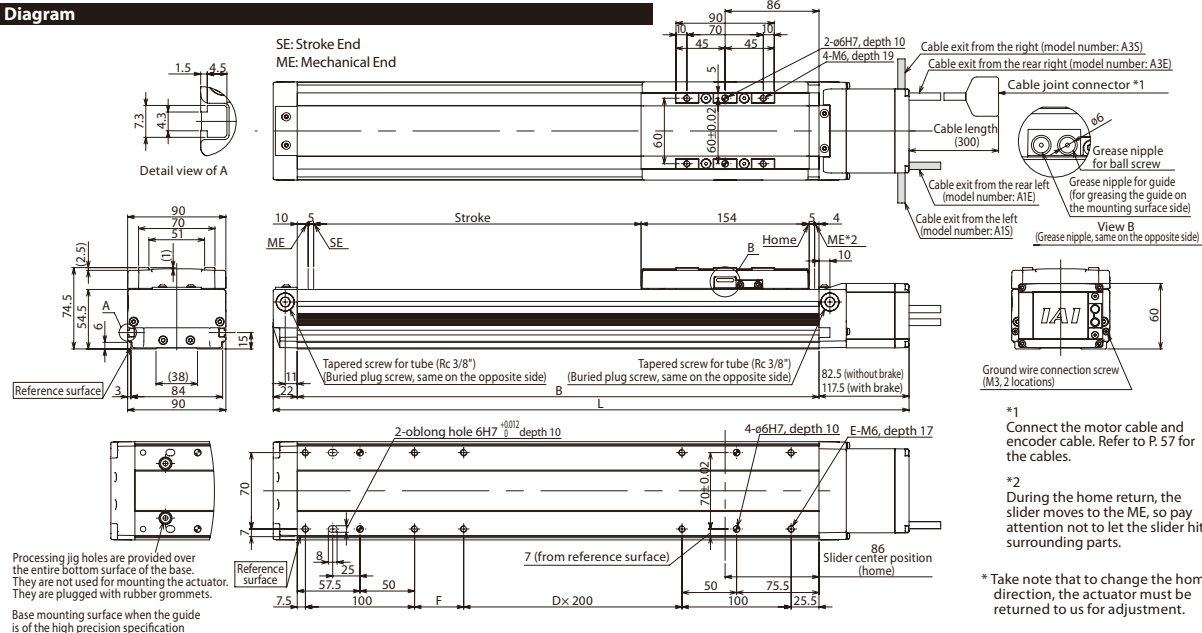

Dimensions, Mass and Maximum Speed by Stroke

Stroke	L										E										F										Mass (kg)										Maximum speed (mm/s)								
	100	150	200	250	300	350	400	450	500	550	600	650	700	750	800	8	8	8	8	8	10	10	10	10	10	12	12	12	12	14	14	14	14	45	95	145	195	245	295	345	395	445	495	545	595	645	695	745	795

ISDB-M-100

Single-axis robot/Medium, dustproof type/Actuator width: 120mm/100W Straight shape

ISPDB-M-100

Single-axis robot/Medium, dustproof type/Actuator width: 120mm/100W Straight shape **High precision specification**

Model Specification Items	Series	M	Encoder type	Motor type	Lead	Stroke	Applicable controller	Cable length	Options
	ISDB: Standard specification ISPDB: High precision specification		A: Absolute specification I: Incremental specification	100: 100W	30: 30mm 20: 20mm 10: 10mm 5: 5mm	100: 100mm 110: 110mm (in 50mm increments)	T1: XSEL-J/K T2: SCON SSEL XSEL-P/Q	N: None S: 3m M: 5m X□□: Specified length	Refer to the options table below.



* Refer to P. 10 for the details of items comprising the model number.

Model Number/Specification

Model number	Encoder type	Motor output (W)	Lead (mm)	Stroke in 50mm increments (mm)	Speed (mm/s)	Acceleration (Note 1)				Payload (Note 1)				Rated thrust (N)
						Horizontal (G)		Vertical (G)		Horizontal (kg)		Vertical (kg)**		
						Rated	Maximum	Rated	Maximum	Rated acceleration	Maximum acceleration	Rated acceleration	Maximum acceleration	
ISDB[ISPDB]-M-①-100-30-②-③-④-⑤	Absolute Incremental	100	30	100~1100	1~1800	0.4	1.0	0.4	1.0	15	4	2	1.2	56.6
ISDB[ISPDB]-M-①-100-20-②-③-④-⑤			20		1~1200	0.4	1.0	0.4	1.0	23	8	4	2.5	84.9
ISDB[ISPDB]-M-①-100-10-②-③-④-⑤			10		1~600	0.4	0.7	0.4	0.6	45	20	10	7	169.8
ISDB[ISPDB]-M-①-100-5-②-③-④-⑤			5		1~300	0.2	0.5	0.2	0.4	85	45	20	15	339.7

*In the above model numbers, ① indicates the encoder type, ② indicates the stroke, ③ indicates the applicable controller, ④ indicates the cable length, and ⑤ indicates the option(s).
**If the guide with ball retention mechanism (RT) is used, the vertical payload decreases by 0.5kg. (Please also refer to P.9).

Option

Name	Model number	Reference page	Name	Model number	Reference page
Cable exit from the left	A1S	→P11	Home limit switch	L	→P11
Cable exit from the rear left	A1E	→P11	Home limit switch on the opposite side	LL	→P11
Cable exit from the right	A3S	→P11	Master axis specification	LM	→P12
Cable exit from the rear right	A3E	→P11	Master axis specification (sensor on the opposite side)	LLM	→P12
AQ seal (standard feature)	AQ	→P11	Non-motor side specification	NM	→P12
Brake	B	→P11	Guide with ball retention mechanism	RT	→P12
Creep sensor	C	→P11	Slave axis specification	S	→P12
Creep sensor on the opposite side	CL	→P11	High straightness, precision specification	ST	→P13

Common Specifications

Positioning repeatability (Note 2)	±0.01mm [±0.005mm]
Drive method (Note 3)	Ball screw ø16mm, rolled C10 [equivalent to rolled C5]
Lost Motion (Note 4)	0.05mm [0.02mm] max.
Dynamic allowable load moment (Note 5)	Ma: 69.6N·m Mb: 99.0N·m Mc: 161.7N·m
Overhang load length	Ma direction: 600mm max. Mb, Mc directions: 600mm max.
Dynamic straightness (Note 6)	0.02mm/m max.
Base	Material: Aluminum, with white alumite treatment
Applicable controller	T1: XSEL-J/K T2: XSEL-P/Q, SSEL, SCON
Cable length (Note 7)	N: None, S: 3m, M: 5m, X□□: Specified length
Protection structure	IP30
Ambient operating temperature/humidity	0 to 40°C, 85%RH max. (non-condensing)

Diagram

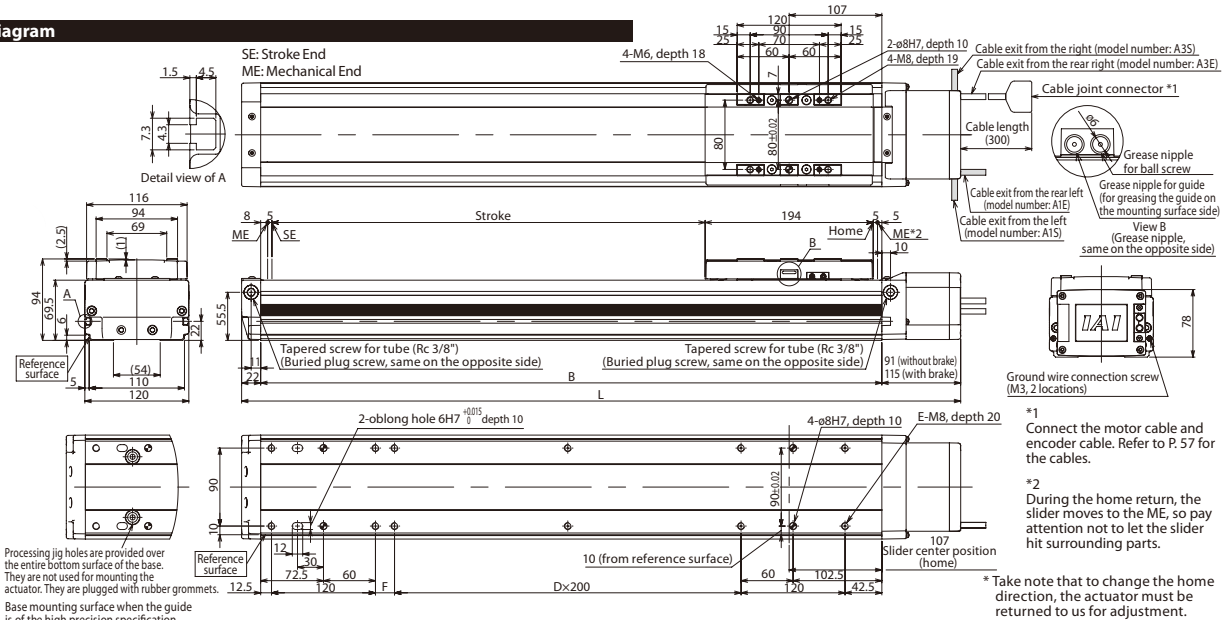

Dimensions, Mass and Maximum Speed by Stroke

L	Stroke	Stroke (mm)											Mass (kg)	Maximum speed (mm/s)										
		100	150	200	250	300	350	400	450	500	550	600			650	700	750	800	850	900	950	1000	1050	1100
L	without brake	430	480	530	580	630	680	730	780	830	880	930	980	1030	1080	1130	1180	1230	1280	1330	1380	1430		
	with brake	454	504	554	604	654	704	754	804	854	904	954	1004	1054	1104	1154	1204	1254	1304	1354	1404	1454		
B		317	367	417	467	517	567	617	667	717	767	817	867	917	967	1017	1067	1117	1167	1217	1267	1317		
D		0	0	0	0	1	1	1	1	2	2	2	2	3	3	3	4	4	4	4	4	5		
E		8	8	8	8	10	10	10	10	12	12	12	12	14	14	14	14	16	16	16	16	18		
F		22	72	122	172	22	72	122	172	22	72	122	172	22	72	122	172	22	72	122	172	22		
Maximum speed (mm/s)	Lead 30	7.5	8.1	8.8	9.4	10.0	10.7	11.3	11.9	12.6	13.2	13.8	14.5	15.1	15.7	16.4	17.0	17.6	18.3	18.9	19.5	20.2		
	Lead 20												1630	1440	1280	1150	1035	935	850	780	715	660		
	Lead 10												1085	960	855	765	690	625	570	520	475	440		
	Lead 5												545	480	430	380	345	310	285	260	240	220		
	Lead 5												270	240	215	190	155	140	130	120	110			

*If the brake is equipped, the mass increases by 0.3kg. *The maximum speed (mm/s) varies depending on the stroke.

Applicable Controller Specifications

Applicable Controller	Maximum number of controlled axes	Connectable encoder type	Operating method	Power-supply voltage	Reference page
X-SEL-P/Q	6 axes	Absolute/incremental	Program	Single/three-phase 200 VAC	→P56
X-SEL-J/K	4 axes			→P56	
SSEL	2 axes			→P56	
SCON	1 axis			Positioner pulse train control	→P56

(Note 1)	Refer to P.9 for the relationship of acceleration and payload. (Notes 2, 3, 4) The values in [] apply to the ISPDB series. Other specification values apply commonly to the ISDB and ISPDB.
(Note 5)	When the traveling life is 10,000km.
(Note 6)	The value of dynamic straightness is when the high straightness, precision specification (option) is specified.
(Note 7)	The maximum cable length is 30m. Specify a desired length in meters. (Example. X08 = 8m)

37

ISDB-M-100/ISPDB-M-100

ISDB-M-200

Single-axis robot/Medium, dustproof type/Actuator width: 120mm/200W
Straight shape

ISPDB-M-200

Single-axis robot/Medium, dustproof type/Actuator width: 120mm/200W
Straight shape **High precision specification**



Model Specification Items

Series	M	Encoder type	200	Motor type	200W	Lead	30mm	Stroke	100mm	Applicable controller	XSEL-J/K	Cable length	Options
ISDB: Standard specification ISPDB: High precision specification		A: Absolute specification I: Incremental specification	200: 200W	30: 30mm 20: 20mm 10: 10mm 5: 5mm	100: 100mm 110: 110mm (in 50mm increments)	T1: XSEL-J/K T2: SCON SSEL XSEL-P/Q	N: None S: 3m M: 5m X□□: Specified length	Refer to the options table below.					

* Refer to P. 10 for the details of items comprising the model number.

Model Number/Specification

Model number	Encoder type	Motor output (W)	Lead (mm)	Stroke in 50mm increments (mm)	Speed (mm/s)	Acceleration (Note 1)				Payload (Note 1)				Rated thrust (N)
						Horizontal (G)		Vertical (G)		Horizontal (kg)		Vertical (kg)		
						Rated	Maximum	Rated	Maximum	Rated acceleration	Maximum acceleration	Rated acceleration	Maximum acceleration	
ISDB[ISPDB]-M-①-200-30-②-③-④-⑤	Absolute Incremental	200	30	100~1100	1~1800	0.4	1.0	0.4	1.0	30	12	6	3	113.9
ISDB[ISPDB]-M-①-200-20-②-③-④-⑤			20		1~1200	0.4	1.0	0.4	1.0	45	16	10	5	170.9
ISDB[ISPDB]-M-①-200-10-②-③-④-⑤			10		1~600	0.4	0.7	0.4	0.6	90	40	20	15	341.8
ISDB[ISPDB]-M-①-200-5-②-③-④-⑤			5		1~300	0.2	0.5	0.2	0.4	110	80	40	30	683.6

* In the above model numbers, ① indicates the encoder type, ② indicates the stroke, ③ indicates the applicable controller, ④ indicates the cable length, and ⑤ indicates the option(s).

Option

Name	Model number	Reference page	Name	Model number	Reference page
Cable exit from the left	A1S	→P11	Home limit switch	L	→P11
Cable exit from the rear left	A1E	→P11	Home limit switch on the opposite side	LL	→P11
Cable exit from the right	A3S	→P11	Master axis specification	LM	→P12
Cable exit from the rear right	A3E	→P11	Master axis specification (sensor on the opposite side)	LLM	→P12
AQ seal (standard feature)	AQ	→P11	Non-motor side specification	NM	→P12
Brake	B	→P11	Guide with ball retention mechanism	RT	→P12
Creep sensor	C	→P11	Slave axis specification	S	→P12
Creep sensor on the opposite side	CL	→P11	High straightness, precision specification	ST	→P13

Common Specifications

Positioning repeatability (Note 2)	±0.01mm [±0.005mm]
Drive method (Note 3)	Ball screw ø16mm, rolled C10 [equivalent to rolled C5]
Lost Motion (Note 4)	0.05mm [0.02mm] max.
Dynamic allowable load moment (Note 5)	Ma: 69.6N·m Mb: 99.0N·m Mc: 161.7N·m
Overhang load length	Ma direction: 600mm max. Mb, Mc directions: 600mm max.
Dynamic straightness (Note 6)	0.02mm/m max.
Base	Material: Aluminum, with white alumite treatment
Applicable controller	T1: XSEL-J/K T2: XSEL-P/Q, SSEL, SCON
Cable length (Note 7)	N: None, S: 3m, M: 5m, X□□: Specified length
Protection structure	IP30
Ambient operating temperature/humidity	0 to 40°C, 85%RH max. (non-condensing)

Diagram

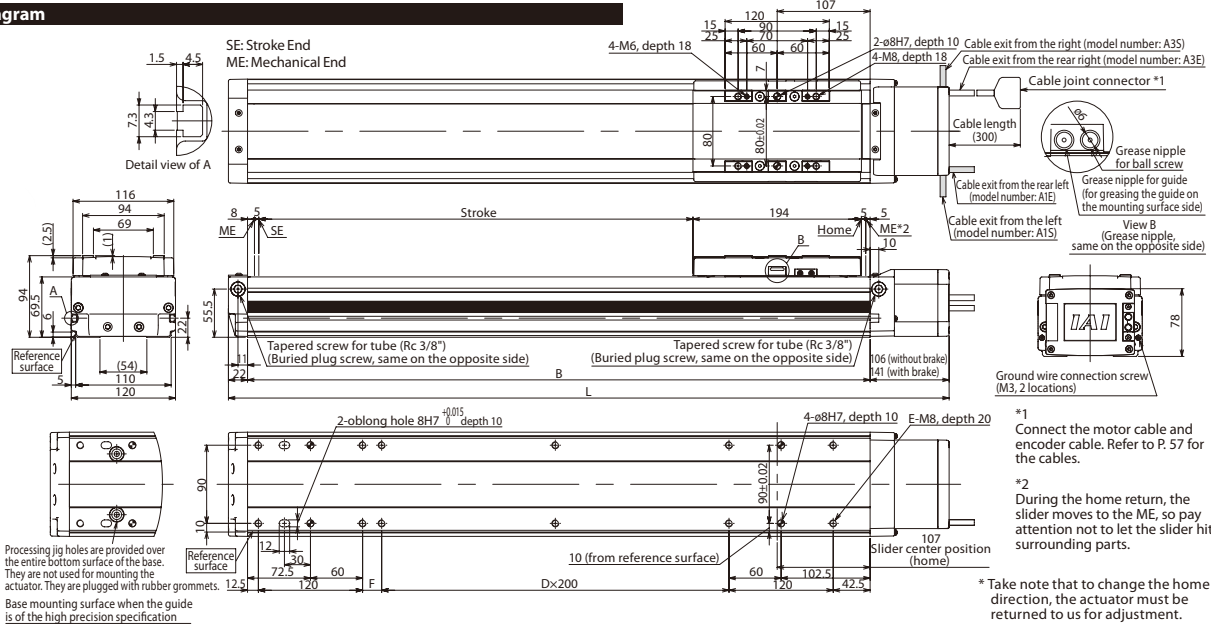

Dimensions, Mass and Maximum Speed by Stroke

Stroke	L											B											D											E											F											Mass (kg)																																																																																																																											
	100	150	200	250	300	350	400	450	500	550	600	650	700	750	800	850	900	950	1000	1050	1100	100	150	200	250	300	350	400	450	500	550	600	650	700	750	800	850	900	950	1000	1050	1100	100	150	200	250	300	350	400	450	500	550	600	650	700		750	800	850	900	950	1000	1050	1100	100	150	200	250	300	350	400	450	500	550	600	650	700	750	800	850	900	950	1000	1050	1100	100	150	200	250	300	350	400	450	500	550	600	650	700	750	800	850	900	950	1000	1050	1100																																																																									
without brake	445	495	545	595	645	695	745	795	845	895	945	995	1045	1095	1145	1195	1245	1295	1345	1395	1445	317	367	417	467	517	567	617	667	717	767	817	867	917	967	1017	1067	1117	1167	1217	1267	1317	0	0	0	0	1	1	1	1	2	2	2	2	3	3	3	3	3	4	4	4	4	4	5	8	8	8	8	10	10	10	10	12	12	12	12	14	14	14	14	16	16	16	16	16	18	22	72	122	172	22	72	122	172	22	72	122	172	22	72	122	172	22	72	122	172	22	72	122	7.9	8.5	9.2	9.8	10.4	11.1	11.7	12.3	13.0	13.6	14.2	14.9	15.5	16.1	16.8	17.4	18.0	18.7	19.3	19.9	20.6	Lead 30	1800	1630	1440	1280	1150	1035	935	850	780	715	660	Lead 20	1200	1085	960	855	765	690	625	570	520	475	440	Lead 10	600	545	480	430	380	345	310	285	260	240	220	Lead 5	300	270	240	215	190	170	155	140	130	120	110

*If the brake is equipped, the mass increases by 0.4kg. *The maximum speed (mm/s) varies depending on the stroke.

Applicable Controller Specifications

Applicable Controller	Maximum number of controlled axes	Connectable encoder type	Operating method	Power-supply voltage	Reference page
X-SEL-P/Q	6 axes	Absolute/ incremental	Program	Single/three-phase 200 VAC	→P56
X-SEL-J/K	4 axes			Single-phase 100/200 VAC	→P56
SSEL	2 axes		Positioner pulse train control	Single-phase 100/200 VAC	→P56
SCON	1 axis			→P56	

CAUTION

(Note 1) Refer to P. 9 for the relationship of acceleration and payload. (Notes 2, 3, 4) The values in [] apply to the ISPDB series. Other specification values apply commonly to the ISDB and ISPDB.

(Note 5) When the traveling life is 10,000km.

(Note 6) The value of dynamic straightness is when the high straightness, precision specification (option) is specified.

(Note 7) The maximum cable length is 30m. Specify a desired length in meters. (Example. X08 = 8m)

ISDB-M-200/ISPDB-M-200

ISDB-MX-200

Single-axis robot/Medium, dustproof, mid-support type/Actuator width: 120mm/200W Straight shape

ISPDB-MX-200

Single-axis robot/Medium, dustproof, mid-support type/Actuator width: 120mm/200W Straight shape **High precision specification**

Model Specification Items

Series	MX	Encoder type	200	Motor type	200: 200W	Lead	30: 30mm 20: 20mm	Stroke	800: 800mm 1600: 1600mm (in 100mm increments)	Applicable controller	T1: XSEL-J/K T2: SCON SSEL XSEL-P/Q	Cable length	N: None S: 3m M: 5m X□□: Specified length	Options	Refer to the options table below.
--------	----	--------------	-----	------------	-----------	------	----------------------	--------	---	-----------------------	--	--------------	--	---------	-----------------------------------

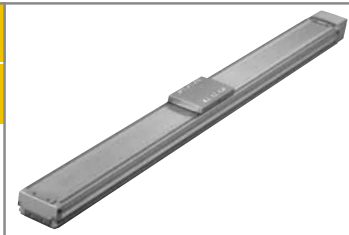

* Refer to P. 10 for the details of items comprising the model number.

Model Number/Specification

Model number	Encoder type	Motor output (W)	Lead (mm)	Stroke in 100mm increments (mm)	Speed (mm/s)	Acceleration (Note 1)				Payload (Note 1)				Rated thrust (N)
						Horizontal (G)		Vertical (G)		Horizontal (kg)		Vertical (kg)		
						Rated	Maximum	Rated	Maximum	Rated acceleration	Maximum acceleration	Rated acceleration	Maximum acceleration	
ISDB[ISPDB]-MX-①-200-30-②-③-④-⑤	Absolute	200	30	800~1600	1~1800	0.4	0.4	0.4	0.4	30	45	30	45	113.9
ISDB[ISPDB]-MX-①-200-20-②-③-④-⑤	Incremental	200	20	800~1600	1~1200	0.4	0.4	0.4	0.4	30	45	30	45	170.9

* In the above model numbers, ① indicates the encoder type, ② indicates the stroke, ③ indicates the applicable controller, ④ indicates the cable length, and ⑤ indicates the option(s).

Option

Name	Model number	Reference page	Name	Model number	Reference page
Cable exit from the left	A1S	→P11	Home limit switch	L	→P11
Cable exit from the rear left	A1E	→P11	Home limit switch on the opposite side	LL	→P11
Cable exit from the right	A3S	→P11	Master axis specification	LM	→P12
Cable exit from the rear right	A3E	→P11	Master axis specification (sensor on the opposite side)	LLM	→P12
AQ seal (standard feature)	AQ	→P11	Non-motor side specification	NM	→P12
Brake	B	→P11	Guide with ball retention mechanism	RT	→P12
Creep sensor	C	→P11	Slave axis specification	S	→P12
Creep sensor on the opposite side	CL	→P11	High straightness, precision specification	ST	→P13

Common Specifications

Positioning repeatability (Note 2)	±0.01mm [±0.005mm]
Drive method (Note 3)	Ball screw ø16mm, rolled C10 [equivalent to rolled C5]
Lost Motion (Note 4)	0.05mm [0.02mm] max.
Dynamic allowable load moment (Note 5)	Ma: 69.6N·m Mb: 99.0N·m Mc: 161.7N·m
Overhang load length	Ma direction: 600mm max. Mb, Mc directions: 600mm max.
Dynamic straightness (Note 6)	0.02mm/m max.
Base	Material: Aluminum, with white alumite treatment
Applicable controller	T1: XSEL-J/K T2: XSEL-P/Q, SSEL, SCON
Cable length (Note 7)	N: None, S: 3m, M: 5m, X□□: Specified length
Protection structure	IP30
Ambient operating temperature/humidity	0 to 40°C, 85%RH max. (non-condensing)

Diagram

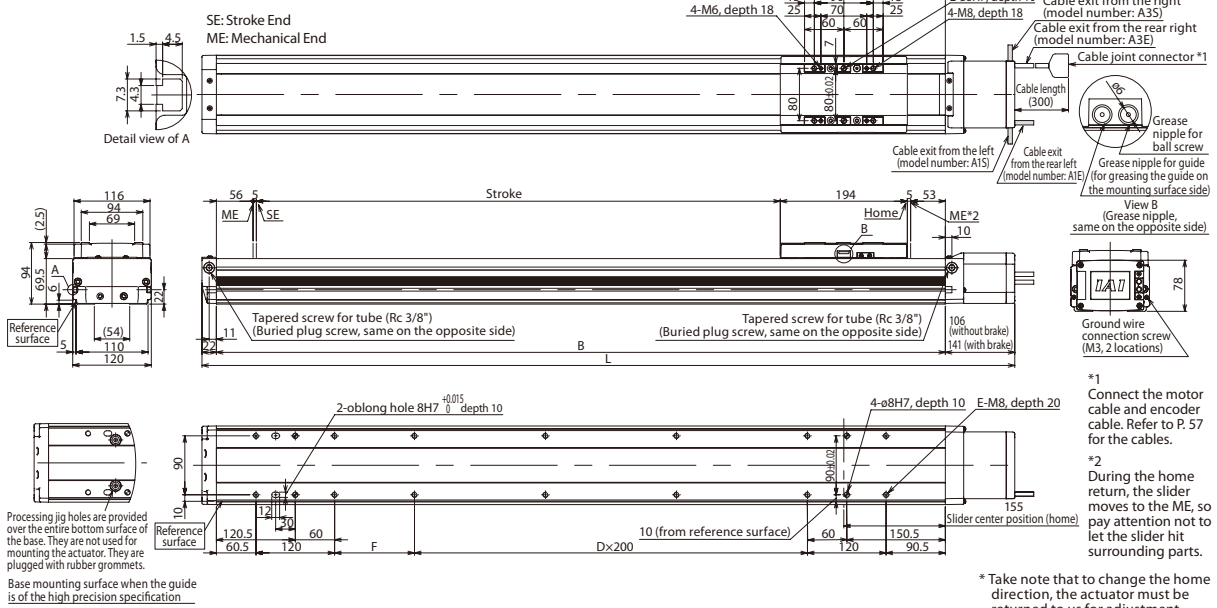

Dimensions, Mass and Maximum Speed by Stroke

Stroke	800				900				1000				1100				1200				1300				1400				1500				1600			
	without brake		with brake		without brake		with brake		without brake		with brake		without brake		with brake		without brake		with brake		without brake		with brake		without brake		with brake		without brake		with brake					
L	1241	1341	1276	1376	1441	1476	1541	1576	1641	1676	1741	1776	1841	1876	1941	1976	2041	2076	2141	2176	2241	2276	2341	2376	2441	2476	2541	2576	2641	2676						
B	1113	1213	1113	1213	1313	1413	1313	1413	1513	1613	1513	1613	1713	1813	1713	1813	1913	2013	1913	2013	2113	2213	2113	2213	2313	2413	2313	2413	2513	2613						
D	3	3	3	3	4	4	4	4	5	5	5	5	6	6	6	6	7	7	7	7	8	8	8	8	9	9	9	9	10							
E	14	14	14	14	16	16	16	16	18	18	18	18	20	20	20	20	22	22	22	22	24	24	24	24	26	26	26	26	28							
F	122	222	122	222	122	222	122	222	122	222	122	222	122	222	122	222	122	222	122	222	122	222	122	222	122	222	122	222	122	222						
Mass (kg)	18.3	19.6	18.3	19.6	20.9	22.2	20.9	22.2	23.4	24.7	23.4	24.7	26.0	27.3	26.0	27.3	28.6	30.0	28.6	30.0	31.3	32.7	31.3	32.7	34.0	35.4	34.0	35.4	36.7	38.1						
Maximum speed (mm/s)	Lead 30	1800	Lead 20	1200	1800	1200	1800	1200	1650	1000	1500	1000	1425	950	1200	1050	1050	700	700	700	700	700	700	700	700	700	700	700	700	700						

* If the brake is equipped, the mass increases by 0.5kg. * The maximum speed (mm/s) varies depending on the stroke.

Applicable Controller Specifications

Applicable Controller	Maximum number of controlled axes	Connectable encoder type	Operating method	Power-supply voltage	Reference page
X-SEL-P/Q	6 axes	Absolute/incremental	Program	Single/three-phase 200 VAC	→P56
X-SEL-J/K	4 axes				→P56
SSEL	2 axes				→P56
SCON	1 axis				Positioner pulse train control



(Note 1) Refer to P. 9 for the relationship of acceleration and payload. (Notes 2, 3, 4) The values in [] apply to the ISPDB series. Other specification values apply commonly to the ISDB and ISPDB.

(Note 5) When the traveling life is 10,000km.

(Note 6) The value of dynamic straightness is when the high straightness, precision specification (option) is specified.

(Note 7) The maximum cable length is 30m. Specify a desired length in meters. (Example. X08 = 8m)

39

ISDB-MX-200/ISPDB-MX-200

ISDB-L-200

Single-axis robot/Large, dustproof type/Actuator width: 150mm/200W
Straight shape

ISPDB-L-200

Single-axis robot/Large, dustproof type/Actuator width: 150mm/200W
Straight shape **High precision specification**

Model Specification Items

Series	Type	Encoder type	Motor type	Lead	Stroke	Applicable controller	Cable length	Options
ISDB: Standard specification ISPDB: High precision specification	L	A: Absolute specification I: Incremental specification	200: 200W	40: 40mm 20: 20mm 10: 10mm	100: 100mm 1300: 1300mm (in 50mm increments)	T1: XSEL-J/K T2: SCON SSEL XSEL-P/Q	N: None S: 3m M: 5m X□□: Specified length	Refer to the options table below.



* Refer to P. 10 for the details of items comprising the model number.

Model Number/Specification

Model number	Encoder type	Motor output (W)	Lead (mm)	Stroke in 50mm increments (mm)	Speed (mm/s)	Acceleration (Note 1)				Payload (Note 1)				Rated thrust (N)
						Horizontal (G)		Vertical (G)		Horizontal (kg)		Vertical (kg)**		
						Rated	Maximum	Rated	Maximum	Rated acceleration	Maximum acceleration	Rated acceleration	Maximum acceleration	
ISDB[ISPDB]-L-①-200-40-②-③-④-⑤	Absolute Incremental	200	40	100~1300	1~1800	0.4	1.0	0.4	1.0	15	7	2.5	2	85.5
ISDB[ISPDB]-L-①-200-20-②-③-④-⑤			20		1~1200	0.4	1.0	0.4	1.0	45	15	9	5	170.9
ISDB[ISPDB]-L-①-200-10-②-③-④-⑤			10		1~600	0.4	0.7	0.4	0.6	90	40	20	14	341.8

* In the above model numbers, ① indicates the encoder type, ② indicates the stroke, ③ indicates the applicable controller, ④ indicates the cable length, and ⑤ indicates the option(s).

** If the guide with ball retention mechanism (RT) is used, the vertical payload decreases by 1.0kg. (Please also refer to P.9).

Option

Name	Model number	Reference page	Name	Model number	Reference page
Cable exit from the left	A1S	→P11	Home limit switch	L	→P11
Cable exit from the rear left	A1E	→P11	Home limit switch on the opposite side	LL	→P11
Cable exit from the right	A3S	→P11	Master axis specification	LM	→P12
Cable exit from the rear right	A3E	→P11	Master axis specification (sensor on the opposite side)	LLM	→P12
AQ seal (standard feature)	AQ	→P11	Non-motor side specification	NM	→P12
Brake	B	→P11	Guide with ball retention mechanism	RT	→P12
Creep sensor	C	→P11	Slave axis specification	S	→P12
Creep sensor on the opposite side	CL	→P11	High straightness, precision specification	ST	→P13

Common Specifications

Positioning repeatability (Note 2)	±0.01mm [±0.005mm]
Drive method (Note 3)	Ball screw ø20mm, rolled C10 [equivalent to rolled C5]
Lost Motion (Note 4)	0.05mm [0.02mm] max.
Dynamic allowable load moment (Note 5)	Ma: 104.9N·m Mb: 149.9N·m Mc: 248.9N·m
Overhang load length	Ma direction: 750mm max. Mb, Mc directions: 750mm max.
Dynamic straightness (Note 6)	0.02mm/m max.
Base	Material: Aluminum, with white alumite treatment
Applicable controller	T1: XSEL-J/K T2: XSEL-P/Q, SSEL, SCON
Cable length (Note 7)	N: None, S: 3m, M: 5m, X□□: Specified length
Protection structure	IP30
Ambient operating temperature/humidity	0 to 40°C, 85%RH max. (non-condensing)

Diagram

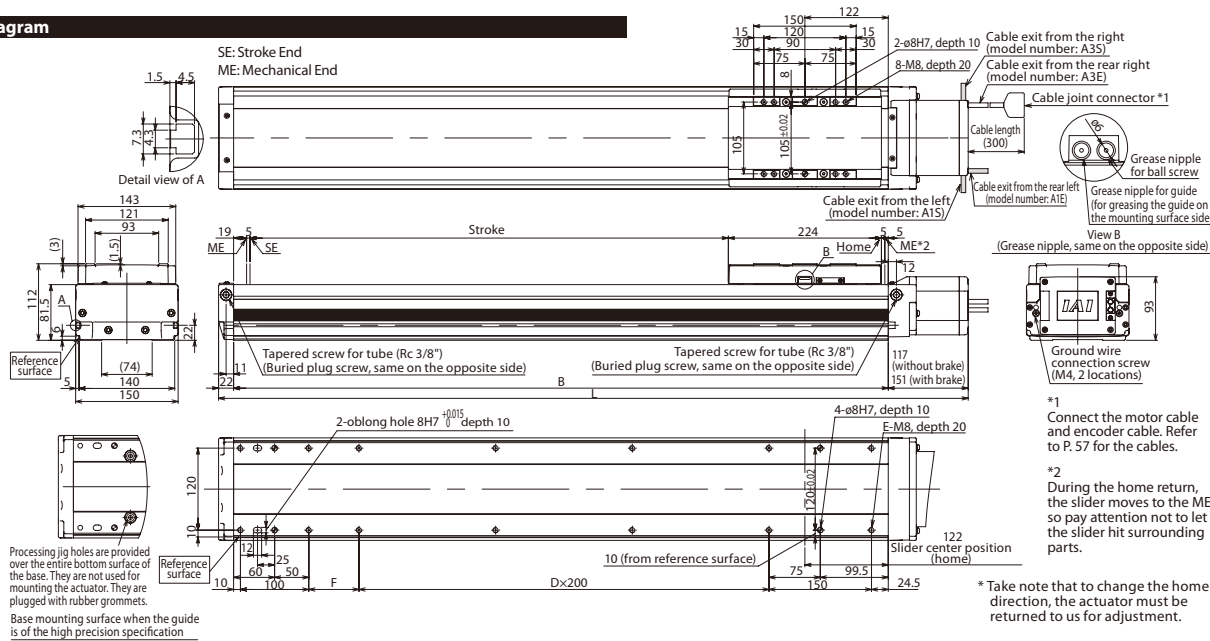

Dimensions, Mass and Maximum Speed by Stroke

L	Stroke	Stroke (mm)																							
		100	150	200	250	300	350	400	450	500	550	600	650	700	750	800	850	900	950	1000	1050	1100	1150	1200	1250
without brake	497	547	597	647	697	747	797	847	897	947	997	1047	1097	1147	1197	1247	1297	1347	1397	1447	1497	1547	1597	1647	1697
	531	581	631	681	731	781	831	881	931	981	1031	1081	1131	1181	1231	1281	1331	1381	1431	1481	1531	1581	1631	1681	1731
with brake	358	408	458	508	558	608	658	708	758	808	858	908	958	1008	1058	1108	1158	1208	1258	1308	1358	1408	1458	1508	1558
D	0	0	0	1	1	1	1	2	2	2	2	3	3	3	3	4	4	4	4	5	5	5	5	6	6
E	8	8	8	10	10	10	10	12	12	12	12	14	14	14	14	16	16	16	16	18	18	18	18	20	20
F	73.5	123.5	173.5	23.5	73.5	123.5	173.5	23.5	73.5	123.5	173.5	23.5	73.5	123.5	173.5	23.5	73.5	123.5	173.5	23.5	73.5	123.5	173.5	23.5	73.5
Mass (kg)	11.8	12.7	13.6	14.4	15.3	16.2	17.0	17.9	18.8	19.6	20.5	21.4	22.3	23.1	24.0	24.9	25.7	26.6	27.5	28.3	29.2	30.1	31.0	31.8	32.7
	11.8	12.7	13.6	14.4	15.3	16.2	17.0	17.9	18.8	19.6	20.5	21.4	22.3	23.1	24.0	24.9	25.7	26.6	27.5	28.3	29.2	30.1	31.0	31.8	32.7
Maximum speed (mm/s)	Lead 40	1800																							
	Lead 20	1165																							
	Lead 10	585																							

* If the brake is equipped, the mass increases by 0.5kg. * The maximum speed (mm/s) varies depending on the stroke.

Applicable Controller Specifications

Applicable Controller	Maximum number of controlled axes	Connectable encoder type	Operating method	Power-supply voltage	Reference page
X-SEL-P/Q	6 axes	Absolute/ incremental	Program	Single/three-phase 200 VAC	→P56
X-SEL-J/K	4 axes			→P56	
SSEL	2 axes			Single-phase 100/200 VAC	→P56
SCON	1 axis			Positioner pulse train control	→P56



(Note 1) Refer to P.9 for the relationship of acceleration and payload. (Notes 2, 3, 4) The values in [] apply to the ISPDB series. Other specification values apply commonly to the ISDB and ISPDB.

(Note 5) When the traveling life is 10,000km.

(Note 6) The value of dynamic straightness is when the high straightness, precision specification (option) is specified.

(Note 7) The maximum cable length is 30m. Specify a desired length in meters. (Example. X08 = 8m)

ISDB-L-200/ISPDB-L-200

40

ISDB-LX-200

Single-axis robot/Large, dustproof, mid-support type/Actuator width: 150mm/200W Straight shape

ISPDB-LX-200

Single-axis robot/Large, dustproof, mid-support type/Actuator width: 150mm/200W Straight shape **High precision specification**

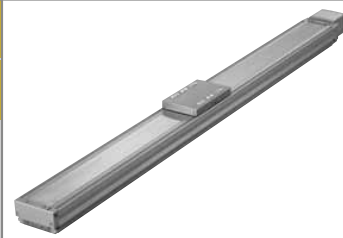

Model Specification Items	Series	LX Type	Encoder type	Motor type	Lead	Stroke	Applicable controller	Cable length	Options
ISDB: Standard specification ISPDB: High precision specification			A: Absolute specification I: Incremental specification	200: 200W	40: 40mm 20: 20mm	1000: 1000mm 1600: 1600mm (in 100mm increments)	T1: XSEL-J/K T2: SCON SSEL XSEL-P/Q	N: None S: 3m M: 5m X□□: Specified length	Refer to the options table below.

* Refer to P. 10 for the details of items comprising the model number.

Model Number/Specification

*1.0G=9800mm/sec²

Model number	Encoder type	Motor output (W)	Lead (mm)	Stroke in 100mm increments (mm)	Speed (mm/s)	Acceleration (Note 1)				Payload (Note 1)				Rated thrust (N)
						Horizontal (G)		Vertical (G)		Horizontal (kg)		Vertical (kg)		
						Rated	Maximum	Rated	Maximum	Rated acceleration	Maximum acceleration	Rated acceleration	Maximum acceleration	
ISDB[ISPDB]-LX-①-200-40-②-③-④-⑤	Absolute Incremental	200	40	1000~1600	1~1800	0.4		Designed exclusively for horizontal use		15		Designed exclusively for horizontal use		85.5
ISDB[ISPDB]-LX-①-200-20-②-③-④-⑤			20		1~1200	0.4		45		170.9				

*In the above model numbers, ① indicates the encoder type, ② indicates the stroke, ③ indicates the applicable controller, ④ indicates the cable length, and ⑤ indicates the option(s).

Option

Name	Model number	Reference page	Name	Model number	Reference page
Cable exit from the left	A1S	→P11	Home limit switch	L	→P11
Cable exit from the rear left	A1E	→P11	Home limit switch on the opposite side	LL	→P11
Cable exit from the right	A3S	→P11	Master axis specification	LM	→P12
Cable exit from the rear right	A3E	→P11	Master axis specification (sensor on the opposite side)	LLM	→P12
AQ seal (standard feature)	AQ	→P11	Non-motor side specification	NM	→P12
Brake	B	→P11	Guide with ball retention mechanism	RT	→P12
Creep sensor	C	→P11	Slave axis specification	S	→P12
Creep sensor on the opposite side	CL	→P11	High straightness, precision specification	ST	→P13

Common Specifications

Positioning repeatability (Note 2)	±0.01mm [±0.005mm]
Drive method (Note 3)	Ball screw ø16mm, rolled C10 [equivalent to rolled C5]
Lost Motion (Note 4)	0.05mm [0.02mm] max.
Dynamic allowable load moment (Note 5)	Ma: 104.9N·m Mb: 149.9N·m Mc: 248.9N·m
Overhang load length	Ma direction: 750mm max. Mb, Mc directions: 750mm max.
Dynamic straightness (Note 6)	0.02mm/m max.
Base	Material: Aluminum, with white alumite treatment
Applicable controller	T1: XSEL-J/K T2: XSEL-P/Q, SSEL, SCON
Cable length (Note 7)	N: None, S: 3m, M: 5m, X□□: Specified length
Protection structure	IP30
Ambient operating temperature/humidity	0 to 40°C, 85%RH max. (non-condensing)

Diagram

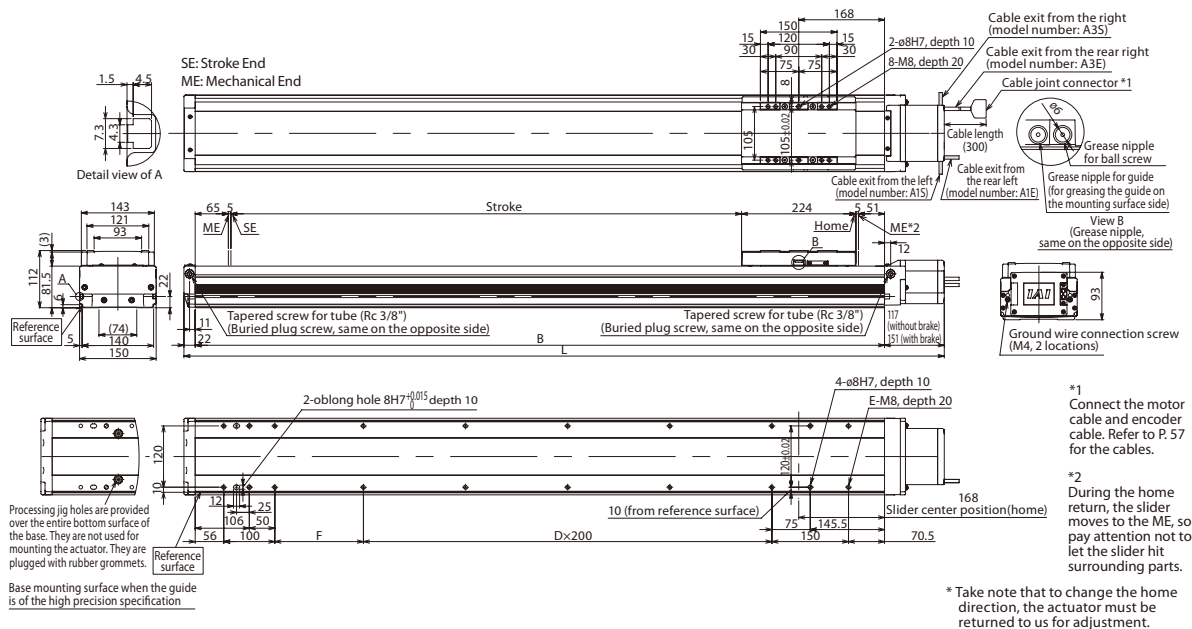

Dimensions, Mass and Maximum Speed by Stroke

*If the brake is equipped, the mass increases by 0.5kg. *The maximum speed (mm/s) varies depending on the stroke.

Stroke	Maximum speed (mm/s)								
	1000	1100	1200	1300	1400	1500	1600		
L	without brake	1489	1589	1689	1789	1889	1989	2089	
	with brake	1523	1623	1723	1823	1923	2023	2123	
B	1350	1450	1550	1650	1750	1850	1950		
D	4	5	5	6	6	7	7		
E	16	18	18	20	20	22	22		
F	173.5	73.5	173.5	73.5	173.5	73.5	173.5		
Mass (kg)									
	Lead 30	29.7	31.4	33.2	35.0	36.7	38.5	40.2	
Maximum speed (mm/s)	Lead 30	1800							
	Lead 20	1200		1150		1000		950	
								830	

Applicable Controller Specifications

Applicable Controller	Maximum number of controlled axes	Connectable encoder type	Operating method	Power-supply voltage	Reference page
X-SEL-P/Q	6 axes	Absolute/incremental	Program	Single/three-phase 200 VAC	→P56
X-SEL-J/K	4 axes			→P56	
SSEL	2 axes			Single-phase 100/200 VAC	→P56
SCON	1 axis			Positioner pulse train control	→P56



(Note 1) Refer to P.9 for the relationship of acceleration and payload. (Notes 2, 3, 4) The values in [] apply to the ISPDB series. Other specification values apply commonly to the ISDB and ISPDB.

(Note 5) When the traveling life is 10,000km.

(Note 6) The value of dynamic straightness is when the high straightness, precision specification (option) is specified.

(Note 7) The maximum cable length is 30m. Specify a desired length in meters. (Example. X08 = 8m)

ISDB-LX-200/ISPDB-LX-200

42

ISDB-LX-400

Single-axis robot/Large, dustproof, mid-support type/Actuator width: 150mm/400W Straight shape

ISPDB-LX-400

Single-axis robot/Large, dustproof, mid-support type/Actuator width: 150mm/400W Straight shape **High precision specification**

Model Specification Items	Series	LX Type	Encoder type	Motor type	Lead	Stroke	Applicable controller	Cable length	Options
ISDB: Standard specification ISPDB: High precision specification			A: Absolute specification I: Incremental specification	400: 400W	40: 40mm 20: 20mm	1000: 1000mm 1600: 1600mm (in 100mm increments)	T1: XSEL-J/K T2: SCON SSEL XSEL-P/Q	N: None S: 3m M: 5m X□□: Specified length	Refer to the options table below.

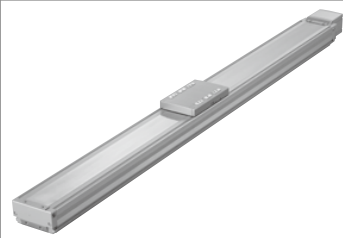

* Refer to P.10 for the details of items comprising the model number.

Model Number/Specification

*1.0G=9800mm/sec²

Model number	Encoder type	Motor output (W)	Lead (mm)	Stroke in 100mm increments (mm)	Speed (mm/s)	Acceleration (Note 1)				Payload (Note 1)				Rated thrust (N)
						Horizontal (G)		Vertical (G)		Horizontal (kg)		Vertical (kg)		
						Rated	Maximum	Rated	Maximum	Rated acceleration	Maximum acceleration	Rated acceleration	Maximum acceleration	
ISDB[ISPDB]-LX-①-400-40-②-③-④-⑤	Absolute	400	40	1000~1600	1~1800	0.4		Designed exclusively for horizontal use		40		Designed exclusively for horizontal use	169.6	
ISDB[ISPDB]-LX-①-400-20-②-③-④-⑤	Incremental	400	20	1000~1600	1~1200	0.4		Designed exclusively for horizontal use		90		Designed exclusively for horizontal use	339.1	

† In the above model numbers, ① indicates the encoder type, ② indicates the stroke, ③ indicates the applicable controller, ④ indicates the cable length, and ⑤ indicates the option(s).

Option

Name	Model number	Reference page	Name	Model number	Reference page
Cable exit from the left	A1S	→P11	Home limit switch	L	→P11
Cable exit from the rear left	A1E	→P11	Home limit switch on the opposite side	LL	→P11
Cable exit from the right	A3S	→P11	Master axis specification	LM	→P12
Cable exit from the rear right	A3E	→P11	Master axis specification (sensor on the opposite side)	LLM	→P12
AQ seal (standard feature)	AQ	→P11	Non-motor side specification	NM	→P12
Brake	B	→P11	Guide with ball retention mechanism	RT	→P12
Creep sensor	C	→P11	Slave axis specification	S	→P12
Creep sensor on the opposite side	CL	→P11	High straightness, precision specification	ST	→P13

Common Specifications

Positioning repeatability (Note 2)	±0.01mm [±0.005mm]
Drive method (Note 3)	Ball screw ø20mm, rolled C10 [equivalent to rolled C5]
Lost Motion (Note 4)	0.05mm [0.02mm] max.
Dynamic allowable load moment (Note 5)	Ma: 104.9N·m Mb: 149.9N·m Mc: 248.9N·m
Overhang load length	Ma direction: 750mm max. Mb, Mc directions: 750mm max.
Dynamic straightness (Note 6)	0.02mm/m max.
Base	Material: Aluminum, with white alumite treatment
Applicable controller	T1: XSEL-J/K T2: XSEL-P/Q, SSEL, SCON
Cable length (Note 7)	N: None, S: 3m, M: 5m, X□□: Specified length
Protection structure	IP30
Ambient operating temperature/humidity	0 to 40°C, 85%RH max. (non-condensing)

Diagram

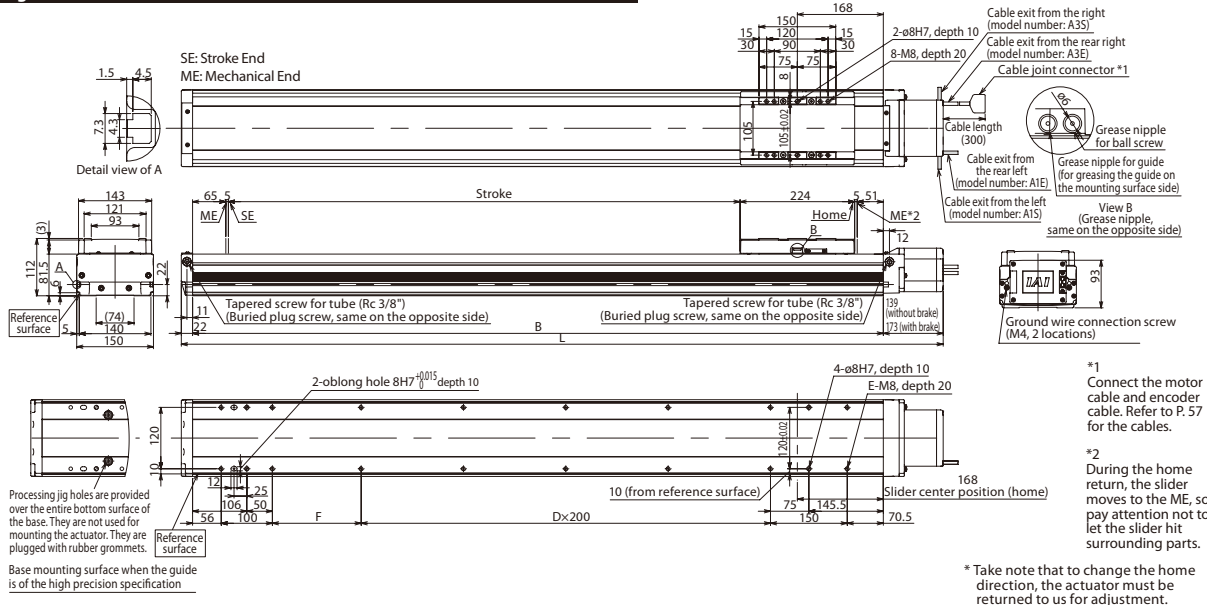

Dimensions, Mass and Maximum Speed by Stroke

*If the brake is equipped, the mass increases by 0.5kg. *The maximum speed (mm/s) varies depending on the stroke.

Stroke	1000	1100	1200	1300	1400	1500	1600
L without brake	1511	1611	1711	1811	1911	2011	2111
L with brake	1545	1645	1745	1845	1945	2045	2145
B	1350	1450	1550	1650	1750	1850	1950
D	4	5	5	6	6	7	7
E	16	18	18	20	20	22	22
F	173.5	73.5	173.5	73.5	173.5	73.5	173.5
Mass (kg)	30.1	31.8	33.6	35.4	37.1	38.9	40.6
Maximum speed (mm/s)	Lead 30		1800				1660
	Lead 20		1200		1150	1000	950
							830

Applicable Controller Specifications

Applicable Controller	Maximum number of controlled axes	Connectable encoder type	Operating method	Power-supply voltage	Reference page
X-SEL-P/Q	6 axes	Absolute/ incremental	Program	Single/three-phase 200 VAC	→P56
X-SEL-J/K	4 axes			Single-phase 100/200 VAC	→P56
SSEL	2 axes			Single-phase 100/200 VAC	→P56
SCON	1 axis		Positioner pulse train control	Single-phase 200 VAC	→P56



(Note 1) Refer to P.9 for the relationship of acceleration and payload. (Notes 2, 3, 4) The values in [] apply to the ISPDB series. Other specification values apply commonly to the ISDB and ISPDB.

(Note 5) When the traveling life is 10,000km.

(Note 6) The value of dynamic straightness is when the high straightness, precision specification (option) is specified.

(Note 7) The maximum cable length is 30m. Specify a desired length in meters. (Example. X08 = 8m)

43

ISDB-LX-400/ISPDB-LX-400

Sold & Serviced By:

ELECTROMATE

Toll Free Phone (877) SERV098

Toll Free Fax (877) SERV098

www.electromate.com

sales@electromate.com

Cleanroom Type

ISDBCR / ISPDBCR / SSPDACR

ISDBCR ISPDBCR	Standard (High Precision) Type	Small	Standard Type	Width: 90mm	ISDBCR (ISPDBCR)-S	P.45
		Medium	Standard Type	Width: 120mm	ISDBCR (ISPDBCR)-M-100	P.46
				Width: 120mm	ISDBCR (ISPDBCR)-M-200	P.47
		Large	Mid-Support Type	Width: 120mm	ISDBCR (ISPDBCR)-MX-200	P.48
			Standard Type	Width: 150mm	ISDBCR (ISPDBCR)-L-200	P.49
				Width: 150mm	ISDBCR (ISPDBCR)-L-400	P.50
			Mid-Support Type	Width: 150mm	ISDBCR (ISPDBCR)-LX-200	P.51
		Width: 150mm		ISDBCR (ISPDBCR)-LX-400	P.52	
SSPDACR	High Precision Type	Small	High-Rigidity, Iron-Base Type	Width: 100mm	SSPDACR-S-200	P.53
		Medium	High-Rigidity, Iron-Base Type	Width: 130mm	SSPDACR-M-400	P.54
		Large	High-Rigidity, Iron-Base Type	Width: 155mm	SSPDACR-L-750	P.55

ISDBCR-S

Single-axis robot for cleanroom/Small/Actuator width: 90mm/60 W
Straight shape

ISPDBCR-S

Single-axis robot for cleanroom/Small/Actuator width: 90mm/60 W
Straight shape **High precision specification**



Model Specification Items	Series	Type	Encoder type	Motor type	Lead	Stroke	Applicable controller	Cable length	Options
ISDBCR: Standard specification ISPDBCR: High precision specification	S	60	A: Absolute specification I: Incremental specification	60: 60W	16: 16mm 8: 8mm 4: 4mm	100: 100mm 800: 800mm (in 50mm increments)	T1: XSEL-J/K T2: SCON SSEL XSEL-P/Q	N: None S: 3m M: 5m X□: Specified length	Refer to the options table below.

* Refer to P. 10 for the details of items comprising the model number.

Model Number/Specification

*1.0G=9800mm/sec²

Model number	Encoder type	Motor output (W)	Lead (mm)	Stroke in 50mm increments (mm)	Speed (mm/s)	Acceleration (Note 1)				Payload (Note 1)				Rated thrust (N)	Suction flow rate (Nℓ/min)
						Horizontal (G)		Vertical (G)		Horizontal (kg)		Vertical (kg)**			
						Rated	Maximum	Rated	Maximum	Rated acceleration	Maximum acceleration	Rated acceleration	Maximum acceleration		
ISDBCR[ISPDBCR]-S-①-60-16-②-③-④-⑤	Absolute Incremental	60	16	100~800	1~960	0.4	1.0	0.4	0.8	13	4.5	3	2	53.1	60
8			1~480		0.4	0.7	0.4	0.6	27	12	6	5	106.1	30	
4			1~240		0.2	0.5	0.2	0.4	55	30	14	12	212.3	15	

* In the above model numbers, ① indicates the encoder type, ② indicates the stroke, ③ indicates the applicable controller, ④ indicates the cable length, and ⑤ indicates the option(s).
** If the guide with ball retention mechanism (RT) is used, the vertical payload decreases by 0.5kg. (Please also refer to P.9).

Option

Name	Model number	Reference page	Name	Model number	Reference page
Cable exit from the left	A1S	→P11	Home limit switch	L	→P11
Cable exit from the rear left	A1E	→P11	Home limit switch on the opposite side	LL	→P11
Cable exit from the right	A3S	→P11	Master axis specification	LM	→P12
Cable exit from the rear right	A3E	→P11	Master axis specification (sensor on the opposite side)	LLM	→P12
AQ seal (standard feature)	AQ	→P11	Non-motor side specification	NM	→P12
Brake	B	→P11	Guide with ball retention mechanism	RT	→P12
Creep sensor	C	→P11	Slave axis specification	S	→P12
Creep sensor on the opposite side	CL	→P11	High straightness, precision specification	ST	→P13
			Suction tube joint on the opposite side	VR	→P12

Common Specifications

Positioning repeatability (Note 2)	±0.01mm [±0.005mm]
Drive method (Note 3)	Ball screw ø12mm, rolled C10 [equivalent to rolled C5]
Lost Motion (Note 4)	0.05mm [0.02mm] max.
Dynamic allowable load moment (Note 5)	Ma: 28.4N·m Mb: 40.2N·m Mc: 65.7N·m
Overhang load length	Ma direction: 450mm max. Mb, Mc directions: 450mm max.
Dynamic straightness (Note 6)	0.02mm/m max.
Base	Material: Aluminum, with white alumite treatment
Applicable controller	T1: XSEL-J/K T2: XSEL-P/Q, SSEL, SCON
Cable length (Note 7)	N: None, S: 3m, M: 5m, X□: Specified length
Grease	Low dust-raising grease (for ball screw and guide)
Cleanliness degree	Class 10 (0.1µm per 1cf)
Suction tube joint	Quick connect joint, applicable tube outer diameter ø12mm

Diagram

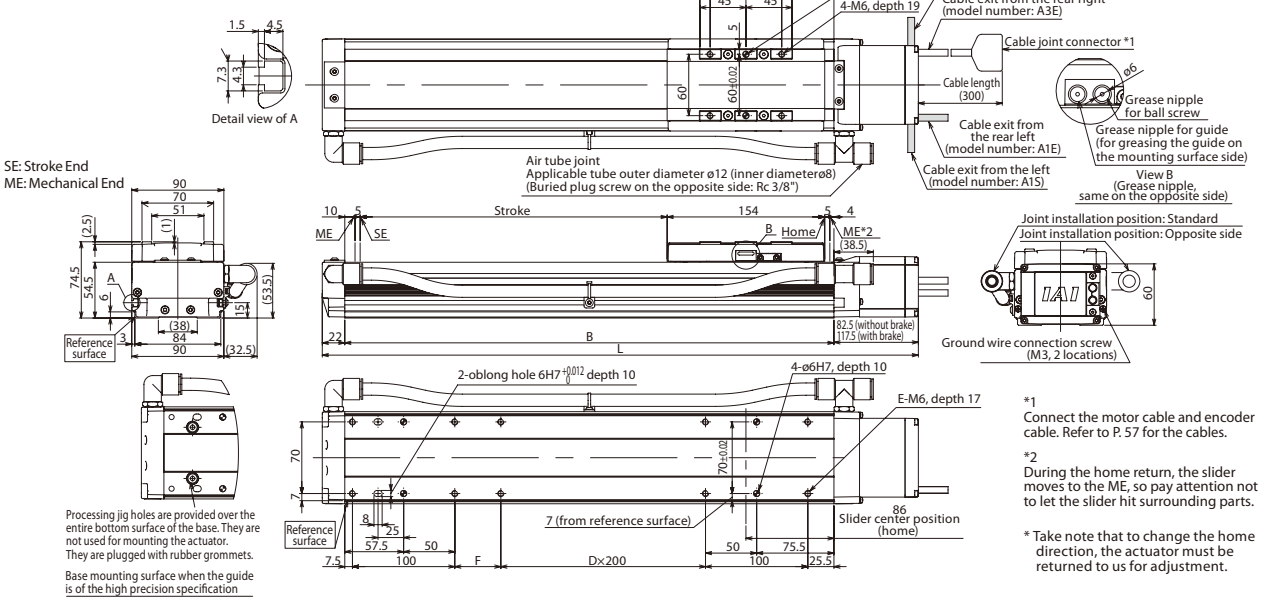

Dimensions, Mass and Maximum Speed by Stroke

* If the brake is equipped, the mass increases by 0.2kg. * The maximum speed (mm/s) varies depending on the stroke.

L	Stroke	Stroke										Mass (kg)		Maximum speed (mm/s)		
		100	150	200	250	300	350	400	450	500	550	600	650	700	750	800
	without brake	382.5	432.5	482.5	532.5	582.5	632.5	682.5	732.5	782.5	832.5	882.5	932.5	982.5	1032.5	1082.5
	with brake	417.5	467.5	517.5	567.5	617.5	667.5	717.5	767.5	817.5	867.5	917.5	967.5	1017.5	1067.5	1117.5
	B	278	328	378	428	478	528	578	628	678	728	778	828	878	928	978
	D	0	0	0	0	1	1	1	1	2	2	2	2	3	3	3
	E	8	8	8	8	10	10	10	10	12	12	12	12	14	14	14
	F	45	95	145	195	45	95	145	195	45	95	145	195	45	95	145
	Mass (kg)	4.2	4.5	4.9	5.2	5.6	6.0	6.3	6.7	7.0	7.4	7.8	8.1	8.5	8.9	9.2
Maximum speed (mm/s)	Lead 16	960														
	Lead 8	480														
	Lead 4	240														

Applicable Controller Specifications

Applicable Controller	Maximum number of controlled axes	Connectable encoder type	Operating method	Power-supply voltage	Reference page
X-SEL-P/Q	6 axes	Absolute/ incremental	Program	Single/three-phase 200 VAC	→P56
X-SEL-J/K	4 axes				→P56
SSEL	2 axes				→P56
SCON	1 axis				Positioner pulse train control →P56

CAUTION

(Note 1) Refer to P. 9 for the relationship of acceleration and payload. (Notes 2, 3, 4) The values in [] apply to the ISPDBCR series. Other specification values apply commonly to the ISDBCR and ISPDBCR.

(Note 5) When the traveling life is 10,000km.

(Note 6) The value of dynamic straightness is when the high straightness, precision specification (option) is specified.

(Note 7) The maximum cable length is 30m. Specify a desired length in meters. (Example. X08 = 8m)

45

ISDBCR-S/ISPDBCR-S

ISDBCR-M-100

Single-axis robot for cleanroom/Medium/Actuator width: 120mm/100W Straight shape

ISPDBCR-M-100

Single-axis robot for cleanroom/Medium/Actuator width: 120mm/100W Straight shape **High precision specification**



Model Specification Items

Series	M	Encoder type	100	Motor type	Lead	Stroke	Applicable controller	Cable length	Options
ISDBCR: Standard specification ISPDBCR: High precision specification		A: Absolute specification I: Incremental specification	100: 100W	30: 30mm 20: 20mm 10: 10mm 5: 5mm	100: 100mm 1100: 1100mm (in 50mm increments)	T1: XSEL-J/K T2: SCON SSEL XSEL-P/Q	N: None S: 3m M: 5m X□□: Specified length	Refer to the options table below.	

* Refer to P. 10 for the details of items comprising the model number.

Model Number/Specification

Model number	Encoder type	Motor output (W)	Lead (mm)	Stroke in 50mm increments (mm)	Speed (mm/s)	Acceleration (Note 1)				Payload (Note 1)				Rated thrust (N)	Suction flow rate (Nl/min)
						Horizontal (G)		Vertical (G)		Horizontal (kg)		Vertical (kg)**			
						Rated	Maximum	Rated	Maximum	Rated acceleration	Maximum acceleration	Rated acceleration	Maximum acceleration		
ISDBCR[ISPDBCR]-M-[1]-100-30-[2]-[3]-[4]-[5]	Absolute/Incremental	100	30	100~1100	1~1800	0.4	1.0	0.4	1.0	15	4	2	1.2	56.6	180
ISDBCR[ISPDBCR]-M-[1]-100-20-[2]-[3]-[4]-[5]			1~1200		0.4	1.0	0.4	1.0	23	8	4	2.5	84.9	120	
ISDBCR[ISPDBCR]-M-[1]-100-10-[2]-[3]-[4]-[5]			1~600		0.4	0.7	0.4	0.6	45	20	10	7	169.8	50	
ISDBCR[ISPDBCR]-M-[1]-100-5-[2]-[3]-[4]-[5]			1~300		0.2	0.5	0.2	0.4	85	45	20	15	339.7	20	

* In the above model numbers, [1] indicates the encoder type, [2] indicates the stroke, [3] indicates the applicable controller, [4] indicates the cable length, and [5] indicates the option(s).
** If the guide with ball retention mechanism (RT) is used, the vertical payload decreases by 0.5kg. (Please also refer to P.9).

Option

Name	Model number	Reference page	Name	Model number	Reference page
Cable exit from the left	A1S	→P11	Home limit switch	L	→P11
Cable exit from the rear left	A1E	→P11	Home limit switch on the opposite side	LL	→P11
Cable exit from the right	A3S	→P11	Master axis specification	LM	→P12
Cable exit from the rear right	A3E	→P11	Master axis specification (sensor on the opposite side)	LLM	→P12
AQ seal (standard feature)	AQ	→P11	Non-motor side specification	NM	→P12
Brake	B	→P11	Guide with ball retention mechanism	RT	→P12
Creep sensor	C	→P11	Slave axis specification	S	→P12
Creep sensor on the opposite side	CL	→P11	High straightness, precision specification	ST	→P13
			Suction tube joint on the opposite side	VR	→P12

Common Specifications

Positioning repeatability (Note 2)	±0.01mm (±0.005mm)
Drive method (Note 3)	Ball screw ø16mm, rolled C10 [equivalent to rolled C5]
Lost Motion (Note 4)	0.05mm [0.02mm] max.
Dynamic allowable load moment (Note 5)	Ma: 69.6Nm Mb: 99.0Nm Mc: 161.7Nm
Overhang load length	Ma direction: 600mm max. Mb, Mc directions: 600mm max.
Dynamic straightness (Note 6)	0.02mm/m max.
Base	Material: Aluminum, with white alumite treatment
Applicable controller	T1: XSEL-J/K T2: XSEL-P/Q SSEL, SCON
Cable length (Note 7)	N: None, S: 3m, M: 5m, X□□: Specified length
Grease	Low dust-raising grease (for ball screw and guide)
Cleanliness degree	Class 10 (0.1µm per 1cf)
Suction tube joint	Quick connect joint, applicable tube outer diameter ø12mm

Diagram

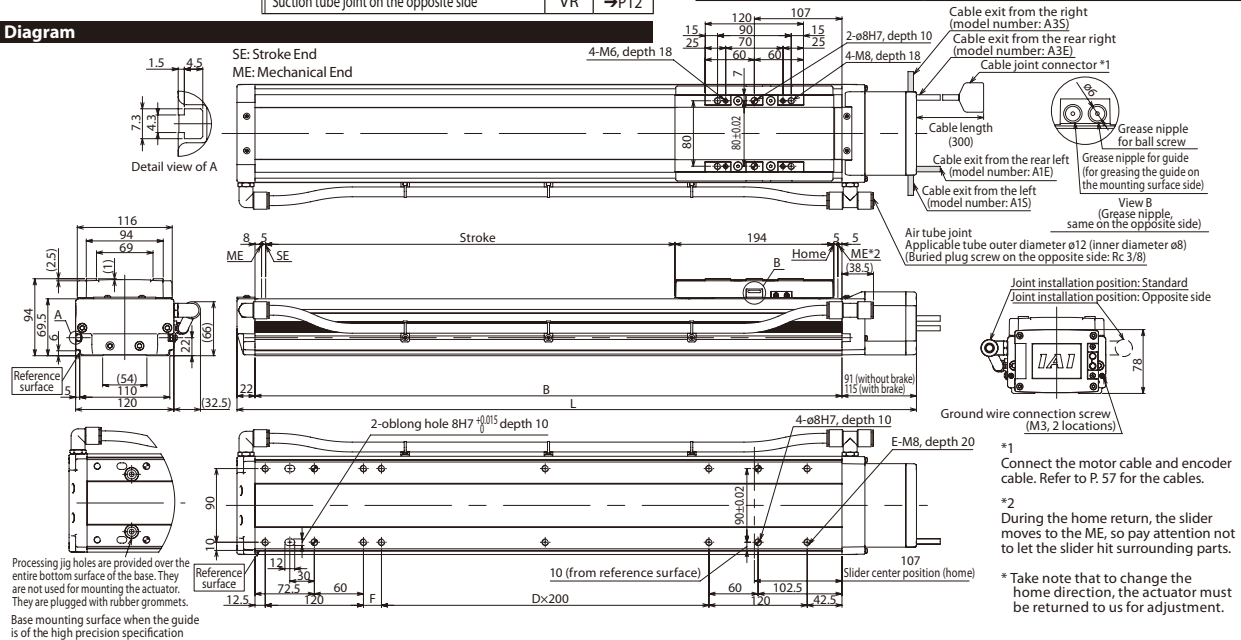

Dimensions, Mass and Maximum Speed by Stroke

* If the brake is equipped, the mass increases by 0.3kg. * The maximum speed (mm/s) varies depending on the stroke.

Stroke	100	150	200	250	300	350	400	450	500	550	600	650	700	750	800	850	900	950	1000	1050	1100
	L	430	480	530	580	630	680	730	780	830	880	930	980	1030	1080	1130	1180	1230	1280	1330	1380
B	454	504	554	604	654	704	754	804	854	904	954	1004	1054	1104	1154	1204	1254	1304	1354	1404	1454
D	0	0	0	0	1	1	1	1	2	2	2	2	3	3	3	4	4	4	4	4	5
E	8	8	8	8	10	10	10	10	12	12	12	12	14	14	14	14	16	16	16	16	18
F	22	72	122	172	22	72	122	172	22	72	122	172	22	72	122	172	22	72	122	172	22
Mass (kg)	7.6	8.2	8.8	9.5	10.1	10.7	11.3	12.0	12.6	13.2	13.9	14.5	15.1	15.7	16.4	17.0	17.6	18.2	18.9	19.5	20.1
Maximum speed (mm/s)	Lead 30	1800																			
	Lead 20	1200																			
	Lead 10	600																			
	Lead 5	300																			
		1630	1440	1280	1150	1035	935	850	780	715	660	1085	960	855	765	690	625	570	520	475	440
		545	480	430	380	345	310	285	260	240	220	270	240	215	190	170	155	140	130	120	110

Applicable Controller Specifications

Applicable Controller	Maximum number of controlled axes	Connectable encoder type	Operating method	Power-supply voltage	Reference page
X-SEL-P/Q	6 axes	Absolute/Incremental	Program	Single/three-phase 200 VAC	→P56
X-SEL-J/K	4 axes			→P56	
SSEL	2 axes			Single-phase 100/200 VAC	→P56
SCON	1 axis			Positioner pulse train control	→P56



(Note 1) Refer to P.9 for the relationship of acceleration and payload. (Notes 2, 3, 4) The values in [] apply to the ISPDBCR series. Other specification values apply commonly to the ISDBCR and ISPDBCR. (Note 5) When the traveling life is 10,000km. (Note 6) The value of dynamic straightness is when the high straightness, precision specification (option) is specified. (Note 7) The maximum cable length is 30m. Specify a desired length in meters. (Example. X08 = 8m)

ISDBCR-M-100/ISPDBCR-M-100

46

ISDBCR-MX-200

Single-axis robot for cleanroom/Medium, mid-support type/Actuator width: 120mm/200W Straight shape

ISPDBCR-MX-200

Single-axis robot for cleanroom/Medium, mid-support type/Actuator width: 120mm/200W Straight shape **High precision specification**

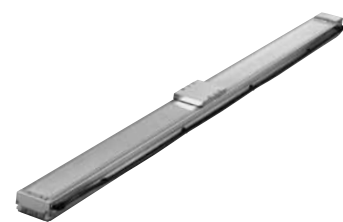

Model Specification Items

Series	MX	Encoder type	200	Motor type	200: 200W	Lead	30: 30mm 20: 20mm	Stroke	800: 800mm 2000: 2000mm (in 100mm increments)	Applicable controller	T1: XSEL-J/K T2: SCON SSEL XSEL-P/Q	Cable length	N: None S: 3m M: 5m X□□: Specified length	Options	Refer to the options table below.
--------	----	--------------	-----	------------	-----------	------	----------------------	--------	---	-----------------------	--	--------------	--	---------	-----------------------------------

* Refer to P. 10 for the details of items comprising the model number.

Model Number/Specification

Model number	Encoder type	Motor output (W)	Lead (mm)	Stroke in 100mm increments (mm)	Speed (mm/s)	Acceleration (Note 1)				Payload (Note 1)				Rated thrust (N)	Suction flow rate (Nℓ/min)
						Horizontal (G)		Vertical (G)		Horizontal (kg)		Vertical (kg)			
						Rated	Maximum	Rated	Maximum	Rated acceleration	Maximum acceleration	Rated acceleration	Maximum acceleration		
ISDBCR[ISPDBCR]-MX-①-200-30-②-③-④-⑤	Absolute	200	30	800~2000	1~1800	0.4		Designed exclusively for horizontal use		30		Designed exclusively for horizontal use		113.9	180
ISDBCR[ISPDBCR]-MX-①-200-20-②-③-④-⑤	Incremental	200	20	800~2000	1~1200	0.4				45				170.9	120

*In the above model numbers, ① indicates the encoder type, ② indicates the stroke, ③ indicates the applicable controller, ④ indicates the cable length, and ⑤ indicates the option(s).

Option

Name	Model number	Reference page	Name	Model number	Reference page
Cable exit from the left	A1S	→P11	Home limit switch	LL	→P11
Cable exit from the rear left	A1E	→P11	Home limit switch on the opposite side	LL	→P11
Cable exit from the right	A3S	→P11	Master axis specification	LM	→P12
Cable exit from the rear right	A3E	→P11	Master axis specification (sensor on the opposite side)	LLM	→P12
AQ seal (standard feature)	AQ	→P11	Non-motor side specification	NM	→P12
Brake	B	→P11	Guide with ball retention mechanism	RT	→P12
Creep sensor	C	→P11	Slave axis specification	S	→P12
Creep sensor on the opposite side	CL	→P11	High straightness, precision specification	ST	→P13
			Suction tube joint on the opposite side	VR	→P12

Common Specifications

Positioning repeatability (Note 2)	±0.01mm [±0.005mm]
Drive method (Note 3)	Ball screw ø16mm, rolled C10 [equivalent to rolled C5]
Lost Motion (Note 4)	0.05mm [0.02mm] max.
Dynamic allowable load moment (Note 5)	Ma: 69.6N·m Mb: 99.0N·m Mc: 161.7N·m
Overhang load length	Ma direction: 600mm max. Mb, Mc directions: 600mm max.
Dynamic straightness (Note 6)	0.02mm/m max.
Base	Material: Aluminum, with white alumite treatment
Applicable controller	T1: XSEL-J/K T2: XSEL-P/Q SSEL, SCON
Cable length (Note 7)	N: None, S: 3m, M: 5m, X□□: Specified length
Grease	Low dust-raising grease (for ball screw and guide)
Cleanliness degree	Class 10 (0.1µm per 1cf)
Suction tube joint	Quick connect joint, applicable tube outer diameter ø12mm

Diagram

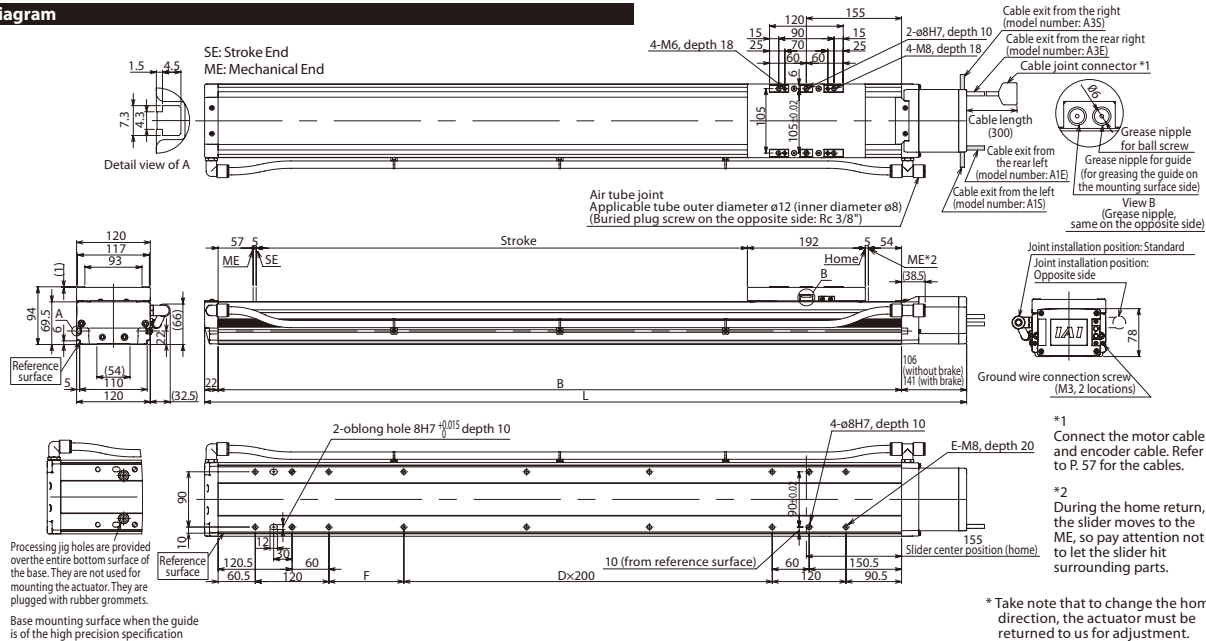

Dimensions, Mass and Maximum Speed by Stroke

Stroke	*If the brake is equipped, the mass increases by 0.5kg. *The maximum speed (mm/s) varies depending on the stroke.																														
	800	900	1000	1100	1200	1300	1400	1500	1600	1700	1800	1900	2000																		
L	without brake	1241	1341	1441	1541	1641	1741	1841	1941	2041	2141	2241	2341	2441																	
	with brake	1276	1376	1476	1576	1676	1776	1876	1976	2076	2176	2276	2376	2476																	
B	1113	1213	1313	1413	1513	1613	1713	1813	1913	2013	2113	2213	2313																		
D	3	3	4	4	5	5	6	6	7	7	8	8	9																		
E	14	14	16	16	18	18	20	20	22	22	24	24	26																		
F	122	222	122	222	122	222	122	222	122	222	122	222	122																		
Mass (kg)		18.5	19.8	21.0	22.3	23.6	24.9	26.2	27.4	28.7	30.0	31.3	32.5	33.8																	
	Maximum speed (mm/s)																														
	Lead 30	1800			1650			1500			1425			1200			1050			900			825			750			675		
	Lead 20	1200			1100			1000			950			800			700			600			550			500			450		

Applicable Controller Specifications

Applicable Controller	Maximum number of controlled axes	Connectable encoder type	Operating method	Power-supply voltage	Reference page
X-SEL-P/Q	6 axes	Absolute/ incremental	Program	Single/three-phase 200 VAC	→P56
X-SEL-J/K	4 axes				→P56
SSEL	2 axes			Single-phase 100/200 VAC	→P56
SCON	1 axis				Positioner pulse train control



(Note 1) Refer to P. 9 for the relationship of acceleration and payload.
(Notes 2, 3, 4) The values in [] apply to the ISPDBCR series. Other specification values apply commonly to the ISDBCR and ISPDBCR.
(Note 5) When the traveling life is 10,000km.
(Note 6) The value of dynamic straightness is when the high straightness, precision specification (option) is specified.
(Note 7) The maximum cable length is 30m. Specify a desired length in meters. (Example. X08 = 8m)

ISDBCR-MX-200/ISPDBCR-MX-200

ISDBCR-L-200

Single-axis robot for cleanroom/Large/Actuator width: 150mm/200W Straight shape

ISPDBCR-L-200

Single-axis robot for cleanroom/Large/Actuator width: 150mm/200W Straight shape **High precision specification**

Model Specification Items	Series	Type	Encoder type	Motor type	Lead	Stroke	Applicable controller	Cable length	Options
ISDBCR: Standard specification ISPDBCR: High precision specification	L	200	A: Absolute specification I: Incremental specification	200: 200W	40: 40mm 20: 20mm 10: 10mm	100: 100mm 1300: 1300mm (in 50 mm increments)	T1: XSEL-J/K T2: SCON SSEL XSEL-P/Q	N: None S: 3m M: 5m X□□: Specified length	Refer to the options table below.



* Refer to P. 10 for the details of items comprising the model number.

Model Number/Specification

Model number	Encoder type	Motor output (W)	Lead (mm)	Stroke in 50mm increments (mm)	Speed (mm/s)	Acceleration (Note 1)				Payload (Note 1)				Rated thrust (N)	Suction flow rate (Nℓ/min)
						Horizontal (G)		Vertical (G)		Horizontal (kg)		Vertical (kg)**			
						Rated	Maximum	Rated	Maximum	Rated acceleration	Maximum acceleration	Rated acceleration	Maximum acceleration		
ISDBCR[ISPDBCR]-L-①-200-40-②-③-④-⑤	Absolute Incremental	200	40	100~1300	1~1800	0.4	1.0	0.4	1.0	15	7	2.5	2	85.5	180
ISDBCR[ISPDBCR]-L-①-200-20-②-③-④-⑤			20		1~1200	0.4	1.0	0.4	1.0	45	15	9	5	170.9	120
ISDBCR[ISPDBCR]-L-①-200-10-②-③-④-⑤			10		1~600	0.4	0.7	0.4	0.6	90	40	20	14	341.8	50

*In the above model numbers, ① indicates the encoder type, ② indicates the stroke, ③ indicates the applicable controller, ④ indicates the cable length, and ⑤ indicates the option(s).
**If the guide with ball retention mechanism (RT) is used, the vertical payload decreases by 1.0kg. (Please also refer to P.9).

Option

Name	Model number	Reference page	Name	Model number	Reference page
Cable exit from the left	A1S	→P11	Home limit switch	L	→P11
Cable exit from the rear left	A1E	→P11	Home limit switch on the opposite side	LL	→P11
Cable exit from the right	A3S	→P11	Master axis specification	LM	→P12
Cable exit from the rear right	A3E	→P11	Master axis specification (sensor on the opposite side)	LLM	→P12
AQ seal (standard feature)	AQ	→P11	Non-motor side specification	NM	→P12
Brake	B	→P11	Guide with ball retention mechanism	RT	→P12
Creep sensor	C	→P11	Slave axis specification	S	→P12
Creep sensor on the opposite side	CL	→P11	High straightness, precision specification	ST	→P13
			Suction tube joint on the opposite side	VR	→P12

Common Specifications

Positioning repeatability (Note 2)	±0.01mm (±0.005mm)
Drive method (Note 3)	Ball screw ø20mm, rolled C10 [equivalent to rolled C5]
Lost Motion (Note 4)	0.05mm [0.02mm] max.
Dynamic allowable load moment (Note 5)	Ma: 104.9N·m Mb: 149.9N·m Mc: 248.9N·m
Overhang load length	Ma direction: 750mm max. Mb, Mc directions: 750mm max.
Dynamic straightness (Note 6)	0.02mm/m max.
Base	Material: Aluminum, with white alumite treatment
Applicable controller	T1: XSEL-J/K T2: XSEL-P/Q, SSEL, SCON
Cable length (Note 7)	N: None, S: 3m, M: 5m, X□□: Specified length
Grease	Low dust-raising grease (for ball screw and guide)
Cleanliness degree	Class 10 (0.1µm per 1cf)
Suction tube joint	Quick connection joint, applicable tube outer diameter ø12mm

Diagram

CAD drawings are available for download from our website.

2D CAD

SE: Stroke End
ME: Mechanical End

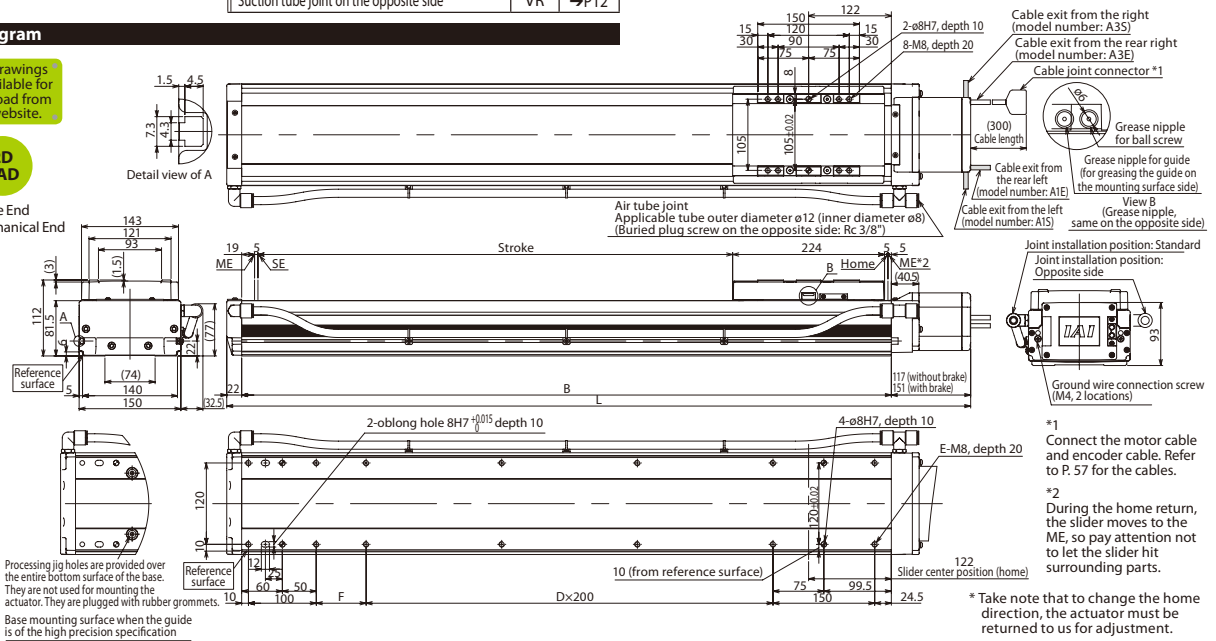

Dimensions, Mass and Maximum Speed by Stroke

L	Stroke		Stroke (mm)																	Mass (kg)		Maximum speed (mm/s)															
	without brake	with brake	100	150	200	250	300	350	400	450	500	550	600	650	700	750	800	850	900	950	1000	1050	1100	1150	1200	1250	1300										
B	497	547	597	647	697	747	797	847	897	947	997	1047	1097	1147	1197	1247	1297	1347	1397	1447	1497	1547	1597	1647	1697												
D	0	0	0	1	1	1	1	1	2	2	2	2	3	3	3	3	4	4	4	4	5	5	5	5	6	6											
E	8	8	8	10	10	10	10	10	12	12	12	12	14	14	14	14	16	16	16	16	16	18	18	18	20	20											
F	73.5	123.5	173.5	223.5	273.5	323.5	373.5	423.5	473.5	523.5	573.5	623.5	673.5	723.5	773.5	823.5	873.5	923.5	973.5	1023.5	1073.5	1123.5	1173.5	1223.5	1273.5	1323.5											
Mass (kg)	11.9	12.7	13.6	14.4	15.3	16.2	17.0	17.9	18.7	19.6	20.4	21.3	22.1	23.0	23.9	24.7	25.6	26.4	27.3	28.1	29.0	29.8	30.7	31.5	32.4												
Maximum speed (mm/s)	Lead 40		1800																																		
	Lead 20		1200																	1165	1045	940	850	770	705	645	595	545	505	470	440	410					
	Lead 10		600																	585	520	470	425	385	350	320	295	275	255	235	220	205					

*If the brake is equipped, the mass increases by 0.5kg. *The maximum speed (mm/s) varies depending on the stroke.

Applicable Controller Specifications

Applicable Controller	Maximum number of controlled axes	Connectable encoder type	Operating method	Power-supply voltage	Reference page
X-SEL-P/Q	6 axes	Absolute/ incremental	Program	Single/three-phase 200 VAC	→P56
X-SEL-J/K	4 axes				→P56
SSEL	2 axes				→P56
SCON	1 axis				Positioner pulse train control →P56

(Note 1) Refer to P.9 for the relationship of acceleration and payload. (Notes 2, 3, 4) The values in [] apply to the ISPDBCR series. Other specification values apply commonly to the ISDBCR and ISPDBCR. (Note 5) When the traveling life is 10,000km. (Note 6) The value of dynamic straightness is when the high straightness, precision specification (option) is specified. (Note 7) The maximum cable length is 30m. Specify a desired length in meters. (Example. X08 = 8m)

49

ISDBCR-L-200/ISPDBCR-L-200

Sold & Serviced By:
ELECTROMATE

Toll Free Phone (877) SERV098
Toll Free Fax (877) SERV099
www.electromate.com
sales@electromate.com

ISDBCR-L-400

Single-axis robot for cleanroom/Large/Actuator width: 150mm/400W Straight shape

ISPDBCR-L-400

Single-axis robot for cleanroom/Large/Actuator width: 150mm/400 W Straight shape **High precision specification**



Model Specification Items

Series	Type	Encoder type	Motor type	Lead	Stroke	Applicable controller	Cable length	Options
ISDBCR: Standard specification ISPDBCR: High precision specification	L	A: Absolute specification I: Incremental specification	400: 400W	40: 40mm 20: 20mm 10: 10mm	100: 100mm ? 1300: 1300mm (in 50mm increments)	T1: XSEL-J/K T2: SCON SSEL XSEL-P/Q	N: None S: 3m M: 5m X□□: Specified length	Refer to the options table below.

* Refer to P. 10 for the details of items comprising the model number.

Model Number/Specification

Model number	Encoder type	Motor output (W)	Lead (mm)	Stroke in 50mm increments (mm)	Speed (mm/s)	Acceleration (Note 1)				Payload (Note 1)				Rated thrust (N)	Suction flow rate (Nℓ/min)
						Horizontal (G)		Vertical (G)		Horizontal (kg)		Vertical (kg)			
						Rated	Maximum	Rated	Maximum	Rated acceleration	Maximum acceleration	Rated acceleration	Maximum acceleration		
ISDBCR[ISPDBCR]-L-①-400-40-②-③-④-⑤	Absolute Incremental	400	40	100~1300	1~1800	0.4	1.0	0.4	1.0	40	17	8	5	169.6	180
ISDBCR[ISPDBCR]-L-①-400-20-②-③-④-⑤					1~1200	0.4	1.0	0.4	1.0	90	30	20	10	339.1	120
ISDBCR[ISPDBCR]-L-①-400-10-②-③-④-⑤					1~600	0.4	0.7	0.4	0.6	120	60	40	30	678.3	50

* In the above model numbers, ① indicates the encoder type, ② indicates the stroke, ③ indicates the applicable controller, ④ indicates the cable length, and ⑤ indicates the option(s).

Option

Name	Model number	Reference page	Name	Model number	Reference page
Cable exit from the left	A1S	→P11	Home limit switch	L	→P11
Cable exit from the rear left	A1E	→P11	Home limit switch on the opposite side	LL	→P11
Cable exit from the right	A3S	→P11	Master axis specification	LM	→P12
Cable exit from the rear right	A3E	→P11	Master axis specification (sensor on the opposite side)	LLM	→P12
AQ seal (standard feature)	AQ	→P11	Non-motor side specification	NM	→P12
Brake	B	→P11	Guide with ball retention mechanism	RT	→P12
Creep sensor	C	→P11	Slave axis specification	S	→P12
Creep sensor on the opposite side	CL	→P11	High straightness, precision specification	ST	→P13
			Suction tube joint on the opposite side	VR	→P12

Common Specifications

Positioning repeatability (Note 2)	±0.01mm (±0.005mm)
Drive method (Note 3)	Ball screw ø20mm, rolled C10 [equivalent to rolled C5]
Lost Motion (Note 4)	0.05mm [0.02mm] max.
Dynamic allowable load moment (Note 5)	Ma: 104.9N·m Mb: 149.9N·m Mc: 248.9N·m
Overhang load length	Ma direction: 750mm max. Mb, Mc directions: 750mm max.
Dynamic straightness (Note 6)	0.02mm/m max.
Base	Material: Aluminum, with white aluminate treatment
Applicable controller	T1: XSEL-J/K T2: XSEL-P/Q, SSEL, SCON
Cable length (Note 7)	N: None, S: 3m, M: 5m, X□□: Specified length
Grease	Low dust-raising grease (for ball screw and guide)
Cleanliness degree	Class 10 (0.1µm per 1cf)
Suction tube joint	Quick connect joint, applicable tube outer diameter ø12mm

Diagram

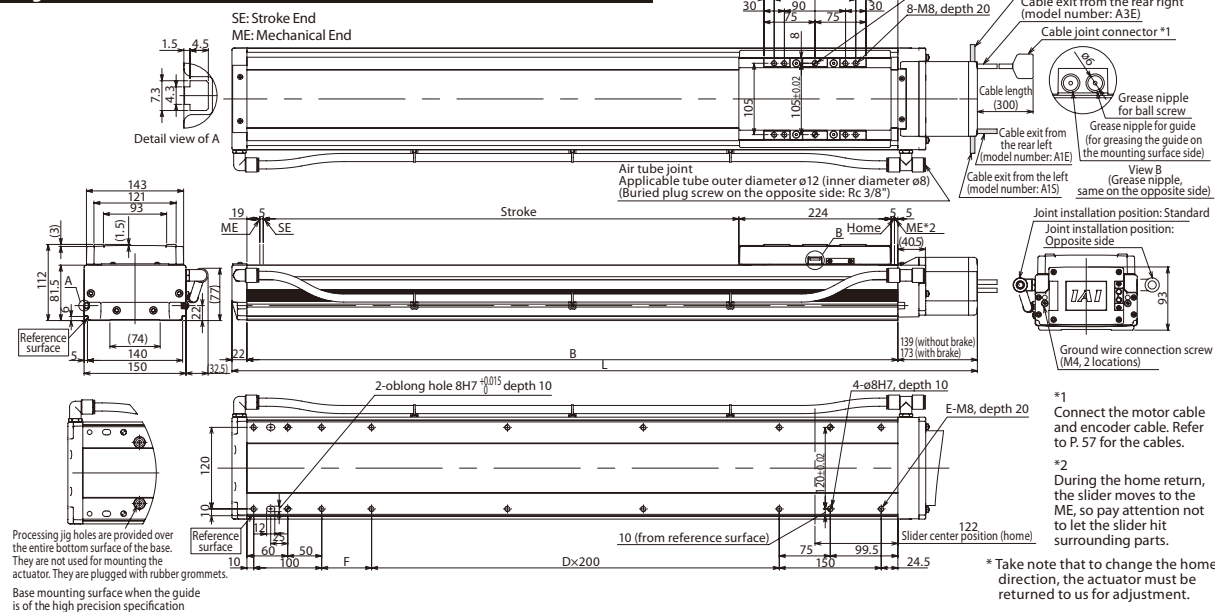

Dimensions, Mass and Maximum Speed by Stroke

*If the brake is equipped, the mass increases by 0.5kg. *The maximum speed (mm/s) varies depending on the stroke.

Stroke	L																E																F																Mass (kg)		Maximum speed (mm/s)																																																																																				
	100	150	200	250	300	350	400	450	500	550	600	650	700	750	800	850	900	950	1000	1050	1100	1150	1200	1250	1300	100	150	200	250	300	350	400	450	500	550	600	650	700	750	800	850	900	950	1000	1050	1100	1150	1200	1250	1300	Lead 40	Lead 20	Lead 10																																																																																		
without brake	519	569	619	669	719	769	819	869	919	969	1019	1069	1119	1169	1219	1269	1319	1369	1419	1469	1519	1569	1619	1669	1719	519	569	619	669	719	769	819	869	919	969	1019	1069	1119	1169	1219	1269	1319	1369	1419	1469	1519	1569	1619	1669	1719	519	569	619	669	719	769	819	869	919	969	1019	1069	1119	1169	1219	1269	1319	1369	1419	1469	1519	1569	1619	1669	1719	519	569	619	669	719	769	819	869	919	969	1019	1069	1119	1169	1219	1269	1319	1369	1419	1469	1519	1569	1619	1669	1719	12.3	13.1	14.0	14.8	15.7	16.6	17.4	18.3	19.1	20.0	20.8	21.7	22.5	23.4	24.3	25.1	26.0	26.8	27.7	28.5	29.4	30.2	31.1	31.9	32.8	1700	1540	1410	1290	1185	1095	1015	940	875	815
with brake	553	603	653	703	753	803	853	903	953	1003	1053	1103	1153	1203	1253	1303	1353	1403	1453	1503	1553	1603	1653	1703	1753	553	603	653	703	753	803	853	903	953	1003	1053	1103	1153	1203	1253	1303	1353	1403	1453	1503	1553	1603	1653	1703	1753	553	603	653	703	753	803	853	903	953	1003	1053	1103	1153	1203	1253	1303	1353	1403	1453	1503	1553	1603	1653	1703	1753	553	603	653	703	753	803	853	903	953	1003	1053	1103	1153	1203	1253	1303	1353	1403	1453	1503	1553	1603	1653	1703	1753	12.3	13.1	14.0	14.8	15.7	16.6	17.4	18.3	19.1	20.0	20.8	21.7	22.5	23.4	24.3	25.1	26.0	26.8	27.7	28.5	29.4	30.2	31.1	31.9	32.8	1700	1540	1410	1290	1185	1095	1015	940	875	815

Applicable Controller Specifications

Applicable Controller	Maximum number of controlled axes	Connectable encoder type	Operating method	Power-supply voltage	Reference page
X-SEL-P/Q	6 axes	Absolute/ incremental	Program	Single/three-phase 200 VAC	→P56
X-SEL-J/K	4 axes			Single-phase 100/200 VAC	→P56
SSEL	2 axes			Single-phase 200 VAC	→P56
SCON	1 axis			Positioner pulse train control	→P56

CAUTION

(Note 1) Refer to P. 9 for the relationship of acceleration and payload.
(Notes 2, 3, 4) The values in [] apply to the ISPDBCR series. Other specification values apply commonly to the ISDBCR and ISPDBCR.
(Note 5) When the traveling life is 10,000km.
(Note 6) The value of dynamic straightness is when the high straightness, precision specification (option) is specified.
(Note 7) The maximum cable length is 30m. Specify a desired length in meters. (Example. X08 = 8m)

ISDBCR-L-400/ISPDBCR-L-400

50

ISDBCR-LX-400

Single-axis robot for cleanroom/Large, mid-support type/Actuator width: 150mm/400W Straight shape

ISPDBCR-LX-400

Single-axis robot for cleanroom/Large, mid-support type/Actuator width: 150mm/400W Straight shape **High precision specification**

Model Specification Items	Series	Type	Encoder type	Motor type	Lead	Stroke	Applicable controller	Cable length	Options
ISDBCR: Standard specification ISPDBCR: High precision specification	LX	400	A: Absolute specification I: Incremental specification	400: 400W 40: 40mm 20: 20mm	1000: 1000mm 2500: 2500mm (in 100mm increments)	T1: XSEL-J/K T2: SCON SSEL XSEL-P/Q	N: None S: 3m M: 5m X□□: Specified length	Refer to the options table below.	

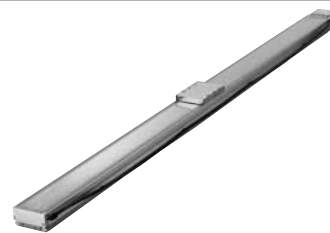

* Refer to P. 10 for the details of items comprising the model number.

Model Number/Specification

1.0G=9800mm/sec

Model number	Encoder type	Motor output (W)	Lead (mm)	Stroke in 100mm increments (mm)	Speed (mm/s)	Acceleration (Note 1)				Payload (Note 1)				Rated thrust (N)	Suction flow rate (Nℓ/min)
						Horizontal (G)		Vertical (G)		Horizontal (kg)		Vertical (kg)			
						Rated	Maximum	Rated	Maximum	Rated acceleration	Maximum acceleration	Rated acceleration	Maximum acceleration		
ISDBCR[ISPDBCR]-LX-①-400-40-②-③-④-⑤	Absolute Incremental	400	40	1000~2500	1~1800	0.4		Designed exclusively for horizontal use		40		Designed exclusively for horizontal use		169.6	180
1~1200					0.4		90		339.1		120				

*In the above model numbers, ① indicates the encoder type, ② indicates the stroke, ③ indicates the applicable controller, ④ indicates the cable length, and ⑤ indicates the option(s).

Option

Name	Model number	Reference page	Name	Model number	Reference page
Cable exit from the left	A1S	→P11	Home limit switch	L	→P11
Cable exit from the rear left	A1E	→P11	Home limit switch on the opposite side	LL	→P11
Cable exit from the right	A3S	→P11	Master axis specification	LM	→P12
Cable exit from the rear right	A3E	→P11	Master axis specification (sensor on the opposite side)	LLM	→P12
AQ seal (standard feature)	AQ	→P11	Non-motor side specification	NM	→P12
Brake	B	→P11	Guide with ball retention mechanism	RT	→P12
Creep sensor	C	→P11	Slave axis specification	S	→P12
Creep sensor on the opposite side	CL	→P11	High straightness, precision specification	ST	→P13
			Suction tube joint on the opposite side	VR	→P12

Common Specifications

Positioning repeatability (Note 2)	±0.01mm [±0.005mm]
Drive method (Note 3)	Ball screw ø20mm, rolled C10 [equivalent to rolled C5]
Lost Motion (Note 4)	0.05mm [0.02mm] max.
Dynamic allowable load moment (Note 5)	Ma: 104.9N·m Mb: 149.9N·m Mc: 248.9N·m
Overhang load length	Ma direction: 750mm max. Mb, Mc directions: 750mm max.
Dynamic straightness (Note 6)	0.02mm/m max.
Base	Material: Aluminum, with white alumite treatment
Applicable controller	T1: XSEL-J/K T2: XSEL-P/Q, SSEL, SCON
Cable length (Note 7)	N: None, S: 3m, M: 5m, X□□: Specified length
Grease	Low dust-raising grease (for ball screw and guide)
Cleanliness degree	Class 10 (0.1µm per 1cf)
Suction tube joint	Quick connect joint, applicable tube outer diameter ø12mm

Diagram

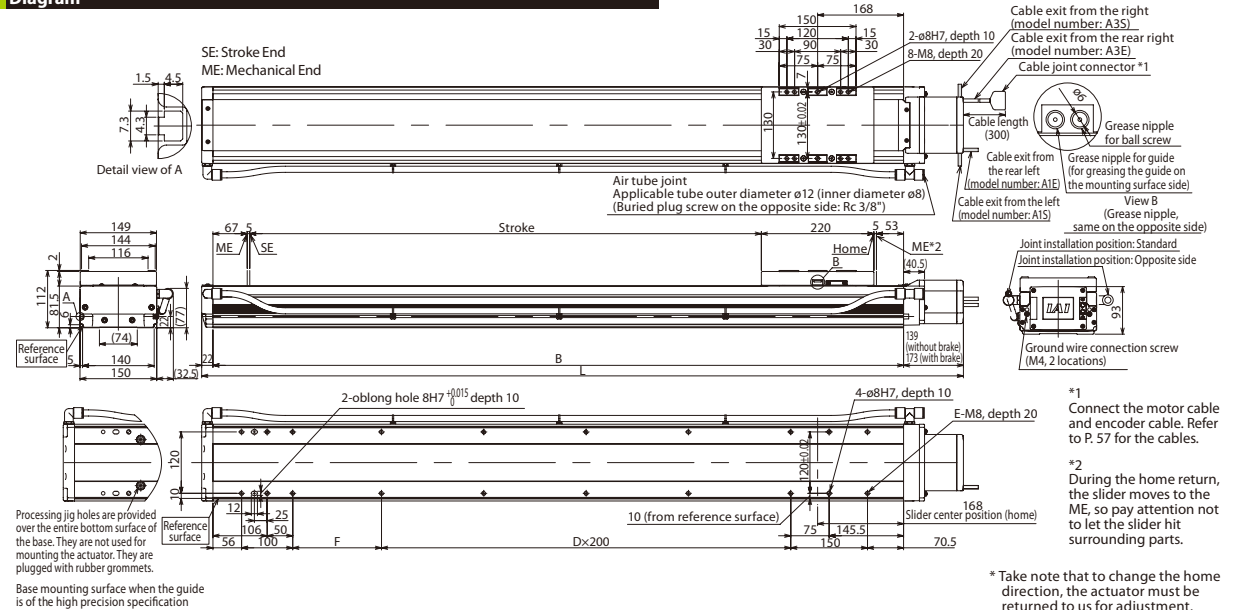

Dimensions, Mass and Maximum Speed by Stroke

*If the brake is equipped, the mass increases by 0.5kg. *The maximum speed (mm/s) varies depending on the stroke.

Stroke	1000	1100	1200	1300	1400	1500	1600	1700	1800	1900	2000	2100	2200	2300	2400	2500	
L	without brake	1511	1611	1711	1811	1911	2011	2111	2211	2311	2411	2511	2611	2711	2811	2911	3011
	with brake	1545	1645	1745	1845	1945	2045	2145	2245	2345	2445	2545	2645	2745	2845	2945	3045
B	1350	1450	1550	1650	1750	1850	1950	2050	2150	2250	2350	2450	2550	2650	2750	2850	
D	4	5	5	6	6	7	7	8	8	9	9	10	10	11	11	12	
E	16	18	18	20	20	22	22	24	24	26	26	28	28	30	30	32	
F	173.5	73.5	173.5	73.5	173.5	73.5	173.5	73.5	173.5	73.5	173.5	73.5	173.5	73.5	173.5	73.5	
Mass (kg)	30.2	31.9	33.6	35.4	37.1	38.8	40.6	42.3	44.0	45.8	47.5	49.2	51.0	52.7	54.4	56.2	
Maximum speed (mm/s)	Lead 40	1800															
	Lead 20	1200															
				1150	1000	950	830	740	650	590	540	490	440	410	370	340	

Applicable Controller Specifications

Applicable Controller	Maximum number of controlled axes	Connectable encoder type	Operating method	Power-supply voltage	Reference page
X-SEL-P/Q	6 axes	Absolute/incremental	Program	Single/three-phase 200VAC	→P56
X-SEL-J/K	4 axes			Single-phase 100/200VAC	→P56
SSEL	2 axes			Single-phase 200VAC	→P56
SCON	1 axis			Positioner pulse train control	→P56

CAUTION

(Note 1) Refer to P.9 for the relationship of acceleration and payload. (Notes 2, 3, 4) The values in [] apply to the ISPDBCR series. Other specification values apply commonly to the ISDBCR and ISPDBCR.

(Note 5) When the traveling life is 10,000km.

(Note 6) The value of dynamic straightness is when the high straightness, precision specification (option) is specified.

(Note 7) The maximum cable length is 30m. Specify a desired length in meters. (Example. X08 = 8m)

ISDBCR-LX-400/ISPDBCR-LX-400

52

SSPDACR-S-200

Single-axis robot for cleanroom/Small, high-rigidity, iron-base type/Actuator width: 100mm/200W
Straight shape **High precision specification**



Model Specification Items	SSPDACR	S								
	Series	Type	Encoder type	Motor type	Lead	Stroke	Applicable controller	Cable length	Options	
	SSPDACR: High precision specification		A: Absolute specification I: Incremental specification	200: 200W	30: 30mm 20: 20mm 10: 10mm	100: 100mm 1100: 1100mm (in 50mm increments)	T1: XSEL-J/K T2: SCON SSEL XSEL-P/Q	N: None S: 3m M: 5m X□□: Specified length	Refer to the options table below.	

* Refer to P. 10 for the details of items comprising the model number.

Model Number/Specification

Model number	Encoder type	Motor output (W)	Lead (mm)	Stroke in 50mm increments (mm)	Speed (mm/s)	Acceleration (Note 1)				Payload (Note 1)				Rated thrust (N)	Suction flow rate (Nℓ/min)
						Horizontal (G)		Vertical (G)		Horizontal (kg)		Vertical (kg)			
						Rated	Maximum	Rated	Maximum	Rated acceleration	Maximum acceleration	Rated acceleration	Maximum acceleration		
SSPDACR-S-①-200-30-②-③-④-⑤	Absolute Incremental	200	30	100~1100	1~1600	0.4	1.2	0.4	1.2	30	10	4	1	113.9	150
SSPDACR-S-①-200-20-②-③-④-⑤			20		1~1100	0.4	1.0	0.4	1.0	45	17	6	2.4	170.9	100
SSPDACR-S-①-200-10-②-③-④-⑤			10		1~600	0.4	0.7	0.4	0.6	90	50	12	8	341.8	50

* In the above model numbers, ① indicates the encoder type, ② indicates the stroke, ③ indicates the applicable controller, ④ indicates the cable length, and ⑤ indicates the option(s).

Option

Name	Model number	Reference page	Name	Model number	Reference page
Cable exit from the left	A1S	→P11	Home limit switch	L	→P11
Cable exit from the rear left	A1E	→P11	Home limit switch on the opposite side	LL	→P11
Cable exit from the right	A3S	→P11	Master axis specification	LM	→P12
Cable exit from the rear right	A3E	→P11	Master axis specification (sensor on the opposite side)	LLM	→P12
AQ seal (standard feature)	AQ	→P11	Non-motor side specification	NM	→P12
Brake	B	→P11	Guide with ball retention mechanism	RT	→P12
Creep sensor	C	→P11	Slave axis specification	S	→P12
Creep sensor on the opposite side	CL	→P11	High straightness, precision specification	ST	→P13
			Suction tube joint on the opposite side	VR	→P12

Common Specifications

Positioning repeatability	±0.005mm
Drive method	Ball screw ø16mm equivalent to rolled C5
Lost Motion	0.02mm max.
Dynamic allowable load moment (Note 2)	Ma: 36N·m Mb: 36N·m Mc: 98N·m
Overhang load length	Ma direction: 450mm max. Mb, Mc directions: 450mm max.
Dynamic straightness (Note 3)	0.015mm/m max.
Base	Material: Cast iron with coating
Applicable controller	T1: XSEL-J/K T2: XSEL-P/Q, SSEL, SCON
Cable length (Note 4)	N: None, S: 3m, M: 5m, X□□: Specified length
Grease	Low dust-raising grease (for ball screw and guide)
Cleanliness degree	Class 10 (0.1µm per 1cf)
Suction tube joint	Quick connect joint, applicable tube outer diameter ø12mm

Diagram

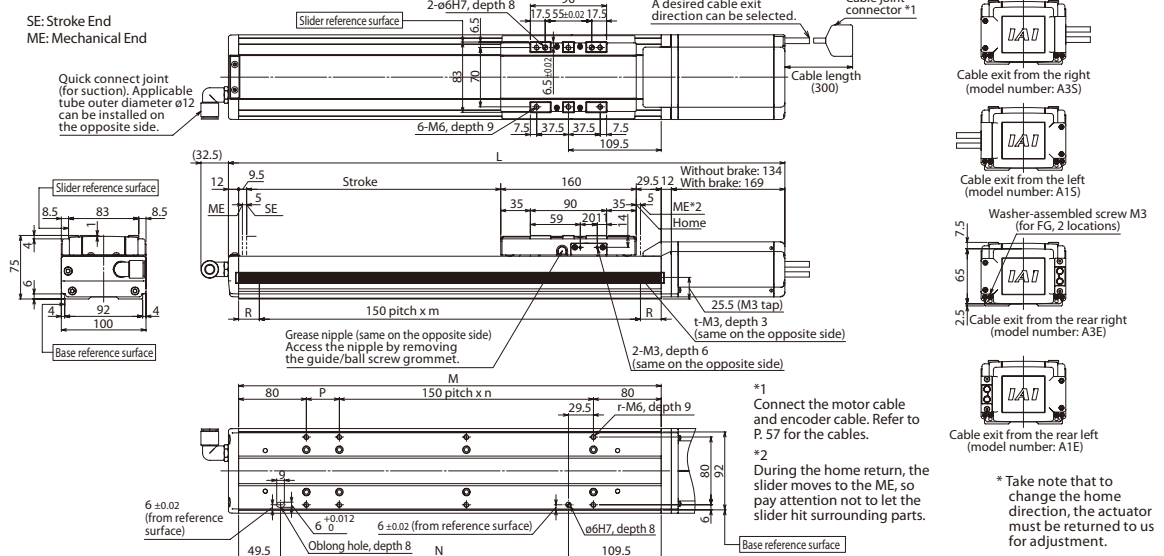

Dimensions, Mass and Maximum Speed by Stroke

Stroke	L											M											N											P											R											m											n											r											t																																																																																																																																																																																																															
	100	150	200	250	300	350	400	450	500	550	600	650	700	750	800	850	900	950	1000	1050	1100	100	150	200	250	300	350	400	450	500	550	600	650	700	750	800	850	900	950	1000	1050	1100	100	150	200	250	300	350	400	450	500	550	600	650	700	750	800	850	900	950	1000	1050	1100	100	150	200	250	300	350	400	450	500	550	600	650	700	750	800	850	900	950	1000	1050	1100	100	150	200	250	300	350	400	450	500	550	600	650	700	750	800	850	900	950	1000	1050	1100	100	150	200	250	300	350	400	450	500	550	600	650	700	750	800	850	900	950	1000	1050	1100	100	150	200	250	300	350	400	450	500	550	600	650	700	750	800	850	900	950	1000	1050	1100																																																																																																																																																					
without brake	457	507	557	607	657	707	757	807	857	907	957	1007	1057	1107	1157	1207	1257	1307	1357	1407	1457	299	349	399	449	499	549	599	649	699	749	799	849	899	949	999	1049	1099	1149	1199	1249	1299	140	190	240	290	340	390	440	490	540	590	640	690	740	790	840	890	940	990	1040	1090	1140	139	39	89	139	39	89	139	39	89	139	39	89	139	39	89	139	39	89	139	39	89	139	39	89	74.5	24.5	49.5	74.5	24.5	49.5	74.5	24.5	49.5	74.5	24.5	49.5	74.5	24.5	49.5	74.5	24.5	49.5	74.5	24.5	49.5	74.5	24.5	49.5	1	2	2	2	3	3	3	4	4	4	5	5	5	6	6	6	7	7	7	7	7	8	8	8	0	1	1	1	2	2	2	3	3	3	4	4	4	5	5	5	6	6	6	7	7	7	7	7	4	6	6	6	8	8	8	8	10	10	10	12	12	14	14	14	16	16	16	18	18	18	18	18	2	3	3	3	4	4	4	5	5	5	6	6	6	7	7	7	8	8	8	9	9	9	9	9	Mass (kg)	7.5	8.1	8.7	9.3	10.0	10.6	11.2	11.8	12.4	13.0	13.7	14.3	14.9	15.5	16.1	16.7	17.3	18.0	18.6	19.2	19.8	Maximum speed (mm/s)	Lead 30	1600																					Lead 20	1100																					Lead 10	600																				

Applicable Controller Specifications

Applicable Controller	Maximum number of controlled axes	Connectable encoder type	Operating method	Power-supply voltage	Reference page
X-SEL-P/Q	6 axes	Absolute/incremental	Program	Single/three-phase 200 VAC	→P56
X-SEL-J/K	4 axes			Single-phase 100/200 VAC	→P56
SSEL	2 axes			→P56	
SCON	1 axis			Positioner pulse train control	→P56



(Note 1) Refer to P. 9 for the relationship of acceleration and payload.
 (Note 2) When the traveling life is 10,000 km.
 (Note 3) The value of dynamic straightness is when the high straightness, precision specification (option) is specified.
 (Note 4) The maximum cable length is 30 m. Specify a desired length in meters. (Example, X08 = 8 m)

53

SSPDACR-S-200

SSPDACR-M-400

Single-axis robot for cleanroom/Medium, high-rigidity, iron-base type/Actuator width: 130mm/400W
Straight shape **High precision specification**



Model Specification Items	SSPDACR	M	400						
	Series	Type	Encoder type	Motor type	Lead	Stroke	Applicable controller	Cable length	Options
	SSPDACR: High precision specification		A: Absolute specification I: Incremental specification	400: 400W 40: 40mm 20: 20mm 10: 10mm	100: 100mm 1300: 1300mm (in 50mm increments)	T1: XSEL-J/K T2: SCON SSEL XSEL-P/Q	N: None S: 3m M: 5m X□□: Specified length		Refer to the options table below.

* Refer to P. 10 for the details of items comprising the model number.

Model number	Encoder type	Motor output (W)	Lead (mm)	Stroke in 50mm increments (mm)	Speed (mm/s)	Acceleration (Note 1)				Payload (Note 1)				Rated thrust (N)	Suction flow rate (Nl/min)
						Horizontal (G)		Vertical (G)		Horizontal (kg)		Vertical (kg)			
						Rated	Maximum	Rated	Maximum	Rated acceleration	Maximum acceleration	Rated acceleration	Maximum acceleration		
SSPDACR-M-①-400-40-②-③-④-⑤	Absolute Incremental	400	40	100~1300	1~1600	0.4	1.2	0.4	1.2	45	13.5	6	2	169.6	160
SSPDACR-M-①-400-20-②-③-④-⑤			20		1~1100	0.4	1.0	0.4	1.0	90	34	12	4.8	339.1	110
SSPDACR-M-①-400-10-②-③-④-⑤			10		1~600	0.4	0.7	0.4	0.6	120	70	25	16.5	678.3	60

*In the above model numbers, ① indicates the encoder type, ② indicates the stroke, ③ indicates the applicable controller, ④ indicates the cable length, and ⑤ indicates the option(s).

Option

Name	Model number	Reference page	Name	Model number	Reference page
Cable exit from the left	A1S	→P11	Home limit switch	L	→P11
Cable exit from the rear left	A1E	→P11	Home limit switch on the opposite side	LL	→P11
Cable exit from the right	A3S	→P11	Master axis specification	LM	→P12
Cable exit from the rear right	A3E	→P11	Master axis specification (sensor on the opposite side)	LLM	→P12
AQ seal (standard feature)	AQ	→P11	Non-motor side specification	NM	→P12
Brake	B	→P11	Guide with ball retention mechanism	RT	→P12
Creep sensor	C	→P11	Slave axis specification	S	→P12
Creep sensor on the opposite side	CL	→P11	High straightness, precision specification	ST	→P13
			Suction tube joint on the opposite side	VR	→P12

Common Specifications

Positioning repeatability	±0.005mm
Drive method	Ball screw ø20mm equivalent to rolled C5
Lost Motion	0.02mm max.
Dynamic allowable load moment (Note 2)	Ma: 90N·m Mb: 90N·m Mc: 230N·m
Overhang load length	Ma direction: 600mm max. Mb, Mc directions: 600mm max.
Dynamic straightness (Note 3)	0.015mm/m max.
Base	Material: Cast iron with coating
Applicable controller	T1: XSEL-J/K T2: XSEL-P/Q, SSEL, SCON
Cable length (Note 4)	N: None, S: 3m, M: 5m, X□□: Specified length
Grease	Low dust-raising grease (for ball screw and guide)
Cleanliness degree	Class 10 (0.1µm per lcf)
Suction tube joint	Quick connect joint, applicable tube outer diameter ø12mm

Diagram

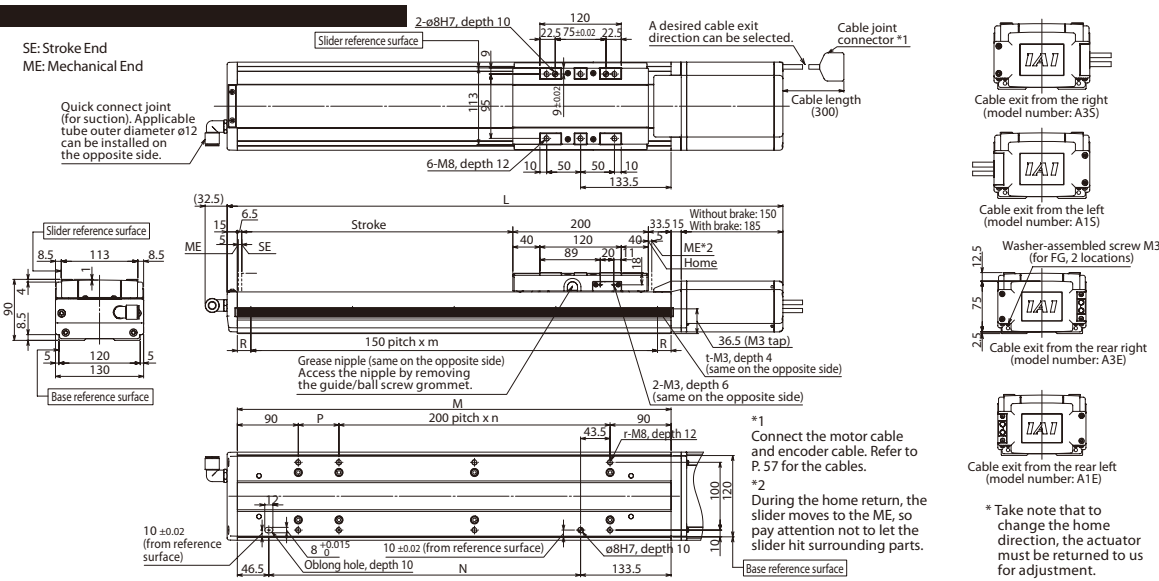

Dimensions, Mass and Maximum Speed by Stroke

*If the brake is equipped, the mass increases by 0.6kg. *The maximum speed (mm/s) varies depending on the stroke.

Stroke	100	150	200	250	300	350	400	450	500	550	600	650	700	750	800	850	900	950	1000	1050	1100	1150	1200	1250	1300	
L	without brake	520	570	620	670	720	770	820	870	920	970	1020	1070	1120	1170	1220	1270	1320	1370	1420	1470	1520	1570	1620	1670	1720
	with brake	555	605	655	705	755	805	855	905	955	1005	1055	1105	1155	1205	1255	1305	1355	1405	1455	1505	1555	1605	1655	1705	1755
M		340	390	440	490	540	590	640	690	740	790	840	890	940	990	1040	1090	1140	1190	1240	1290	1340	1390	1440	1490	1540
N		160	210	260	310	360	410	460	510	560	610	660	710	760	810	860	910	960	1010	1060	1110	1160	1210	1260	1310	1360
P		160	210	260	310	360	410	460	510	560	610	660	710	760	810	860	910	960	1010	1060	1110	1160	1210	1260	1310	1360
R		20	45	70	20	45	70	20	45	70	20	45	70	20	45	70	20	45	70	20	45	70	20	45	70	20
m		2	2	2	3	3	4	4	4	5	5	5	6	6	6	7	7	7	8	8	8	8	9	9	9	10
n		0	0	1	1	1	1	2	2	2	2	3	3	3	4	4	4	4	5	5	5	5	6	6	6	6
r		4	4	6	6	6	8	8	8	8	8	10	10	10	12	12	12	12	14	14	14	14	16	16	16	16
t		3	3	3	4	4	4	5	5	5	6	6	6	7	7	7	8	8	8	9	9	10	10	10	10	11
Mass (kg)		13.9	15.0	16.0	17.1	18.1	19.2	20.2	21.3	22.3	23.4	24.4	25.5	26.5	27.6	28.7	29.7	30.8	31.8	32.9	33.9	35.0	36.0	37.1	38.1	39.2
Maximum speed (mm/s)	Lead 40																									
	Lead 20																									
	Lead 10																									

Applicable Controller Specifications

Applicable Controller	Maximum number of controlled axes	Connectable encoder type	Operating method	Power-supply voltage	Reference page
X-SEL-P/Q	6 axes	Absolute/ incremental	Program	Single/three-phase 200 VAC	→P56
X-SEL-J/K	4 axes			Single-phase 100/200 VAC	→P56
SSEL	2 axes			Single-phase 200 VAC	→P56
SCON	1 axis			Positioner pulse train control	→P56





CAUTION

(Note 1) Refer to P. 9 for the relationship of acceleration and payload.
 (Note 2) When the traveling life is 10,000 km.
 (Note 3) The value of dynamic straightness is when the high straightness, precision specification (option) is specified.
 (Note 4) The maximum cable length is 30 m. Specify a desired length in meters. (Example. X08 = 8 m)

SSPDACR-M-400

The ISB/ISPB/SSPA/ISDB/ISPDB/ISDBCR/ISPDCR/SSPDACR can be operated with the following controllers.

Select a controller that meets the specifications of your equipment. *For details, refer to the ROBO Cylinder General Catalog.

	Controller series/type	SCON	SSEL	XSEL	
				J/K type	P/Q type
Base specifications	External view				
	Features	<ul style="list-style-type: none"> A positioner controller supporting up to 512 positioning points For control modes, the pulse-train input mode is supported in addition to the positioner mode. 	<ul style="list-style-type: none"> A program controller capable of 2-axis interpolation operation. Offering excellent cost performance, although scalability is lower than XSEL controllers. 	<ul style="list-style-type: none"> A high-function controller capable of interpolation operation involving up to 4 axes. Can be operated on 100 VAC. 	<ul style="list-style-type: none"> A high-function controller capable of interpolation operation involving up to 6 axes. Actuators of a total wattage of 2400W can be connected.
	Power capacity	60W/186VA 100W/282VA 200W/469VA 400W/844VA 750W/1569VA	60W/198VA 100W/294VA 200W/481VA 400W/856VA 750W/1581VA (The above assumes a 1-axis specification.)	The specifications vary. Contact IAI for details.	
	Input power supply	Single-phase 100 VAC Single-phase 200 VAC	Single-phase 100 VAC Single-phase 200 VAC	Single-phase 100 VAC Single-phase 200 VAC	Single-phase 200 VAC Three-phase 200 VAC
	Operating power-supply voltage range	±10%			
	Control specifications	Total maximum output of connected axes (W)	200W (100-V power-supply specification) 750W (200-V power-supply specification)	400W (100-V power-supply specification) 800W (200-V power-supply specification)	400W (XSEL-J, single-phase, 100 V) 800W (XSEL-K, single-phase, 100 V)
Maximum number of controlled axes		1 axis	2 axes	4 axes	6 axes
Position detection method		Incremental encoder/Absolute encoder			
Operation method		Positioner operation Pulse-train control	Program operation Positioner operation (switchable)	Program operation	
Program	Program language	—	Super SEL language		
	Number of programs	—	128	64	128
	Number of program steps	—	9,999	6,000	9,999
	Number of multi-task programs	—	8	16	16
	Number of positions	512 max.	20,000	3,000	20,000
	Data input devices (optional)	Teaching pendant Model number: CON-PT/CON-T RCM-E/RCM-P PC software Model number: RCM-101-MW (for RS232 communication) RCM-101-USB (for USB communication)	Teaching pendant Model number: SEL-T-J SEL-TD-J IA-T-X-J IA-T-XD-J PC software Model number: IA-101-X-MW-J (for RS232 communication) IA-101-X-USB (for USB communication)	Teaching pendant Model number: IA-T-X/XD SEL-TG (for both XSEL-J/K) SEL-T/TD (for XSEL-K) PC software Model number: IA-101-X-MW (for RS232 communication) IA-101-X-USBMW (for USB communication)	Teaching pendant Model number: SEL-T/TD/TG IA-T-X/XD PC software Model number: IA-101-X-MW IA-101-X-USBMW (for XSEL-P) Model: IA-101-XA-MW (for XSEL-Q)
Inputs/Outputs and communication	Standard inputs/outputs	16 input points/16 output points (NPN/PNP selectable)	24 input points/8 output points (NPN/PNP selectable)	32 input points/16 output points (NPN/PNP selectable)	
	Extended inputs/outputs	Not supported		Total 80 input/output points (XSEL-J) Total 336 input/output points (XSEL-K)	Total 384 input/output points
	Field network	DeviceNet, CC-Link, ProfiBus		DeviceNet, CC-Link, ProfiBus, Ethernet	
Ambient conditions	Ambient operating temperature/humidity	0 to 40°C 10 to 95% (non-condensing)			
	Operating ambience	There shall be no corrosive gases or excessive powder dust.			
	External dimensions	58 (W) x 200.5 (H) x 121 (D) (200W or less) 72 (W) x 200.5 (H) x 121 (D) (400W or more)	100 (W) x 202.6 (H) x 126 (D) (when the absolute battery installed)	159.4 (W) x 195 (H) x 125.3 (D) (XSEL-J, 1-axis specification) 369.4 (W) x 195 (H) x 125.3 (D) (XSEL-K, 1-axis, 2-axes specification)	265 (W) x 195 (H) x 125.3 (D) (XSEL-P, 1-axis specification) 222 (W) x 195 (H) x 125.3 (D) (XSEL-Q, 1-axis specification)
	Mass	0.8 to 1.1 kg	1.4kg	2.6 to 5.0 kg (XSEL-J) 6.0 to 7.0 kg (XSEL-K)	5.2 to 5.7 kg (XSEL-P) 4.5 to 5.0 kg (XSEL-Q)
	Accessories	I/O flat cable (40 cores)	I/O flat cable (34 cores)	I/O flat cable (50 cores)	

■ When the SCON controller is connected

Note The regenerative resistance unit may be required depending on the actuator used. For details, refer to the ROBO Cylinder General Catalog.



Actuator

Motor cable
Model number: CB-X-MA□□□
(Supplied with the actuator)

Encoder cable
Model number: CB-X1-PA□□□
(for standard specification)
Model number: CB-X1-PLA□□□
(for sensor specification)
(Supplied with the actuator)

Main power Single-phase 100 VAC
Single-phase 200 VAC

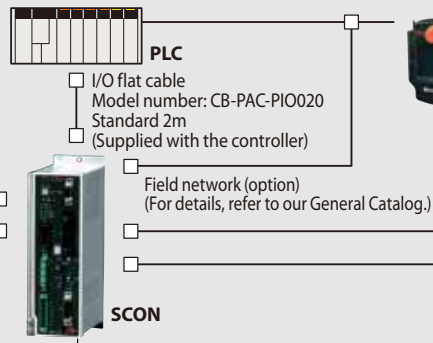

Teaching pendant (optional)

Model: CON-PT-M
Model: CON-T
Model: RCM-E
Model: RCM-P

PC software (optional)

RS232 connection version
Model number: RCM-101-MW
USB connection version
Model number: RCM-101-USB

* Be sure to use a noise filter on the power supply. (For the recommended models, refer to the ROBO Cylinder General Catalog.)

■ When the SSEL controller is connected

Note The regenerative resistance unit may be required depending on the actuator used. For details, refer to the ROBO Cylinder General Catalog.



Actuator

Motor cable
Model number: CB-X-MA□□□
(Supplied with the actuator)

Encoder cable
Model number: CB-X1-PA□□□
(for standard specification)
Model number: CB-X1-PLA□□□
(for sensor specification)
(Supplied with the actuator)

Main power Single-phase 100 VAC
Single-phase 200 VAC

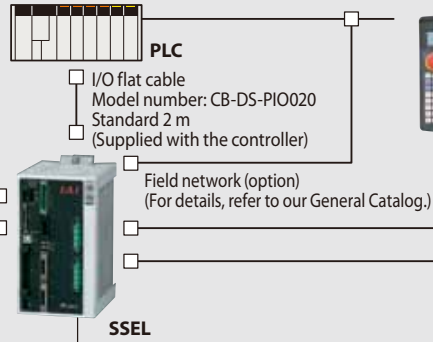

Teaching pendant (optional)

Model: SEL-T-J
Model: SEL-TD-J
Model: IA-T-X-J
Model: IA-T-XD-J

PC software (optional)

RS232 connection version
Model number: IA-101-X-MW-J
USB connection version
Model number: IA-101-X-USB

* Be sure to use a noise filter on the power supply. (For the recommended models, refer to the ROBO Cylinder General Catalog.)

■ When the XSEL-J/K controller is connected

Note The regenerative resistance unit may be required depending on the actuator used. For details, refer to the ROBO Cylinder General Catalog.



Actuator

Motor cable
Model number: CB-X-MA□□□
(Supplied with the actuator)

Encoder cable
Model number: CB-X-PA□□□
(Supplied with the actuator)
Limit switch cable
Model number: CB-X-LC□□□ (for sensor specification)
(Supplied with the actuator)

Main power Single-phase 100 VAC
Single-phase 200 VAC

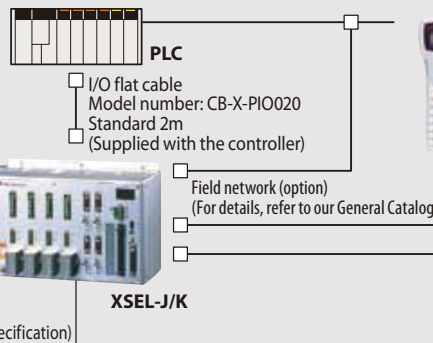

Teaching pendant (optional)

Model number: IA-T-X
Model number: IA-T-XD
Model number: SEL-T
Model number: SEL-TD
Model number: SEL-TG
* The SEL-T/SEL-TD cannot be used with the XSEL-J.

PC software (optional)

RS232 connection version
Model number: IA-101-X-MW
USB connection version
Model number: IA-101-X-USBMW

* Be sure to use a noise filter on the power supply. (For the recommended models, refer to the ROBO Cylinder General Catalog.)

■ When the XSEL-P/Q controller is connected

Note The regenerative resistance unit may be required depending on the actuator used. For details, refer to the ROBO Cylinder General Catalog.



Actuator

Motor cable
Model number: CB-X-MA□□□
(Supplied with the actuator)

Encoder cable
Model number: CB-X1-PA□□□
(Supplied with the actuator)
Encoder cable with limit switch wiring
Model number: CB-X1-PLA□□□ (for sensor specification)
(Supplied with the actuator)

Main power Single-phase 200 VAC
Three-phase 200 VAC

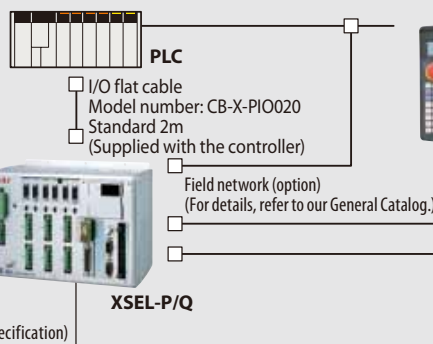

Teaching pendant (optional)

Model number: SEL-T
Model number: SEL-TD
Model number: SEL-TG
Model number: IA-T-X
Model number: IA-T-XD

PC software (optional)

RS232 connection version
Model number: IA-101-X-MW
Model number: IA-101-XA-MW (for XSEL-Q)
USB connection version
Model number: IA-101-X-USBMW

* Be sure to use a noise filter on the power supply. (For the recommended models, refer to the ROBO Cylinder General Catalog.)