

Harmonic Drive[®]

AC Servo Actuator

SHA SG/CG series manual

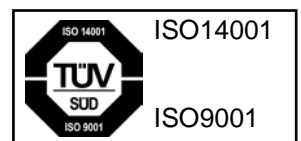
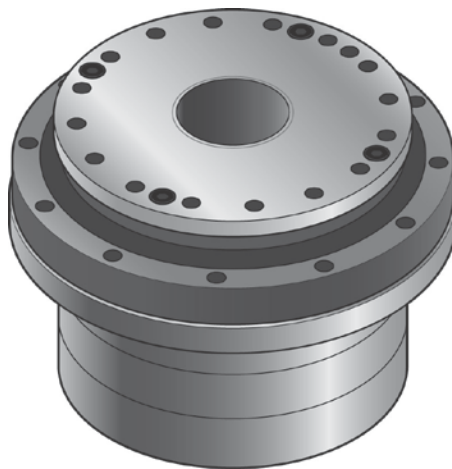

Introduction

Thank you for purchasing our SHA series AC Servo Actuator.



- Improper handling or use of this product may result in an accident or reduced life of the product. Read this document carefully and use the product correctly so that the product can be used safely for many years to come.
- Product specifications are subject to change without notice.
- Keep this manual in a convenient location and refer to it as necessary when operating or maintaining the actuator.
- The end user of the actuator should have a copy of this manual.

SAFETY GUIDE

To use this actuator safely and correctly, be sure to read SAFETY GUIDE and other parts of this document carefully and fully understand the information provided herein before using the actuator.

NOTATION

Important safety information you must note is provided herein. Be sure to observe these instructions.

 WARNING	Indicates a potentially hazardous situation, which, if not avoided, could result in death or serious personal injury.
 CAUTION	Indicates a potentially hazardous situation, which, if not avoided, may result in minor or moderate personal injury and/or damage to the equipment.
Caution	Indicates what should be performed or avoided to prevent non-operation or malfunction of the product or negative effects on its performance or function.

LIMITATION OF APPLICATIONS

The equipment listed in this document may not be used for the applications listed below:

- Space equipment
- Automobile, automotive parts
- Aircraft, aeronautic equipment
- Amusement equipment, sport equipment, game machines
- Nuclear equipment
- Machine or devices acting directly on the human body
- Household apparatus
- Instruments or devices to transport or carry people
- Vacuum equipment
- Apparatus or devices used in special environments

If the above list includes your intending application for our products, please consult us.



Safety measures are essential to prevent accidents resulting in death, injury or damage of the equipment due to malfunction or faulty operation.

SAFETY NOTE

ITEMS YOU SHOULD NOTE WHEN USING THE ACTUATOR

● CAUTIONS RELATED TO THE DESIGN



Always use under followings conditions.

The actuator is designed to be used indoors. Observe the following conditions:

- Ambient temperature: 0 to 40 °C
- Ambient humidity: 20 to 80 %RH (Non-condensation)
- Vibration: Max 25 m/s²
- No contamination by water, oil
- No corrosive or explosive gas

Follow exactly the instructions in the relating manuals to install the actuator in the equipment.

- Ensure exact alignment of the actuator center and the center of the corresponding machine by following the manual.
- Failure to observe this caution may lead to vibration, resulting in damage of output elements.

● CAUTIONS FOR USAGE



Keep limited torques of the actuator.

- Keep limited torques of the actuator.
- Be aware, that if arms attached to output element hits by accident an solid, the output element may be uncontrollable.

Never connect cables directly to a power supply socket.

- Each actuator must be operated with a proper driver.
- Failure to observe this caution may lead to injury, fire or damage of the actuator.

Do not apply impacts and shocks

- The actuator directly connects with the encoder so do not use a hammer during installation.
- Failure to observe this caution could damage the encoder and may cause uncontrollable operation.

Avoid handling of actuators by cables.

- Failure to observe this caution may damage the wiring, causing uncontrollable or faulty operation.

ITEMS YOU SHOULD NOTE WHEN USING THE DRIVER

● CAUTIONS RELATED TO THE DESIGN



Always use drives under followings conditions.

The driver generates heat. Use under the following conditions while paying careful attention to the heat radiation.

- Mount in a vertical position keeping sufficient clearance.
- 0 to 50 °C, 95 %RH or below (No condensation)
- No vibration or physical shock
- No dust, dirt, corrosive or inflammable gas

Use sufficient noise suppressing means and safe grounding.

Any noise generated on a signal wire will cause vibration or improper motion. Conform to the following conditions.

- Keep signal and power leads separated.
- Keep leads as short as possible.
- Ground actuator and driver at one single point, minimum ground resistance class: D (less than 100 ohms)
- Do not use a power line filter in the motor circuit.

Pay attention to negative torque by inverse load.

- Inverse load may cause damages of drivers.
- Please consult our sales office, if you intent to apply products for inverse load.

Use a fast-response type ground-fault detector designed for PWM inverters.

Do not use a time-delay-type ground-fault detector.

Safety measures are essential to prevent accidents resulting in death, injury or damage of the equipment due to malfunction or faulty operation.

● CAUTIONS FOR USAGE



Never change wiring while power is active.

Make sure of power non-active before servicing the products. Failure to observe this caution may result in electric shock or personal injury.

Do not touch terminals or inspect products at least 5 minutes after turning OFF power.

- Otherwise residual electric charges may result in electric shock.
- Make installation of products not easy to touch their inner electric components.



Do not make a voltage resistance test.

- Failure to observe this caution may result in damage of the control unit.
- Please consult our sales office, if you intent to use a voltage resistance test.

Do not operate control units by means of power ON/OFF switching.

- Start/stop operation should be performed via input signals.
- Failure to observe this caution may result in deterioration of electronic parts.

DISPOSAL



All products or parts have to be disposed of as industrial waste.

Since the case or the box of drivers have a material indication, classify parts and dispose them separately.

Contents

SAFETY GUIDE	1
NOTATION	1
LIMITATION OF APPLICATIONS.....	1
SAFETY NOTE	2
Contents	5
Related manuals	7
Conformance to overseas standards.....	7

Chapter 1 Outlines

1-1 Overview.....	1-1
1-2 Model	1-2
1-3 Drivers and extension cables.....	1-3
1-4 Specifications.....	1-4
1-5 Motor shaft holding brake	1-14
1-6 External dimensions.....	1-17
1-7 Mechanical accuracy	1-30
1-8 Positional accuracy.....	1-32
One-way positional accuracy.....	1-32
Repeatability (CG).....	1-33
Bi-directional repeatability (CG).....	1-33
1-9 Encoder specifications (Absolute encoder).....	1-34
1-10 Stiffness	1-36
Moment stiffness	1-36
Torsional stiffness (Ratio 50:1 or more: HarmonicDrive® speed reducer).....	1-37
Torsional stiffness (Ratio 11:1 HPF hollow shaft planetary speed reducer)	1-39
1-11 Rotation direction.....	1-40
1-12 Shock resistance.....	1-41
1-13 Resistance to vibration.....	1-42
1-14 Operable range	1-43
1-15 Cable specifications	1-59
Motor cable specifications	1-59
Encoder cable specifications	1-60

Chapter 2 Selection guidelines

2-1	SHA series selection	2-1
	Allowable load inertia moment.....	2-1
2-2	Change in load inertia moment	2-5
2-3	Verifying and examining load weights	2-6
	Maximum load moment load.....	2-7
	Verifying life.....	2-7
	Verifying static safety coefficients	2-9
2-4	Examining operating status.....	2-10
	Examining actuator rotation speed	2-10
	Calculating and examining load inertia moment.....	2-10
	Load torque calculation	2-11
	Acceleration time and deceleration time	2-12
	Examining effective torque and average rotation speed	2-13

Chapter 3 Installing the actuator

3-1	Receiving Inspection.....	3-1
	Inspection procedure	3-1
3-2	Notices on handling	3-2
	Installation and transmission torque	3-2
	Precautions on installation.....	3-4
	Use of positioning pins	3-5
	Surface treatments	3-5
3-3	Location and installation	3-6
	Environment of location	3-6
	Installation	3-7

Chapter 4 Options

4-1	Options	4-1
	With near origin and end limit sensors (option code: L)	4-1
	Cable exiting from side face (option code: Y).....	4-1
	Output shaft single revolution absolute model (option code: S)	4-1
	With stand (CG only, option code: V)	4-2
	Extension cables	4-4

Appendix

A-1	Unit conversion	5-1
A-2	Calculating inertia moment	5-3
	Formula of mass and inertia moment	5-3
	Inertia moment of cylinder	5-5

Related manual

The table below lists related manual. Check each item as necessary.

Title	Description
AC Servo Driver HA-800 series manual	The specifications and characteristics of HA-800 series are explained.

Conformance to overseas standards

The SHA series actuator conforms to following overseas standards.

UL Standard	UL1004-1,UL1004-6 (File No. E243316)
CSA Standard	C22.2 No.100
European Low Voltage EC Directives	EN60034-1, EN60034-5

UL nameplate sticker

The following specifications of the SHA series actuators are shown based on the UL1004-1,UL1004-6 (File No. E243316) standards.

Nameplate field	Explanation
(1)	Output [W] at point A on the graph below
(2)	Voltage [V] between motor wires at point A on the graph below
(3)	Allowable continuous current [A]
(4)	Rotation speed [r/min] at point A on the graph below
(5)	Current fundamental frequency [Hz] at point A on the graph below
(6)	Allowable range temperature [°C]
(7)	Number of phase

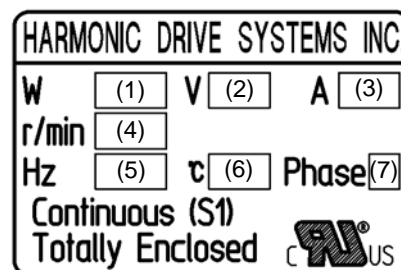

UL nameplate sticker

Aluminum radiation plate: 350×350×18 [mm]

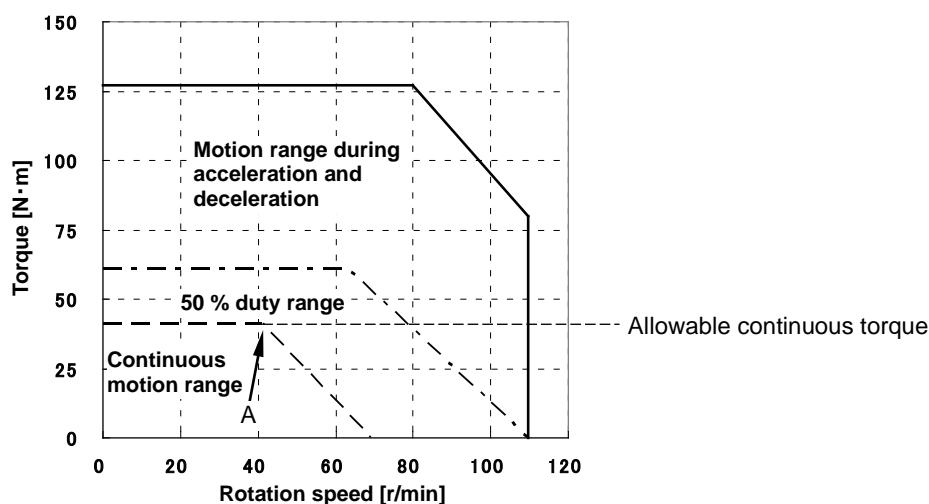

The nameplate values of various models are shown below.

SG/HP type

Item	Model	SHA20A				
		51	81	101	121	161
(1) Output at point A	W	99	109	109	106	86
(2) Voltage at point A	V	113	117	117	119	122
(3) Allowable continuous current	A	2.1	2.0	2.0	1.9	1.6
(4) Speed at point A	rpm	44	30	24	21	17
(5) Frequency at point A	Hz	187	203	202	212	228
(6) Allowable range temperature	°C	40				
(7) Number of phase	—	3				

Item	Model	SHA25A (Motor input voltage 100 V)					SHA25A (Motor input voltage 200 V)					
		51	81	101	121	161	11	51	81	101	121	161
		(1) Output at point A	W	165	188	190	178	127	133	175	203	207
(2) Voltage at point A	V	61	64	65	64	62	101	115	122	125	125	120
(3) Allowable continuous current	A	4.7	4.7	4.7	4.5	3.7	3.0	3.0	3.0	2.9	2.6	2.1
(4) Speed at point A	rpm	45	31	25	21	15	141	41	29	24.5	21	15
(5) Frequency at point A	Hz	191	209	210	212	201	129	174	196	206	212	201
(6) Allowable range temperature	°C	40										
(7) Number of phase	—	3										

Item	Model	SHA32A						SHA40A				
		11	51	81	101	121	161	51	81	101	121	161
(1) Output at point A	W	240	328	369	373	308	233	487	564	570	560	480
(2) Voltage at point A	V	97	110	114	118	116	115	109	115	115	116	122
(3) Allowable continuous current	A	6.0	6.0	6.0	5.7	5.0	4.1	9.0	9.0	9.0	8.8	7.2
(4) Speed at point A	rpm	115	34	23	20	16.5	12.5	29	20.5	16.5	14	12
(5) Frequency at point A	Hz	105	145	155	168	166	168	123	138	139	141	161
(6) Allowable range temperature	°C	40										
(7) Number of phase	—	3										

Item	Model	SHA45A				
		51	81	101	121	161
(1) Output at point A	W	456	534	543	551	537
(2) Voltage at point A	V	103	108	108	109	112
(3) Allowable continuous current	A	10.0	10.0	10.0	10.0	9.2
(4) Speed at point A	rpm	25	17.6	14.3	12	9.8
(5) Frequency at point A	Hz	107	119	120	121	132
(6) Allowable range temperature	°C	40				
(7) Number of phase	—	3				

Item	Model	SHA58A				SHA65A			
		81	101	121	161	81	101	121	161
(1) Output at point A	W	897	948	863	731	964	963	958	802
(2) Voltage at point A	V	99	101	101	107	92	92	96	100
(3) Allowable continuous current	A	17.7	17.8	16.4	13.4	22.0	21.9	20.1	16.3
(4) Speed at point A	rpm	12	10	8.5	7.2	10	8	7.4	6.2
(5) Frequency at point A	Hz	130	135	137	155	108	108	119	133
(6) Allowable range temperature	°C	40							
(7) Number of phase	—	3							

CG type

Item	Model	SHA20A				
		50	80	100	120	160
(1) Output at point A	W	97	108	108	106	85
(2) Voltage at point A	V	112	116	116	119	122
(3) Allowable continuous current	A	2.1	2.1	2.1	2.0	1.7
(4) Speed at point A	rpm	44	29.5	24	21	17
(5) Frequency at point A	Hz	183	197	200	210	227
(6) Allowable range temperature	°C	40				
(7) Number of phase	—	3				

Item	Model	SHA25A (Motor input voltage 100 V)					SHA25A (Motor input voltage 200 V)				
		50	80	100	120	160	50	80	100	120	160
		(1) Output at point A	W	167	191	192	174	127	177	201	204
(2) Voltage at point A	V	62	65	65	63	61	115	121	123	123	119
(3) Allowable continuous current	A	4.7	4.7	4.7	4.5	3.7	3.0	3.0	3.0	2.6	2.1
(4) Speed at point A	rpm	47	32	25.5	20.5	15	42	29	24	20.5	15
(5) Frequency at point A	Hz	196	213	213	205	200	175	193	200	205	200
(6) Allowable range temperature	°C	40									
(7) Number of phase	—	3									

Item	Model	SHA32A					SHA40A				
		50	80	100	120	160	50	80	100	120	160
(1) Output at point A	W	321	372	373	308	233	493	558	568	568	488
(2) Voltage at point A	V	109	114	117	116	115	109	114	115	116	123
(3) Allowable continuous current	A	6.0	6.0	5.7	5.0	4.1	9.0	9.0	9.0	8.8	7.2
(4) Speed at point A	rpm	34	23.5	20	16.5	12.5	30	20.5	16.6	14.2	12.2
(5) Frequency at point A	Hz	142	157	167	165	167	125	137	138	142	163
(6) Allowable range temperature	°C	40									
(7) Number of phase	—	3									

Chapter 1

Outlines

This chapter explains the features, functions and specifications of the actuator.

1-1 Overview.....	1-1
1-2 Model.....	1-2
1-3 Drivers and extension cables.....	1-3
1-4 Specifications.....	1-4
1-5 Motor shaft holding brake	1-14
1-6 External dimensions	1-17
1-7 Mechanical accuracy	1-30
1-8 One-way positional accuracy.....	1-32
1-9 Encoder specifications (Absolute encoder)	1-34
1-10 Stiffness	1-36
1-11 Rotation direction	1-40
1-12 Shock resistance.....	1-41
1-13 Resistance to vibration	1-42
1-14 Operable range.....	1-43
1-15 Cable specifications	1-59

1-1 Overview

SHA The SHA series of AC Servo Actuators provide high torque and high accuracy rotary motion. These AC Servo Actuators are each composed of a Harmonic Drive® speed reducer for precise control and a flat, high performance AC servo motor with an integral absolute multi-turn encoder. The SHA series AC Servo Actuators all feature a large hollow shaft through the axis of rotation.

There are 3 types of speed reducers: SG with SHG series incorporated, HP with HPF series incorporated, and CG with the CSG series incorporated. They are an advanced version of current FHA series AC Servo Actuators having a flat, hollow structure.

One key feature of the SHA actuators is their compact size. The outside diameter has been minimized, providing a maximum torque/volume ratio which is approximately double that of conventional FHA actuators. A through hole is provided in the center of the actuator, through which wiring, air lines, laser beams or concentric shafts may be passed.

The HA-800 series driver is a dedicated family of servo drive units for position/speed control, developed exclusively for driving SHA series actuators. The small, multi-functional drivers control the SHA series actuators' operations with great accuracy and precision. Additionally, the REL driver series may be used, which provides interface to many network field buses.

SHA actuators play an important role in driving many factory automation (FA) equipment, such as robot joints, alignment mechanisms for semi-conductor and LCD, metal-cutting machines, printing machine roller drive, etc.

◆ Improved Torque Density

High-torque SHG or CSG series Harmonic Drive® speed reducers are incorporated into the actuator for precise control and the outer diameter of the actuator has been reduced by 20% compared to our conventional products. As a result, the maximum torque/volume ratio has approximately doubled compared to our previous actuator designs. Based on maximum torque, you can select a model which is one size smaller. Also, the output torque is much higher than direct drive motors of similar volume/weight..

◆ Expanded product lineup

SHA-SG is available in 7 sizes, accommodating high torque up to 3,400 Nm, with reduction ratios of 51 to 161. CG series has 4 frame sizes with 5 reduction ratios of 50:1 to 160:1.

◆ Modular design

The components of the SHA series, such as speed reducers, output shaft bearing, motor, brake and encoder, are arranged based on modular design. We can also custom-design a model meeting your specific requirements, so please contact your HDLLC sales representative.

◆ Standard 17-bit magnetic absolute encoder

The newly developed AC servo motors are equipped with Harmonic Drive's original highly reliable 17-bit magnetic absolute encoder* with safety function. The serial communication reduces wiring and provides not only a multi-turn encoder, which is a must-have feature on actuators with speed reducers, but it also has an internal backup to retain absolute positions even when the encoder cable is disconnected for short periods of time.

The encoder circuitry also constantly compares two separate sets of encoder signals. If any abnormality is detected, the encoder's built-in failsafe function outputs an alarm signal to the host system.

*Size. 20 is equipped with an optical encoder.

◆ Supporting open network control when combined with a dedicated driver

By using a dedicated HA-800 series drive, you can control your actuator on a MECHATROLINK-II or CC-Link network. The REL series drives support EtherCat, CANOpen, and DeviceNet.

◆ For high speeds

Also supports high speeds in combination with the HPF hollow shaft planetary gearhead.

◆ CG model has an improved output shaft deflection accuracy

After reviewing the output rotary unit structure, the higher accuracy of the surface runout and shaft deflection has been achieved. Together with easy-to-index speed ratios that are divisible, such as 50:1 and 100:1, this is ideal for use with index tables. There is also an output shaft single revolution absolute model available as an option that can control the position even with infinite rotation in one direction.

1-2 Ordering Code

Ordering code for the SHA series actuators and how to interpret them are explained below.

Examples of standard models:

SHA	32	A	101	SG	—	B	12	A	200	—	10	S17b	A	—	C	L	—	SP
(1)	(2)	(3)	(4)	(5)	(6)	(7)	(8)	(9)	(10)	(11)	(12)	(13)	(14)	(15)				

(1) Model: SHA series Servo Actuator

(2) Sizes: HP: 25, 32
SG: 20, 25, 32, 40, 45, 58, 65
CG: 20, 25, 32, 40

(3) Version symbol A: Standard, Y: Yaskawa compatible, M: Mitsubishi compatible, P: Panasonic compatible

(4) Reduction ratio (R:1)

Reduction ratio 11:1 is for the HPF hollow shaft planetary speed reducer (size 25, 32)

Reduction ratios 50 and higher are for the HarmonicDrive® speed reducers.

HPF		SHG		CSG	
11	11:1	51	51:1	50	50:1
		81	81:1	80	80:1
		101	101:1	100	100:1
		121	121:1	120	120:1
		161	161:1	160	160:1

(5) Speed reducer

HP	HPF hollow shaft planetary
SG	HarmonicDrive® SHG series
CG	HarmonicDrive® CSG series

(6) Motor version symbol

A	Size 58, 65 (SG only)
B	Size 25, 32, 40
C	Size 20
D	Size 45 (SG only)

(7) Motor size

08	Size 20
09	Size 25
12	Size 32
15	Size 40
16	Size 45 (SG)
21	Size 58, 65 (SG)

(8) Brake

A	Without brake
B	With brake

(9) Motor input voltage

100	100 V (Size 25 only)
200	200 V
LV	48V DC to 90V DC (Size 20, 25, 32)

(10) Encoder format

10	A-Format (2.5Mbps, 1 to 1 connection)
00	Incremental Encoder
14	Panasonic Format
16	Mitsubishi Format (not available in size 20)
17	Yaskawa Format (not available in size 20)

(11) Encoder type, resolution

S17b	17-bit absolute encoder, 131072 pulses/revolution (Nikon-A format)
D250	D250: Incremental encoder (size 25, 32, and 40)

(12) Encoder phase angle: Phase difference between induced voltage in motor phase U and absolute origin

A	0 degree
B	30 degree

(13) Connector specification

C	With standard connector
N	With pigtails

(14) Option symbol

L	With near origin and end limit sensors
Y	Side exit cable
V	With mounting stand (CG only)
S	Output shaft single revolution absolute encoder (CG only)

(Please contact us for options)

(15) Special specification

No description	Standard product
SP	Special specification code

1-3 Drives and extension cables

The combinations of SHA actuators, drives and extension cables are as follows:

		SHA20A	SHA25A	SHA32A	SHA40A
REL Servo Drive		REL-230-18	REL-230-36(100V) REL-230-18 (200V)	REL-230-36 (ratio <160) REL-230-40 (ratio 160, 161)	REL-230-40 (ratio <120) REL-230-36 (ratio ≥120)
I/O command type		HA-800A-3D/E-200	HA-800A-3D/E-200 [HA-800A-6D/E-100]	HA-800A-6D/E-200	HA-800A-6D/E-200 or HA-800A-24D/E-200
MECHATROLINK type		HA-800B-3D/E-200	HA-800B-3D/E-200 [HA-800B-6D/E-100]	HA-800B-6D/E-200	HA-800B-6D/E-200 or HA-800B-24D/E-200
CC-Link type		HA-800C-3D/E-200	HA-800C-3D/E-200 [HA-800C-6D/E-100]	HA-800C-6D/E-200	HA-800C-6D/E-200 or HA-800C-24D/E-200
Extension cables (option)	Motor wire	HA800: EWD-MB**-A06-TN3 REL-230: EWD-S**-A08-A26-BX			HA-800□-6D/E: EWD-MB**-A06-TN3 HA-800□-24D/E: EWD-MB**-A06-TMC
	Encoder wire	EWD-S**-A08-3M14			

		SHA45A	SHA58A	SHA65A
I/O command type		HA-800A-24D/E-200	HA-800A-24D/E-200	HA-800A-24D/E-200
MECHATROLINK type		HA-800B-24D/E-200	HA-800B-24D/E-200	HA-800B-24D/E-200
CC-Link type		HA-800C-24D/E-200	HA-800C-24D/E-200	HA-800C-24D/E-200
Extension cables (option)	Motor wire	EWD-MB**-A06-TMC	EWD-MB**-D09-TMC	
	Encoder wire	EWD-S**-A08-3M14	EWD-S**-D10-3M14	

Note: ** in the extension cable model indicates the cable length: 03 = 3 m, 05 = 5 m, 10 = 10 m

The models shown in brackets are those with 100 V input voltage.

1-4 Specifications

SG

Item		Model	SHA20A				
			51	81	101	121	161
Recommended Drive		REL-230-18 / HA-800□-3D/E-200					
Max. torque ^{*1}	N·m	73	96	107	113	120	
	kgf·m	7.4	9.8	10.9	11.5	12.2	
Allowable continuous torque ^{*1,2}	N·m	21	35	43	48	48	
	kgf·m	2.1	3.6	4.4	4.9	4.9	
Max. rotational speed ^{*1}	rpm	117.6	74.1	59.4	49.6	37.3	
Torque constant ^{*1}	N·m/A _{rms}	16.5	27	33	40	53	
	kgf·m/A _{rms}	1.7	2.7	3.4	4.1	5.4	
Max. current ^{*1}	A _{rms}	6.0	4.9	4.5	4.0	3.4	
Allowable continuous current ^{*1,2}	A _{rms}	2.1	2.0	2.0	1.9	1.6	
EMF constant ^{*3}	V/(rpm)	1.9	3.0	3.7	4.5	5.9	
Phase resistance (20 °C)	Ω	1.4					
Phase inductance	mH	2.5					
Inertia moment (without brake)	GD ² /4	kg·m ²	0.23	0.58	0.91	1.3	2.3
	J	kgf·cm·s ²	2.4	6.0	9.3	13	24
Inertia moment (with brake)	GD ² /4	kg·m ²	0.26	0.65	1.0	1.4	2.6
	J	kgf·cm·s ²	2.6	6.6	10	15	26
Permissible moment load	N·m		187				
	kgf·m		19.1				
Moment stiffness	N·m/rad		25.2 × 10 ⁴				
	kgf·m/arc-min		7.5				
One-way positional accuracy	arc-sec		60	50	50	50	50
Encoder type	Absolute encoder						
Encoder resolution	Single-turn		2 ¹⁷ (131072)				
	Multi-turn ^{*5}		2 ¹⁶ (65536)				
Output shaft resolution	counts/rev		6684672	10616832	13238272	15859712	21102592
Mass (without brake)	kg		2.0				
Mass (with brake)	kg		2.1				
Environmental conditions ^{*6}	Operating temperature: 0 to 40 °C/Storage temperature: -20 to 60 °C Operating humidity/storage humidity: 20 to 80 %RH (no condensation) Resistance to vibration: 25 m/s ² (frequency: 10 to 400 Hz) Shock resistance: 300 m/s ² *4 No dust, no metal powder, no corrosive gas, no inflammable gas, no oil mist To be used indoors, no direct sunlight Altitude: less than 1000 m above sea level						
Motor insulation	Insulation resistance: 100 MΩ or more (by DC500 V insulation tester) Dielectric strength: AC1500 V/1 min Insulation class: A						
Mounting direction	Can be installed in any direction.						
Protection structure	Totally enclosed self-cooled type (IP54)						

The table shows typical output values of actuators.

*1: Typical characteristics when combined (driven by ideal sine wave) with our drive.

*2: Value after temperature rise and saturation when the 320×320×16 [mm] aluminum heatsink is installed.

*3: Value of phase induced voltage constant multiplied by 3.

*4: For testing conditions, refer to [1-12 Shock resistance] (P1-41) and [1-13 Resistance to vibration] (P1-42).
 Motor operation is not guaranteed in applications where vibrations and impacts are continuously applied for a long period of time.

*5: The multi-turn detector range is -32768 to 32767.

*6: For details, refer to [3-3 Location and installation] (P3-6).

Item		Model	SHA25A (Motor input voltage 100 V)					SHA25A (Motor input voltage 200 V)					
			51	81	101	121	161	11	51	81	101	121	161
Recommended Drive			REL 230-18 / HA-800□-6D/E-100					REL 230-18 / REL 230-36 / HA-800□- 3D/E-200					
Max. torque ^{*1}	N·m		127	178	204	217	229	26	127	178	204	217	229
	kgf·m		13	18.2	20.8	22.1	23.4	2.7	13	18.2	20.8	22.1	23.4
Allowable continuous torque ^{*1*2}	N·m		35	58	73	81	81	9.0	41	67	81	81	81
	kgf·m		3.6	5.9	7.4	8.2	8.2	0.92	4.2	6.8	8.2	8.2	8.2
Max. rotational speed ^{*1}	rpm		94.1	59.3	47.5	39.7	29.8	509.1	109.8	69.1	55.4	46.3	34.8
Torque constant ^{*1}	N·m/A _{rms}		11.1	17.9	22	27	36	4.2	19	31	39	46	62
	kgf·m/A _{rms}		1.1	1.8	2.3	2.7	3.6	0.43	2.0	3.2	4.0	4.7	6.3
Max. current ^{*1}	A _{rms}		14.9	13.0	12.1	10.9	9.0	8.9	8.6	7.5	7.0	6.3	5.2
Allowable continuous current ^{*1*2}	A _{rms}		4.7	4.7	4.7	4.5	3.7	3.0	3.0	3.0	2.9	2.6	2.1
EMF constant ^{*3}	V/(rpm)		1.3	2.0	2.5	3.0	4.0	0.47	2.2	3.5	4.3	5.2	6.9
Phase resistance (20 °C)	Ω		0.4					1.2					
Phase inductance	mH		1.0					3					
Inertia moment (without brake)	GD ² /4	kg·m ²	0.56	1.4	2.2	3.2	5.6	0.029	0.56	1.4	2.2	3.2	5.6
	J	kgf·cm·s ²	5.7	14	22	32	57	0.30	5.7	14	22	32	57
Inertia moment (with brake)	GD ² /4	kg·m ²	0.66	1.7	2.6	3.7	6.6	0.034	0.66	1.7	2.6	3.7	6.6
	J	kgf·cm·s ²	6.7	17	26	38	67	0.35	6.7	17	26	38	67
Permissible moment load	N·m		258					410	258				
	kgf·m		26.3					41.8	26.3				
Moment stiffness	N·m/rad		39.2 × 10 ⁴					37.9 × 10 ⁴	39.2 × 10 ⁴				
	kgf·m/arc-min		11.6					11.3	11.6				
One-way positional accuracy	arc-sec.		50	40	40	40	40	120	50	40	40	40	40
Encoder type			Absolute encoder with battery buffered multi-turn										
Encoder resolution	Single-turn		2 ¹⁷ (131072)										
	Multi-turn ^{*5}		2 ¹⁶ (65536)										
Output shaft resolution	counts/rev		6684672	10616832	13238272	15859712	21102592	1441792	6684672	10616832	13238272	15859712	21102592
Mass (without brake)	kg		2.95					5.0	2.95				
Mass (with brake)	kg		3.1					5.1	3.1				
Environmental conditions ^{*6}			Operating temperature: 0 to 40 °C/Storage temperature: -20 to 60 °C Operating humidity/storage humidity: 20 to 80 %RH (no condensation) Resistance to vibration: 25 m/s ² (frequency: 10 to 400 Hz) Shock resistance: 300 m/s ² ^{*4} No dust, no metal powder, no corrosive gas, no inflammable gas, no oil mist To be used indoors, no direct sunlight Altitude: less than 1000 m above sea level										
Motor insulation			Insulation resistance: 100 MΩ or more (by DC500 V insulation tester) Dielectric strength: AC1500 V/1 min Insulation class: A										
Mounting direction			Can be installed in any direction.										
Protection structure			Totally enclosed self-cooled type (IP54)										

The table shows typical output values of actuators.

*1: Typical characteristics when combined (driven by ideal sine wave) with our drive.

*2: Value after temperature rise and saturation when the 350×350×18 [mm] aluminum heatsink is installed.

*3: Value of phase induced voltage constant multiplied by 3.

*4: For testing conditions, refer to [1-12 Shock resistance] (P1-41) and [1-13 Resistance to vibration] (P1-42).
Motor operation is not guaranteed in applications where vibrations and impacts are continuously applied for a long period of time.

*5: The multi-turn detector range is -32768 to 32767.

*6: For details, refer to [3-3 Location and installation] (P3-6).

SG/HP

Item		Model	SHA32A					
			11	51	81	101	121	161
Recommended Drive			REL-230-18 / REL-230-36 / HA-800□-6D/E-200					
Max. torque* ¹	N·m		62	281	395	433	459	484
	kgf·m		6.3	28.7	40.3	44.2	46.8	49.4
Allowable continuous torque* ^{1,2}	N·m		20	92	153	178	178	178
	kgf·m		2.1	9.4	15.6	18.2	18.2	18.2
Max. rotational speed* ¹	rpm		436.4	94.1	59.3	47.5	39.7	29.8
Torque constant* ¹	N·m/A _{rms}		4.5	21	33	42	50	66
	kgf·m/A _{rms}		0.46	2.1	3.4	4.2	5.1	6.8
Max. current* ¹	A _{rms}		19	17.3	15.2	13.5	12.2	9.9
Allowable continuous current* ^{1,2}	A _{rms}		6.0	6.0	6.0	5.7	5.0	4.1
EMF constant* ³	V/(rpm)		0.51	2.3	3.7	4.7	5.6	7.4
Phase resistance (20 °C)	Ω		0.33					
Phase inductance	mH		1.4					
Inertia moment (without brake)	GD ² /4	kg·m ²	0.091	2.0	5.1	8.0	11	20
	J	kgf·cm·s ²	0.93	21	52	81	117	207
Inertia moment (with brake)	GD ² /4	kg·m ²	0.11	2.3	5.9	9.2	13	23
	J	kgf·cm·s ²	1.1	24	60	94	135	238
Permissible moment load	N·m		932	580				
	kgf·m		95	59.1				
Moment stiffness	N·m/rad		86.1×10 ⁴	100×10 ⁴				
	kgf·m/arc-min		25.7	29.6				
One-way positional accuracy	arc-sec.		120	50	40	40	40	40
Encoder type			Absolute encoder with battery buffered multi-turn					
Encoder resolution	Single-turn		2 ¹⁷ (131072)					
	Multi-turn ⁵		2 ¹⁶ (65536)					
Output shaft resolution	counts/rev		1441792	6684672	10616832	13238272	15859712	21102592
Mass (without brake)	kg		9.4	5.9				
Mass (with brake)	kg		9.7	6.2				
Environmental conditions* ⁶			Operating temperature: 0 to 40 °C/Storage temperature: -20 to 60 °C Operating humidity/storage humidity: 20 to 80 %RH (no condensation) Resistance to vibration: 25 m/s ² (frequency: 10 to 400 Hz) Shock resistance: 300 m/s ² * ⁴ No dust, no metal powder, no corrosive gas, no inflammable gas, no oil mist To be used indoors, no direct sunlight Altitude: less than 1000 m above sea level					
Motor insulation			Insulation resistance: 100 MΩ or more (by DC500 V insulation tester) Dielectric strength: AC1500 V/1 min Insulation class: A					
Mounting direction			Can be installed in any direction.					
Protection structure			Totally enclosed self-cooled type (IP54)					

The table shows typical output values of actuators.

*1: Typical characteristics when combined (driven by ideal sine wave) with our drive.

*2: Value after temperature rise and saturation when the 400×400×20 [mm] aluminum heatsink is installed.

*3: Value of phase induced voltage constant multiplied by 3.

*4: For testing conditions, refer to [1-12 Shock resistance] (P1-41) and [1-13 Resistance to vibration] (P1-42).
Motor operation is not guaranteed in applications where vibrations and impacts are continuously applied for a long period of time.

*5: The multi-turn detector range is -32768 to 32767.

*6: For details, refer to [3-3 Location and installation] (P3-6).

SG

Item	Model	SHA40A										
		51	81	101	121	161	51	81	101	121	161	
Recommended Drive		REL-230 / HA-800□-6D/E-200 ¹					REL-230 / HA-800□-24D/E-200					
Max. torque ^{*2}	N·m	340	560	686	802	841	523	675	738	802	841	
	kgf·m	34.7	57.1	70	81.8	85.8	53.4	68.9	75.3	81.8	85.8	
Allowable continuous torque ^{*2*3}	N·m	94	158	198	237	317	160	263	330	382	382	
	kgf·m	9.6	16.1	20.2	24.2	32.3	16.3	26.8	33.7	39	39	
Max. rotational speed ^{*2}	rpm	78.4	49.4	39.6	33.1	24.8	78.4	49.4	39.6	33.1	24.8	
Torque constant ^{*2}	N·m/A _{rms}	25	41	51	61	81	25	41	51	61	81	
	kgf·m/A _{rms}	2.6	4.1	5.2	6.2	8.2	2.6	4.1	5.2	6.2	8.2	
Max. current ^{*2}	A _{rms}	18	18	18	17.9	14.6	26.7	21.8	19.4	17.9	14.6	
Allowable continuous current ^{*2*3}	A _{rms}	6.0	6.0	6.0	6.0	6.0	9.0	9.0	9.0	8.8	7.2	
EMF constant ^{*4}	V/(rpm)	2.9	4.6	5.7	6.8	9.1	2.9	4.6	5.7	6.8	9.1	
Phase resistance (20 °C)	Ω	0.19										
Phase inductance	mH	1.2										
Inertia moment (without brake)	GD ² /4	kg·m ²	5.0	13	20	28	50	5.0	13	20	28	50
	J	kgf·cm·s ²	51	130	202	290	513	51	130	202	290	513
Inertia moment (with brake)	GD ² /4	kg·m ²	6.1	15	24	34	61	6.1	15	24	34	61
	J	kgf·cm·s ²	62	157	244	350	619	62	157	244	350	619
Permissible moment load	N·m	849										
	kgf·m	86.6										
Moment stiffness	N·m/rad	179 × 10 ⁴										
	kgf·m/arc-min	53.2										
One-way positional accuracy	arc-sec.	50	40	40	40	40	50	40	40	40	40	
Encoder type		Absolute encoder with battery buffered multi-turn r										
Encoder resolution	Single-turn	2 ¹⁷ (131072)										
	Multi-turn ^{*6}	2 ¹⁶ (65536)										
Output shaft resolution	counts /rev	6684672	10616832	13238272	15859712	21102592	6684672	10616832	13238272	15859712	21102592	
Mass (without brake)	kg	9.9										
Mass (with brake)	kg	10.7										
Environmental conditions ^{*7}		Operating temperature: 0 to 40 °C/Storage temperature: -20 to 60 °C Operating humidity/storage humidity: 20 to 80 %RH (no condensation) Resistance to vibration: 25 m/s ² (frequency: 10 to 400 Hz) Shock resistance: 300 m/s ² ^{*5} No dust, no metal powder, no corrosive gas, no inflammable gas, no oil mist To be used indoors, no direct sunlight Altitude: less than 1000 m above sea level										
Motor insulation		Insulation resistance: 100 MΩ or more (by DC500 V insulation tester) Dielectric strength: AC1500 V/1 min Insulation class: A										
Mounting direction		Can be installed in any direction.										
Protection structure		Totally enclosed self-cooled type (IP54)										

The table shows typical output values of actuators.

*1: If a HA-800□-6D/E driver is combined with a SHA40A actuator, the maximum torque and allowable continuous torque are limited.

*2: Typical characteristics when combined (driven by ideal sine wave) with our drivers.

*3: Value after temperature rise and saturation when the 500×500×25 [mm] aluminum heatsink is installed.

*4: Value of phase induced voltage constant multiplied by 3.

*5: For testing conditions, refer to [1-12 Shock resistance] (P1-41) and [1-13 Resistance to vibration] (P1-42).
Motor operation is not guaranteed in applications where vibrations and impacts are continuously applied for a long period of time.

*6: The multi-turn detector range is -32768 to 32767.

*7: For details, refer to [3-3 Location and installation] (P3-6).

SG

Item		Model	SHA45A				
			51	81	101	121	161
Combined drive		HA-800□-24D/E-200					
Max. torque ^{*1}	N·m	650	918	982	1070	1147	
	kgf·m	66.3	93.6	100	109	117	
Allowable continuous torque ^{*1,2}	N·m	174	290	363	437	523	
	kgf·m	17.7	29.6	37.0	44.6	53.3	
Max. rotational speed ^{*1}	rpm	74.5	46.9	37.6	31.4	23.6	
Torque constant ^{*1}	N·m/A _{rms}	25	41	51	61	81	
	kgf·m/A _{rms}	2.6	4.1	5.2	6.2	8.2	
Max. current ^{*1}	A _{rms}	36.5	29.9	25.9	24.5	19.3	
Allowable continuous current ^{*1,2}	A _{rms}	10.0	10.0	10.0	10.0	9.2	
EMF constant ^{*3}	V/(rpm)	2.9	4.6	5.7	6.8	9.1	
Phase resistance (20 °C)	Ω	0.19					
Phase inductance	mH	1.2					
Inertia moment (without brake)	GD ² /4	kg·m ²	6.8	17	27	38	68
	J	kgf·cm·s ²	69	175	272	390	690
Inertia moment (with brake)	GD ² /4	kg·m ²	7.9	20	31	45	79
	J	kgf·cm·s ²	81	204	316	454	804
Permissible moment load	N·m		1127				
	kgf·m		115				
Moment stiffness	N·m/rad		257 × 10 ⁴				
	kgf·m/arc-min		76.3				
One-way positional accuracy	arc-sec.		50	40	40	40	40
Encoder type	Absolute encoder with battery buffered multi-turn						
Encoder resolution	Single-turn detector		2 ¹⁷ (131072)				
	Multi-turn detector ^{*5}		2 ¹⁶ (65536)				
Output shaft resolution	counts /rev		6684672	10616832	13238272	15859712	21102592
Mass (without brake)	kg		12.4				
Mass (with brake)	kg		13.2				
Environmental conditions ^{*6}	Operating temperature: 0 to 40 °C/Storage temperature: -20 to 60 °C Operating humidity/storage humidity: 20 to 80 %RH (no condensation) Resistance to vibration: 25 m/s ² (frequency: 10 to 400 Hz) Shock resistance: 300 m/s ² *4 No dust, no metal powder, no corrosive gas, no inflammable gas, no oil mist To be used indoors, no direct sunlight Altitude: less than 1000 m above sea level						
Motor insulation	Insulation resistance: 100 MΩ or more (by DC500 V insulation tester) Dielectric strength: AC1500 V/1 min Insulation class: A						
Mounting direction	Can be installed in any direction.						
Protection structure	Totally enclosed self-cooled type (IP54)						

The table shows typical output values of actuators.

*1: Typical characteristics when combined (driven by ideal sine wave) with our drivers.

*2: Value after temperature rise and saturation when the 500×500×25 [mm] aluminum heatsink is installed.

*3: Value of phase induced voltage constant multiplied by 3.

*4: For testing conditions, refer to [1-12 Shock resistance] (P1-41) and [1-13 Resistance to vibration] (P1-42).
 Motor operation is not guaranteed in applications where vibrations and impacts are continuously applied for a long period of time.

*5: The multi-turn detector range is -32768 to 32767.

*6: For details, refer to [3-3 Location and installation] (P3-6).

SG

Item	Model	SHA58A				SHA65A				
		81	101	121	161	81	101	121	161	
Combined driver		HA-800□-24D/E-200				HA-800□-24D/E-200				
Max. torque* ¹	N·m	1924	2067	2236	2392	2400	2990	3263	3419	
	kgf·m	196	211	228	244	245	305	333	349	
Allowable continuous torque** ²	N·m	714	905	969	969	921	1149	1236	1236	
	kgf·m	73	92	99	99	94	117	126	126	
Max. rotational speed* ¹	rpm	37.0	29.7	24.8	18.6	34.6	27.7	23.1	17.4	
Torque constant* ¹	N·m/A _{rms}	54	68	81	108	54	68	81	108	
	kgf·m/A _{rms}	5.5	6.9	8.3	11.0	5.5	6.9	8.3	11.0	
Max. current* ¹	A _{rms}	45	39	36	30	55	55	51	41	
Allowable continuous current** ²	A _{rms}	17.7	17.8	16.4	13.4	22.0	21.9	20.1	16.3	
EMF constant* ³	V/(rpm)	6.1	7.6	9.1	12.1	6.1	7.6	9.1	12.1	
Phase resistance (20 °C)	Ω	0.028				0.028				
Phase inductance	mH	0.29				0.29				
Inertia moment (without brake)	GD ² /4	kg·m ²	96	149	214	379	110	171	245	433
	J	kgf·cm·s ²	980	1520	2180	3870	1120	1740	2500	4420
Inertia moment (with brake)	GD ² /4	kg·m ²	106	165	237	420	120	187	268	475
	J	kgf·cm·s ²	1090	1690	2420	4290	1230	1910	2740	4850
Permissible moment load	N·m	2180				2740				
	kgf·m	222				280				
Moment stiffness	N·m/rad	531 × 10 ⁴				741 × 10 ⁴				
	kgf·m/arc-min	158				220				
One-way positional accuracy	arc-sec.	40	40	40	40	40	40	40	40	
Encoder type		Absolute encoder with battery buffered multi-turn								
Encoder resolution	Single-turn detector	2 ¹⁷ (131072)								
	Multi-turn detector* ⁵	2 ¹⁶ (65536)								
Output shaft resolution	counts/rev	10616832	13238272	15859712	21102592	10616832	13238272	15859712	21102592	
Mass (without brake)	kg	29.5				37.5				
Mass (with brake)	kg	32				40				
Environmental conditions* ⁶		Operating temperature: 0 to 40 °C/Storage temperature: -20 to 60 °C Operating humidity/storage humidity: 20 to 80 %RH (no condensation) Resistance to vibration: 25 m/s ² (frequency: 10 to 400 Hz) Shock resistance: 300 m/s ² * ⁴ No dust, no metal powder, no corrosive gas, no inflammable gas, no oil mist To be used indoors, no direct sunlight Altitude: less than 1000 m above sea level								
Motor insulation		Insulation resistance: 100 MΩ or more (by DC500 V insulation tester) Dielectric strength: AC1500 V/1 min Insulation class: A								
Mounting direction		Can be installed in any direction.								
Protection structure		Totally enclosed self-cooled type (IP54)								

The table shows typical output values of actuators.

*1: Typical characteristics when combined (driven by ideal sine wave) with our drivers.

*2: Value after temperature rise and saturation when the 650×650×30 [mm] aluminum heatsink is installed.

*3: Value of phase induced voltage constant multiplied by 3.

*4: For testing conditions, refer to [1-12 Shock resistance] (P1-41) and [1-13 Resistance to vibration] (P1-42).

Motor operation is not guaranteed in applications where vibrations and impacts are continuously applied for a long period of time.

*5: The multi-turn detector range is -32768 to 32767.

*6: For details, refer to [3-3 Location and installation] (P3-6).

CG

Item		Model	SHA20A				
			50	80	100	120	160
Recommended Drive		REL-230-18 / HA-800□-3D/E-200					
Max. torque ^{*1}	N·m	73	96	107	113	120	
	kgf·m	7.4	9.8	10.9	11.5	12.2	
Allowable continuous torque ^{**2}	N·m	21	35	43	48	48	
	kgf·m	2.1	3.6	4.4	4.9	4.9	
Max. rotational speed ^{*1}	rpm	120	75	60	50	37.5	
Torque constant ^{*1}	N·m/A _{rms}	16	26	33	39	53	
	kgf·m/A _{rms}	1.7	2.7	3.4	4.0	5.4	
Max. current ^{*1}	A _{rms}	6.1	5.0	4.6	4.1	3.4	
Allowable continuous current ^{**2}	A _{rms}	2.1	2.1	2.1	2.0	1.7	
EMF constant ^{*3}	V/(rpm)	1.8	2.9	3.7	4.4	5.9	
Phase resistance (20 °C)	Ω	1.4					
Phase inductance	mH	2.5					
Inertia moment (without brake)	GD ² /4	kg·m ²	0.21	0.53	0.82	1.2	2.1
	J	kgf·cm·s ²	2.1	5.4	8.0	12	22
Inertia moment (with brake)	GD ² /4	kg·m ²	0.23	0.60	0.94	1.3	2.4
	J	kgf·cm·s ²	2.4	6.1	9.6	14	24
Permissible moment load	N·m		187				
	kgf·m		19.1				
Moment stiffness	N·m/rad		25.2 × 10 ⁴				
	kgf·m/arc-min		7.5				
One-way positional accuracy	arc-sec.		60	50	50	50	50
Repeatability	arc-sec.		±5				
Reverse positional accuracy	arc-sec.		75	30	30	30	30
Encoder type	Absolute encoder with battery buffered multi-turn						
Encoder resolution	Single-turn detector		2 ¹⁷ (131072)				
	Multi-turn detector ^{*5}		2 ¹⁶ (65536)				
Output shaft resolution	counts/rev		6553600	10485760	13107200	15728640	20971520
Mass (without brake)	kg		2.6				
Mass (with brake)	kg		2.7				
Environmental conditions ^{*6}	Operating temperature: 0 to 40 °C/Storage temperature: -20 to 60 °C Operating humidity/storage humidity: 20 to 80 %RH (no condensation) Resistance to vibration: 25 m/s ² (frequency: 10 to 400 Hz) Shock resistance: 300 m/s ² *4 No dust, no metal powder, no corrosive gas, no inflammable gas, no oil mist To be used indoors, no direct sunlight Altitude: less than 1000 m above sea level						
Motor insulation	Insulation resistance: 100 MΩ or more (by DC500 V insulation tester) Dielectric strength: AC1500 V/1 min Insulation class: A						
Mounting direction	Can be installed in any direction						
Protection structure	Totally enclosed self-cooled type (IP54)						

The table shows typical output values of actuators.

*1: Typical characteristics when combined (driven by ideal sine wave) with our drivers.

*2: Value after temperature rise and saturation when the 320×320×16 [mm] aluminum heatsink is installed.

*3: Value of phase induced voltage constant multiplied by 3.

*4: For testing conditions, refer to [1-12 Shock resistance] (P1-41) and [1-13 Resistance to vibration] (P1-42).
Motor operation is not guaranteed in applications where vibrations and impacts are continuously applied for a long period of time.

*5: The multi-turn detector range is -32768 to 32767.

*6: For details, refer to [3-3 Location and installation] (P3-6).

Item		Model	SHA25A (Motor input voltage 100 V)					SHA25A (Motor input voltage 200 V)				
			50	80	100	120	160	50	80	100	120	160
Combined drive			REL-230-18 / REL-230-36 HA-800□-6D/E-100					REL-230-18 / REL-230-36 HA-800□-3D/E-200				
Max. torque* ¹	N·m		127	178	204	217	229	127	178	204	217	229
	kgf·m		13	18.2	20.8	22.1	23.4	13	18.2	20.8	22.1	23.4
Allowable continuous torque* ^{1,2}	N·m		34	57	72	81	81	40	66	81	81	81
	kgf·m		3.5	5.8	7.3	8.2	8.2	4.1	6.8	8.2	8.2	8.2
Max. rotational speed* ¹	rpm		96	60	48	40	30	112	70	56	46.7	35
Torque constant* ¹	N·m/A _{rms}		10.9	17.7	22	27	35	19	31	38	46	61
	kgf·m/A _{rms}		1.1	1.8	2.3	2.7	3.6	1.9	3.1	3.9	4.7	6.3
Max. current* ¹	A _{rms}		15.1	13.2	12.2	11.0	9.0	8.7	7.6	7.0	6.3	5.2
Allowable continuous current* ^{1,2}	A _{rms}		4.7	4.7	4.7	4.5	3.7	3.0	3.0	3.0	2.6	2.1
EMF constant* ³	V/(rpm)		1.2	2.0	2.5	3.0	4.0	2.1	3.4	4.3	5.2	6.9
Phase resistance (20 °C)	Ω		0.4					1.2				
Phase inductance	mH		1.0					3.0				
Inertia moment (without brake)	GD ² /4	kg·m ²	0.50	1.3	2.0	2.9	5.1	0.50	1.3	2.0	2.9	5.1
	J	kgf·cm·s ²	5.1	13	20	29	52	5.1	13	20	29	52
Inertia moment (with brake)	GD ² /4	kg·m ²	0.60	1.5	2.4	3.4	6.1	0.60	1.5	2.4	3.4	6.1
	J	kgf·cm·s ²	6.1	16	24	35	62	6.1	16	24	35	62
Permissible moment load	N·m		258									
	kgf·m		26.3									
Moment stiffness	N·m/rad		39.2 × 10 ⁴									
	kgf·m/arc-min		11.6									
One-way positional accuracy	arc-sec.		50	40	40	40	40	50	40	40	40	40
Repeatability	arc-sec.		±5									
Bi-directional repeatability	arc-sec.		60	25	25	25	25	60	25	25	25	25
Encoder type			Absolute encoder with battery buffered multi-turn									
Encoder resolution	Single-turn		2 ¹⁷ (131072)									
	Multi-turn * ⁵		2 ¹⁶ (65536)									
Output shaft resolution	counts/rev		6553600	10485760	13107200	15728640	20971520	6553600	10485760	13107200	15728640	20971520
Mass (without brake)	kg		3.95									
Mass (with brake)	kg		4.1									
Environmental conditions* ⁶			Operating temperature: 0 to 40 °C/Storage temperature: -20 to 60 °C Operating humidity/storage humidity: 20 to 80 %RH (no condensation) Resistance to vibration: 25 m/s ² (frequency: 10 to 400 Hz) Shock resistance: 300 m/s ² * ⁴ No dust, no metal powder, no corrosive gas, no inflammable gas, no oil mist To be used indoors, no direct sunlight Altitude: less than 1000 m above sea level									
Motor insulation			Insulation resistance: 100 MΩ or more (by DC500 V insulation tester) Dielectric strength: AC1500 V/1 min Insulation class: A									
Mounting direction			Can be installed in any direction									
Protection structure			Totally enclosed self-cooled type (IP54)									

The table shows typical output values of actuators.

*1: Typical characteristics when combined with our drives.

*2: Value after temperature rise and saturation when the 350×350×18 [mm] aluminum heatsink is installed.

*3: Value of phase induced voltage constant multiplied by 3.

*4: For testing conditions, refer to [1-12 Shock resistance] (P1-41) and [1-13 Resistance to vibration] (P1-42).
Motor operation is not guaranteed in applications where vibrations and impacts are continuously applied for a long period of time.

*5: The multi-turn detector range is -32768 to 32767.

*6: For details, refer to [3-3 Location and installation] (P3-6).

CG

Item		Model	SHA32A				
			50	80	100	120	160
Combined drive		REL-230-18 / REL-230-36 / HA-800□-6D/E-200					
Max. torque* ¹	N·m	281	395	433	459	484	
	kgf·m	28.7	40.3	44.2	46.8	49.4	
Allowable continuous torque* ^{1,2}	N·m	90	151	178	178	178	
	kgf·m	9.2	15.4	18.2	18.2	18.2	
Max. rotational speed* ¹	rpm	96	60	48	40	30	
Torque constant* ¹	N·m/A _{rms}	20	33	41	49	66	
	kgf·m/A _{rms}	2.1	3.4	4.2	5.0	6.7	
Max. current* ¹	A _{rms}	17.7	15.4	13.7	12.2	10	
Allowable continuous current* ^{1,2}	A _{rms}	6.0	6.0	5.7	5.0	4.1	
EMF constant* ³	V/(rpm)	2.3	3.7	4.6	5.5	7.4	
Phase resistance (20 °C)	Ω	0.33					
Phase inductance	mH	1.4					
Inertia moment (without brake)	GD ² /4	kg·m ²	1.7	4.3	6.7	9.7	17
	J	kgf·cm·s ²	17	44	68	99	175
Inertia moment (with brake)	GD ² /4	kg·m ²	2.0	5.1	7.9	11	20
	J	kgf·cm·s ²	20	52	81	116	207
Permissible moment load	N·m		580				
	kgf·m		59.2				
Moment stiffness	N·m/rad		100 × 10 ⁴				
	kgf·m/arc-min		29.6				
One-way positional accuracy	arc-sec.		40	30	30	30	30
Repeatability	arc-sec.		±4				
Bi-directional repeatability	arc-sec.		60	25	25	25	25
Encoder type	Absolute encoder with battery buffered multi-turn						
Encoder resolution	Single-turn		2 ¹⁷ (131072)				
	Multi-turn * ⁵		2 ¹⁶ (65536)				
Output shaft resolution	counts/rev		6553600	10485760	13107200	15728640	20971520
Mass (without brake)	kg		7.7				
Mass (with brake)	kg		8.0				
Environmental conditions* ⁶	Operating temperature: 0 to 40 °C/Storage temperature: -20 to 60 °C Operating humidity/storage humidity: 20 to 80 %RH (no condensation) Resistance to vibration: 25 m/s ² (frequency: 10 to 400 Hz) Shock resistance: 300 m/s ² * ⁴ No dust, no metal powder, no corrosive gas, no inflammable gas, no oil mist To be used indoors, no direct sunlight Altitude: less than 1000 m above sea level						
Motor insulation	Insulation resistance: 100 MΩ or more (by DC500 V insulation tester) Dielectric strength: AC1500 V/1 min Insulation class: A						
Mounting direction	Can be installed in any direction.						
Protection structure	Totally enclosed self-cooled type (IP54)						

The table shows typical output values of actuators.

*1: Typical characteristics when combined (driven by ideal sine wave) with our drivers.

*2: Value after temperature rise and saturation when the 400×400×20 [mm] aluminum heatsink is installed.

*3: Value of phase induced voltage constant multiplied by 3.

*4: For testing conditions, refer to [1-12 Shock resistance] (P1-41) and [1-13 Resistance to vibration] (P1-42).
Motor operation is not guaranteed in applications where vibrations and impacts are continuously applied for a long period of time.

*5: The multi-turn detector range is -32768 to 32767.

*6: For details, refer to [3-3 Location and installation] (P3-6).

CG

Item	Model	SHA40A										
		50	80	100	120	160	50	80	100	120	160	
Recommended drive		REL-230 / HA-800□-6D/E-200 ^{*1}					REL-230 / HA-800□-24D/E-200					
Max. torque ^{*2}	N·m	333	548	686	802	841	523	675	738	802	841	
	kgf·m	34.0	55.9	70.0	81.8	85.8	53.4	68.9	75.3	81.8	85.8	
Allowable continuous torque ^{*2,3}	N·m	92	156	196	235	315	157	260	327	382	382	
	kgf·m	9.4	15.9	20.0	24.0	32.1	16.0	26.5	33.3	39	39	
Max. rotational speed ^{*2}	rpm	80	50	40	33.3	25	80	50	40	33.3	25	
Torque constant ^{*2}	N·m/A	25	40	50	60	80	25	40	50	60	80	
	kgf·m/A	2.5	4.1	5.1	6.1	8.2	2.5	4.1	5.1	6.1	8.2	
Max. current ^{*2}	A	18	18	18	17.6	14.3	27.2	22	19.6	18	14.7	
Allowable continuous current ^{*2,3}	A	6.0	6.0	6.0	6.0	6.0	9.0	9.0	9.0	8.8	7.2	
EMF constant ^{*4}	V/(rpm)	2.8	4.5	5.6	6.7	9.0	2.8	4.5	5.6	6.7	9.0	
Phase resistance (20°C)	Ω	0.19										
Phase inductance	mH	1.2										
Inertia moment (without brake)	GD ² /4	kg·m ²	4.8	12	19	27	49	4.8	12	19	27	49
	J	kgf·cm·s ²	49	124	194	280	497	49	124	194	280	497
Inertia moment (with brake)	GD ² /4	kg·m ²	5.8	15	23	33	59	5.8	15	23	33	59
	J	kgf·cm·s ²	59	150	235	338	601	59	150	235	338	601
Permissible moment load	N·m	849										
	kgf·m	86.6										
Moment stiffness	N·m/rad	179 × 10 ⁴										
	kgf·m/arc-min	53.2										
One-way positional accuracy	arc-sec.	40	30	30	30	30	40	30	30	30	30	
Repeatability	arc-sec.	±4										
Bi-directional repeatability	arc-sec.	50	20	20	20	20	50	20	20	20	20	
Encoder type	Absolute encoder with battery buffered multi-turn											
Encoder resolution	Single-turn	2 ¹⁷ (131072)										
	Multi-turn ^{*6}	2 ¹⁶ (65536)										
Output shaft resolution	counts/rev	6553600	10485760	13107200	15728640	20971520	6553600	10485760	13107200	15728640	20971520	
Mass (without brake)	kg	13.0										
Mass (with brake)	kg	13.8										
Environmental conditions ^{*7}	Operating temperature: 0 to 40 °C/Storage temperature: -20 to 60 °C Operating humidity/storage humidity: 20 to 80 %RH (no condensation) Resistance to vibration: 25 m/s ² (frequency: 10 to 400 Hz) Shock resistance: 300 m/s ² ^{*5} No dust, no metal powder, no corrosive gas, no inflammable gas, no oil mist To be used indoors, no direct sunlight Altitude: less than 1000 m above sea level											
Motor insulation	Insulation resistance: 100 MΩ or more (by DC500 V insulation tester) Dielectric strength: AC1500 V/1 min Insulation class: A											
Mounting direction	Can be installed in any direction.											
Protection structure	Totally enclosed self-cooled type (IP54)											

The table shows typical output values of actuators.

*1: If a HA-800□-6D/E driver is combined with a SHA40A actuator, the maximum torque and allowable continuous torque are limited.

*2: Typical characteristics when combined (driven by ideal sine wave) with our drivers.

*3: Value after temperature rise and saturation when the 500x500x25 [mm] aluminum radiation plate is installed.

*4: Value of phase induced voltage constant multiplied by 3.

*5: For testing conditions, refer to [1-12 Shock resistance] (P1-41) and [1-13 Resistance to vibration] (P1-42).
Motor operation is not guaranteed in applications where vibrations and impacts are continuously applied for a long period of time.

*6: The multi-turn detector range is -32768 to 32767.

*7: For details, refer to [3-3 Location and installation] (P3-6).

1-5 Motor shaft brake

1

Outlines

The brake is used to hold the motor shaft in place when the power is turned off. With smaller sizes (SHA25A, 32A), the actuator's built-in circuit controls the voltage supplied to the brake in order to reduce the power consumption while the brake is actuated.

Be sure to use a DC power supply having proper brake excitation voltage and capable of outputting enough current for the brake actuation (release).

Specifications

SG/HP

Item	Model	SHA20A				
		51	81	101	121	161
Type		Dry non-excitation actuation type (without power-saving control)				
Brake excitation voltage	V	DC24 V \pm 10 % (no polarity) ¹				
Current consumption during suction (at 20 °C)	A _{rms}	0.37				
Current consumption during holding (at 20 °C)	A _{rms}	Same as current consumption during suction				
Holding torque ³	N·m	31	49	61	73	97
	kgf·m	3.1	5.0	6.2	7.4	9.9
Inertia moment ³ (Actuator total) (with brake)	kg·m ² (GD ² /4)	0.26	0.65	1.0	1.4	2.6
	kgf·cm·s ² (J)	2.7	6.6	10	15	26
Mass (with brake) ⁴	kg	2.1				
Allowable number of normal brakings ⁵		100000 times				
Allowable number of emergency stops ⁶		200 times				

Item	Model	SHA25A						SHA32A					
		11	51	81	101	121	161	11	51	81	101	121	161
Type		Dry non-excitation actuation type (with power-saving control)											
Brake excitation voltage	V	DC24 V \pm 10 % (no polarity) ¹											
Current consumption during suction (at 20 °C)	A _{rms}	0.8 ²						0.8 ²					
Current consumption during holding (at 20 °C)	A _{rms}	0.3						0.3					
Holding torque ³	N·m	11	51	81	101	121	161	22	102	162	202	242	322
	kgf·m	1.1	5.2	8.3	10	12	16	2.2	10	17	21	25	33
Inertia moment ³ (Actuator total) (with brake)	kg·m ² (GD ² /4)	0.034	0.66	1.7	2.6	3.7	6.6	1.7	2.3	5.9	9.2	13	23
	kgf·cm·s ² (J)	0.35	6.7	17	26	38	67	17	24	60	94	135	238
Mass (with brake) ⁴	kg	5.1	3.1				9.7	6.2					
Allowable number of normal brakings ⁵		100000 times											
Allowable number of emergency stops ⁶		200 times											

SG

Item	Model	SHA40A					SHA45A				
		51	81	101	121	161	51	81	101	121	161
Type		Dry non-excitation actuation type (without power-saving control)									
Brake excitation voltage	V	DC24 V ± 10 % (no polarity) ¹									
Current consumption during suction (at 20 °C)	A _{rms}	0.7									
Current consumption during holding (at 20 °C)	A _{rms}	Same as current consumption during suction									
Holding torque ³	N·m	204	324	404	484	644	204	324	404	484	644
	kgf·m	21	33	41	49	66	21	33	41	49	66
Inertia moment ³ (Actuator total) (With brake)	kg·m ² (GD ² /4)	6.1	15	24	34	61	7.9	20	31	45	79
	kgf·cm·s ² (J)	62	157	244	350	619	81	204	316	454	804
Mass (with brake) ⁴	kg	10.7					13.2				
Allowable number of normal brakings ⁵		100000 times									
Allowable number of emergency stops ⁶		200 times									

Item	Model	SHA58A				SHA65A			
		81	101	121	161	81	101	121	161
Type		Dry non-excitation actuation type (without power-saving control)							
Brake excitation voltage	V	DC24 V ± 10 % (no polarity) ¹							
Current consumption during suction (at 20 °C)	A _{rms}	0.9							
Current consumption during holding (at 20 °C)	A _{rms}	Same as current consumption during suction							
Holding torque ³	N·m	1220	1520	1820	2420	1220	1520	1820	2420
	kgf·m	124	155	185	246	124	155	185	246
Inertia moment ³ (Actuator total) (With brake)	kg·m ² (GD ² /4)	106	165	237	420	120	187	268	475
	kgf·cm·s ² (J)	1090	1690	2420	4290	1230	1910	2740	4850
Mass (with brake) ⁴	kg	32				40			
Allowable number of normal brakings ⁵		100000 times							
Allowable number of emergency stops ⁶		200 times							

CG

Item		Model	SHA20A					SHA25A				
			50	80	100	120	160	50	80	100	120	160
Type			Dry non-excitation actuation type (without power-saving control)					Dry non-excitation actuation type (with power-saving control)				
Brake excitation voltage	V		DC24 V \pm 10 % (no polarity) ^{*1}									
Current consumption during suction (at 20 °C)	A _{rms}		0.37					0.8 ^{*2}				
Current consumption during holding (at 20 °C)	A _{rms}		Same as current consumption during suction					0.3				
Holding torque ^{*3}	N·m		30	48	60	72	96	50	80	100	120	160
	kgf·m		3.1	4.9	6.1	7.3	9.8	5.1	8.2	10	12	16
Inertia moment ^{*3} (Actuator total) (With brake)	kg·m ² (GD ² /4)		0.23	0.6	0.94	1.3	2.4	0.60	1.5	2.4	3.4	6.1
	kgf·cm·s ² (J)		2.4	6.1	9.6	14	24	6.1	16	24	35	62
Mass (with brake) ^{*4}	kg		2.7					4.1				
Allowable number of normal brakings ^{*5}			100000 times									
Allowable number of emergency stops ^{*6}			200 times									

Item		Model	SHA32A					SHA40A				
			50	80	100	120	160	50	80	100	120	160
Type			Dry non-excitation actuation type (with power-saving control)					Dry non-excitation actuation type (without power-saving control)				
Brake excitation voltage	V		DC24 V \pm 10 % (no polarity) ^{*1}									
Current consumption during suction (at 20 °C)	A _{rms}		0.8 ^{*2}					0.7				
Current consumption during holding (at 20 °C)	A _{rms}		0.3					Same as current consumption during suction				
Holding torque ^{*3}	N·m		100	160	200	240	320	200	320	400	480	640
	kgf·m		10	16	20	24	33	20	33	41	49	65
Inertia moment ^{*3} (Actuator total) (With brake)	kg·m ² (GD ² /4)		2.0	5.1	7.9	11	20	5.8	15	23	33	59
	kgf·cm·s ² (J)		20	52	81	116	207	59	150	235	338	601
Mass (with brake) ^{*4}	kg		8.0					13.8				
Allowable number of normal brakings ^{*5}			100000 times									
Allowable number of emergency stops ^{*6}			200 times									

*1: Power supply is user's responsibility. Use a power supply capable of outputting enough current consumption during suction for the brake.

*2: The duration for current consumption during suction is 0.5 second or less for the power supply of DC24 V \pm 10 %.

*3: The values are converted for the output shaft of the actuator.

*4: The values present total mass of the actuator.

*5: The service time for normal holding is assured when the brake activates at motor shaft rotation speed of 150 rpm or less.

*6: The service time for emergency stop is assured when the brake activates at motor speed of 3000 rpm or less provided the load inertia moment is 3 times of less than that of the actuator.



WARNING

The motor shaft holding brake cannot be used for deceleration.
Do not use the holding brake more than the allowable number of normal brakings (100000 times at the motor shaft rotation speed of 150 rpm or less) or allowable number of emergency stops (200 times at the motor shaft rotation speed of 3000 rpm, provided the load inertia moment is 3 times or less than that of the actuator).

Exceeding the allowable number of normal brakings and allowable number of emergency stops may deteriorate holding torque, and may consequently become out of use as a brake.

1-6 External dimensions

● SHA20A-SG

Unit [mm]

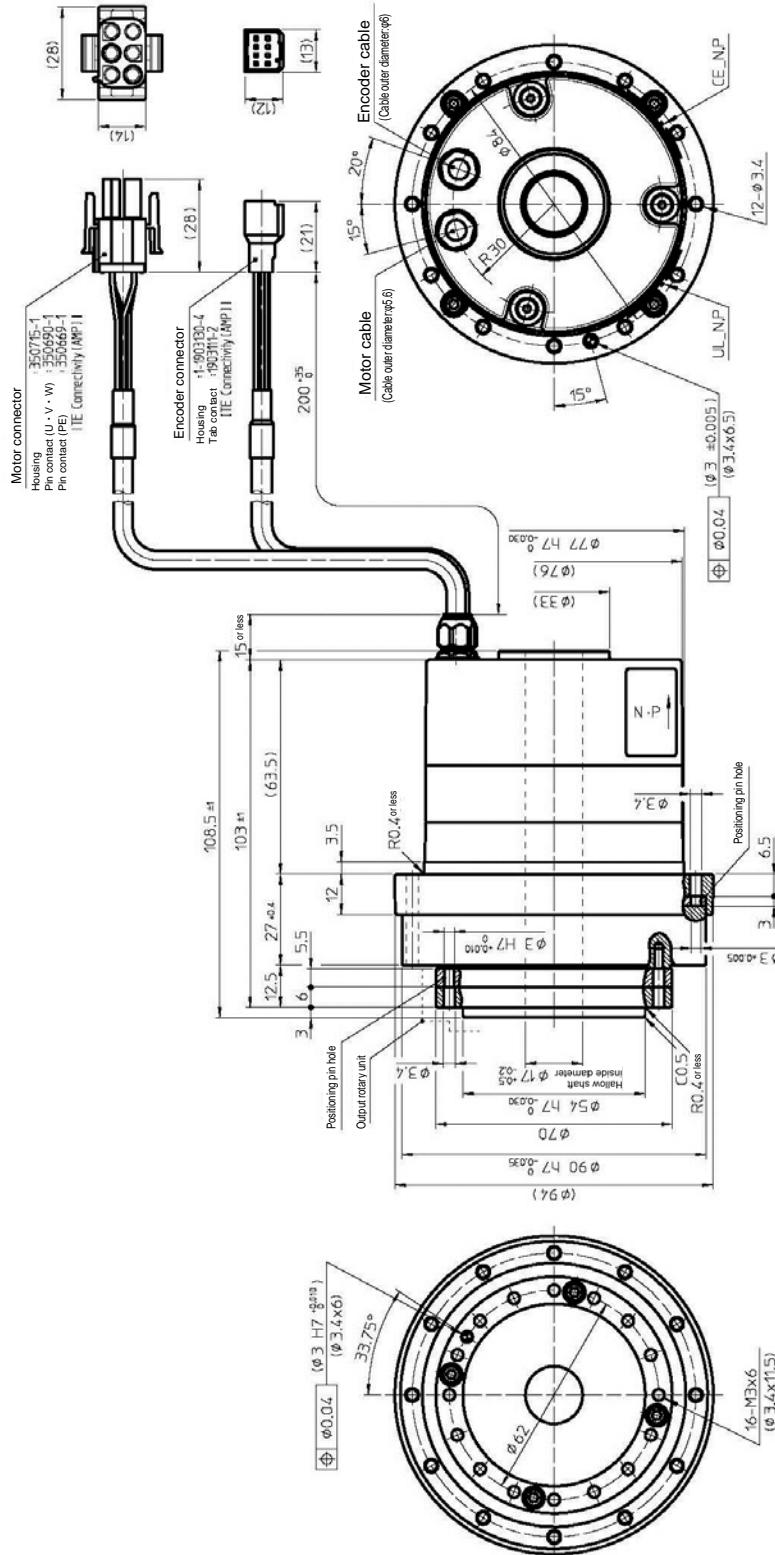

Note: The dimension tolerances that are not specified vary depending on the manufacturing method. Please check the confirmation drawing or contact us for dimension tolerances not shown. Refer to [3-3 Location and installation] (P3-6) for the allowable cable bending radius.

● SHA20A-CG

Unit [mm]

1
Outlines

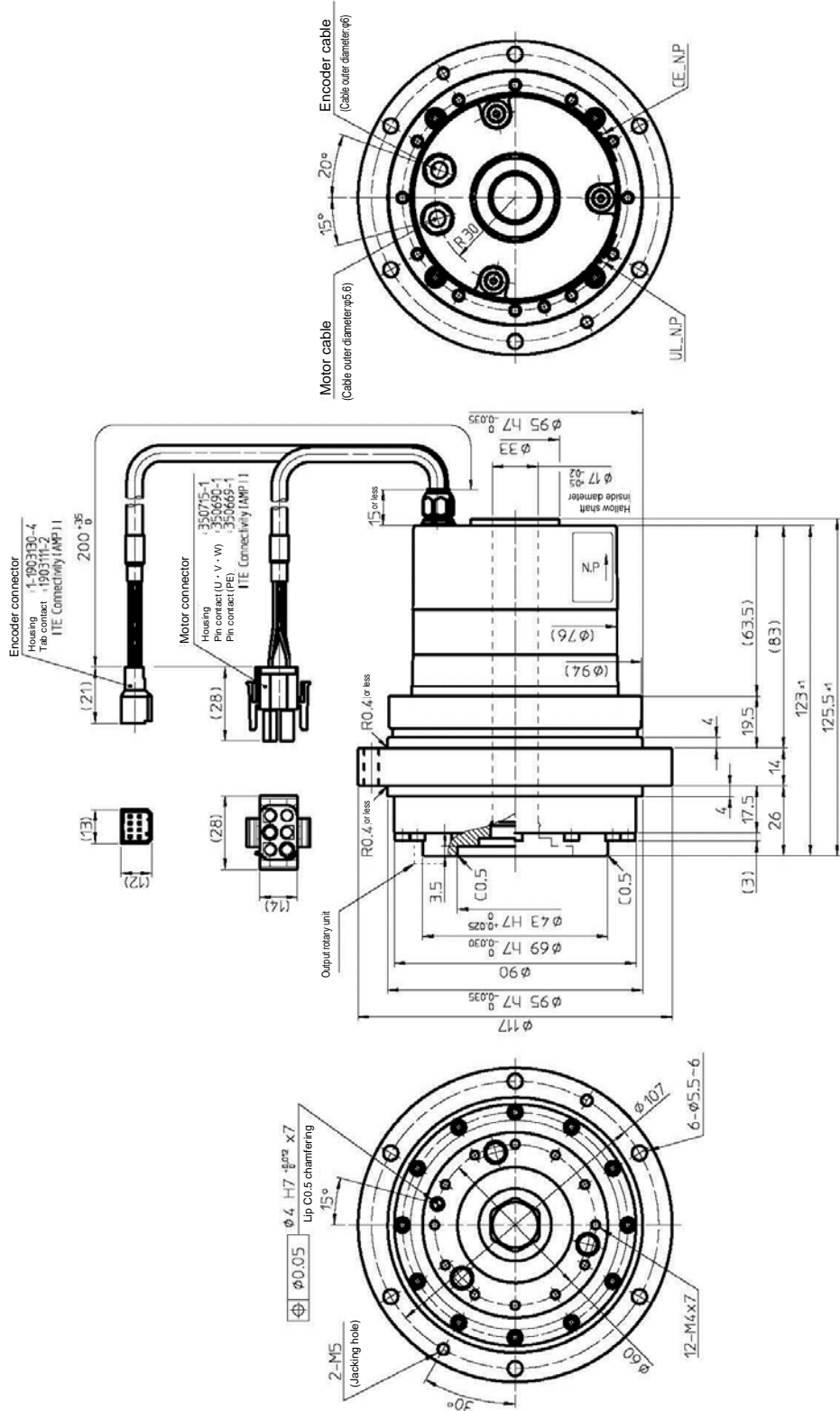

Note: The dimension tolerances that are not specified vary depending on the manufacturing method. Please check the confirmation drawing or contact us for dimension tolerances not shown. Refer to [3-3 Location and installation] (P3-6) for the allowable cable bending radius.

● SHA25A-HP

Unit [mm]

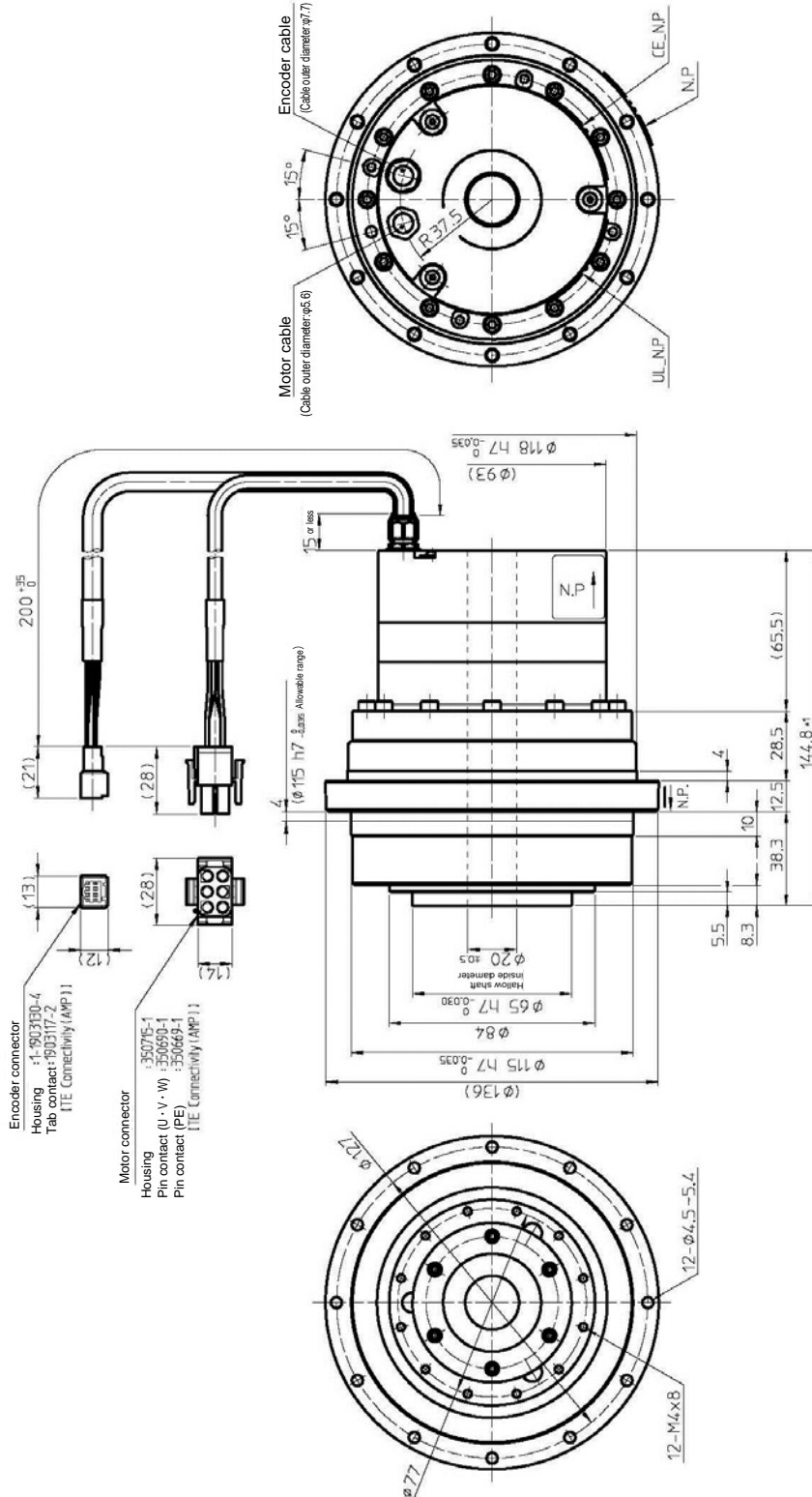

Note: The dimension tolerances that are not specified vary depending on the manufacturing method. Please check the confirmation drawing or contact us for dimension tolerances not shown. Refer to [3-3 Location and installation] (P3-6) for the allowable cable bending radius.

● SHA25A-SG

Unit [mm]

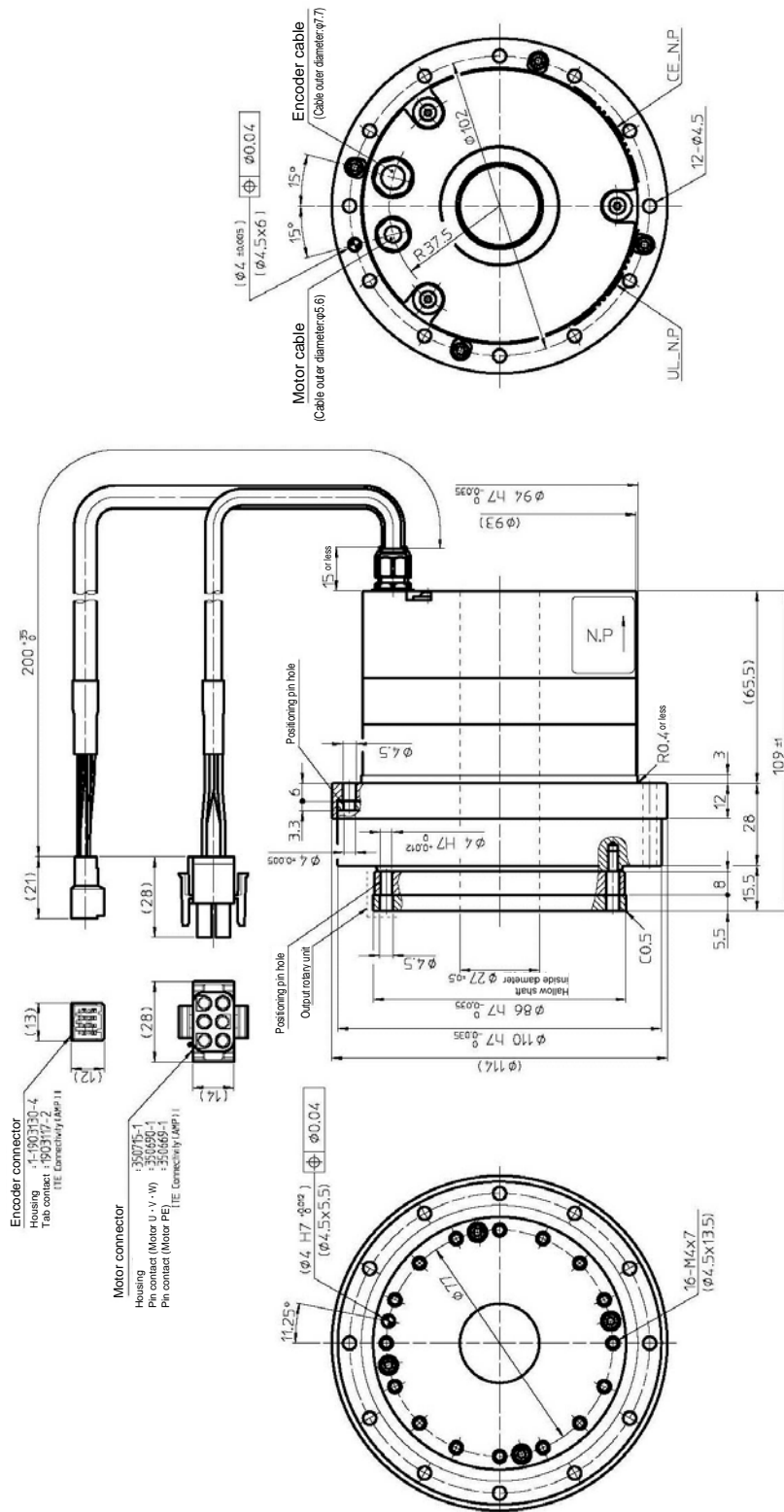

Note: The dimension tolerances that are not specified vary depending on the manufacturing method. Please check the confirmation drawing or contact us for dimension tolerances not shown. Refer to [3-3 Location and installation] (P3-6) for the allowable cable bending radius.

● SHA25A-CG

Unit [mm]

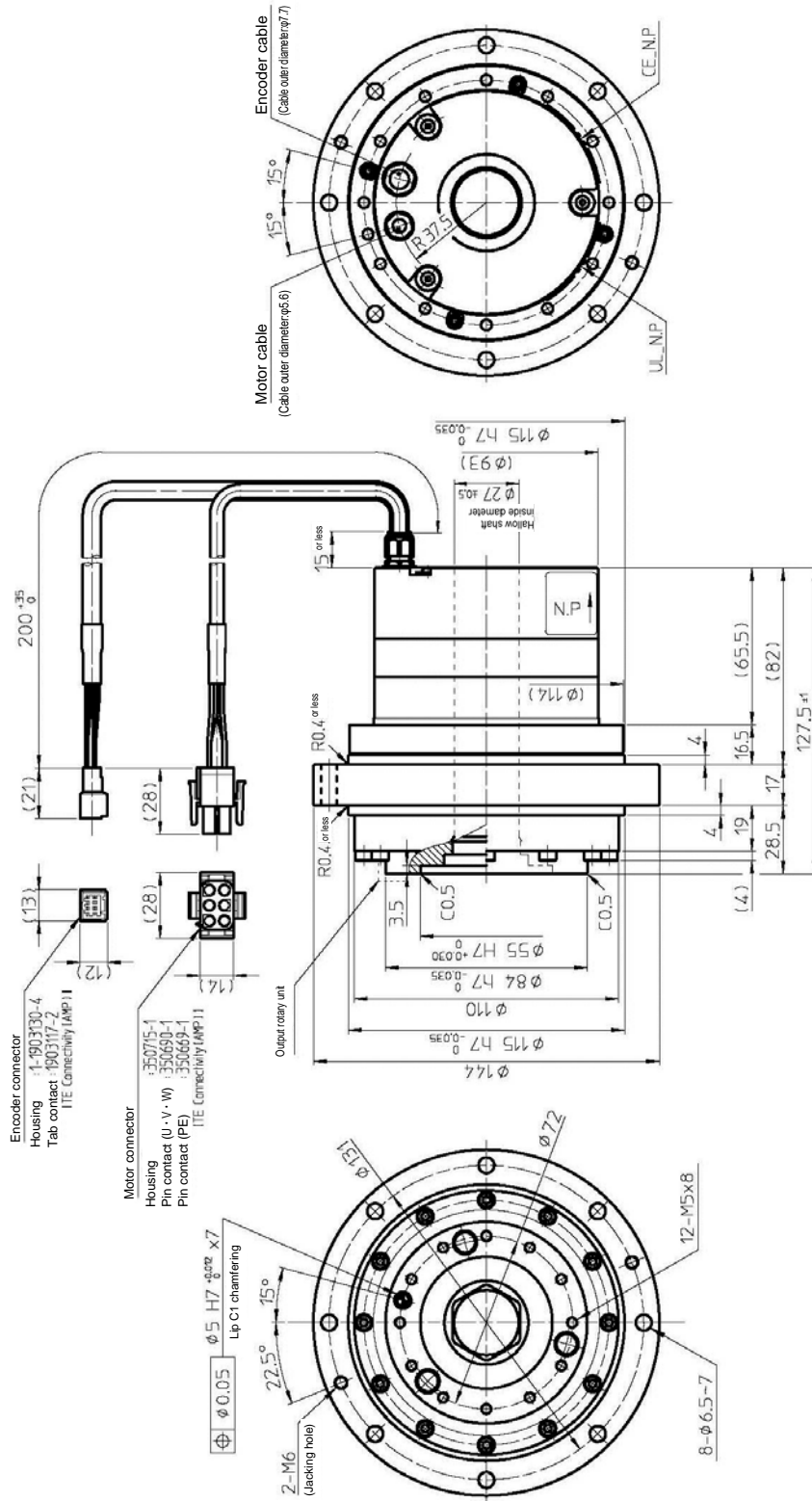

Note: The dimension tolerances that are not specified vary depending on the manufacturing method. Please check the confirmation drawing or contact us for dimension tolerances not shown. Refer to [3-3 Location and installation] (P3-6) for the allowable cable bending radius.

● SHA32A-HP

Unit [mm]

1
Outlines

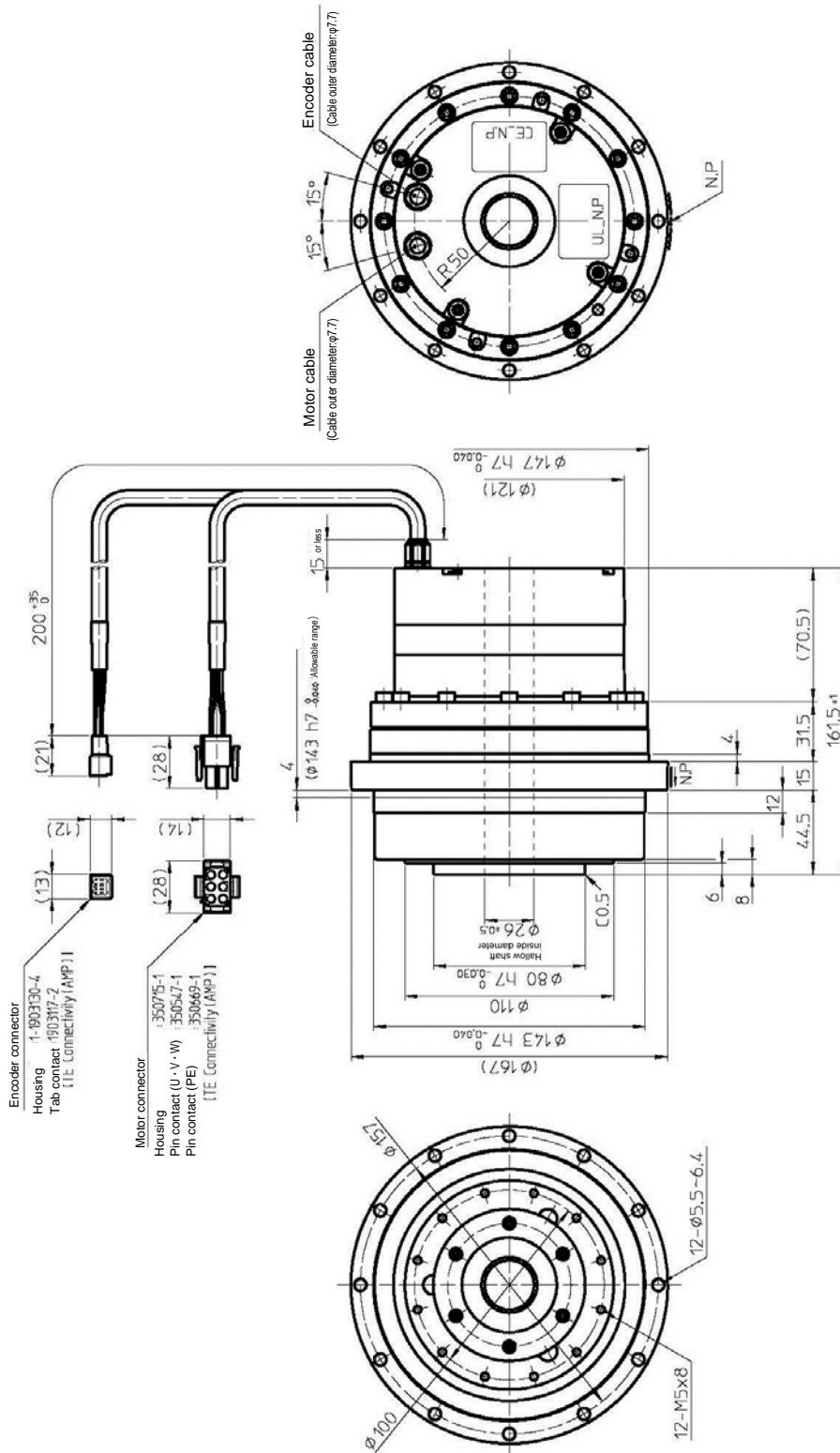

Note: The dimension tolerances that are not specified vary depending on the manufacturing method. Please check the confirmation drawing or contact us for dimension tolerances not shown. Refer to [3-3 Location and installation] (P3-6) for the allowable cable bending radius.

1 Outlines

- SHA32A-SG

Unit [mm]

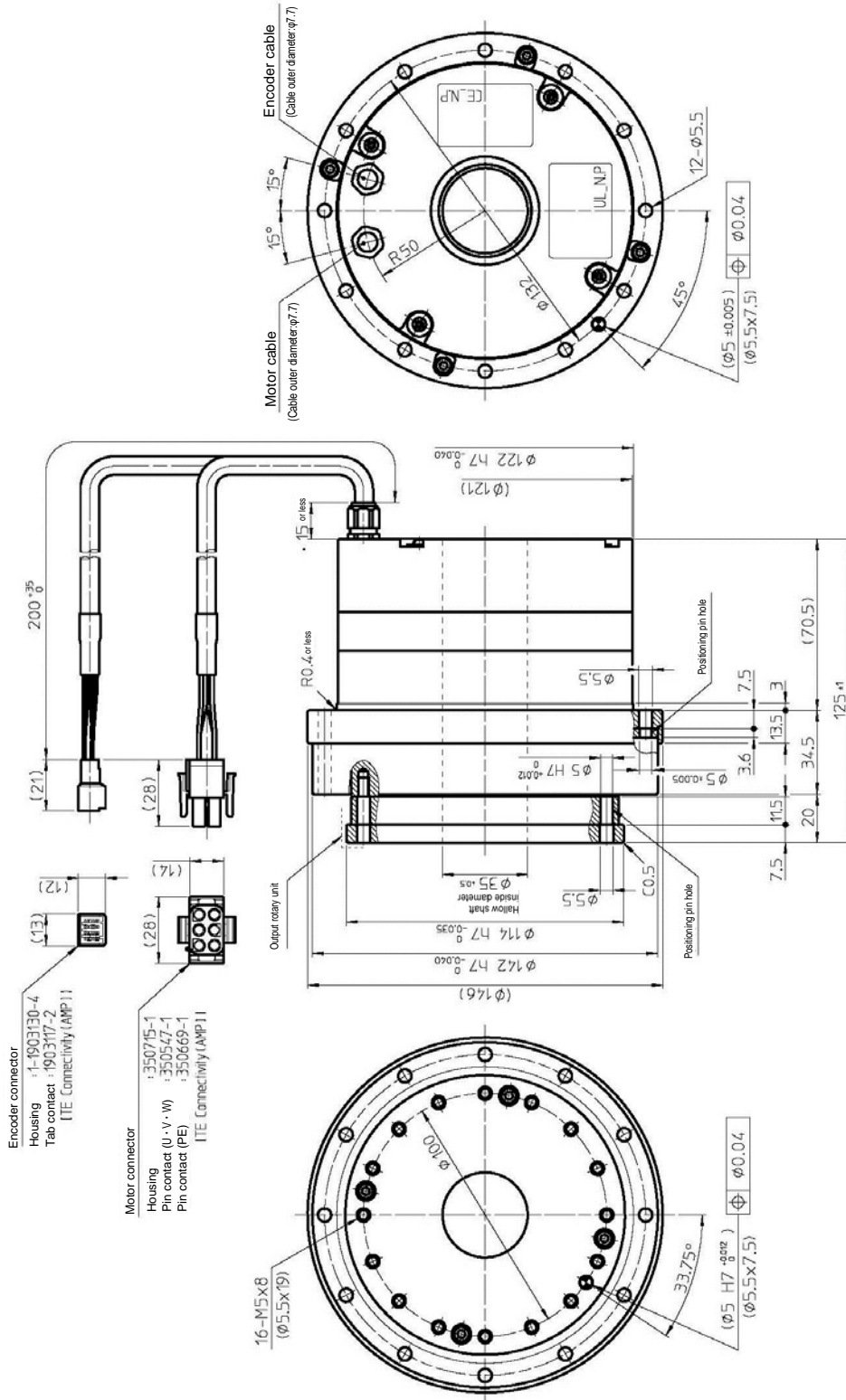

Note: The dimension tolerances that are not specified vary depending on the manufacturing method. Please check the confirmation drawing or contact us for dimension tolerances not shown. Refer to [3-3 Location and installation] (P3-6) for the allowable cable bending radius.

● SHA32A-CG

Unit [mm]

1
Outlines

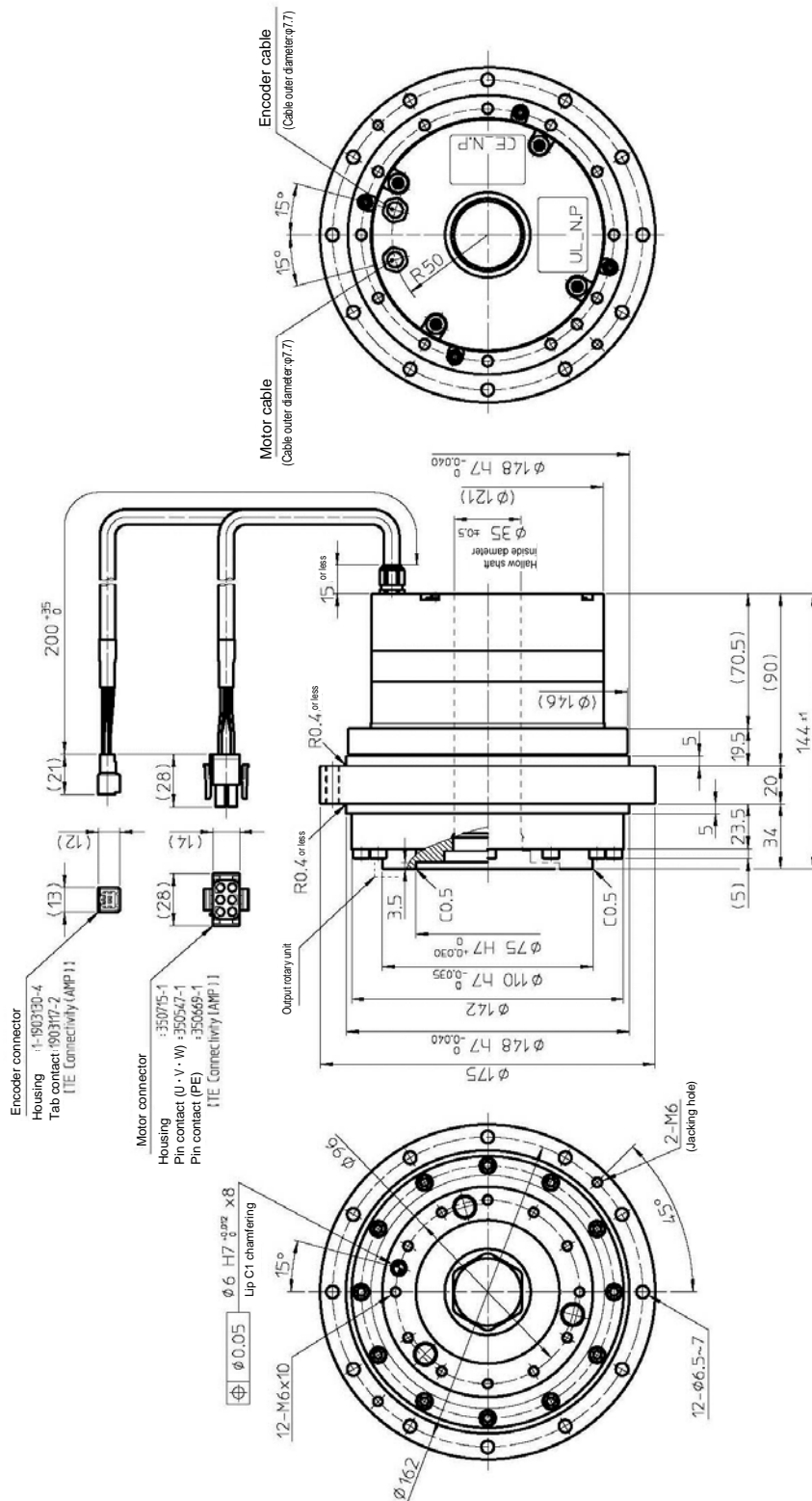

Note: The dimension tolerances that are not specified vary depending on the manufacturing method. Please check the confirmation drawing or contact us for dimension tolerances not shown. Refer to [3-3 Location and installation] (P3-6) for the allowable cable bending radius.

● SHA40A-CG

Unit [mm]

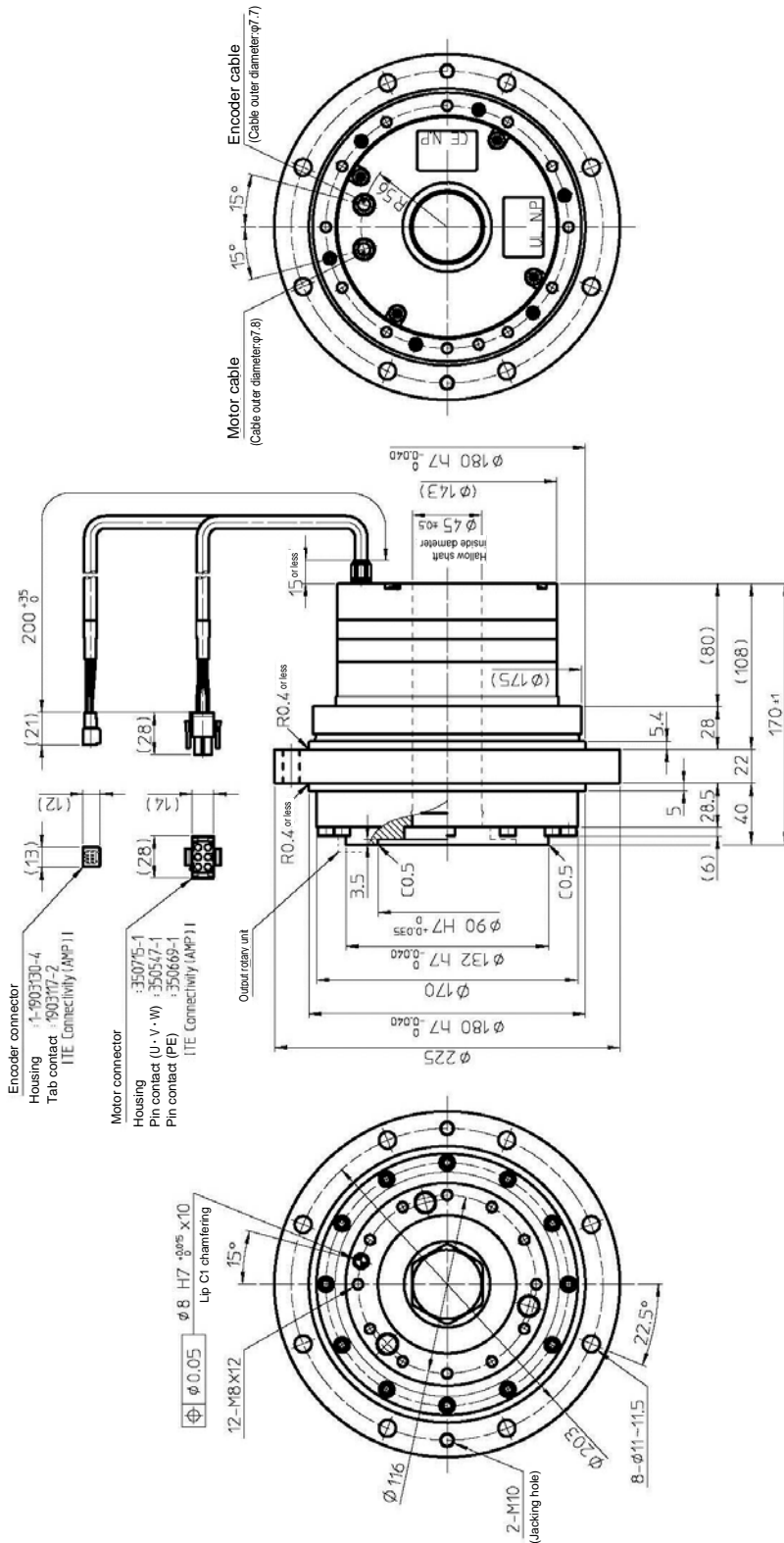

Note: The dimension tolerances that are not specified vary depending on the manufacturing method. Please check the confirmation drawing or contact us for dimension tolerances not shown. Refer to [3-3 Location and installation] (P3-6) for the allowable cable bending radius.

● SHA45A-SG

Unit [mm]

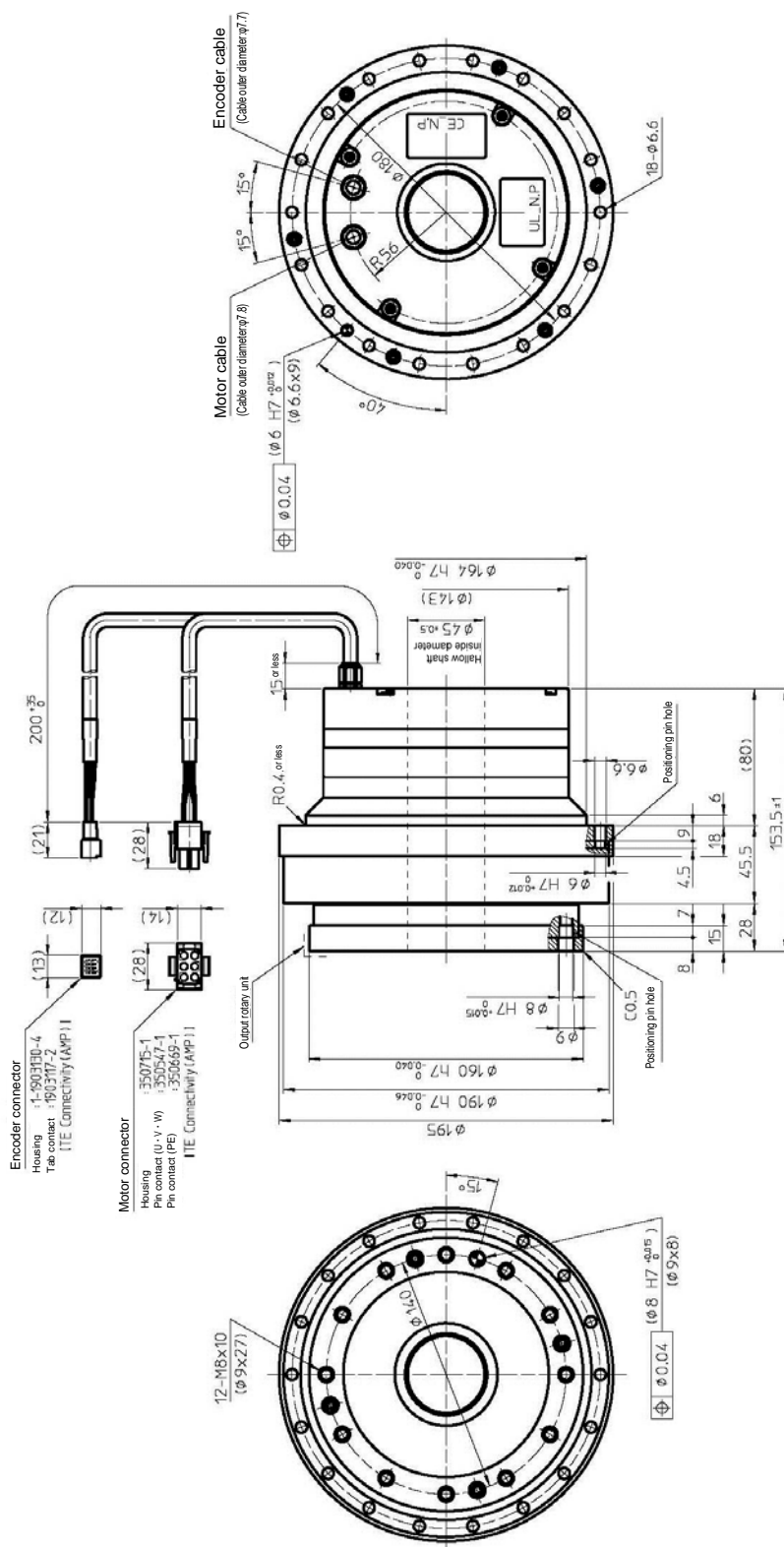

Note: The dimension tolerances that are not specified vary depending on the manufacturing method. Please check the confirmation drawing or contact us for dimension tolerances not shown. Refer to [3-3 Location and installation] (P3-6) for the allowable cable bending radius.

● SHA58A-SG

Unit [mm]

1
Outlines

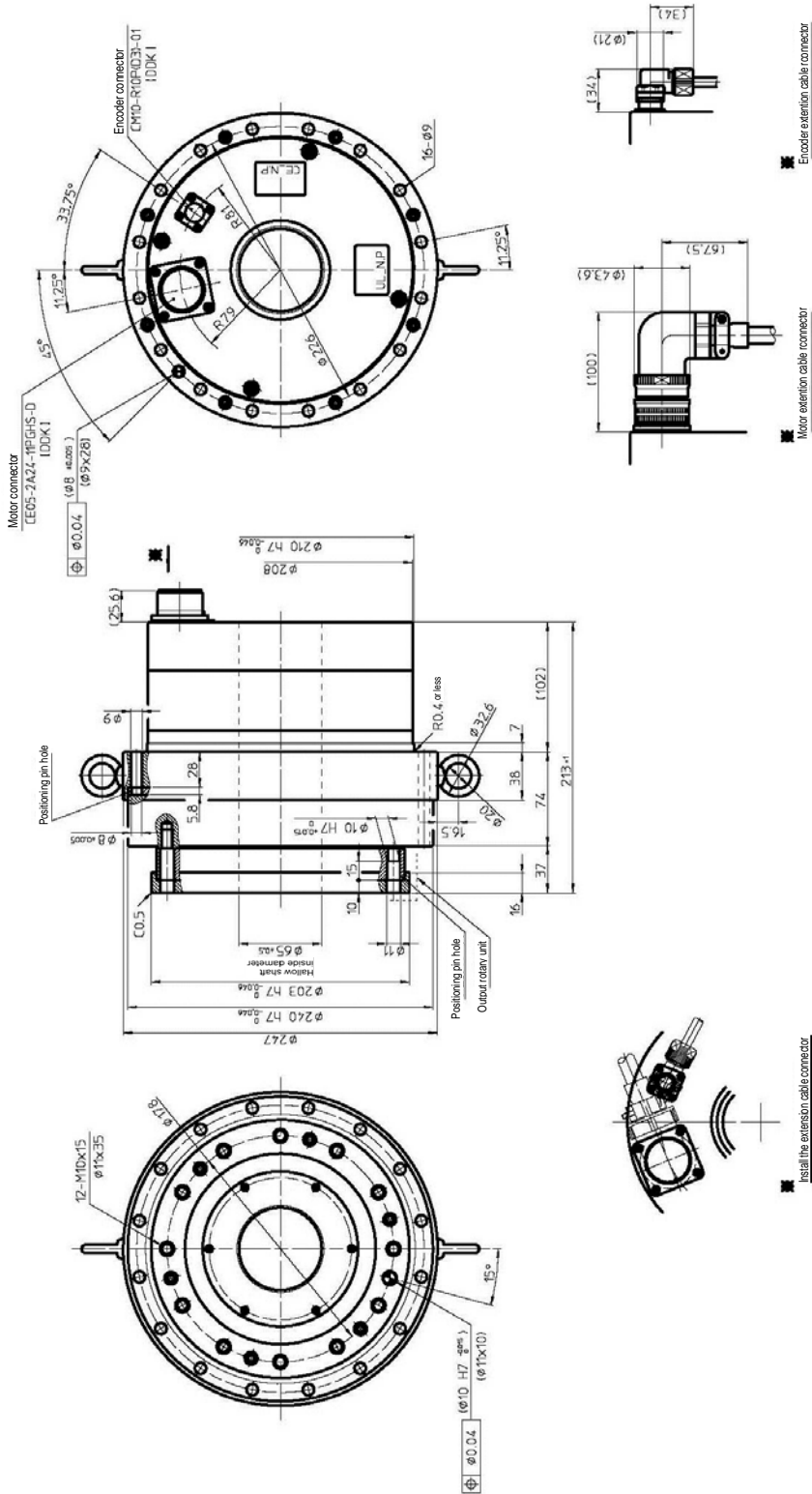

Note: The dimension tolerances that are not specified vary depending on the manufacturing method. Please check the confirmation drawing or contact us for dimension tolerances not shown. Refer to [3-3 Location and installation] (P3-6) for the allowable cable bending radius.

● SHA65A-SG

Unit [mm]

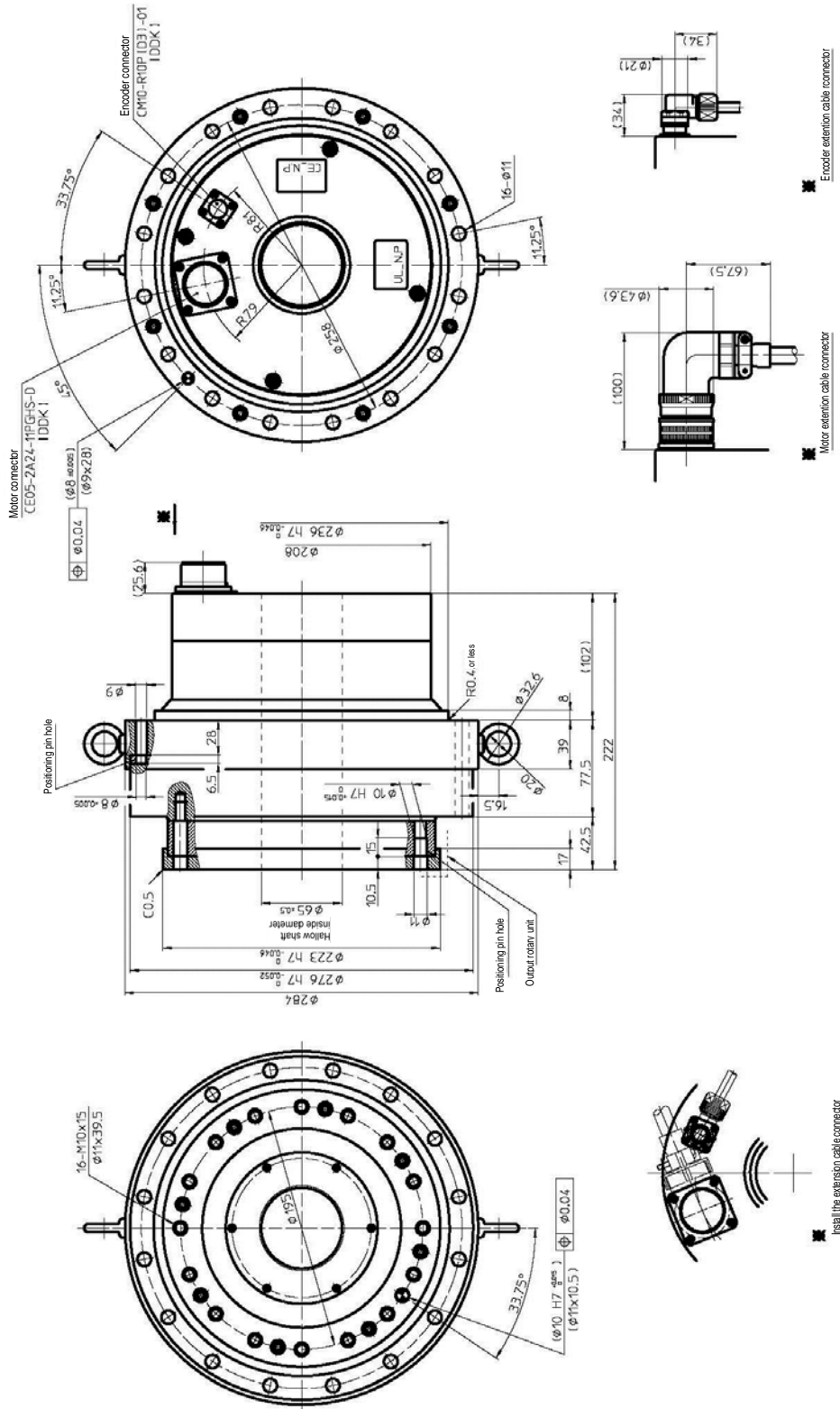

Note: The dimension tolerances that are not specified vary depending on the manufacturing method. Please check the confirmation drawing or contact us for dimension tolerances not shown. Refer to [3-3 Location and installation] (P3-6) for the allowable cable bending radius.

1-7 Mechanical accuracy

The mechanical accuracies of the output shaft and mounting flange are shown below:

SG/HP type		Unit [mm]			
Accuracy items	SHA20A	SHA25A	SHA32A	SHA40A	
1. Axial runout of output shaft	0.030	0.035 (0.020)	0.040 (0.020)	0.045	
2. Radial runout of output shaft	0.030	0.035	0.040	0.045	
3. Parallelism between the output shaft and mounting surface	0.030	0.035	0.040	0.045	
4. Parallelism between the output shaft and mounting surface	0.055	0.050	0.055	0.060	
5. Concentricity between the output shaft and mounting pilot	0.030	0.035	0.040	0.045	
6. Concentricity between the output shaft and mounting pilot	0.045	0.060	0.065	0.070	

Accuracy items	SHA45A	SHA58A	SHA65A
1. Axial runout of output shaft	0.045	0.050	0.050
2. Radial runout of output shaft	0.045	0.050	0.050
3. Parallelism between the output shaft and mounting surface	0.045	0.050	0.050
4. Parallelism between the output shaft and mounting surface	0.060	0.070	0.070
5. Concentricity between the output shaft and mounting pilot	0.045	0.050	0.050
6. Concentricity between the output shaft and mounting pilot	0.070	0.080	0.080

Note: All values are T.I.R. (Total Indicator Reading).

The values in parenthesis are those combined with the HPF hollow shaft planetary speed reducer.

CG type		Unit [mm]			
Accuracy items	SHA20A	SHA25A	SHA32A	SHA40A	
1. Axial runout of the output shaft	0.010	0.010	0.010	0.010	
2-1. Radial runout output shaft (Outside pilot)	0.010	0.010	0.010	0.010	
2-2. Radial runout output shaft (Inside pilot)	0.015	0.015	0.015	0.015	
3. Parallelism between the output shaft and mounting surface	0.030	0.030	0.035	0.035	
4. Parallelism between the output shaft and mounting surface	0.040	0.040	0.045	0.045	
5. Concentricity between the output shaft and mounting pilot	0.050	0.050	0.055	0.060	
6. Concentricity between the output shaft and mounting pilot	0.060	0.060	0.065	0.070	

Note: All values are T.I.R. (Total Indicator Reading).

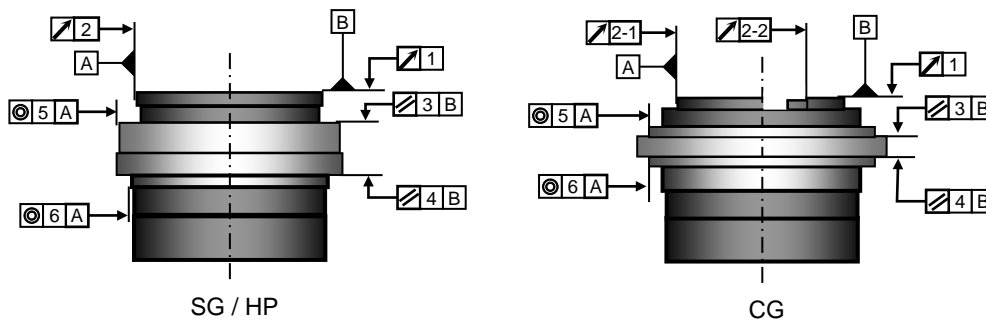

Definitions:

1 Output shaft surface runout

The indicator on the fixed part measures the axial runout (maximum runout width) of the outermost circumference of output shaft of the output rotary unit per revolution.

2 Radial runout of output shaft

The indicator on the fixed part measures the radial runout (maximum runout width) of output shaft of the output rotary unit per revolution.

3,4 Parallelism between the output shaft and mounting pilot

The indicator on the output rotary unit measures the axial runout (maximum runout width) of the outermost circumference of the mounting surface (both on the output shaft side and opposite side) of the output rotary unit per revolution.

5,6 Concentricity between the output shaft and mounting pilot

The indicator on the output rotary unit measures the radial runout (maximum runout width) of the fitting part (both on the output shaft side and opposite side) of the output rotary unit per revolution.

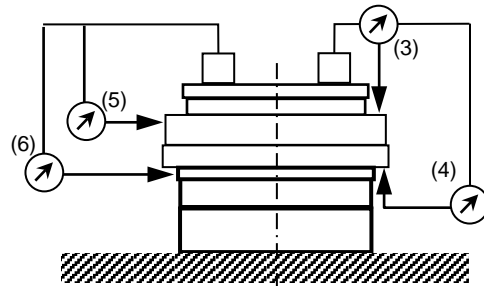
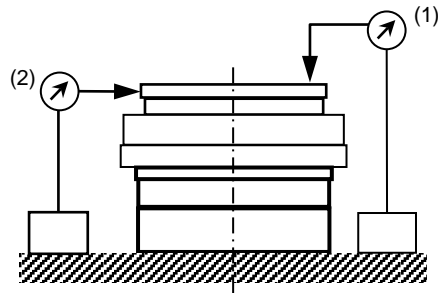

1-8 Positional accuracy

One-way positional accuracy

The one-way positioning accuracy is defined as the maximum positional difference between the commanded position and the actual stop position when a series of positioning moves are performed in the same rotation direction. (Refer to JIS B-6201-1987).
 The SHA series incorporates a HarmonicDrive® speed reducer or an HPF hollow shaft planetary gear which inherently has high rotational position accuracy. Because of the gearing's high ratio, any rotational error at the input (i.e. motor shaft position error or motor feedback error) is reduced by a factor of the ratio (1/ratio) and typically becomes negligible at the output. Therefore, most of the error is represented by the transmission error of the gear itself.

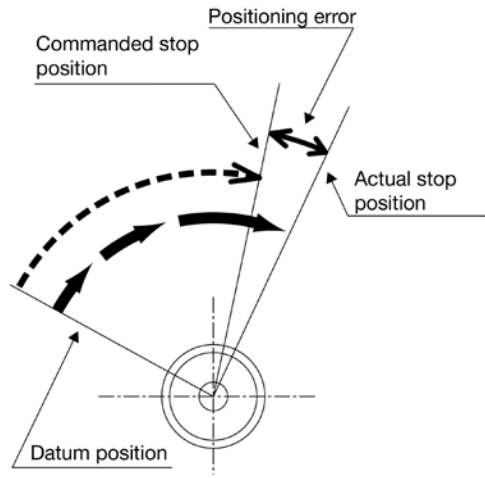

The one-way positional accuracy is shown in the table below:

SG/HP Unit [arc-sec]

Reduction ratio \ Model	SHA20A	SHA 25A	SHA32A	SHA40A	SHA45A	SHA58A	SHA65A
11:1	—	120	120	—	—	—	—
51:1	60	50	50	50	50	—	—
81:1 or more	50	40	40	40	40	40	40

CG Unit [arc-sec]

Reduction ratio \ Model	SHA20A	SHA25A	SHA32A	SHA40A
50:1	60	50	40	40
80:1 or more	50	40	30	30

Repeatability (CG)

The repeatability is measured by moving to a given theoretical position seven times, each time approaching from the same direction. The actual position of the output shaft is measured each time and repeatability is calculated as the 1/2 of the maximum difference of the seven data points. Measured values are indicated in angles (arc-sec) prefixed with "±". (Refer to JIS B 6201-1987.)

CG		Unit [arc-sec]			
Reduction ratio	Model	SHA20A	SHA25A	SHA32A	SHA40A
Ratio to full speed		±5	±5	±4	±4

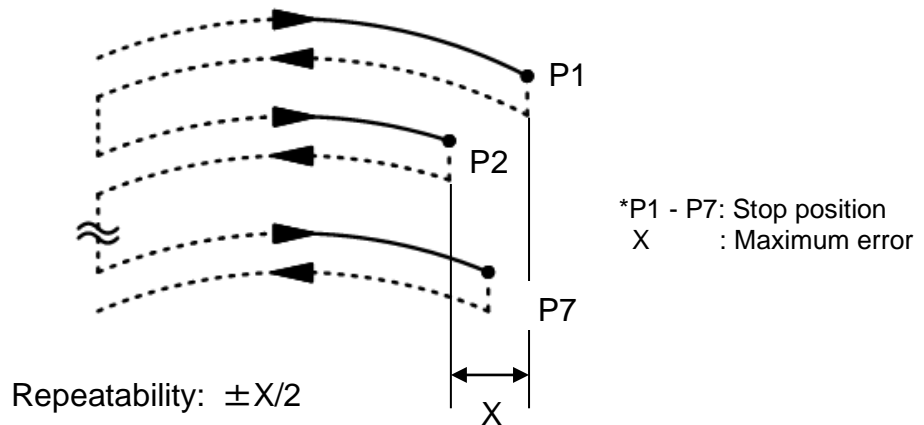

Bi-directional repeatability (CG)

For the "bi-directional repeatability", the shaft is rotated beforehand in the forward (or reverse) direction and the stop position for that rotation is set as the reference position. An instruction is given to rotate the shaft in the same direction and from the stopped position, the same instruction is given in the reverse (or forward) direction and the difference between the stop position after this rotation and the reference position is measured. The average value from repeating this 7 times in each direction is shown and the maximum value measured at the 4 locations on the output shaft is shown.

CG		Unit [arc-sec]			
Reduction ratio	Model	SHA20A	SHA25A	SHA32A	SHA40A
1:50		75	60	60	50
1:80 of more		30	25	25	20

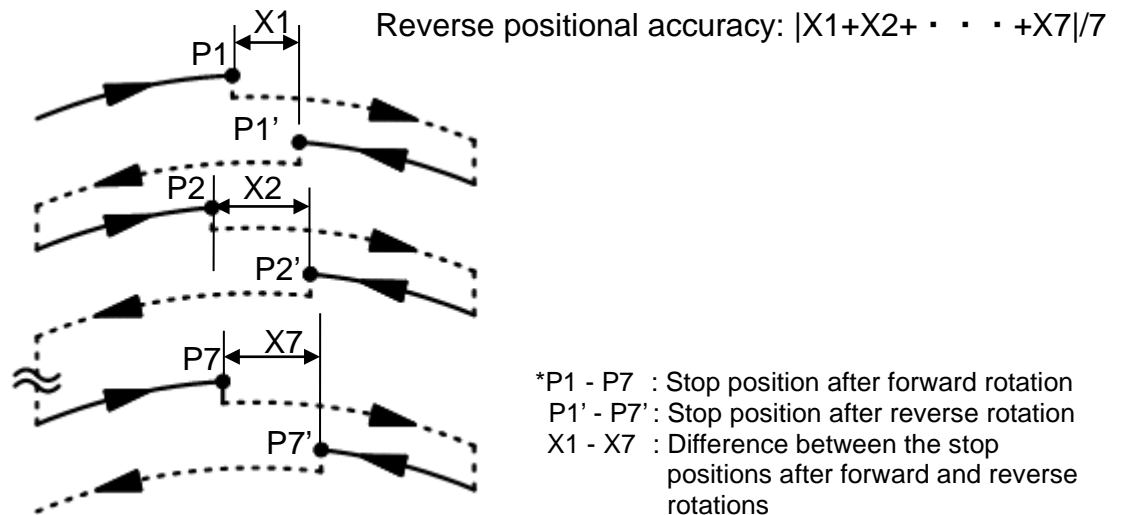

1-9 Encoder specifications (Absolute encoder)

The absolute encoder used in the SHA series is a multi-turn magnetic absolute encoder. This encoder consists of 17 bit single turn absolute encoder and a 16 bit cumulative counter for detecting the number of total revolutions.

This encoder constantly detects the absolute machine position and stores it by means of the backup battery, regardless of whether the driver or external controller power is turned ON/OFF. Accordingly, once the origin is detected when the machine is installed, originating is not required after subsequent power ON operation. This facilitates the recovery operation after a power failure or breakdown.

In addition, while the power is ON, the multi-turn detector portion that detects the single revolution absolute position and the number of revolutions is a dual-redundant system in which a matching check is always performed on data, and this highly reliable design allows for encoder errors to be self-detected should they occur.

In addition, a backup capacitor is installed in the encoder to retain absolute positions even when the driver-encoder extension cable is disconnected for initial startup of the device, etc. However, the backup capacitor has a limited life and its performance deteriorates. Therefore, it is recommended that you replace the backup battery in the HA-800 driver while the driver is receiving power.

Specifications

Type ^{*1}	Magnetic sensor/electronic battery backup type (Single rotation optic, multiple revolution magnetic sensor/electronic battery backup type)
Single-turn detector	2 ¹⁷ : 131072 pulses
Multi-turn detector	2 ¹⁶ : 65536 (-32768 to 32767)
Maximum permissible motor shaft rotational speed	7000 rpm ^{*2}
Safety/redundancy	<ul style="list-style-type: none"> • Check method in which two identical single revolution detectors are compared • Check method in which two identical cumulative revolution counters are compared
Backup time by external battery	1 year ^{*3} (when power is not supplied)
Backup time by internal battery	30 minutes (after 3 hours of charge, ambient temperature of 25 °C, axis stopped) (For backup while the driver and encoder are disconnected briefly)

*1: Size 20 is equipped with an optical encoder; other models are equipped with a magnetic encoder.

*2: This is the rotation speed limit of the encoder and is different from the rotation speed that the motor can drive.

*3: The value is obtained with the motor axis stopped. Frequent movement of the motor axis with no power supply would cause the external battery to drain quickly.

Resolution of output shaft

Encoder resolution		17bit (2 ¹⁷ : 131072 pulses)					
Reduction ratio		11:1	51:1	81:1	101:1	121:1	161:1
Resolution of output shaft	Pulse/rev	1441792	6684672	10616832	13238272	15859712	21102592
Resolvable angle per pulse	Sec.	Approx. 0.9	Approx. 0.2	Approx. 0.12	Approx. 0.1	Approx. 0.082	Approx. 0.061
Reduction ratio		50:1	80:1	100:1	120:1	160:1	
Resolution of output shaft	pulse/rev	6553600	10485760	13107200	15728640	20971520	
Resolvable angle per pulse	Sec.	Approx. 0.2	Approx. 0.12	Approx. 0.1	Approx. 0.082	Approx. 0.062	

Absolute position data

[Absolute position] indicates the absolute position within one motor shaft revolution, while [multi revolution] indicates the number of motor revolutions. The position of the actuator output shaft is obtained by the following formula:

Position of actuator output shaft = (Absolute position + Multi revolution data × Encoder resolution) / Reduction ratio

Transfer of encoder data

Data is transferred via bi-directional communication in a normal condition while power is supplied. When the driver control power supply is turned OFF and the driver enters the battery backup mode, communication stops.

Output shaft single revolution absolute model (Option)

With the standard actuator, when it continues to rotate in just one direction, the absolute encoder eventually exceeds the number of revolutions that can be detected with multi-revolution detection and it becomes impossible to manage position information accurately.

With the output shaft single revolution absolute model, each time the output shaft turns through single revolution, the cumulative multi revolution counter is cleared to 0. This is how position information is accurately managed when the shaft continuously turns in just one direction.

1-10 Stiffness

1

Outlines

Moment stiffness

The moment stiffness refers to the torsional stiffness when a moment load is applied to the output shaft of the actuator (shown in the figure).

For example, when a load is applied to the end of an arm attached on the output shaft of the actuator, the face of the output shaft of the actuator tilts in proportion to the moment load. The moment stiffness is expressed as the load/gradient angle.

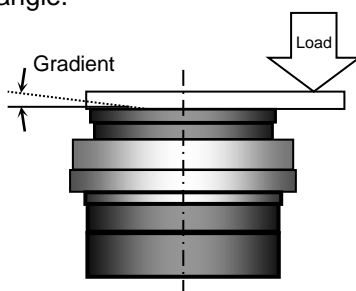

Model		SHA20A	SHA25A		SHA32A	
Item	Reduction ratio	50:1 or more	11:1	50:1 or more	11:1	50:1 or more
Moment stiffness	N·m/rad	25.2×10^4	37.9×10^4	39.2×10^4	86.1×10^4	100×10^4
	kgf·m/rad	25.7×10^3	38.7×10^3	40×10^3	87.9×10^3	102×10^3
	kgf·m/arc-min	7.5	11.3	11.6	25.7	29.6

Model		SHA40A	SHA45A	SHA58A	SHA65A
Item	Reduction ratio	50:1 or more	51:1 or more	81:1 or more	81:1 or more
Moment stiffness	N·m/rad	179×10^4	257×10^4	531×10^4	741×10^4
	kgf·m/rad	183×10^3	262×10^3	542×10^3	756×10^3
	kgf·m/arc-min	53.2	76.3	158	220



Do not apply torque, load or thrust to the sleeve (hollow shaft) directly.

The sleeve (hollow shaft) is adhered to the output rotary shaft. Accordingly, the adhered sleeve may be detached from the output rotary shaft if a torque or load is applied to the sleeve (hollow shaft).

Do not apply any torque, moment load or thrust load directly to the sleeve (hollow shaft).

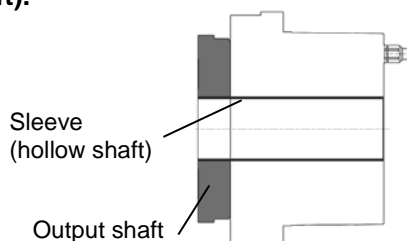

Torsional Stiffness (Ratio 50 or more: HarmonicDrive® speed reducer)

Caution

- The speed reducer uses (1) speed ratio 50 or more for the HarmonicDrive® speed reducer and (2) ratio 11 for the HPF hollow shaft planetary speed reducer. The structures of the speed reducers are different, so their rotation direction torsional stiffness are different. Refer to individual characteristics shown on the graphs and tables.

If a torque is applied to the output shaft of the actuator with the servo locked, the output shaft generates a torsional stress roughly in proportion to the torque.

The upper right figure shows the torsional angle of the output shaft when a torque starting from zero and increased to positive side [+T₀] and negative side [-T₀] is applied to the output shaft. This is called [torque vs. torsional angle] diagram, which typically follows a loop 0→A→B→A'→B'→A. The torsional rigidity of the SHA series actuator is expressed by the gradient of this [torque vs. torsional angle diagram] representing a spring constant (unit: N·m/rad).

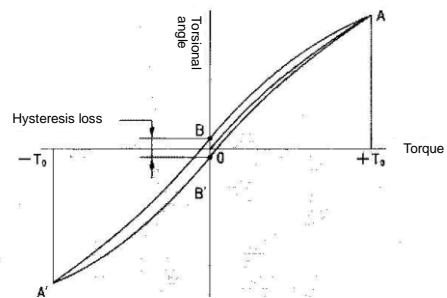

As shown by lower right figure, this [torque vs. torsional angle] diagram is divided into three regions and the spring constants in these regions are expressed by K₁, K₂, and K₃, respectively.

- K₁: Spring constant for torque region 0 to T₁
- K₂: Spring constant for torque region T₁ to T₂
- K₃: Spring constant for torque region over T₂

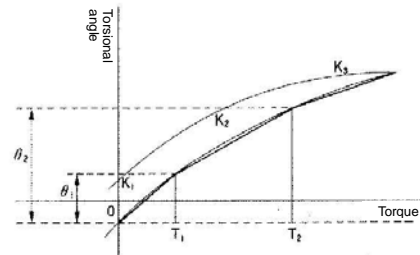

The torsional angle for each region is expressed as follows: * φ: Torsional angle

- Range where torque T is T₁ or below: $\varphi = \frac{T}{K_1}$
- Range where torque T is T₁ to T₂: $\varphi = \theta_1 + \frac{T - T_1}{K_2}$
- Range where torque T is T₂ to T₃: $\varphi = \theta_2 + \frac{T - T_2}{K_3}$

The table below shows the averages of T_1 to T_3 , K_1 to K_3 , and θ_1 to θ_2 for each actuator.

Size		SHA20A		SHA25A		SHA32A		SHA40A	
Reduction ratio		1:50 1:51	1:80 or more	1:50 1:51	1:80 or more	1:50 1:51	1:80 or more	1:50 1:51	1:80 or more
T1	N·m	7.0		14		29		54	
	kgf·m	0.7		1.4		3.0		5.5	
K1	$\times 10^4$ N·m/rad	1.3	1.6	2.5	3.1	5.4	6.7	10	13
	kgf·m/arc-min	0.38	0.47	0.74	0.92	1.6	2.0	3.0	3.8
θ_1	$\times 10^{-4}$ rad	5.2	4.4	5.5	4.4	5.5	4.4	5.2	4.1
	arc-min	1.8	1.5	1.9	1.5	1.9	1.5	1.8	1.4
T2	N·m	25		48		108		196	
	kgf·m	2.5		4.9		11		20	
K2	$\times 10^4$ N·m/rad	1.8	2.5	3.4	5.0	7.8	11	14	20
	kgf·m/arc-min	0.52	0.75	1.0	1.5	2.3	3.2	4.2	6.0
θ_2	$\times 10^{-4}$ rad	15.4	11.3	15.7	11.1	15.7	11.6	15.4	11.1
	arc-min	5.3	3.9	5.4	3.8	5.4	4.0	5.3	3.8
K3	$\times 10^4$ N·m/rad	2.3	2.9	4.4	5.7	9.8	12	18	23
	kgf·m/arc-min	0.67	0.85	1.3	1.7	2.9	3.7	5.3	6.8

Size		SHA45A		SHA58A	SHA65A
Reduction ratio		1:51	1:81 or more	1:81 or more	1:81 or more
T1	N·m	76		168	235
	kgf·m	7.8		17	24
K1	$\times 10^4$ N·m/rad	15	18	40	54
	kgf·m/arc-min	4.3	5.4	12	16
θ_1	$\times 10^{-4}$ rad	5.2	4.1	4.1	4.4
	arc-min	1.8	1.4	1.4	1.5
T2	N·m	275		598	843
	kgf·m	28		61	86
K2	$\times 10^4$ N·m/rad	20	29	61	88
	kgf·m/arc-min	6.0	8.5	18	26
θ_2	$\times 10^{-4}$ rad	15.1	11.1	11.1	11.3
	arc-min	5.2	3.8	3.8	3.9
K3	$\times 10^4$ N·m/rad	26	33	71	98
	kgf·m/arc-min	7.6	9.7	21	29

The table below shows reference torque values calculated for different torsional angle. Unit [N·m]

Size	SHA20A		SHA25A		SHA32A		SHA40A	
Reduction ratio	1:50 1:51	1:80 or more	1:50 1:51	1:80 or more	1:50 1:51	1:80 or more	1:50 1:51	1:80 or more
2 arc-min	8	11	15	21	31	45	63	88
4 arc-min	19	25	35	51	77	108	144	208
6 arc-min	30	43	56	84	125	178	233	342

Size	SHA45A		SHA58A	SHA65A
Reduction ratio	1:51	1:81 or more	1:81 or more	1:81 or more
2 arc-min	88	124	273	360
4 arc-min	205	293	636	876
6 arc-min	336	483	1050	1450

Torsional Stiffness (Ratio 11: HPF hollow shaft planetary gearhead)

If a torque is applied to the output unit with the input and casing of the speed reducer are locked, the output unit generates a torsion in proportion to the torque. When the values for torque are gradually changed in sequence from (1) Rated output torque in the positive rotation direction→(2) zero→(3) Rated output torque in the negative rotation direction→(4) zero→(5) Rated output torque in the positive rotation direction, the values follow a loop (1)→(2)→(3)→(4)→(5) (returns to (1)) shown in Fig.1 [torque vs. torsional angle diagram].

The gradient of the region [Rated output torque] from [0.15 × rated output torque] is small, and the torsional stiffness of the HPF series is the average of this gradient. The gradient of the region [0.15 × rated output torque] from [zero torque] is large. This gradient is caused by semi-partial contact in the meshing region and uneven load distribution from light loads and so forth on the planet gears.

An explanation is provided below on how to calculate the total torsional quantity on one side from a no-load state after a load has been applied by the speed reducer.

$$\theta = D + \frac{T - TL}{\frac{A}{B}}$$

- θ : total torsional quantity
- D: torsional quantity on one side given by rated output torque × 0.15 torque
- T: load torque
- TL: rated output torque × 0.15 torque (= $T_R \times 0.15$)
- A/B: torsional stiffness

The zero torque part widths of (2) and (4) in the figure on the right [torque vs. torsional angle diagram] is called the hysteresis loss. For the HPF series, backlash is defined as hysteresis loss [rated output torque in the negative rotation direction] from [rated output torque in the positive rotation direction]. The HPF series has a backlash of less than 3 minutes (less than 1 minute with special products) with factory settings.

Fig. 1 Torque vs. torsional angle diagram

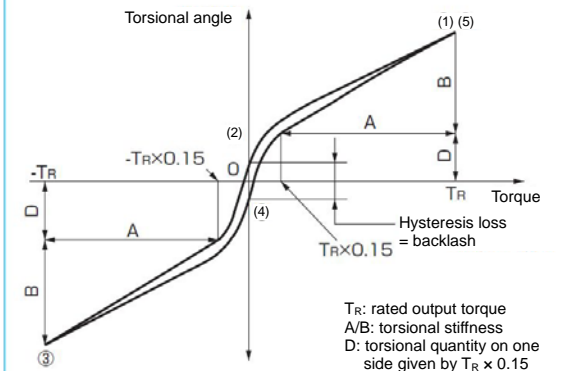

Item	Model • speed ratio	SHA25A	SHA32A
		11	11
Backlash	10 ⁻⁴ rad	8.7	8.7
	arc-min	3	3
Rated torque (T _R)	N·m	21	44
Torsional quantity on one side given by T _R × 0.15 (D)	10 ⁻⁴ rad	5.8	4.9
	arc-min	2.0	1.7
Torsional stiffness (A/B)	× 10 ⁻⁴ N·m/rad	5.70	11.7
	kgf·m/arc-min	1.7	3.5

1-11 Rotation direction

SG/HP

As a default, the rotation direction is defined as counter-clockwise (CCW) rotation as viewed from the output shaft when a FWD command pulse is given from a HA-800 driver.

This rotation direction can be changed on the HA-800 driver by selecting [SP50: Command polarity setting] under [System parameter mode 3].

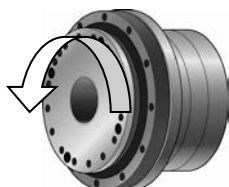

Counterclockwise rotation direction

Setting of [SP50: Command polarity setting]

Set value	FWD command pulse	REV command pulse	Setting
0	CCW (counterclockwise) direction	CW (clockwise) direction	Default
1	CW (clockwise) direction	CCW (counterclockwise) direction	

CG type

As a default, the rotation direction is defined as clockwise (CW) rotation as viewed from the output shaft when a FWD command pulse is given from a HA-800 driver.

This rotation direction can be changed on the HA-800 driver by selecting [SP50: Command polarity setting] under [System parameter mode 3].

Setting of [SP50: Command polarity setting]

Set value	FWD command pulse	REV command pulse	Setting
0	CW (clockwise) direction	CCW (counterclockwise) direction	Default
1	CCW (counterclockwise) direction	CW (clockwise) direction	

1-12 Shock resistance

The shock resistance of the actuator is as follows, and this value is the same in up/down, left/right and front/rear directions:

Impact acceleration: 300 m/s^2

In our shock resistance test, the actuator is tested 3 times in each direction. Actuator operation is not guaranteed in applications where impact exceeding the above value is constantly applied.

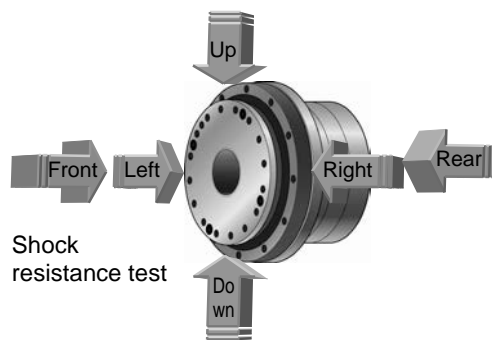

1-13 Resistance to vibration

The resistance to vibration of the actuator is as follows, and this value is the same in up/down, left/right and front/rear directions:

Vibration acceleration: 25 m/s² (frequency: 10 to 400 Hz)

In our test, the actuator is tested for 2 hours in each direction at a vibration frequency sweep period of 10 minutes.

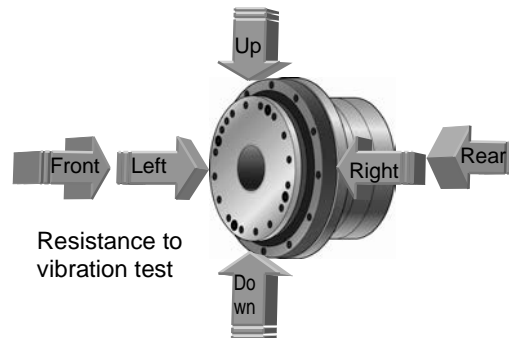

1-14 Operating range

The graph on the next page shows the operating range when a SHA series actuator and an HA-800 drive are combined.

1. Continuous motion range

The range allows continuous operation for the actuator.

2. 50 % duty motion range

This range indicates the torque rotation speed which is operating in the 50 % duty operation (the ratio of operating time and delay time is 50:50).

Limit the operation cycle to a period of several minutes, and keep it within a range where the overload alarm of the driver does not sound.

3. Motion range during acceleration and deceleration

This range indicates the torque rotation speed which is operated momentarily. The range allows instantaneous operation as is typical during acceleration and deceleration.

The continuous and 50 % duty motion ranges in each graph are measured on the condition where the radiation plate specified in the graph is installed.

Caution

- When the SHA-SG series is operated at a constant speed (motor shaft speed of 1000 rpm or less) in the same direction under a constant load torque in a condition where the output shaft is facing up (output shaft is facing down with CG type), improper lubrication of the built-in speed reducer may cause abnormal sound or wear, leading to a shorter life. Improper lubrication can be prevented by changing the speed in the operation pattern, such as by periodically stopping the actuator. However, the planetary speed reducer (ratio 11) is not included.

SG
SHA20A

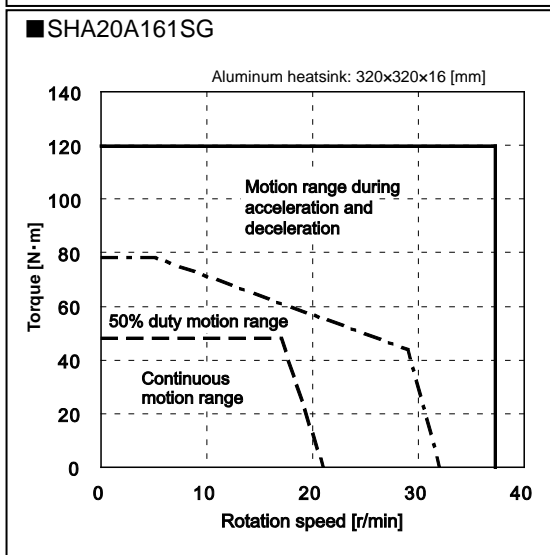
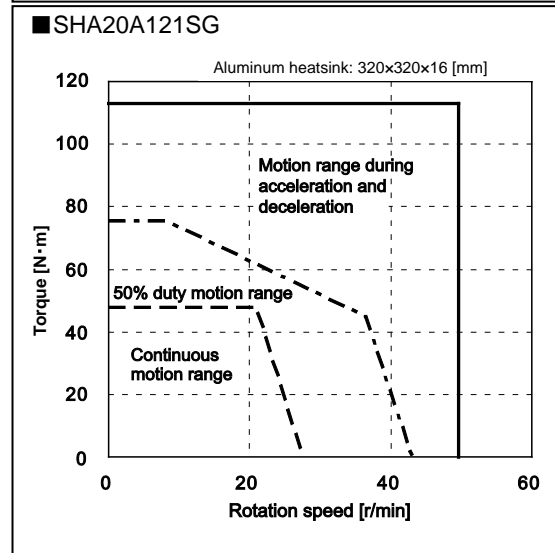
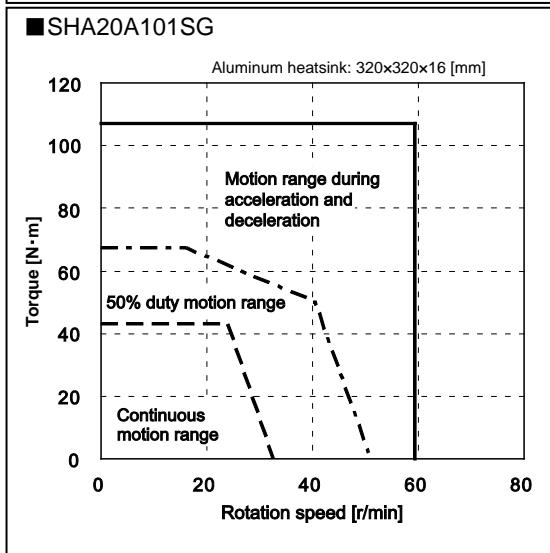
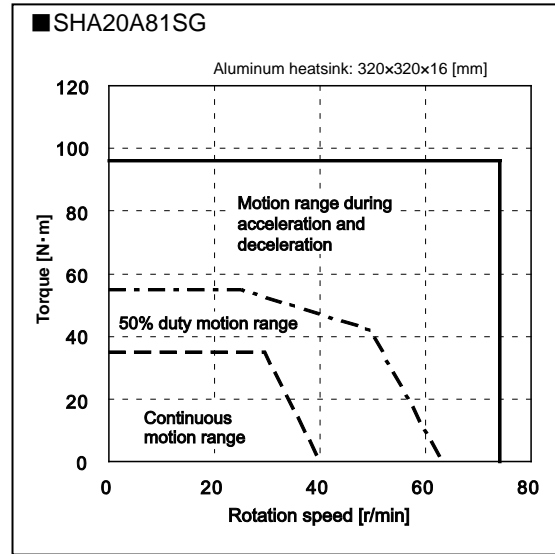
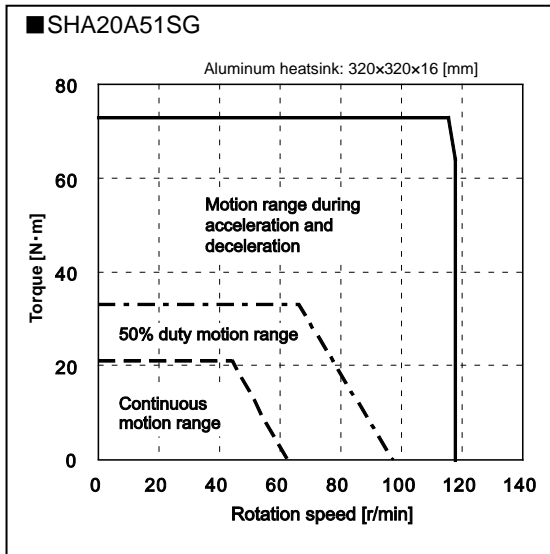

Note1: Values in the continuous motion range and 50 % duty range are measured on the condition where an aluminum heatsink of the dimensions specified in the upper right of the graph is installed.

Note2: The graph shows typical values of 3-phase 200 VAC.

SG
SHA25A (Motor input voltage 100 V)

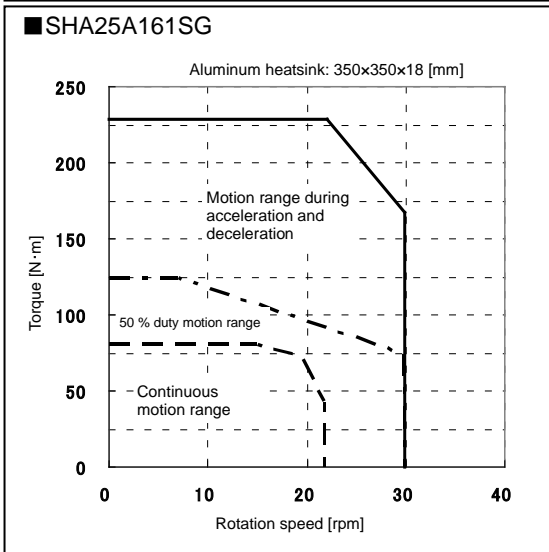
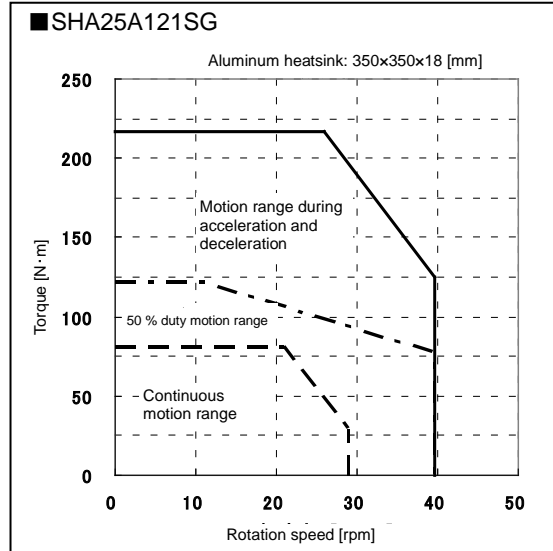
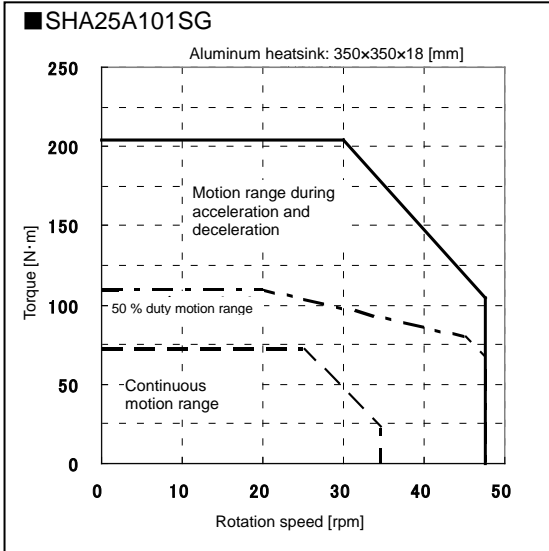
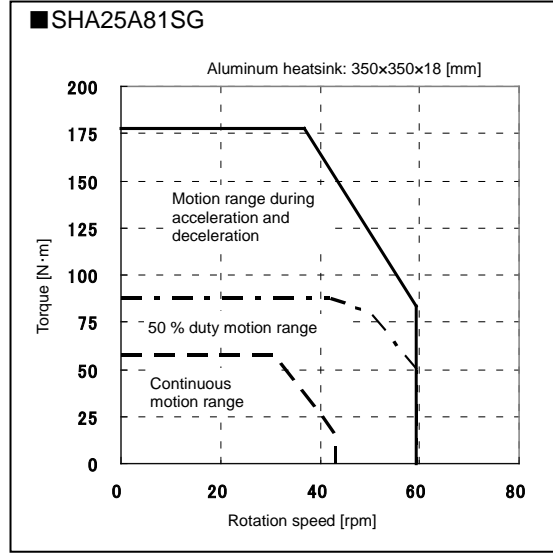
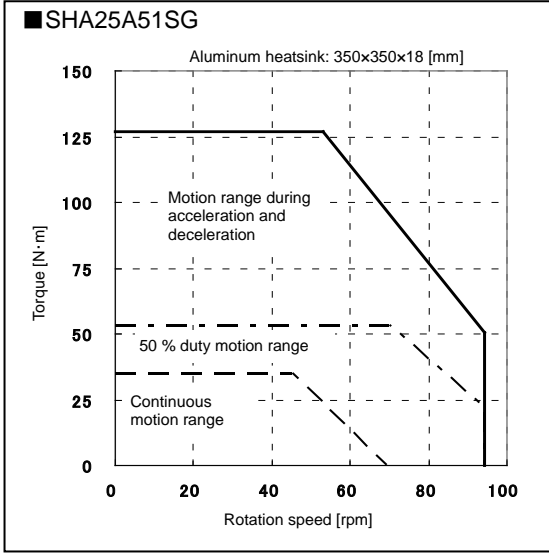

Note1: Values in the continuous motion range and 50 % duty range are measured on the condition where an aluminum heatsink of the dimensions specified in the upper right of the graph is installed.

Note2: The graph shows typical values of single phase 100 VAC.

SG/HP
SHA25A (Motor input voltage 200 V)

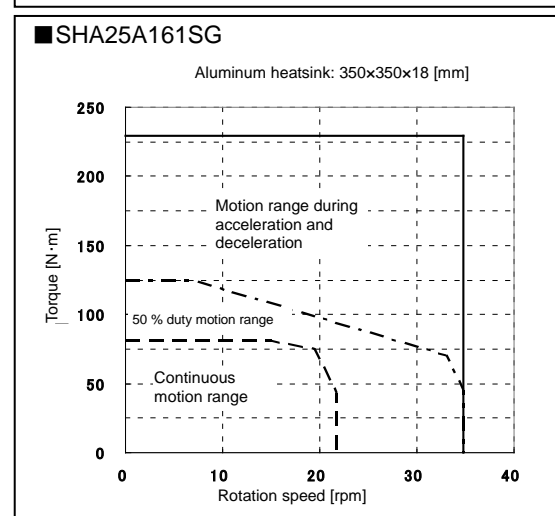
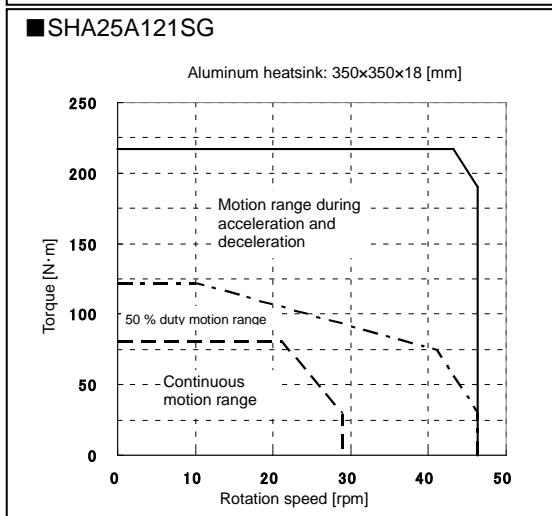
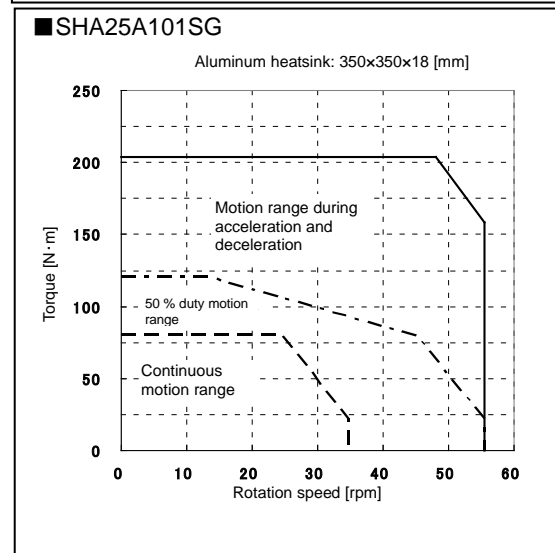
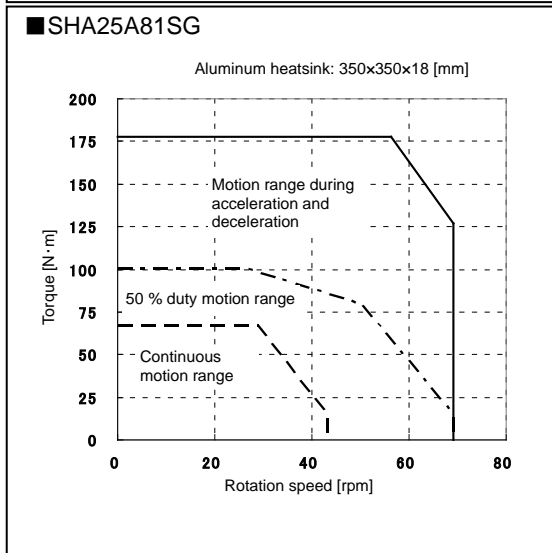
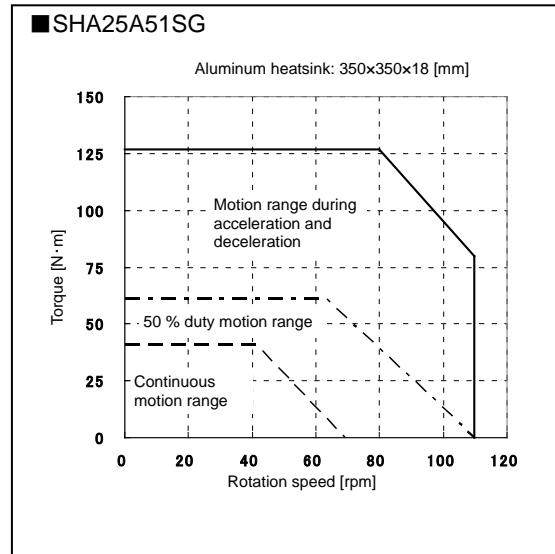
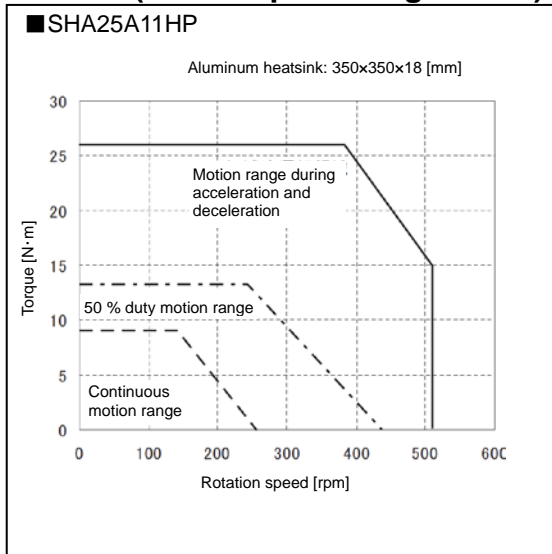

Note1: Values in the continuous motion range and 50 % duty range are measured on the condition where an aluminum heatsink of the dimensions specified in the upper right of the graph is installed.

Note2: The graph shows typical values of 3-phase 200 VAC.

**SG/HP
SHA32A**

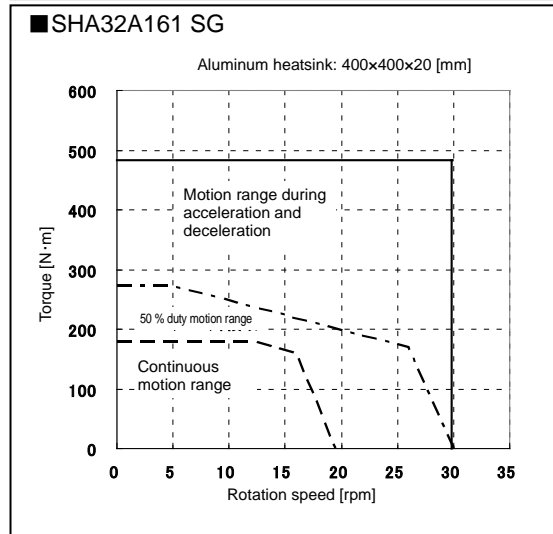
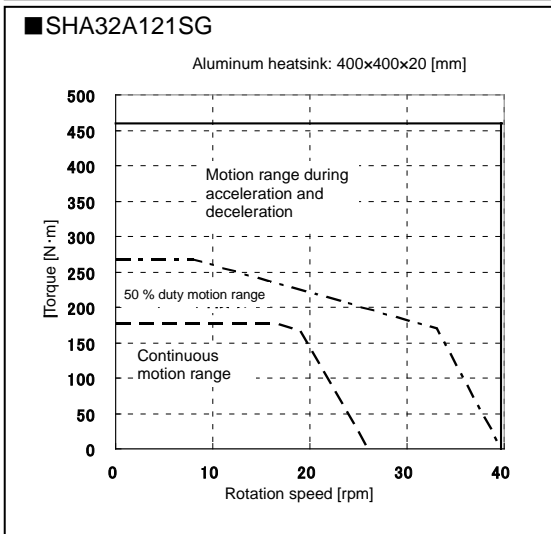
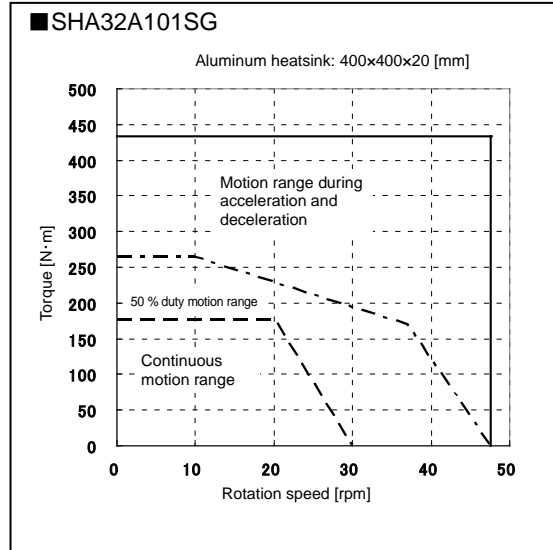
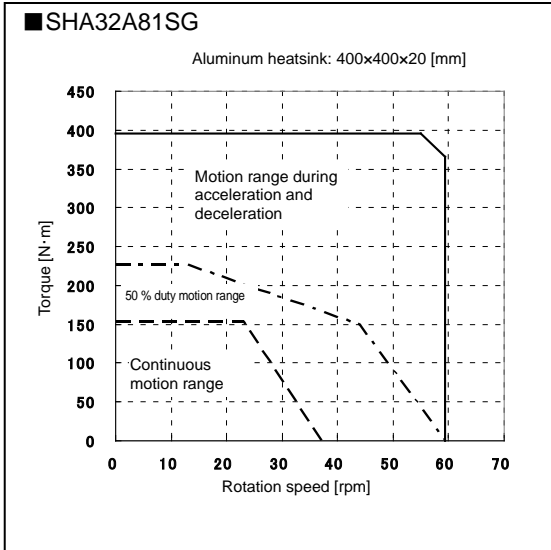
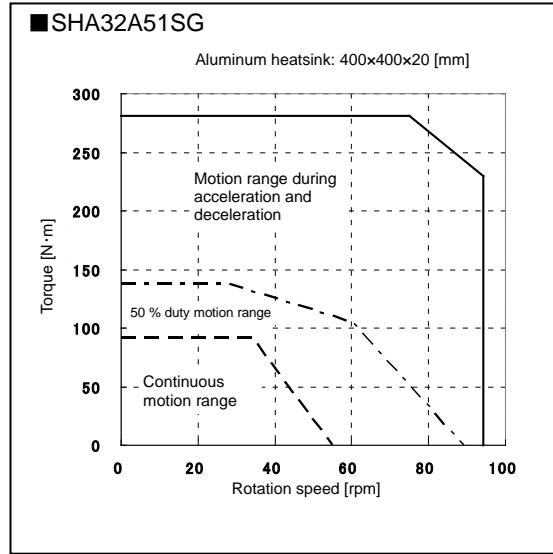
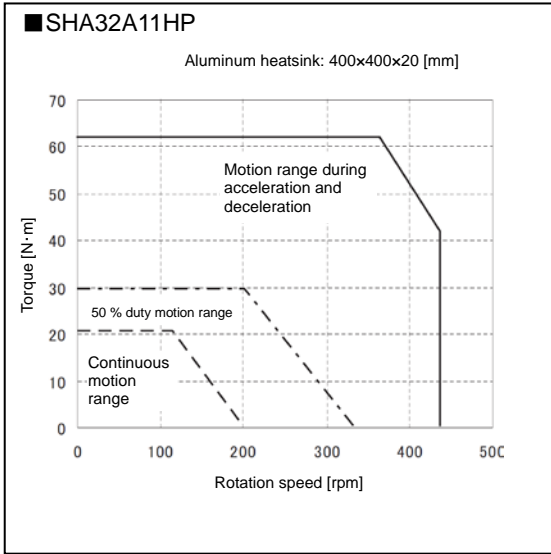

Note1: Values in the continuous motion range and 50 % duty range are measured on the condition where an aluminum heatsink of the dimensions specified in the upper right of the graph is installed.
 Note2: The graph shows typical values of 3-phase 200 VAC.

**SG
SHA40A**

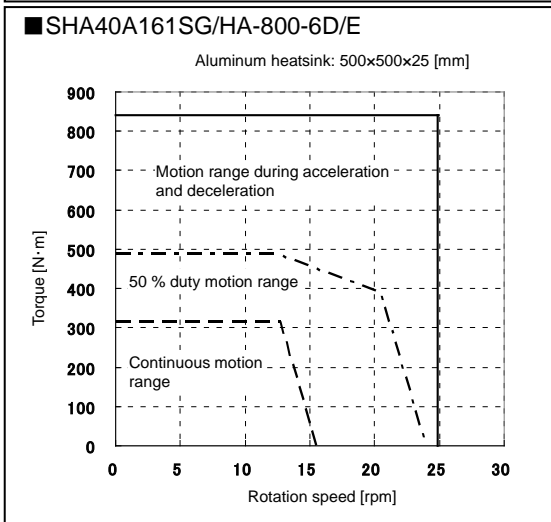
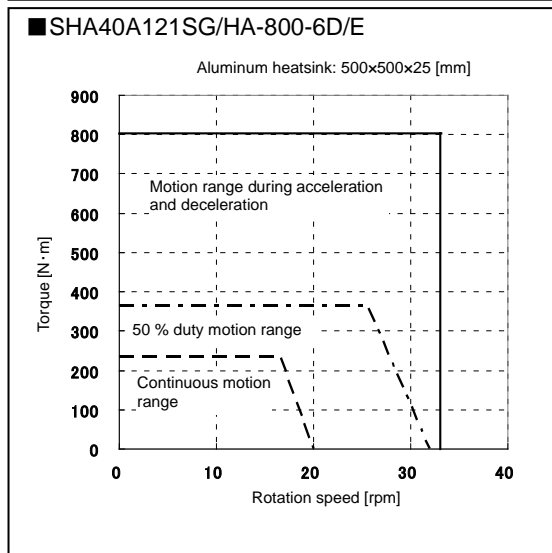
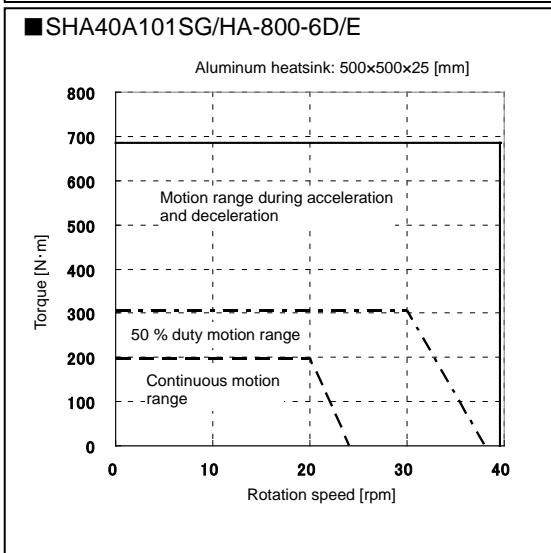
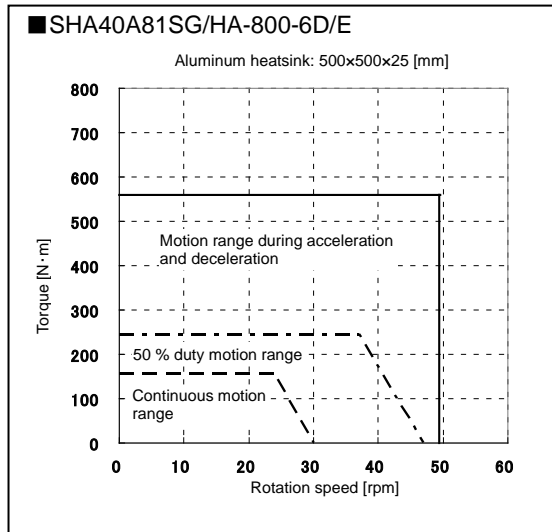
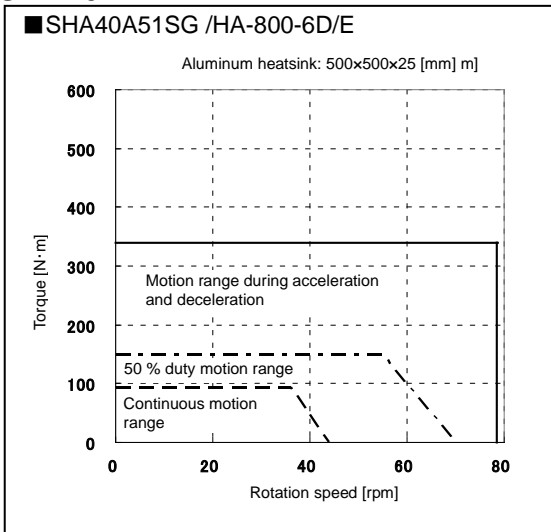

Note1: Values in the continuous motion range and 50 % duty range are measured on the condition where an aluminum heatsink of the dimensions specified in the upper right of the graph is installed.
 Note2: The graph shows typical values of 3-phase 200 VAC.

SG SHA40A

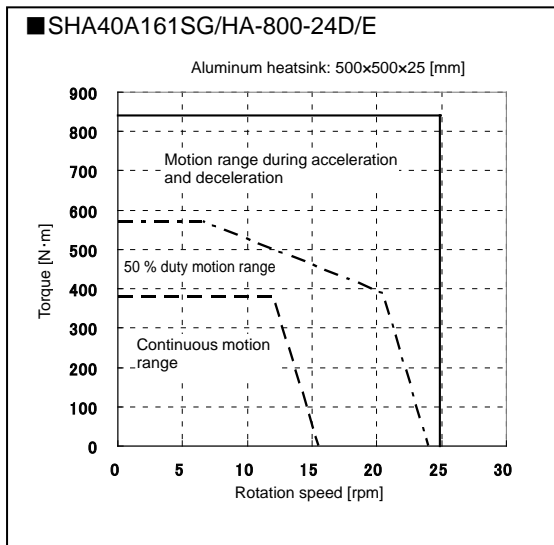
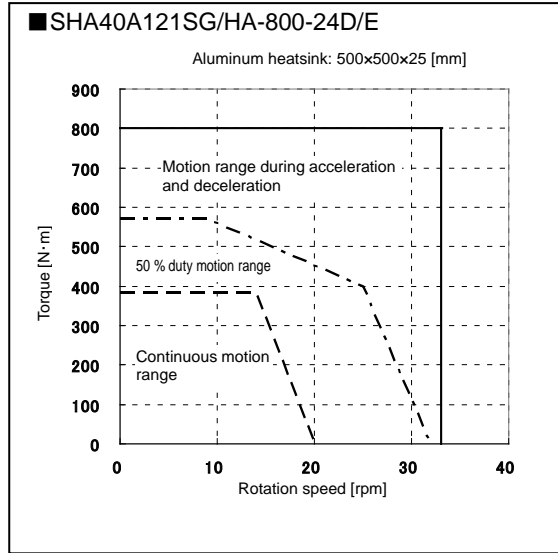
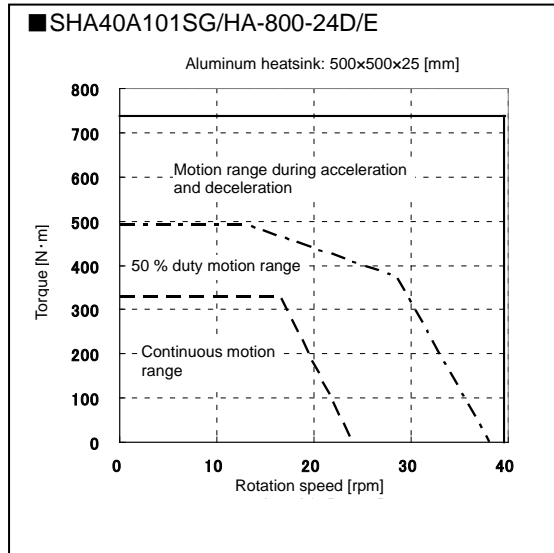
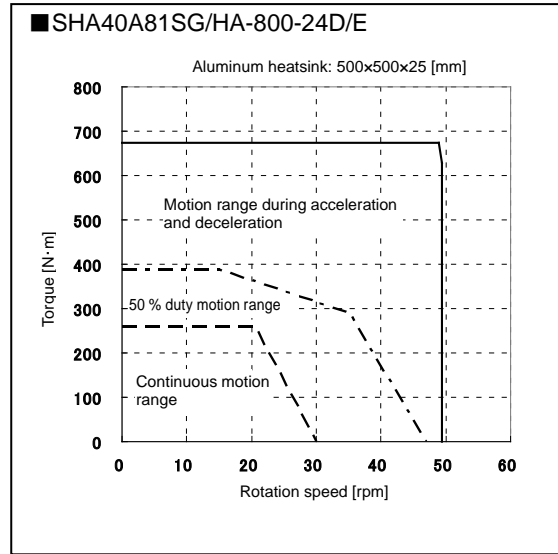
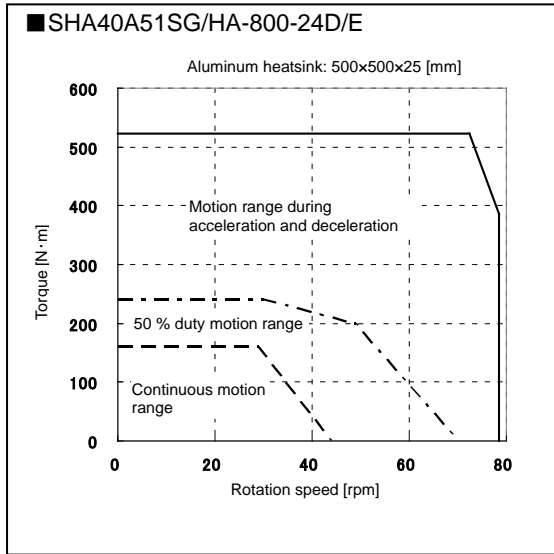

Note1: Values in the continuous motion range and 50 % duty range are measured on the condition where an aluminum heatsink of the dimensions specified in the upper right of the graph is installed.

Note2: The graph shows typical values of 3-phase 200 VAC.

**SG
SHA45A**

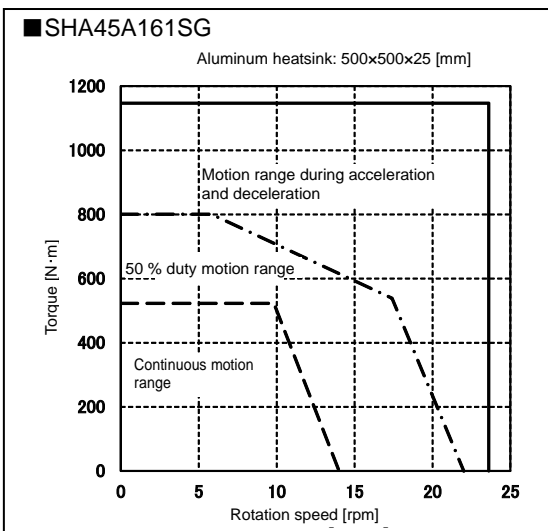
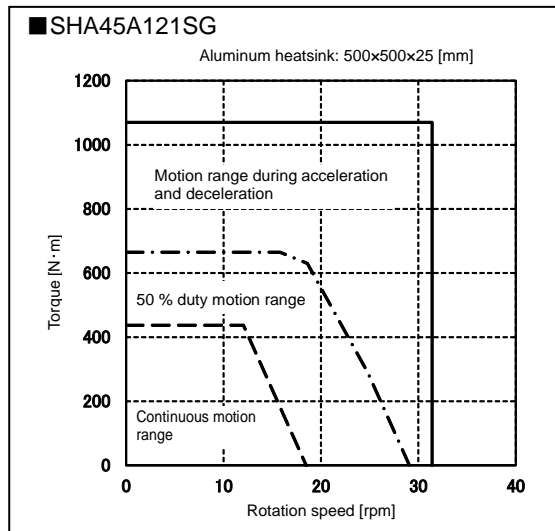
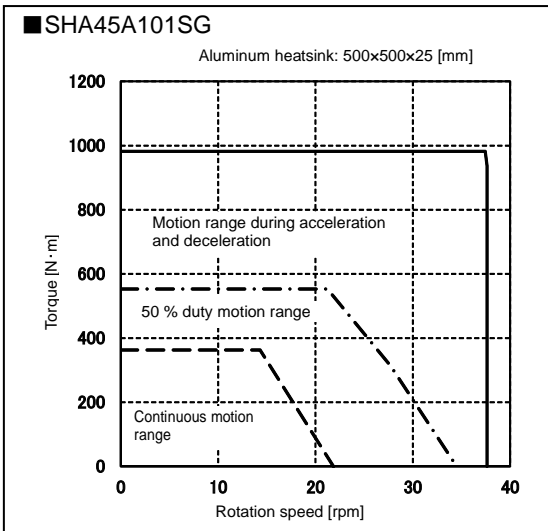
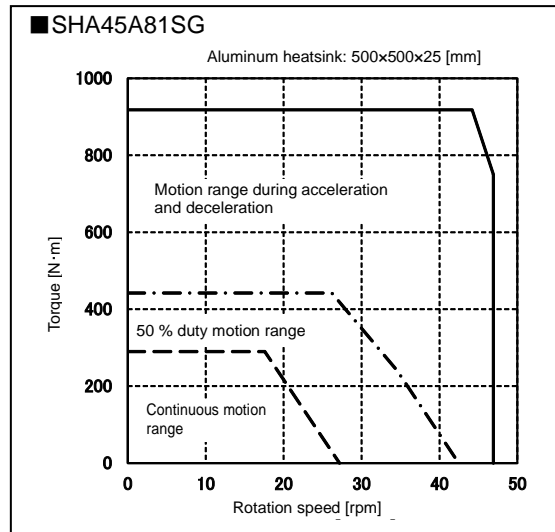
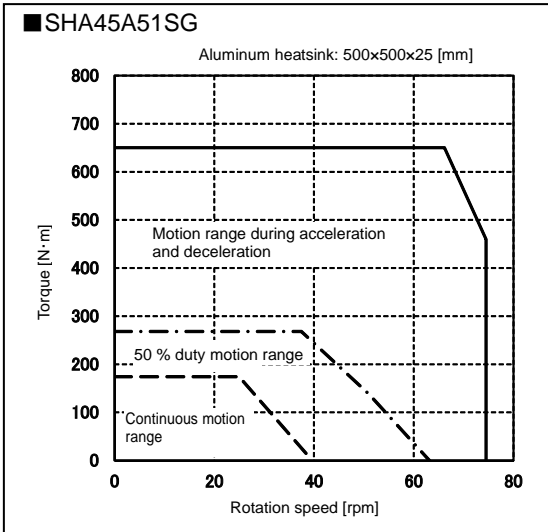

Note1: Values in the continuous motion range and 50 % duty range are measured on the condition where an aluminum heatsink of the dimensions specified in the upper right of the graph is installed.

Note2: The graph shows typical values of 3-phase 200 VAC.

SG
SHA58A

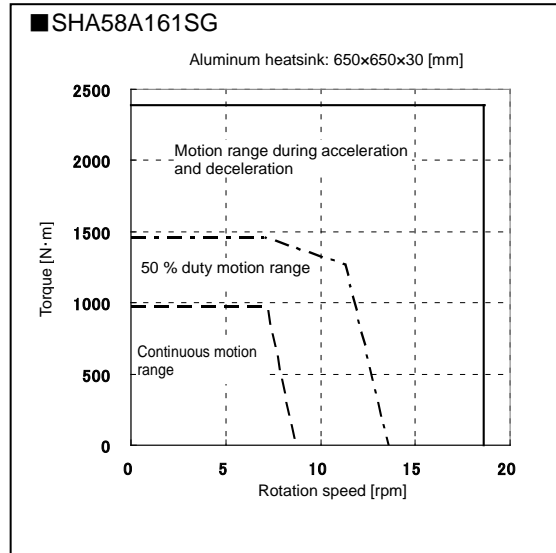
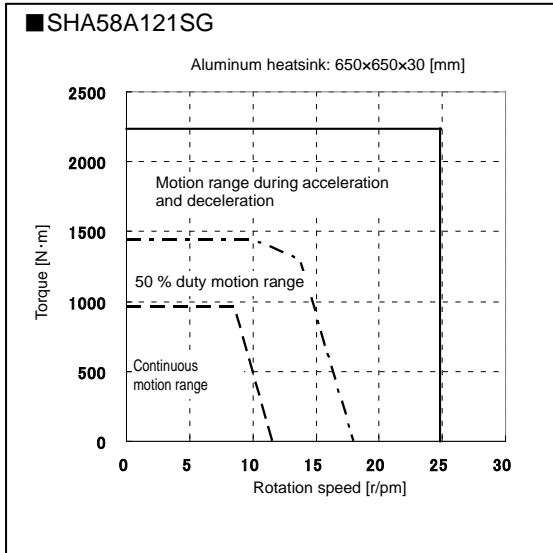
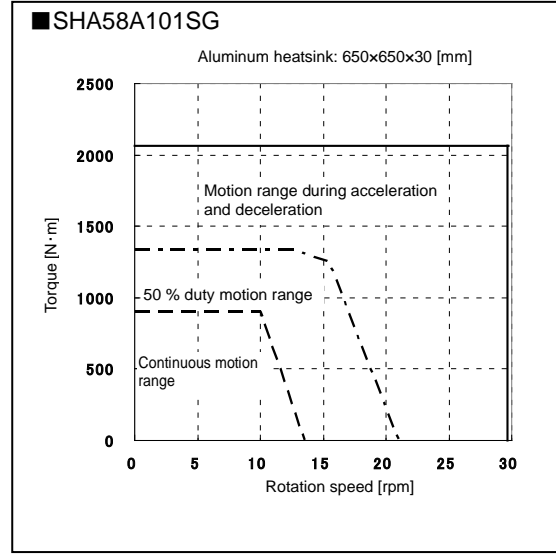
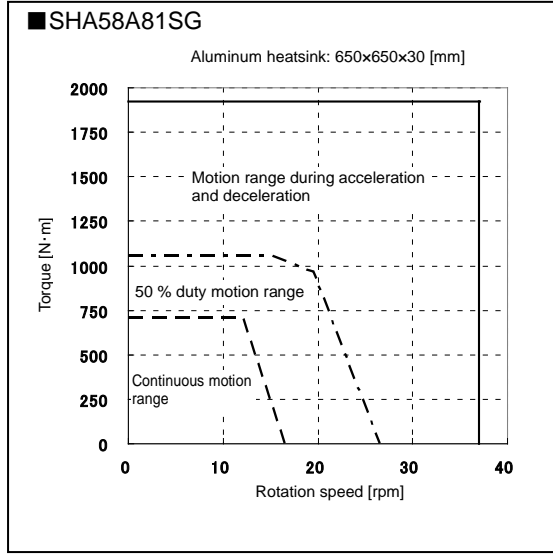

Note1: Values in the continuous motion range and 50 % duty range are measured on the condition where an aluminum heatsink of the dimensions specified in the upper right of the graph is installed.

Note2: The graph shows typical values of 3-phase 200 VAC.

**SG
SHA65A**

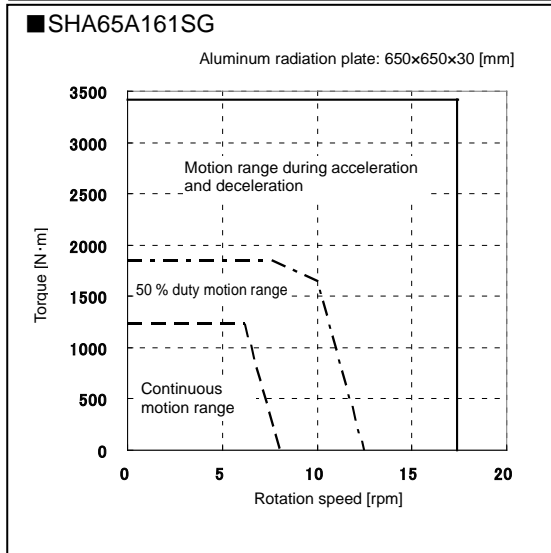
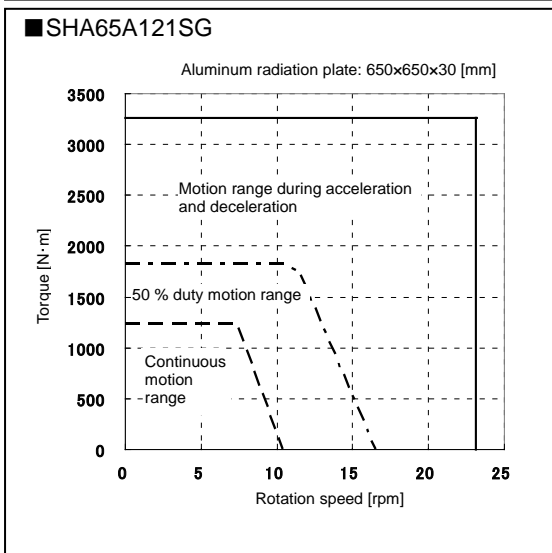
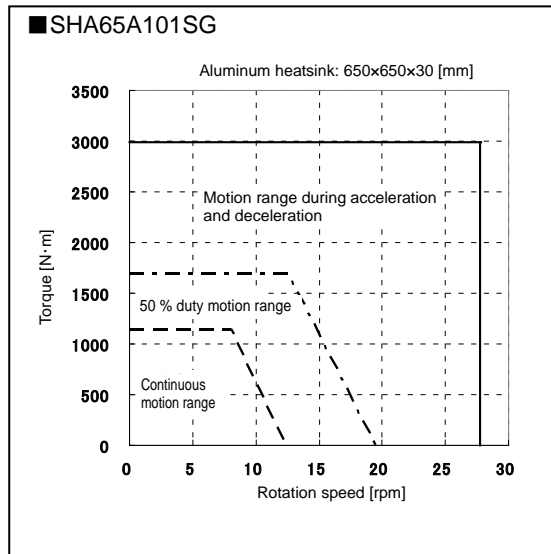
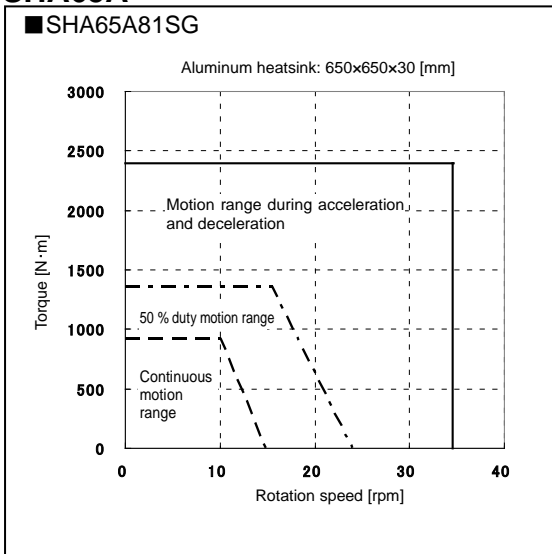

Note1: Values in the continuous motion range and 50 % duty range are measured on the condition where an aluminum radiation plate of the dimensions specified in the upper right of the graph is installed.
 Note2: The graph shows typical values of 3-phase 200 VAC.

CG
SHA20A

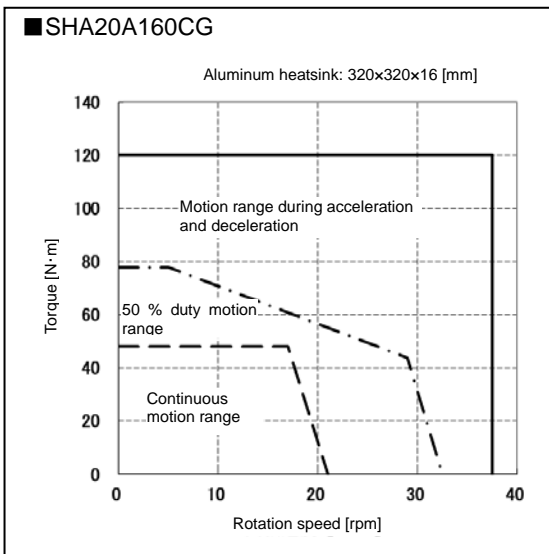
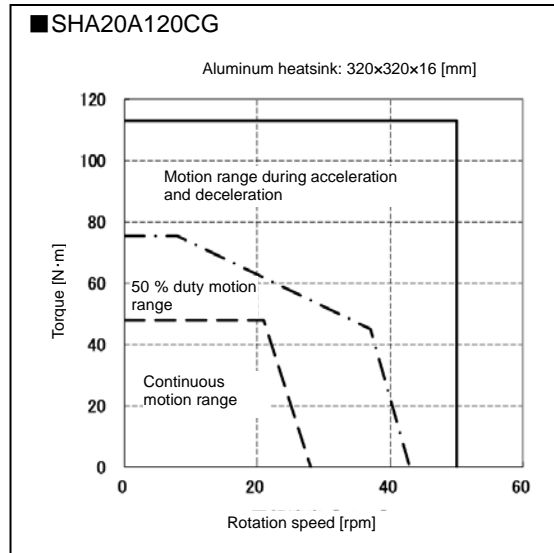
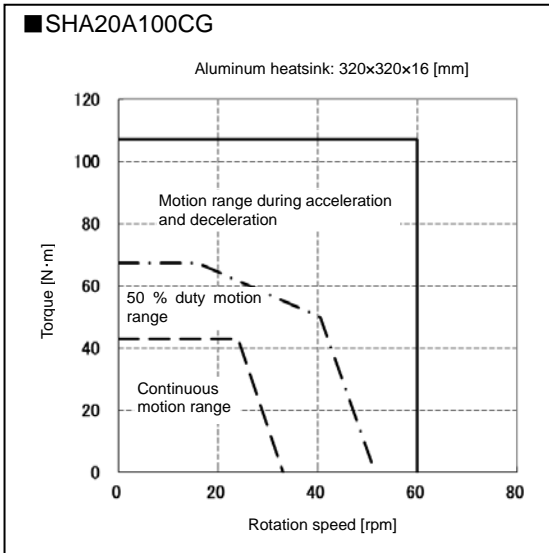
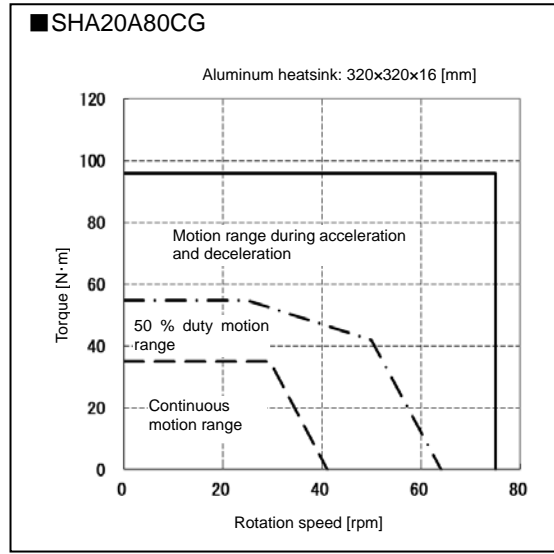
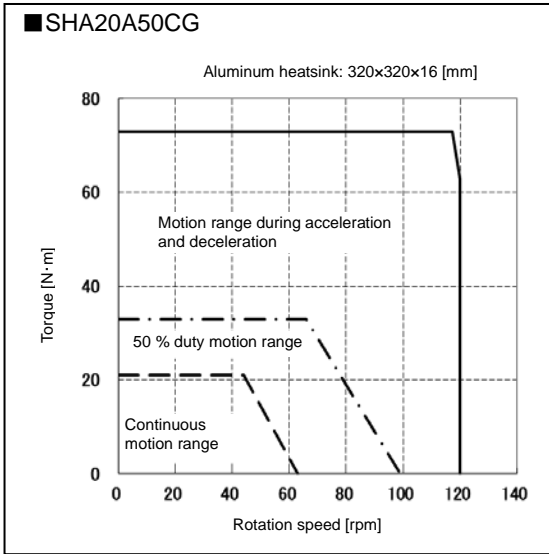

Note1: Values in the continuous motion range and 50 % duty range are measured on the condition where an aluminum heatsink of the dimensions specified in the upper right of the graph is installed.

Note2: The graph shows typical values of 3-phase 200 VAC.

CG

SHA25A (Motor input voltage 100 V)

1
Outlines

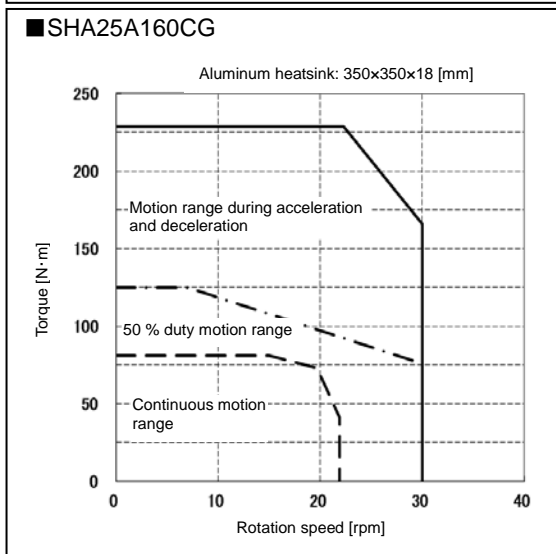
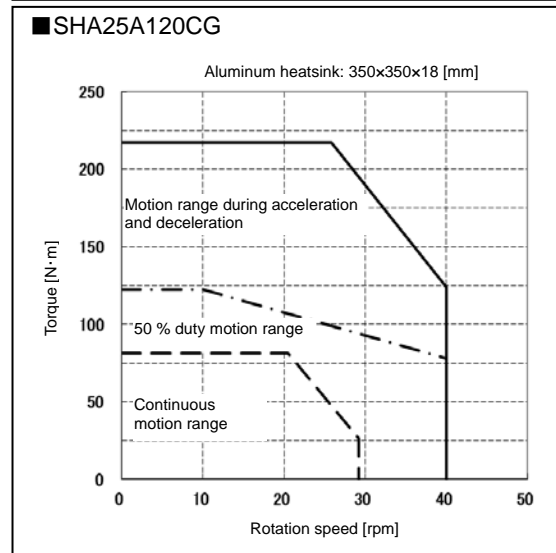
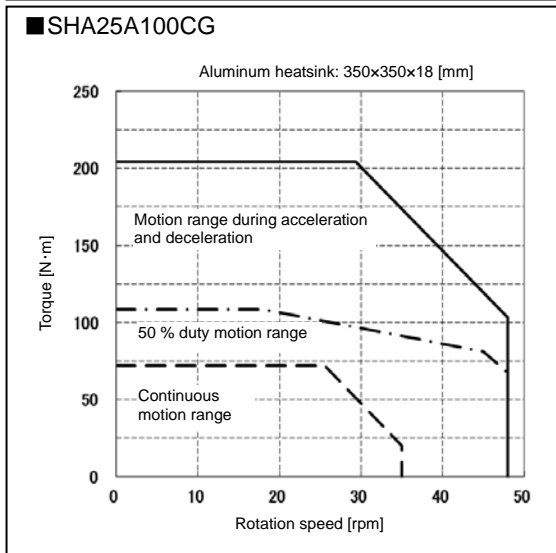
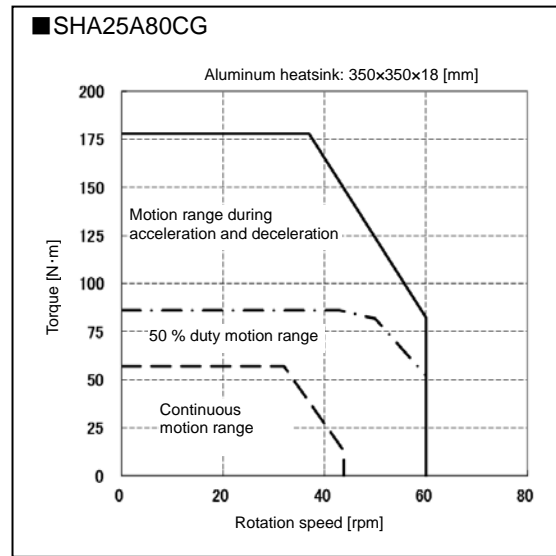
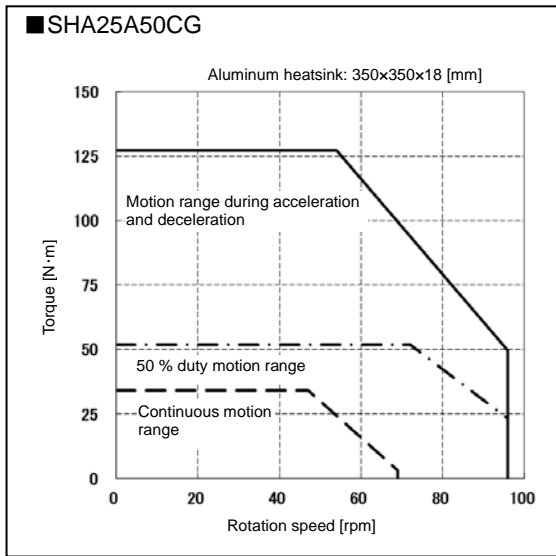

Note1: Values in the continuous motion range and 50 % duty range are measured on the condition where an aluminum radiation plate of the dimensions specified in the upper right of the graph is installed.

Note2: The graph shows typical values of single phase 100 VAC.

CG
SHA25A (Motor input voltage 200 V)

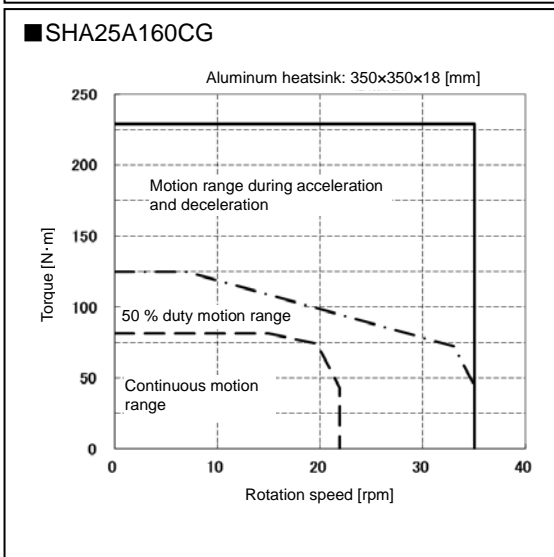
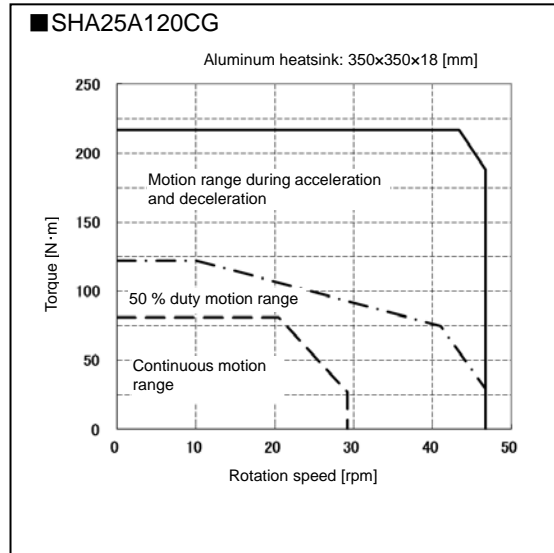
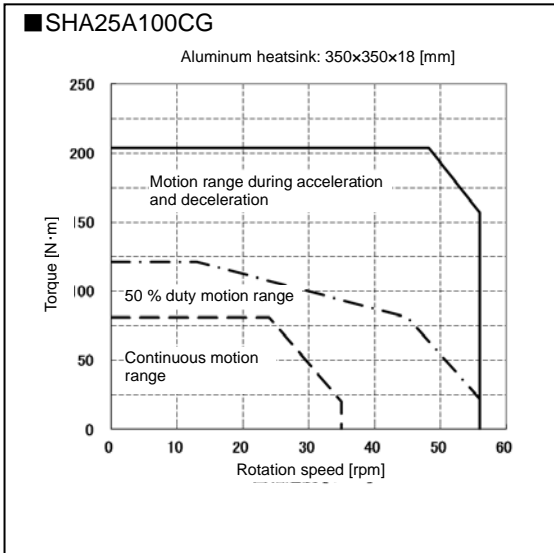
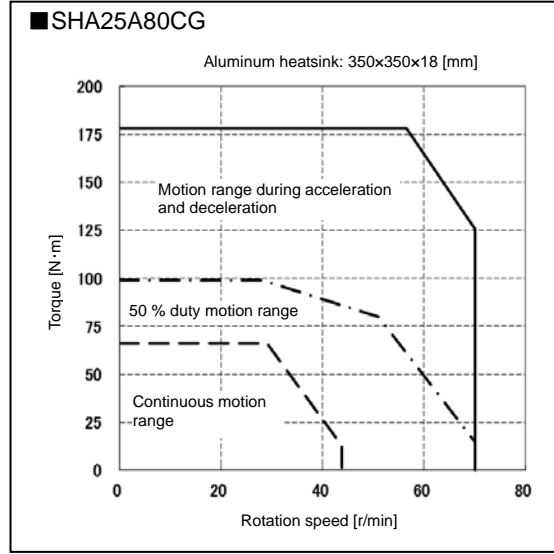
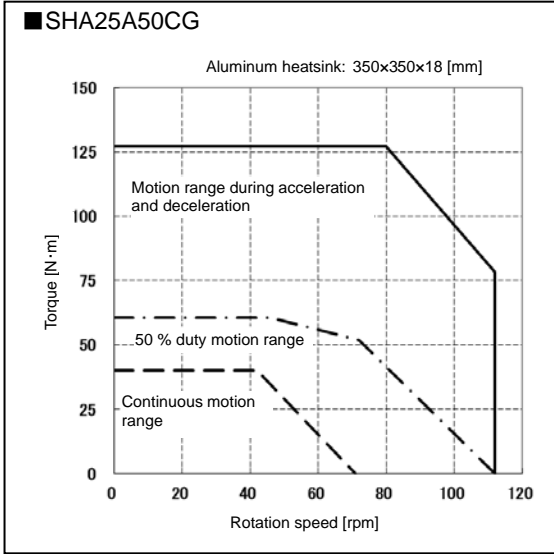

Note1: Values in the continuous motion range and 50 % duty range are measured on the condition where an aluminum heatsink of the dimensions specified in the upper right of the graph is installed.

Note2: The graph shows typical values of 3-phase 200 VAC.

CG
SHA32A

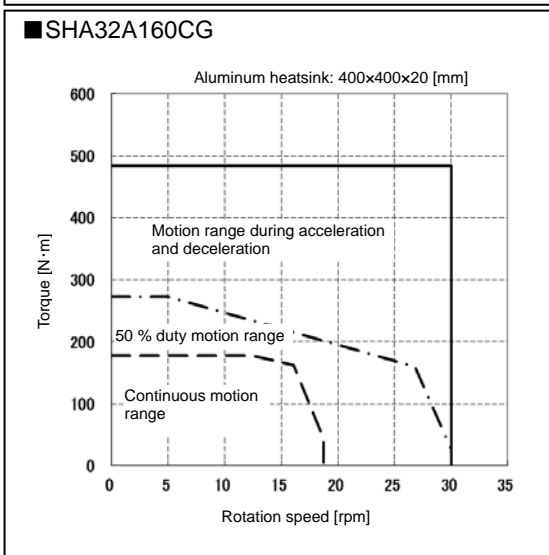
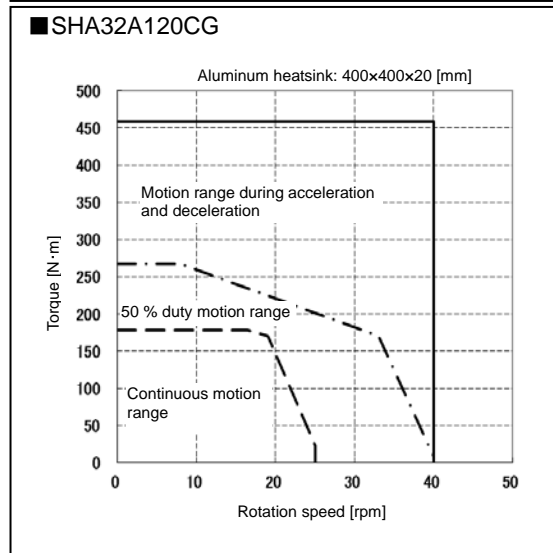
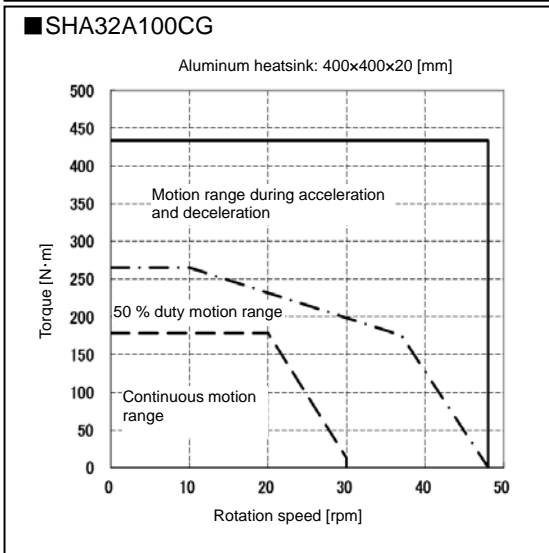
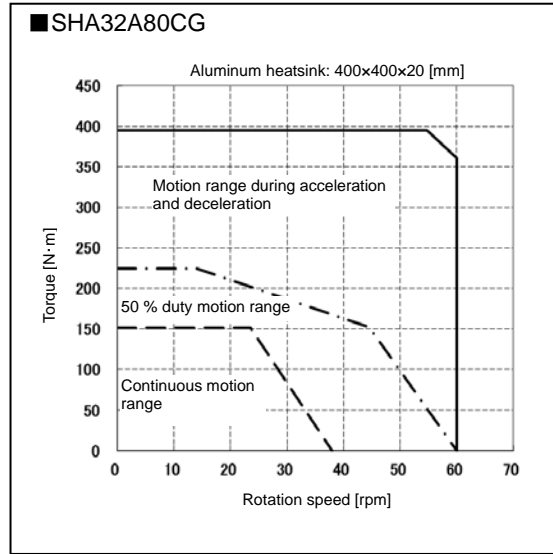
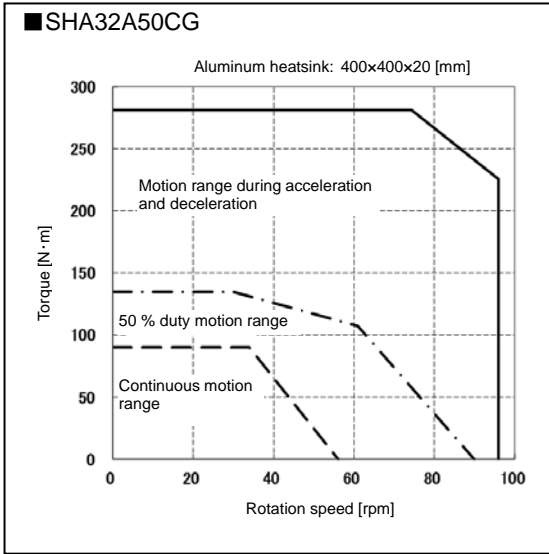

Note1: Values in the continuous motion range and 50 % duty range are measured on the condition where an aluminum heatsink of the dimensions specified in the upper right of the graph is installed.

Note2: The graph shows typical values of 3-phase 200 VAC.

**CG
SHA40A**

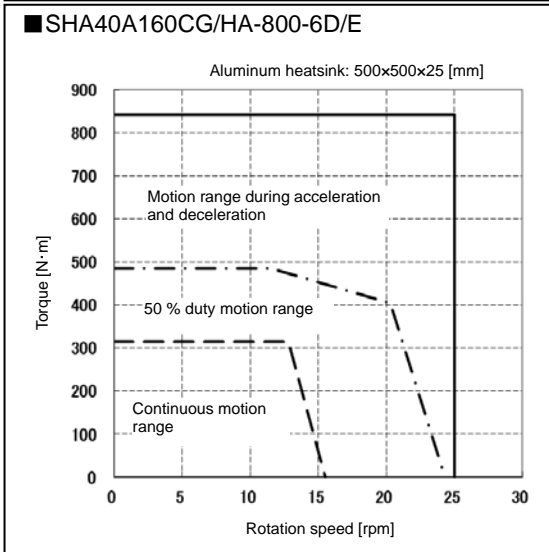
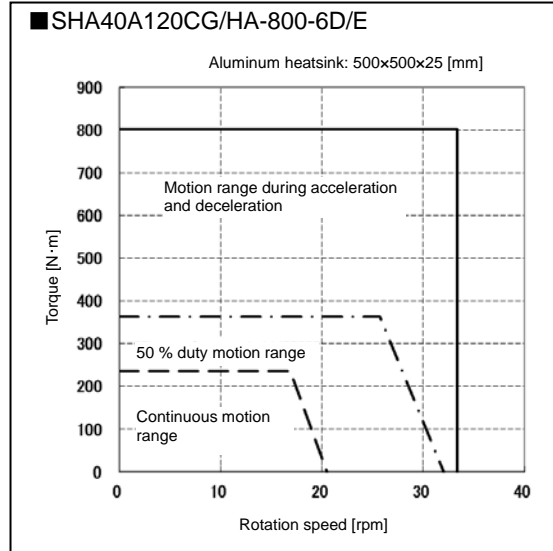
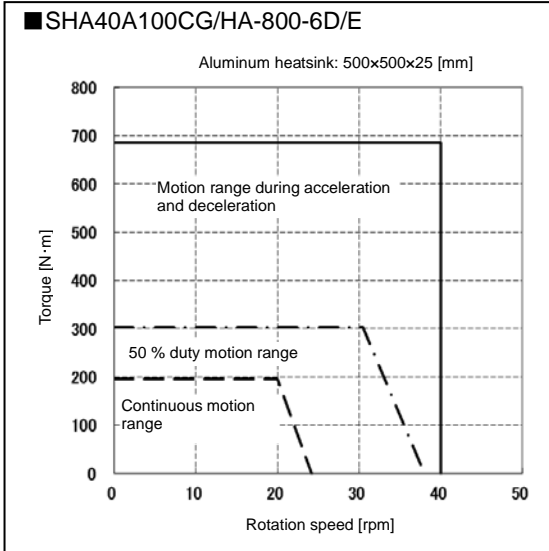
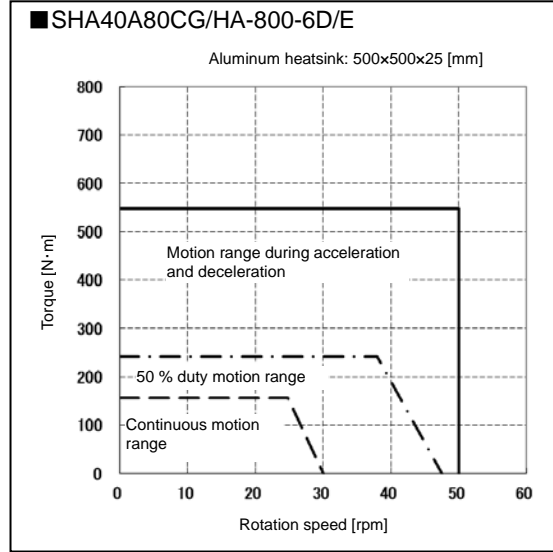
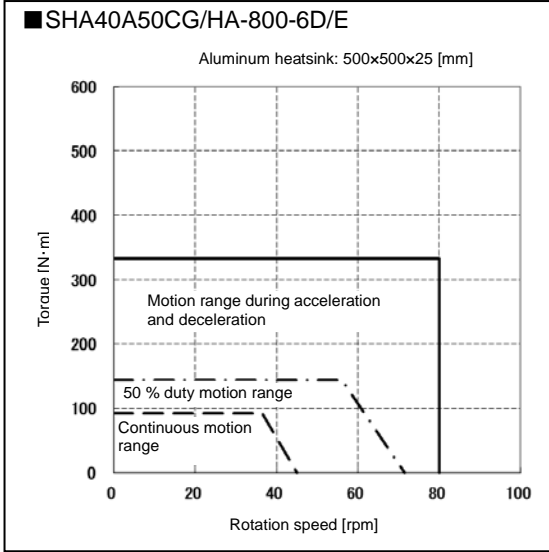

Note1: Values in the continuous motion range and 50 % duty range are measured on the condition where an aluminum heatsink of the dimensions specified in the upper right of the graph is installed.

Note2: The graph shows typical values of 3-phase 200 VAC.

**CG
SHA40A**

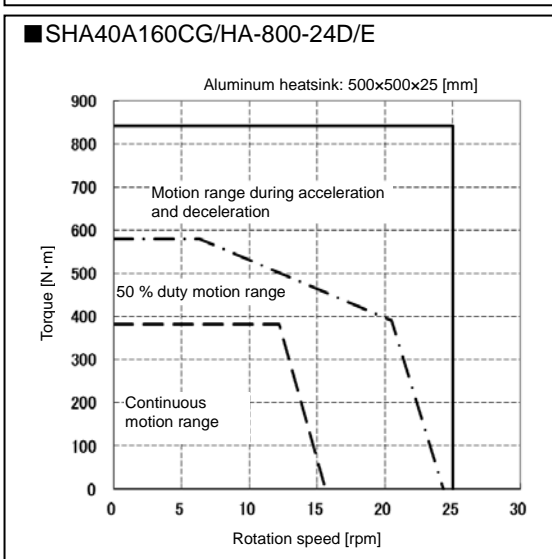
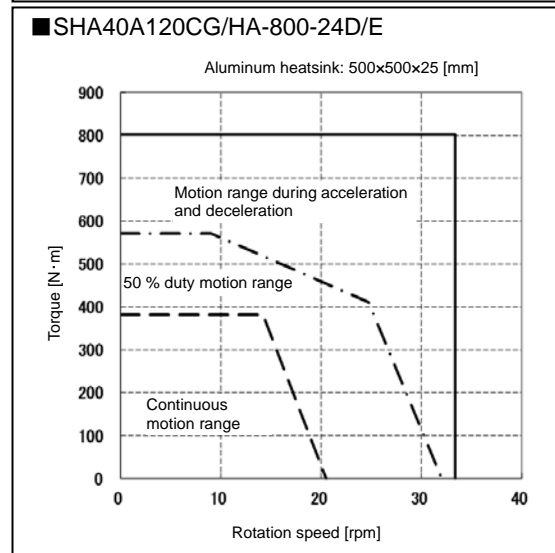
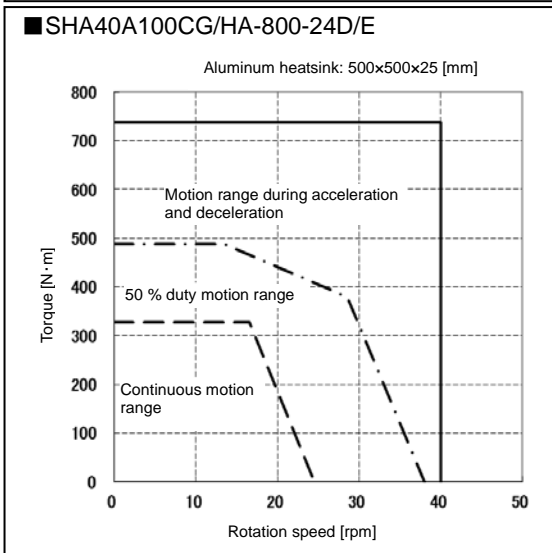
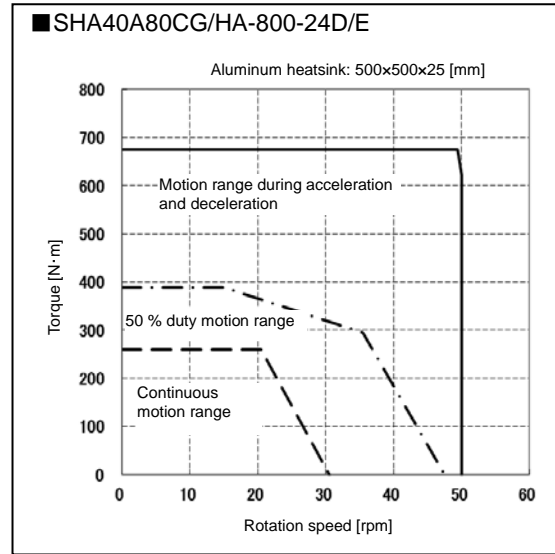
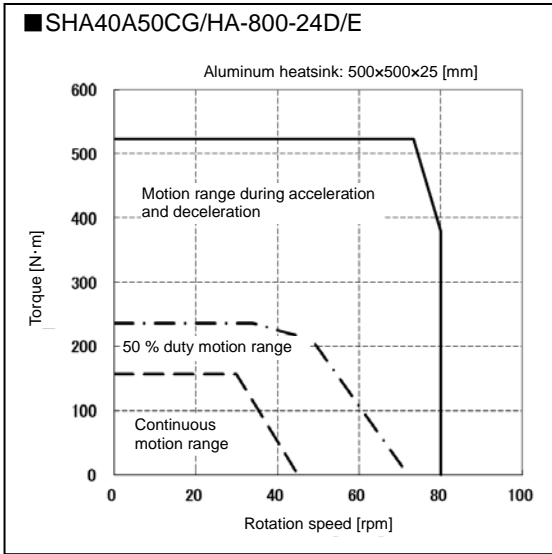

Note1: Values in the continuous motion range and 50 % duty range are measured on the condition where an aluminum heatsink of the dimensions specified in the upper right of the graph is installed.
 Note2: The graph shows typical values of 3-phase 200 VAC.

1-15 Cable specifications

The following tables show specifications of the motor and encoder cables of the SHA series actuators.

Motor cable specifications

- Sizes 20, 25, 32, 40, 45

Pin number	Color	Name	
		Without brake	With brake
1	Red	Motor phase-U	Motor phase-U
2	White	Motor phase-V	Motor phase-V
3	Black	Motor phase-W	Motor phase-W
4	Green/yellow	PE	PE
5	Blue	No connection	Brake
6	Yellow	No connection	Brake

- Connector pin layout



Connector model: 350715-1
Pin model:

	Model Nos 20, 25	Model Nos 32, 40
Motor UVW	350690-1	350547-1
Brake	350690-1	350690-1
Motor PE	350669-1	350669-1

TE Connectivity (by AMP)

- Sizes 58, 65

Pin number	Name		Color (Extension cables)
	Without brake	With brake	
A	No connection	Brake	Blue
B	No connection	Brake	Yellow
C	No connection	No connection	—
D	Motor phase-U	Motor phase-U	Red
E	Motor phase-V	Motor phase-V	White
F	Motor phase-W	Motor phase-W	Black
G	PE	PE	Green/yellow
H	PE	PE	—
I	No connection	No connection	—

- Connector pin layout

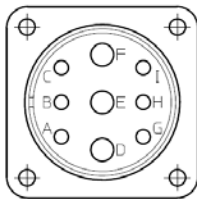

Connector model: CE05-2A24-11PGHS-D (by DDK)

Encoder cable specifications

- Sizes 20, 25, 32, 40, 45

Pin number	Color	Signal name	Remarks
1A	Red	Vcc	Power supply input +5 V
1B	Black	GND (Vcc)	Power supply input 0 V (GND)
2A	Yellow	SD +	Serial signal differential output (+)
2B	Blue	SD -	Serial signal differential output (-)
3A	—	No connection	
3B	Shield	FG	
4A	Orange	Vbat	Battery +
4B	Gray	GND (bat)	Battery - (GND)

- Connector pin layout

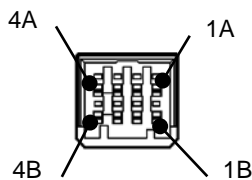

Connector model: 1-1903130-4
 Pin model: 1903111-2, 1903116-2 or 1903117-2
 TE Connectivity (by AMP)

- Sizes 58, 65

Pin number	Signal name	Remarks
1	Vbat	Battery +
2	GND (bat)	Battery - (GND)
3	No connection	
4	Vcc	Power supply input +5 V
5	GND (Vcc)	Power supply input 0 V (GND)
6	No connection	
7	No connection	
8	SD +	Serial signal differential output (+)
9	SD -	Serial signal differential output (-)
10	FG	

- Connector pin layout

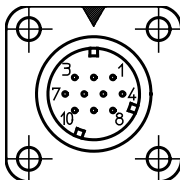

Connector model: CM10-R10P(D3)-01 (by DDK)

Chapter 2

Selection guidelines

This chapter explains how to select a proper SHA series actuator.

2-1	SHA series selection.....	2-1
2-2	Change in load inertia moment	2-5
2-3	Verifying and examining load weights	2-6
2-4	Examining operating status	2-10

2-1 SHA series selection

2

Selection guidelines

Allowable load moment of inertia

To achieve high accuracy and performance, select an SHA series actuator where the allowable load inertia moment specified for the applicable size. is not exceeded.

Note that the allowable values in the table below should be referenced if you wish to shorten the transient vibration period during positioning or operate the actuator at a constant speed in a stable manner.

The operation is possible with the allowable value exceeded if the actuator is accelerated/decelerated gradually, commands given from the host to the servo driver are adjusted, or the servo driver's vibration suppression function is used.

Refer to [A-2 Calculating inertia moment] (P5-3) for the calculation of inertia moment.

SG type

[kg·m²] Allowable load inertia moment

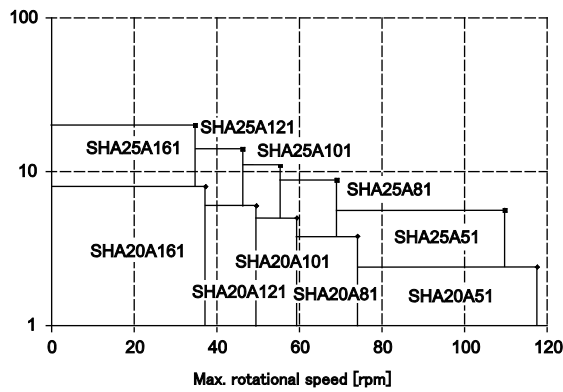

[kg·m²] Allowable load inertia moment

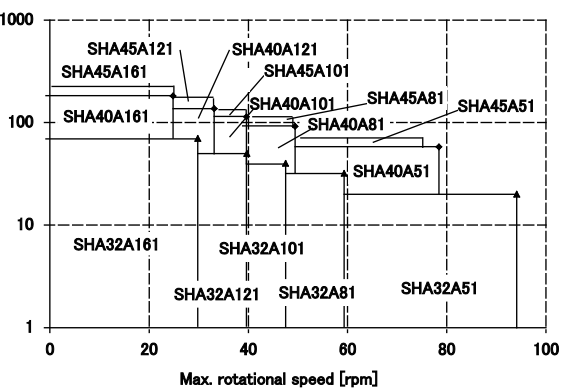

[kg·m²] Allowable load inertia moment

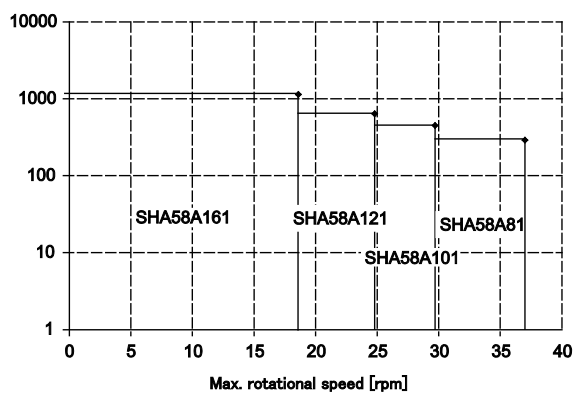

[kg·m²] Allowable load inertia moment

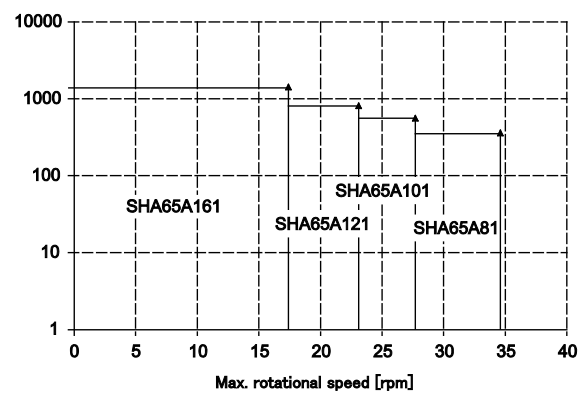

CG type

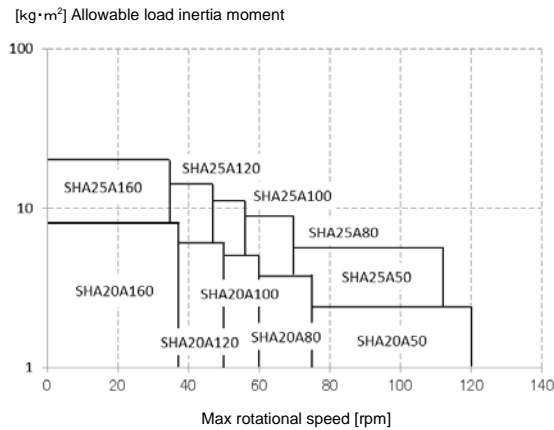
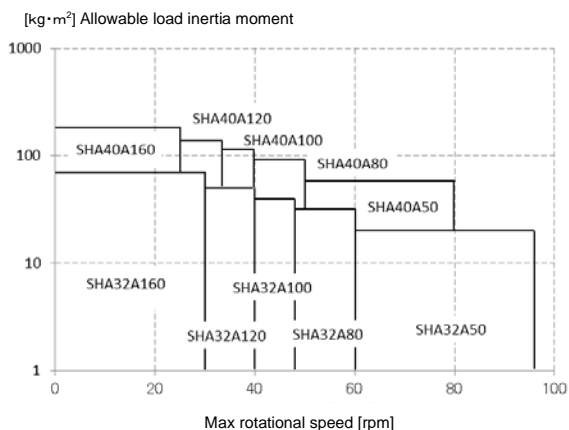

When temporarily selecting an actuator, make certain that the inertia moment and max. rotational speed do not exceed the allowable values shown in the table on the following page.

When a load generating a large moment of inertia is operated frequently, a greater regenerative energy will be produced during braking. If the produced regenerative energy exceeds the absorption capacity of the built-in regenerative resistor of the servo driver, an additional regenerative resistor must be connected externally to the driver. For details, refer to the manual of your drive.

SG/HP type

Actuator model		SHA20A				
		51	81	101	121	161
Reduction ratio		1:51	1:81	1:101	1:121	1:161
Max. rotational speed	rpm	117.6	74.1	59.4	49.6	37.3
Actuator inertia moment (without brake)	kg·m ²	0.23	0.58	0.91	1.3	2.3
	kgf·cm·s ²	2.4	6.0	9.3	13	24
Actuator inertia moment (with brake)	kg·m ²	0.26	0.65	1.0	1.4	2.6
	kgf·cm·s ²	2.6	6.6	10	15	26
Allowable load inertia moment	kg·m ²	2.4	3.8	4.8	5.8	7.7
	kgf·cm·s ²	25	39	49	59	78

Actuator model		SHA25A					
		11	51	81	101	121	161
Reduction ratio		1:11	1:51	1:81	1:101	1:121	1:161
Max. rotational speed	rpm	509.1	109.8	69.1	55.4	46.3	34.8
Actuator inertia moment (without brake)	kg·m ²	0.029	0.56	1.4	2.2	3.2	5.6
	kgf·cm·s ²	0.30	5.7	14	22	32	57
Actuator inertia moment (with brake)	kg·m ²	0.034	0.66	1.7	2.6	3.7	6.6
	kgf·cm·s ²	0.35	6.7	17	26	38	67
Allowable load inertia moment	kg·m ²	0.32	5.6	8.8	11	14	20
	kgf·cm·s ²	3.3	57	90	112	144	201

Actuator model		SHA32A					
		11	51	81	101	121	161
Reduction ratio		1:11	1:51	1:81	1:101	1:121	1:161
Max. rotational speed	rpm	436.4	94.1	59.3	47.5	39.7	29.8
Actuator inertia moment (without brake)	kg·m ²	0.091	2.0	5.1	8.0	11	20
	kgf·cm·s ²	0.93	21	52	81	117	207
Actuator inertia moment (with brake)	kg·m ²	0.11	2.3	5.9	9.2	13	23
	kgf·cm·s ²	1.1	24	60	94	135	238
Allowable load inertia moment	kg·m ²	0.99	20	32	40	50	70
	kgf·cm·s ²	10	200	320	400	510	710

Actuator model		SHA40A					SHA45A				
		51	81	101	121	161	51	81	101	121	161
Reduction ratio		1:51	1:81	1:101	1:121	1:161	1:51	1:81	1:101	1:121	1:161
Max. rotational speed	r/min	78.4	49.4	39.6	33.1	24.8	74.5	46.9	37.6	31.4	23.6
Actuator inertia moment (without brake)	kg·m ²	5.0	13	20	28	50	6.8	17	27	38	68
	kgf·cm·s ²	51	130	202	290	513	69	175	272	390	690
Actuator inertia moment (with brake)	kg·m ²	6.1	15	24	34	61	7.9	20	31	45	79
	kgf·cm·s ²	62	157	244	350	619	81	204	316	454	804
Allowable load inertia moment	kg·m ²	58	92	114	137	182	75	119	148	178	236
	kgf·cm·s ²	590	930	1170	1400	1860	766	1215	1514	1814	2413

Actuator model		SHA58A				SHA65A			
		81	101	121	161	81	101	121	161
Reduction ratio		1:81	1:101	1:121	1:161	1:81	1:101	1:121	1:161
Max. rotational speed	rpm	37.0	29.7	24.8	18.6	34.6	27.7	23.1	17.4
Actuator inertia moment (without brake)	kg·m ²	96	149	214	379	110	171	245	433
	kgf·cm·s ²	980	1520	2180	3870	1120	1740	2500	4420
Actuator inertia moment (with brake)	kg·m ²	106	165	237	420	120	187	268	475
	kgf·cm·s ²	1090	1690	2420	4290	1230	1910	2740	4850
Allowable load inertia moment	kg·m ²	290	450	640	1140	360	560	810	1420
	kgf·cm·s ²	2900	4600	6500	11600	3700	5700	8200	14500

CG type

Actuator model		SHA20A				
		50	80	100	120	160
Reduction ratio		1:50	1:80	1:100	1:120	1:160
Max. rotational speed	rpm	120	75	60	50	37.5
Actuator inertia moment (without brake)	kg·m ²	0.21	0.53	0.82	1.2	2.1
	kgf·cm·s ²	2.1	5.4	8.0	12	22
Actuator inertia moment (with brake)	kg·m ²	0.23	0.60	0.94	1.3	2.4
	kgf·cm·s ²	2.4	6.1	9.6	14	24
Allowable load inertia moment	kg·m ²	2.4	3.8	4.8	5.8	7.7
	kgf·cm·s ²	25	39	49	59	78

Actuator model		SHA25A					SHA32A				
		50	80	100	120	160	50	80	100	120	160
Reduction ratio		1:50	1:80	1:100	1:120	1:160	1:50	1:80	1:100	1:120	1:160
Max. rotational speed	rpm	112	70	56	46.7	35	96	60	48	40	30
Actuator inertia moment (without brake)	kg·m ²	0.50	1.3	2.0	2.9	5.1	1.7	4.3	6.7	9.7	17
	kgf·cm·s ²	5.1	13	20	29	52	17	44	68	99	175
Actuator inertia moment (with brake)	kg·m ²	0.60	1.5	2.4	3.4	6.1	2.0	5.1	7.9	11	20
	kgf·cm·s ²	6.1	16	24	35	62	20	52	81	116	207
Allowable load inertia moment	kg·m ²	5.6	8.8	11	14	20	20	32	40	50	70
	kgf·cm·s ²	57	90	112	144	201	200	320	400	510	710

Actuator model		SHA40A				
		50	80	100	120	160
Reduction ratio		1:50	1:80	1:100	1:120	1:160
Max. rotational speed	rpm	80	50	40	33.3	25
Actuator inertia moment (without brake)	kg·m ²	4.8	12	19	27	49
	kgf·cm·s ²	49	124	194	280	497
Actuator inertia moment (with brake)	kg·m ²	5.8	15	23	33	59
	kgf·cm·s ²	59	150	235	338	601
Allowable load inertia moment	kg·m ²	58	92	114	137	182
	kgf·cm·s ²	590	930	1170	1400	1860

2-2 Change in load inertia moment

2

Selection guidelines

For the SHA series combined with the high reduction ratio of the CSG or SHG Harmonic Drive® gear, the effects of change in load inertia moment on the servo performance are minimal. In comparison to direct servo drive mechanisms, therefore, this benefit allows the load to be driven with a better servo response.

For example, assume that the load inertia moment increases to N-times. The total inertia moment converted to motor shaft which has an effect on servo response is as follows:

The symbols in the formulas are:

- J_S : Total inertia moment converted to motor shaft
- J_M : Inertia moment of motor
- R : Reduction ratio of SHA series actuator
- L : Ratio of load inertia moment to inertia moment of motor
- N : Rate of change in load inertia moment

- Direct drive

$$\text{Before: } J_S = J_M(1+L) \qquad \text{After: } J_S' = J_M(1+NL) \qquad \text{Ratio: } J_S'/J_S = \frac{1+NL}{1+L}$$

- Driven by SHA series

$$\text{Before: } J_S = J_M \left(1 + \frac{L}{R^2} \right) \qquad \text{After: } J_S' = J_M \left(1 + \frac{NL}{R^2} \right) \qquad \text{Ratio: } J_S'/J_S = \frac{1+NL/R^2}{1+L/R^2}$$

With the SHA series, the value of R increases from 50 to 161, which means that the value increases substantially from $R^2 = 2500$ to $R^2 = 25921$. Then the ratio is $J_S'/J_S \approx 1$. This means that SHA drive systems are hardly affected by the load variation.

Therefore, it is not necessary to take change in load inertia moment into consideration when selecting a SHA series actuator or setting up the initial driver parameters.

2-3 Verifying and examining load weights

The SHA series actuator incorporates a precise cross roller bearing for directly supporting an external load (output flange). To demonstrate the full ability of the actuator, verify the maximum load moment load as well as the life and static safety coefficient of the cross roller bearing.

Checking procedure

1 Verifying the maximum load moment load (M_{max})

Calculating the maximum load moment load (M_{max})



Verifying the maximum load moment load (M_{max}) is less than or equal to the permissible moment load (M_c)

2 Verifying life

Calculate the average radial load (F_{rav}) and average axial load (F_{aav}).



Calculate the radial load coefficient (X) and the axial load coefficient (Y).



Calculate the life of the bearing and verify the life is allowable.

3 Verifying the static safety coefficient

Calculate the static equivalent radial load (P_o).



Verify the static safety coefficient (f_s).

Specifications of the main roller bearing

The following table shows the specifications of the main roller bearings built in SHA actuators.

Table 1: Specifications of the main roller bearings

Model	Item	Circular pitch of the roller (dp)	Offset amount (R)	Basic dynamic rated load (C)	Basic static rated load (C ₀)	Permissible moment load (M _c)	Moment stiffness (K _m)
		mm	mm	kN	kN	N·m	×10 ⁴ N·m/rad
	SHA20A-SG	70	23.5	14.6	22	187	25.2
	SHA20A-CG	70	19.5	14.6	22	187	25.2
	SHA25A-SG	85	27.6	21.8	35.8	258	39.2
	SHA25A-CG	85	21.6	21.8	35.8	258	39.2
	SHA25A-HP	85	15.3	11.4	20.3	410	37.9
	SHA32A-SG	111	34.9	38.2	65.4	580	100
	SHA32A-CG	111	25.4	38.2	65.4	580	100
	SHA32A-HP	111.5	15	22.5	39.9	932	86.1
	SHA40A-SG	133	44	43.3	81.6	849	179
	SHA40A-CG	133	29.5	43.3	81.6	849	179
	SHA45A-SG	154	47.5	77.6	135	1127	257
	SHA58A-SG	195	62.2	87.4	171	2180	531
	SHA65A-SG	218	69	130	223	2740	741

Maximum load moment load

The formula below shows how to calculate the maximum load moment load (M_{max}).

Verify that the maximum load moment load (M_{max}) is less than or equal to the permissible moment load (M_c).

◆ **Formula (1): Maximum load moment load**

$$M_{max} = \frac{Fr_{max} \cdot (L_r + R) + Fa_{max} \cdot La}{1000}$$

Symbols used in the formula

M_{max}	Maximum load moment load	N · m	
Fr_{max}	Max. radial load	N	Refer to Fig.1.
Fa_{max}	Max. axial load	N	Refer to Fig.1.
L_r, La		mm	Refer to Fig.1.
R	Offset amount	mm	Refer to Fig.1 and Table 1.

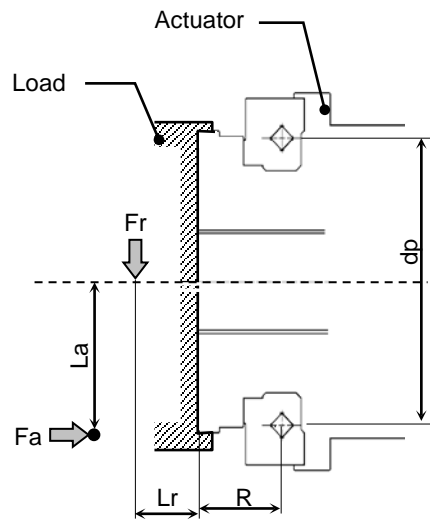

Fig. 1: External load action

Verifying life

Calculating average loads (average radial and axial loads, average output rotational speed)

When the radial and/or axial loads vary during motion, calculate and verify the life of the cross roller bearing converting the loads to their average values.

◆ **Formula (2): Average radial load (F_{rav})**

$$F_{rav} = \sqrt[10/3]{\frac{n_1 t_1 |Fr_1|^{10/3} + n_2 t_2 |Fr_2|^{10/3} + \dots + n_n t_n |Fr_n|^{10/3}}{n_1 t_1 + n_2 t_2 + \dots + n_n t_n}}$$

The maximum radial load in section t_1 is given by Fr_1 , while the maximum radial load in section t_3 is given by Fr_3 .

◆ **Formula (3): Average axial load (F_{aav})**

$$F_{aav} = \sqrt[10/3]{\frac{n_1 t_1 |Fa_1|^{10/3} + n_2 t_2 |Fa_2|^{10/3} + \dots + n_n t_n |Fa_n|^{10/3}}{n_1 t_1 + n_2 t_2 + \dots + n_n t_n}}$$

The maximum axial load in section t_1 is given by Fa_1 , while the maximum axial load in section t_3 is given by Fa_3 .

◆ **Formula (4): Average output rotational speed (N_{av})**

$$N_{av} = \frac{n_1 t_1 + n_2 t_2 + \dots + n_n t_n}{t_1 + t_2 + \dots + t_n}$$

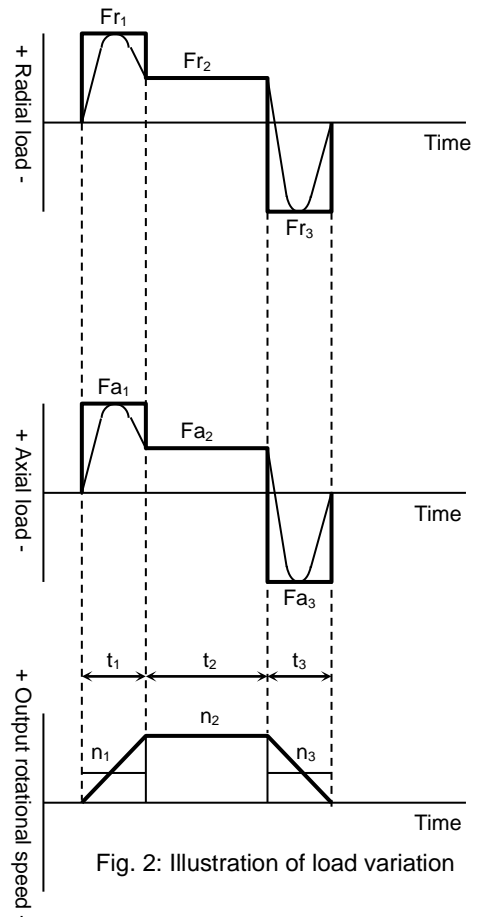

Fig. 2: Illustration of load variation

Radial load coefficient and axial load coefficient

Determine the values of radial load coefficient (X) and axial load coefficient (Y) based on conditional judgment according to formula (5).

Table 2: Radial load coefficient (X), axial load coefficient (Y)

◆ Formula (5)	X	Y
$\frac{F_{rav}}{F_{rav} + 2(F_{rav}(L_r + R) + F_{aav} \cdot L_a)/dp} \leq 1.5$	1	0.45
$\frac{F_{rav}}{F_{rav} + 2(F_{rav}(L_r + R) + F_{aav} \cdot L_a)/dp} > 1.5$	0.67	0.67

Symbols used in the formulas

F_{rav}	Average radial load	N	Refer to the average load.
F_{aav}	Average axial load	N	Refer to the average load.
L_r, L_a	—	mm	Refer to Fig.1.
R	Offset amount	mm	Refer to Fig.1 and Table 1.
dp	Pitch circle diameter of a roller	mm	Refer to Fig.1 and Table 1.

Dynamic equivalent radial load

◆ Formula (6): Dynamic equivalent radial load

$$P_c = X \cdot \left(F_{rav} + \frac{2(F_{rav}(L_r + R) + F_{aav} \cdot L_a)}{dp} \right) + Y \cdot F_{aav}$$

Symbols used in the formulas

P_c	Dynamic equivalent radial load	N	
F_{rav}	Average radial load	N	Obtained by formula (2).
F_{aav}	Average axial load	N	Obtained by formula (3).
dp	Pitch circle diameter of a roller	mm	Refer to Table 1.
X	Radial load coefficient	—	Refer to Table 2.
Y	Axial load coefficient	—	Refer to Table 2.
L_r, L_a	—	mm	Refer to Fig.1.
R	Offset amount	mm	Refer to Fig.1 and Table 1.

Life of cross roller bearing

Calculate the life of cross roller bearing with the formula (7):

◆ Formula (7): Cross roller bearing life

$$L_{B-10} = \frac{10^6}{60 \times N_{av}} \times \left(\frac{C}{f_w \cdot P_c} \right)^{10/3}$$

Symbols used in the formulas

L_{B-10}	Life	hour	—
N_{av}	Average output rotational speed	r/min	Obtained by formula (4).
C	Basic dynamic rated load	N	Refer to Table 1.
P_c	Dynamic equivalent radial load	N	Obtained by formula (6).
f_w	Load coefficient	—	Refer to Table 3.

Table 3: Load coefficient

Loaded state	f_w
Smooth operation free from impact/vibration	1 to 1.2
Normal operation	1.2 to 1.5
Operation subject to impact/vibration	1.5 to 3

Cross roller bearing life based on oscillating movement

Use formula (8) to calculate the cross roller bearing life against oscillating movement.

◆ **Formula (8): Cross roller bearing life (oscillating)**

$$L_{oc} = \frac{10^6}{60 \times n_1} \times \frac{90}{\theta} \times \left(\frac{C}{f_w \cdot P_c} \right)^{10/3}$$

Symbols used in the formulas

L_{oc}	Life	hour	—
n_1	Number of reciprocating oscillation per min.	cpm	—
C	Basic dynamic rated load	N	Refer to Table 1.
P_c	Dynamic equivalent radial load	N	Obtained by formula (6).
f_w	Load coefficient	—	Refer to Table 3.
θ	Oscillating angle/2	—	Refer to Fig.3.

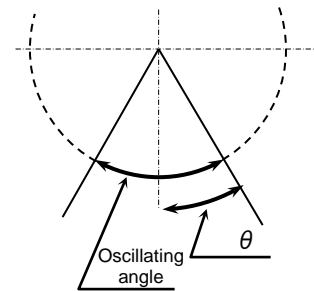

Fig. 3: Oscillating movement

If the oscillating angle is 5° or less, fretting wear may occur because oil film does not form effectively on the contact surface between the race and rolling element of the cross roller bearing. In such cases, consult HDS.

Verifying static safety coefficients

Static equivalent radial load

◆ **Formula (9): Static equivalent radial load**

$$P_o = F_{rmax} + \frac{2M_{max}}{d_p} + 0.44F_{amax}$$

Symbols used in the formulas

F_{rmax}	Max. radial load	N	Refer to Fig.1.
F_{amax}	Max. axial load	N	Refer to Fig.1.
M_{max}	Max. moment load	N·m	Refer to the maximum load weight calculation methods.
d_p	Pitch circle diameter of a roller	mm	Refer to Table 1.

Static safety coefficient

Generally, the static equivalent load is limited by the basic static rated load(C_o). However, the specific limit should be calculated according to the using conditions and required conditions. In this case, calculate the static safety coefficient (f_s) by formula (10).

Table 4 shows general values representing using conditions. Calculate the static equivalent radial load (P_o) by formula (9).

◆ **Formula (10): Static safety coefficient**

$$f_s = \frac{C_o}{P_o}$$

Symbols used in the formulas

f_s	Static safety coefficient	—	Refer to Table 4.
C_o	Basic static rated load	N	Refer to Table 1.
P_o	Static equivalent radial load	N	Obtained by formula (9).

Table 4: Static safety coefficients

Using conditions	f_s
High rotational accuracy is required, etc.	≥ 3
Operation subject to impact/vibration	≥ 2
Normal operation	≥ 1.5

2-4 Examining operating status

The actuator generates heat if started/stopped repeatedly or operated continuously at high speed. Accordingly, examine whether or not the generated heat can be accommodated. The study is as follows:

Examining actuator rotation speed

Calculate the actuator rotation speed [r/min] of the load driven by the SHA series. For linear operation, use the rotation speed conversion formula below:

$$\text{Actuator rotation speed [r/min]} = \frac{\text{Linear travel speed [mm/min]}}{\text{Screw feed pitch [mm]}}$$

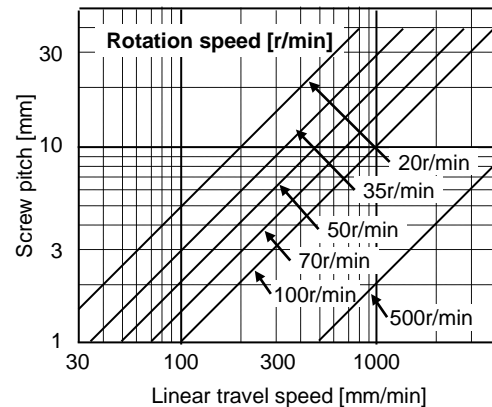

Select an appropriate reduction ratio from 11, 50, 51, 80, 81, 100, 101, 120, 121, 160 and 161 so that the calculated actuator rotation speed does not exceed the maximum rotational speed of the SHA series actuator.

Calculating and examining load inertia moment

Calculate the load inertia moment of the load driven by the SHA series actuator.

Refer to [A-2 Calculating inertia moment] (P5-3) for the calculation.

Based on the calculated result, tentatively select a SHA series actuator by referring to [Allowable load inertia moment] (P2-1).

Load torque calculation

Calculate the load torque as follows:

- Rotary motion

The rotary torque for the rotating mass W on the ring of radius r from the center of rotation is shown in the figure to the right.

$$T = 9.8 \times \mu \times W \times r$$

T : Rotary torque [N·m]

μ : Friction coefficient

W : Mass [kg]

r : Average radius of friction side [m]

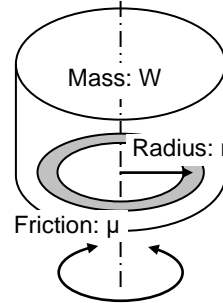

Example of rotary torque calculation (friction coefficient = 0.1)
SHA: 20 % torque of maximum torque is shown.

- Linear operation (horizontal operation)

The rotary torque when the mass W moves horizontally due to the screw of pitch P is shown below.

$$T = 9.8 \times \mu \times W \times \frac{P}{2 \times \pi}$$

T : Rotary torque [N·m]

μ : friction coefficient

W : mass [kg]

P : Screw feed pitch [m]

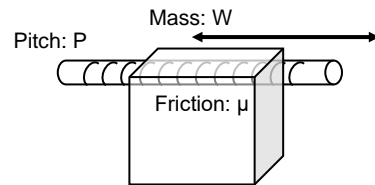

- Linear operation (vertical operation)

The rotary torque when the mass W moves vertically due to the screw of pitch P is shown below.

$$T = 9.8 \times W \times \frac{P}{2 \times \pi}$$

T : Rotary torque [N·m]

W : mass [kg]

P : Screw feed pitch [m]

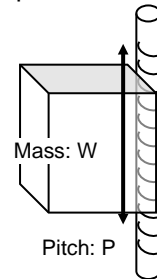

Acceleration time and deceleration time

Calculate acceleration and deceleration times for the selected actuator.

$$\text{Acceleration time: } t_a = k \times (J_A + J_L) \times \frac{2 \times \pi}{60} \times \frac{N}{T_M - T_L}$$

$$\text{Deceleration time: } t_d = k \times (J_A + J_L) \times \frac{2 \times \pi}{60} \times \frac{N}{T_M + 2 \times T_F + T_L}$$

t_a : Acceleration time [s]
 t_d : Deceleration time [s]

k : Acceleration reduction coefficient 1 to 1.5
 The total positioning time may become shorter if the acceleration is lowered for the purpose of reducing the settling time after positioning.

J_A : Actuator inertia moment [kg·m²]

J_L : Load inertia moment [kg·m²]

N : Actuator rotation speed [r/min]

T_M : Maximum actuator torque [N·m]

T_F : Actuator friction torque [N·m]

$$T_F = K_T \times I_R - T_R$$

K_T : Torque constant [N·m/A]

T_R : Allowable continuous torque [N·m]

I_R : Allowable continuous current [A]

T_L : Load torque [N·m]

The polarity is positive (+) when the torque is applied in the rotation direction, or negative (-) when it is applied in the opposite direction.

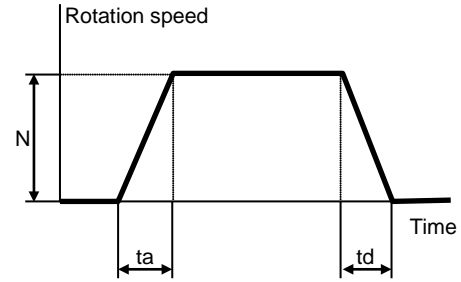

● Calculation example 1

Select an actuator that best suits the following operating conditions:

- Rotation speed: 80 [r/min]
- Load inertia moment: 1.5 [kg·m²]
- Since the load mechanism is mainly inertia, the load torque is negligibly small.

(1) After applying these conditions to the graph in [2-1], SHA25A51SG-B09A200 is tentatively selected.

(2) From the rated table, the following values are obtained:

$$J_A = 0.56 \text{ [kg·m}^2\text{]}$$

$$T_M = 127 \text{ [N·m]}$$

$$T_R = 41 \text{ [N·m]}$$

$$K_T = 19 \text{ [N·m/A]}$$

$$I_R = 3 \text{ [A]}$$

(3) Based on the above formula, the actuator's friction torque T_F is calculated as $19 \times 3 - 41 = 16 \text{ [N·m]}$.

(4) If $k = 1.3$, the acceleration time and deceleration time can be obtained as follows from the above formulas:

$$t_a = 1.3 \times (0.56 + 1.5) \times 2 \times \pi / 60 \times 80 / 127 = 0.177 \text{ [s]}$$

$$t_d = 1.3 \times (0.56 + 1.5) \times 2 \times \pi / 60 \times 80 / (127 + 2 \times 16) = 0.141 \text{ [s]}$$

(5) If the calculated acceleration/deceleration times are too long, correct the situation by:

- Reducing load inertia moment
- Selecting an actuator with a larger frame size

Examining effective torque and average rotation speed

One way to check if the heat generated from the actuator during operation would present a problem is to determine if the point of operation, determined by the effective torque and average rotation speed, is inside the continuous motion range explained in [1-14 Operating range].

Using the following formula, calculate the effective torque T_m and average rotation speed N_{av} when the actuator is operated repeatedly in the drive pattern shown to the right.

$$T_m = \sqrt{\frac{T_a^2 \times t_a + T_r^2 \times t_r + T_d^2 \times t_d}{t}}$$

$$N_{av} = \frac{N/2 \times t_a + N \times t_r + N/2 \times t_d}{t}$$

t_a	: Acceleration time from speed 0 to N	[s]
t_d	: Deceleration time from speed N to 0	[s]
t_r	: Operation time at constant speed N	[s]
t	: Cycle time	[s]
T_m	: Effective torque	[N·m]
T_a	: Torque during acceleration	[N·m]
T_r	: Torque at constant speed	[N·m]
T_d	: Torque during deceleration	[N·m]
N_{av}	: Average rotation speed	[rpm]
N	: Rotation speed at constant speed	[rpm]

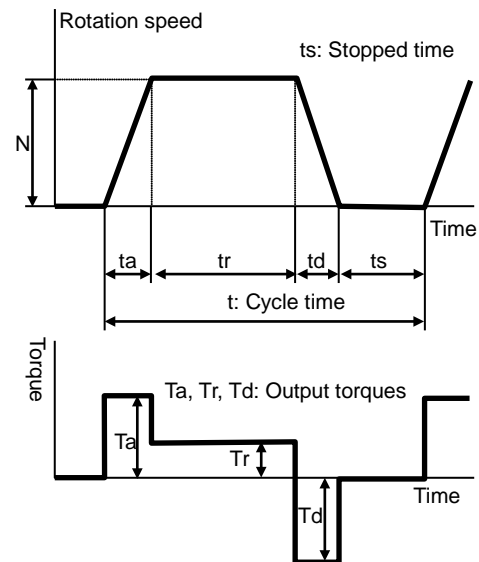

● Calculation example 2

An example of SHA25A51SG-B09A200 is explained.

Operating conditions: Accelerate an inertia load and then let it move at a constant speed, followed by deceleration, based on conditions similar to those used in calculation example 1. The travel angle per cycle is 120° and the cycle time is 1 second.

(1) The travel angle is calculated from the area of the rotation speed vs. time diagram shown above. In other words, the travel angle θ is calculated as follows:

$$\theta = (N / 60) \times \{t_r + (t_a + t_d) / 2\} \times 360$$

$$\text{Accordingly, } t_r = \theta / (6 \times N) - (t_a + t_d) / 2$$

When $\theta = 120^\circ$, and

$$t_a = 0.177 \text{ [s]}$$

$$t_d = 0.141 \text{ [s]}$$

$$N = 80 \text{ [r/min]}$$

in calculation example 1, are applied to this formula, t_r is calculated as 0.091 [s].

(2) Next, calculate the torque during acceleration and torque during deceleration. Based on the acceleration/deceleration time formulas in the preceding section, the relational expressions for torque during acceleration and torque during deceleration if $k = 1$ are as follows:

$$T_a = (J_a + J_L) \times 2 \times \pi / 60 \times N / t_a + T_L$$

$$T_d = (J_a + J_L) \times 2 \times \pi / 60 \times N / t_d - 2 \times T_F - T_L$$

When the values in calculation example 1 are applied to this formula,

$$T_a = 98 \text{ [N·m]} \text{ and}$$

$$T_d = 90 \text{ [N·m]}$$

are obtained.

(3) Calculate the effective torque. Apply the values in (1) and (2), and $T_r = 0 \text{ N·m}$ and $t = 1$ second, to the above formulas.

$$T_m = \sqrt{\frac{98^2 \times 0.177 + 0^2 \times 0.091 + 90^2 \times 0.141}{1}} = 53 \text{ [N·m]}$$

- (4) Calculate the average rotation speed. Apply the values in (1), and $N = 80 \text{ r/min}$ and $t = 1 \text{ second}$, to the above formulas.

$$N_{av} = \frac{80/2 \times 0.177 + 80 \times 0.09 + 80/2 \times 0.141}{1} = 20 \text{ [r/min]}$$

- (5) The figure on the right shows the points of operation determined by the effective torque and average rotation speed calculated above, plotted on the graph of operable range of SHA25A51, exceeding the continuous motion range. The conclusion is that this actuator cannot be operated continuously under these conditions. Accordingly,

- ◆ the operation pattern
- ◆ load (possible reduction)
- ◆ actuator model No.

etc., must be reexamined.

The following formula is a modified version of the formula for effective torque. By applying the value of allowable continuous torque to T_m in this formula, the allowable cycle time can be calculated.

$$t = \frac{T_a^2 \times t_a + T_r^2 \times t_r + T_d^2 \times t_d}{T_m^2}$$

Apply the following:

$T_a = 98 \text{ [N}\cdot\text{m]}$

$T_r = 0 \text{ [N}\cdot\text{m]}$

$T_d = 90 \text{ [N}\cdot\text{m]}$

$T_m = 41 \text{ [N}\cdot\text{m]}$

$t_a = 0.177 \text{ [s]}$

$t_r = 0.091 \text{ [s]}$

$t_d = 0.141 \text{ [s]}$

Then, the following equation is obtained:

$$t = (98^2 \times 0.177 + 90^2 \times 0.141) / 41^2 = 1.69 \text{ [s]}$$

Based on the result, setting the cycle time to 1.7 seconds or more to provide a longer stopped time gives $T_m = 41 \text{ [N}\cdot\text{m]}$ or less, thereby permitting continuous operation within the allowable continuous torque.

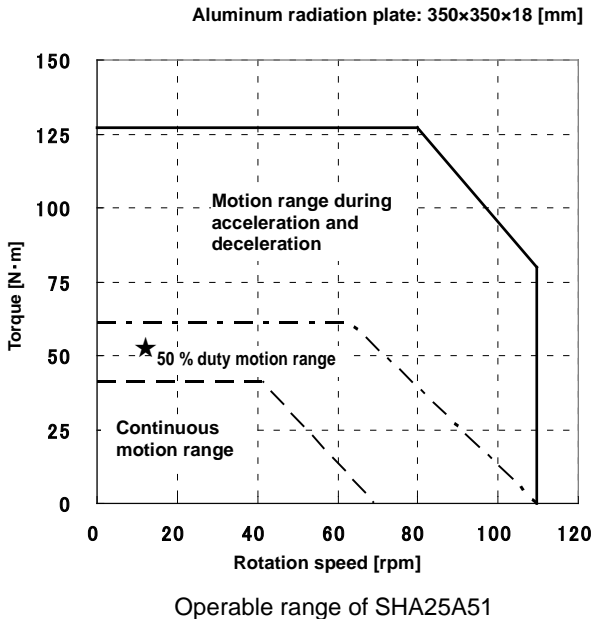

Caution

- The aforementioned continuous motion range represents an allowable range where the actuator installed on a specified aluminum radiation plate is operated under natural air cooling. If the radiation area of the mounting member is small or heat conduction of the material is poor, adjust the operating conditions to keep the rise in the actuator's ambient temperature to 40 K or less as a guide.

2

Selection guidelines

Chapter 3

Installing the actuator

The following explains the installation procedures of the actuators.

3-1 Receiving Inspection.....	3-1
3-2 Notices on handling.....	3-2
3-3 Location and installation	3-6

3-1 Receiving Inspection

Check the following items after unpacking the package.

3

Installing the actuator

Inspection procedure

1 Check the items thoroughly for damage sustained during transportation.

If any item is damaged, immediately contact the dealer.

2 Check if the actuator is what you ordered.

The nameplate is found on the rear end face of the SHA series actuator. Check the TYPE field on the nameplate to confirm that it is indeed the model you have ordered. If any item is wrong, immediately contact the dealer.

Refer to the section [1-2 Model] (P1-2) in this manual for the detail of the model codes.

3 Check the drive input voltages.

The driver's model code is shown in the TYPE field of the driver's nameplate. The last three digits of this model code indicate the input voltage to be input.

100: indicates a single phase 100VAC power supply.

200: indicates a 3-phase/single-phase 200VAC power supply.

If the voltage to be supplied is different from the label voltage, immediately contact the dealer it was purchased from



WARNING

Do not connect a supply voltage other than the voltage specified on the driver label.

Connecting a power supply not matching the input voltage specified on the nameplate may result in damage to the driver, injury or fire.

3-2 Notices on handling

Handle the SHA series actuator carefully by observing the notices specified below.



- (1) Do not apply any excessive force or impact, especially to the actuator's output shaft.
- (2) Do not put the SHA series actuator on a table, shelf, etc., where the actuator could easily fall.
- (3) Do not connect the actuator terminals directly to the power supply. The actuator may burn and cause fire or electric shock.
- (4) The allowable storage temperature is -20 to $+60$ °C. Do not expose the actuator to direct sunlight for long periods of time or store it in areas in low or high temperature.
- (5) The allowable relative storage humidity is 80 % or less. Do not store the actuator in a very humid place or in areas where temperatures are likely to fluctuate greatly during day and night.
- (6) Do not use or store the actuator in locations subject to flammable or corrosive gases or dust particles.
- (7) The large models (SHA58A, SHA65A) are heavy. Handling these models may cause lower back pain, or injury if the actuator drops or topples and you are pinned underneath. Handle your actuator with due care by wearing safety shoes or take other proper precaution and also by using supporting jigs.

Installation and transmission torque

Examples of actuator assembly are shown below. Assembly examples 1 and 2 are for SHA-SG. Assembly examples 3 and 4 are for SHA-CG. Use high-tension bolts and tighten them with a torque wrench to control the tightening torque. In assembly example 2, use flat washers because the tightening torque is high and the actuator flange is made of aluminum.

SHA-SG assembly example

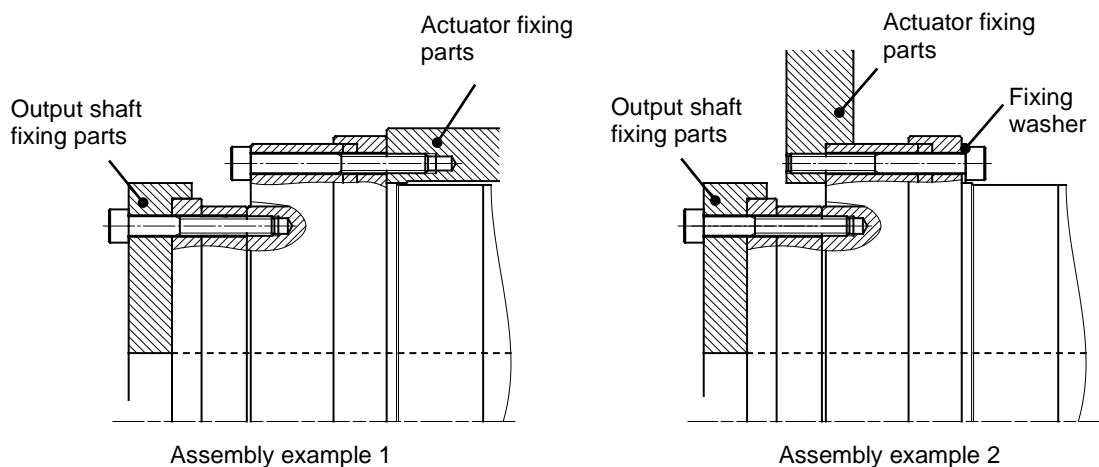

SHA-CG assembly example

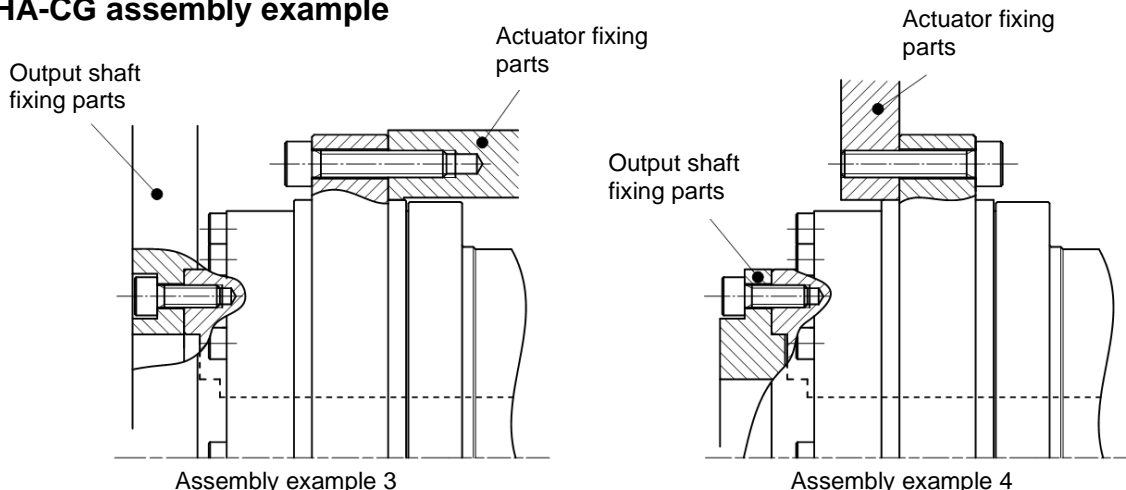

- Recommended tightening torque and transmission torque

SG/HP

Item \ Model		SHA20A		SHA25A		SHA32A	
		Output shaft	Actuator	Output shaft	Actuator	Output shaft	Actuator
Number of bolts, size		16-M3	12-M3	16-M4 (12-M4)	12-M4	16-M5 (12-M5)	12-M5
Bolt installation P.C.D.	mm	62	84	77	102 (127)	100	132 (157)
	N·m	2.0	2.0	4.5	4.5 (3.2)	9	9 (6.4)
Tightening torque	kgf·m	0.20	0.20	0.46	0.46 (0.33)	0.92	0.92 (0.65)
	N·m	203	206	433 (325)	430 (381)	900 (675)	891 (754)
Transmission torque	kgf·m	21	21	44 (33.2)	44 (38.9)	92 (68.9)	91 (76.9)

The values in parenthesis are those combined with the HPF hollow shaft planetary speed reducer.

Item \ Model		SHA40A		SHA45A	
		Output shaft	Actuator	Output shaft	Actuator
Number of bolts, size		16-M6	12-M6	12-M8	18-M6
Bolt installation P.C.D.	mm	122	158	140	180
	N·m	15.3	15.3	37	15.3
Tightening torque	kgf·m	1.56	1.56	3.8	1.56
	N·m	1560	1510	2428	2582
Transmission torque	kgf·m	159	154	248	263

Item \ Model		SHA58A		SHA65A	
		Output shaft	Actuator	Output shaft	Actuator
Number of bolts, size		12-M10	16-M8	16-M10	16-M10
Bolt installation P.C.D.	mm	178	226	195	258
	N·m	74	37	74	74
Tightening torque	kgf·m	7.5	3.8	7.5	7.5
	N·m	4940	5230	7210	9550
Transmission torque	kgf·m	504	533	735	974

CG

Item \ Model		SHA20A		SHA25A	
		Output shaft	Actuator	Output shaft	Actuator
Number of bolts, size		12-M4	6-M5	12-M5	8-M6
Bolt installation P.C.D.	mm	60	107	72	131
Tightening torque	N·m	4.5	6.4	9	11
	kgf·m	0.46	0.65	0.92	1.1
Transmission torque	N·m	253	257	486	600
	kgf·m	26	26	50	61

Item \ Model		SHA32A		SHA40A	
		Output shaft	Actuator	Output shaft	Actuator
Number of bolts, size		12-M6	12-M6	12-M8	8-M10
Bolt installation P.C.D.	mm	96	162	116	203
Tightening torque	N·m	15.3	11	37	52
	kgf·m	1.6	1.1	3.8	5.3
Transmission torque	N·m	918	1114	2012	2639
	kgf·m	94	114	205	269

Note 1: The female thread material is premised to withstand the bolt tightening torque

2: Recommended bolt: Hexagonal bolt per JIS B 1176 Intensity category: JIS B 1051 12.9 or higher

3: Calculation conditions Torque efficiency: 0.2 Tightening efficiency: 1.4 Tightening friction coefficient: 0.15

Precautions on installation

When designing the assembly, take note that application of any abnormal or excessive force that causes deformation of the installation surface may result in performance drop. To demonstrate the excellent performance of the SHA series actuator fully, take note of the following points:

- Warp and deformation on the mounting surface
- Blocking of foreign matter
- Burrs, rising and abnormal position accuracy around tapped mounting holes
- Insufficient chamfering of mounting faucet joint
- Abnormal circularity of mounting faucet joint

When the installation method is as shown in assembly example 2 mentioned above, the recessing shown to the right is recommended for the spigot corner section on the actuator fixing member.

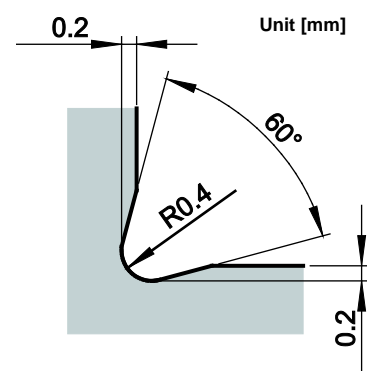

Use of positioning pins

The SHA-SG series actuator has positioning pin holes in the output rotary unit and flange fixed to the actuator. The SHA series CG type has positioning pin holes only in the output rotary unit. Use these pins as necessary. For details, refer to [1-6 External dimensions] (P1-17) or the illustrated specifications.

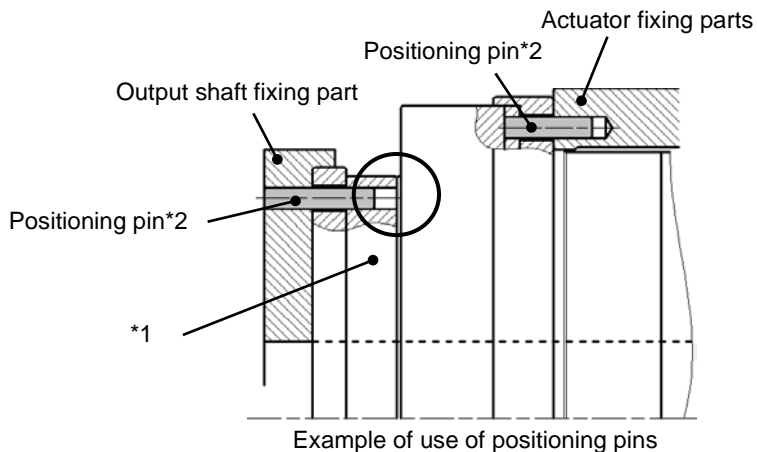

- *1. Do not drive positioning pins into the output rotary unit, but keep proper fitting clearances to the actuator parts. Failure to do so may result in lower positional accuracy.
- *2. The hollow planetary speed reducer model is not equipped with a positioning pin.

Surface treatments

Standard SHA series actuators are given the following surface treatments:

SG/HP

Location	Surface treatments
Housing	No treatment (aluminum material is exposed)
Output shaft bearing	Raydent treatment
Speed reducer rotating part	Chrome plating
Output flange	Nickel plating or Raydent treatment
Hollow shaft (sleeve)	Nickel plating
Bolt (output shaft side)	Black oxide coating treatment

CG

Location	Surface treatments
Housing	No treatment (aluminum material is exposed)
Output flange	Raydent treatment
Speed reducer rotating part	Raydent treatment, enamel resin is applied to some surfaces
Hollow shaft (sleeve)	Nickel plating
Bolt (output shaft side)	Chrome plating or Nickel plating

The surface treatments given to SHA series actuators do not fully prevent rust.

3-3 Location and installation

Environment of location

The environmental conditions of the installation location for SHA series actuators must be as follows. Determine an appropriate installation location by observing these conditions without fail.

- ◆ Operating temperature: 0 to 40 °C
The temperature in the cabinet may be higher than the atmosphere depending on the power loss of housed devices and size of the cabinet. Plan the cabinet size, cooling system, and device locations so the ambient temperature of the actuator is kept 40 °C or below.
- ◆ Operating humidity: Relative humidity of 20 to 80 %.
Make sure no condensation occurs. Take note that condensation is likely to occur in a place where there is a large temperature change between day and night or when the actuator is started/stopped frequently.
- ◆ Vibration: 25 m/s² (10 to 400 Hz) or less (Refer to [1-13 Resistance to vibration] (P1-42))
- ◆ Impact: 300 m/s² or less (Refer to [1-12 Shock resistance] (P1-41))
- ◆ Use environment: Free from condensation, metal powder, corrosive gases, water, oil mist, flammable gases, etc.
- ◆ Protection class: Standard products are structurally designed to meet the IP-54 requirements.

The protection class against water entry is as follows:
4: Protected against water splashed from all directions.

The protection class against contact and entry of foreign matter is as follows:
5: Protected against entry of dust/dirt. Entry of foreign matter caused by incomplete protection must not affect the operation of the system.

However, rotating and sliding areas (oil seal areas) and connectors of SHA20, 25, 32, 40, and 45 are not IP-54-compliant. Connectors of SHA58 and 65 are protected in fitted conditions.

- ◆ Locate the driver indoors or within an enclosure. Do not expose it to the sunlight.
- ◆ Altitude: lower than 1000 m above sea level
- ◆ The oil seals in rotating and sliding areas do not fully prevent leakage of lubricant. If the actuator is used in a clean room, etc., provide additional oil leakage prevention measures.

Installation

The SHA series actuator drives mechanical load system at high accuracy. When installing the actuator, pay attention to precision and do not tap the actuator output part with a hammer, etc. The actuator houses an encoder. Excessive impact may damage the encoder.

Installation procedure

1 Align the axis of rotation of the actuator and the load mechanism precisely.

Note 1: Perform this alignment carefully, especially when a rigid coupling is used. Even slight misalignment may cause the permissible load of the actuator to be exceeded, resulting in damage to the output shaft.

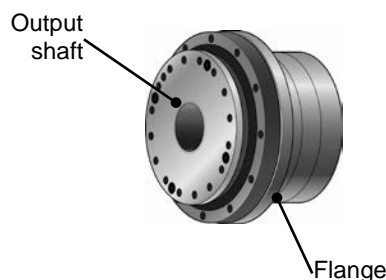

2 Connect the drive and wiring.

An extension cable is provided. Use it when wiring the driver. For details on wiring, refer to [1-15 Cable specifications] (P1-59) and the manual of your HA-800 driver.

3 Wire the motor cable and encoder cable.

Do not pull the cables with a strong force. The connection points may be damaged. Install the cable with slack not to apply tension to the actuator. Provide a sufficient bending radius (at least 6 times the cable diameter), especially when the cable flexes.

Caution

- Do not bring strong magnetic bodies (magnet chucks, permanent magnets, etc.) near the rear cover of the actuator. Encoder abnormality may result.
- This encoder retains absolute positions when the power is turned OFF by means of the driver's battery or its own built-in capacitor. If the encoder cable is disconnected for maintenance, etc., turn on the driver power and charge the backup capacitor first. After 3 hours of charge, the encoder cable can be disconnected for 30 minutes, provided that the axis is stopped and ambient temperature is 25 °C. However, when the backup capacitor is deteriorated, the absolute positions may not be retained.



Do not disassemble/reassemble the actuator.

The actuator uses many precision parts. If the actuator is disassembled or reassembled by the customer, it may cause burned damage or uncontrollable operation of the actuator, resulting in fire or injury.

Chapter 4

Options

This chapter explains the options available for the SHA series actuator.

4-1 Options.....	4-1
------------------	-----

4-1 Options

With near origin and end limit sensors (option code: L)

Revolution sensors are directly connected to the output shaft on the counter-output side of the actuator. Use this option if the mechanical origin is needed (when the virtual origin of the absolute encoder does not do the job) or you want to define an operation range as a safety measure. SHA20 is not compatible.

Side Exiting Cable (option code: Y)

The cables (motor and encoder wires) are taken out from the side of the actuator.

Use this option if the actuator is housed in a system and there is not enough space at the rear of the housing.

This option is not available with the SHA20 (SG), SHA58 and SHA65.

For details on side exiting cables, contact our sales office.

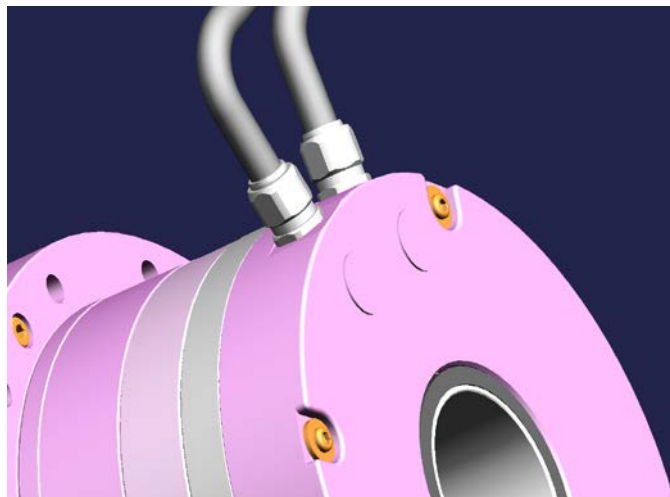

Output shaft single revolution absolute model (option code: S)

With the standard encoder, when it continues to rotate in just one direction, the absolute encoder eventually exceeds the number of revolutions that can be detected with multi-revolution detection and it becomes impossible to manage position information accurately.

With the output shaft single revolution absolute model, each time the output shaft turns through single revolution, the cumulative multi revolution counter is cleared to 0. This is how position information is accurately managed when the shaft continuously turns in just one direction. To use this function, it is necessary to setup a drive. Refer to "HA-800 Series AC Servo Driver Manual". This option is compatible with SHA-CG 25, 32 and 40.

With stand (CG only, option code: V)

An optional stand is available for purchase to use the CG actuator for table drive.

- Outline drawing of the actuator with an optional stand

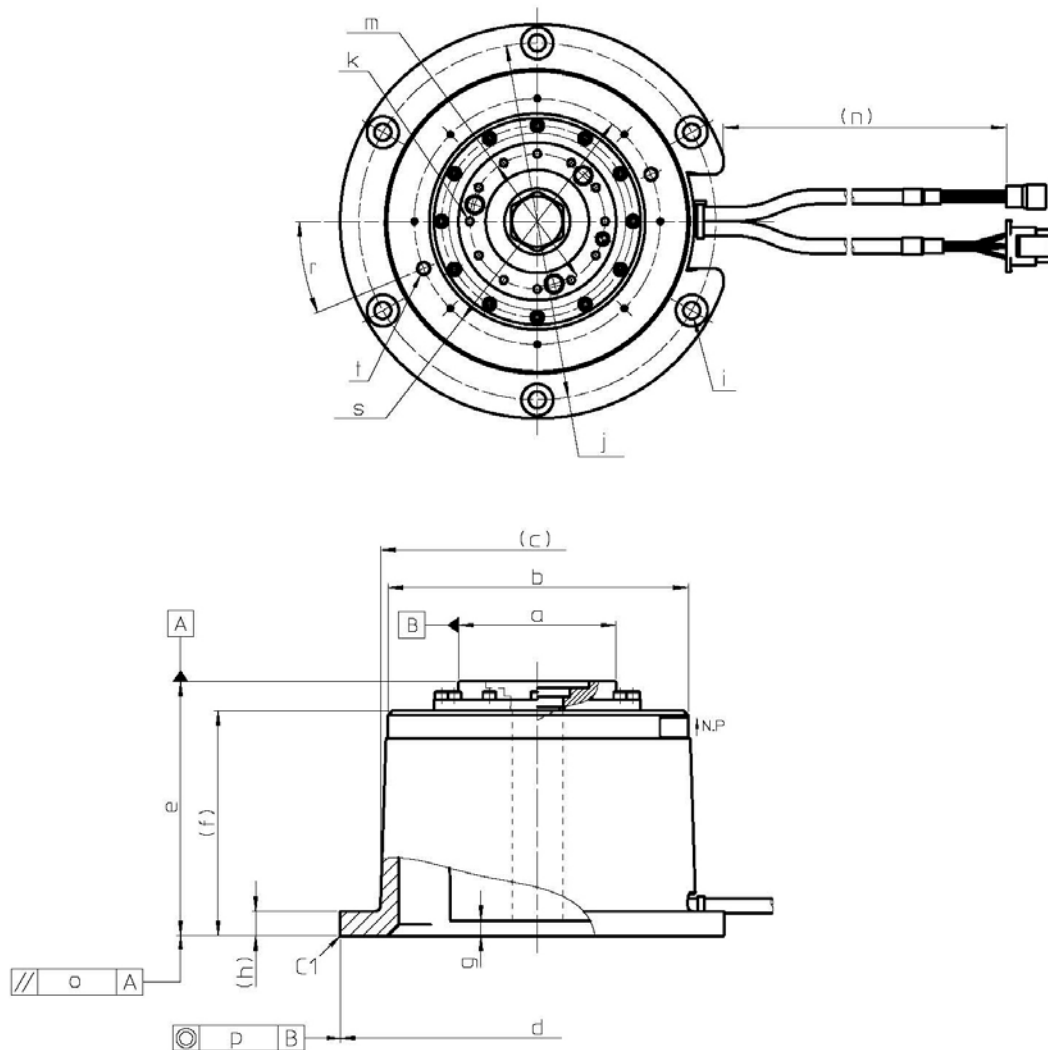

For models with a stand, the cable is taken out from the side of the actuator (option code: Y). Models with near home & end limit sensors (option code: L) are not supported.

● Dimensions and installation specifications of the actuator with an optional stand

Item	Unit	SHA20	SHA25	SHA32	SHA40
a	mm	φ 69 h7 0/-0.030	φ 84 h7 0/-0.035	φ 110 h7 0/-0.035	φ 132 h7 0/-0.040
b	mm	φ 135	φ 160	φ 198	φ 248
c	mm	φ 143	φ 168	φ 208	φ 258
d	mm	φ 177 h7 0/-0.040	φ 210 h7 0/-0.046	φ 260 h7 0/-0.052	φ 316 h7 0/-0.057
e	mm	133±0.3	135.5±0.3	152±0.3	180±0.3
f	mm	118	120	133	163
g	mm	7.5	8	8	10
h	mm	11	13	13	20
i	mm	6-φ 6.6 counterbore φ 13 depth 1	6-φ 9 counterbore φ 17 depth 1	6-φ 11 counterbore φ 21 depth 1	6-φ 13 counterbore φ 25 depth 1
j	mm	φ 161	φ 190	φ 234	φ 288
k	-	12-M4 × 7	12-M5 × 8	12-M6 × 10	12-M8 × 12
m	mm	φ 60	φ 72	φ 96	φ 116
n	mm	170	160	150	130
o ^{Note1)}	mm	0.050	0.055	0.060	0.070
p ^{Note1)}	mm	φ 0.080	φ 0.080	φ 0.090	φ 0.100
r	°	60	22.5	45	90
s	mm	φ 107	φ 131	φ 162	φ 203
t	mm	2-M6 depth 11	2-M8 depth 13	2-M8 depth 15	2-M12 depth 23
Mass ^{Note2)}	kg	4.4 (4.5)	6.1 (6.2)	11.6 (11.9)	20 (21)
Section i ^{Note 5)} Bolts used	-	6-M6	6-M8	6-M10	6-M12
Section i Recommended tightening torque	N·m	11	26	52	90

Note 1) All values are T.I.R. (Total Indicator Reading).

2) The values in parentheses are for models with a brake.

3) For detailed dimensions and specifications of the actuator, refer to the illustrated specifications.

4) Cast aluminum is used for the material of the stand. No surface treatment has been applied.

5) Use flat washers when installing the product.

Extension cables

You must use an extension cable to connect your SHA series actuator and HA-800 driver. Two types of extension cables are available for motor (including brake wire) and encoder.

Motor extension cable:

- **SHA 20, 25, 32, 40 (Size 40 requires an extension cable when combined with the HA-800-6D/E.)**

EWD-MB**-A06-TN3

** in the model code indicates the cable length (03 = 3 m, 05 = 5 m, 10 = 10 m).

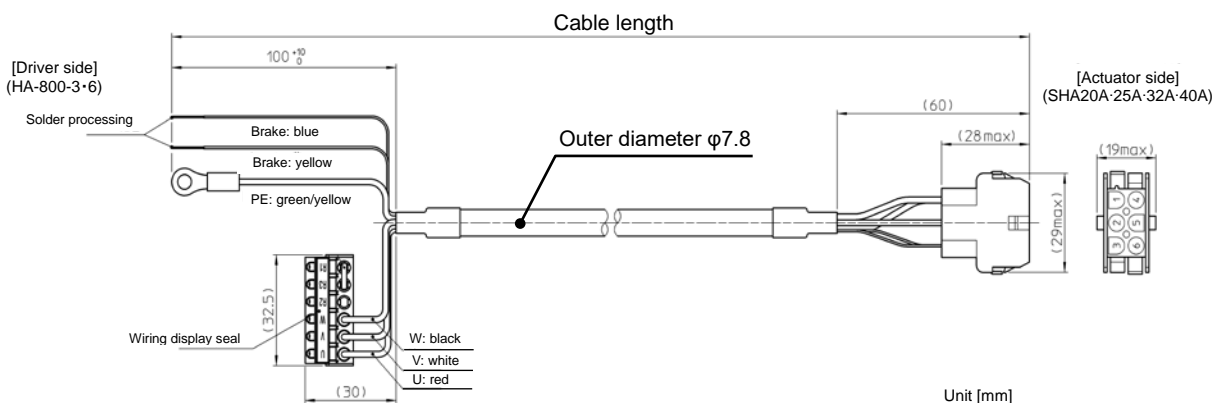

- **SHA 40, 45 (SHA 40 requires an extension cable when combined with the HA-800-24D/E.)**

EWD-MB**-A06-TMC

** in the model code indicates the cable length (03 = 3 m, 05 = 5 m, 10 = 10 m).

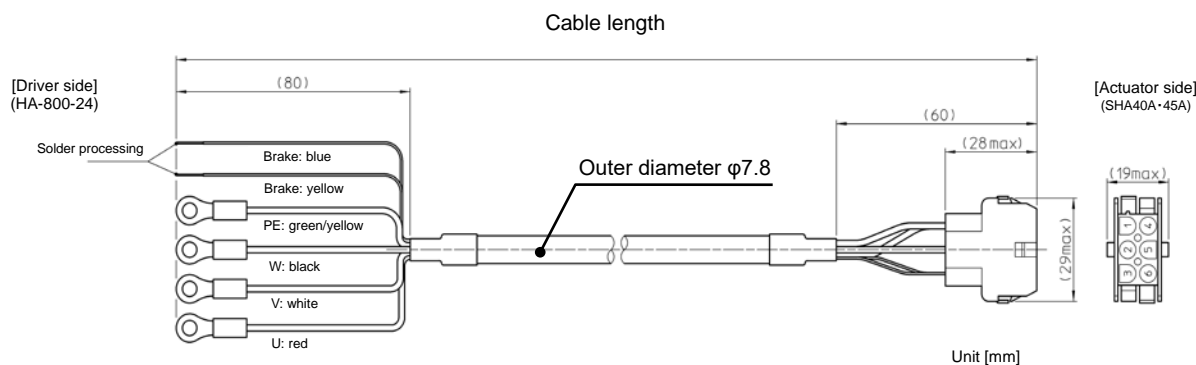

● **SHA 58, 65**
EWD-MB**-D09-TMC

** in the model code indicates the cable length (03 = 3 m, 05 = 5 m, 10 = 10 m).

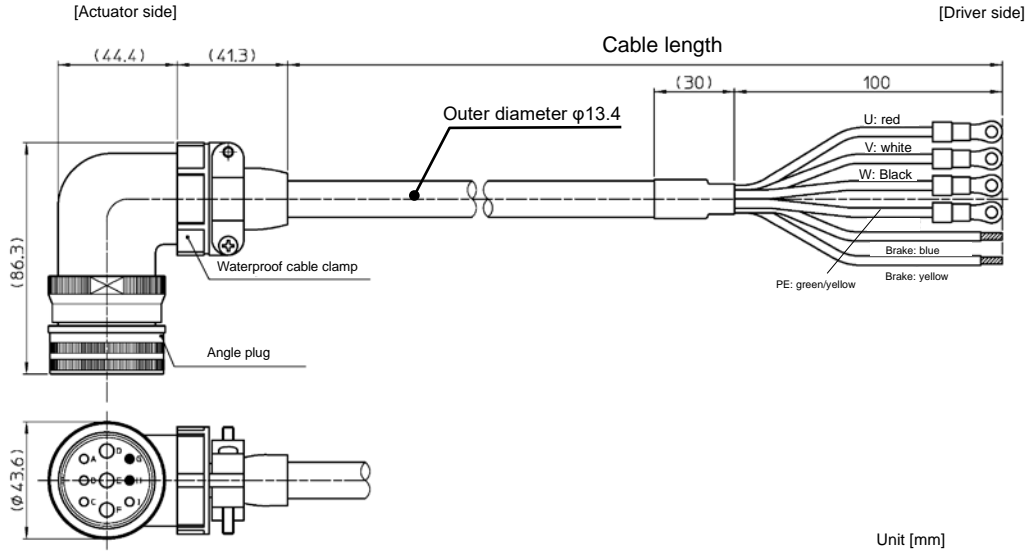

Absolute encoder extension cable:

- **Actuator size 20, 25, 32, 40, 45**
EWD-S**-A08-3M14

** in the model code indicates the cable length (03 = 3 m, 05 = 5 m, 10 = 10 m).

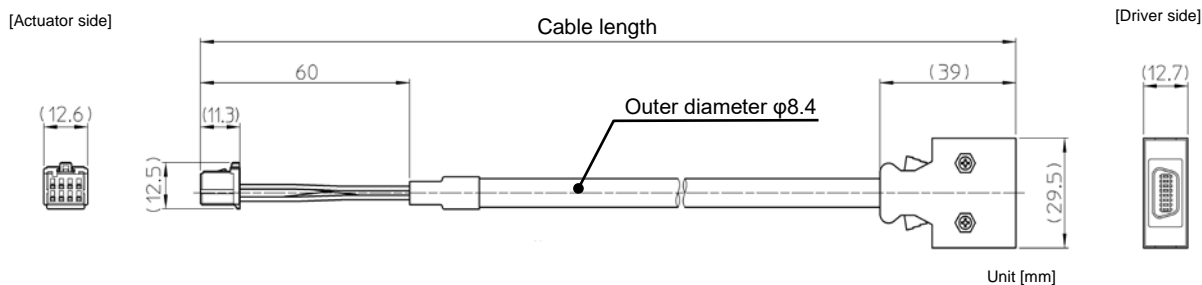

- **Actuator size 58, 65**
EWD-S**-D10-3M14

** in the model code indicates the cable length (03 = 3 m, 05 = 5 m, 10 = 10 m).

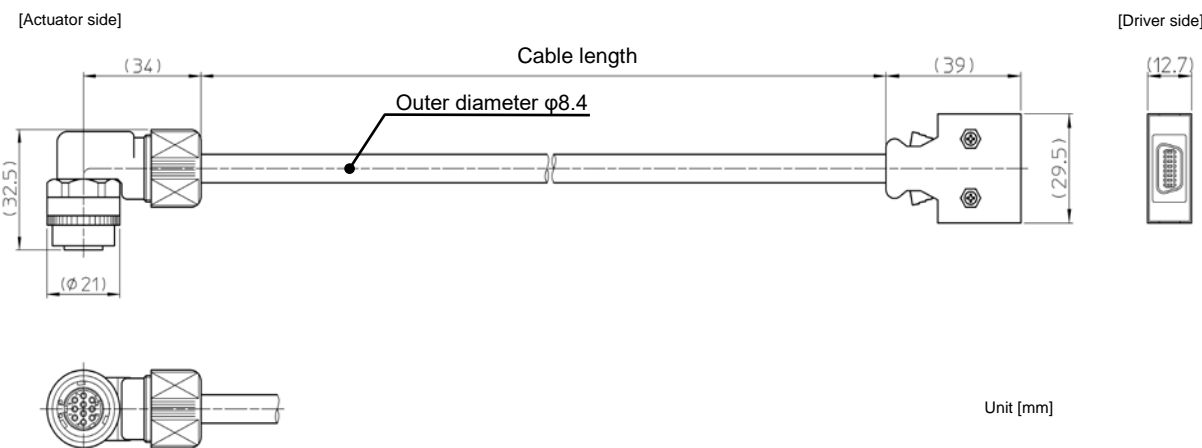

Caution

- Provide a sufficient bending radius (at least 6 times the cable diameter), when the cable flexes.

Appendix

A-1 Unit conversion.....	5-1
A-2 Calculating inertia moment.....	5-3

A-1 Unit conversion

This manual employs SI system for units. Conversion factors between the SI system and other systems are as follows:

(1) Length

SI system	m	
Unit	ft.	in.
Factor	3.281	39.37

(2) Linear speed

SI system	m/s			
Unit	m/min	ft./min	ft./s	in/s
Factor	60	196.9	3.281	39.37

(3) Linear acceleration

SI system	m/s ²			
Unit	m/min ²	ft./min ²	ft./s ²	in/s ²
Factor	3600	1.18x10 ⁴	3.281	39.37

(4) Force

SI system	N		
Unit	kgf	lb (force)	oz (force)
Factor	0.102	0.225	4.386

(5) Mass

SI system	kg	
Unit	lb.	oz.
Factor	2.205	35.27

(6) Angle

SI system	rad		
Unit	deg.	min.	sec.
Factor	57.3	3.44x10 ³	2.06x10 ⁵

(7) Angular speed

SI system	rad/s			
Unit	deg/s	deg/min	r/s	r/min
Factor	57.3	3.44x10 ³	0.1592	9.55

Unit	ft.	in.
Factor	0.3048	0.0254

SI system	m	
-----------	---	--

Unit	m/min	ft./min	ft./s	in/s
Factor	0.0167	5.08x10 ⁻³	0.3048	0.0254

SI system	m/s			
-----------	-----	--	--	--

Unit	m/min ²	ft./min ²	ft./s ²	in/s ²
Factor	2.78 x10 ⁻⁴	8.47x10 ⁻⁵	0.3048	0.0254

SI system	m/s ²			
-----------	------------------	--	--	--

Unit	kgf	lb (force)	oz (force)
Factor	9.81	4.45	0.278

SI system	N		
-----------	---	--	--

Unit	lb.	oz.
Factor	0.4535	0.02835

SI system	kg	
-----------	----	--

Unit	deg.	min.	sec.
Factor	0.01755	2.93x10 ⁻⁴	4.88x10 ⁻⁶

SI system	rad		
-----------	-----	--	--

Unit	deg/s	deg/min	r/s	r/min
Factor	0.01755	2.93x10 ⁻⁴	6.28	0.1047

SI system	rad/s			
-----------	-------	--	--	--

Appendix

(8) Angular acceleration

SI system	rad/s ²	
↓		
Unit	deg/s ²	deg/min ²
Factor	57.3	3.44x10 ³

Unit	deg/s ²	deg/min ²
Factor	0.01755	2.93x10 ⁻⁴
↓		
SI system	rad/s ²	

(9) Torque

SI system	N·m			
↓				
Unit	kgf·m	lb·ft	lb·in	oz·in
Factor	0.102	0.738	8.85	141.6

Unit	kgf·m	lb·ft	lb·in	oz·in
Factor	9.81	1.356	0.1130	7.06x10 ⁻³
↓				
SI system	N·m			

(10) Inertia moment

SI system	kg·m ²							
↓								
Unit	kgf·m·s ²	kgf·cm·s ²	lb·ft ²	lb·ft·s ²	lb·in ²	lb·in·s ²	oz·in ²	oz·in·s ²
Factor	0.102	10.2	23.73	0.7376	3.42x10 ³	8.85	5.47x10 ⁴	141.6

Unit	kgf·m·s ²	kgf·cm·s ²	lb·ft ²	lb·ft·s ²	lb·in ²	lb·in·s ²	oz·in ²	oz·in·s ²
Factor	9.81	0.0981	0.0421	1.356	2.93x10 ⁻⁴	0.113	1.829x10 ⁻⁵	7.06x10 ⁻³

SI system	kg·m ²							
-----------	-------------------	--	--	--	--	--	--	--

(11) Torsional spring constant, moment stiffness

SI system	N·m/rad				
↓					
Unit	kgf·m/rad	kgf·m/arc-min	kgf·m/deg	lb·ft/deg	lb·in/deg
Factor	0.102	2.97 x10 ⁻⁵	1.78x10 ⁻³	0.0129	0.1546

Unit	kgf·m/rad	kgf·m/arc-min	kgf·m/deg	lb·ft/deg	lb·in/deg
Factor	9.81	3.37 x10 ⁴	562	77.6	6.47

SI system	N·m/rad				
-----------	---------	--	--	--	--

A-2 Calculating inertia moment

Formula for moment of inertia and mass

(1) The center of gravity is coincident with the axis of rotation

The following table includes formulas to calculate mass and inertia moment.

m: Mass [kg], I_x, I_y, I_z: inertia moments which rotate around x-, y-, z-axes respectively [kg·m²]

G: Distance from the end face to the center of gravity [m]

ρ : Specific gravity [×10³kg / m³]

Unit Inertia moment [kg·m²]

Appe

Appendix

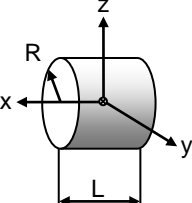
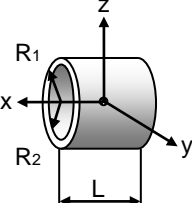
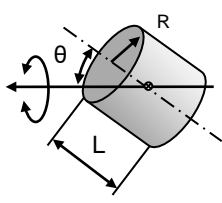
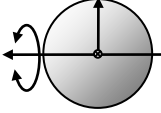
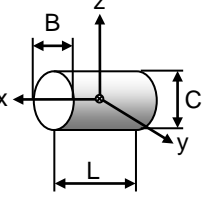
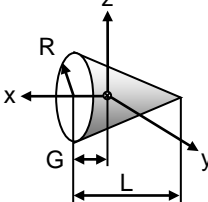
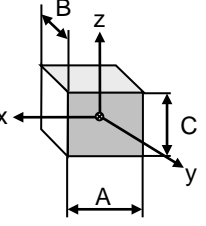
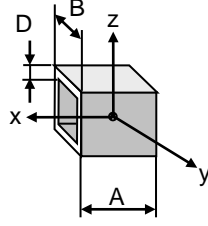
Object form	Mass, inertia, gravity center	Object form	Mass, inertia, gravity center
cylinder 	$m = \pi R^2 L \rho \times 10^3$ $I_x = \frac{1}{2} m R^2$ $I_y = \frac{1}{4} m \left(R^2 + \frac{L^2}{3} \right)$ $I_z = \frac{1}{4} m \left(R^2 + \frac{L^2}{3} \right)$	Circular pipe 	$m = \pi (R_1^2 - R_2^2) L \rho \times 10^3$ $I_x = \frac{1}{2} m (R_1^2 + R_2^2)$ $I_y = \frac{1}{4} m \left\{ (R_1^2 + R_2^2) + \frac{L^2}{3} \right\}$ $I_z = \frac{1}{4} m \left\{ (R_1^2 + R_2^2) + \frac{L^2}{3} \right\}$ <p>R₁: Outer diameter R₂: Inner diameter</p>
Slanted cylinder 	$m = \pi R^2 L \rho \times 10^3$ $I_\theta = \frac{1}{12} m \times \left\{ 3R^2(1 + \cos^2\theta) + L^2 \sin^2\theta \right\}$	Ball 	$m = \frac{4}{3} \pi R^3 \rho \times 10^3$ $I = \frac{2}{5} m R^2$
Ellipsoidal cylinder 	$m = \frac{1}{4} B C L \rho \times 10^3$ $I_x = \frac{1}{16} m (B^2 + C^2)$ $I_y = \frac{1}{4} m \left(\frac{C^2}{4} + \frac{L^2}{3} \right)$ $I_z = \frac{1}{4} m \left(\frac{B^2}{4} + \frac{L^2}{3} \right)$	Cone 	$m = \frac{1}{3} \pi R^2 L \rho \times 10^3$ $I_x = \frac{3}{10} m R^2$ $I_y = \frac{3}{80} m (4R^2 + L^2)$ $I_z = \frac{3}{80} m (4R^2 + L^2)$ $G = \frac{L}{4}$
Rectangular pillar 	$m = A B C \rho \times 10^3$ $I_x = \frac{1}{12} m (B^2 + C^2)$ $I_y = \frac{1}{12} m (C^2 + A^2)$ $I_z = \frac{1}{12} m (A^2 + B^2)$	Square pipe 	$m = 4 A D (B - D) \rho \times 10^3$ $I_x = \frac{1}{3} m (B \cdot D)^2 + D^2 \left\{ \right.$ $I_y = \frac{1}{6} m \left\{ \frac{A^2}{2} + (B \cdot D)^2 + D^2 \right\}$ $I_z = \frac{1}{6} m \left\{ \frac{A^2}{2} + (B \cdot D)^2 + D^2 \right\}$

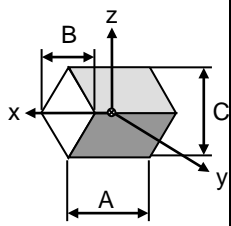
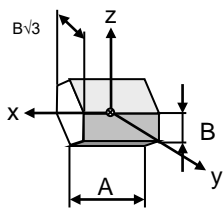
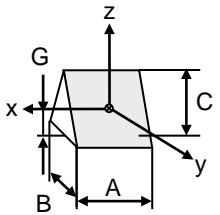
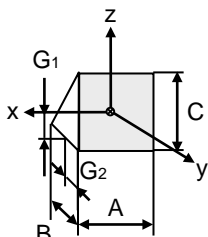
Object form	Mass, inertia, gravity center	Object form	Mass, inertia, gravity center
	$m = \frac{1}{2} ABC\rho \times 10^3$ $I_x = \frac{1}{24} m(B^2 + C^2)$ $I_y = \frac{1}{24} m(C^2 + 2A^2)$ $I_z = \frac{1}{24} m(B^2 + 2A^2)$		$m = \frac{3\sqrt{3}}{2} AB^2 \rho \times 10^3$ $I_x = \frac{5}{12} m B^2$ $I_y = \frac{1}{12} m \left(A^2 + \frac{5}{2} B^2 \right)$ $I_z = \frac{1}{12} m \left(A^2 + \frac{5}{2} B^2 \right)$
	$m = \frac{1}{2} ABC\rho \times 10^3$ $I_x = \frac{1}{12} m \left(\frac{B^2}{2} + \frac{2}{3} C^2 \right)$ $I_y = \frac{1}{12} m \left(A^2 + \frac{2}{3} C^2 \right)$ $I_z = \frac{1}{12} m \left(A^2 + \frac{B^2}{2} \right)$ $G = \frac{C}{3}$		$m = \frac{1}{2} ABC\rho \times 10^3$ $I_x = \frac{1}{36} m(B^2 + C^2)$ $I_y = \frac{1}{12} m \left(A^2 + \frac{2}{3} C^2 \right)$ $I_z = \frac{1}{12} m \left(A^2 + \frac{2}{3} B^2 \right)$ $G_1 = \frac{C}{3} \quad G_2 = \frac{B}{3}$

● **Example of specific gravity**

The following tables show reference values for specific gravity. Check the specific gravity for each material.

Material	Specific gravity [$\times 10^3 \text{kg} / \text{m}^3$]	Material	Specific gravity [$\times 10^3 \text{kg} / \text{m}^3$]	Material	Specific gravity [$\times 10^3 \text{kg} / \text{m}^3$]
SUS304	7.93	Aluminum	2.70	Epoxy resin	1.90
S45C	7.86	Duralumin	2.80	ABS	1.10
SS400	7.85	Silicon	2.30	Silicon resin	1.80
Cast iron	7.19	Quartz glass	2.20	Polyurethane rubber	1.25
Copper	8.92	Teflon	2.20		
Brass	8.50	Fluorocarbon resin	2.20		

(2) Both centerlines of rotation and gravity are not the same:

The following formula calculates the inertia moment when the rotary center is different from the gravity center.

$$I = I_g + mF^2$$

I : Inertia moment when the gravity center axis does not match the rotational axis [$\text{kg} \cdot \text{m}^2$]

I_g : Inertia moment when the gravity center axis matches the rotational axis [$\text{kg} \cdot \text{m}^2$]

Calculate according to the shape by using formula (1).

m : Mass [kg]

F : Distance between rotary center and gravity center [m]

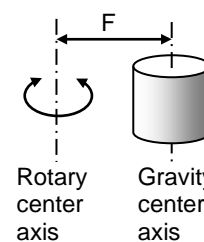

(3) Inertia moment of linear operation objects

The inertia moment, converted to output shaft, of a linear motion object driven by a screw, etc., is calculated using the formula below.

$$I = m \left(\frac{P}{2\pi} \right)^2$$

I : Inertia moment of a linear operation object converted to motor axis [$\text{kg} \cdot \text{m}^2$]

m : Mass [kg]

P : Linear travel per motor one revolution [m/rev]

Inertia moment of cylinder

The inertia moment of a cylinder can be obtained from the graphs to the right.

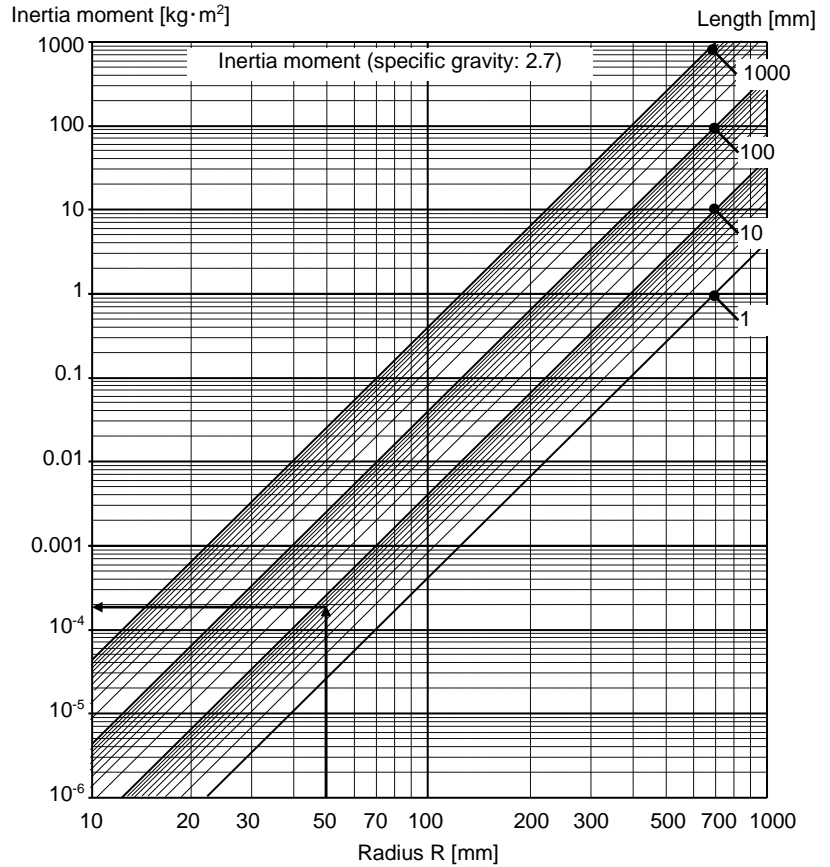
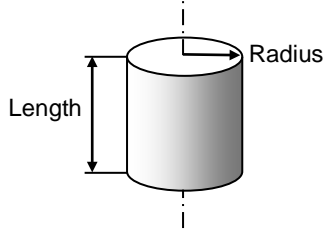

Apply the top graph to aluminum materials (specific gravity: 2.7) and bottom graph to steel materials (specific gravity: 7.85):

(Example)
 Material: Aluminum
 Outer diameter: 100 [mm]
 Length: 7 [mm]
 Shape: Column
 Outer diameter: 100 [mm]
 Inner diameter: 50 [mm]
 Inertia moment:
 Approx. 1.9×10^{-4} [kg·m²] (by the graph on the right)

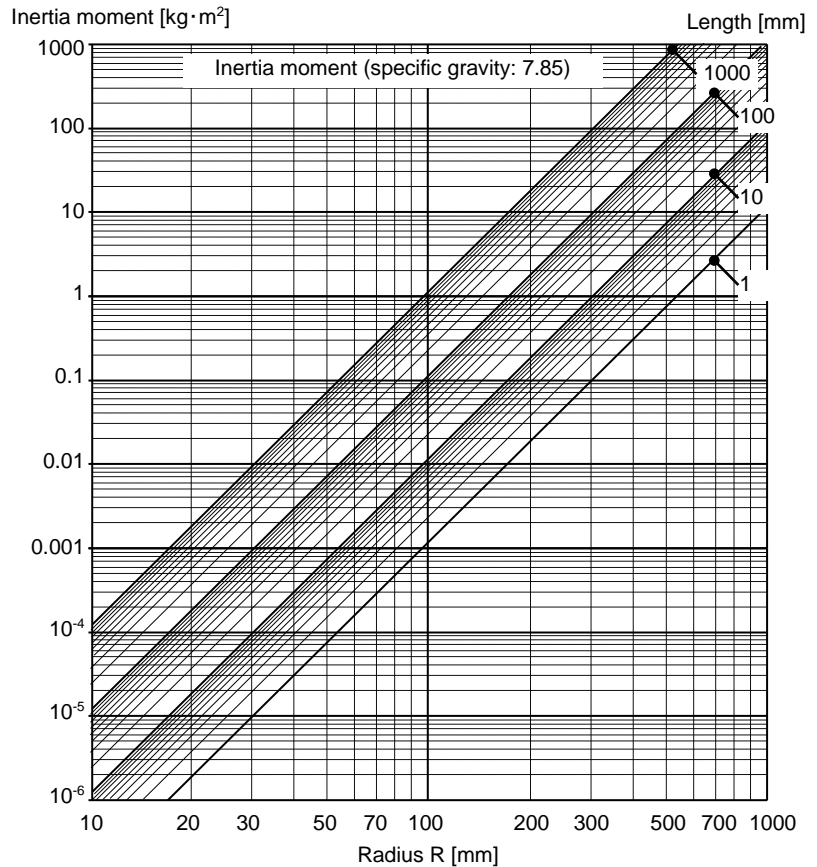

Appendix

Index

A

Absolute encoder.....	1-35
Acceleration time.....	2-12
Allowable load inertia moment.....	2-1
Average rotation speed.....	2-13

C

Cable specifications.....	1-60
Cable taken out from side.....	4-1
Combinations with drivers and extension cables.....	1-4
Conformance to overseas standards.....	7

D

Deceleration time.....	2-12
Detector specifications.....	1-35

E

Effective torque.....	2-13
Encoder cable specifications.....	1-61
Environmental conditions.....	3-6
Examining actuator rotation speed.....	2-10
Examining operating status.....	2-10
Extension cable.....	4-4
External dimensions.....	1-18

I

Inertia moment.....	5-3
Inertia moment of cylinder.....	5-5
Installation.....	3-2, 3-6, 3-7
Installation location.....	3-6

L

Life.....	2-7
Load inertia moment.....	2-5, 2-10
Load torque.....	2-11
Load weight.....	2-6

M

Maximum load moment load.....	2-7
Mechanical accuracy.....	1-31
Model.....	1-3

Moment stiffness.....	1-37
Motor cable specifications.....	1-60
Motor shaft holding brake.....	1-15

N

Notices on handling.....	3-2
--------------------------	-----

O

Operable range.....	1-44
Option.....	4-1
Outlines.....	1-1

P

Positional accuracy.....	1-33
Positioning pins.....	3-5
Precautions on installation.....	3-4

R

Receiving inspection.....	3-1
Related manual.....	7
Resistance to vibration.....	1-43
Rigidity.....	1-37
Rotation direction.....	1-41

S

SHA series selection.....	2-1
Shock resistance.....	1-42
Specifications.....	1-5
Static safety coefficient.....	2-9
Surface treatment.....	3-5

T

Torsional stiffness.....	1-38, 1-40
Transmission torque.....	3-2

U

Unit.....	5-1
-----------	-----

W

With near origin and end limit sensors.....	4-1
With stand (CG type, option code: V).....	4-2



Warranty Period and Terms

The equipment listed in this document is warranted as follows:

■ Warranty period

Under the condition that the actuator is handled, used and maintained properly followed each item of the documents and the manuals, all the applicable products are warranted against defects in workmanship and materials for the shorter period of either one year after delivery or 2,000 hours of operation time.

■ Warranty terms

All the applicable products are warranted against defects in workmanship and materials for the warranted period. This limited warranty does not apply to any product that has been subject to:

- (1) user's misapplication, improper installation, inadequate maintenance, or misuse.
- (2) disassembling, modification or repair by others than Harmonic Drive Systems, Inc.
- (3) imperfection caused by a non-applicable product.
- (4) disaster or others that does not belong to the responsibility of Harmonic Drive Systems, Inc.

Our liability shall be limited exclusively to repairing or replacing the product only found by Harmonic Drive Systems, Inc. to be defective. Harmonic Drive Systems, Inc. shall not be liable for consequential damages of other equipment caused by the defective products, and shall not be liable for the incidental and consequential expenses and the labor costs for detaching and installing to the driven equipment.

All efforts have been made to assure that the information in this catalog is complete and accurate. However, Harmonic Drive LLC is not liable for any errors, omissions or inaccuracies in the reported data. Harmonic Drive LLC reserves the right to change the product specifications, for any reason, without prior notice.



HarmonicDrive.net / 978-532-1800

Harmonic Drive LLC
Headquarters/Manufacturing
42 Dunham Ridge, Beverly, MA 01915

New York Office
100 Motor Parkway Suite 116, Hauppauge, NY 11788

Chicago Office
137 N. Oak Park Ave. Suite 410, Oak Park, IL 60301

California Office
333 W. San Carlos St. Suite 1070, San Jose, CA 95110

Group Companies

Harmonic Drive Systems, Inc.
6-25-3 Minami-Ohi, Shinagawa-ku
Tokyo 141-0013, Japan

Harmonic Drive SE
Hoenbergstrasse, 14, D-65555
Limburg/Lahn Germany

© 2020 Harmonic Drive. All rights reserved.
Harmonic Drive is a registered trademark of Harmonic Drive Systems.

Sold & Serviced by:
 ELECTROMATE

Toll Free Phone: (877) SERV098
Toll Free Fax: (877) SERV099

www.electromate.com
sales@electromate.com

07302020