

# Harmonic Drive<sup>®</sup>

AC Servo Actuator

## **RSF supermini Series Manual**

**(With RSF-3C and RSF-5B)**

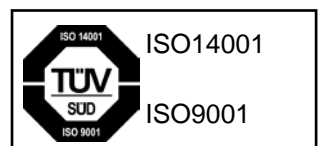
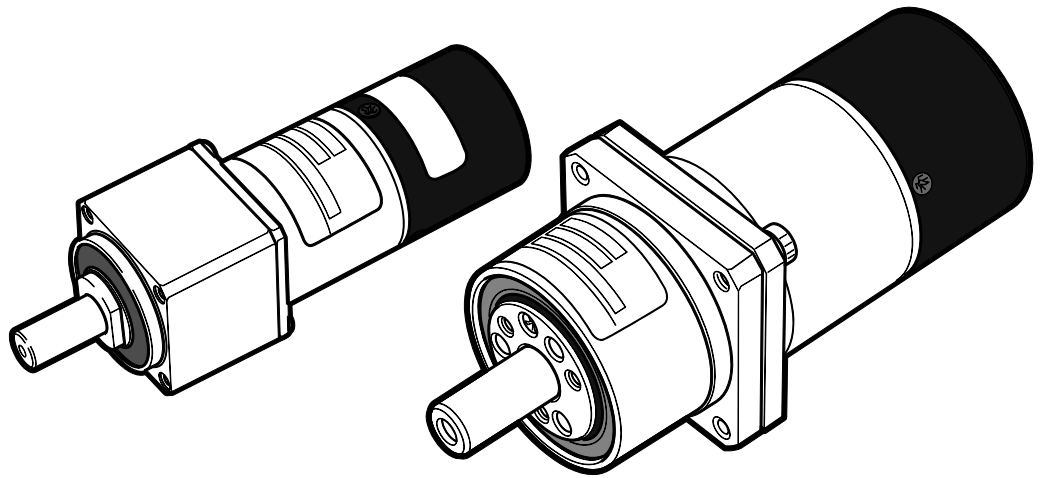

# Introduction

Thank you very much for your purchasing our RSF supermini series servo actuator.

Be sure to use sufficient safety measures when installing and operating the equipment so as to prevent an accident resulting in a serious physical injury damaged by a malfunction or improper operation.

Product specifications are subject to change without notice for improvement purposes.

Keep this manual in a convenient location and refer to it whenever necessary in operating or maintaining the units.



The end user of the actuator should have a copy of this manual.

# SAFETY GUIDE

To use the servo system safely, be sure to read SAFETY GUIDE and other parts of this document carefully and fully understand the information provided herein before using the driver.

## NOTATION

Important safety information you must note is provided herein. Be sure to observe these instructions.

 WARNING	Indicates a potentially hazardous situation, which, if not avoided, could result in death or serious personal injury.
 CAUTION	Indicates a potentially hazardous situation, which, if not avoided, may result in minor or moderate personal injury and/or damage to the equipment.

## LIMITATION OF APPLICATIONS

The equipment listed in this document may not be used for the applications listed below:

- Space equipment
- Aircraft, aeronautic equipment
- Nuclear equipment
- Household apparatus
- Vacuum equipment
- Automobile, automotive parts
- Amusement equipment
- Machine or devices acting directly on the human body
- Instruments or devices to transport or carry people
- Apparatus or devices used in special environments
- Instruments or devices to prevent explosion

If the above list includes your intending application for our products, please consult us.

 CAUTION	<b>If this product is utilized in any facility in which human life is at stake or that may incur material losses, install safety devices so that accidents will not occur even when the output control is disabled due to damage.</b>
--	---

## SAFETY NOTE

### Precautions when using a direct drive motor

#### ● NOTICES ON DESIGN

**BE SURE TO READ THE MANUAL FOR DESIGNING.**



#### **Always use under followings conditions:**

The motor is designed to be used for indoor.

- Ambient temperature: 0°C to 40°C
- Ambient humidity: 20% to 80%RH (Non-condensation)
- Vibration: 49 m/s<sup>2</sup> or less
- No contamination by water, oil
- No metal powder, dust, oil mist, corrosive gas, or explosive gases

#### **Follow exactly the instructions to install the actuator in the equipment.**

- Ensure exact alignment of motor shaft center and corresponding center in the application.
- Failure to observe this caution may lead to vibration, resulting in damage of output shaft.

#### ● OPERATIONAL PRECAUTIONS

**BE SURE TO READ THE MANUAL BEFORE OPERATING THE PRODUCT.**



#### **Never connect cables directly to a power supply socket.**

- Direct drive motor cannot be operated unless it is connected to dedicated driver.
- Never connect it to commercial power supply directly. Direct drive motor may be damaged and causes fire.

#### **Do not apply shocks to actuator.**

- Do not apply shocks because direct drive motor is directly connected to high precision encoder.
- If the encoder is damaged, it may cause uncontrollable operation.

#### **Avoid handling of motor by cables.**

- Failure to observe this caution may damage the wiring, causing uncontrollable or faulty operation of direct drive motor.



#### **Keep limited torques of the actuator.**

- Keep limited torques of the actuator.
- Be aware that, if arms directly attached to the output shaft are hit, the output shaft may become non-controllable.

## Precautions when using a driver

### ● NOTICES ON DESIGN

**BE SURE TO READ THE MANUAL FOR DESIGNING.**



#### **Always use drivers under followings conditions:**

The driver generates heat. Take extra caution for radiation and use it under the following conditions.

- Mount in a vertical position keeping sufficient distance.
- 0 to 50°C, 95% RH or below (Non condensation)
- No vibration or shocks
- No metal powder, dust, oil mist, corrosive gas, or explosive gases

#### **Use sufficient noise suppressing means and safe grounding.**

Any noise generated on a signal wire will cause vibration or improper motion. Be sure to observe the following conditions.

- Keep signal and power leads separated.
- Keep leads as short as possible.
- Ground actuator and driver at one single point, minimum ground resistance class: D (less than 100 ohms)
- Do not use a power line filter in the motor circuit.

#### **Pay attention to negative torque by inverse load.**

- Inverse load may cause damages of direct drive motor.  
Please consult our sales office, if you intend to apply products for inverse load.

#### **Use a fast-response type ground-fault detector designed for PWM inverters.**

When using a fast-response type ground-fault detector, use one that is designed for PWM inverters. Do not use a time-delay-type ground-fault detector.

**If this product is utilized in any facility in which human life is at stake or that may incur material losses, install safety devices so that accidents will not occur even when the output control is disabled due to damage.**

● OPERATIONAL PRECAUTIONS

BE SURE TO READ THE MANUAL BEFORE OPERATING THE PRODUCT.

 <p><b>WARNING</b></p>	<p><b>Never change wiring while power is active.</b> Make sure to turn OFF the power before detaching wires, or disconnecting or connecting the connectors. Failure to observe this caution may result in electric shock or uncontrollable operation.</p> <p><b>Do not touch terminals immediately after turning OFF power.</b></p> <ul style="list-style-type: none"><li>- Even after the power supply is turned OFF, electric charge remains in the driver. To prevent electric shock, perform an inspection upon confirming that the charge voltage monitor LED on the panel is turned OFF after the power is turned off.</li><li>- Make installation of products not easy to touch their inner electric components.</li></ul>
---	---

 <p><b>CAUTION</b></p>	<p><b>Do not make a voltage resistance test.</b></p> <ul style="list-style-type: none"><li>- Do not perform a megger test or voltage resistance test. Failure to observe this caution may result in damage to the control circuit of the driver. Please consult our sales office, if you intent to make a voltage resistance test.</li></ul> <p><b>Do not operate control units by means of power ON/OFF switching.</b></p> <ul style="list-style-type: none"><li>- Frequent power ON/OFF may result in deterioration of internal circuit elements.</li><li>- Start/stop operation should be performed via input signals.</li></ul>
---	---

● DISPOSAL

DISPOSAL OF AN ACTUATOR AND/OR A DRIVER

 <p><b>CAUTION</b></p>	<p><b>All products or parts have to be disposed of as industrial waste.</b> Dispose of these items as industrial waste.</p>
---	---

# Contents

SAFETY GUIDE .....	1
NOTATION.....	1
LIMITATION OF APPLICATIONS.....	1
SAFETY NOTE.....	2
Contents .....	5

## Chapter 1 Overview of the RSF supermini Series

---

1-1 Overview of RSF supermini Series .....	1-1
1-2 Major characteristics .....	1-1
1-3 Ordering information .....	1-2
Actuator Model.....	1-2
1-4 Combinations with drivers.....	1-2
1-5 Specifications of RSF supermini actuators .....	1-4
1-6 External dimensions of actuators.....	1-6
1-7 One-way positioning accuracy .....	1-8
1-8 Torsional stiffness .....	1-9
1-9 Detector resolution.....	1-10
1-10 Mechanical accuracy .....	1-11
1-11 Allowable load.....	1-12
Allowable radial load and allowable thrust load .....	1-12
Radial load when the operating point is different .....	1-13
1-12 Rotary direction.....	1-14
1-13 Impact resistance.....	1-14
1-14 Vibration resistance .....	1-14
1-15 Operable range.....	1-15
1-16 Cable specifications .....	1-17

## Chapter 2 Selection of the RSF supermini Series

---

2-1 Allowable load moment of inertia .....	2-1
2-2 Variable load inertia .....	2-1
2-3 Verifying loads.....	2-1
2-4 Examining operating status.....	2-2
Examining actuator rotation speed .....	2-2
Calculating and examining load inertia moment .....	2-2
Calculating load torque .....	2-2
Acceleration time and deceleration time .....	2-3

Examining duty .....	2-4
Examining effective torque and average rotational speed .....	2-8
Permissible overloaded time .....	2-9

**Chapter 3 Installing the actuator**

---

3-1 Receiving inspection .....	3-1
3-2 Notice on handling .....	3-2
3-3 Location and installation .....	3-3
Environment of location .....	3-3
Considerations into External Noise .....	3-3
Installation.....	3-4

**Chapter 4 Motor shaft retention brake(RSF-5B)**

---

4-1 Motor shaft retention brake specifications.....	4-1
4-2 Controlling the brake power supply.....	4-2
Using a relay cable (Recommended method).....	4-2
Not using a relay cable .....	4-2

**Chapter 5 Options**

---

5-1 Relay cables .....	5-1
5-2 Relay cable wire bound specifications .....	5-2
5-3 Connectors .....	5-5

**Appendix**

---

A-1 Conversion of unit.....	A-1
A-2 Moment of inertia .....	A-3
1. Calculation formulas for mass and moment of inertia .....	A-3
2. Moment of inertia of circular cylinder .....	A-5





# Chapter 1

## Overview of the RSF supermini Series

---

1-1	Overview of RSF supermini Series .....	1-1
1-2	Major characteristics .....	1-1
1-3	Ordering information .....	1-2
1-4	Combinations with drivers.....	1-2
1-5	Specifications of RSF supermini actuators .....	1-4
1-6	External dimensions of actuators .....	1-6
1-7	One-way positioning accuracy.....	1-8
1-8	Torsional stiffness .....	1-9
1-9	Detector resolution.....	1-10
1-10	Mechanical accuracy.....	1-11
1-11	Allowable load .....	1-12
1-12	Rotary direction.....	1-14
1-13	Impact resistance .....	1-14
1-14	Vibration resistance.....	1-14
1-15	Operable range .....	1-15
1-16	Cable specifications .....	1-17

## 1-1 Overview of RSF supermini Series

The ultra-compact RSF supermini servo actuators utilize zero backlash Harmonic Drive® precision gears, a brushless servo motor and an incremental encoder to deliver precision motion control.

Actuators with an electromagnetic brake are also included in the lineup. They can meet fail-safe requirements of equipment to prevent accidents upon power supply failure.

The RSF supermini series can contribute to downsizing of driving of robot joints, semiconductor/LCD panel manufacturing equipment, machine tools, and other FA equipment. By utilizing its small and high-torque characteristics, it can also be used for small equipment and for research.

## 1-2 Major characteristics

### Small, lightweight, and high-torque

The RSF supermini actuators are the union of Harmonic Drive® gearing with a super-flat AC servomotor. The ultra-compact size allows integration to smaller machines. RSF supermini series actuator outputs have a much higher torque per volume than direct drive motors.

### Standard lineup of actuators with a brake (only RSF-5B)

The standard lineup of AC servo actuators includes the deenergisation operation type actuators with an electromagnetic brake for the first time for this size of actuators.

Fail-safe requirements of equipment can be met to prevent accidents upon power failure without providing any external brake or changing the equipment structure to install a brake.

### Advanced positioning accuracy

Integrated Harmonic Drive® gear for zero backlash and advanced positioning accuracy.

### Stable controllability

By high reduction ratio of speed reducer, stable controllability is gained against change in load inertia moment.

### Wide operation range

The newly developed servo motor features a maximum rotational speed of the motor itself to 10,000rpm, thereby expanding the operational range of the actuator.

## 1-3 Ordering information

Model codes for the RSF supermini series actuators are as follows:

### Actuator Model

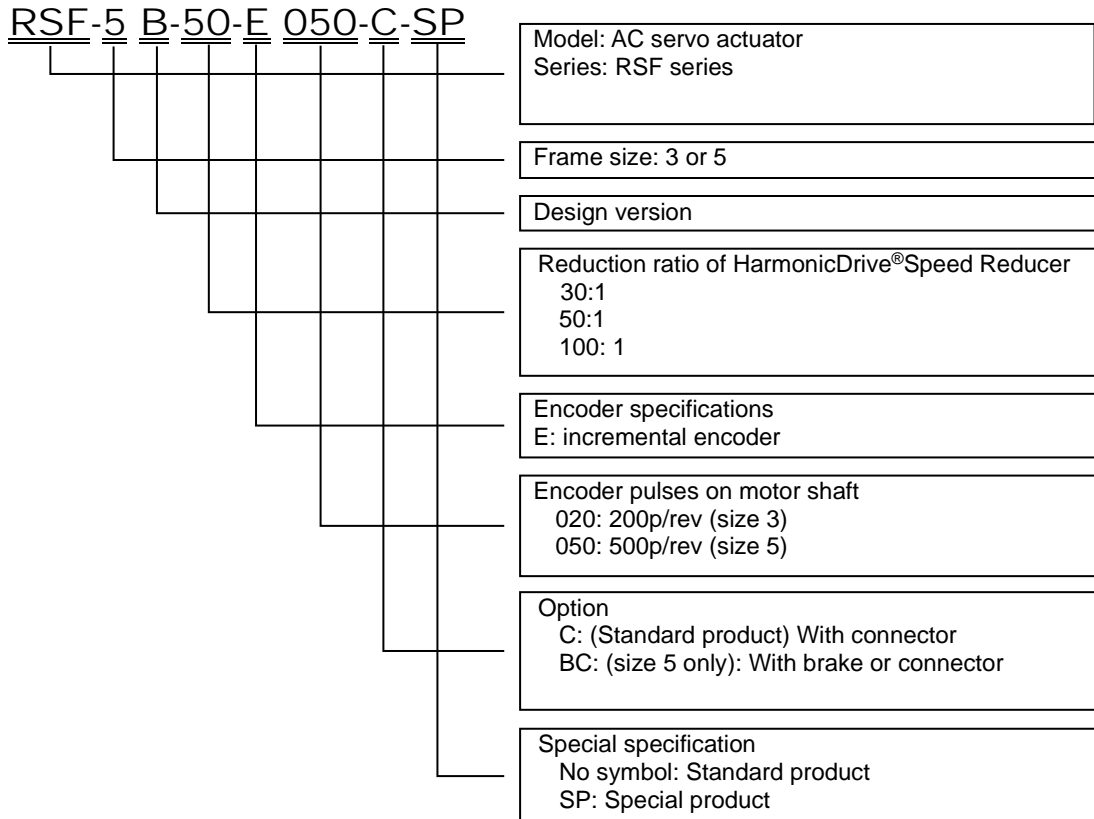

## 1-4 Combinations with drives

The The RSF supermini series actuators can be used in combination with the DCJ, DDP, and HA-680 drives.

- Drives can perform position control, speed control, and torque control.
- For details of the drivers, refer to the “driver manual or data sheet”.
- Extension cables are required for connection between the actuator and the drive.

**1**

**Overview of the RSF supermini series**

# 1-5 Specifications of RSF supermini actuators

Specifications of actuators are as follows:

Time rating:	Continuous	Service temperature:	0~40°C
Excitation method:	Permanent magnet type	Storage temperature:	-20~+60°C
Insulation class:	B	Humidity (Operating/Storage)	20~80%RH (no condensation)
Withstanding voltage:	AC500V/min	Vibration resistance: <sup>Note7</sup>	49m/s <sup>2</sup> (10-400Hz)
Insulation resistance:	DC500V 100MΩ or more	Shock resistance: <sup>Note7</sup>	300m/s <sup>2</sup>
Structure:	Totally enclosed self cooling	Lubricant:	Grease (Harmonic Grease®)

Item	Size	RSF-3C			RSF-5B			
		30	50	100	30	50	100	
Power supply voltage(diver)	V	DC24±10%			DC24±10%			
Allowable continuous current	A <sub>rms</sub>	0.65	0.66	0.56	1.11	0.92	0.76	
Allowable continuous torque (during operation at allowable continuous rotation speed)	Nm	0.03	0.07	0.11	0.18	0.29	0.44	
	kgfcm	0.31	0.68	1.08	1.83	2.95	4.48	
Allowable continuous rotation speed (output shaft)	rpm	150	90	45	150	90	45	
Allowable continuous stall torque	Nm	0.04	0.08	0.12	0.28	0.44	0.65	
	kgfcm	0.41	0.82	1.22	2.85	4.48	6.62	
Instantaneous maximum current	A <sub>rms</sub>	1.5	1.4	1.1	2.3	2.2	1.7	
Max. torque	Nm	0.13	0.21	0.30	0.5	0.9	1.4	
	kgfcm	1.27	2.05	2.94	5.1	9.17	14.3	
Max. speed	rpm	333	200	100	333	200	100	
Torque constant	Nm/A <sub>rms</sub>	0.11	0.18	0.40	0.3	0.54	1.1	
	kgfcm/A	1.12	1.84	4.08	3.06	5.51	11.22	
EMF constant	V/(rpm)	0.015	0.025	0.05	0.04	0.07	0.13	
Phase resistance (at 20°C)	Ω	1.34			0.82			
Phase inductance	mH	0.18			0.27			
Moment of inertia Note 3	GD <sup>2</sup> /4	kgm <sup>2</sup>	0.11×10 <sup>-4</sup>	0.29×10 <sup>-4</sup>	1.17×10 <sup>-4</sup>	0.66×10 <sup>-4</sup> (0.11×10 <sup>-3</sup> )	1.83×10 <sup>-4</sup> (0.31×10 <sup>-3</sup> )	7.31×10 <sup>-4</sup> (1.23×10 <sup>-3</sup> )
	J	kgfcms <sup>2</sup>	1.07×10 <sup>-4</sup>	2.98×10 <sup>-4</sup>	11.90×10 <sup>-4</sup>	0.67×10 <sup>-3</sup> (1.13×10 <sup>-3</sup> )	1.87×10 <sup>-3</sup> (3.15×10 <sup>-3</sup> )	7.45×10 <sup>-3</sup> (12.6×10 <sup>-3</sup> )
Gear ratio		30	50	100	30	50	100	
Allowable radial load (output shaft central value)	N	36			90			
	kgf	3.6			9.1			
Allowable thrust load	N	130			270			
	kgf	13.2			27.5			

Item		Size	RSF-3C			RSF-5B		
			30	50	100	30	50	100
Encoder pulses (motor shaft)		Pulse/	200			500		
Encoder resolution (Output shaft: when multiplied by 4) Note 4		Pulse/Rotation	24,000	40,000	80,000	60,000	100,000	200,000
Motor shaft brake	Input power supply voltage	V	—			DC24±10%		
	Retention torque	Nm	—			0.18	0.29	0.44
		kgfcm	—			1.83	2.95	4.48
Mass Note 5	Without brake	g	31 (except clamp filter)			66 (except clamp filter)		
	With brake	g	—			86 (except clamp filter)		
Recommended drive			HA-680-4B-24			HA-680-4B-24		
			DCJ-055-09, DDP-090-09					

Note 1: The table shows typical output values of actuators.

Note 2: the values in the table above are obtained when it is combined with the combined driver (HA-680-4B-24).

Note 3: Moment of inertia is the total value of the motor shaft and the HarmonicDrive® gear moment of inertia values converted to the output side. The values in parentheses are for model with a brake.

Note 4: The encoder resolution is (motor shaft encoder resolution when multiplied by 4) x (gear ratio).

Note 5: The mass of clamp filter is 6g for each.

Note 6: Refer to "1-13 Vibration resistance" or "1-14 Shock resistance" on page 12 for the test conditions.

# 1-6 External dimensions of actuators

1 Overview of the RSF supermini series

The external drawings are shown as follows:

## RSF-3C-XXX-E020-C

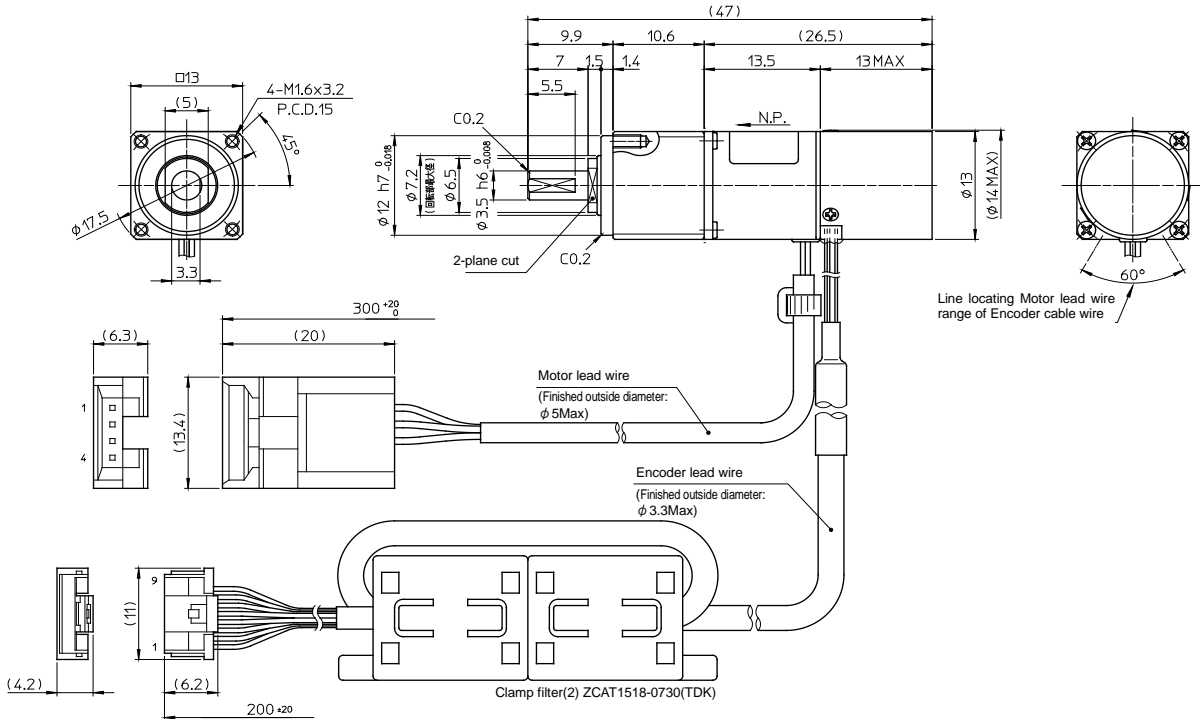

Note) For detailed external dimensions, check the delivery specification drawing issued by us. Tolerances may vary due to product manufacturing method (foundry piece, machine-finished good). If necessary, please contact us for the tolerance when it is not indicated in the dimensions.



RSF-5B-XXX-E050-C

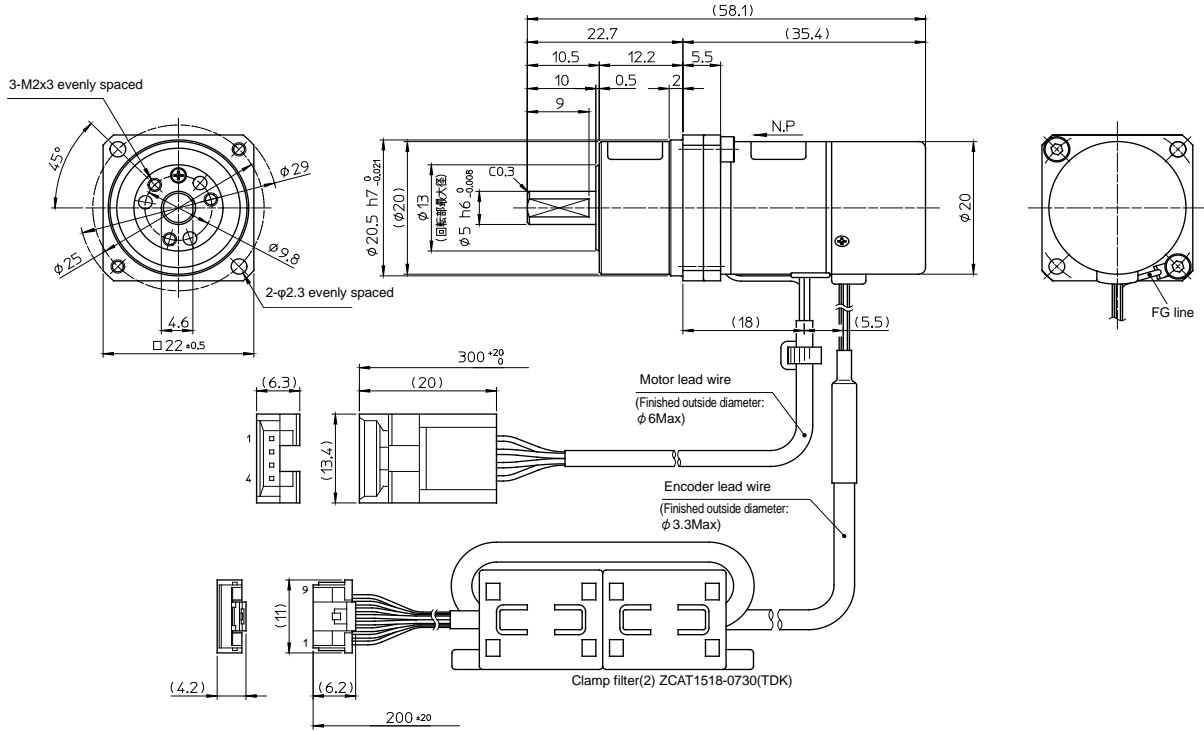

RSF-5B-XXX-E050-BC(with brake)

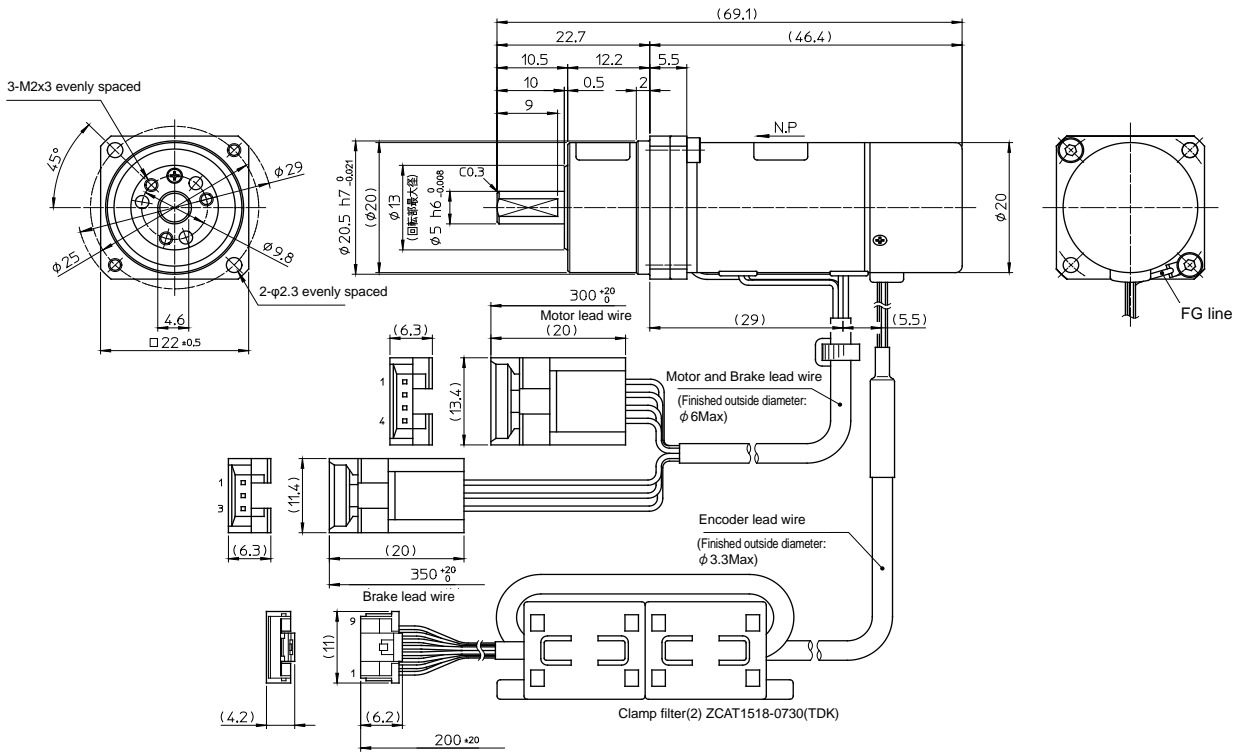

Note) For detailed external dimensions, check the delivery specification drawing issued by us. Tolerances may vary due to product manufacturing method (foundry piece, machine-finished good). If necessary, please contact us for the tolerance when it is not indicated in the dimensions.

# 1-7 One-way positioning accuracy

The following table shows the "one-way positioning accuracy."  
 The "one-way positional accuracy" represents the maximum difference in a single revolution among differences between an angle actually rotated from the datum position and one that is supposed to turn in each position by repeating sequential positioning in a preset rotational direction.  
 The RSF supermini series contains a HarmonicDrive® speed reducer for precision control and positioning errors of the motor shaft are therefore compressed to 30:1, 50:1 or 100:1 by speed reduction. In reality, angular transmission errors of the speed reducer determine the one-way positional accuracy. The measured values of angular transmission errors of the speed reducer are therefore shown as the one-way positional accuracy of the RSF supermini series.

The accuracy for each gear ratio is shown below.

Model		RSF-3C			RSF-5B		
Item	Gear ratio	30	50	100	30	50	100
		One-way positioning accuracy	arc min	10			4
	rad	$2.9 \times 10^{-3}$			$1.20 \times 10^{-3}$	$0.87 \times 10^{-3}$	$0.87 \times 10^{-3}$

**Reference**

(Accuracy display and measurement method according to JIS B 6201: 1987)

- One-way positioning of rotation shaft motion**  
 First, perform positioning at any one position in a fixed direction. This position is the reference position. Next, perform positioning in succession in the same direction, and measure the difference between the angle actually rotated from the reference position and the desired angle at each position. The maximum difference in one rotation among these values is taken as the measurement value. Measurement of equipment with the continuous positioning function for rotational motion shall be done once per 30 degrees or 12 positions throughout the entire rotation range as a rule.

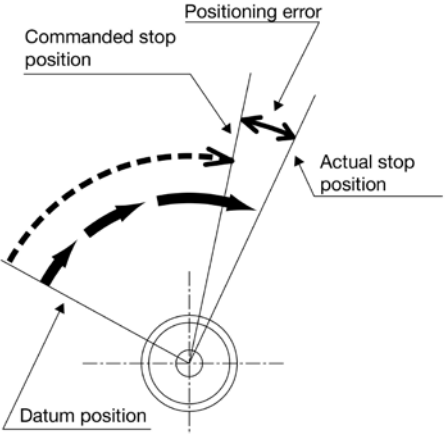

# 1-8 Torsional stiffness

When a torque is applied to the output flange of the actuator with the motor locked, the resulting torsional wind up is near proportional to the torque.

The upper right figure shows the torsional stiffness characteristics of the output flange applying torque starting from zero to plus side [+T<sub>0</sub>] and minus side [-T<sub>0</sub>]. This trajectory is called torque-torsion characteristics which typically follows a loop 0→A→B→A'→B'→A as illustrated. The torsional stiffness of the RSF supermini actuator is expressed by the slope of the curve that is a spring rate (wind-up) (unit:N·m/rad).

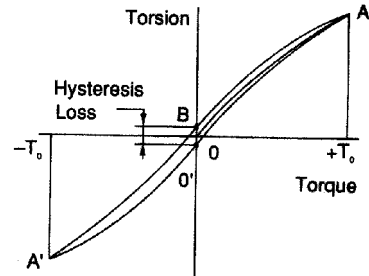

The torsional stiffness may be evaluated by dividing torque-torsion characteristics curve into three major regions. The spring rate of each region is expressed K<sub>1</sub>, K<sub>2</sub>, and K<sub>3</sub> respectively.

- K<sub>1</sub>: spring rate for torque region 0-T<sub>1</sub>
- K<sub>2</sub>: spring rate for torque region T<sub>1</sub>-T<sub>2</sub>
- K<sub>3</sub>: spring rate for torque region over T<sub>2</sub>

The wind-up for each region is expressed as follows:

- wind-up for torque region 0-T<sub>1</sub>:  $\varphi = \frac{T}{K_1}$
- wind-up for torque region T<sub>1</sub>-T<sub>2</sub>:  $\varphi = \theta_1 + \frac{T - T_1}{K_2}$
- wind-up for torque region over T<sub>2</sub>:  $\varphi = \theta_2 + \frac{T - T_2}{K_3}$

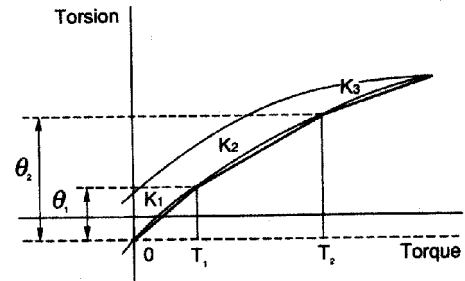

The following table shows average values of T<sub>1</sub> through T<sub>3</sub>, K<sub>1</sub> through K<sub>3</sub>, and θ<sub>1</sub> through θ<sub>2</sub> for different gear ratios.

Model		RSF-3C			RSF-5B		
Gear ratio		30	50	100	30	50	100
Symbol							
T <sub>1</sub>	Nm	0.016	0.016	0.016	0.075	0.075	0.075
	kgfm	0.0016	0.0016	0.0016	0.0077	0.0077	0.0077
K <sub>1</sub>	Nm/rad	27	30	34	90	110	150
	kgfm/arc min	0.0008	0.0009	0.0010	0.003	0.003	0.004
θ <sub>1</sub>	x10 <sup>-4</sup> rad	5.9	5.3	4.7	8.7	6.9	5
	arc min	2.0	1.8	1.6	3	2.4	1.7
T <sub>2</sub>	Nm	0.05	0.05	0.05	0.22	0.22	0.22
	kgfm	0.005	0.005	0.005	0.022	0.022	0.022
K <sub>2</sub>	Nm/rad	40	47	54	110	140	180
	kgf m/arc min	0.0012	0.0014	0.0016	0.003	0.004	0.005
θ <sub>2</sub>	x10 <sup>-4</sup> rad	12.5	10.6	9.3	22	18	13
	arc min	4.2	3.6	3.1	7.5	6	4.4
K <sub>3</sub>	Nm/rad	51	57	67	120	170	200
	kgfm/arc min	0.0015	0.0017	0.0020	0.004	0.005	0.006

## 1-9 Detector resolution

An encoder with 200 pulses for RSF-3C, 500 pulses for RSF-5B per rotation is incorporated in the motor unit of the RSF supermini series actuators, and the motor output is decelerated by 30:1, 50:1, or 100:1 by the Harmonic Drive® speed reducer. Therefore, the resolution per one rotation of the actuator output shaft is 30, 50, or 100 times of the actual encoder resolution. In addition, the encoder signal is electrically multiplied by 4.

The following table shows the resolution at the output shaft for different gear ratios.

Model		RSF-3C			RSF-5B		
Gear ratio		30	50	100	30	50	100
Item							
Detector resolution (when multiplied by 4)	Pulse/Rotation	24,000	40,000	80,000	60,000	100,000	200,000
Angle per one pulse	Angle second (arc sec)	54	32.4	16.2	21.6	12.96	6.48

# 1-10 Mechanical accuracy

The machining accuracy of the output flange and the mounting flange of RSF supermini actuators are indicated in the table below.

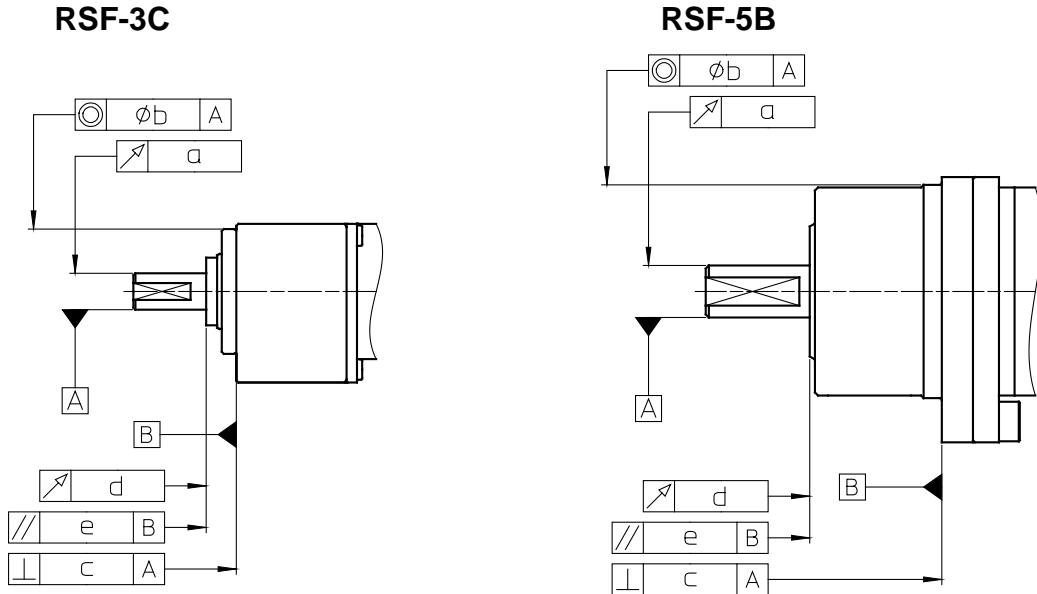

Machined accuracy of the output flange

\* T.I.R. unit: mm

Symbol Model	Machined parts	Accuracy value	
		RSF-3C	RSF-5B
a	Runout of the tip of the output shaft	0.03	0.03
b	Concentricity of installed spigot joint	0.02	0.04
c	Squareness of installation surface	0.02	0.02
d	Output flange surface contact	0.005	0.005
e	Parallelism of installation surface and output flange	0.015	0.015

\*) T.I.R(Total Indicator Reading): Indicates the total amount of dial gage reading when the measurement unit is rotated once.

# 1-11 Allowable load

1

Overview of the RSF supermini series

## Allowable radial load and allowable thrust load

The gear head used in the RSF supermini series incorporates the high-precision 4-point contact ball bearing for direct support of external load (output part).

The allowable radial load and thrust load of the output shaft are shown below.

The allowable radial load  $F_r$  is obtained with respect to the center ( $L/2$ ) 0 point of the output shaft.

The values in the following table are designed by considering the life of the bearing.

The allowable values must not be exceeded.

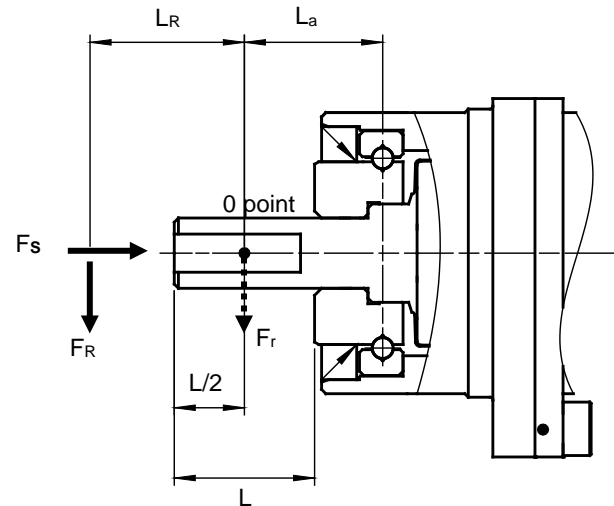

Model	Unit	RSF-3C	RSF-5B
Allowable radial load ( $F_r$ )	N	36	90
	kgf	3.6	9.1
Allowable thrust load ( $F_s$ )	N	130	270
	kgf	13	27

## Radial load when the operating point is different

If the operating point of radial load is different, the allowable radial load value is also different. The relation between radial load position  $L_R$  and allowable radial value  $F_R$  is obtained from the following formula.

The allowable values must not be exceeded.

$$F_R = \frac{L_a}{L_a + L_R} F_r$$

$F_R$	Allowable radial load at distance $L_R$ from the 0 point [N]
$F_r$	Allowable radial load at the 0 point [N]
$L_a$	Distance from the bearing starting point to the 0 point [mm]
$L_R$	Distance from the position where radial load is exerted to the 0 point [mm]
$L$	Shaft length [mm]

Model		RSF-3C	RSF-5B
Allowable radial load ( $F_r$ )	N	36	90
	kgf	3.6	9.1
$L_a$	mm	8.6	9.85
$L$	mm	7	10

## 1-12 Rotary direction

The rotary direction of the RSF supermini series actuators when a forward rotation command is given from the HA-680 driver is forward rotation seen from the output shaft side (i.e. clockwise: CW).

The rotary direction of the HA-680 can be switched by using the Parameter → “20: Rotary direction command” setting.

“20: Rotary direction command” setting

Value	FWD command	REV command	Setting
0	FWD rotation	REV rotation	Default
1	REV rotation	FWD rotation	

\* The model shape is RSF-5B. RSF-3C is also the same.

\* For details of the driver, refer to “AC Servo Driver HA-680 Series Technical Data.”

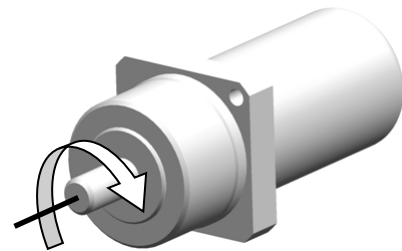

FWD: CW rotation

## 1-13 Impact resistance

The impact resistance of the actuators is as follows.

Impact acceleration: 300 m/s<sup>2</sup>

Direction: top/bottom, right/left, front/back

Repeating times: three

However, do not apply impact to the output shaft.

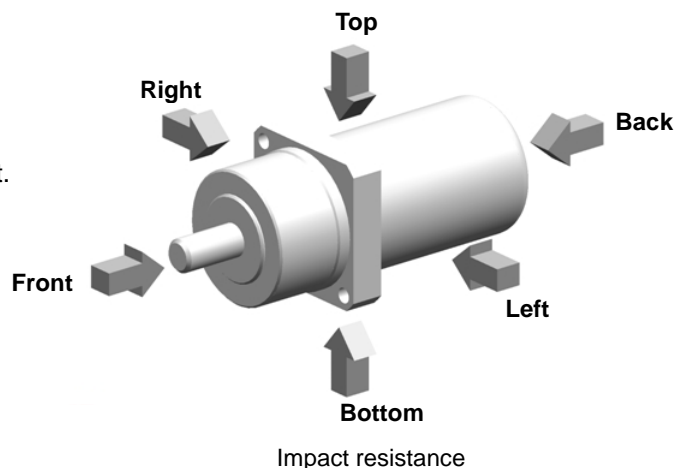

## 1-14 Vibration resistance

The vibration resistance of the actuators for up/down, left/right, and front/back is as follows.

Vibration acceleration: 49m/s<sup>2</sup> (5G)

Frequency: 10 to 400Hz

This specification does not guarantee fretting wear of mechanism components due to micro vibrations.

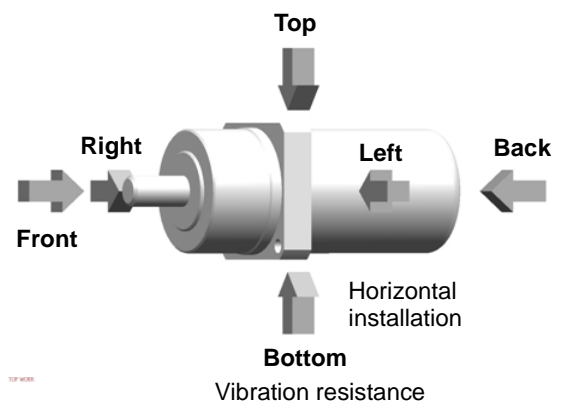



# 1-15 Operating range

The following graphs show the operating ranges of the RSF supermini series actuators.

- (1) **Continuous Motion Range** The range allows continuous operation for the actuator.
- (2) **50% Duty Motion Range** This range indicates the torque rotation speed which is operating in the 50% duty operation (the ratio of operating time and delay time is 50:50).
- (3) **Motion Range During Acceleration and Deceleration** This range indicates the torque rotation speed which is operating momentarily. The range allows instantaneous operation as is typical during acceleration and deceleration. The continuous and 50% duty motion ranges shown on each graph are measured on the condition where the radiation plate specified in the graph is installed.

## RSF-3C-30-E020-C

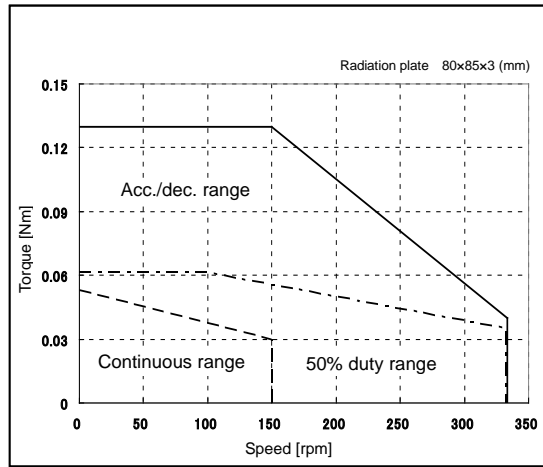

## RSF-3C -50-E020-C

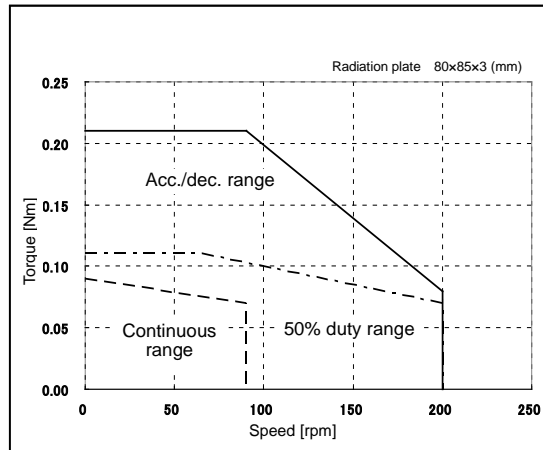

## RSF-3C -100-E020-C

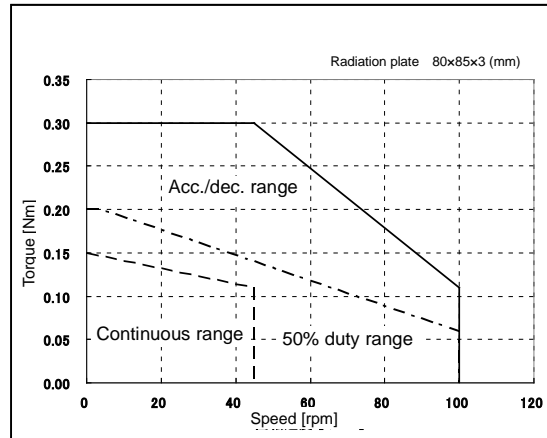

Note: The values of the graph are obtained when the heatsink shown at the upper right of the graph is installed.

Note: If it is used continuously in one direction, please consult with us.

**RSF-5B-30-US050-C, RSF-5B-30-US050-BC**

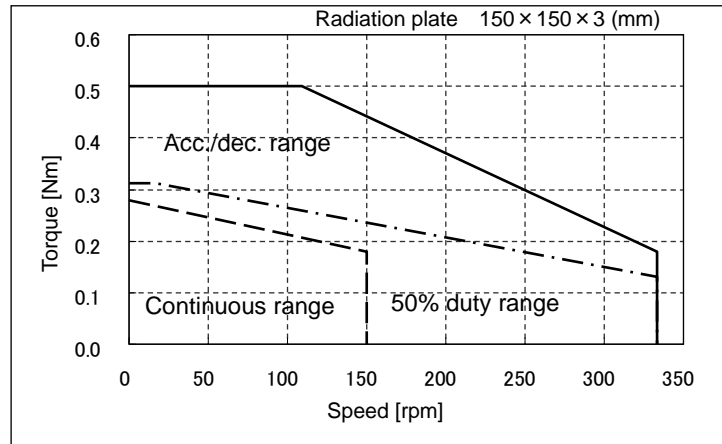

**RSF-5B-50-US050-C, RSF-5B-50-US050-BC**

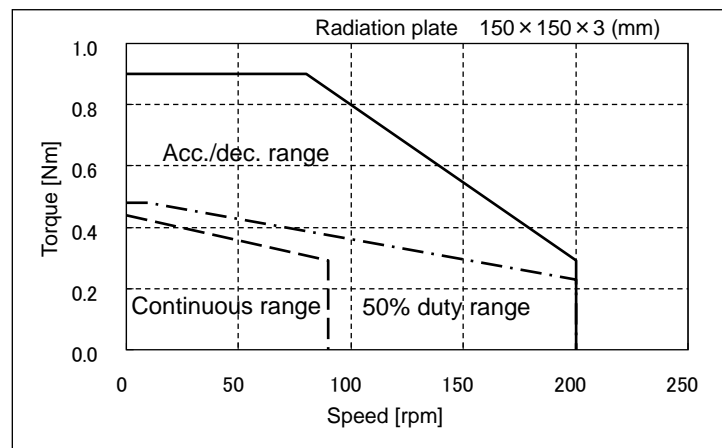

**RSF-5B-100-US050-C, RSF-5B-100-US050-BC**

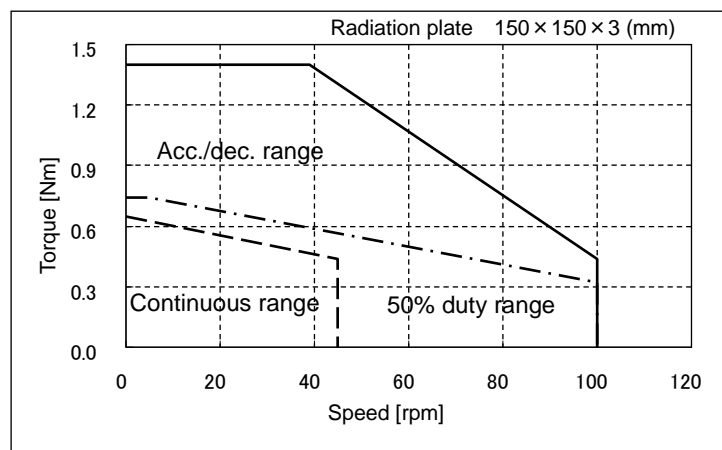

Note: The values of the graph are obtained when the heatsink shown at the upper right of the graph is installed.  
 Note: Even in the continuous range, if it is used continuously in one direction, please consult with us.

# 1-16 Cable specifications

The following tables show specifications of motor lead wires, brake lead wires and encoder lead wires of the RSF supermini actuators.

## Motor cable

Pin No.	Color	Signal name	Remark
1	Red (RED)	U	Motor phase-U
2	White (WHT)	V	Motor phase-V
3	Black (BLK)	W	Motor phase-W
4	Green <sup>1</sup> (GRN)	FG	Grounding *RSF-5B only

1: Green/yellow tubes are attached in the vicinity of the connector.

Connector used	Housing:	PALR-04VF (with retainer)
	Contact:	S(B)PAL-001T-P0.5
Recommended connector	Housing:	PARP-04V (with retainer)
	Contact:	S(B)PA-001T-P0.5

Manufactured by J.S.T. Mfg Co., Ltd

## Brake lead wire

Pin No.	Line color
1	Blue (BLU)
2	Yellow (YEL)
3	Gray (GRY)

Connector used	Housing:	PALR-03VF (with retainer)
	Contact:	S(B)PAL-001T-P0.5
Recommended connector	Housing:	PARP-03V (with retainer)
	Contact:	S(B)PA-001T-P0.5

Manufactured by J.S.T. Mfg Co., Ltd

## Encoder lead wire

Pin No.	Color	Signal name	Remark
1	White (WHT)	A	A phase output
2	Green (GRN)	B	B phase output
3	Yellow (YEL)	Z	Z phase output
4	Brown (BRW)	U	U phase output
5	Blue (BLU)	V	V phase output
6	Orange (ORG)	W	W phase output
7	Red (RED)	+5V	Power supply input
8	Black (BLK)	GND	Power supply input
9			

Connector used	Housing:	NSHR-09V-S
	Terminal:	SSHL-003T-P0.2

Manufactured by J.S.T. Mfg Co., Ltd





# Chapter 2

## Selection of the RSF supermini Series

---

This chapter explains how to select a proper RSF supermini series actuator.

---

2-1	Allowable load moment of inertia.....	2-1
2-2	Variable load inertia.....	2-1
2-3	Verifying loads .....	2-1
2-4	Examining operating status.....	2-2

## 2-1 Allowable load moment of inertia

To make full use of high precision and high performance of the RSF supermini series actuator, perform temporary selection by considering the load moment of inertia and rotation speed.

As a guideline, the load moment of inertia should be 3 to 5 times the moment of inertia of the actuator. For the moment of inertia of the actuator, refer to [1-5 Specifications of RSF supermini actuators] (P1-4).

For the method of calculating moment of inertia, refer to [Appendix 2 Moment of inertia] (Page A-3).

The rotation speed cannot exceed the maximum rotation speed of the actuator. For the maximum rotation speed, refer to [1-5 Specifications of RSF supermini actuators] (P1-4).

## 2-2 Variable load inertia

RSF supermini series actuators include HarmonicDrive® gearing that has a high reduction ratio. Because of this there are minimal effects of variable load moment of inertias to the servo drive system. In comparison to direct servo systems this benefit will drive the load with a better servo response.

For example, assume that the load moment of inertia increases to N-times during its motion (for example, robot arms). The effect of the variable load moment of inertia to the [total inertia converted into motor shaft] is as follows:

The symbols in the formulas are:

<b>J<sub>s</sub></b> :	total moment of inertia converted into motor shaft	<b>L</b> :	Ratio of load moment of inertia to motor inertia
<b>J<sub>M</sub></b> :	moment inertia of motor		
<b>R</b> :	reduction ratio of RSF supermini series	<b>N</b> :	variation ratio of load moment of inertia

- Direct drive

$$\text{Before: } J_s = J_M(1+L) \quad \text{After: } J_s' = J_M(1+NL) \quad \text{Ratio: } J_s'/J_s = \frac{1+NL}{1+L}$$

- RSF supermini actuator drive

$$\text{Before: } J_s = J_M \left( 1 + \frac{L}{R^2} \right) \quad \text{After: } J_s' = J_M \left( 1 + \frac{NL}{R^2} \right) \quad \text{Ratio: } J_s'/J_s = \frac{1+NL/R^2}{1+L/R^2}$$

In the case of the RSF supermini series, this is an extremely large number, such as  $R = 30$ ,  $R = 50$  or  $R = 100$ , that is  $R^2 = 900$ ,  $R^2 = 2500$ , or  $R^2 = 10000$ . The ratio is  $J_s'/J_s \cong 1$ . This means that drive systems are hardly affected by the load moment of inertia variation. Therefore, it is not necessary to take the load moment of inertia variation in consideration for selecting an RSF supermini actuator or for setting up the HA-680 driver.

## 2-3 Verifying loads

The RSF supermini series incorporates a precision 4-point contact ball bearing for direct support of external load. To make full use of the performance of the RSF supermini series, check the maximum load moment, life of the 4-point contact ball bearing, and static safety factor.

For detailed calculation methods for the maximum load moment, life of the 4-point contact ball bearing, and static safety factor, refer to the "HarmonicDrive® CSF Mini series" catalogue.

## 2-4 Duty Cycles

When the operation pattern (duty cycle) is such that the actuator starts and stops repeatedly, starting current and braking current flow through the motor at high frequency and the actuator generates heat. Accordingly, examine whether or not the generated heat can be accommodated. The study is as follows:

### Actuator speed

Calculate the required RSF supermini actuator speed (r/min) to drive the load.

For linear motion, convert with the formula below:

$$\text{Rotary speed (r/min)} = \frac{\text{Liner speed (mm/min)}}{\text{Pitch of screw(mm)}}$$

Select a reduction ratio from [30], [50] and [100] of an RSF supermini actuator of which the maximum speed is more than the required speed.

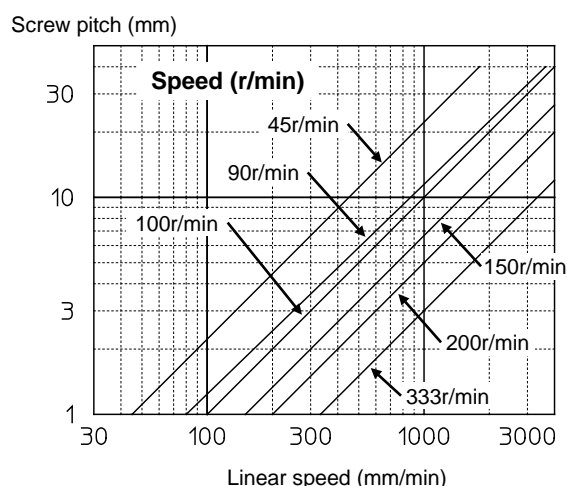

### Load moment of inertia

Calculate the load moment of inertia driven by the RSF supermini series actuator.

For the calculation methods, refer to [Appendix 1 Conversion of unit] (Page A-1).

Tentatively select an RSF supermini actuator referring to section [2-1 Allowable load moment of inertia] (P2-1) with the calculated value.

### Calculating load torque

Calculate the load torque as follows:

- Rotary motion

The torque for the rotating mass [W] on the friction ring of radius [r] as shown in the figure to the right.

$$T = 9.8 \times \mu \times W \times r$$

- T:** torque (N·m)
- $\mu$ :** coefficient of friction
- W:** mass (kg)
- r:** radius of friction face (m)

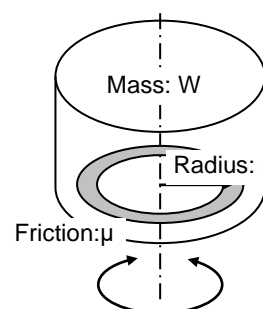



● Horizontal linear motion

The following formula calculates the torque for horizontal linear motion of mass [W] fed by the screw of pitch [P].

$$T = 9.8 \times \mu \times W \times \frac{P}{2 \times \pi}$$

- T:** torque (N·m)
- μ:** coefficient of friction
- W:** mass (kg)
- P:** screw pitch (m)

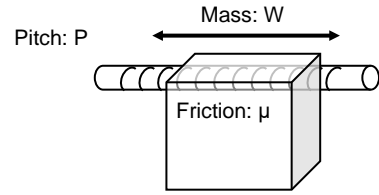

● Vertical linear motion

The following formula calculates the torque for vertical linear motion of mass [W] fed by the screw of pitch [P].

$$T = 9.8 \times W \times \frac{P}{2 \times \pi}$$

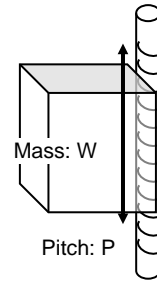

## Acceleration time and deceleration time

The fastest acceleration and deceleration times with the selected actuator can be calculated using the following formula.

Acceleration:  $t_a = (J_A + J_L) \times \frac{2 \times \pi}{60} \times \frac{N}{T_M - T_L}$  (1)

Deceleration:  $t_d = (J_A + J_L) \times \frac{2 \times \pi}{60} \times \frac{N}{T_M + 2 \times T_F - T_L}$  (2)

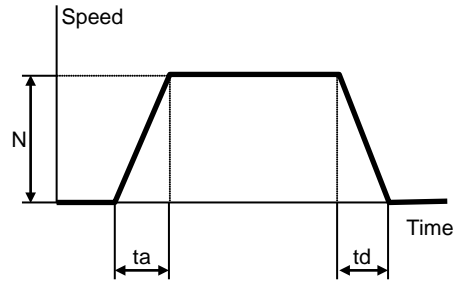

- ta:** acceleration time (sec)
- td:** deceleration time (sec)
- JA:** actuator inertia (kg·m<sup>2</sup>)
- JL:** load moment of inertia (kg·m<sup>2</sup>)
- N:** actuator speed (r/min)
- TM:** maximum torque of actuator (N·m)
- TL:** load torque (N·m)

For polarity, the rotation direction is set to positive (+), and the opposite direction is set to negative (-).

The friction torque of the actuator  $T_F$  (N·m) can also be obtained from the following formula:

$$T_F = K_T \times I_M - T_M$$
 (3)

- KT** : Torque constant [N·m/A]
- IM** : Maximum current [A]

**Example: 1**

Select an actuator that best suits the following operating conditions:

Rotary speed: 140r/min

Load moment of inertia:  $0.9 \times 10^{-3} \text{ kg} \cdot \text{m}^2$

Since the load mechanism is mainly inertia, the load torque is negligibly small.

Acceleration/deceleration time is 0.03sec (30msec) or less.

- (1) Compare these conditions with the [1-5 Specifications of RSF supermini actuators] (P1-4) and temporarily select RSF-5B-50.
- (2) Obtain  $J_A = 1.83 \times 10^{-4} \text{ kg} \cdot \text{m}^2$ ,  $T_M = 0.9 \text{ N} \cdot \text{m}$ ,  $K_T = 0.54 \text{ N} \cdot \text{m/A}$ , and  $I_M = 2.2 \text{ A}$  from [1-5 Specifications of RSF supermini actuators] (P1-4).
- (3) The friction torque of the actuator is  $T_F = 0.54 \times 2.2 - 0.9 = 0.29 \text{ N} \cdot \text{m}$  from Formula (3) on the previous page.
- (4) Therefore, the shortest acceleration time and deceleration time can be obtained from Formula (1) and Formula (2), as follows:

$$t_a = (0.183 \times 10^{-3} + 0.9 \times 10^{-3}) \times 2 \times \pi / 60 \times 140 / 0.9 = 0.018 \text{ sec (18msec)}$$

$$t_d = (0.183 \times 10^{-3} + 0.9 \times 10^{-3}) \times 2 \times \pi / 60 \times 140 / (0.9 + 2 \times 0.29) = 0.011 \text{ s (11msec)}$$

- (5) Because the assumed acceleration/deceleration time is 0.03sec (30msec) or less, the temporarily selected actuator can be used for acceleration/deceleration, based on the result of (4).
- (6) If the calculation results of the acceleration/deceleration time do not fall within the desired time range, examine them again as follows.
  - Try to reduce the load moment of inertia.
  - Re-examine the gear ratio and gear head model.

## Calculating equivalent duty

During the selecting process of the RSF supermini series, the temporal variability of torque and rotation speed need to be taken into account. During acceleration or deceleration in particular, a large amount of electricity flows to generate a large amount of torque, resulting in a greater amount of heat.

Using the following formula, calculate the duty: %ED when the actuator is operated repeatedly in the drive pattern shown to the right.

$$\%ED = \frac{K_{La} \times t_a + K_{Lr} \times t_r + K_{Ld} \times t_d}{t} \times 100 \quad (4)$$

- t<sub>a</sub>**: Acceleration time from speed 0 to N [s]  
**t<sub>d</sub>**: Deceleration time from speed N to 0 [s]  
**t<sub>r</sub>**: Operating time at a constant speed of N [s]  
**t**: single cycle time in second [s]  
**K<sub>La</sub>**: duty factor for acceleration time  
**K<sub>Lr</sub>**: duty factor for driving time  
**K<sub>Ld</sub>**: duty factor for deceleration time

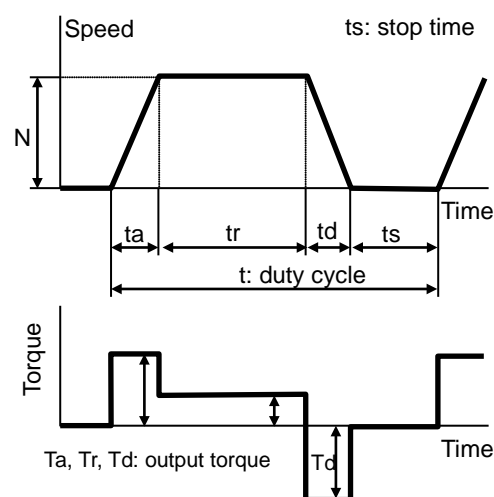

## How to obtain $K_{La}$ , $K_{Lr}$ and $K_{Ld}$ and example of duty calculation 2

As a result of Calculation Example 1 shown below, the selected actuator RSF-5B-50 works fine, so RSF-5B-50 can be used for duty factor graphs.

Operation conditions:

- The inertial load is accelerated at the maximum torque of the actuator, and decelerated at the maximum torque after operation at a fixed speed.
- The movement angle  $\theta$  of one cycle is  $120^\circ$ .
- The duration of one cycle is 0.4 (s).
- The other conditions are the same as Calculation Example 1.

- (1)  $K_{La}$  and  $K_{Ld}$ : The average speed during the rotation speed change from 0 to 140r/min is 70r/min. From the duty factor graphs,  $K_{La}=K_{Ld}\approx 1.5$  can be obtained.
- (2)  $K_{Lr}$ :  $Tr\approx 0$  for the inertial load. Similarly, from the duty factor graphs,  $K_{Lr}\approx 0.29$  can be read.
- (3) The movement angle can be obtained from the area in the "Rotation speed-Time" diagram above. In other words, the movement angle  $\theta$  can be expressed as follows:

$$\theta = (N / 60) \times \{tr + (ta + td) / 2\} \times 360$$

Solving the formula above for  $tr$  (operation time at a fixed speed of  $N$ ), the following can be obtained.

$$tr = \theta / (6 \times N) - (ta + td) / 2$$

Substituting  $\theta = 120^\circ$  and  $ta = 0.03(s)$ ,  $td = 0.03(s)$ , and  $N = 140r/min$  from Example 1,  $tr = 0.113(s)$ .

- (4) Because the cycle time is 0.4(s), the %ED is obtained as follows:

$$\%ED = (1.5 \times 0.03 + 0.29 \times 0.113 + 1.5 \times 0.03) / 0.4 \times 100 = 30.7\%$$

Because the value of %ED obtained is below 100, continuous repeated operation of this cycle can be done.

If this value is 100 or above,

- Operation pattern
  - Load reduction
- must be reexamined.

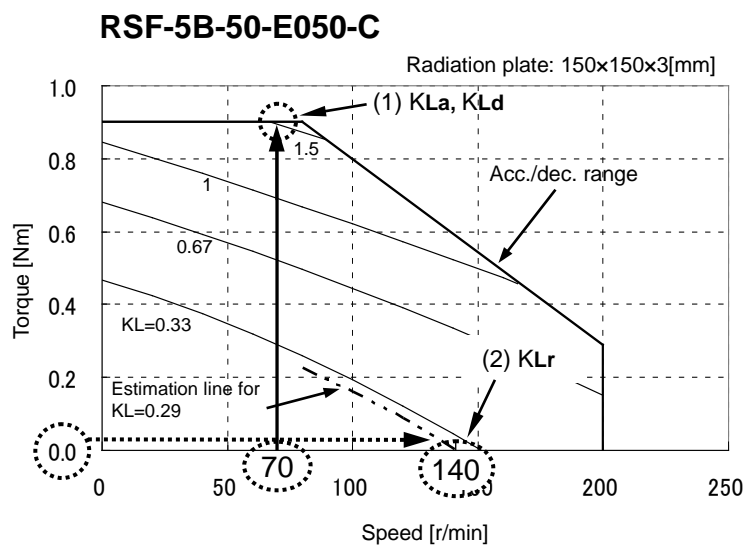

Graphs of duty factor

● RSF-3C-30-E020-C

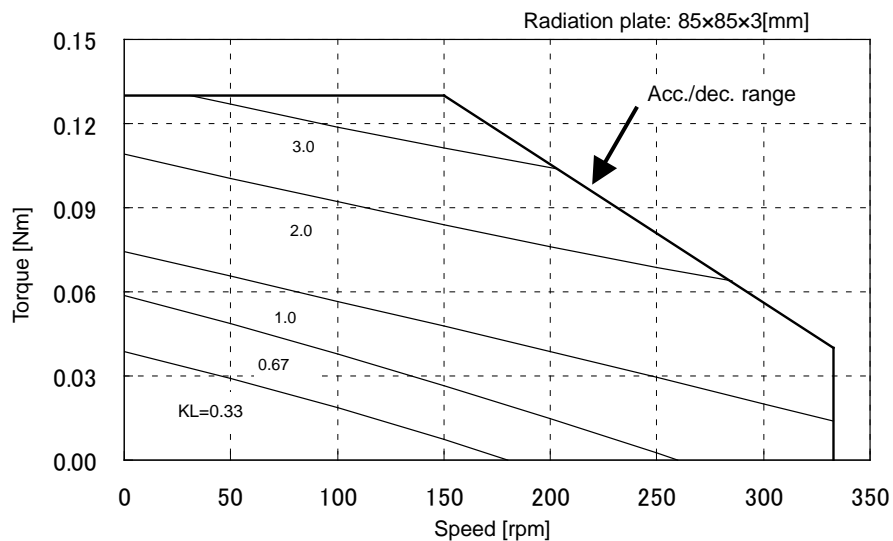

● RSF-3C-50-E020-C

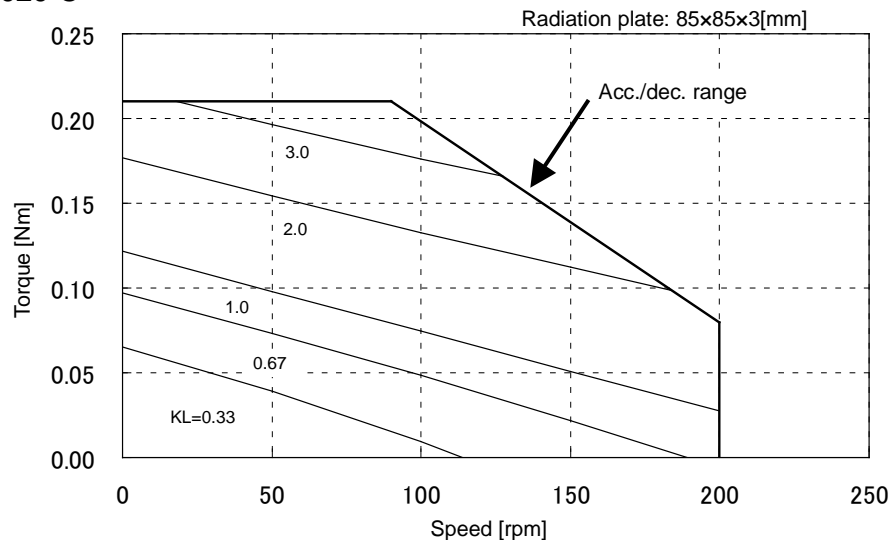

● RSF-3C-100-E020-C

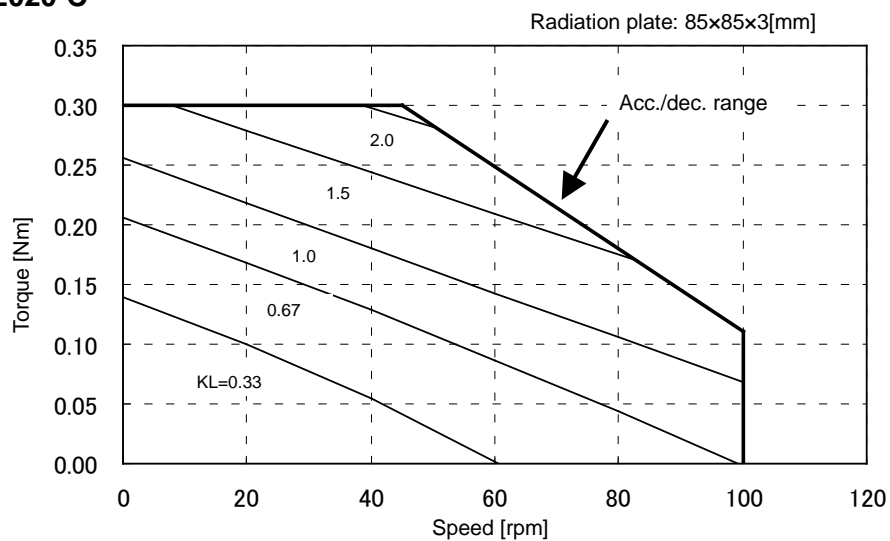

● **RSF-5B-30-E050-C**

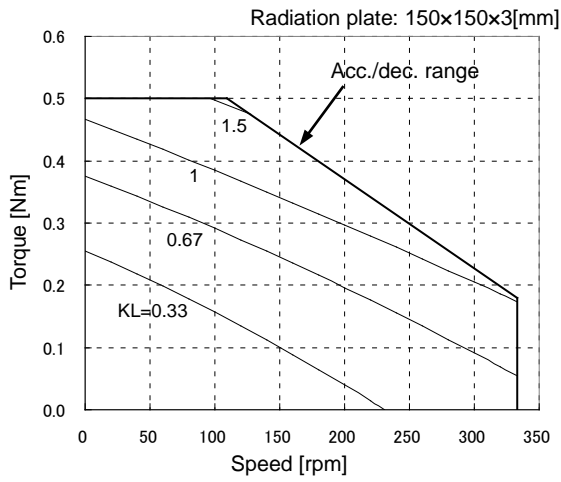

● **RSF-5B-30-E050-BC**

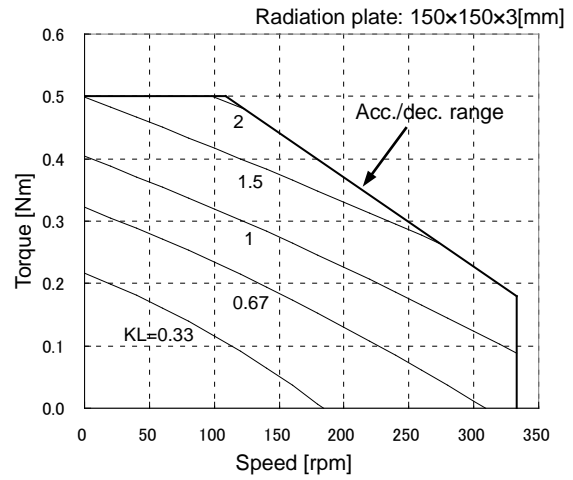

● **RSF-5B-50-E050-C**

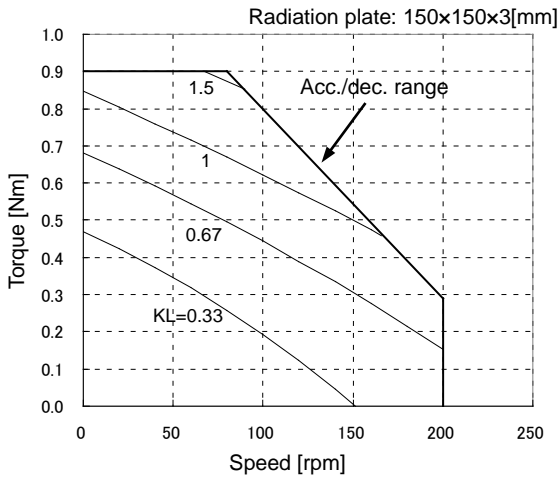

● **RSF-5B-50-E050-BC**

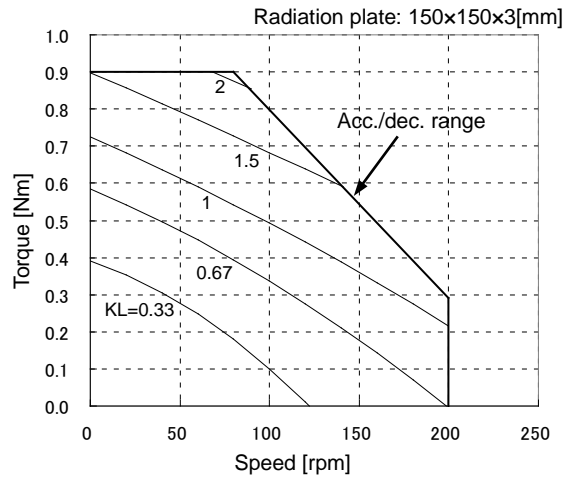

● **RSF-5B-100-E050-C**

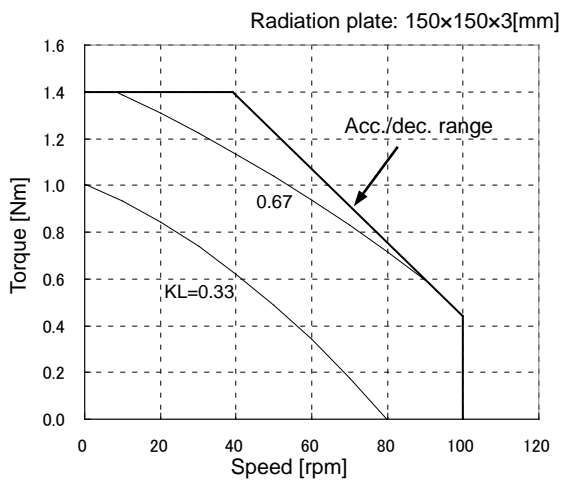

● **RSF-5B-100-E050-BC**

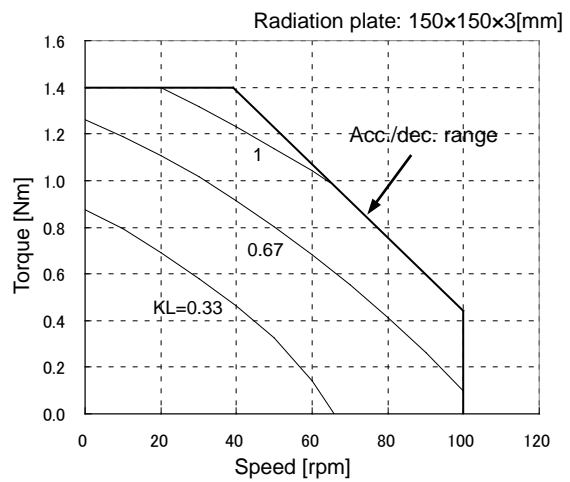

## Examining effective torque and average rotational speed

Additionally to the former studies, the effective torque and the average speed should be studied.

- (1) The effective torque should be less than allowable continuous torque specified by the driver.
- (2) The average speed should be less than allowable continuous speed of the actuator.

Calculate the effective torque ( $T_m$ ) and the average speed of an operating cycle ( $N_{av}$ ) as shown in [Calculating equivalent duty] (P2-4).

$$T_m = \sqrt{\frac{T_a^2 \times (t_a + t_d) + T_r^2 \times t_r}{t}}$$

$$N_{av} = \frac{\frac{N}{2} \times t_a + N \times t_r + \frac{N}{2} \times t_d}{t}$$

<b>T<sub>m</sub>:</b>	effective torque	(N·m)		
<b>T<sub>a</sub>:</b>	maximum torque	(N·m)		
<b>T<sub>r</sub>:</b>	load torque	(N·m)		
<b>t<sub>a</sub>:</b>	acceleration time	(s)	<b>t<sub>d</sub>:</b>	deceleration time (s)
<b>t<sub>r</sub>:</b>	running time at constant speed	(s)	<b>t:</b>	time for one duty cycle
<b>N<sub>av</sub>:</b>	average speed	(r/min)		
<b>N:</b>	driving speed	(r/min)		

If the calculation results for the effective torque and average rotation speed are not within the range of continuous usage in the graph shown in [1-15 Operable range] (P1-15) take measures to reduce the duty.

### Example 3: getting effective torque and average speed

Effective torque and average speed are studied by using the operation conditions of Example 1 and 2.

#### 1) Effective torque

From the parameters of  $T_a = 8.3 \text{ N}\cdot\text{m}$ ,  $T_r = 0 \text{ N}\cdot\text{m}$ ,  $t_a = 0.113 \text{ s}$ ,  $t_r = t_d = 0.03 \text{ s}$ ,  $t = 0.4 \text{ s}$ ,

$$T_m = \sqrt{\frac{0.9^2 \times (0.03 + 0.03)}{0.4}} = 0.349 \text{ N}\cdot\text{m}$$

The value exceeds the allowable continuous torque ( $0.29 \text{ N}\cdot\text{m}$ ) of RSF-5B-50 temporarily selected in Example 1, so continuous operation cannot be done using the cycle set in Example 2. The following formula is the formula for effective torque solved for  $t$ . By substituting the value of allowable continuous torque in  $T_m$  of this formula, the allowable value for one cycle time can be obtained.

$$t = \frac{T_a^2 \times (t_a + t_d) + T_r^2 \times t_r}{T_m^2}$$

Substituting  $0.9 \text{ N}\cdot\text{m}$  for  $T_a$ ,  $0 \text{ N}\cdot\text{m}$  for  $T_r$ ,  $0.349 \text{ N}\cdot\text{m}$  for  $T_m$ ,  $0.03 \text{ s}$  for  $t_a$ ,  $0.113 \text{ s}$  for  $t_r$ , and  $0.03 \text{ s}$  for  $t_d$ :

$$t = \frac{0.9^2 \times (0.03 + 0.03)}{0.29^2} = 0.578 \text{ [s]}$$

Namely, when the time for one duty cycle is set more than  $0.578 \text{ s}$ , the effective torque [ $T_m$ ] becomes less than  $0.29 \text{ N}\cdot\text{m}$ , and the actuator can drive the load with lower torque than the continuous torque continuously.

2) Average speed

From the parameters of  $N = 140 \text{ r/min}$ ,  $t_a = 0.03 \text{ s}$ ,  $t_r = 0.113 \text{ s}$ ,  $t_d = 0.03 \text{ s}$ ,  $t = 0.4 \text{ s}$

$$N_{av} = \frac{140/2 \times 0.03 + 140 \times 0.113 + 140/2 \times 0.03}{0.578} = 34.64 \text{ [r/min]}$$

As the speed is less than the continuous speed (90 r/min) of RSF-5B-50, it is possible to drive it continuously on new duty cycle.

### Permissible overloaded time

In case RSF supermini series is intermittently operated in allowable continuous torque or more, the overloaded time is limited by the protective function in the driver even if the duty cycle is allowed. The limits are shown in the figure below.

#### RSF-3C

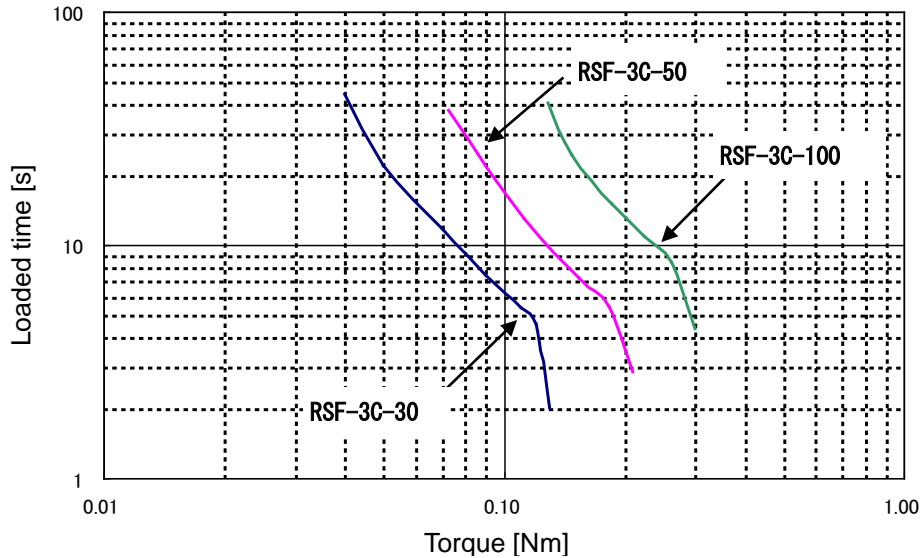

#### RSF-5B

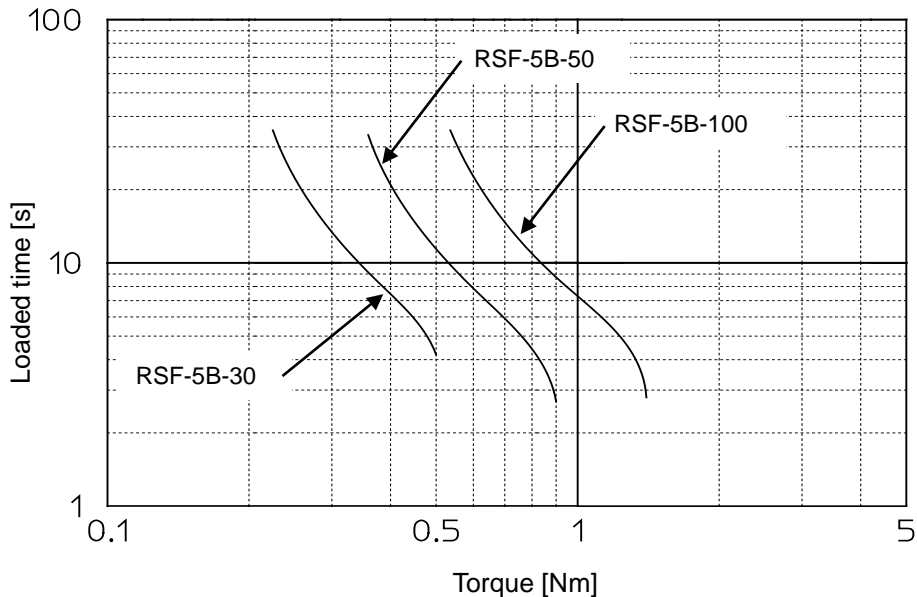

# Chapter 3

## Installing the actuator

---

The following explains the installation procedures of the actuators.

---

3-1	Receiving inspection .....	3-1
3-2	Notice on handling .....	3-2
3-3	Location and installation .....	3-3



## 3-1 Receiving inspection

Check the following when products are received.

- Inspection procedure

- (1) Check the shipping container and item for any damage that may have been caused during transportation. If the item is damaged, immediately report the damage to the dealer it was purchased from.
- (2) A label is attached on the side of the RSF supermini series actuator. Confirm the products you ordered by comparing with the model on the [TYPE] line of the label. If it is different, immediately contact the dealer it was purchased from.  
For details of model symbols, refer to [1-3 Ordering information] (P1-2).
- (3) On the label of the HA-680 driver, the model code of the actuator to be driven is indicated on the [ADJUSTED FOR USE WITH] line. Match the actuator with its driver so as not to confuse the item with the other actuators.



**Only connect the actuator specified on the driver label.**

The drivers have been tuned for the actuator specified on the driver label. Wrong combination of drivers and actuators may cause low torque problems or over current that may cause physical injury and fire.

- (4) The HA-680 driver is for 24VDC supply voltage only. Any power supply voltage other than 24VDC cannot be used.



**Do not connect a supply voltage other than the voltage specified on the label.**

The wrong power supply voltage (other than 24VDC) may damage the driver resulting physical injury and fire.

## 3-2 Notice on handling

Handle the RSF supermini series actuator carefully by observing the notices specified below.



**Do not plug the actuators directly into a commercial line power source.**  
**This could burn out the actuator, potentially resulting in a fire and/or electrical hazard.**



- (1) Do not apply impact or unnecessary excessive force to output flange of actuators.
- (2) Do not put actuators on in a location where the driver could easily fall.
- (3) The allowable temperature for storage is from -20°C to +60°C. Do not expose it to the sunlight for a long time and do not store it in areas with widely fluctuating temperatures.
- (4) The allowable relative humidity for storage is less than 80%. Do not store it in highly humid place or in a place where temperature changes excessively during the course of a day.
- (5) Do not use or store the actuator in locations subject to corrosive gases or dust particles.

## 3-3 Location and installation

### Environment of location

The environmental conditions of the installation location for RSF supermini series actuators must be as follows. Determine an appropriate installation location by observing these conditions without fail.

- Service temperature:0°C to 40°C  
The temperature in the cabinet may be higher than the atmosphere depending on the power loss of housed devices and size of the cabinet. Design the closed space size, ventilation system, and device locations so the ambient temperature near the actuator is always less than 40°C.
- Service humidity:20 to 80% relative humidity, without condensation  
Make sure no water condensation occurs at the place where there is a large temperature change in a day or due to frequent heat-and-cool cycles due to the operation of the actuator.
- Vibration:less than 49m/sec<sup>2</sup> (10Hz~400Hz)
- Impact:less than 300 m/sec<sup>2</sup>
- Make sure the actuator is in an area free from dust, water condensation, metal powder, corrosive gas, water, water drops, and oil mist.
- Locate the driver indoors. Do not expose it to the sunlight.

### Considerations into External Noise

Pay sufficient attention when installing the actuator: The actuator may malfunction by external noise depending on the conditions of installation.

- Make sure that the FG line of RSF-5B is securely grounded.
- Because RSF-3C does not have any FG line from the motor enclosure. Thus, when using it, make sure that that enclosure is securely grounded to the body of the equipment through the gear head house. In addition, make sure that the body of the equipment is securely grounded.
- Do not bind the motor line and encoder signal line together.
- Do not draw any external power line (i.e., driver power supply line, 100/200 VAC line.), actuator signal line, and motor line through the same pipe or duct or bind them together.

The noise tolerance values of RSF supermini equipment are listed below.

They are guide values from a measurement that were performed using a standard relay cable in a noise test environment while the clamp filter included with the product was installed to the equipment. Note that the noise tolerance values in your actual environment of use may differ from them.

Model	RSF-3C	RSF-5B
Noise tolerance (encoder signal line)	1.5kV	2.0kV

## Installation

Since the RSF supermini series actuator is a high precision servo mechanism, great care is required for proper installation.

Install the actuator taking care not to damage accurately machined surfaces. Do not hit the actuator with a hammer. Take note that actuators provide a glass encoder, which may be damaged by impact.

- Procedure

- (1) Align the axis of rotation of the actuator and the load mechanism precisely.

Note 1: Very careful alignment is required especially when a rigid coupling is applied. Slight differences between centerlines will cause failure of the output shaft of the actuator.

Note 2: When attaching a coupling, be sure not to apply force to the actuator output shaft.

- (2) Fasten the flange of the actuator with flat washers and high strength bolts. Use a torque wrench when tightening the fasteners.

The recommended tightening torque is shown in the table below:

Model		RSF-3C	RSF-5B
Number of bolts		4	2
Bolt size		M1.6	M2
Installation PCD	mm	15	25
Wrenching torque	N·m	0.26	0.25
	kgf·m	0.03	0.03
Transfer torque	N·m	3.0	2.0
	kgf·m	0.3	0.2

Recommended bolt: JIS B 1176 bolt with hexagonal hole; Strength category: JIS B 1051 12.9 or greater

- (3) For wiring operation, refer to “AC Servo Driver for 24VDC Power Supply HA-680 Series Technical Data.”

- (4) Motor cable and encoder cable

Do not pull the cable. Do not hang the actuator with the cable. If you do, the connection part may be damaged. Install the cable with slack not to apply tension to the actuator. Especially, do not use the actuator under any condition where the cable is bent repeatedly.



### Do not disassemble and re-assemble the actuator.

The actuator uses many precision parts. The Harmonic Drive Systems, Inc. does not guarantee the actuator that has been reassembled by others than the authorized persons by the Harmonic Drive Systems, Inc.

**3**

**Installing the actuator**

# Chapter 4

## Motor shaft retention brake(RSF-5B)

---

RSF-5B actuator is standard-equipped with a motor shaft holding brake. (Option symbol: B) An external brake is not required to meet the fail safe and other requirements. The brake has 2 coils; one for releasing brake, and another for retaining the released state. By controlling the currents through the coils, power consumption during retention of brake release can be reduced.

---

4-1	Motor shaft retention brake specifications .....	4-1
4-2	Controlling the brake power supply .....	4-2

# 4-1 Motor shaft retention brake specifications

Item		Gear ratio	30	50	100
Method			Single disc dry type deenergisation operation type (Separate attraction coil and retention coil)		
Brake operating voltage	V		24VDC±10%		
Current consumption during release (at 20°C)	A		0.8		
Current consumption during retention of release (at 20°C)	A		0.05		
Retention torque <sup>Note 1</sup>	N·m		0.18	0.29	0.44
	kgf·cm		1.84	2.96	4.49
Moment of inertia <sup>Note 1</sup>	(GD <sup>2</sup> /4) kg·cm <sup>2</sup>		0.111 × 10 <sup>-3</sup>	0.309 × 10 <sup>-3</sup>	1.234 × 10 <sup>-3</sup>
	(J) kgf·cm·s <sup>2</sup>		1.132 × 10 <sup>-3</sup>	3.151 × 10 <sup>-3</sup>	12.58 × 10 <sup>-3</sup>
Weight <sup>Note 2</sup>	g		86 (excluding the clamp filters)		
Number of allowable brake operations <sup>Note 3</sup>			100,000 times		

Note 1: This is a value at the output shaft of the actuator.

Note 2: This is a value for the entire actuator.

Note 3: The motor shaft rotation speed is controlled as shown in the following table.

Gear ratio	Output shaft rotation speed [rpm]	Motor shaft rotation speed [rpm]
1:30	5.0	150
1:50	3.0	
1:100	1.5	

## 4-2 Controlling the brake power supply

### Using an extension cable (Recommended method)

The optional extension cables for brakes (EWA-Bxx-JST03-TMC) incorporate a circuit that controls the brake current.

You don't have to control the brake current, so it is recommended to use the actuator with a brake in combination with a relay cable for brakes.

If the relay cable for brakes is used, brake can be operated by turning on/off the brake power supply.

The power supply for the brake (that can output 24VDC±10%) shall be provided by the customer. Use a power supply unit that can output the current during release as described in [4-1 Motor shaft retention brake specifications] (P4-1).

The supply duration of the current consumption during release is 0.5sec or less at 24VDC±10%.

### Not using an extension cable

If the optional relay cable for brakes (EWA-Bxx-JST03-TMC) is not used, the customer must control the brake power supply to the brake release coil and release retention coil.

Supply the power upon brake release and during brake release retention, as shown below.

	Lead wire color	Applied voltage
Upon brake release	Gray/Yellow	24VDC±10%
	Blue/Yellow	
During release retention	Gray/Yellow	0VDC
	Blue/Yellow	24VDC±10%
During brake use	Gray/Yellow	0VDC
	Blue/Yellow	

Supply the power to the coils according to the following time chart.

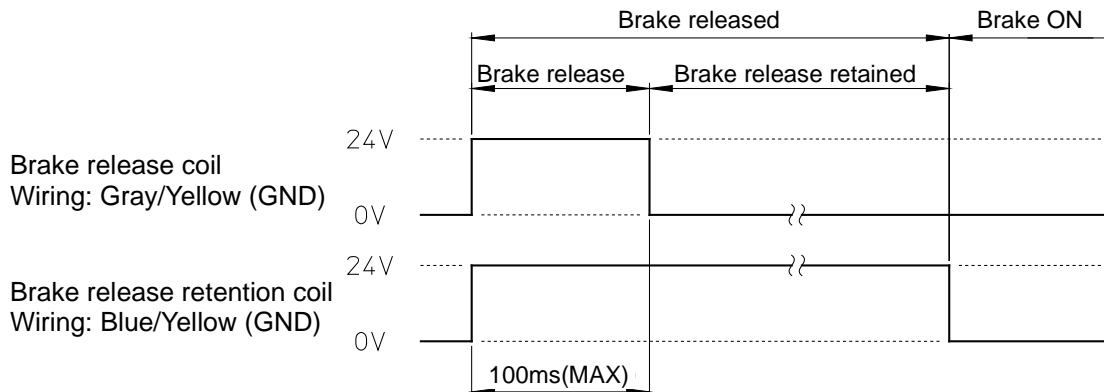

Control the power supply so that the duration in which the power is supplied to the brake release coil (gray/yellow) is 100ms or less. The brake will not be released only by the power supply to the brake release retention coil. To release the brake, also supply the power to the brake release coil.





**The power supply to the brake must be controlled.**

Control the power supply to the brake as described in [4-2 Controlling the brake power supply] (P4-2). If the current flows continuously to the attraction coil, the actuator burns due to temperature rise, causing fire or electric shock.



**Be careful not to exceed the number of allowable brake operations (Refer to [4-1 Motor shaft retention brake specifications] (P4-1)).**

If the number is exceeded, the retention torque drops and it cannot be used as a brake.

# Chapter 5

## Options

---

Options you can purchase as necessary are explained in this chapter.

---

5-1	Extension cables .....	5-1
5-2	Extension cable wire bound specifications.....	5-2
5-3	Connectors .....	5-5

# 5-1 Extension cables

There are extension cables that connect the RSF supermini series actuator and driver. There are 3 types of extension cables for encoders, motors, and brakes. Select an appropriate type according to the model of the actuator you ordered.

- **Extension cable model** (XX indicates the cable length 3m, 5m, or 10m.)

## (1) For encoders

EWA-E<sub>xx</sub>-JST09-3M14

Cable length (03=3m, 05=5m, 10=10m) : L

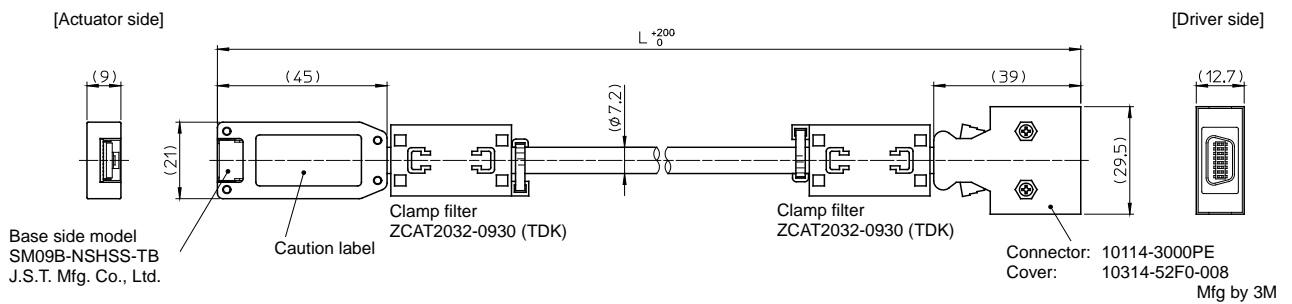

## (2) For motors

EWA-M<sub>xx</sub>-JST04-TN2

Cable length (03=3m, 05=5m, 10=10m) : L

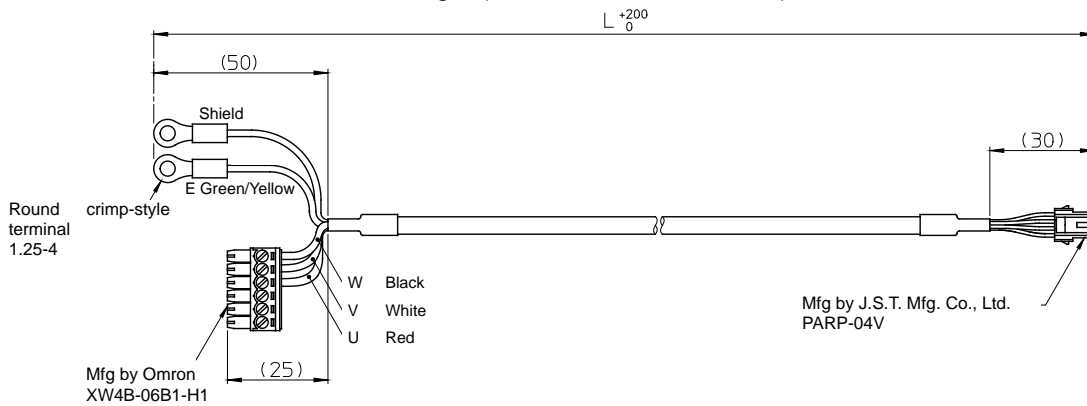

## (3) For brakes (RSF-5B only)

EWA-B<sub>xx</sub>-JST03-TMC

Cable length (03=3m, 05=5m, 10=10m)

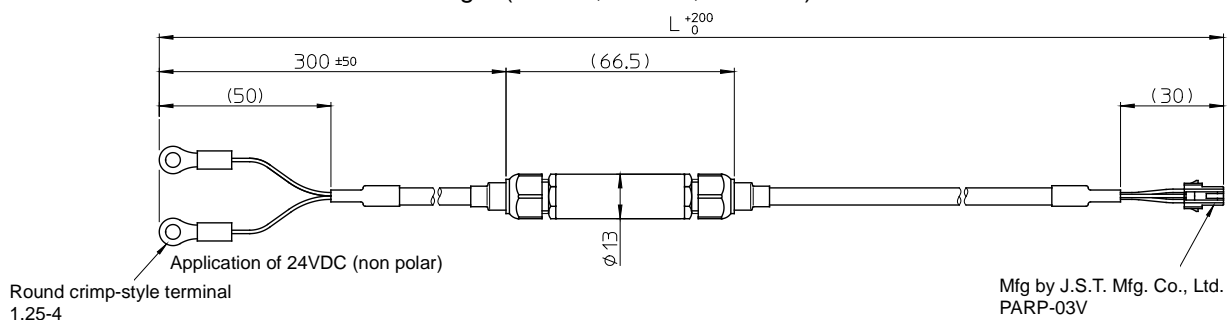

● **Extension cable DCJ/DDP Driver**

(1) For encoders

EWA-E x x -JST09-SP

Cable length (03=3m, 05=5m, 10=10m)

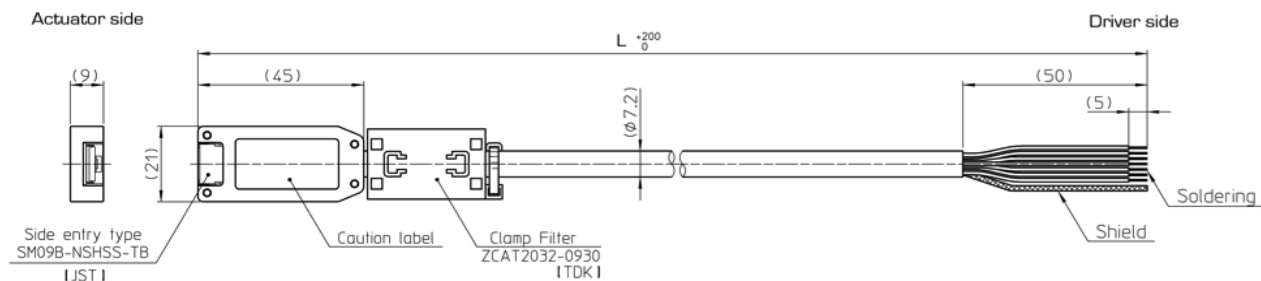

Driver side			
Color	Signal	Color	Signal
White/Red	Vcc	White/Black	GND
Red	B	Orange	U
Green	Z	Gray	Ü
Blue	B̄	Purple	V
White	A	Brown	V̄
Yellow	Z̄	Pink	w
Black	Ā	Light Blue	W̄

(2) For motors

EWA-M x x -JST04-SP

Cable length (03=3m, 05=5m, 10=10m)

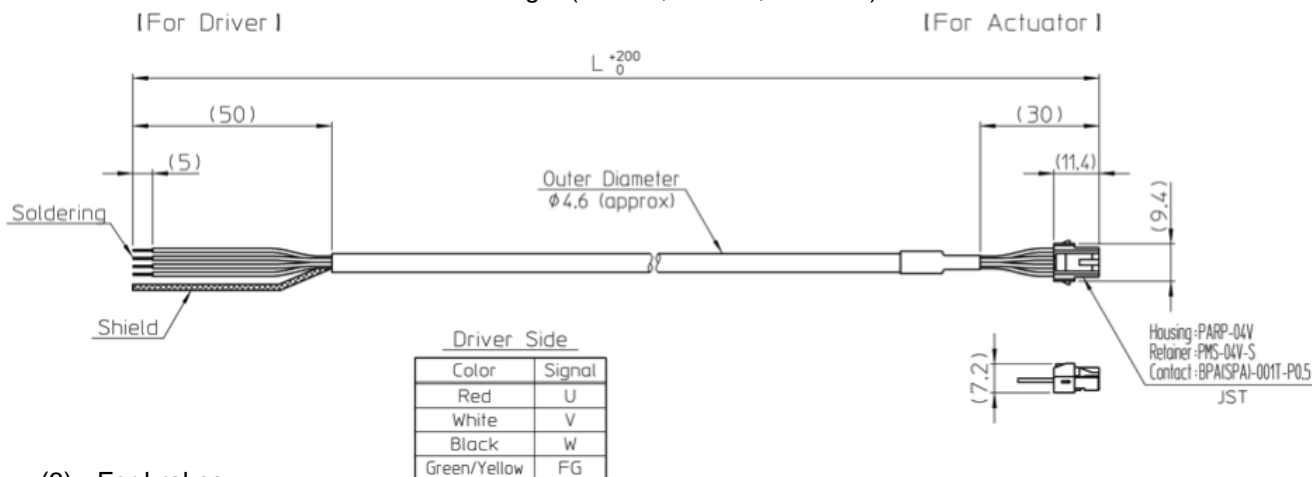

Driver Side	
Color	Signal
Red	U
White	V
Black	W
Green/Yellow	FG

(3) For brakes

EWA-B x x -JST03-TMC

Cable length (03=3m, 05=5m, 10=10m)

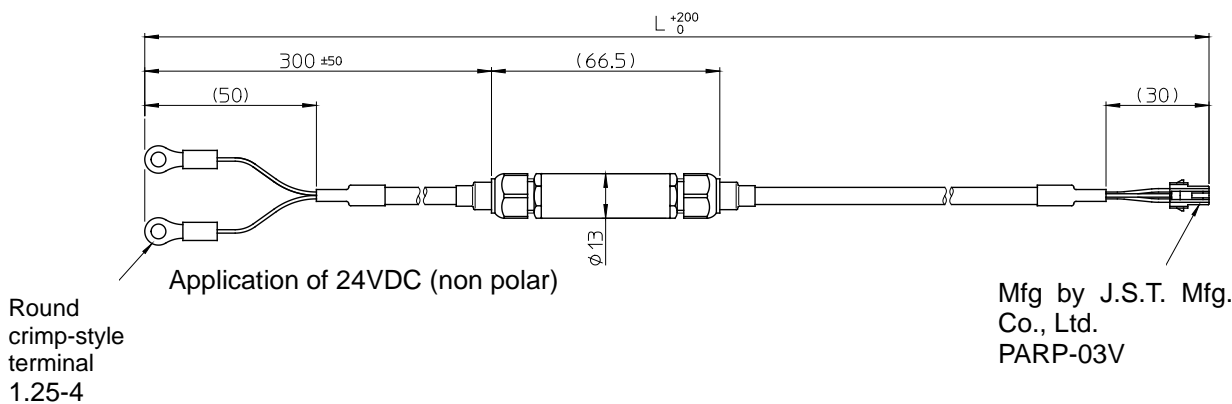

Round crimp-style terminal 1.25-4

Mfg by J.S.T. Mfg. Co., Ltd. PARP-03V

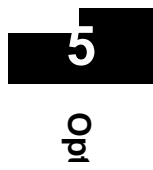

## Extension cable wire bound specifications

The following tables show the wire bound specifications of the relay cables.

### (1) For encoders (EWA-Exx-JST09-3M14)

#### Actuator side

Pin NO.	Signal name	Pin NO.	Signal name
1	A phase	6	W phase
2	B phase	7	+5V
3	Z phase	8	GND
4	U phase	9	N.C.
5	V phase		

Connector: SM09B-NSHSS-TB  
J.S.T. Mfg. Co., Ltd.

#### Driver side

Pin NO.	Signal name	Pin NO.	Signal name
1	+5V	8	GND
2	B+ phase	9	U+ phase
3	Z+ phase	10	U- phase
4	B- phase	11	V+ phase
5	A+ phase	12	V- phase
6	Z- phase	13	W+ phase
7	A- phase	14	W- phase

Connector: 10114-3000PE  
Cover: 10314-52F0-008  
3M

### (2) For motors (EWA-Mxx-JST04-TN2)

#### Actuator side

Pin NO.	Signal name
1	U phase
2	V phase
3	W phase
4	FG

Connector

Housing: PARP-04V  
Retainer: PMS-04V-S  
Contact: S(B)PA-001T-P0.5

J.S.T. Mfg Co.,Ltd

#### Driver side

Signal name	Connector
U phase	XW4B-06B1-H1 Omron
V phase	
W phase	
FG	Round crimp-style terminal 1.25-4
Shield	With insulating coating

**(3) For brakes (EWA-Bxx-JST03-TMC)**Actuator side

Pin NO.	Wire color
1	Red
2	White
3	Black

Connector

Retainer: PMS-03V-S  
Housing: PARP-03V  
Contact: S(B)PA-001T-P0.5  
J.S.T. Mfg Co.,Ltd

Power supply side for brake

Wire color	Connector
Red, black (nonpolar)	Round crimp-style terminal 1.25-4 With insulating coating

# 5-3 Connectors

**HA-680 Driver** There are 2 types of connectors for the driver for different set types:

- Connector model: CNK-HA68-S1  
For CN1, CN2, actuator line connection, power supply connection.....4 types
- Connector model: CNK-HA68-S2  
For CN2, power supply connection.....2 types

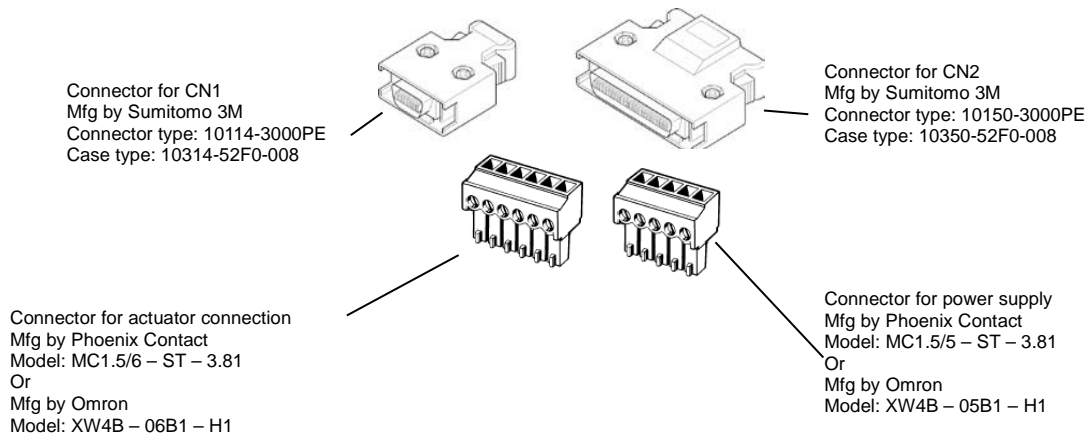

**DCJ Series ----- ACJ – CK – Poke/Crimp Connector Kit**

**DDP Series----- ADP – CK – Solder Cup Connector Kit**







# Appendix

---

This chapter explains the conversion of unit and the moment of inertia.

---

A-1	Conversion of unit.....	A-1
A-2	Moment of inertia.....	A-3

# A-1 Conversion of unit

This technical manual basically uses the SI unit system. The conversion coefficients between the SI unit system and other unit systems are shown below.

## (1) Length

SI unit	m	
	↓	
Unit	ft.	in.
Coefficient	3.281	39.37

Unit	ft.	in.
Coefficient	0.3048	0.0254
	↓	
SI unit	m	

## (2) Linear speed

SI unit	m/s			
	↓			
Unit	m/min	ft./min	ft./s	in/s
Coefficient	60	196.9	3.281	39.37

Unit	m/min	ft./min	ft./s	in/s
Coefficient	0.0167	5.08x10 <sup>-3</sup>	0.3048	0.0254
	↓			
SI unit	m/s			

## (3) Linear acceleration

SI unit	m/s <sup>2</sup>			
	↓			
Unit	m/min <sup>2</sup>	ft./min <sup>2</sup>	ft./s <sup>2</sup>	in/s <sup>2</sup>
Coefficient	3600	1.18x10 <sup>4</sup>	3.281	39.37

Unit	m/min <sup>2</sup>	ft./min <sup>2</sup>	ft./s <sup>2</sup>	in/s <sup>2</sup>
Coefficient	2.78x10 <sup>-4</sup>	8.47x10 <sup>-5</sup>	0.3048	0.0254
	↓			
SI unit	m/s <sup>2</sup>			

## (4) Force

SI unit	N		
	↓		
Unit	kgf	lb (force)	oz (force)
Coefficient	0.102	0.225	4.386

Unit	kgf	lb (force)	oz (force)
Coefficient	9.81	4.45	0.278
	↓		
SI unit	N		

## (5) Mass

SI unit	kg	
	↓	
Unit	lb.	oz.
Coefficient	2.205	35.27

Unit	lb.	oz.
Coefficient	0.4535	0.02835
	↓	
SI unit	kg	

**(6) Angle**

SI unit	rad		
Unit	Deg.	Min.	Sec.
Coefficient	57.3	3.44x10 <sup>3</sup>	2.06x10 <sup>5</sup>

Unit	Deg.	Min.	Sec.
Coefficient	0.01755	2.93x10 <sup>-4</sup>	4.88x10 <sup>-6</sup>
SI unit	rad		

**(7) Angular speed**

SI unit	rad/s			
Unit	Deg./s	Deg./min	r/s	r/min
Coefficient	57.3	3.44x10 <sup>3</sup>	0.1592	9.55

Unit	Deg./s	Deg./min	r/s	r/min
Coefficient	0.01755	2.93x10 <sup>-4</sup>	6.28	0.1047
SI unit	rad/s			

**(8) Angular acceleration**

SI unit	rad/s <sup>2</sup>	
Unit	Deg./s <sup>2</sup>	Deg./min <sup>2</sup>
Coefficient	57.3	3.44x10 <sup>3</sup>

Unit	Deg./s <sup>2</sup>	Deg./min <sup>2</sup>
Coefficient	0.01755	2.93x10 <sup>-4</sup>
SI unit	rad/s <sup>2</sup>	

**(9) Torque**

SI unit	Nm			
Unit	kgfm	lbft	lbin	ozin
Coefficient	0.102	0.738	8.85	141.6

Unit	kgfm	lbft	lbin	ozin
Coefficient	9.81	1.356	0.1130	7.06x10 <sup>-3</sup>
SI unit	Nm			

**(10) Moment of inertia**

SI unit	kgm <sup>2</sup>							
Unit	kgfms <sup>2</sup>	kgfcms <sup>2</sup>	lbft <sup>2</sup>	lbfts <sup>2</sup>	lbin <sup>2</sup>	lbins <sup>2</sup>	ozin <sup>2</sup>	ozins <sup>2</sup>
Coefficient	0.102	10.2	23.73	0.7376	3.42x10 <sup>3</sup>	8.85	5.47x10 <sup>4</sup>	141.6

Unit	kgfms <sup>2</sup>	kgfcms <sup>2</sup>	lbft <sup>2</sup>	lbfts <sup>2</sup>	lbin <sup>2</sup>	lbins <sup>2</sup>	ozin <sup>2</sup>	ozins <sup>2</sup>
Coefficient	9.81	0.0981	0.0421	1.356	2.93x10 <sup>-4</sup>	0.113	1.829x10 <sup>-5</sup>	7.06x10 <sup>-3</sup>
SI unit	kgm <sup>2</sup>							

**(11) Torsional spring constant, moment of rigidity**

SI unit	Nm/rad				
Unit	kgfm/rad	kgfm/arc min	kgfm/Deg.	lbft/Deg.	lbin/Deg.
Coefficient	0.102	2.97 x10 <sup>-5</sup>	1.78x10 <sup>-3</sup>	0.0129	0.1546

Unit	kgfm/rad	Kgfm/arc min	kgfm/Deg.	lbft/Deg.	lbin/Deg.
Coefficient	9.81	3.37 x10 <sup>4</sup>	562	77.6	6.47
SI unit	Nm/rad				

# A-2 Moment of inertia

## 1. Calculation formulas for mass and moment of inertia

### (1) When center of revolution and line of center of gravity match

Calculation formulas for mass and moment of inertia are shown below.

m: Mass (kg),  $I_x, I_y, I_z$ : moment of inertia ( $\text{kgm}^2$ ) making Axes x, y and z as centers of revolution

G : Distance from edge surface of center of gravity (m)

$\rho$  : Density ( $\text{kg/m}^3$ )

Units - Length: m, mass: kg, moment of inertia:  $\text{kgm}^2$

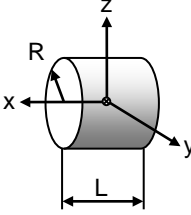
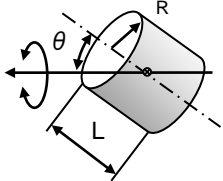
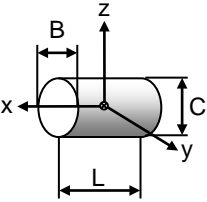
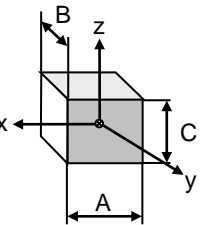
Shape of object	Mass, inertia, position of center of gravity
Circular cylinder 	$m = \pi R^2 L \rho$ $I_x = \frac{1}{2} m R^2$ $I_y = \frac{1}{4} m \left( R^2 + \frac{L^2}{3} \right)$ $I_z = \frac{1}{4} m \left( R^2 + \frac{L^2}{3} \right)$
Tilted circular cylinder 	$m = \pi R^2 L \rho$ $I_\theta = \frac{1}{12} m \times \left\{ 3R^2(1 + \cos^2\theta) + L^2 \sin^2\theta \right\}$
Elliptic circular cylinder 	$m = \pi B C L \rho$ $I_x = \frac{1}{16} m (B^2 + C^2)$ $I_y = \frac{1}{4} m \left( \frac{C^2}{4} + \frac{L^2}{3} \right)$ $I_z = \frac{1}{4} m \left( \frac{B^2}{4} + \frac{L^2}{3} \right)$
Prism 	$m = A B C \rho$ $I_x = \frac{1}{12} m (B^2 + C^2)$ $I_y = \frac{1}{12} m (C^2 + A^2)$ $I_z = \frac{1}{12} m (A^2 + B^2)$

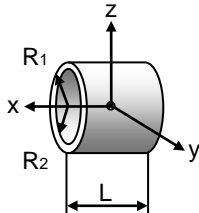
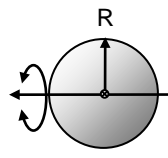
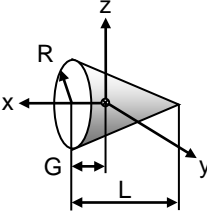
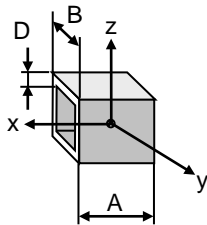
Shape of object	Mass, inertia, position of center of gravity
Round pipe 	$m = \pi (R_1^2 - R_2^2) L \rho$ $I_x = \frac{1}{2} m (R_1^2 + R_2^2)$ $I_y = \frac{1}{4} m \left\{ (R_1^2 + R_2^2) + \frac{L^2}{3} \right\}$ $I_z = \frac{1}{4} m \left\{ (R_1^2 + R_2^2) + \frac{L^2}{3} \right\}$ <p><math>R_1</math>: Outside diameter <math>R_2</math>: Inside diameter</p>
Sphere 	$m = \frac{4}{3} \pi R^3 \rho$ $I = \frac{2}{5} m R^2$
Cone 	$m = \frac{\pi}{3} \pi R^2 L \rho$ $I_x = \frac{3}{10} m R^2$ $I_y = \frac{3}{80} m (4R^2 + L^2)$ $I_z = \frac{3}{80} m (4R^2 + L^2)$ $G = \frac{L}{4}$
Regular square pipe 	$m = 4 A D (B - D) \rho$ $I_x = \frac{1}{3} m (B \cdot D)^2 + D^2$ $I_y = \frac{1}{6} m \left\{ \frac{A^2}{2} + (B \cdot D)^2 + D^2 \right\}$ $I_z = \frac{1}{6} m \left\{ \frac{A^2}{2} + (B \cdot D)^2 + D^2 \right\}$

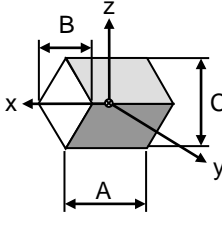
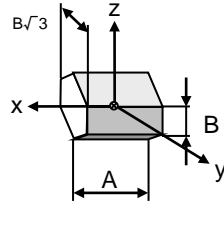
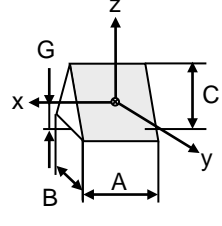
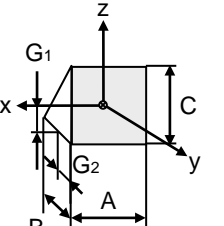
Shape of object	Mass, inertia, position of center of gravity	Shape of object	Mass, inertia, position of center of gravity
Rhombic prism 	$m = \frac{1}{2} ABC\rho$ $I_x = \frac{1}{24} m(B^2 + C^2)$ $I_y = \frac{1}{24} m(C^2 + 2A^2)$ $I_z = \frac{1}{24} m(B^2 + 2A^2)$	Regular hexagon prism 	$m = \frac{3\sqrt{3}}{2} AB^2\rho$ $I_x = \frac{5}{12} mB^2$ $I_y = \frac{1}{12} m\left(A^2 + \frac{5}{2}B^2\right)$ $I_z = \frac{1}{12} m\left(A^2 + \frac{5}{2}B^2\right)$
Equilateral triangular prism 	$m = \frac{1}{2} ABC\rho$ $I_x = \frac{1}{12} m\left(\frac{B^2}{2} + \frac{2}{3}C^2\right)$ $I_y = \frac{1}{12} m\left(A^2 + \frac{2}{3}C^2\right)$ $I_z = \frac{1}{12} m\left(A^2 + \frac{B^2}{2}\right)$ $G = \frac{C}{3}$	Right-angled triangular prism 	$m = \frac{1}{2} ABC\rho$ $I_x = \frac{1}{36} m(B^2 + C^2)$ $I_y = \frac{1}{12} m\left(A^2 + \frac{2}{3}C^2\right)$ $I_z = \frac{1}{12} m\left(A^2 + \frac{2}{3}B^2\right)$ $G_1 = \frac{C}{3} \quad G_2 = \frac{B}{3}$

● Example of density

The following table shows informative values of density. Please check actual specific gravities of materials individually.

Material	Density	Material	Density	Material	Density
SUS304	7930	Aluminum	2700	Epoxy resin	1900
S45C	7860	Duralumin	2800	ABS	1100
SS400	7850	Silicon	2300	Silicon resin	1800
Cast iron	7190	Quartz glass	2200	Polyurethane rubber	1250
Copper	8920	Teflon	2200		
Brass	8500	Fluorocarbon resin	2200		

**(2) When center of revolution and line of center of gravity do not match**

Moment of inertia when axis of center of gravity and axis of revolution of an inertia field do not match is calculated by the following formula.

$$I = I_g + mF^2$$

I: Moment of inertia when axis of center of gravity and axis of revolution do not match (kgm<sup>2</sup>)

I<sub>g</sub>: Moment of inertia when axis of center of gravity and axis of revolution match (kgm<sup>2</sup>)

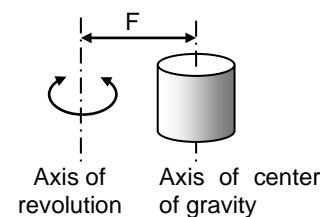

Calculated by formula shown in (1) in accordance with shape.

m: Mass (kg)

F: Distance between axis of revolution and axis of center of gravity (m)

**(3) Moment of inertia of linear motion object**

The moment of inertia converted into an FHA-C actuator axis of a linear motion object driven by a screw is calculated by the following formula.

$$I = m\left(\frac{P}{2\pi}\right)^2$$

I: Moment of inertia converted into actuator axis of a linear motion object (kgm<sup>2</sup>)

m: Mass (kg)

P: Amount of linear movement per revolution of actuator (m/rev)

## 2. Moment of inertia of circular cylinder

Approximate values of moment of inertia of circular cylinder can be calculated from the graph on the right.

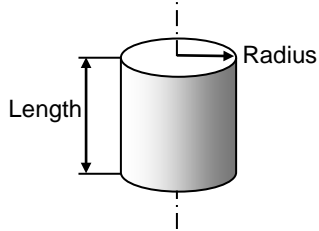

The top graph is applied to aluminum (density 2700) and the bottom graph, to steel (density 7850).

(Example)  
 Material: Aluminum  
 Outside diameter: 100mm  
 Length: 7mm  
 Shape: Circular cylinder  
 Outside diameter: 100mm  
 Since the outside diameter is 100mm, the radius is 50mm.  
 Based on the top graph, moment of inertia is about  $1.9 \times 10^{-4} \text{ kgm}^2$ .  
 (Calculated value:  $0.000186 \text{ kgm}^2$ )

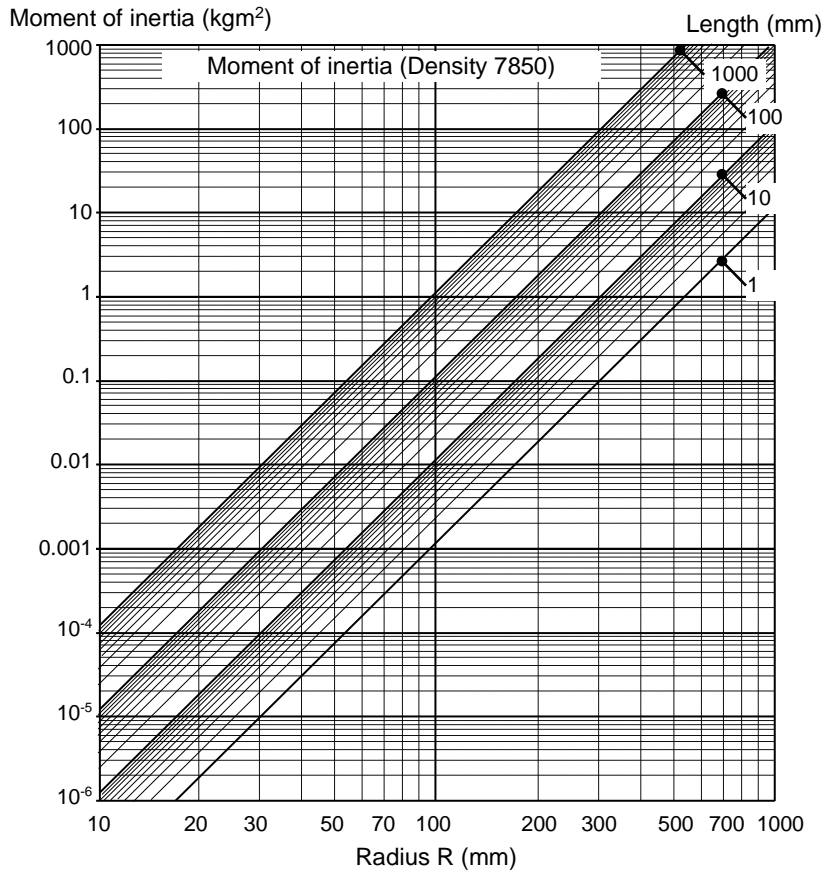
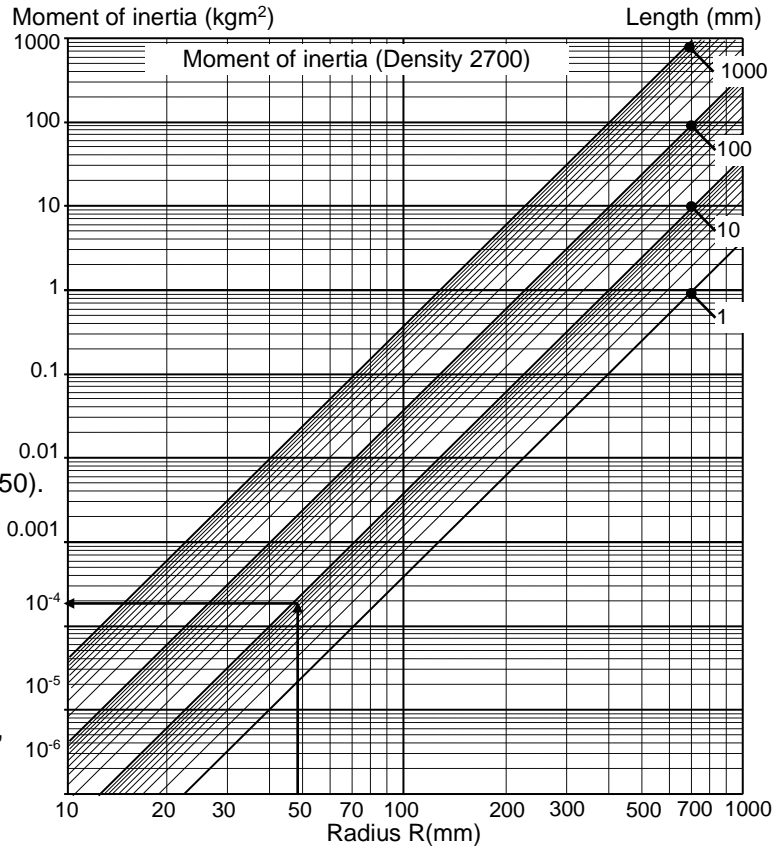

---

## Warranty Period and Terms

### The RSF supermini series actuators are warranted as follows:

#### ■ Warranty period

Under the condition that the actuator are handled, used and maintained properly followed each item of the documents and the manuals, all the RSF supermini series actuators are warranted against defects in workmanship and materials for the shorter period of either one year after delivery or 2,000 hours of operation time.

#### ■ Warranty terms

All the RSF supermini series actuators are warranted against defects in workmanship and materials for the warranted period. This limited warranty does not apply to any product that has been subject to:

- (1) user's misapplication, improper installation, inadequate maintenance, or misuse.
- (2) disassembling, modification or repair by others than Harmonic Drive Systems, Inc.
- (3) imperfection caused by the other than the RSF supermini series actuator and the HA-680 servo driver.
- (4) disaster or others that does not belong to the responsibility of Harmonic Drive Systems, Inc.

Our liability shall be limited exclusively to repairing or replacing the product only found by Harmonic Drive Systems, Inc. to be defective. Harmonic Drive Systems, Inc. shall not be liable for consequential damages of other equipment caused by the defective products, and shall not be liable for the incidental and consequential expenses and the labor costs for detaching and installing to the driven equipment. Specifications and dimensions in the catalog subject to change without notice.

*Specifications and dimensions in the catalog subject to change without notice.*

All efforts have been made to assure that the information in this catalog is complete and accurate. However, Harmonic Drive LLC is not liable for any errors, omissions or inaccuracies in the reported data. Harmonic Drive LLC reserves the right to change the product specifications, for any reason, without prior notice.

HarmonicDrive is registered trademark of Harmonic Drive LLC.



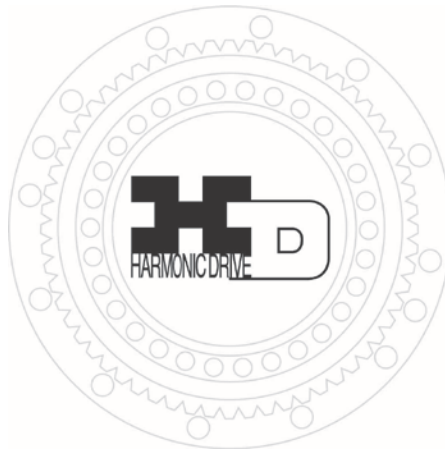

**Harmonic Drive LLC**  
**Headquarters/Manufacturing**  
42 Dunham Ridge, Beverly, MA 01915

**New York Office**  
100 Motor Parkway Suite #116, Hauppauge, NY 11788

**Chicago Office**  
137 N. Oak Park Ave. Suite 410, Oak Park, IL 60301

**California Office**  
333 W. San Carlos St. Suite 1070, San Jose, CA 95110

**Group Companies**  
Harmonic Drive Systems, Inc.  
6-25-3 Minami-Ohi, Shinagawa-ku  
Tokyo 141-0013, Japan

Harmonic Drive AG  
Hoenbergstrasse, 14, D-65555  
Limburg/Lahn Germany

HarmonicDrive.net | 978-532-1800