

Sold & Serviced By:

 **ELECTROMATE**

Toll Free Phone (877) SERV098

Toll Free Fax (877) SERV099

www.electromate.com

sales@electromate.com

HarmonicDrive®

FHA-C Mini 24VDC

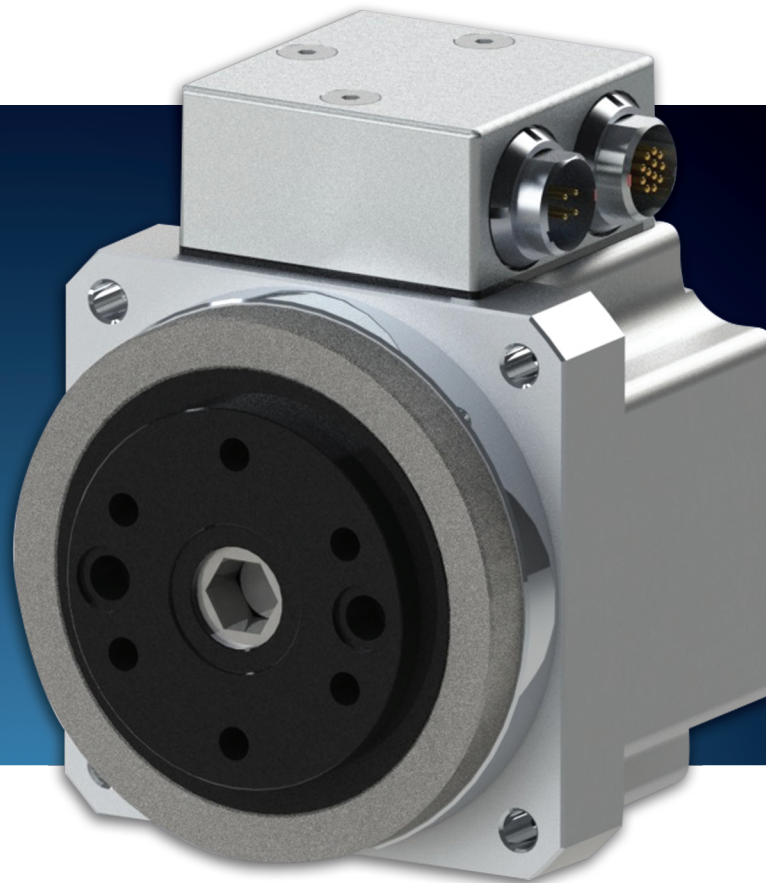

NEW!

Now Available:

• **New Connector Options** • **Dual Absolute Encoder** •

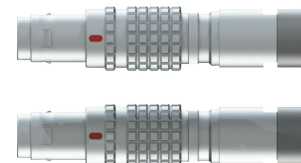

FHA-C Mini Actuator 24VDC

Introducing Dual Absolute encoder versions of the FHA-C mini actuator. Featuring BiSS-C bi-directional communication for both encoders. The dual encoders are incorporated in essentially the same package size as the long-standing FHA-C mini single incremental encoder version. Without increasing the size, the dual absolute encoder offers single turn absolute position at the output, without the need for battery back-up.

Panel mount connectors come standard, and customers can choose between 4 exit options. Together, these new features offer the design engineer more flexibility and reliability.

The FHA-C mini Series is a family of extremely compact actuators that deliver high torque with exceptional accuracy and repeatability. The actuator combines a high precision Harmonic Drive[®] gear component with a pancake brushless servo motor. An encoder is integrated to provide high-resolution velocity and position feedback. The large cross-roller output bearing allows heavy loads to be mounted directly to the actuator without the need for additional support. FHA-C mini actuators are designed to work with a variety of third party drives, as well as, Harmonic Drive LLC's DEP, DDP, DCJ and HA-680.

■ Features

- Zero backlash
- Incremental, Absolute or **Dual Absolute** Encoder
- **Panel Mount** Connectors with 4 exit options
- 24VDC*
- High-torque/weight and torque/volume ratio
- Optional flex-rated cables with sealed connectors
- Hollow shaft available with Incremental encoder version (only)

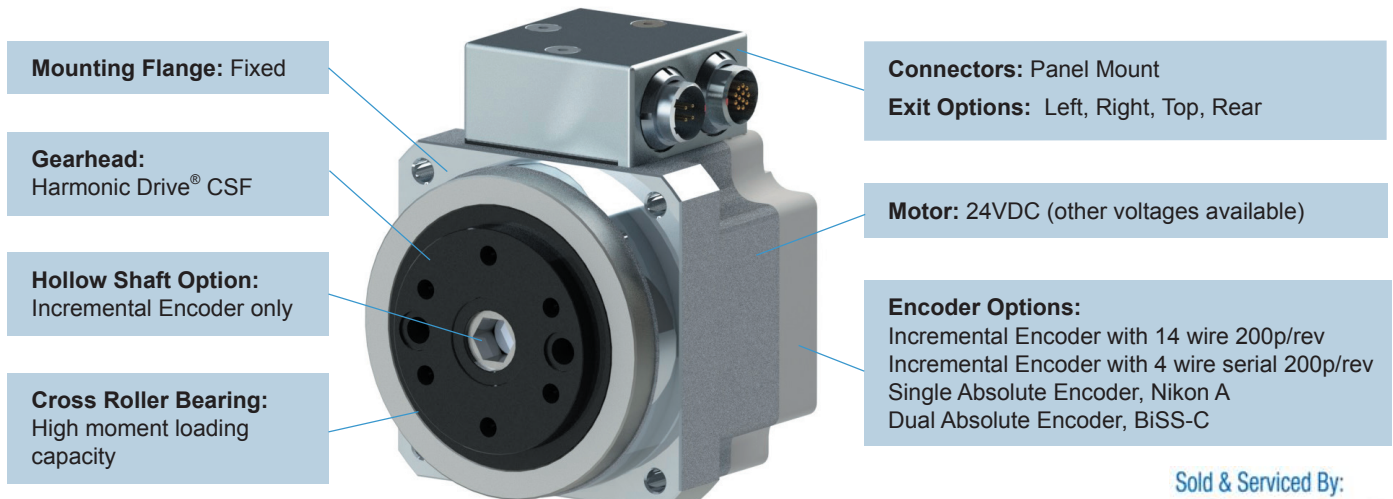

*Contact us for 100/200VAC

Sold & Serviced By:

 Toll Free Phone (877) SERV098
 Toll Free Fax (877) SERV099
www.electromate.com
sales@electromate.com

Ordering Code (with Incremental Encoder)



1	Model		FHA-C Mini Series
2	Size		8, 11, 14
3	Design Version		C
4	Gear Ratio		30, 50, 100
5	Encoder Type and Resolution		US200 – Incremental Encoder with 14 wire 2000p/rev E200 – Incremental Encoder with 4 wire serial 2000p/rev
6	Connector (leads only)		Blank – Leads without connector C – Leads with connector for extension cable
7	Power Supply		E – 24VDC
8	Options	Leads	Blank – Side exit leads, right (of output side) K – Rear exit leads
		Cable	M1 – 1M Length Cable (motor & encoder) KM1 – Rear Exit 1M Length Cable (motor & encoder)
		Panel Mount	PM1 – Panel Mount Connectors, rear exit PM2 – Panel Mount Connectors, right exit PM3 – Panel Mount Connectors, left exit PM4 – Panel Mount Connectors, top exit NEW!
9	Special Specification		Blank – Standard Product SP ____ – Special Specification Code

Ordering Code (with Absolute Encoder or Dual Absolute Encoder)

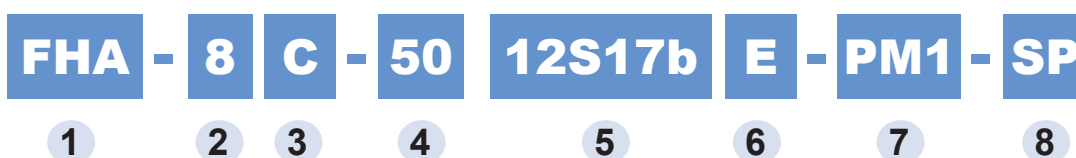

1	Model		FHA-C Mini Series
2	Size		8, 11, 14
3	Design Version		C
4	Gear Ratio		30, 50, 100
5	Encoder Type and Resolution		12S17b - Single Absolute Encoder, Nikon A <i>Single Turn (17 bit) & Multi-Turn (16 bit)</i> SB14bSB14b - Dual Absolute Encoder, BiSS-C, bi-directional <i>Motor Input Encoder (14 bit) & Gear Output Encoder (14 bit)</i> NEW!
6	Power Supply		E – 24VDC
7	Options	Leads*	Blank – Leads without connector C – Leads with connector for extension cable
		Cable*	M1 – 1M Length Cable (motor & encoder)
		Panel Mount	PM1 – Panel Mount Connectors, rear exit PM2 – Panel Mount Connectors, right exit PM3 – Panel Mount Connectors, left exit PM4 – Panel Mount Connectors, top exit NEW!
8	Special Specification		Blank – Standard Product SP ____ – Special Specification Code

* only available with single absolute encoder.

NEW! Panel Mount Connectors

The FHA-C mini series actuators are now available with built-in connectors. These connector options expand the FHA-C mini series servo actuator line and offer cable flexibility without adding additional length or width.

■ Features

- Standard Lemo[®] Connectors
- 4 exit options
- Available for all sizes, ratios and encoder options for FHA-C mini 24VDC
- No exposed leads that could be susceptible to damage
- Cables can be replaced without replacing the entire actuator. In most cases, the actuator can remain installed.
- Simple to install replacement cables available
- IP68 rated connectors

■ Exit Options

Key

- **PM1** Panel mount connectors, rear exit (opposite output)
- **PM2** Panel mount connectors, right exit (of output side)
- **PM3** Panel mount connectors, left exit (of output side)
- **PM4** Panel mount connectors, top exit

*Hollow shaft only available with incremental encoder version

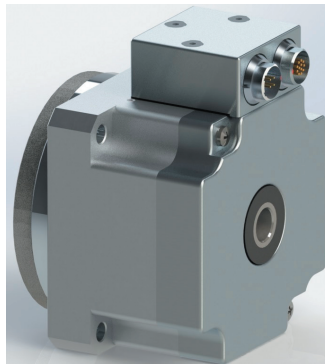

PM1 Rear Exit



PM2 Right Exit

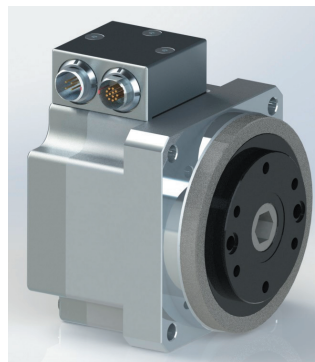

PM3 Left Exit



PM4 Top Exit

Sold & Serviced By:

 **ELECTROMATE**

Toll Free Phone (877) SERV098

Toll Free Fax (877) SERV099

www.electromate.com

sales@electromate.com

Dual Absolute Encoder

A single turn 14 bit (16384 cpr) gear output encoder has been integrated along with a single turn 14 bit (16384 cpr) motor input encoder providing a true absolute encoder that does not require a battery within 360° of rotation of the output. Typical multi-turn encoders monitoring the motor input shaft require a battery to store the current position when power is lost to the system; however, the dual absolute encoder overcomes this need. In other words, **No Battery Required**. When power is restored the actuator knows its position within 0.35° accuracy.

■ Features

- Single Turn Absolute Encoders on both Input and Output Sides
- Compact - significantly shorter than our multi-turn absolute encoder version
- Minimal length difference compared to our incremental encoder version
- Output Encoder 14 bit (16384 cpr) resolution, 0.35° accuracy
- Input Encoder 14 bit (16384 cpr) resolution, 0.1° accuracy
- BiSS-C bi-directional communication for both encoders
- Compatible Drive: Copley Controls BEL or BPL

■ Optional Cables 3 Lengths Available: 3m (03), 5m (05), 10m (10)

Encoder Cable

Encoder	Description	Length (ZZ)		
		3 meter	5 meter	10 meter
Inc	CBL-EZZ-L006-N	✓	✓	✓
ABS	CBL-EZZ-L012-N	✓	✓	✓
Dual	CBL-EZZ-L012-N	✓	✓	–

Encoder Voltage

Encoder	Encoder Voltage Operational Range	Voltage (Minimum) Requirement for Cable Length (ZZ)		
		3 meter	5 meter	10 meter
Inc	4.75V - 5.25V	5V	5.2	5.65
ABS	4.75V - 30V	5V	5	5.4
Dual	4.75 - 6V	5V	5	5.25

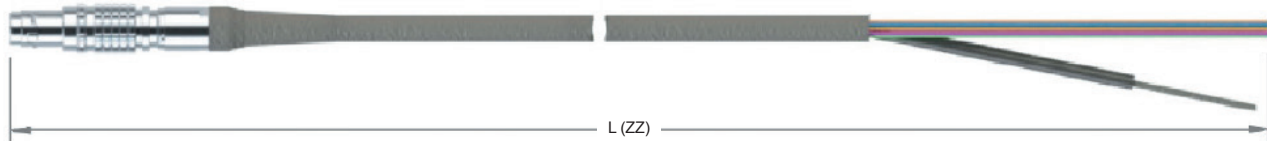

Motor Cable

Actuator	Description	Length (ZZ)		
		3 meter	5 meter	10 meter
FHA-8,11	CBL-MZZ-L004-N	✓	✓	✓
FHA-14	CBL-MZZ-L104-N	✓	✓	✓

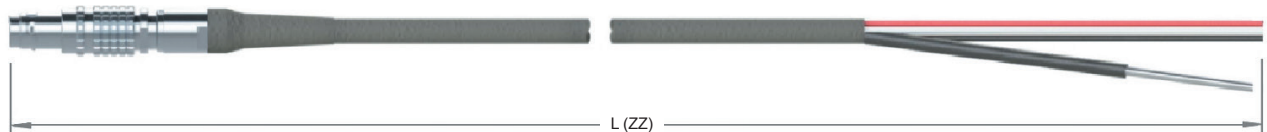

Specifications

Item		Size	FHA-8C			FHA-11C			FHA-14C			
			30	50	100	30	50	100	30	50	100	
Maximum torque ^{(Note) 2}		Nm	1.8	3.3	4.8	4.5	8.3	11	9.0	18	28	
Maximum speed		rpm	200	120	60	200	120	60	200	120	60	
Torque constant		Nm/A _{rms}	0.8	1.3	2.7	0.8	1.3	2.6	0.8	1.4	2.9	
Maximum current ^{(Note) 2}		A _{rms}	3.0	3.3	2.4	7.8	8.2	5.6	14.8	16.4	12.3	
Allowable continuous current ^{(Note) 2}		A _{rms}	1.6	1.7	1.3	3.7	3.5	2.8	6	5.4	4.4	
Power supply voltage		V	24VDC									
EMF constant		V/(rpm)	0.10	0.16	0.32	0.09	0.15	0.31	0.10	0.17	0.34	
Phase resistance		Ω(20°C)	0.54			0.19			0.07			
Phase inductance		mH	0.22			0.11			0.06			
Number of poles			10									
Moment of inertia ^{(Note) 3}	INC	GD ² /4	kgm ²	0.0026	0.0074	0.029	0.0060	0.017	0.067	0.018	0.050	0.20
	ABS	GD ² /4	kgm ²	0.0026	0.0073	0.029	0.0062	0.017	0.069	0.019	0.054	0.215
	Dual ABS	GD ² /4	kgm ²	0.0036	0.0100	0.0399	0.007	0.019	0.077	0.019	0.052	0.206
Allowable moment load		Nm	15			40			75			
Moment Stiffness		Nm/rad	2 x 10 ⁴			4 x 10 ⁴			8 x 10 ⁴			
Output shaft resolution ^{(Note) 4}	INC		pls/rev	240,000	400,000	800,000	240,000	400,000	800,000	240,000	400,000	800,000
	Single ABS			3,932,160	6,553,600	13,107,200	3,932,160	6,553,600	13,107,200	3,932,160	6,553,600	13,107,200
	Dual ABS Motor			491,520	819,200	1,638,400	491,520	819,200	1,638,400	491,520	819,200	1,638,400
	Dual ABS Output			16,384	16,384	16,384	16,384	16,384	16,384	16,384	16,384	16,384
One-way positioning accuracy		arc sec	150	120	120	120	90	90	120	90	90	
Input power supply voltage		V	24VDC									
Mass	INC	kg	0.40			0.62			1.2			
	ABS		0.50			0.75			1.3			
	Dual ABS		0.40			0.62			1.2			
Enclosure		Totally enclosed self-cooled (IP44)										
Ambient environment specification		Use temperature: 0 to 40°C/Storage temperature: -20 to +60°C, Use humidity and storage humidity: 20 to 80%RH (non-condensing) Free from dust, dirt, metallic powder, corrosive gas, flammable gas, oil mist, and others. Avoid outdoor use or direct sunlight. Altitude: 1,000 m or less Insulation resistance. Motor insulation: 100 MΩ (500 VDC) or higher Dielectric strength voltage: 1500 VAC/min Insulation class: B										
Mounting direction		Can be installed in any direction										
Servo drive	Incremental (14 wire)	24VDC	DCJ-055-09, DDP-090-09, DEP-090-09			DCJ-055-18, DDP-090-18, DEP-090-18			DDP-090-36, DEP-090-36			
			HA-680-4-24									
	Incremental (4 wire serial)	24VDC	DEP-090-09			DEP-090-18			DEP-090-36			
			DEP-090-09			DEP-090-18			DEP-090-36			
Dual ABS		24VDC	BEL or BPL-06			BEL or BPL-14			BEL or BPL-30			

(Note) 1. The table shows typical output values of actuators.

2. Values when using HA-680 drive.

3. All values are typical.

4. Incremental encoder resolutions are obtained by [motor encoder resolution] x 4 x [reduction ratio]. Motor ABS encoder resolutions are obtained by [motor encoder resolution] x [reduction ratio].

5. Refer to the HA-680 manual for details.

6. All parts, except the rotary sliding parts (oil seal) and C option connectors, are protected against solid bodies of superior dimensions to 1mm, and against the water sprays. Panel mount connectors are IP68.

One-Way Positional Accuracy

The one-way positioning accuracy is defined as the maximum positional difference between the commanded position and the actual stop position when a series of positioning moves are performed in the same rotation direction. (Refer to JIS B-6201-1987).

The FHA-C mini actuator incorporates a Harmonic Drive[®] gear which inherently has high rotational position accuracy. Because of the gearing's high ratio, any rotational error at the input (i.e. motor shaft position error or motor feedback error) is reduced by a factor of the ratio (1/ratio) and typically becomes negligible at the output. Therefore most of the error is represented by the transmission error of the Harmonic Drive gear itself.

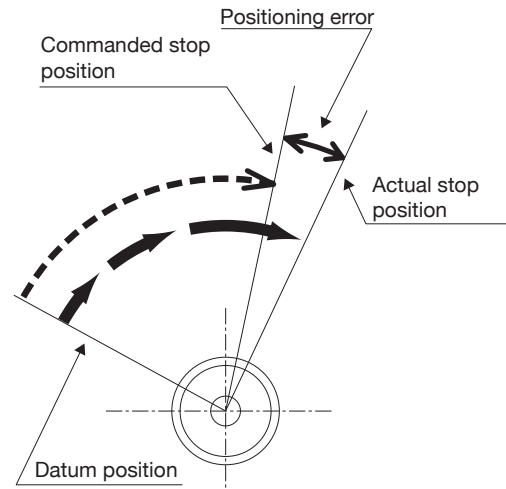

One-Way Positioning Accuracy

Item	Size	FHA-8C			FHA-11C			FHA-14C		
		30	50	100	30	50	100	30	50	100
One-Way Positional Accuracy	arc sec	150	120	120	120	90	90	120	90	90
	rad	7.27×10^{-4}	5.82×10^{-4}	5.82×10^{-4}	5.82×10^{-4}	4.37×10^{-4}	4.37×10^{-4}	5.82×10^{-4}	4.37×10^{-4}	4.37×10^{-4}

Compatible Servo Drives

Encoder Type	Actuator Size	Input Voltage	Recommended Sero Drives		
			General/CANopen	Ether CAT	General I/O
Incremental	8	24VDC	DDP-090-09 DCJ-055-09	DEP-090-09	HA-680-4-24
	11	24VDC	DDP-090-18 DCJ-055-18	DEP-090-18	
	14	24VDC	DDP-090-36	DEP-090-36	
Absolute	8	24VDC	-	DEP-090-09	-
	11	24VDC		DEP-090-18	
	14	24VDC		DEP-090-36	
Dual Absolute	8	24VDC	BPL-090-06	BEL-090-06	-
	11	24VDC	BPL-090-14	BEL-090-14	
	14	24VDC	BPL-090-30	BEL-090-30	

1. HA-680 is available for MECHATROLINK-II & CC-Link.



Outline Dimensions (FHA-C mini 24VDC)

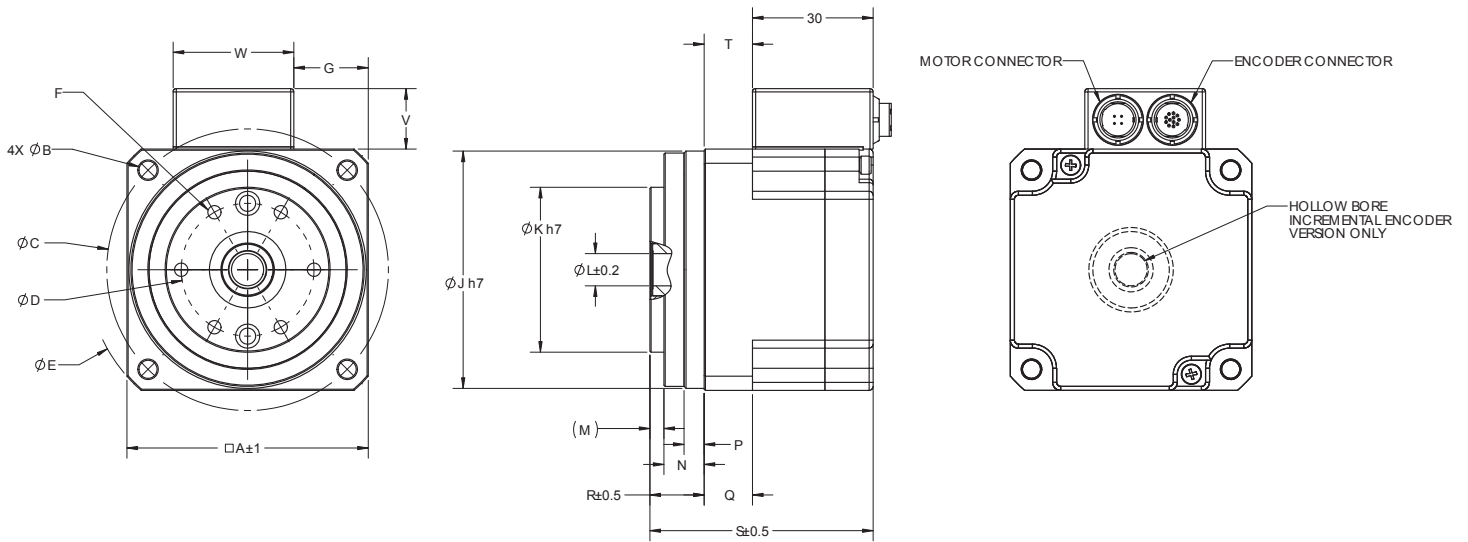





Dimensions

Unit: mm

	FHA-8C	FHA-11C	FHA-14C
A	50	60	75
øB	3.4	4.5	5.5
øC	58	70	88
øD	25.5	33	44
øE	66	80	100
F	6-M3X5	6-M4X5	6-M5X7
G	10	18.5	24 (PM1), 25.8 (PM2, 3) 25.3 (PM4)
øJ	49	59	74
øK	33.5	41	52.5
øL	6.2*	8*	13.5*
M	3	3.5	3.5
N	10	10	15
P	5	5	8
Q	10	12	15
R	13	13.5	18.5
S	[INC]	48.5	66
	[Single ABS]	61.8	78
	[Dual ABS]	49	65.5
T	2.1	12	14.8 (PM1), 13 (PM2), 14 (PM3), 14.3 (PM4)
V	15	15	17.5 (PM1,2,3), 15 (PM4)
W	30	30	32.5 (PM1,2,3), 30 (PM4)

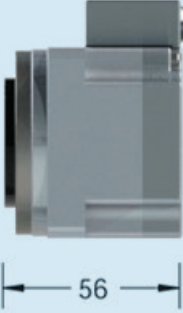
1. *Incremental encoder version only.

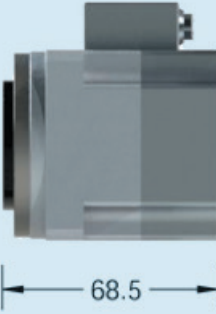
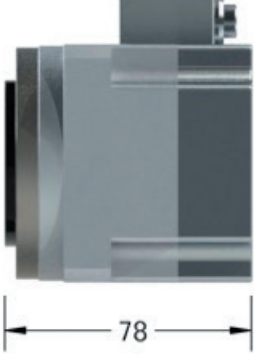
■ Length Comparison [mm]

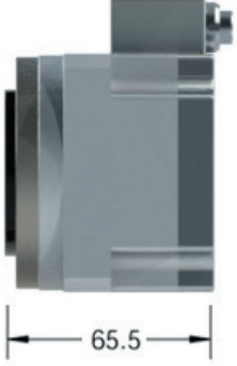
	FHA-8	FHA-11	FHA-14
Incremental Encoder	 <p>48.5</p>	 <p>56</p>	 <p>66</p>
Single Absolute Encoder	 <p>61.8</p>	 <p>68.5</p>	 <p>78</p>
Dual Absolute Encoder	 <p>49</p>	 <p>55.5</p>	 <p>65.5</p>

Operable Range

The following graphs show the operable range when a FHA-C mini series actuator and an HA-680 drive are combined.

(1) Continuous Motion Range

The range allows continuous operation for the actuator.

(2) 50% Duty Motion Range

This range indicates the torque rotation speed which is operable in the 50% duty operation (the ratio of operating time and delay time is 50:50).

(3) Motion Range During Acceleration and Deceleration

This range indicates the torque rotation speed which is operable momentarily. The range allows instantaneous operation as is typical during acceleration and deceleration. The continuous and 50% duty motion ranges shown on each graph are measured on the condition where the radiation plate specified in the graph is installed.

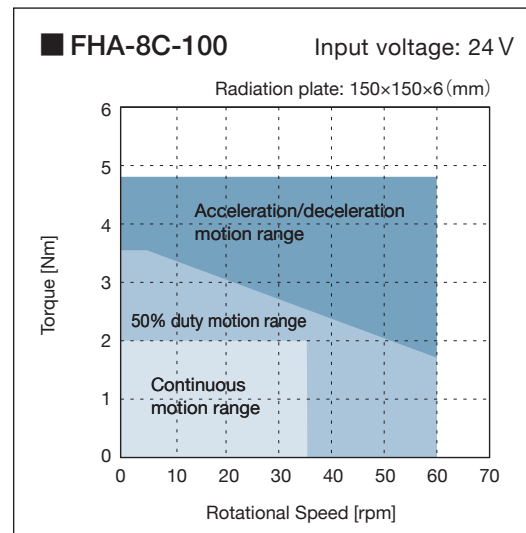
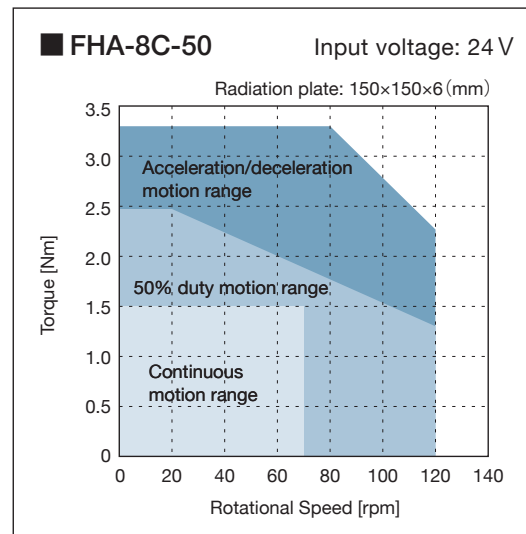
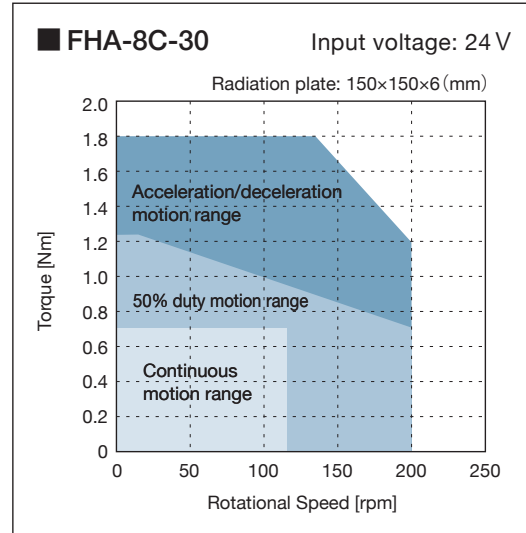

Sold & Serviced By:

ELECTROMATE

Toll Free Phone (877) SERV098
Toll Free Fax (877) SERV099
www.electromate.com
sales@electromate.com

Operable Range

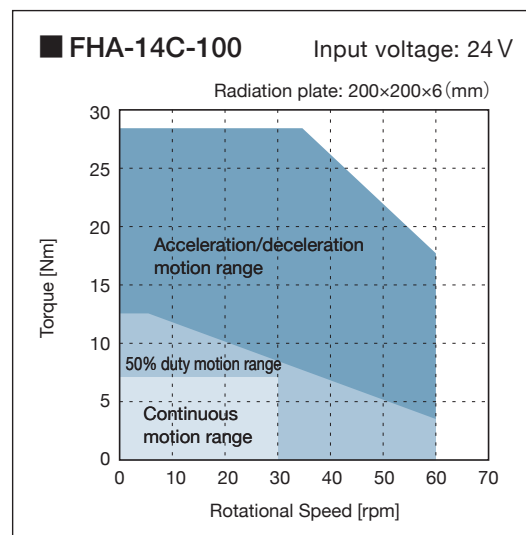
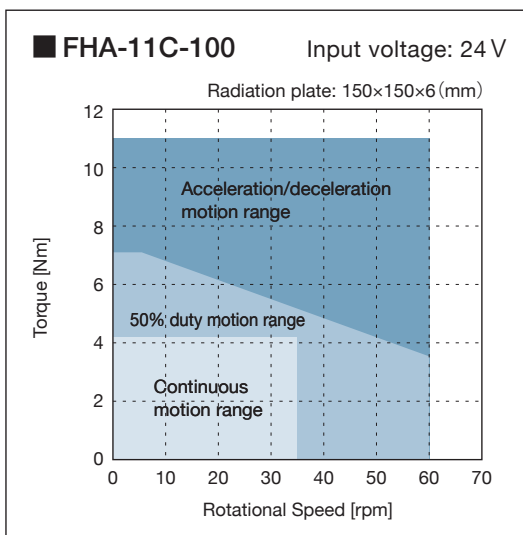
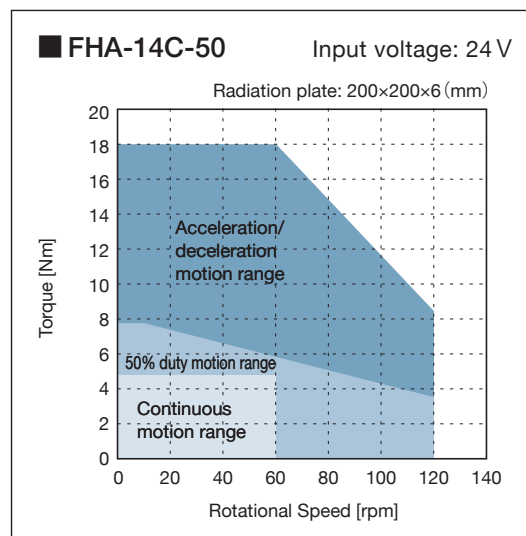
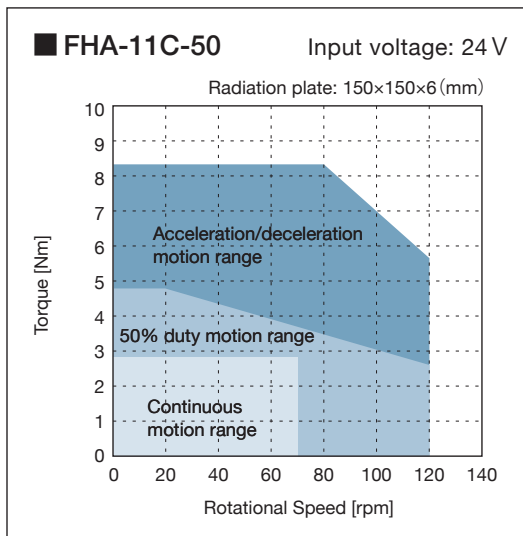
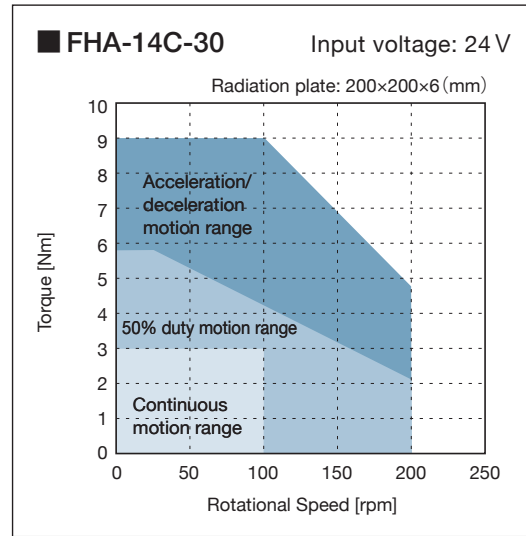
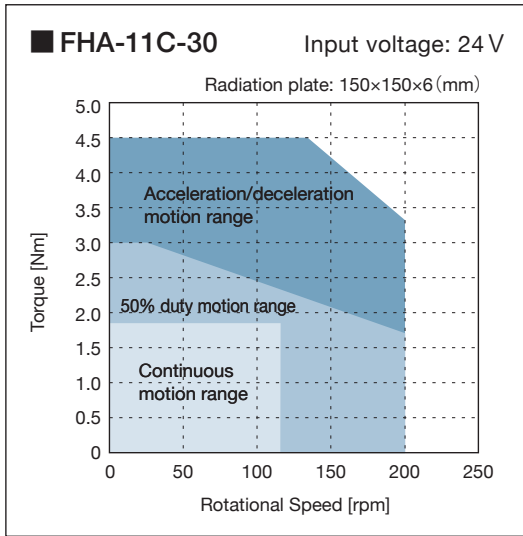

Sold & Serviced By:



ELECTROMATE

Toll Free Phone (877) SERV098

Toll Free Fax (877) SERV099

www.electromate.com

sales@electromate.com

