

**Description**

The AZ20A8DDC PWM servo drive is designed to drive brush-type DC motors at a high switching frequency. To increase system reliability and to reduce cabling costs, the drive is designed for direct integration into your PCB. The AZ20A8DDC is fully protected against over-voltage, under-voltage, over-current, over-heating and short-circuits. A single digital output indicates operating status. The drive interfaces with digital controllers that have digital PWM output. The PWM IN duty cycle determines the output current and DIR input determines the direction of rotation. This servo drive requires only a single unregulated isolated DC power supply, and is fully RoHS (Reduction of Hazardous Substances) compliant.

See Part Numbering Information on last page of datasheet for additional ordering options.

**Power Range**

Peak Current	20 A
Continuous Current	12 A
Supply Voltage	10 - 80 VDC



**Features**

- ▲ High Power Density
- ▲ Compact Size
- ▲ Direct Board-to-Board Integration
- ▲ Lightweight
- ▲ High Switching Frequency
- ▲ Four Quadrant Regenerative Operation
- ▲ Wide Temperature Range
- ▲ High Performance Thermal Dissipation
- ▲ Differential Input Command
- ▲ Current Monitor Output
- ▲ Digital Fault Output Monitor
- ▲ 12VDC Operation

**HARDWARE PROTECTION**

- Over-Voltage
- Under-Voltage
- Over-Current
- Over-Temperature
- Short-circuit (phase-phase)
- Short-circuit (phase-ground)

**INPUTS/OUTPUTS**

- Digital Fault Output
- Digital Inhibit Input
- Analog Current Monitor
- Analog Command Input
- Analog Current Reference

**MODES OF OPERATION**

- Current

**MOTORS SUPPORTED**

- Single Phase (Brushed, Voice Coil, Inductive Load)

**COMMAND SOURCE**

- PWM

**COMPLIANCES & AGENCY APPROVALS**

- UL
- cUL
- CE Class A (EMC)
- CE Class A (LVD)
- RoHS

Sold & Serviced By:



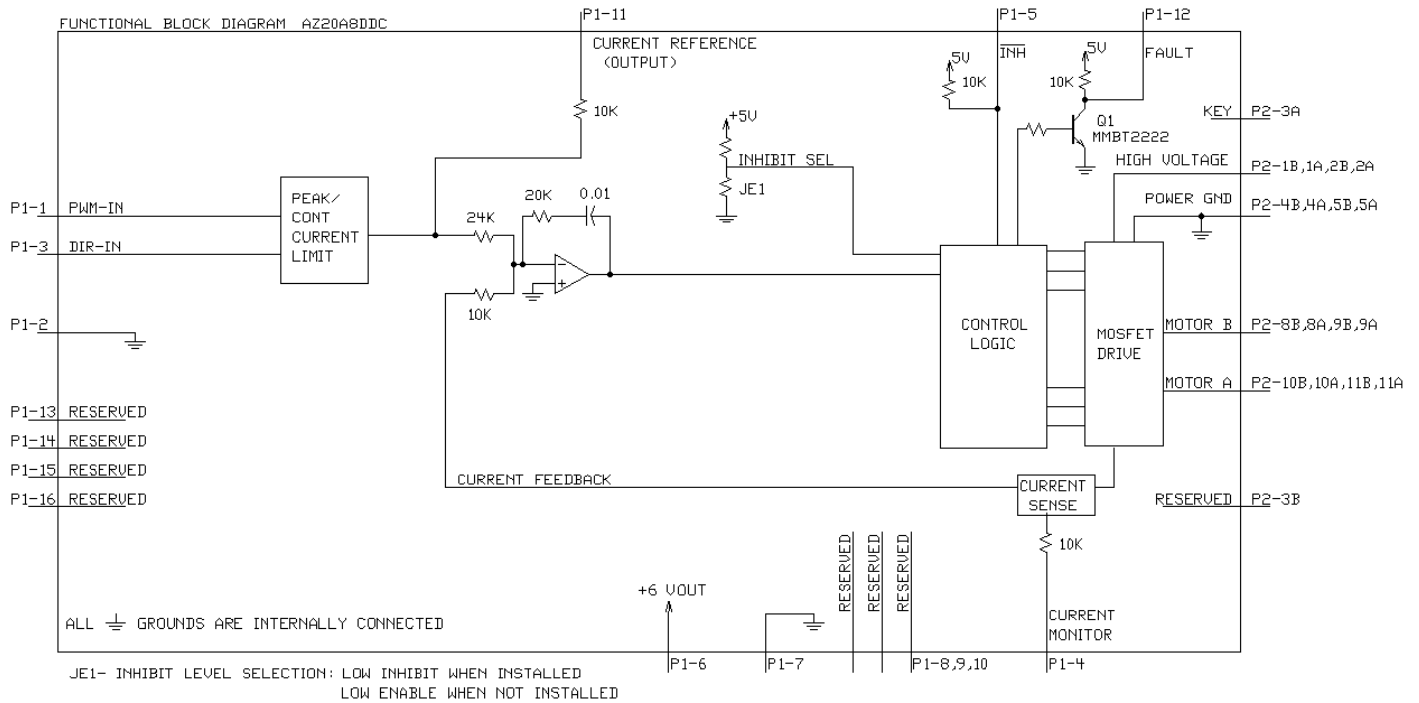

Toll Free Phone (877) SERV098  
 Toll Free Fax (877) SERV099  
[www.electromate.com](http://www.electromate.com)  
[sales@electromate.com](mailto:sales@electromate.com)

**BLOCK DIAGRAM**



**Information on Approvals and Compliances**

	<p>US and Canadian safety compliance with UL 508c, the industrial standard for power conversion electronics. UL registered under file number E140173. Note that machine components compliant with UL are considered UL registered as opposed to UL listed as would be the case for commercial products.</p>
	<p>Compliant with European CE for both the Class A EMC Directive 2004/108/EC on Electromagnetic Compatibility (specifically EN 61000-6-4:2007 and EN 61000-6-2:2005) and LVD requirements of directive 2006/95/EC (specifically EN 60204-1:2006), a low voltage directive to protect users from electrical shock.</p>
	<p>RoHS (Reduction of Hazardous Substances) is intended to prevent hazardous substances such as lead from being manufactured in electrical and electronic equipment.</p>

Sold & Serviced By:



Toll Free Phone (877) SERV098

Toll Free Fax (877) SERV099

www.electromate.com

sales@electromate.com

**SPECIFICATIONS**

Power Specifications		
Description	Units	Value
DC Supply Voltage Range	VDC	10 - 80
DC Bus Under Voltage Limit	VDC	9
DC Bus Over Voltage Limit	VDC	88
Maximum Peak Output Current <sup>1</sup>	A	20
Maximum Continuous Output Current	A	12
Maximum Continuous Output Power	W	912
Maximum Power Dissipation at Continuous Current	W	48
Minimum Load Inductance (Line-To-Line) <sup>2</sup>	µH	100
Low Voltage Supply Outputs	-	+6 VDC (30 mA)
Switching Frequency	kHz	31
Control Specifications		
Description	Units	Value
Command Sources	-	PWM
PWM Input Frequency Range	kHz	10 - 25
Modes of Operation	-	Current
Motors Supported	-	Single Phase (Brushed, Voice Coil, Inductive Load)
Hardware Protection	-	Over Current, Over Temperature, Over Voltage, Under Voltage, Short Circuit (Phase-Phase & Phase-Ground)
Mechanical Specifications		
Description	Units	Value
Agency Approvals	-	CE Class A (EMC), CE Class A (LVD), cUL, RoHS, UL
Size (H x W x D)	mm (in)	63.5 x 50.8 x 22.9 (2.5 x 2 x 0.9)
Weight	g (oz)	94.5 (3.3)
Heatsink (Base) Temperature Range <sup>3</sup>	°C (°F)	0 - 75 (32 - 167)
Storage Temperature Range	°C (°F)	-40 - 85 (-40 - 185)
P1 Connector	-	16-pin, 2.54 mm spaced header
P2 Connector	-	22-pin, 2.54 mm spaced, dual-row header

**Notes**

1. Maximum duration of peak current is ~2 seconds. Peak RMS value must not exceed continuous current rating of the drive.
2. Lower inductance is acceptable for bus voltages well below maximum. Use external inductance to meet requirements.
3. Additional cooling and/or heatsink may be required to achieve rated performance.

Sold &amp; Serviced By:



Toll Free Phone (877) SERV098

Toll Free Fax (877) SERV099

[www.electromate.com](http://www.electromate.com)
[sales@electromate.com](mailto:sales@electromate.com)

## PIN FUNCTIONS

P1 - Signal Connector			
Pin	Name	Description / Notes	I/O
1	PWM INPUT	10 – 25 kHz pulse width modulated digital input command (+5V). Input duty cycle commands the output current.	I
2	SIGNAL GND	Signal Ground	GND
3	DIRECTION	Direction Input (+5 V)	I
4	CURRENT MONITOR	Current Monitor. Analog output signal proportional to the actual current output. Scaling is 6.4 A/V. Measure relative to signal ground.	O
5	INHIBIT IN	TTL level (+5 V) inhibit/enable input. Leave open to enable drive. Pull to ground to inhibit drive. Inhibit turns off all power devices.	I
6	+6V 30mA OUT	+6V @ 30mA power supply for customer use.	O
7	SIGNAL GND	Signal Ground	GND
8	RESERVED		-
9	RESERVED	Reserved	-
10	RESERVED		-
11	CURRENT REFERENCE	Measures the command signal to the internal current-loop. This pin has a maximum output of $\pm 7.45$ V when the drive outputs maximum peak current. Measure relative to signal ground.	O
12	FAULT OUT	TTL level (+5 V) output becomes high when power devices are disabled due to at least one of the following conditions: inhibit, output short circuit, over voltage, over temperature, power-up reset.	O
13	RESERVED		-
14	RESERVED		-
15	RESERVED	Reserved	-
16	RESERVED		-

P2 - Power Connector				
Pin	Name	Description / Notes	I/O	
1b	1a	HIGH VOLTAGE	DC Power Input. 3A Continuous Current Rating Per Pin.	I
2b	2a	HIGH VOLTAGE		I
3b		NC	Not Connected (Reserved) Key: No Connection (pin removed)	-
	3a	NC (KEY)		-
4b	4a	PWR GND	Power Ground (Common With Signal Ground). 3A Continuous Current Rating Per Pin.	GND
5b	5a	PWR GND		GND
6b	6a	RESERVED	Reserved	-
7b	7a	RESERVED		-
8b	8a	MOTOR B	Motor Phase Outputs. Current output distributed equally across 4 pins per motor phase, 3A continuous current carrying capacity per pin.	O
9b	9a	MOTOR B		O
10b	10a	MOTOR A		O
11b	11a	MOTOR A		O

## HARDWARE SETTINGS

### Jumper Settings

Jumper is a SMT, 0 ohm resistor located on the underside of the drive PCB. By default, the drive is configured with the jumper installed. Typical drive operation will not require the jumper to be removed. Please contact the factory before jumper removal.

Jumper	Description	Configuration	
		Not Installed	Installed
JE1	Inhibit logic. Sets the logic level of inhibit pins. Labeled JE1 on the PCB of the drive.	Low Enable	Low Inhibit

Sold & Serviced By:



Toll Free Phone (877) SERV098  
 Toll Free Fax (877) SERV099  
[www.electromate.com](http://www.electromate.com)  
[sales@electromate.com](mailto:sales@electromate.com)

**MECHANICAL INFORMATION**

**P1 - Signal Connector**

Connector Information		16-pin, 2.54 mm spaced header
Mating Connector	Details	Samtec: BCS-116-L-S-PE
	Included with Drive	No

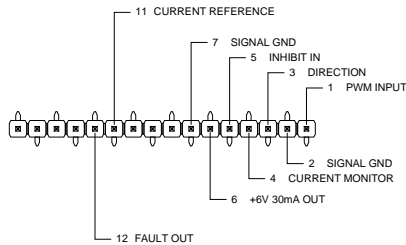

**P2 - Power Connector**

Connector Information		22-pin, 2.54 mm spaced, dual-row header
Mating Connector	Details	Samtec: SSM-111-L-DV
	Included with Drive	No

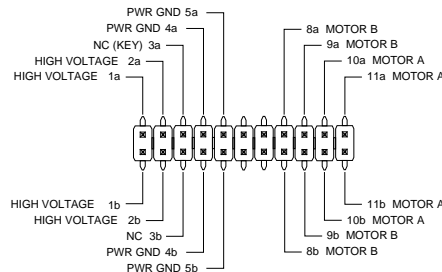

Sold & Serviced By:



Toll Free Phone (877) SERV098

Toll Free Fax (877) SERV099

[www.electromate.com](http://www.electromate.com)

[sales@electromate.com](mailto:sales@electromate.com)

**MOUNTING DIMENSIONS**

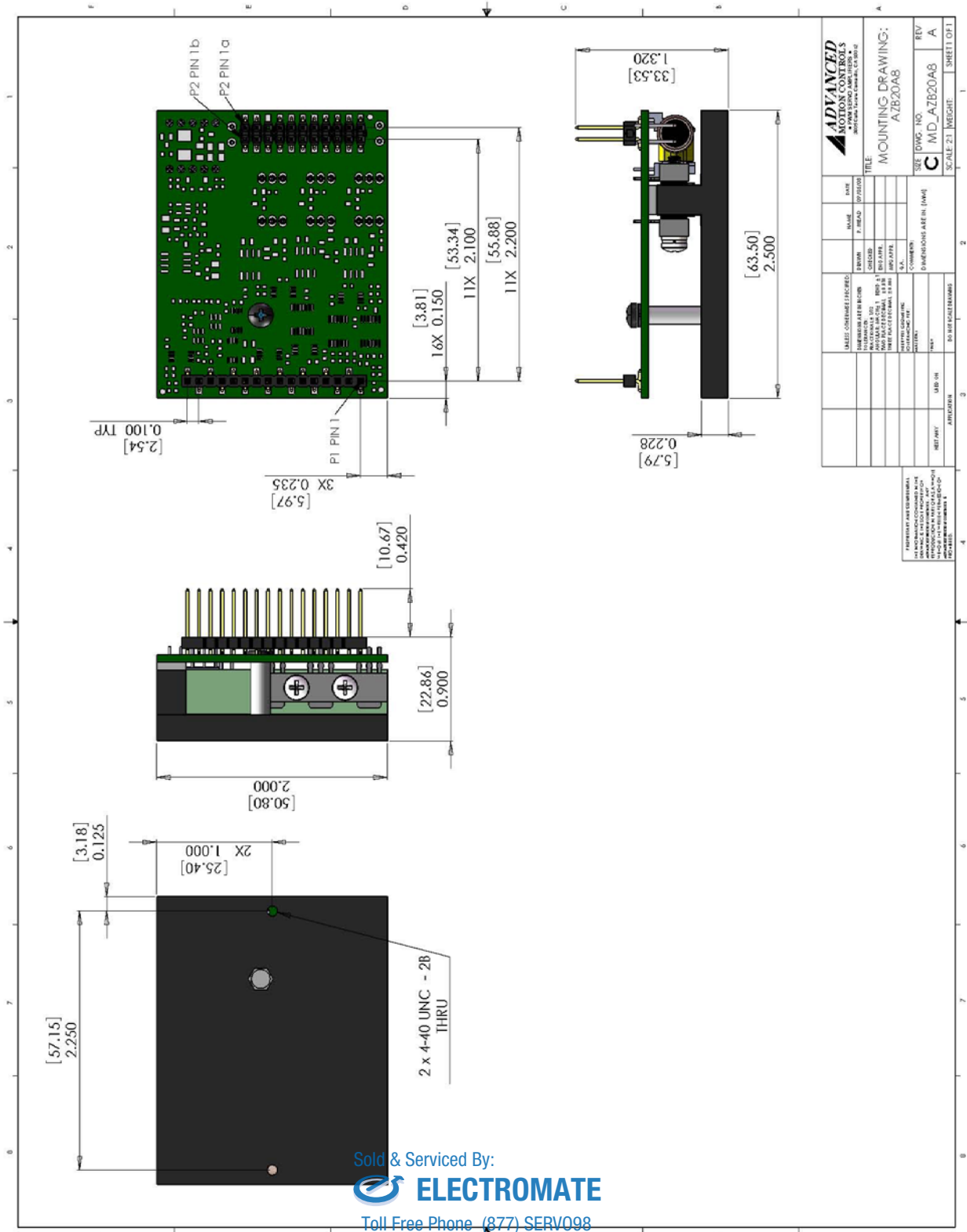

DATE: 07/20/08		NAME: P. HEAD	DATE: 07/20/08
DESIGNED BY: P. HEAD	CHECKED BY: P. HEAD	DATE: 07/20/08	DATE: 07/20/08
TITLE: MOUNTING DRAWING: A.ZB20A8			
SCALE: 2:1		REV: A	SHEET 1 OF 1
DIMENSIONS ARE IN (MM)			

Sold & Serviced By:  
**ELECTROMATE**  
 Toll Free Phone (877) SERV098  
 Toll Free Fax (877) SERV099  
[www.electromate.com](http://www.electromate.com)  
[sales@electromate.com](mailto:sales@electromate.com)

**PART NUMBERING INFORMATION**

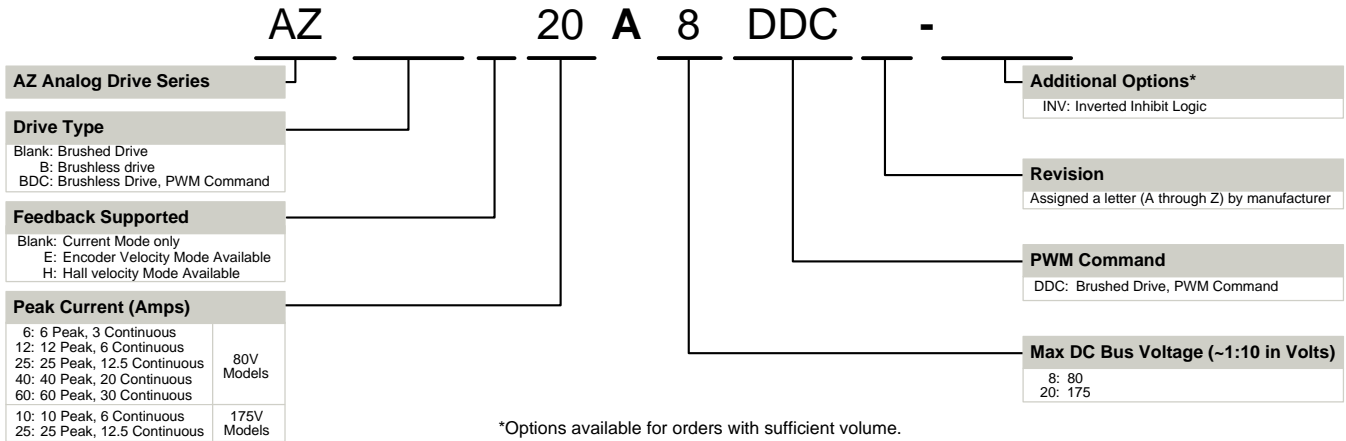

*ADVANCED* Motion Controls AZ series of servo drives are available in many configurations. Note that not all possible part number combinations are offered as standard drives. All models listed in the selection tables of the website are readily available, standard product offerings.

*ADVANCED* Motion Controls also has the capability to promptly develop and deliver specified products for OEMs with volume requests. Our Applications and Engineering Departments will work closely with your design team through all stages of development in order to provide the best servo drive solution for your system. Equipped with on-site manufacturing for quick-turn customs capabilities, *ADVANCED* Motion Controls utilizes our years of engineering and manufacturing expertise to decrease your costs and time-to-market while increasing system quality and reliability.

**Examples of Modifications and Customized Products**

- ▲ Integrate Drive into Motor Housing
- ▲ Mount OEM PCB onto Drive Without Cables
- ▲ Multi-axis Configuration for Compact System
- ▲ Custom PCB and Baseplate for Optimized Footprint
- ▲ RTV/Epoxy Components for High Vibration
- ▲ OEM Specified Connectors for Instant Compatibility
- ▲ OEM Specified Silkscreen for Custom Appearance
- ▲ Increased Thermal Limits for High Temp. Operation
- ▲ Integrate OEM Circuitry onto Drive PCB
- ▲ Custom Control Loop Tuned to Motor Characteristics
- ▲ Custom I/O Interface for System Compatibility
- ▲ Preset Switches and Pots to Reduce User Setup
- ▲ Optimized Switching Frequency
- ▲ Ramped Velocity Command for Smooth Acceleration
- ▲ Remove Unused Features to Reduce OEM Cost
- ▲ Application Specific Current and Voltage Limits

Feel free to contact Applications Engineering for further information and details.

**Available Accessories**

*ADVANCED* Motion Controls offers a variety of accessories designed to facilitate drive integration into a servo system. Visit [www.a-m-c.com](http://www.a-m-c.com) to see which accessories will assist with your application design and implementation.



Sold & Serviced By:



Toll Free Phone (877) SERV098  
Toll Free Fax (877) SERV099  
[www.electromate.com](http://www.electromate.com)  
[sales@electromate.com](mailto:sales@electromate.com)