

FD060-5-CM

FlexPro® Series

Product Status: Active

SPECIFICATIONS

Current Peak	10 A
Current Continuous	5 A
DC Supply Voltage	10 – 55 VDC
Network Communication	CANopen

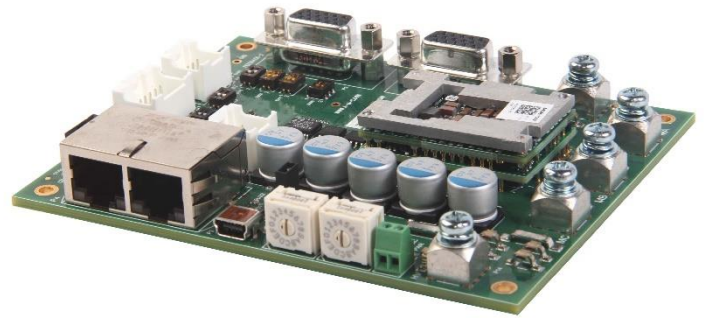

The **FD060-5-CM** is a servo drive and development board assembly for a FE060-5-CM FlexPro® series servo drive with IMPACT™ architecture. Connections to the controller, motor, power, and feedback are simplified through the standard connectors featured on the board. The **FD060-5-CM** is ideal for prototyping and can be used in production and industrial environments as well.

The **FD060-5-CM** offers full tuning control of all servo loops and is designed to drive brushed and brushless servo motors, stepper motors, and AC induction motors. The drive assembly accepts a variety of external command signals, or can use the built-in Motion Engine, an internal motion controller used with Sequencing and Indexing commands. Programmable digital and analog I/O are included to enhance interfacing with external controllers and devices.

The **FD060-5-CM** utilizes CANopen network communication and is configured via USB. All drive and motor parameters are stored in non-volatile memory.

IMPACT™ (Integrated **M**otion **P**latform **A**nd **C**ontrol **T**echnology) combines exceptional processing capability and high-current components to create powerful, compact, feature-loaded servo solutions. IMPACT™ is used in all FlexPro® drives and is available in custom products as well.

FEATURES

- Follows the CAN in Automation (CiA) 301 Communications Profile and 402 Device Profile
- Four Quadrant Regenerative Operation
- Programmable Gain Settings
- PIDF Velocity Loop
- On-the-Fly Mode Switching
- On-the-Fly Gain Set Switching
- Dedicated Safe Torque Off (STO) Inputs
- Bridge Status, Fault and Network Status LEDs
- I/O Status LEDs
- Standard Connections for Easy Setup

Feedback Supported	<ul style="list-style-type: none"> • Absolute Encoder <ul style="list-style-type: none"> ○ BiSS C-Mode ○ EnDat 2.2 • Incremental Encoder • Hall Sensors • Aux Incremental Encoder • ±10 VDC Position • Tachometer (±10V) 	Motors Supported	<ul style="list-style-type: none"> • Three Phase • Single Phase • Stepper • AC Induction 	Modes of Operation	<ul style="list-style-type: none"> • Profile Modes • Cyclic Synchronous Modes • Current • Velocity • Position • Interpolated Position Mode (PVT)
Command Sources	<ul style="list-style-type: none"> • Over the Network • ±10V Analog • Sequencing • Indexing • Jogging • Step & Direction • Encoder Following 	Inputs / Outputs	<ul style="list-style-type: none"> • 4 Programmable Digital Inputs • 3 Programmable Digital Outputs • 1 Programmable Analog Input 	Agency Approvals	<ul style="list-style-type: none"> • RoHS • UL (Pending) • CE (Pending) • TUV Rheinland (STO) (Pending)

BLOCK DIAGRAM

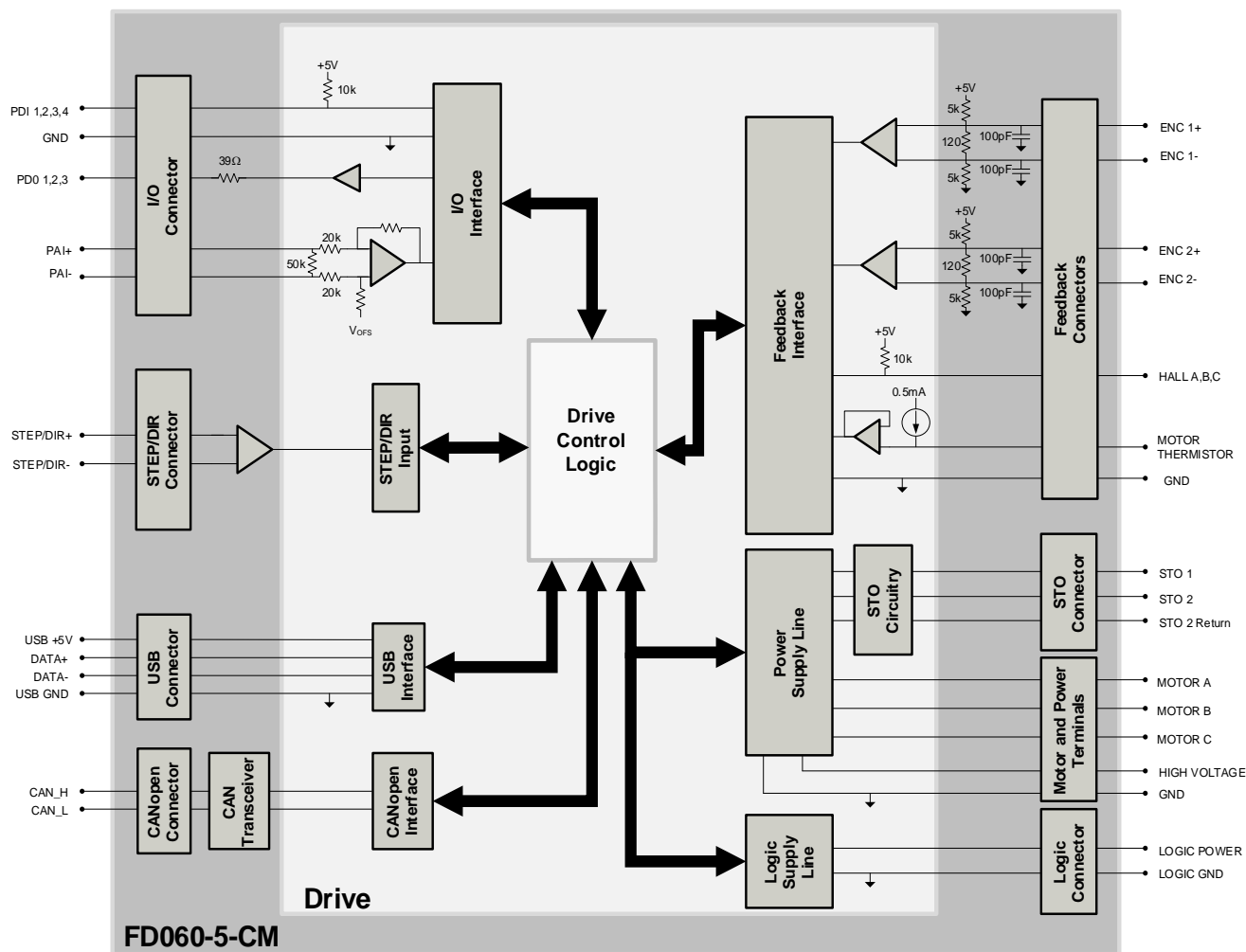

INFORMATION ON APPROVALS AND COMPLIANCES



The RoHS Directive restricts the use of certain substances including lead, mercury, cadmium, hexavalent chromium and halogenated flame retardants PBB and PBDE in electronic equipment.

Sold & Serviced By:

Canadian and International Sales

ELECTROMATE
 877-737-8698
 sales@electromate.com
 www.electromate.com

U.S. Sales

SERVO2GO.com
 877-378-0240
 sales@servo2go.com
 www.servo2go.com

SPECIFICATIONS

Description	Electrical Specifications	
	Units	Value
DC Supply Input Range	VDC	10 – 55
DC Supply Undervoltage	VDC	8
DC Supply Overvoltage	VDC	58
Logic Supply Input Range (optional)	VDC	10 – 55
Safe Torque Off Voltage (Default)	VDC	5
Bus Capacitance	μF	500
Maximum Peak Current Output ¹	A (Arms)	10 (7.07)
Maximum Continuous Current Output ²	A (Arms)	5 (5)
Efficiency at Rated Power	%	99
Maximum Continuous Output Power	W	272
Maximum Power Dissipation at Rated Power	W	3
Minimum Load Inductance (line-to-line) ³	μH	150 (@ 48VDC supply); 75 (@24VDC supply); 40 (@12VDC supply)
Switching Frequency	kHz	20
Maximum Output PWM Duty Cycle	%	85

Description	Control Specifications	
	Units	Value
Communication Interfaces	-	CANopen (USB for configuration)
Command Sources	-	±10 V Analog, Over the Network, Sequencing, Indexing, Jogging, Step & Direction, Encoder Following
Feedback Supported	-	<ul style="list-style-type: none"> o Absolute Encoder (BiSS C-Mode, EnDat 2.2), Incremental Encoder, Hall Sensors, Auxiliary Incremental Encoder, ±10 VDC Position, Tachometer (±10V)
Commutation Methods	-	Sinusoidal, Trapezoidal
Modes of Operation	-	Profile Modes, Cyclic Synchronous Modes, Current, Velocity, Position, Interpolated Position Mode (PVT)
Motors Supported ⁴	-	Three Phase (Brushless Servo), Single Phase (Brushed Servo, Voice Coil, Inductive Load), Stepper (2- or 3-Phase Closed Loop), AC Induction (Closed Loop Vector)
Hardware Protection	-	40+ Configurable Functions, Over Current, Over Temperature (Drive & Motor), Over Voltage, Short Circuit (Phase-Phase & Phase-Ground), Under Voltage
Programmable Digital Inputs/Outputs	-	4/3
Programmable Analog Inputs/Outputs	-	1/0
Primary I/O Logic Level	-	5 VDC, not isolated
Current Loop Sample Time	μs	50
Velocity Loop Sample Time	μs	100
Position Loop Sample Time	μs	100
Maximum Encoder Frequency	MHz	20 (5 pre-quadrature)

Description	Mechanical Specifications	
	Units	Value
Size (H x W x D)	mm (in)	114.3 x 91.4 x 26.0 (4.50 x 3.60 x 1.03)
Weight	g (oz)	178.5 (6.3)
Ambient Operating Temperature Range ⁵	°C (°F)	0 – 65 (32 – 149)
Storage Temperature Range	°C (°F)	-40 – 85 (-40 – 185)
Relative Humidity	-	0-95%, non-condensing
P2 LOGIC POWER CONNECTOR	-	2-port Screw Terminal
P3 USB COMMUNICATION CONNECTOR	-	5-pin, Mini USB B Type port
P5 CANopen COMMUNICATION CONNECTORS	-	8-pin, dual row, 2.00 mm spaced plug terminal
P6 STO CONNECTOR	-	8-pin 2.00 mm spaced, enclosed, friction lock header
P7 IO CONNECTOR	-	12-pin 2.00 mm spaced dual-row plug terminal
P8 STEP/DIR CONNECTOR	-	8-pin 2.00 mm spaced dual-row plug terminal
P9 FEEDBACK 2 CONNECTOR	-	15-pin vertical D-Sub
P10 FEEDBACK 1 CONNECTOR	-	15-pin vertical D-Sub
P11/12/13 MOTOR POWER TERMINALS	-	3x Hex Screw Lug
P14/15 DC POWER TERMINALS	-	2x Hex Screw Lug

Notes

1. Capable of supplying drive rated peak current for 2 seconds with 10 second foldback to continuous value. Longer times are possible with lower current limits.
2. Continuous I_{Arms} value attainable when RMS Charge-Based Limiting is used.
3. Lower inductance is acceptable for bus voltages well below maximum. Use external inductance to meet requirements.
4. Maximum motor speed for stepper motors is 600 RPM. Consult the hardware installation manual for 2-phase stepper wiring configuration.
5. Additional cooling and/or heatsink may be required to achieve rated performance.

PIN FUNCTIONS

P2 – Logic Power Connector			
Pin	Name	Description / Notes	I/O
1	LOGIC PWR	Logic Supply Input (10 – 60VDC) (optional)	I
2	LOGIC GND	Ground	GND
Connector Information		2-port Screw Terminal	
Mating Connector Details		N/A	
Mating Connector Included		N/A	

P3 – USB Communication Connector			
Pin	Name	Description / Notes	I/O
1	VBUS	Supply Voltage	O
2	DATA-	Data -	I/O
3	DATA+	Data +	I/O
4	RESERVED	Reserved.	-
5	GND	Ground	GND
Connector Information		5-pin, Mini USB B Type port	
Mating Connector Details		TYCO: 1496476-3 (2-meter STD-A to MINI-B ASSY)	
Mating Connector Included		No	

P5 – CANopen Communication Connector			
Pin	Name	Description / Notes	I/O
1	RESERVED	Reserved.	-
2	RESERVED	Reserved.	-
3	RESERVED	Reserved.	-
4	RESERVED	Reserved.	-
5	GND	Ground	GND
6	GND	Ground	GND
7	CAN_H	CAN_H bus line (dominant high)	I/O
8	CAN_L	CAN_L bus line (dominant low)	I/O
Connector Information		8-pin, dual row, 2.00 mm spaced plug terminal	
Mating Connector Details		Molex: P/N 51353-0800 (housing); 56134-9100 (contacts)	
Mating Connector Included		Yes	

Sold & Serviced By:

Canadian and International Sales
ELECTROMATE
 877-737-8698
 sales@electromate.com
 www.electromate.com

U.S. Sales
SERVO2GO.com
 877-378-0240
 sales@servo2go.com
 www.servo2go.com

P6 – STO Connector			
Pin	Name	Description / Notes	I/O
1	RESERVED	Reserved.	-
2	RESERVED	Reserved.	-
3	STO RETURN	Safe Torque Off Return	STORET
4	STO-1 INPUT	Safe Torque Off – Input 1	I
5	STO RETURN	Safe Torque Off Return	STORET
6	STO-2 INPUT	Safe Torque Off – Input 2	I
7	RESERVED	Reserved.	-
8	RESERVED	Reserved.	-

Connector Information	8-port, 2.00 mm spaced, enclosed, friction lock header	
Mating Connector Details	Molex: P/N 51110-0860 (housing); 50394-8051 (pins)	
Mating Connector Included	Yes	

P7 – IO Connector			
Pin	Name	Description / Notes	I/O
1	PDI-1	General Purpose Programmable Digital Input	I
2	PDI-2	General Purpose Programmable Digital Input	I
3	PDI-3	General Purpose Programmable Digital Input	I
4	PDI-4	General Purpose Programmable Digital Input	I
5	PDO-1	General Purpose Programmable Digital Output (TTL/8mA)	O
6	PDO-2	General Purpose Programmable Digital Output (TTL/8mA)	O
7	PDO-3	General Purpose Programmable Digital Output (TTL/8mA)	O
8	+5V OUT	+5V Supply Output. Short-circuit protected. (300ma total load capacity shared between P7-8, P8-7, P9-13, and P10-13)	O
9	GND	Ground.	GND
10	GND	Ground.	GND
11	PAI-1+	General Purpose Differential Programmable Analog Input or Reference Signal Input.	I
12	PAI-1-	±10VDC Range (12-bit Resolution)	I

Connector Information	12-pin, dual row, 2.00 mm spaced plug terminal	
Mating Connector Details	Molex: P/N 51353-1200 (housing); 56134-9100 (contacts)	
Mating Connector Included	Yes	

P8 – STEP/DIR Connector				
Pin	Name	Description / Notes	I/O	
1	STEP +	Differential Step Input.	I	
2	STEP -		I	
3	DIR +		Differential Direction Input.	I
4	DIR -			I
5	RESERVED	Reserved.	-	
6	RESERVED		-	
7	+5V OUT	+5V Supply Output. Short-circuit protected. (300ma total load capacity shared between P7-8, P8-7, P9-13, and P10-13)	O	
8	GND	Ground.	GND	

Connector Information	8-pin, dual row, 2.00 mm spaced plug terminal	
Mating Connector Details	Molex: P/N 51353-0800 (housing); 56134-9100 (contacts)	
Mating Connector Included	Yes	

P9 – Feedback 2 Connector



Pin	Incremental Encoder	Description / Notes	I/O
1	HALL A	Single-ended Commutation Sensor Inputs. Signals shared with Feedback 1 connector. Use only Hall connections on either Feedback 1 or Feedback 2.	I
2	HALL B		I
3	HALL C		I
4	ENC 2 A+	Differential Incremental Encoder A.	I
5	ENC 2 A-		I
6	ENC 2 B+		I
7	ENC 2 B-	Differential Incremental Encoder B.	I
8	ENC 2 INDEX+	Differential Incremental Encoder Index.	I
9	ENC 2 INDEX-		I
10	RESERVED	Reserved.	-
11	RESERVED	Reserved.	-
12	GND	Ground.	GND
13	+5V OUT	+5V Supply Output. Short-circuit protected. (300ma total load capacity shared between P7-8, P8-7, P9-13, and P10-13)	O
14	THERMISTOR	Motor Thermal Protection. Select which Thermistor pin is active using DIP Switch SW6 (see Board Configuration section below). Only one Thermistor pin between Feedback 1 and Feedback 2 Connector can be active.	I
15	RESERVED	Reserved.	-



Connector Information	15-pin, high-density, female D-sub	
Mating Connector Details	TYCO: Plug P/N 748364-1; Housing P/N 5748677-2; Terminals P/N 1658670-2 (loose) or 1658670-1 (strip)	
Mating Connector Included	No	

P10 – Feedback 1 Connector

Pin	Absolute Encoder	Incremental Encoder	Description / Notes	I/O
1	HALL A	HALL A	Single-ended Commutation Sensor Inputs. Signals shared with Feedback 2 connector. Use only Hall connections on either Feedback 1 or Feedback 2.	I
2	HALL B	HALL B		I
3	HALL C	HALL C		I
4	ENC 1 DATA+	ENC 1 A+	Differential Data Line for Absolute Encoders (BiSS: SLO+/-) or Differential Incremental Encoder A.	I
5	ENC 1 DATA-	ENC 1 A-		I
6	ENC 1 CLOCK+	ENC 1 B+	Differential Clock Line for Absolute Encoders (BiSS: MA+/-) or Differential Incremental Encoder B.	I
7	ENC 1 CLOCK-	ENC 1 B-		I
8	ENC 1 REF MARK+	ENC 1 I+	Differential Reference Mark for Absolute Encoders (Leave open for BiSS and EnDat 2.2) or Differential Incremental Encoder Index.	I
9	ENC 1 REF MARK-	ENC 1 I-		I
10	RESERVED	RESERVED	Reserved.	-
11	RESERVED	RESERVED	Reserved.	-
12	GND	GND	Ground.	GND
13	+5V OUT	+5V OUT	+5V Supply Output. Short-circuit protected. (300ma total load capacity shared between P7-8, P8-7, P9-13, and P10-13)	O
14	THERMISTOR	THERMISTOR	Motor Thermal Protection. Select which Thermistor pin is active using DIP Switch SW6 (see Board Configuration section below). Only one Thermistor pin between Feedback 1 and Feedback 2 Connector can be active.	I
15	RESERVED	RESERVED	Reserved.	-

Connector Information	15-pin, high-density, female D-sub	
Mating Connector Details	TYCO: Plug P/N 748364-1; Housing P/N 5748677-2; Terminals P/N 1658670-2 (loose) or 1658670-1 (strip)	
Mating Connector Included	No	

P11/12/13 - Motor Power Terminals			
Pin	Name	Description / Notes	I/O
1	MOTOR A	Motor Phase A.	O
2	MOTOR B	Motor Phase B.	O
3	MOTOR C	Motor Phase C.	O
Connector Information		Bushings with M4 Screw	<div style="display: flex; justify-content: space-around;"> <div style="text-align: center;"> <p>MOTOR C</p>  </div> <div style="text-align: center;"> <p>MOTOR B</p>  </div> <div style="text-align: center;"> <p>MOTOR A</p>  </div> </div>
Mating Connector Details		N/A	
Mating Connector Included		N/A	

P14/15 - DC Power Terminals			
Pin	Name	Description / Notes	I/O
1	HV	DC Supply Input (10-55 VDC).	I
2	POWER GND	Ground.	GND
Connector Information		Bushings with M4 Screw	<div style="display: flex; justify-content: space-around;"> <div style="text-align: center;"> <p>HV</p>  </div> <div style="text-align: center;"> <p>POWER GND</p>  </div> </div>
Mating Connector Details		N/A	
Mating Connector Included		N/A	

Sold & Serviced By:

Canadian and International Sales

ELECTROMATE
 877-737-8698
sales@electromate.com
www.electromate.com

U.S. Sales

SERVO2GO.com
 877-378-0240
sales@servo2go.com
www.servo2go.com

BOARD CONFIGURATION

Status LED Functions

LED	Description
STAT	Indicates drive power bridge status. GREEN when DC bus power is applied and the drive is enabled. RED when the drive is in a fault state.
LOGIC PWR	Indicates that +5V logic power is available to the drive. GREEN when +5V logic power is available.
EMA	Indicates whether the Emulated Encoder Output functionality is active. GREEN for Emulated Encoder Output active. OFF for Step & Direction Input or PWM & Direction Input.
SEL	Indicates whether CANopen communication is selected. GREEN for CANopen.

Input/Output LED Functions

LED	Description
DI1 – DI4	Indicates digital input status. GREEN when the corresponding digital input is active.
DO1 – DO3	Indicates digital output status. BLUE when the corresponding digital output is active

CANopen Node ID Switches

Switch Diagram	Description																								
<p>SW3 SW4</p>	<p>Hexadecimal switch settings correspond to the CANopen Node ID. Allowable CANopen Node ID range using the rotary switches is 1 - 63. Node IDs above 63 can be set via ACE setup software or network commands and stored to NVM (up to a Node ID of 127). Setting the rotary switches to zero will use the address stored in NVM.</p> <table border="1"> <thead> <tr> <th>SW3</th> <th>SW4</th> <th>Node ID</th> </tr> </thead> <tbody> <tr> <td>0</td> <td>0</td> <td>Address stored in NVM</td> </tr> <tr> <td>0</td> <td>1</td> <td>001</td> </tr> <tr> <td>0</td> <td>2</td> <td>002</td> </tr> <tr> <td>...</td> <td>...</td> <td>...</td> </tr> <tr> <td>3</td> <td>D</td> <td>61</td> </tr> <tr> <td>3</td> <td>E</td> <td>62</td> </tr> <tr> <td>3</td> <td>F</td> <td>63</td> </tr> </tbody> </table>	SW3	SW4	Node ID	0	0	Address stored in NVM	0	1	001	0	2	002	3	D	61	3	E	62	3	F	63
SW3	SW4	Node ID																							
0	0	Address stored in NVM																							
0	1	001																							
0	2	002																							
...																							
3	D	61																							
3	E	62																							
3	F	63																							

DIP Switches

Switch	Description	ON	OFF
SW6	Motor Thermistor Selection. Note that both switches on SW6 must be set to the same position for proper operation.	Uses the motor thermistor reading from P9 – Feedback 2 Connector	Uses the motor thermistor reading from P10 – Feedback 1 Connector
SW9	CAN Termination. The last device in a CAN network requires termination. Note that both switches on SW9 must be set to the same position for proper operation.	Terminated	Not terminated
SW10	CAN Communication Selection. Note that all 4 switches of SW10 and SW11 must be set to the same position for proper operation.	RS232/485	CAN
SW11			

Safe Torque Off (STO) Inputs

The Safe Torque Off (STO) inputs are dedicated +5VDC sinking single-ended inputs. For applications not using STO functionality, disabling of the STO feature is required for proper drive operation. STO may be disabled by installing the included mating connector for the STO connector and following the STO Disable wiring instructions as given in the hardware installation manual. Consult the hardware installation manual for more information. Alternatively, a dedicated STO Disable Key connector is available for purchase for applications where STO is not in use. Contact the factory for ordering information.

MOUNTING DIMENSIONS

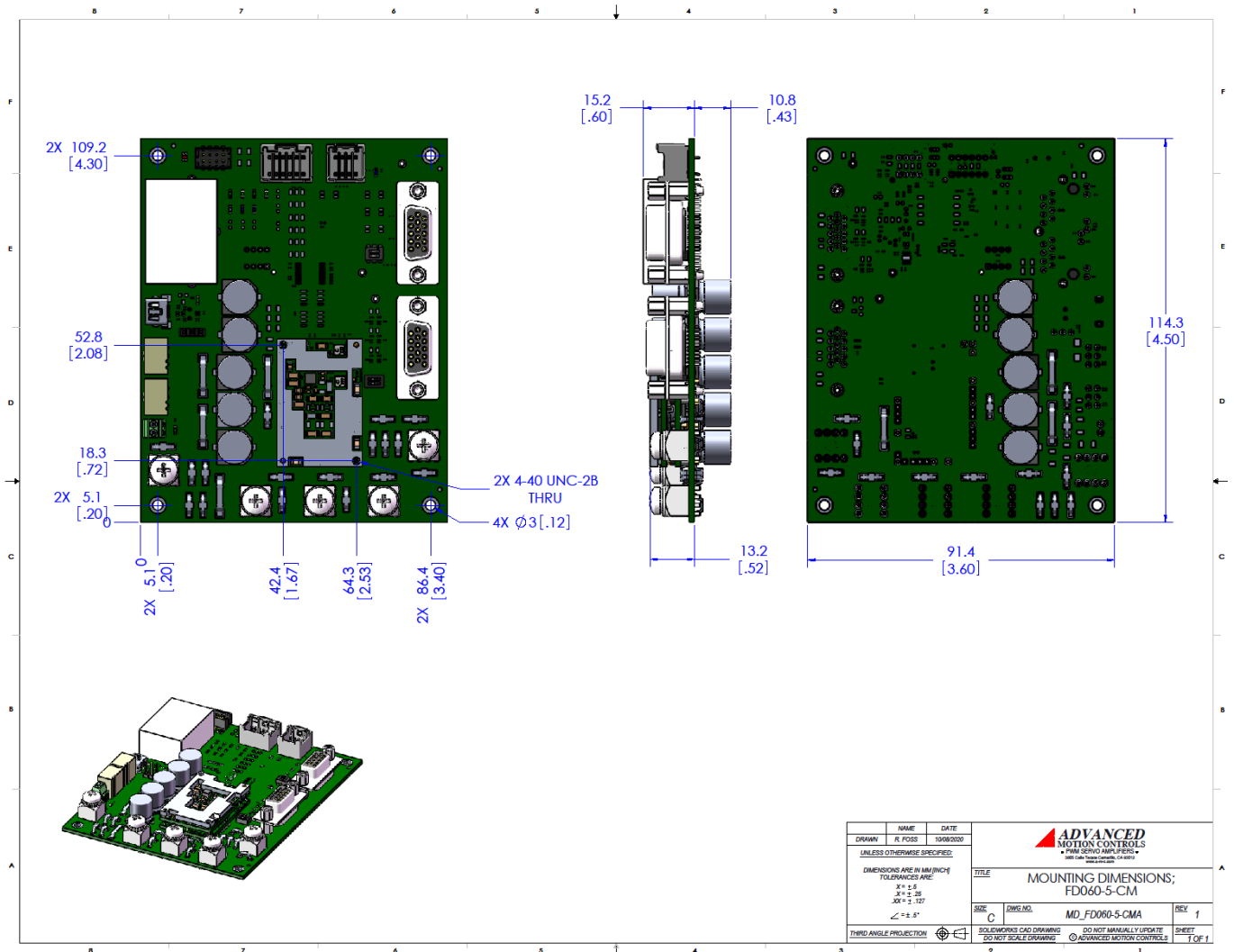

Sold & Serviced By:



Canadian and International Sales

ELECTROMATE

877-737-8698

sales@electromate.com

www.electromate.com

U.S. Sales



877-378-0240

sales@servo2go.com

www.servo2go.com

PART NUMBERING AND CUSTOMIZATION INFORMATION

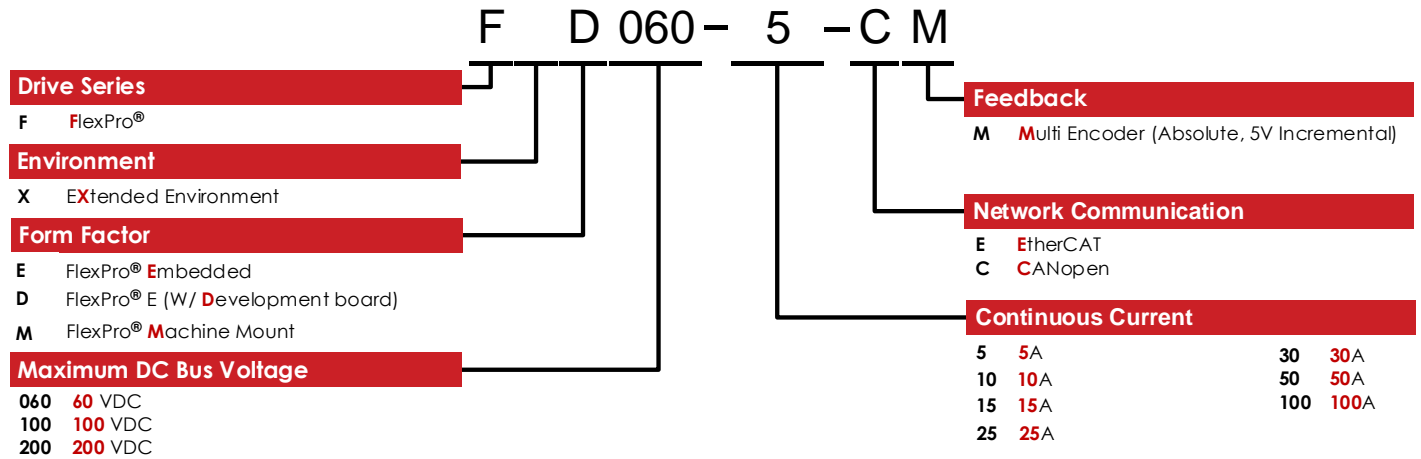

ADVANCED Motion Controls also has the capability to promptly develop and deliver specified products for OEMs with volume requests. Our Applications and Engineering Departments will work closely with your design team through all stages of development in order to provide the best servo drive solution for your system. Equipped with on-site manufacturing for quick-turn customs capabilities, ADVANCED Motion Controls utilizes our years of engineering and manufacturing expertise to decrease your costs and time-to-market while increasing system quality and reliability.

Examples of Customized Products

- | | |
|--|--|
| <ul style="list-style-type: none"> ▲ Optimized Footprint ▲ Private Label Software ▲ OEM Specified Connectors ▲ No Outer Case ▲ Increased Current Resolution ▲ Increased Temperature Range ▲ Custom Control Interface ▲ Integrated System I/O | <ul style="list-style-type: none"> ▲ Tailored Project File ▲ Silkscreen Branding ▲ Optimized Base Plate ▲ Increased Current Limits ▲ Increased Voltage Range ▲ Conformal Coating ▲ Multi-Axis Configurations ▲ Reduced Profile Size and Weight |
|--|--|

Feel free to contact us for further information and details!

Available Accessories

ADVANCED Motion Controls offers a variety of accessories designed to facilitate drive integration into a servo system. Visit www.a-m-c.com to see which accessories will assist with your application design and implementation.

Sold & Serviced By:

Canadian and International Sales

ELECTROMATE

877-737-8698
sales@electromate.com
www.electromate.com

U.S. Sales

SERVO2GO.com

877-378-0240
sales@servo2go.com
www.servo2go.com

All specifications in this document are subject to change without written notice. Actual product may differ from pictures provided in this document.