

# FD060-25-EM

FlexPro® Series

**Product Status:** Active

## SPECIFICATIONS

Current Peak	<b>50 A</b>
Current Continuous	<b>25 A</b>
DC Supply Voltage	<b>10 – 55 VDC</b>
Network Communication	<b>EtherCAT</b>



The **FD060-25-EM** is a servo drive and development board assembly for a FE060-25-EM FlexPro® series servo drive with IMPACT™ architecture. Connections to the controller, motor, power, and feedback are simplified through the standard connectors featured on the board. The **FD060-25-EM** is ideal for prototyping and can be used in production and industrial environments as well.

The **FD060-25-EM** offers full tuning control of all servo loops and is designed to drive brushed and brushless servo motors, stepper motors, and AC induction motors. The drive assembly accepts a variety of external command signals, or can use the built-in Motion Engine, an internal motion controller used with Sequencing and Indexing commands. Programmable digital and analog I/O are included to enhance interfacing with external controllers and devices.

The **FD060-25-EM** utilizes EtherCAT® network communication using CANopen over EtherCAT (CoE) and is configured via USB. All drive and motor parameters are stored in non-volatile memory.

IMPACT™ (Integrated **M**otion **P**latform **A**nd **C**ontrol **T**echnology) combines exceptional processing capability and high-current components to create powerful, compact, feature-loaded servo solutions. IMPACT™ is used in all FlexPro® drives and is available in custom products as well.

## FEATURES

- CoE – Based on DSP-402 Device Profile for Drives and Motion Control
- Synchronization using Distributed Clocks
- Position Cycle Times down to 100µs
- Four Quadrant Regenerative Operation
- Programmable Gain Settings
- PIDF Velocity Loop
- On-the-Fly Mode Switching
- On-the-Fly Gain Set Switching
- Dedicated Safe Torque Off (STO) Inputs
- Bridge Status, Fault and Network Status LEDs
- I/O Status LEDs
- Standard Connections for Easy Setup

<b>Feedback Supported</b>	<ul style="list-style-type: none"> <li>• Absolute Encoder                             <ul style="list-style-type: none"> <li>◦ BiSS C-Mode</li> </ul> </li> <li>• Incremental Encoder</li> <li>• Hall Sensors</li> <li>• Aux Incremental Encoder</li> <li>• ±10 VDC Position</li> <li>• Tachometer (±10V)</li> </ul>	<b>Motors Supported</b>	<ul style="list-style-type: none"> <li>• Three Phase</li> <li>• Single Phase</li> <li>• Stepper</li> <li>• AC Induction</li> </ul>	<b>Modes of Operation</b>	<ul style="list-style-type: none"> <li>• Profile Modes</li> <li>• Cyclic Synchronous Modes</li> <li>• Current</li> <li>• Velocity</li> <li>• Position</li> </ul>
<b>Command Sources</b>	<ul style="list-style-type: none"> <li>• Over the Network</li> <li>• ±10V Analog</li> <li>• Sequencing</li> <li>• Indexing</li> <li>• Jogging</li> <li>• Step &amp; Direction</li> <li>• Encoder Following</li> </ul>	<b>Inputs / Outputs</b>	<ul style="list-style-type: none"> <li>• 4 Programmable Digital Inputs</li> <li>• 3 Programmable Digital Outputs</li> <li>• 1 Programmable Analog Input</li> </ul>	<b>Agency Approvals</b>	<ul style="list-style-type: none"> <li>• RoHS</li> <li>• UL (Pending)</li> <li>• CE (Pending)</li> <li>• TUV Rheinland (STO) (Pending)</li> </ul>

**BLOCK DIAGRAM**

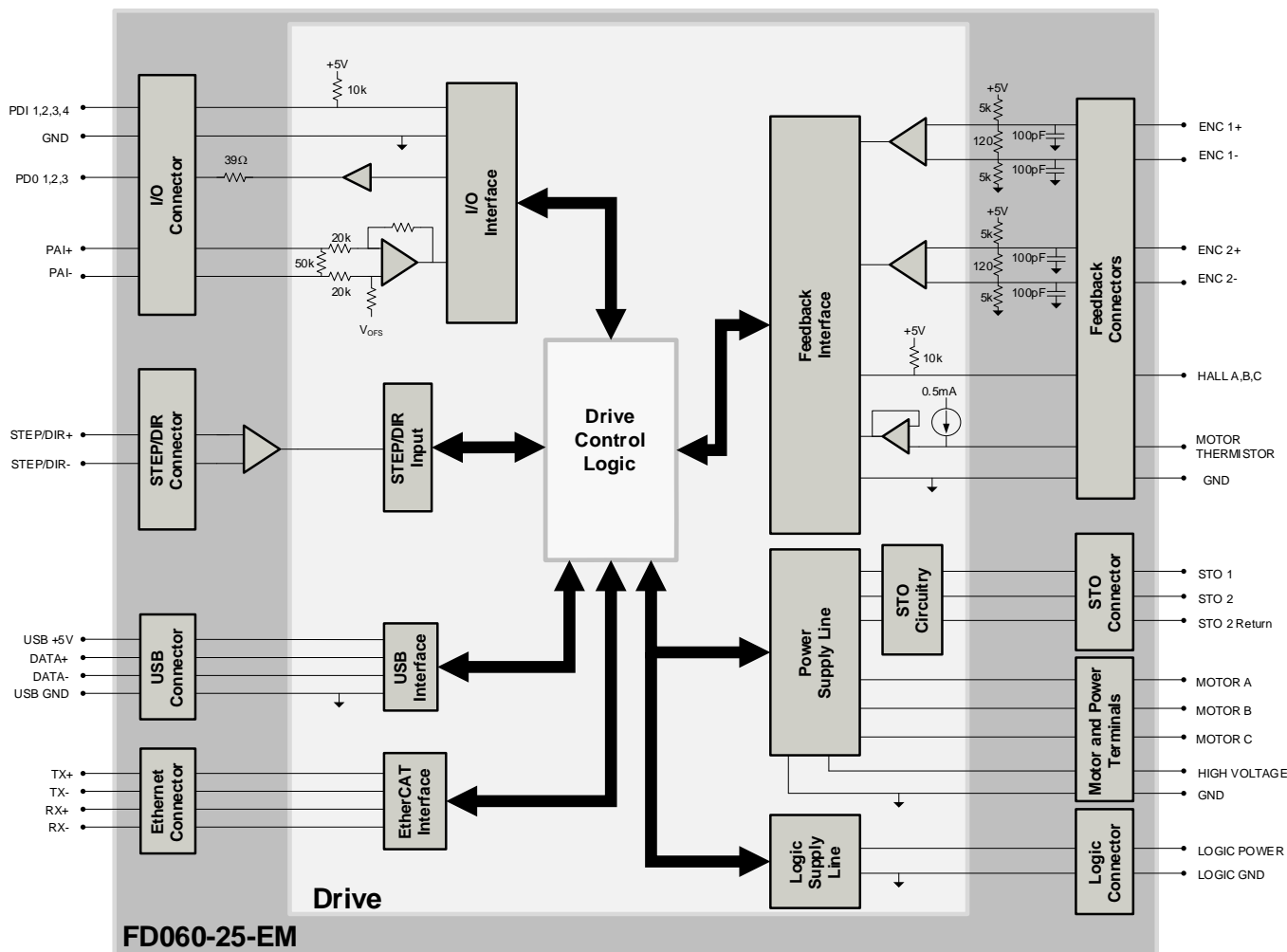

**INFORMATION ON APPROVALS AND COMPLIANCES**



The RoHS Directive restricts the use of certain substances including lead, mercury, cadmium, hexavalent chromium and halogenated flame retardants PBB and PBDE in electronic equipment.

Sold & Serviced By:



Canadian and International Sales

**ELECTROMATE**

877-737-8698

sales@electromate.com

www.electromate.com

U.S. Sales



877-378-0240

sales@servo2go.com

www.servo2go.com

**SPECIFICATIONS**

Description	Electrical Specifications	
	Units	Value
DC Supply Input Range	VDC	10 – 55
DC Supply Undervoltage	VDC	8
DC Supply Overvoltage	VDC	58
Logic Supply Input Range (optional)	VDC	10 – 55
Safe Torque Off Voltage (Default)	VDC	5
Bus Capacitance	μF	500
Maximum Peak Current Output <sup>1</sup>	A (Arms)	50 (35.3)
Maximum Continuous Current Output <sup>2</sup>	A (Arms)	25 (25)
Efficiency at Rated Power	%	99
Maximum Continuous Output Power	W	1361
Maximum Power Dissipation at Rated Power	W	14
Minimum Load Inductance (line-to-line) <sup>3</sup>	μH	150 (@ 48VDC supply); 75 (@24VDC supply); 40 (@12VDC supply)
Switching Frequency	kHz	20
Maximum Output PWM Duty Cycle	%	85

Description	Control Specifications	
	Units	Value
Communication Interfaces <sup>4</sup>	-	EtherCAT® (USB for configuration)
Command Sources	-	±10 V Analog, Over the Network, Sequencing, Indexing, Jogging, Step & Direction, Encoder Following
Feedback Supported	-	Absolute Encoder (BiSS C-Mode), Incremental Encoder, Hall Sensors, Auxiliary Incremental Encoder, ±10 VDC Position, Tachometer (±10V)
Commutation Methods	-	Sinusoidal, Trapezoidal
Modes of Operation	-	Profile Modes, Cyclic Synchronous Modes, Current, Velocity, Position
Motors Supported <sup>5</sup>	-	Three Phase (Brushless Servo), Single Phase (Brushed Servo, Voice Coil, Inductive Load), Stepper (2- or 3-Phase Closed Loop), AC Induction (Closed Loop Vector)
Hardware Protection	-	40+ Configurable Functions, Over Current, Over Temperature (Drive & Motor), Over Voltage, Short Circuit (Phase-Phase & Phase-Ground), Under Voltage
Programmable Digital Inputs/Outputs	-	4/3
Programmable Analog Inputs/Outputs	-	1/0
Primary I/O Logic Level	-	5 VDC, not isolated
Current Loop Sample Time	μs	50
Velocity Loop Sample Time	μs	100
Position Loop Sample Time	μs	100
Maximum Encoder Frequency	MHz	20 (5 pre-quadrature)

Description	Mechanical Specifications	
	Units	Value
Size (H x W x D)	mm (in)	114.3 x 91.4 x 27.8 (4.50 x 3.60 x 1.09)
Weight	g (oz)	181.4 (6.4)
Ambient Operating Temperature Range <sup>6</sup>	°C (°F)	0 – 65 (32 – 149)
Storage Temperature Range	°C (°F)	-40 – 85 (-40 – 185)
Relative Humidity	-	0-95%, non-condensing
P2 LOGIC POWER CONNECTOR	-	2-port Screw Terminal
P3 USB COMMUNICATION CONNECTOR	-	5-pin, Mini USB B Type port
P4 ETHERCAT COMMUNICATION CONNECTORS	-	Shielded, Dual RJ-45 socket with LEDs
P6 STO CONNECTOR	-	8-pin 2.00 mm spaced, enclosed, friction lock header
P7 IO CONNECTOR	-	12-pin 2.00 mm spaced dual-row plug terminal
P8 STEP/DIR CONNECTOR	-	8-pin 2.00 mm spaced dual-row plug terminal
P9 FEEDBACK 2 CONNECTOR	-	15-pin vertical D-Sub
P10 FEEDBACK 1 CONNECTOR	-	15-pin vertical D-Sub
P11/12/13 MOTOR POWER TERMINALS	-	3x Hex Screw Lug
P14/15 DC POWER TERMINALS	-	2x Hex Screw Lug

**Notes**

1. Capable of supplying drive rated peak current for 2 seconds with 10 second foldback to continuous value. Longer times are possible with lower current limits.
2. Continuous  $A_{rms}$  value attainable when RMS Charge-Based Limiting is used.
3. Lower inductance is acceptable for bus voltages well below maximum. Use external inductance to meet requirements.
4. EtherCAT® is a registered trademark and patented technology, licensed by Beckhoff Automation GmbH, Germany.
5. Maximum motor speed for stepper motors is 600 RPM. Consult the hardware installation manual for 2-phase stepper wiring configuration.
6. Additional cooling and/or heatsink may be required to achieve rated performance.

**PIN FUNCTIONS**

**P2 – Logic Power Connector**

Pin	Name	Description / Notes	I/O
1	LOGIC PWR	Logic Supply Input (10 – 60VDC) (optional)	I
2	LOGIC GND	Ground	GND

<b>Connector Information</b>	2-port Screw Terminal	
<b>Mating Connector Details</b>	N/A	
<b>Mating Connector Included</b>	N/A	

**P3 – USB Communication Connector**

Pin	Name	Description / Notes	I/O
1	VBUS	Supply Voltage	O
2	DATA-	Data -	I/O
3	DATA+	Data +	I/O
4	RESERVED	Reserved.	-
5	GND	Ground	GND

<b>Connector Information</b>	5-pin, Mini USB B Type port	
<b>Mating Connector Details</b>	TYCO: 1496476-3 (2-meter STD-A to MINI-B ASSY)	
<b>Mating Connector Included</b>	No	

**P4 – EtherCAT / Ethernet Communication Connectors**

Pin	Name	Description / Notes	I/O
1	RX+	Receiver + (100Base-TX)	I
2	RX-	Receiver - (100Base-TX)	I
3	TX+	Transmitter + (100Base-TX)	O
4	RESERVED	Reserved.	-
5	RESERVED	Reserved.	-
6	TX-	Transmitter - (100Base-TX)	O
7	RESERVED	Reserved.	-
8	RESERVED	Reserved.	-

<b>Connector Information</b>	Shielded, dual RJ-45 socket with LEDs	
<b>Mating Connector Details</b>	CAT 5 Cable	
<b>Mating Connector Included</b>	No	

Sold & Serviced By:

Canadian and International Sales  
  
**ELECTROMATE**  
 877-737-8698  
 sales@electromate.com  
 www.electromate.com

U.S. Sales  
  
**SERVO2GO.com**  
 877-378-0240  
 sales@servo2go.com  
 www.servo2go.com

P6 – STO Connector			
Pin	Name	Description / Notes	I/O
1	RESERVED	Reserved.	-
2	RESERVED	Reserved.	-
3	STO RETURN	Safe Torque Off Return	STORET
4	STO-1 INPUT	Safe Torque Off – Input 1	I
5	STO RETURN	Safe Torque Off Return	STORET
6	STO-2 INPUT	Safe Torque Off – Input 2	I
7	RESERVED	Reserved.	-
8	RESERVED	Reserved.	-

<b>Connector Information</b>	8-port, 2.00 mm spaced, enclosed, friction lock header	
<b>Mating Connector Details</b>	Molex: P/N 51110-0860 (housing); 50394-8051 (pins)	
<b>Mating Connector Included</b>	Yes	

P7 – IO Connector			
Pin	Name	Description / Notes	I/O
1	PDI-1	General Purpose Programmable Digital Input	I
2	PDI-2	General Purpose Programmable Digital Input	I
3	PDI-3	General Purpose Programmable Digital Input	I
4	PDI-4	General Purpose Programmable Digital Input	I
5	PDO-1	General Purpose Programmable Digital Output (TTL/8mA)	O
6	PDO-2	General Purpose Programmable Digital Output (TTL/8mA)	O
7	PDO-3	General Purpose Programmable Digital Output (TTL/8mA)	O
8	+5V OUT	+5V Supply Output. Short-circuit protected. (300ma total load capacity shared between P7-8, P8-7, P9-13, and P10-13)	O
9	GND	Ground.	GND
10	GND	Ground.	GND
11	PAI-1+	General Purpose Differential Programmable Analog Input or Reference Signal Input. ±10VDC Range (12-bit Resolution)	I
12	PAI-1-		I

<b>Connector Information</b>	12-pin, dual row, 2.00 mm spaced plug terminal	
<b>Mating Connector Details</b>	Molex: P/N 51353-1200 (housing); 56134-9100 (contacts)	
<b>Mating Connector Included</b>	Yes	

P8 – STEP/DIR Connector				
Pin	Name	Description / Notes	I/O	
1	STEP +	Differential Step Input.	I	
2	STEP -		I	
3	DIR +		Differential Direction Input.	I
4	DIR -			I
5	RESERVED	Reserved.	-	
6	RESERVED		-	
7	+5V OUT	+5V Supply Output. Short-circuit protected. (300ma total load capacity shared between P7-8, P8-7, P9-13, and P10-13)	O	
8	GND	Ground.	GND	

<b>Connector Information</b>	8-pin, dual row, 2.00 mm spaced plug terminal	
<b>Mating Connector Details</b>	Molex: P/N 51353-0800 (housing); 56134-9100 (contacts)	
<b>Mating Connector Included</b>	Yes	

**P9 – Feedback 2 Connector**



Pin	Incremental Encoder	Description / Notes	I/O
1	HALL A	Single-ended Commutation Sensor Inputs. Signals shared with Feedback 1 connector. Use only Hall connections on either Feedback 1 or Feedback 2.	I
2	HALL B		I
3	HALL C		I
4	ENC 2 A+	Differential Incremental Encoder A.	I
5	ENC 2 A-		I
6	ENC 2 B+	Differential Incremental Encoder B.	I
7	ENC 2 B-		I
8	ENC 2 INDEX+	Differential Incremental Encoder Index.	I
9	ENC 2 INDEX-		I
10	RESERVED	Reserved.	-
11	RESERVED	Reserved.	-
12	GND	Ground.	GND
13	+5V OUT	+5V Supply Output. Short-circuit protected. (300ma total load capacity shared between P7-8, P8-7, P9-13, and P10-13)	O
14	THERMISTOR	Motor Thermal Protection. Select which Thermistor pin is active using DIP Switch SW6 (see Board Configuration section below). Only one Thermistor pin between Feedback 1 and Feedback 2 Connector can be active.	I
15	RESERVED	Reserved.	-



<b>Connector Information</b>	15-pin, high-density, female D-sub	
<b>Mating Connector Details</b>	TYCO: Plug P/N 748364-1; Housing P/N 5748677-2; Terminals P/N 1658670-2 (loose) or 1658670-1 (strip)	
<b>Mating Connector Included</b>	No	

**P10 – Feedback 1 Connector**

Pin	Absolute Encoder	Incremental Encoder	Description / Notes	I/O
1	HALL A	HALL A	Single-ended Commutation Sensor Inputs. Signals shared with Feedback 2 connector. Use only Hall connections on either Feedback 1 or Feedback 2.	I
2	HALL B	HALL B		I
3	HALL C	HALL C		I
4	ENC 1 DATA+	ENC 1 A+	Differential Data Line for Absolute Encoders (BiSS: SLO+/-) or Differential Incremental Encoder A.	I
5	ENC 1 DATA-	ENC 1 A-		I
6	ENC 1 CLOCK+	ENC 1 B+	Differential Clock Line for Absolute Encoders (BiSS: MA+/-) or Differential Incremental Encoder B.	I
7	ENC 1 CLOCK-	ENC 1 B-		I
8	ENC 1 REF MARK+	ENC 1 I+	Differential Reference Mark for Absolute Encoders (Leave open for BiSS and EnDat 2.2) or Differential Incremental Encoder Index.	I
9	ENC 1 REF MARK-	ENC 1 I-		I
10	RESERVED	RESERVED	Reserved.	-
11	RESERVED	RESERVED	Reserved.	-
12	GND	GND	Ground.	GND
13	+5V OUT	+5V OUT	+5V Supply Output. Short-circuit protected. (300ma total load capacity shared between P7-8, P8-7, P9-13, and P10-13)	O
14	THERMISTOR	THERMISTOR	Motor Thermal Protection. Select which Thermistor pin is active using DIP Switch SW6 (see Board Configuration section below). Only one Thermistor pin between Feedback 1 and Feedback 2 Connector can be active.	I
15	RESERVED	RESERVED	Reserved.	-

<b>Connector Information</b>	15-pin, high-density, female D-sub	
<b>Mating Connector Details</b>	TYCO: Plug P/N 748364-1; Housing P/N 5748677-2; Terminals P/N 1658670-2 (loose) or 1658670-1 (strip)	
<b>Mating Connector Included</b>	No	

P11/12/13 - Motor Power Terminals			
Pin	Name	Description / Notes	I/O
1	MOTOR A	Motor Phase A.	○
2	MOTOR B	Motor Phase B.	○
3	MOTOR C	Motor Phase C.	○
<b>Connector Information</b>		Bushings with M4 Screw	<div style="display: flex; justify-content: space-around;"> <div style="text-align: center;"> <p>MOTOR C</p>  </div> <div style="text-align: center;"> <p>MOTOR B</p>  </div> <div style="text-align: center;"> <p>MOTOR A</p>  </div> </div>
<b>Mating Connector Details</b>		N/A	
<b>Mating Connector Included</b>		N/A	

P14/15 - DC Power Terminals			
Pin	Name	Description / Notes	I/O
1	HV	DC Supply Input (10-55 VDC).	I
2	POWER GND	Ground.	GND
<b>Connector Information</b>		Bushings with M4 Screw	<div style="display: flex; justify-content: space-around;"> <div style="text-align: center;"> <p>HV</p>  </div> <div style="text-align: center;"> <p>POWER GND</p>  </div> </div>
<b>Mating Connector Details</b>		N/A	
<b>Mating Connector Included</b>		N/A	

Sold & Serviced By:



Canadian and International Sales

**ELECTROMATE**

877-737-8698

[sales@electromate.com](mailto:sales@electromate.com)

[www.electromate.com](http://www.electromate.com)

U.S. Sales

**SERVO2GO.com**

877-378-0240

[sales@servo2go.com](mailto:sales@servo2go.com)

[www.servo2go.com](http://www.servo2go.com)

**BOARD CONFIGURATION**

**Status LED Functions**

LED	Description
STAT	Indicates drive power bridge status. GREEN when DC bus power is applied and the drive is enabled. RED when the drive is in a fault state.
LOGIC PWR	Indicates that +5V logic power is available to the drive. GREEN when +5V logic power is available.
EMA	Indicates whether the Emulated Encoder Output functionality is active. GREEN for Emulated Encoder Output active. OFF for Step & Direction Input or PWM & Direction Input.

**Input/Output LED Functions**

LED	Description
DI1 – DI4	Indicates digital input status. GREEN when the corresponding digital input is active.
DO1 – DO3	Indicates digital output status. BLUE when the corresponding digital output is active

**Communication Status LED Functions (on RJ-45 Communication Connectors)**

LED	Description
LINK	Green – On Valid Link - No Activity
	Green – Flickering Valid Link - Network Activity
	Off Invalid Link
ETHERCAT STATUS	Green – On The device is in the state OPERATIONAL
	Green – Blinking (2.5Hz – 200ms on and 200ms off) The device is in the state PRE-OPERATIONAL
	Green – Single Flash (200ms flash followed by 1000ms off) The device is in state SAFE-OPERATIONAL
	Green – Flickering (10Hz – 50ms on and 50ms off) The device is booting and has not yet entered the INIT state or The device is in state BOOTSTRAP or Firmware download operation in progress
	Off The device is in state INIT
ERROR	Red – On A PDI Watchdog timeout has occurred. Example: Application controller is not responding anymore. General Configuration Error.
	Red – Blinking (2.5Hz – 200ms on and 200ms off) Example: State change commanded by master is impossible due to register or object settings.
	Red – Flickering (10Hz – 50ms on and 50ms off) Bootling Error was detected. INIT state reached, but parameter "Change" in the AL status register is set to 0x01:change/error Example: Checksum Error in Flash Memory.
	Red – Single Flash (200ms flash followed by 1000ms off) The slave device application has changed the EtherCAT state autonomously: Parameter "Change" in the AL status register is set to 0x01:change/error. Example: Synchronization error; device enters SAFE-OPERATIONAL automatically
	Red – Double Flash (Two 200ms flashes separated by 200ms off, followed by 1000ms off) An application Watchdog timeout has occurred. Example: Sync Manager Watchdog timeout.

**Address Selector Switches**

Switch Diagram	Description																								
	<p>Hexadecimal switch settings correspond to the drive Station Alias (EtherCAT). Note that drives on an EtherCAT network will be given an address automatically based on proximity to the host. Setting the switches manually is optional, and only necessary if a fixed address is required.</p> <table border="1"> <thead> <tr> <th>SW3</th> <th>SW4</th> <th>Node ID</th> </tr> </thead> <tbody> <tr> <td>0</td> <td>0</td> <td>000</td> </tr> <tr> <td>0</td> <td>1</td> <td>001</td> </tr> <tr> <td>0</td> <td>2</td> <td>002</td> </tr> <tr> <td>...</td> <td>...</td> <td>...</td> </tr> <tr> <td>F</td> <td>D</td> <td>253</td> </tr> <tr> <td>F</td> <td>E</td> <td>254</td> </tr> <tr> <td>F</td> <td>F</td> <td>255</td> </tr> </tbody> </table>	SW3	SW4	Node ID	0	0	000	0	1	001	0	2	002	...	...	...	F	D	253	F	E	254	F	F	255
SW3	SW4	Node ID																							
0	0	000																							
0	1	001																							
0	2	002																							
...	...	...																							
F	D	253																							
F	E	254																							
F	F	255																							



**DIP Switches**

Switch	Description	ON	OFF
SW6	Motor Thermistor Selection. Note that both switches on SW6 must be set to the same position for proper operation.	Uses the motor thermistor reading from P9 – Feedback 2 Connector	Uses the motor thermistor reading from P10 – Feedback 1 Connector

**Safe Torque Off (STO) Inputs**

The Safe Torque Off (STO) inputs are dedicated +5VDC sinking single-ended inputs. For applications not using STO functionality, disabling of the STO feature is required for proper drive operation. STO may be disabled by installing the included mating connector for the STO connector and following the STO Disable wiring instructions as given in the hardware installation manual. Consult the hardware installation manual for more information. Alternatively, a dedicated STO Disable Key connector is available for purchase for applications where STO is not in use. Contact the factory for ordering information.

Sold & Serviced By:



*Canadian and International Sales*

**ELECTROMATE**

877-737-8698

[sales@electromate.com](mailto:sales@electromate.com)

[www.electromate.com](http://www.electromate.com)

*U.S. Sales*



877-378-0240

[sales@servo2go.com](mailto:sales@servo2go.com)

[www.servo2go.com](http://www.servo2go.com)

**MOUNTING DIMENSIONS**

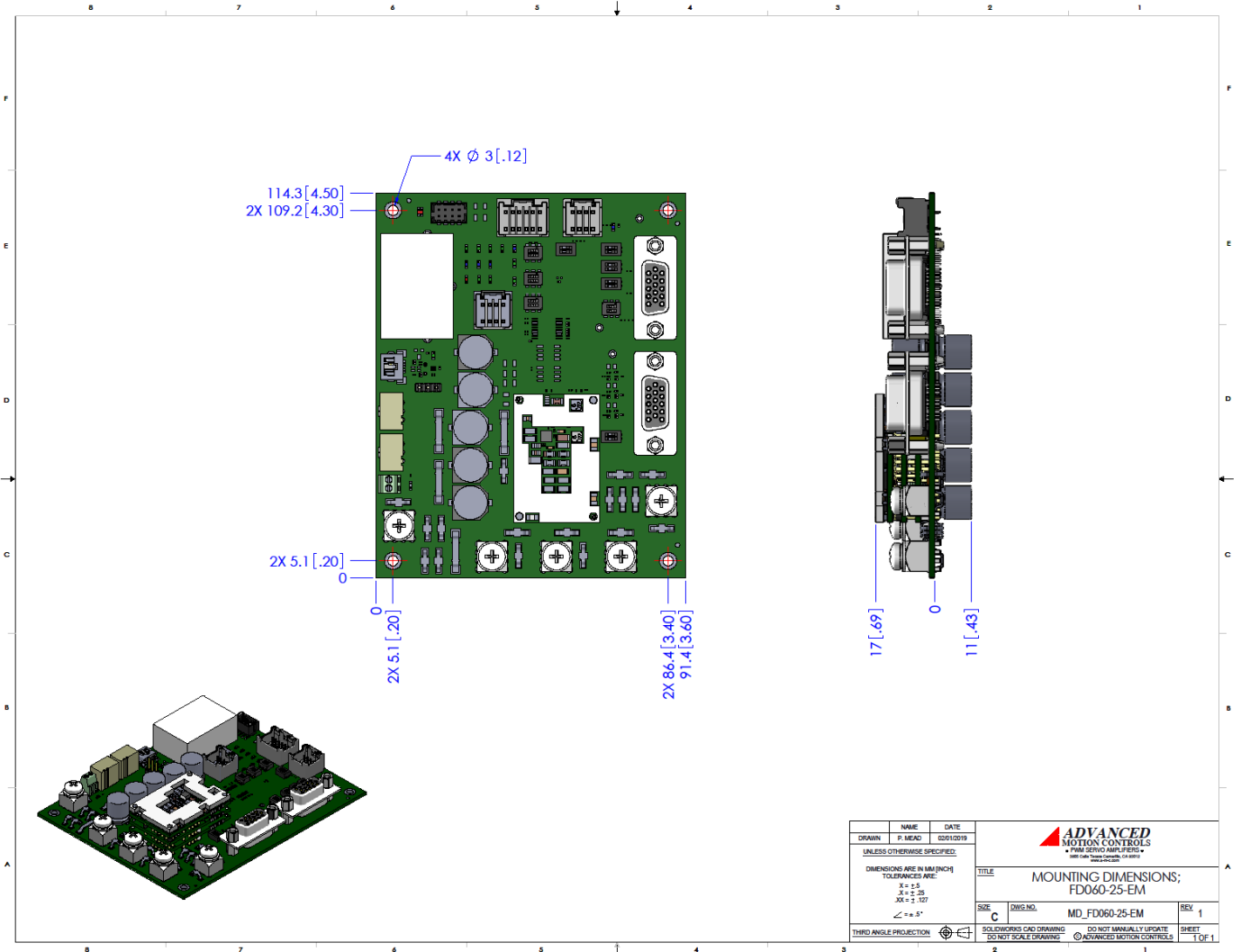

Sold & Serviced By:



Canadian and International Sales

**ELECTROMATE**

877-737-8698

sales@electromate.com

www.electromate.com

U.S. Sales



877-378-0240

sales@servo2go.com

www.servo2go.com

**PART NUMBERING AND CUSTOMIZATION INFORMATION**

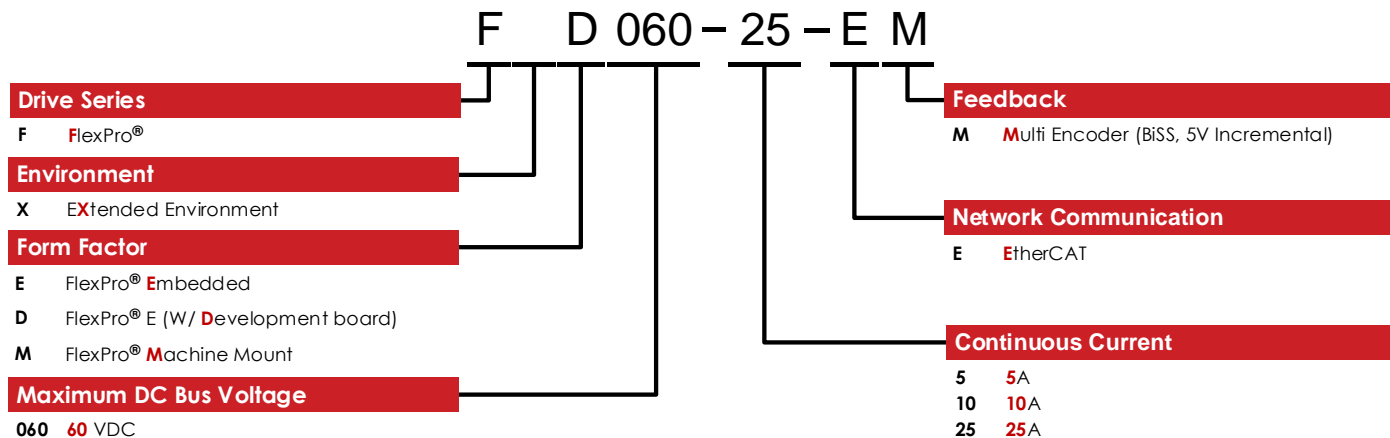

ADVANCED Motion Controls also has the capability to promptly develop and deliver specified products for OEMs with volume requests. Our Applications and Engineering Departments will work closely with your design team through all stages of development in order to provide the best servo drive solution for your system. Equipped with on-site manufacturing for quick-turn customs capabilities, ADVANCED Motion Controls utilizes our years of engineering and manufacturing expertise to decrease your costs and time-to-market while increasing system quality and reliability.

**Examples of Customized Products**

- |  |  |
|--|--|
| <ul style="list-style-type: none"> <li>▲ Optimized Footprint</li> <li>▲ Private Label Software</li> <li>▲ OEM Specified Connectors</li> <li>▲ No Outer Case</li> <li>▲ Increased Current Resolution</li> <li>▲ Increased Temperature Range</li> <li>▲ Custom Control Interface</li> <li>▲ Integrated System I/O</li> </ul> | <ul style="list-style-type: none"> <li>▲ Tailored Project File</li> <li>▲ Silkscreen Branding</li> <li>▲ Optimized Base Plate</li> <li>▲ Increased Current Limits</li> <li>▲ Increased Voltage Range</li> <li>▲ Conformal Coating</li> <li>▲ Multi-Axis Configurations</li> <li>▲ Reduced Profile Size and Weight</li> </ul> |
|--|--|

Feel free to contact us for further information and details!

**Available Accessories**

ADVANCED Motion Controls offers a variety of accessories designed to facilitate drive integration into a servo system. Visit [www.a-m-c.com](http://www.a-m-c.com) to see which accessories will assist with your application design and implementation.

## Sold & Serviced By:

Canadian and International Sales

ELECTROMATE

877-737-8698

sales@electromate.com

www.electromate.com

U.S. Sales

SERVO2GO.com

877-378-0240

sales@servo2go.com

www.servo2go.com

All specifications in this document are subject to change without written notice. Actual product may differ from pictures provided in this document.