

TKS & TKB ACTUATORS

SCREW DRIVE & BELT DRIVE

ENDURANCE TECHNOLOGY™

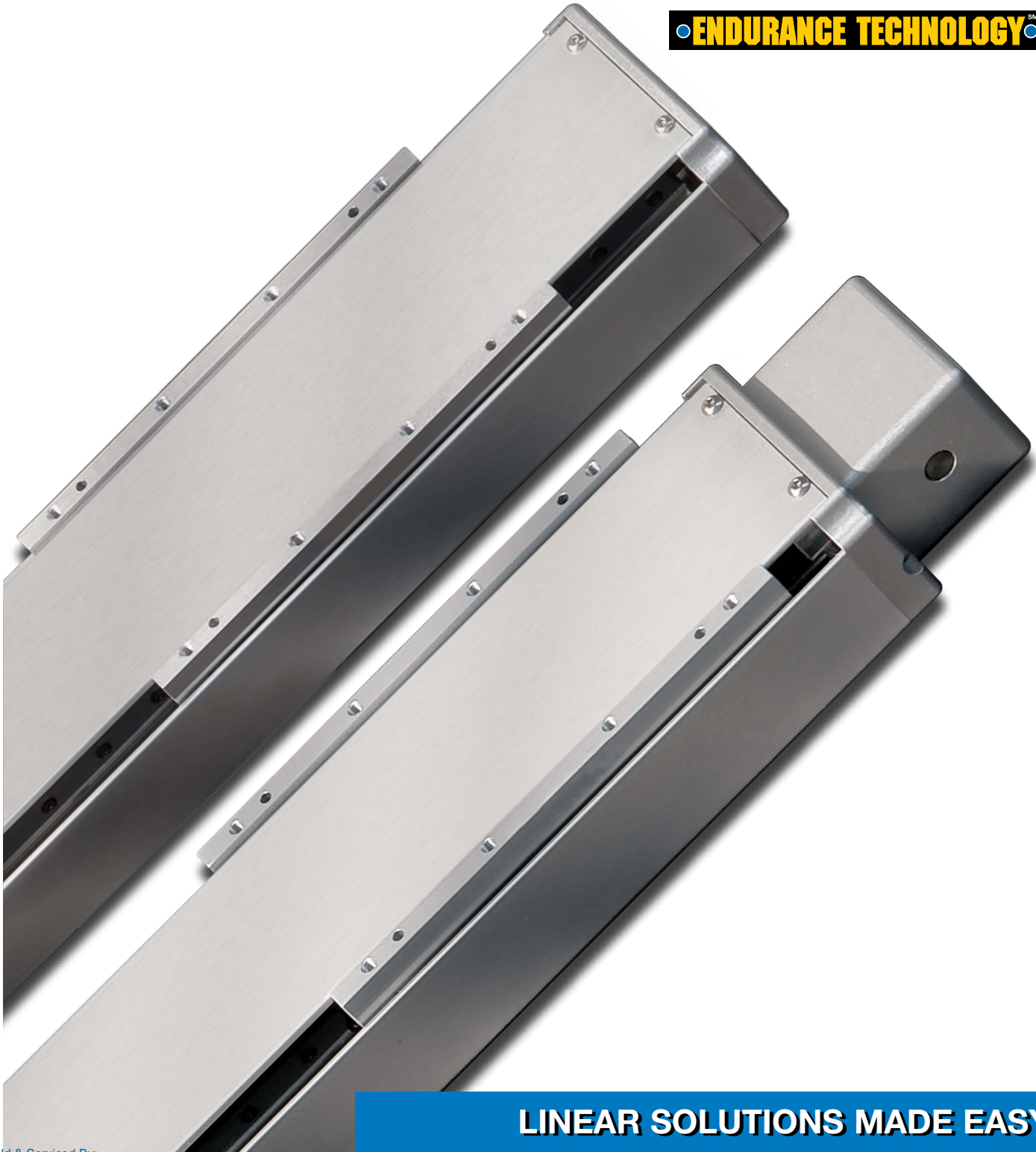

LINEAR SOLUTIONS MADE EASY

Sold & Serviced By:

 **ELECTROMATE**

Toll Free Phone (877) SERV098

Toll Free Fax (877) SERV099

www.electromate.com

sales@electromate.com





Tolomatic TKS & TKB Electric Rodless Actuators



High Precision Rodless Actuators

The TKS and TKB linear table style actuators are designed for applications carrying moderate load and requiring high precision in parameters such as flatness, straightness and accuracy. Both the TKS and TKB actuators utilize two parallel profiled rails with four recirculating ball linear guides to provide consistent and precise performance. Built-to-order in stroke lengths up to 96 inches.





A Comparison of Screw Drive Actuators

	TKS	B3S	MXE-S	MXE-P
				
Features:	Superior rigidity, high moment load capacities	High load and bending moment capacities	Basic guidance and support	High load and bending moment capacities
Load up to: (with options)	1,500 lbf [6,672 N]	8,000 lbf [35,586 N]	1,040 lbf [4,626 N]	2,584 lbf [11,494 N]
Thrust up to:	3,260 lbf [14,501 N]	2,700 lbf [12,010 N]	4,300 lbf [19,127 N]	4,300 lbf [19,127 N]
Speed up to:	60 in/sec [1,524 mm/sec]	60 in/sec [1,524 mm/sec]	60 in/sec [1,524 mm/sec]	60 in/sec [1,524 mm/sec]
Stroke Length up to:	96 in [2,438 mm]	179 in [4,547 mm]	178 in [4,521 mm]	178 in [4,521 mm]
Screw/Nut Type	Solid & Ball	Solid & Ball	Solid & Ball	Solid & Ball
<i>www.tolomatic.com for complete information, search by literature number:</i>				
Literature Number:	3600-4609	3600-4176	8300-4000	8300-4000

(Not all models deliver ALL maximum values listed, i.e.: Maximum thrust may not be available with maximum speed)

TKS

A Comparison of Belt Drive Actuators

	TKB	B3W	MXB-U	MXB-P
				
Features:	Superior rigidity, high moment load capacities	High load and bending moment capacities	Basic thrust, requires external guidance and support	High load and bending moment capacities
Load up to: (with options)	1,500 lbf [6,672 N]	8,000 lbf [35,586 N]	NA	2,584 lbf [11,494 N]
Thrust up to:	245 lbf [1,090 N]	325 lbf [1,446 N]	418 lbf [1,859 N]	418 lbf [1,859 N]
Speed up to:	100 in/sec [2,540 mm/sec]	200 in/sec [5,080 mm/sec]	200 in/sec [5,080 mm/sec]	150 in/sec [3,810 mm/sec]
Stroke Length up to:	96 in [2,438 mm]	207 in [5,258 mm]	230 in [5,842 mm]	230 in [5,842 mm]
<i>www.tolomatic.com for complete information, search by literature number:</i>				
Literature Number:	3600-4609	3600-4176	8500-4000	8500-4000

(Not all models deliver ALL maximum values listed, i.e.: Maximum thrust may not be available with maximum speed)

TKB

Sold & Serviced By:

 **ELECTROMATE**

Toll Free Phone (877) SERV098

Toll Free Fax (877) SERV099

www.electromate.com

sales@electromate.com

TKS & TKB Applications

Storage & Retrieval

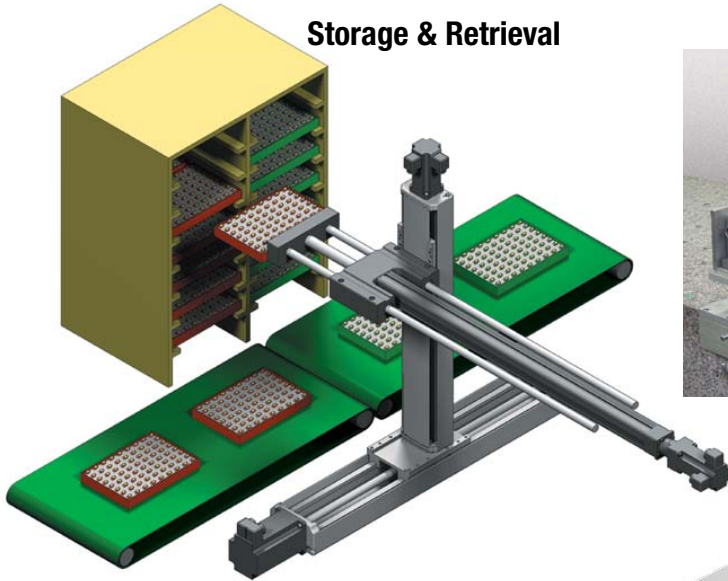

Inspection & Measurement

Custom Two Direction TKS



- Animation
- Assembly machinery
- Automotive
- Cosmetics
- Cycle testing
- Inspection & measurement
- Laser positioning
- Machine tools
- Material handling
- Medical equipment
- Packaging equipment
- Pick & place
- Precision grinders
- Product test simulations
- Semiconductor
- Stage motion control
- Table positioning
- Tension control
- Test stands
- Water jet control
- Wave generation
- and many more

Semiconductor Inspection



CONTENTS

Rodless Comparison TK_2

Applications..... TK_3

TKS Features..... TK_4

TKB Features TK_6

TKS & TKB Specs..... TK_8

TKS Specifications TK_15

TKB Performance..... TK_21

TKB Specifications TK_22

Switches TK_26

Application Data
Worksheet..... TK_28

Selection Guidelines TK_29

TKS Ordering TK_30

TKB Ordering TK_31

Other Tolomatic
Products..... TK_32

TKS

TKB

Sold & Serviced By:



Toll Free Phone (877) SERV098
 Toll Free Fax (877) SERV099
www.electromate.com
sales@electromate.com

TKS PRECISION SCREW DRIVE ACTUATOR

ENDURANCE TECHNOLOGYSM

Endurance Technology features are designed for maximum durability to provide extended service life.

The TKS linear table style actuator is designed for applications carrying moderate load and requiring high precision in parameters such as flatness, straightness and accuracy. The TKS actuator utilizes two parallel profiled rails with four recirculating ball linear guides to provide consistent and precise performance. Built-to-order in stroke lengths up to 96 inches with your choice of screw technology.

PRECISION MACHINED TABLE DESIGN

- A low profile design accommodates multiple mounting designs and assures a rigid and secure load



SCREW SUPPORT BEARINGS

- Unique high thrust bearing assembly design eliminates runout and isolates the motor from axial forces

MULTIPLE SCREW TECHNOLOGIES YOU CAN CHOOSE:

- Solid nuts of engineered resins offer quiet performance at the lowest cost; anti-backlash available
- Ball nuts offer positioning accuracy and repeatability with longer life; low-backlash available



TWIN LINEAR RAILS AND BEARINGS

- Industry leading bearing system for consistent tracking, low friction and extended performance
- Superior straightness and flatness is verified at the factory below 0.0002 inches per inch
- Four bearing blocks provide rigid support of the carrier with the lowest possible deflection

INTERNAL SWITCHES

- End of travel and home positioning sensors are integral into the body of the actuator for clean and easy management



TKS

TKB

Sold & Serviced By:

 **ELECTROMATE**

Toll Free Phone (877) SERV098

Toll Free Fax (877) SERV099

www.electromate.com

sales@electromate.com

INTERNAL BUMPERS

- Bumpers protect the screw and nut assembly from damage at end of stroke

INTERNAL COUPLER

- Integral motor coupling for inline mounts provides a more compact package size

MOTOR ORIENTATION YOU CAN CHOOSE:

- Inline option directly couples the driving shafts and is a one-piece housing construction for optimum alignment and support of the motor
- Reverse-parallel option minimizes the overall length and offers a 1:1 or 2:1 belt ratio

LIGHTWEIGHT ALUMINUM DESIGN

- Clear anodized extrusion design is optimized for rigidity and strength
- Mounting holes placed evenly throughout the stroke maintain rigidity



REMOVABLE COVER

- Provides rapid access to internal components and protects mechanisms from incidental damage



OPTIONS



CARRIER OPTIONS

- **AUXILIARY CARRIER** Doubles the load capacity and increases pitch and yaw bending moment capacities

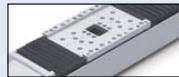

SEALING OPTIONS

- **BELLOWS** provides additional protection of mechanical components in dirty environments



SWITCHES

- Styles include: reed or hall-effect. 15ft potted cable with flying leads

TKS

TKB

Sold & Serviced By:

ELECTROMATE

Toll Free Phone (877) SERV098

Toll Free Fax (877) SERV099

www.electromate.com

sales@electromate.com

TKB PRECISION BELT DRIVE ACTUATOR

ENDURANCE TECHNOLOGYSM

Endurance Technology features are designed for maximum durability to provide extended service life.

The TKB linear table style actuator is designed for high speed applications requiring high precision in parameters such as flatness and straightness. This unique actuator utilizes two parallel profiled rails with four recirculating ball linear guides to provide wide and stable mounting surface with consistent and precise performance. The TKB belt-driven actuator features speeds up to 100 in/sec. and thrusts up to 245 lbf. Built-to-order in stroke lengths up to 96 inches.



MULTIPLE BELT TECHNOLOGIES YOU CAN CHOOSE:

- Polyurethane steel-cord reinforced HTD style belt (standard)
- Polyurethane Kevlar reinforced HTD style belt (Contact Tolomatic)

REMOVABLE COVER

- Provides rapid access to internal components and protects mechanisms from incidental damage



INTERNAL SWITCHES

- End of travel and home positioning sensors are integral into the body of the actuator for clean and easy management



PRECISION MACHINED TABLE DESIGN

- A wide and low profile design accommodates multiple mounting designs and assures a rigid and secure load



TKS

TKB

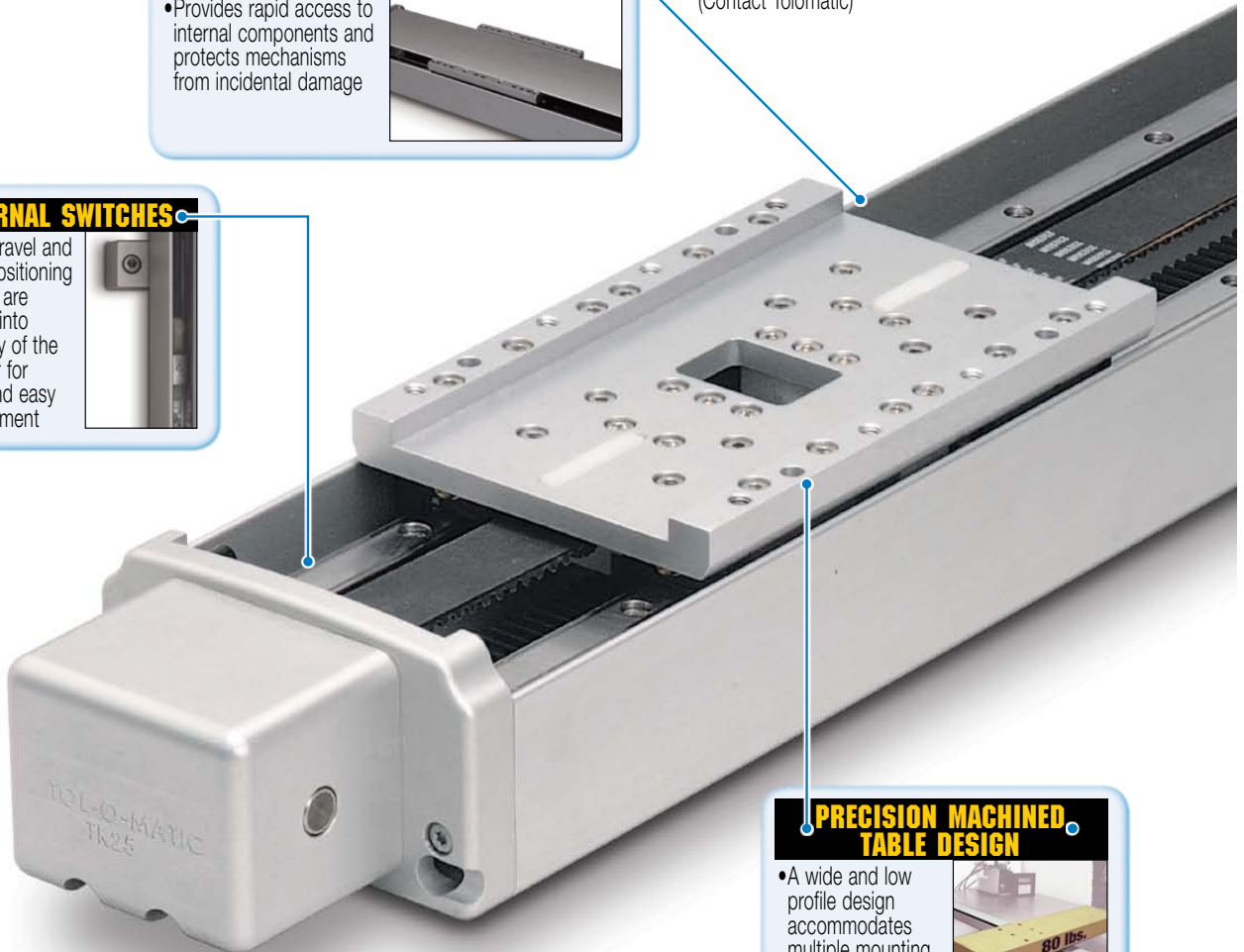

Sold & Serviced By:

 **ELECTROMATE**

Toll Free Phone (877) SERV098

Toll Free Fax (877) SERV099

www.electromate.com

sales@electromate.com

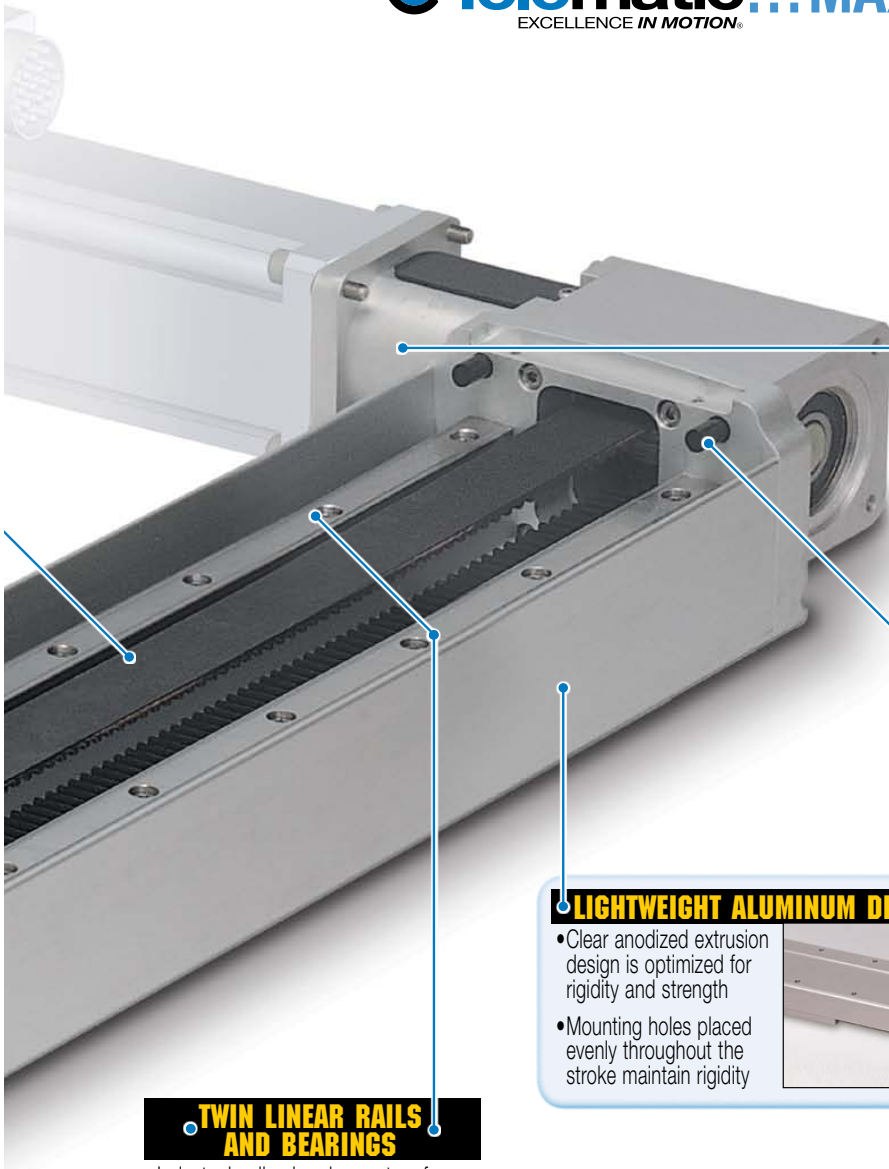

MOTOR ORIENTATION YOU CAN CHOOSE:

- Direct drive option directly couples the driving shafts and is a one-piece housing construction for optimum alignment and support of the motor
- Reduction drive option offers the ability to reduce the reflected inertia and lower the motor torque requirements

EXTERNAL BUMPERS

- External bumpers, both ends, are standard
- Protect actuator and load from damage

LIGHTWEIGHT ALUMINUM DESIGN

- Clear anodized extrusion design is optimized for rigidity and strength
- Mounting holes placed evenly throughout the stroke maintain rigidity



TWIN LINEAR RAILS AND BEARINGS

- Industry leading bearing system for consistent tracking, low friction and extended performance
- Superior straightness and flatness is verified at the factory below 0.0002 inches per inch
- Four bearing blocks provide rigid support of the carrier with the lowest possible deflection

OPTIONS



CARRIER OPTIONS

- **AUXILIARY CARRIER** Doubles the load capacity and increases pitch and yaw bending moment capacities

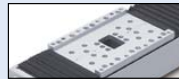

SEALING OPTIONS

- **BELLOWS** provides additional protection of mechanical components in dirty environments



SWITCHES

Styles include: reed or hall-effect. 15ft potted cable with flying leads

TKS

TKB

Sold & Serviced By:



Toll Free Phone (877) SERV098
Toll Free Fax (877) SERV099
www.electromate.com
sales@electromate.com

TKS & TKB Rodless Actuators

TKS & TKB SPECIFICATIONS

BENDING MOMENTS AND LOADS

STANDARD CARRIER		MAX. BENDING MOMENTS AND LOADS*								
		U.S. Conventional				Metric				
		10	25	50	75	10	25	50	75	
Max. Dynamic Bending Moments										
Mx (Roll)	lb-in	85	721	971	1,151	<i>N-m</i>	9.6	81.5	109.7	130.0
My (Pitch)	lb-in	234	1,014	1,442	1,477	<i>N-m</i>	26.4	114.6	162.9	166.9
Mz (Yaw)	lb-in	234	915	1,301	1,332	<i>N-m</i>	26.4	103.4	147.0	150.5
Max. Dynamic Loads										
Fy (Radial Load)	lb	100	250	500	750	<i>N</i>	445	1,113	2,225	3,338
Fz (Lateral Load)	lb	100	250	500	750	<i>N</i>	445	1,113	2,225	2,225
Fzr (Reverse Lateral Load)	lb	100	250	500	750	<i>N</i>	445	1,113	2,225	2,225
Max. Static Bending Moments										
Mx (Roll)	lb-in	170	1,251	1,685	1,997	<i>N-m</i>	19.2	141.3	190.3	225.6
My (Pitch)	lb-in	468	1,759	2,502	2,563	<i>N-m</i>	52.9	198.8	282.7	289.5
Mz (Yaw)	lb-in	468	1,588	2,257	2,311	<i>N-m</i>	52.9	179.4	255.0	261.1
Max. Static Loads										
Fy (Radial Load)	lb	200	434	868	1,301	<i>N</i>	890	1,931	3,863	5,789
Fz (Lateral Load)	lb	200	434	868	868	<i>N</i>	890	1,931	3,863	3,863
Fzr (Reverse Lateral Load)	lb	200	434	868	868	<i>N</i>	890	1,931	3,863	3,863
AUXILIARY CARRIER: Increases rigidity, load-carrying capacity and moments		U.S. Conventional				Metric				
		10DC	25DC	50DC	75DC		10DC	25DC	50DC	75DC
Max. Dynamic Bending Moments**										
Mx (Roll)	lb-in	170	1,442	1,942	2,302	<i>N-m</i>	19.2	162.9	219.4	260.1
My (Pitch)	lb-in	563	1,733	3,810	3,875	<i>N-m</i>	63.6	195.7	430.5	437.8
Mz (Yaw)	lb-in	563	1,733	3,810	3,875	<i>N-m</i>	63.6	195.7	430.5	437.8
Max. Dynamic Loads										
Fy (Radial Load)	lb	200	500	1,000	1,500	<i>N</i>	890	2,225	4,450	6,672
Fz (Lateral Load)	lb	200	500	1,000	1,500	<i>N</i>	890	2,225	4,450	6,672
Fzr (Reverse Lateral Load)	lb	200	500	1,000	1,500	<i>N</i>	890	2,225	4,450	6,672
Max. Static Bending Moments**										
Mx (Roll)	lb-in	340	2,502	3,369	3,994	<i>N-m</i>	38	283	381	451
My (Pitch)	lb-in	1,126	3,006	6,610	6,723	<i>N-m</i>	127	340	747	760
Mz (Yaw)	lb-in	1,126	3,006	6,610	6,723	<i>N-m</i>	127	340	747	760
Max. Static Loads										
Fy (Radial Load)	lb	400	868	1,735	2,603	<i>N</i>	1,780	3,863	7,721	11,583
Fz (Lateral Load)	lb	400	868	1,735	1,735	<i>N</i>	1,780	3,863	7,721	7,721
Fzr (Reverse Lateral Load)	lb	400	868	1,735	1,735	<i>N</i>	1,780	3,863	7,721	7,721
Min. Dimension 'D'	in	5.63	6.93	7.63	7.75	<i>mm</i>	142.9	176	193.8	196.9



* Bending moments & load specifications are based on 200,000,000 (5,000 KM) linear inches of carrier travel.

Breakaway torque will increase when using the Auxiliary carrier option. When ordering, determine your working stroke and enter this value into the configuration string. Overall actuator length will automatically be calculated.

Deflection Considerations: In applications where substantial Mx or My moments come into play, deflection of the cylinder tube, carrier and supports must be considered. The deflection factors shown in the Load Deflection charts, are based on cylinder mounted with tube supports at minimum recommended spacing. If more rigidity is desired, refer to the Auxiliary or Dual Carrier options.

** Loads shown in table are at minimum "D" dimension, for ratings with longer "D" dimension see graph on page TK_9.

Sold & Serviced By:

ELECTROMATE

Toll Free Phone (877) SERV098

Toll Free Fax (877) SERV099

www.electromate.com

sales@electromate.com

TKS & TKB Rodless Actuators

TKS & TKB SPECIFICATIONS

LOAD DEFLECTION

X-AXIS DEFLECTION

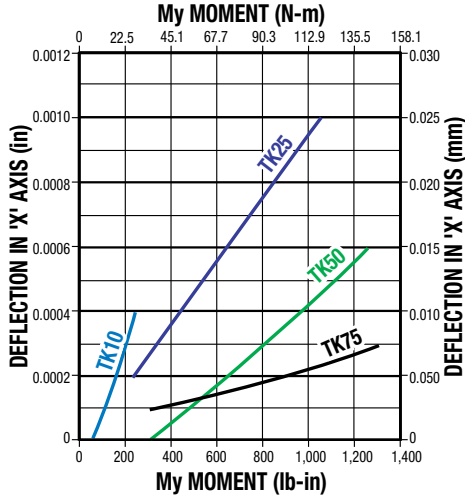
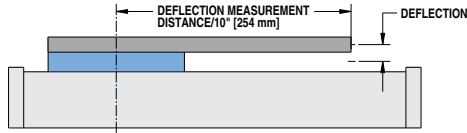

Y-AXIS DEFLECTION

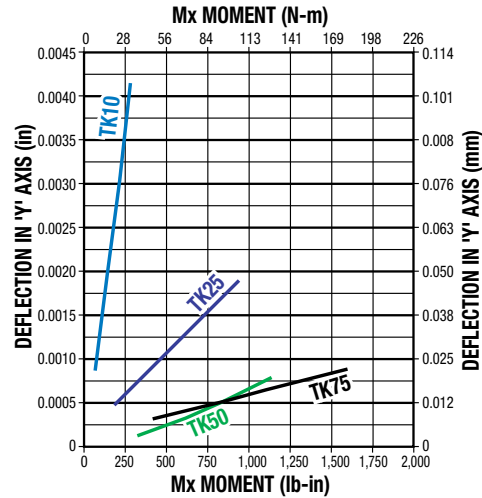
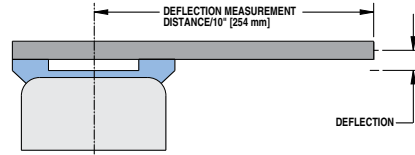

AUXILIARY CARRIER: BENDING MOMENT AT 'D' DISTANCE

DYNAMIC BENDING MOMENT

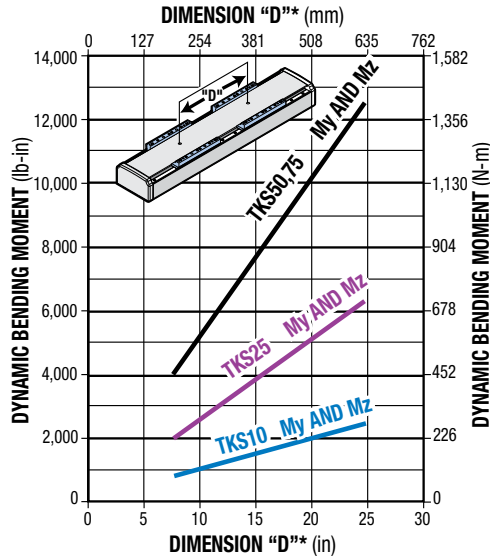

STATIC BENDING MOMENT

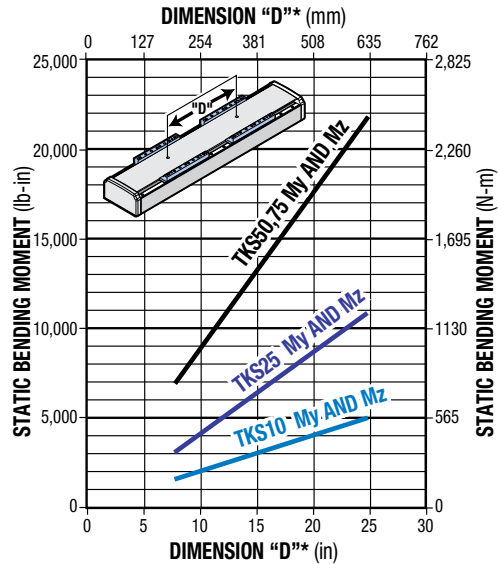

Rates shown on charts were calculated with these assumptions:

- 1.) Coupling between carriers is rigid.
- 2.) Load is equally distributed between carriers.
- 3.) Coupling device applies no misalignment loads to carriers.

* Customer must specify Dimension "D" (Distance between carrier center lines) in configuration string.

 See page TK_8 for minimum "D" dimension.

TKS

TKB

Sold & Serviced By:

 **ELECTROMATE**

Toll Free Phone (877) SERV098

Toll Free Fax (877) SERV099

www.electromate.com

sales@electromate.com

TKS & TKB Rodless Actuators

TKS & TKB SPECIFICATIONS

BELLOWS STROKE REQUIREMENTS

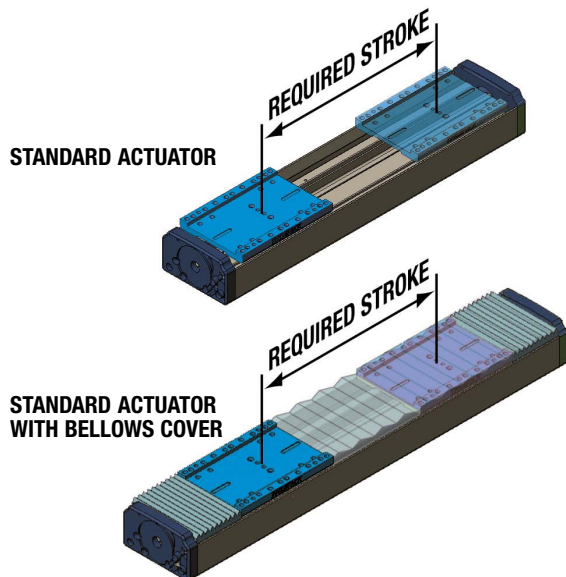

MAXIMUM AVAILABLE STROKE FOR BELLOWS OPTION

	TKS		TKB
	Ball Nut	Solid Nut	
10	24	64	64
mm	610	1626	1626
25	44	64	64
mm	1118	1626	1626
50	56	64	64
mm	1422	1626	1626
75	64	64	64
mm	1626	1626	1626

! BELLOWS COVER OPTION INCREASES OVERALL ACTUATOR LENGTH BY 0.508 x STROKE

MOUNTING PLATE RECOMMENDATIONS

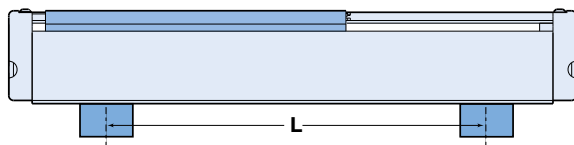
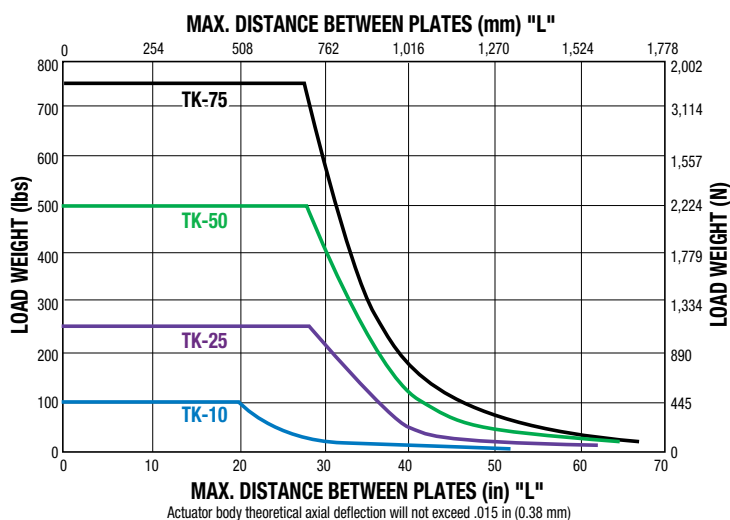

FRICITION FORCE

$$lbf = 0.0003 \times \text{LOAD (lb)} + 3.96$$

$$N = 0.003 \times \text{LOAD (kg)} + 17.6$$

LUBRICATION

Proper and adequate lubrication is essential for normal operation of TruTrack actuators. Poor lubrication will cause quicker wear and decrease service life of the actuator. For general use, lubrication should be performed at intervals of 4,000,000 linear inches of travel (100 km) or once every year, whichever occurs first. However, the operating conditions of certain applications may require more frequent lubrication. Please consult Tolomatic for recommendations.

Recommended greases:

- Multi-purpose grease based on refined mineral oil containing lithium thickening agent (excellent at high pressures, excellent viscosity stability).
- Grease based on a high-grade synthetic oil containing a urea thickening agent (long life, wide temperature range).

Sold & Serviced By:

ELECTROMATE

Toll Free Phone (877) SERV098

Toll Free Fax (877) SERV099

www.electromate.com

sales@electromate.com

TKS Rodless Screw Drive Actuator

ACME SCREW/NUT COMBINATIONS

TKS ACME SCREW CRITICAL SPEED CAPACITIES

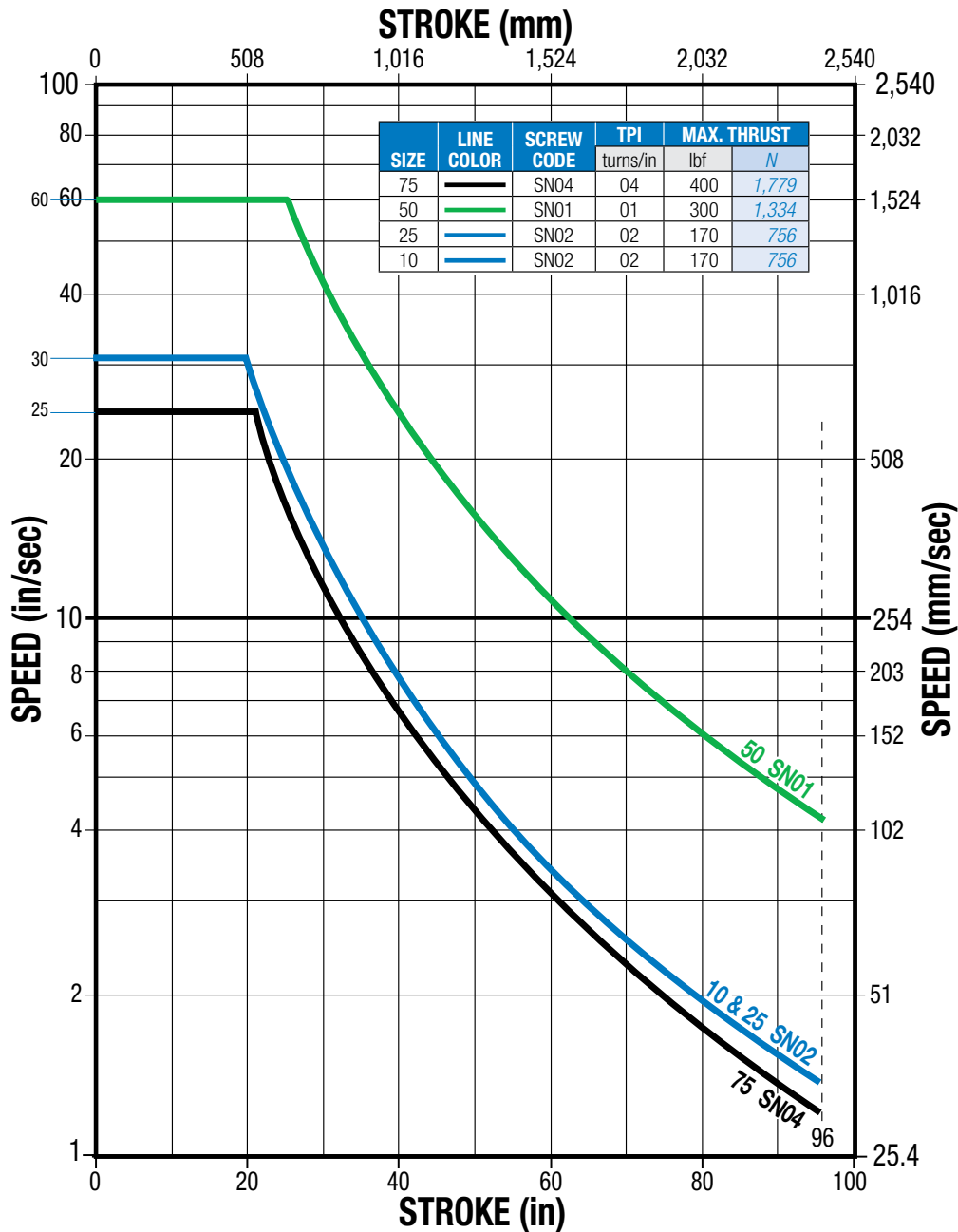

* For Acme screws, maximum thrust is the maximum continuous dynamic thrust subject to Thrust x Velocity limitation.

Dashed line represents maximum stroke for screw selections.

SCREW TYPE
DESCRIPTION

SN Solid Nut
BN Ball Nut

TKS

TKB

Sold & Serviced By:

ELECTROMATE

Toll Free Phone (877) SERV098

Toll Free Fax (877) SERV099

www.electromate.com

sales@electromate.com

TKS Rodless Screw Drive Actuator

ACME SCREW/NUT COMBINATIONS

TKS ACME SCREW PV LIMITS

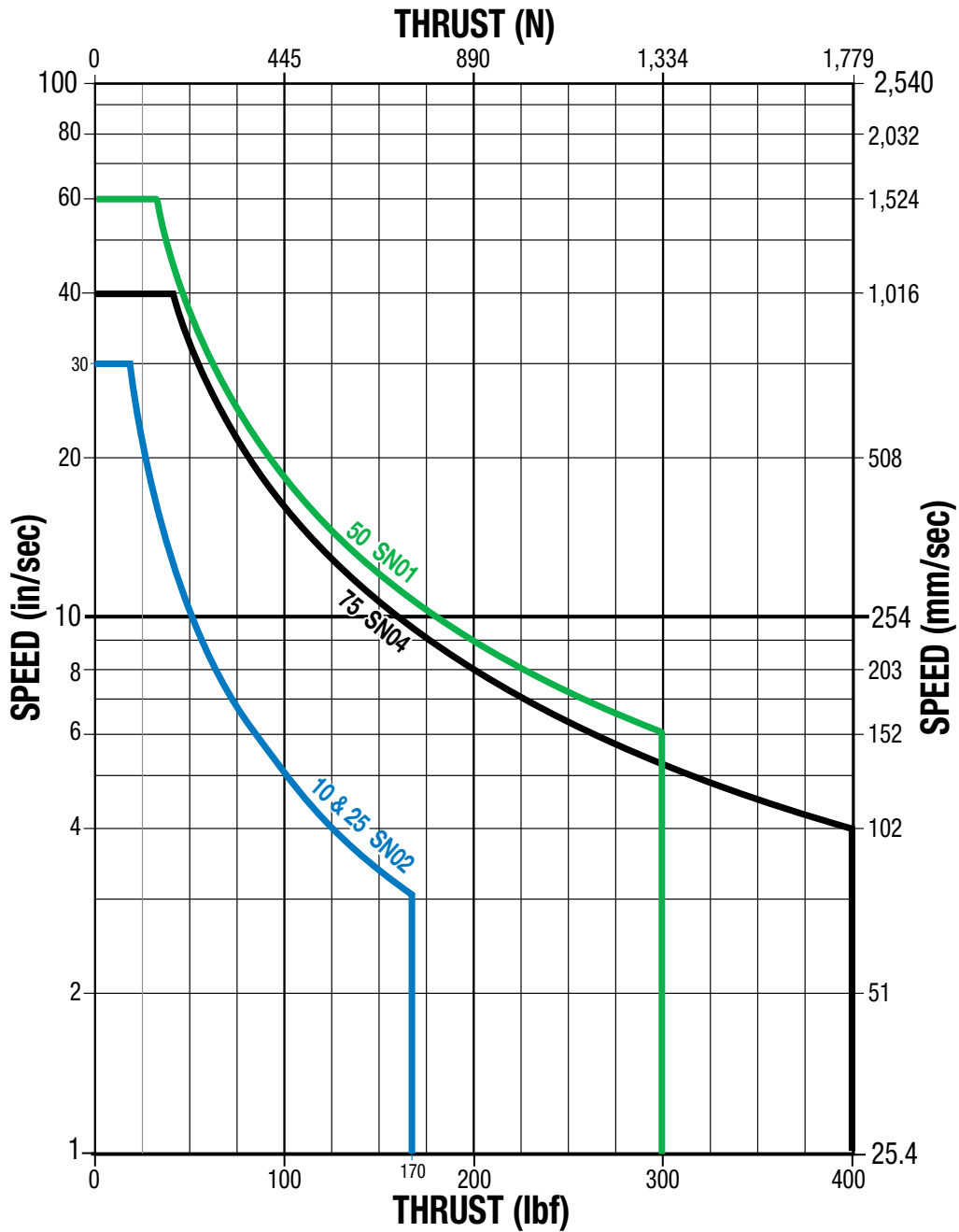

▲ * Maximum thrust is the maximum continuous dynamic thrust subject to Thrust x Velocity Limitation.

PV LIMITS: Any material which carries a sliding load is limited by heat buildup. The factors that affect heat generation rate in an application are the pressure on the nut in pounds per square inch and the surface velocity in feet per minute. The product of these factors provides a measure of the severity of an application.

$$\frac{P}{(\text{Max. Thrust Rating})} \times \frac{V}{(\text{Max. Speed Rating})} \leq 0.1$$

Sold & Serviced By:

ELECTROMATE

Toll Free Phone (877) SERV098

Toll Free Fax (877) SERV099

www.electromate.com

sales@electromate.com

TKS Rodless Screw Drive Actuator

BALL SCREW/NUT COMBINATIONS

BALL SCREW CRITICAL SPEED CAPACITIES

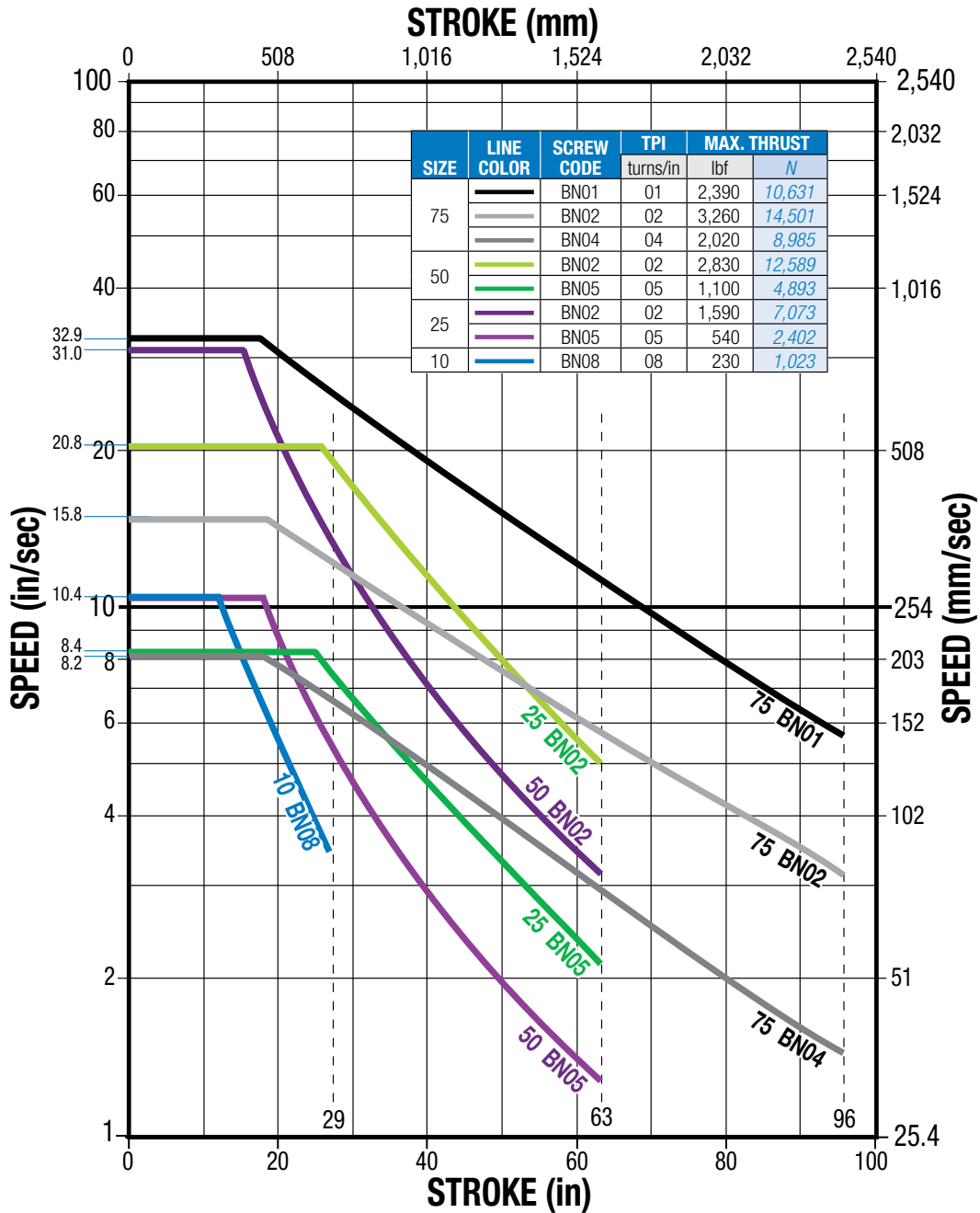

* For ball screws, maximum thrust reflects 90% reliability for 1 million linear inches of travel.

Dashed lines represent maximum stroke for screw selections.

SCREW TYPE DESCRIPTION
BN Ball Nut

TKS

TKB

Sold & Serviced By:



Toll Free Phone (877) SERV098

Toll Free Fax (877) SERV099

www.electromate.com

sales@electromate.com

TKS Rodless Screw Drive Actuator

BALL SCREW SPECIFICATIONS

BALL SCREW LIFE CALCULATION

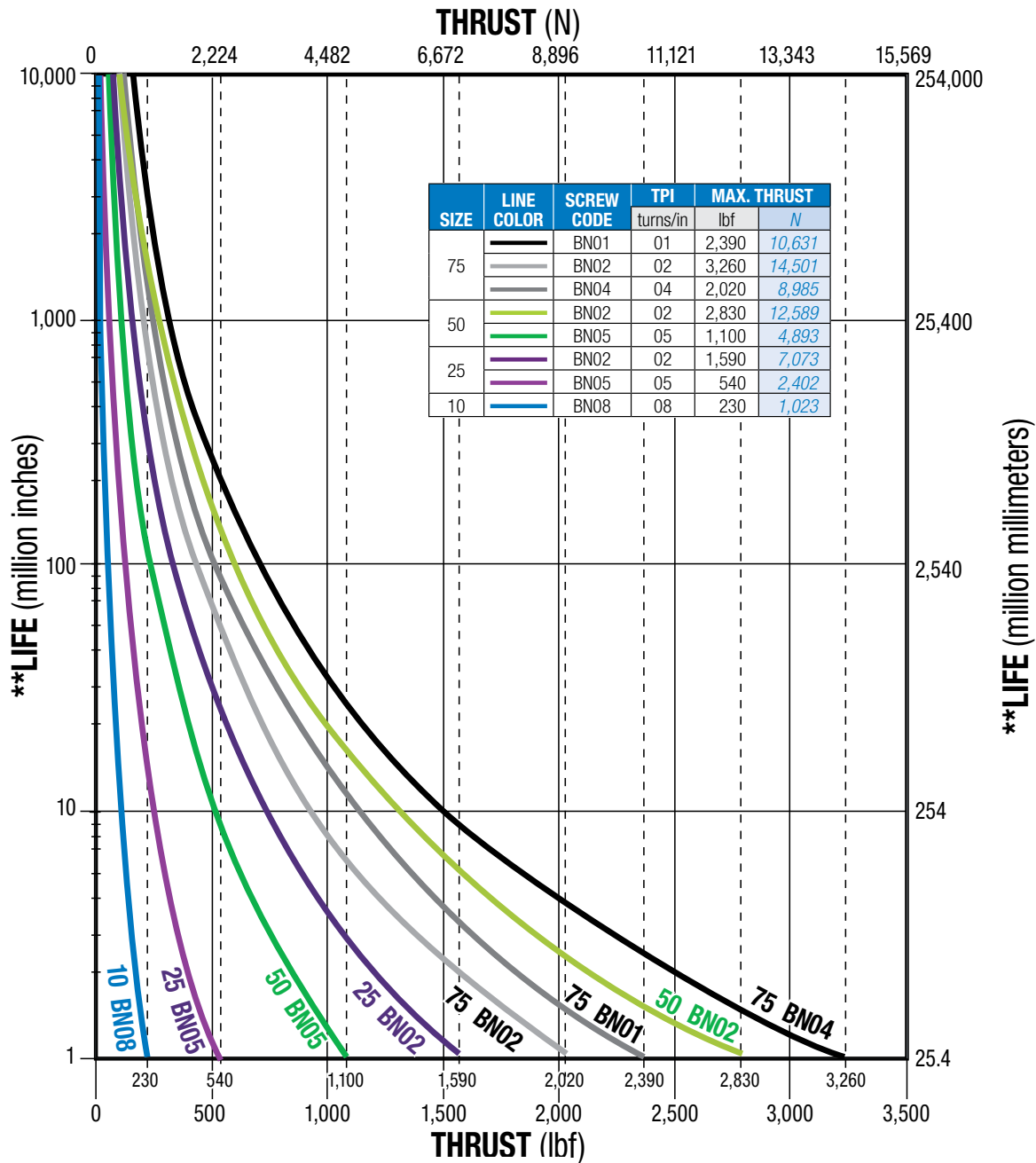

SCREW TYPE DESCRIPTION
BN Ball Nut

▲ * Maximum thrust reflects 90% reliability for 1 million linear inches of travel

**Life indicates theoretical maximum life of screw only, under ideal conditions and does not indicate expected life of actuator.

Sold & Serviced By:

ELECTROMATE

Toll Free Phone (877) SERV098

Toll Free Fax (877) SERV099

www.electromate.com

sales@electromate.com

TKS Rodless Screw Drive Actuator

TKS SPECIFICATIONS

SPECIFICATIONS RELATED TO ACTUATOR SIZE AND SCREW SELECTION

TKS LEAD SCREWS U.S. CONVENTIONAL											
ACTUATOR	SCREW DIA. (in)	SCREW CODE	TPI (turns/in)	LEAD ACCURACY (in/ft)	BACKLASH (in)	MAXIMUM THRUST* (lb)	MAXIMUM STROKE (in)	INERTIA (lb-in ²)			BREAKAWAY TORQUE (lb-in)
								BASE ACTUATOR		PER/in OF STROKE	
	In Line	Rev. Parallel									
TKS10	0.500	SN	2	0.003	0.007	170	96	0.0126	0.0159	0.0017	0.938
	0.375	BN	8	0.004	0.002	230	29	0.0029	0.0038	0.0005	0.813
TKS25	0.500	SN	2	0.003	0.007	170	96	0.0263	0.0291	0.0017	1.750
	0.500	BN	2	0.004	0.002	1,590	63	0.0263	0.0291	0.0017	1.438
	0.625	BN	5	0.004	0.002	540	63	0.0311	0.0380	0.0042	1.063
TKS50	0.750	SN	1	0.003	0.007	300	96	0.1472	0.1577	0.0087	3.750
	0.750	BN	2	0.004	0.002	2,830	63	0.0867	0.0972	0.0087	1.875
	0.750	BN	5	0.004	0.002	1,100	63	0.0698	0.0803	0.0087	1.500
TKS75	1.000	SN	4	0.003	0.007	400	96	0.2196	0.2737	0.0275	2.813
	1.000	BN	1	0.004	0.002	2,390	96	0.3037	0.3578	0.0275	3.438
	1.000	BN	2	0.004	0.002	3,260	96	0.2364	0.2905	0.0275	2.813
	1.000	BN	4	0.004	0.002	2,020	96	0.2196	0.2737	0.0275	2.500

TKS LEAD SCREWS METRIC											
ACTUATOR	SCREW DIA. (in)	SCREW CODE	TPI (turns/in)	LEAD ACCURACY (mm/300)	BACKLASH (mm)	MAXIMUM THRUST* (N)	MAXIMUM STROKE (mm)	INERTIA (kg-m ² x 10 ⁻⁶)			BREAKAWAY TORQUE (N-m)
								BASE ACTUATOR		PER/in OF STROKE	
	In Line	Rev. Parallel									
TKS10	0.500	SN	2	0.0762	0.1778	756	2,438	3.69	4.65	0.50	0.11
	0.375	BN	8	0.1016	0.0508	1,023	737	0.85	1.11	0.15	0.09
TKS25	0.500	SN	2	0.0762	0.1778	756	2,438	7.69	8.51	0.49	0.20
	0.500	BN	2	0.1016	0.0508	7,073	1,600	7.69	8.51	0.49	0.16
	0.625	BN	5	0.1016	0.0508	2,402	1,600	9.10	11.12	2.17	0.12
TKS50	0.750	SN	1	0.0762	0.1778	1,334	2,438	43.06	46.13	2.54	0.42
	0.750	BN	2	0.1016	0.0508	12,588	1,600	25.36	28.43	2.54	0.21
	0.750	BN	5	0.1016	0.0508	4,893	1,600	20.42	23.49	2.54	0.17
TKS75	1.000	SN	4	0.0762	0.1778	1,779	2,438	64.23	80.06	8.04	0.31
	1.000	BN	1	0.1016	0.0508	10,631	2,438	88.83	104.66	8.04	0.39
	1.000	BN	2	0.1016	0.0508	14,234	2,438	69.15	84.97	8.04	0.31
	1.000	BN	4	0.1016	0.0508	8,985	2,438	64.23	80.06	8.04	0.28

 **Contact the factory for higher accuracy and lower backlash options.**

***For Acme screws, maximum thrust is the maximum continuous dynamic thrust subject to Thrust x Velocity limitation. For ball screws, maximum thrust reflects 90% reliability for 1 million linear inches of travel.**

SCREW TYPE DESCRIPTION

SN **Solid Nut**
BN **Ball Nut**

TKS

TKB

Sold & Serviced By:

 **ELECTROMATE**

Toll Free Phone (877) SERV098

Toll Free Fax (877) SERV099

www.electromate.com

sales@electromate.com

TKS Rodless Screw Drive Actuator

TKS SPECIFICATIONS

ACTUATOR SPECIFICATIONS

SPECIFICATIONS	U.S. CONVENTIONAL				METRIC					
		TKS10	TKS25	TKS50	TKS75		TKS10	TKS25	TKS50	TKS75
Carrier weight	lb	0.56	2.31	3.18	3.54	kg	0.25	1.05	1.44	1.61
Base weight (in-line model, including carrier • motor not included)	lb	3.22	9.46	14.56	17.95	kg	1.46	4.29	6.6	8.14
Weight per/in (mm) of stroke	lb	0.229	0.527	0.728	0.932	kg	0.10	0.24	0.33	0.42
Straightness (YX Plane) (unconstrained ¹)	in/in	0.0004				mm/mm	0.0004			
Straightness (YX Plane) (constrained ²)	in/in	0.0002				mm/mm	0.0002			
Flatness (ZX Plane) (unconstrained ¹)	in/in	0.0008				mm/mm	0.0008			
Flatness (ZX Plane) (constrained ²)	in/in	0.0002				mm/mm	0.0002			
Screw uni-directional repeatability ³	in	±0.0004				mm	±0.010			
Temperature Range ⁴	°F	40-130				°C	4-54			



¹ Listed values are intended for reference purposes only, and not as an engineering standard of absolute tolerance for a given actuator. Values were derived from testing of characteristic samples of appropriate products, and indicate an expected range of deviation from a theoretical straight line in the indicated plane of carrier motion. Appropriate installation is the single most important factor in reducing such deviation, so good engineering practices such as measurement, mapping, etc. must be employed in applications with stringent straightness/flatness requirements. For more information on how these values were obtained, please read the white paper on this subject available at www.tolomatic.com.

² Actuator mounted on a flat surface and fully restrained.

³ Ball screw; not including backlash

⁴ Heat generated by the motor and drive should be taken into consideration as well as linear velocity and work cycle time. For applications that require operation outside of the recommended temperature range, contact the factory.

LARGE FRAME MOTORS AND SMALLER SIZE ACTUATORS: Cantilevered motors need to be supported, if subjected to continuous rapid reversing duty and/or under dynamic conditions.

TKS

TKB

Sold & Serviced By:

 **ELECTROMATE**

Toll Free Phone (877) SERV098

Toll Free Fax (877) SERV099

www.electromate.com

sales@electromate.com

TKS Rodless Screw Drive Actuator

DIMENSIONS

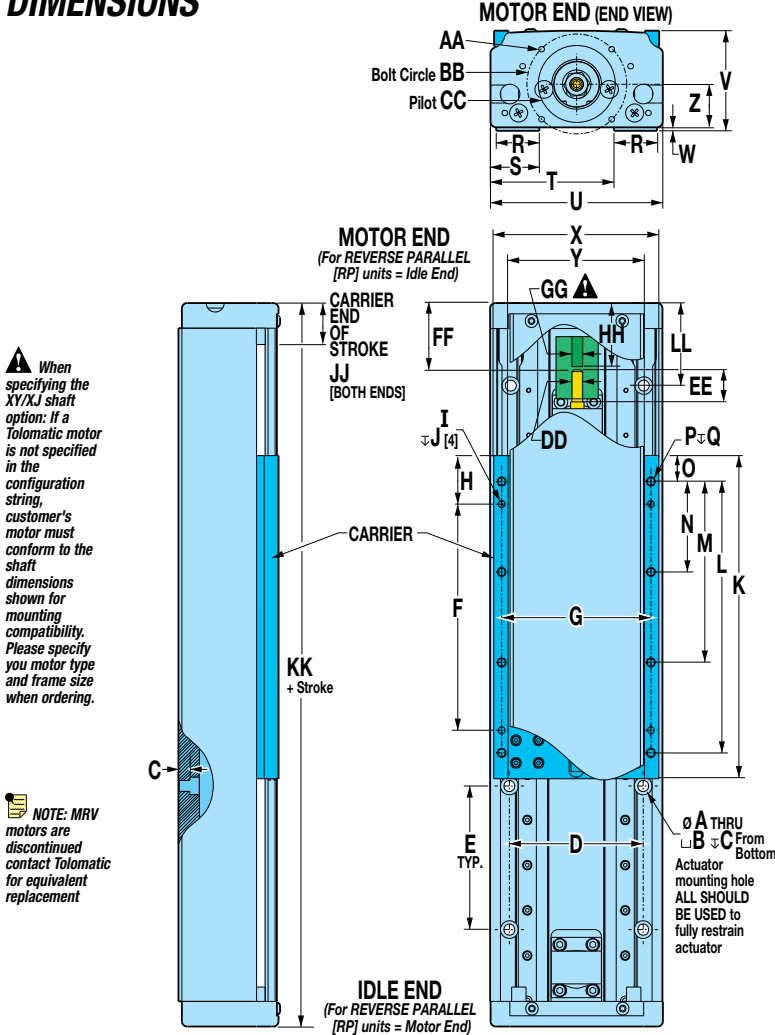

SIZE	10	25	50	75
A	0.19	0.26	0.26	0.34
mm	4.8	6.6	6.6	8.6
B	0.31	0.53	0.44	0.53
mm	7.9	13.5	11.2	13.5
C	0.24	0.31	0.28	0.28
mm	6.1	7.9	7.1	7.1
D	2.330	3.580	2.270	2.939
mm	59.18	90.93	57.66	74.65
E	2.500	2.500	5.000	5.000
mm	63.50	63.50	127.00	127.00
F	3.937	3.937	5.118	5.512
mm	100.00	100.00	130.00	140.00
G	2.599	3.937	4.724	5.315
mm	66.00	100.00	120.00	135.00
H	0.84	1.49	1.25	1.12
mm	21.4	38.0	31.8	28.4
I	0.12	0.24	0.24	0.24
mm	3.0	6.0	6.0	6.0
J	Thru	Thru	Thru	Thru
mm				
K	5.63	6.93	7.62	7.75
mm	142.9	175.9	193.5	196.9
L	4.725	5.512	7.086	7.244
mm	120.02	140.00	180.00	184.00
M	3.150	3.543	4.724	4.882
mm	80.00	90.00	120.00	124.00
N	1.575	1.968	2.362	2.362
mm	40.00	50.00	60.00	60.00
O	0.45	0.71	0.27	0.25
mm	11.4	18.0	6.8	6.4
P	M4	M6	M8	M8
mm				
Q	0.31	Thru	Thru	Thru
mm	7.9			
R	0.75	1.00	1.75	1.75
mm	19.1	25.4	44.5	44.5
S	0.85	1.22	2.00	2.00
mm	21.6	31.0	50.8	50.8
T	2.15	3.28	3.50	4.13
mm	54.6	83.3	88.9	104.9
U	3.00	4.50	5.50	6.13
mm	76.2	114.3	139.7	155.6
V	1.74	2.72	3.14	3.42
mm	44.2	69.1	79.8	86.9
W	0.06	0.06	0.06	0.06
mm	1.5	1.5	1.5	1.5
X	2.88	4.35	5.35	5.97
mm	73.0	110.6	135.9	151.7
Y	2.38	3.35	4.10	4.72
mm	60.3	85.2	104.1	119.9
Z	0.75	1.25	1.53	1.62
mm	19.1	31.6	38.9	41.2

SIZE	10				25				50				75	
	17	23		23		34		23		34		34		
Frame	MRS	Brushless	MRS	Brushless	Gearbox	Motor	Gearbox	Motor	Gearbox	Motor	Gearbox	Motor	Gearbox	
AA	#6-32	M5	M5	M5	M5	M5	M5	M5	M5	M5	M5	M5	M5	
mm	1.810	2.625	2.625	2.625	2.625	3.875	3.875	2.625	2.625	3.875	3.875	3.875	3.875	
BB Ø	1.810	2.625	2.625	2.625	2.625	3.875	3.875	2.625	2.625	3.875	3.875	3.875	3.875	
mm	45.97	66.68	66.68	66.68	66.68	98.43	98.43	66.68	66.68	98.43	98.43	98.43	98.43	
CC Ø	1.182	1.501	1.501	1.501	1.501	2.875	2.875	1.501	1.501	2.875	2.875	2.875	2.875	
mm	30.02	38.13	38.13	38.13	38.13	73.03	73.03	38.13	38.13	73.03	73.03	73.03	73.03	
DD	0.315	0.250	0.500	0.250	0.500	0.500	0.500	0.500	0.500	0.500	0.500	0.500	0.500	
mm	8.00	6.35	12.70	6.35	12.70	12.70	12.70	12.70	12.70	12.70	12.70	12.70	12.70	
EE	0.70	0.78	0.58	1.38	0.75	1.00	1.31	1.06	0.91	1.16	0.85	0.60	0.71	
mm	17.6	19.7	14.6	35.1	19.1	25.4	33.3	26.9	23.2	29.5	21.6	15.2	18.0	
FF	1.16	1.15	1.35	1.49	1.92	1.67	1.36	1.61	1.61	1.36	1.67	1.92	1.92	
mm	29.5	29.1	34.2	37.8	48.8	42.4	34.5	40.9	40.9	34.5	42.4	48.8	48.8	
GG	0.315	0.250	0.500	0.250	0.500	0.500	0.500	0.500	0.500	0.500	0.500	0.500	0.500	
mm	8.00	6.35	12.70	6.35	12.70	12.70	12.70	12.70	12.70	12.70	12.70	12.70	12.70	
HH	1.00	0.79	1.50	0.83	1.42	1.18	1.17	1.43	1.45	1.20	1.20	1.33	1.21	
mm	25.4	20.0	38.1	21.0	36.0	30.0	29.6	36.3	36.9	30.5	30.5	33.7	30.7	
JJ	0.69	motor = 0.75 idle = 0.69				1.00				1.13			1.12	
mm	17.5	19.1	17.5			25.4				28.7			28.4	
KK	7.00	7.06				8.92				9.87			10.31	
mm	177.8	179.4				226.6				250.7			261.9	
LL	1.44	1.50				1.63				1.75			1.67	
mm	36.5	38.1				41.3				44.5			42.4	

TKS Rodless Screw Drive Actuator

DIMENSIONS

TKS: DOUBLE C-FACE BRAKE OPTION

BRAKE FOR 23-FRAME MOTOR

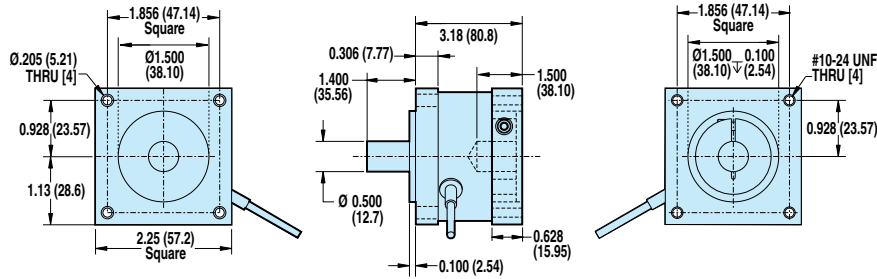

BRAKE FOR 34-FRAME MOTOR

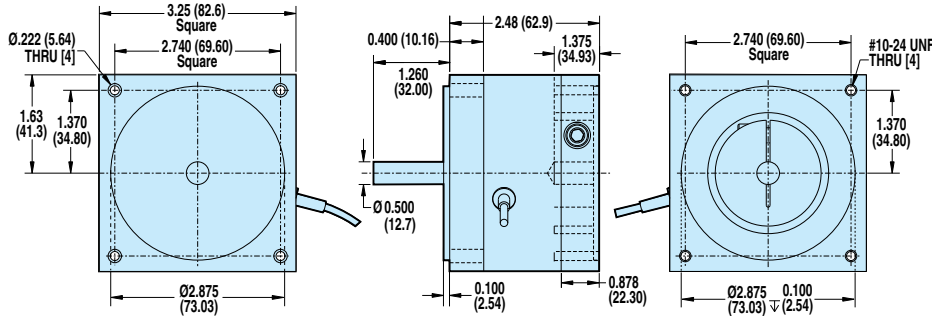

MOTOR TYPE	FRAME	BRAKE PART NO.	STATIC TORQUE		REFLECTED INERTIA		WEIGHT		VOLTAGE	CURRENT	RESISTANCE	CABLE LENGTH	
			lb-in	N-m	lb-in ²	kg-m ² x 10 ⁻⁶	lbs	kg				in	mm
BRUSHLESS	23	3600-6286	10	1.130	0.0125	3.66	1.49	0.68	24	0.286	83.6	16.75	425
	34	3600-6288	25	2.825	0.1087	31.79	2.88	1.31	24	0.369	65.1	18.0	457

MAXIMUM BRAKE HOLDING LOADS

LEADSCREW/NUT REDUCTION	23-FRAME BRAKE						34-FRAME BRAKE					
	INLINE		5:1 GEARBOX		10:1 GEARBOX		INLINE		5:1 GEARBOX		10:1 GEARBOX	
	lb	kg	lb	kg	lb	kg	lb	kg	lb	kg	lb	kg
TKS10 with SN02	180	81.6	180	81.6	180	81.6						
TKS10 with BN08	559	253.5	1874	850	1874	850						
TKS25 with SN02	180	81.6	180	81.6	180	81.6	180	81.6	180	81.6	180	81.6
TKS25 with BN02	140	63.5	903	409.5	1643	745.2	349	158.3	2259	1024.6	4107	1862.8
TKS25 with BN05	349	158.3	2259	1024.6	4008	1817.9	873	395.9	4008	1817.9	4008	1817.9
TKS50 with SN01	105	47.6	300	136.0	300	136.0	262	118.8	300	136.0	300	136.0
TKS50 with BN02	140	63.5	903	409.5	1643	745.2	349	158.3	2259	1024.6	4107	1862.8
TKS50 with BN05	349	158.3	2259	1024.6	4107	1862.8	873	395.9	5647	2561.4	10055	4560.8
TKS75 with SN04							419	190	419	190	419	190
TKS75 with BN01							175	79.3	1129	512.1	2053	931.2
TKS75 with BN02							349	158.3	2259	1024.6	4107	1862.8
TKS75 with BN04							698	316.6	4517	2048.8	8213	3725.3

Double C-face brakes are used for static holding (back driving prevention) and are not designed for dynamic stopping. Please contact Tolomatic if your application requires dynamic stopping. This brake can be used with other Tolomatic systems. Consult Tolomatic for availability.

NOTE: MRB & MRV motors are discontinued contact Tolomatic for information

Sold & Serviced By:

ELECTROMATE

Toll Free Phone (877) SERV098

Toll Free Fax (877) SERV099

www.electromate.com

sales@electromate.com

TKS Rodless Screw Drive Actuator

DIMENSIONS

TKS: REVERSE PARALLEL MOUNTING

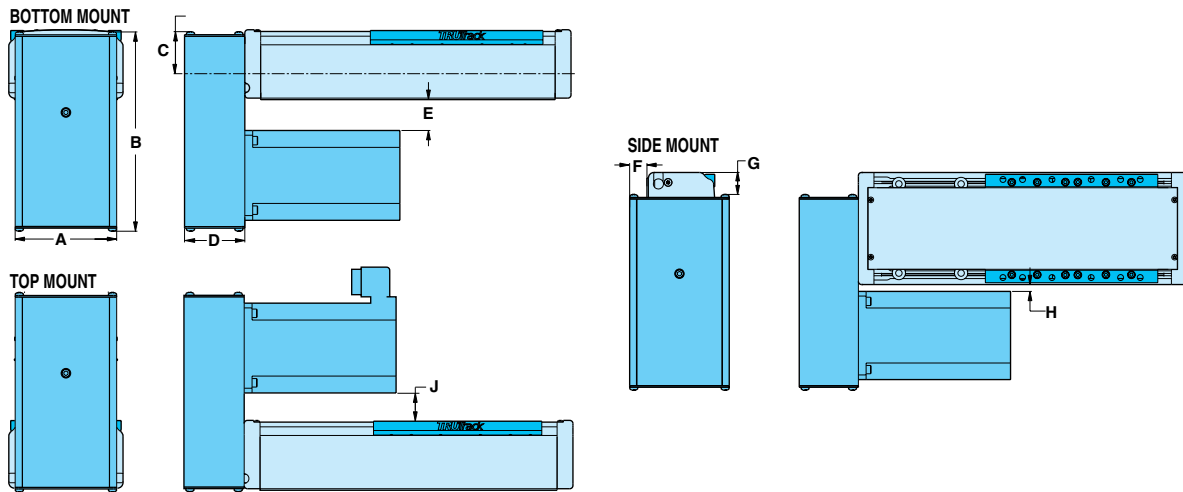

		A		B		C		D		E		F		G		H		J			
		in.	mm	in.	mm	in.	mm	in.	mm	in.	mm	in.	mm	in.	mm	in.	mm	in.	mm		
BRUSHLESS	TKS10	11, 21, 22, 23, 24 Frame Motor		3.25	82.6	5.70	144.8	1.27	32.3	2.13	54.1	0.98	24.9	0.82	20.8	0.38	9.7	0.29	7.4	0.86	21.8
				23 Frame																	
	TKS25	21, 22, 23, 24 Frame		3.25	82.6	7.02	178.4	1.33	33.8	2.13	54.1	1.74	44.2	0.32	8.1	1.07	27.2	0.8	20.3	1.78	45.2
		31, 32, 33 Frame		4.00	101.6	7.79	197.9	1.33	33.8	2.38	60.5	0.97	24.6	0.69	17.5	1.07	27.2	0.15	3.8	1.01	25.7
TKS50	21, 22, 23, 24 Frame		3.25	82.6	7.02	178.4	1.33	33.8	2.13	54.1	1.74	44.2	0.32	8.1	1.07	27.2	0.80	20.3	1.78	45.2	
	31, 32, 33 Frame		4.00	101.6	7.79	197.9	1.33	33.8	2.38	60.5	0.97	24.6	0.69	17.5	1.07	27.2	0.15	3.8	1.01	25.7	
TKS75	31, 32, 33 Frame Motor		4.00	101.6	8.98	228.1	1.77	45.0	4.00	101.6	1.35	34.3	0.32	8.1	1.45	36.8	0.08	2.0	1.29	32.8	
		34 Frame																			

SPECIFICATIONS

		WEIGHT OF REDUCTION DRIVE				REDUCTION INERTIA AT MOTOR SHAFT					
		1:1		2:1		1:1		2:1			
		lbs	kg	lbs	kg	lb-in ²	kg-cm ²	lb-in ²	kg-cm ²		
BRUSHLESS	TKS10	11, 21, 22, 23, 24 Frame Motor		1.80	0.82	1.80	0.82	0.039	0.1141	0.047	0.1368
	TKS25	21, 22, 23, 24 Frame		2.51	1.14	2.74	1.24	0.038	0.1112	0.103	0.3014
		31, 32, 33 Frame Motor		2.75	1.25	2.98	1.35	0.038	0.1112	0.103	0.3014
TKS50	21, 22, 23, 24 Frame		2.85	1.29	3.08	1.40	0.036	0.1054	0.227	0.6628	
	31, 32, 33 Frame Motor		3.40	1.54	3.56	1.62	0.036	0.1054	0.227	0.6628	
TKS75	31, 32, 33 Frame Motor		3.40	1.54	3.56	1.62	0.036	0.1054	0.227	0.6628	

REDUCTION EFFICIENCY: 0.95

TKS

TKB

Sold & Serviced By:

ELECTROMATE

Toll Free Phone (877) SERV098

Toll Free Fax (877) SERV099

www.electromate.com

sales@electromate.com

TKB Rodless Belt Drive Actuator

BELT PERFORMANCE

BELT FORCE AND SPEED CAPACITIES

BELT FORCE FOR TKB ACTUATORS

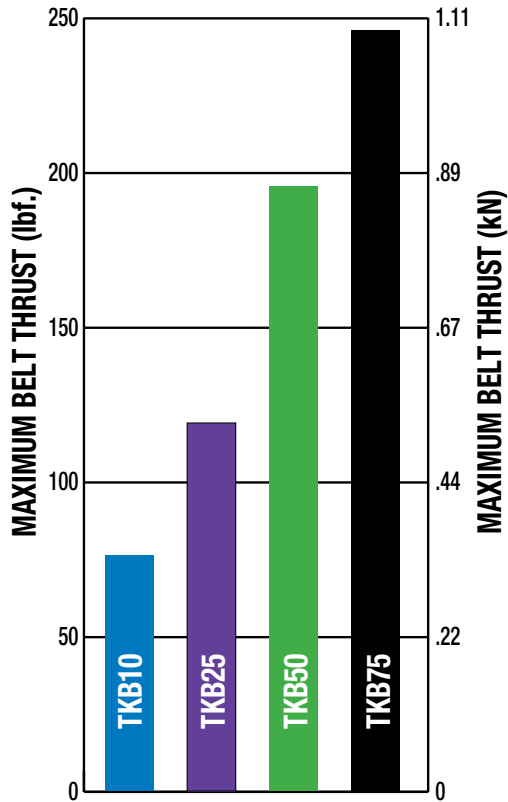

MAXIMUM BELT SPEED FOR TKB ACTUATORS

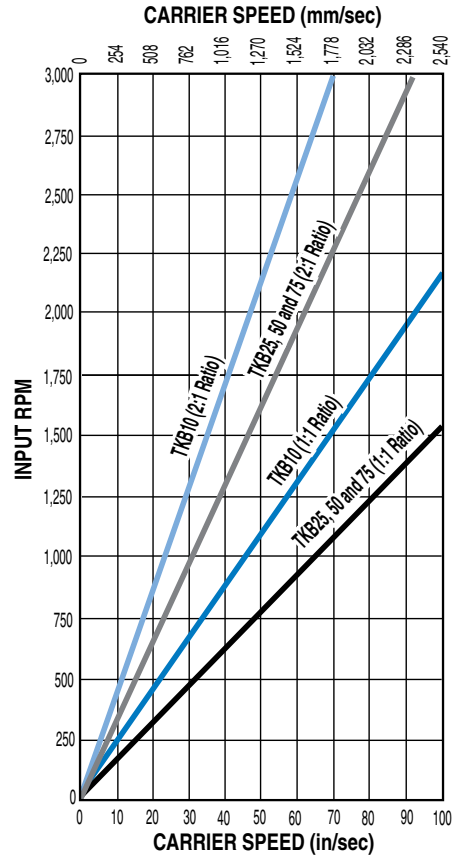

BELT SPECIFICATIONS

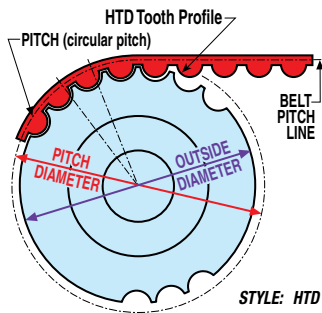

STYLE: HTD Tooth

TOOTH PITCH: 5mm

BELT MATERIAL: Polyurethane body with steel tension members

- CHARACTERISTICS:
- For higher speed, higher load applications
 - Heavy duty drive and idler pulley bearings

MAX ACCELERATION

AS A FUNCTION OF CARRIER LOAD WEIGHT

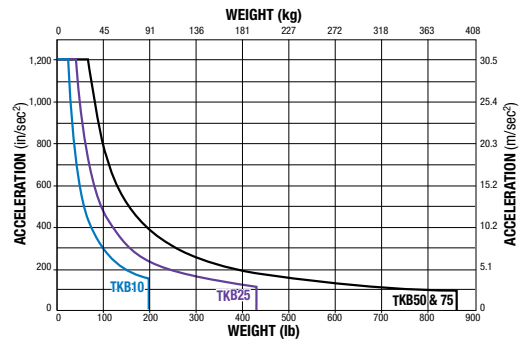

TKS

TKB

Sold & Serviced By:

ELECTROMATE

Toll Free Phone (877) SERV098

Toll Free Fax (877) SERV099

www.electromate.com

sales@electromate.com

TKB Rodless Belt Drive Actuator

TKB SPECIFICATIONS

TKB BELT, INERTIA AND BREAKAWAY TORQUE SPECIFICATIONS

TKB ACTUATORS (US STANDARD MEASUREMENTS)								
	MAXIMUM STROKE	BELT WIDTH	BELT DEAD LENGTH	WHEEL PITCH DIA.	MOTION RATIO	STRAIGHTNESS & FLATNESS (in) ¹	TEMP. RANGE ²	BREAKAWAY TORQUE
	(in)	(in)	(in)	(in)	(in/rev)	(Constrained)	(F°)	(lb-in)
TKB10	96	0.59	15.88	0.89	2.787	0.0002	40 - 130	3.5
TKB25	96	1.00	23.12	1.19	3.742	0.0002	40 - 130	10.0
TKB50	96	1.57	26.23	1.19	3.742	0.0002	40 - 130	10.0
TKB75	96	1.97	25.68	1.19	3.742	0.0002	40 - 130	10.0

TKB ACTUATORS (METRIC MEASUREMENTS)								
	MAXIMUM STROKE	BELT WIDTH	BELT DEAD LENGTH	WHEEL PITCH DIA.	MOTION RATIO	STRAIGHTNESS & FLATNESS (mm) ¹	TEMP. RANGE ²	BREAKAWAY TORQUE
	(mm)	(mm)	(mm)	(mm)	(mm/rev)	(Constrained)	(C°)	(N-m)
TKB10	2438	15.0	333.6	22.5	70.78	0.005	4 - 54	0.35
TKB25	2438	25.4	533.8	30.3	95.05	0.005	4 - 54	1.06
TKB50	2438	40.0	867.4	30.3	95.05	0.005	4 - 54	1.06
TKB75	2438	50.0	1089.8	30.3	95.05	0.005	4 - 54	1.06

GENERAL ACTUATOR SPECIFICATIONS

TKB ACTUATORS (US STANDARD MEASUREMENTS)						
	CARRIER WEIGHT	BASE WEIGHT (inc. carrier)	WEIGHT PER (in) OF STROKE	INERTIA (lb-in ²) BASE ACTUATOR (inc. carrier assy.)	INERTIA (lb-in ²) PER (in) OF STROKE	REPEATABILITY
	(lbs)	(lbs)	(lbs)			(in)
TKB10	0.64	3.23	0.20	0.165	0.0012	±0.002
TKB25	2.41	10.69	0.46	1.100	0.0046	±0.002
TKB50	3.38	14.99	0.61	1.576	0.0072	±0.002
TKB75	4.42	18.34	0.72	2.039	0.0090	±0.002

TKB ACTUATORS (METRIC MEASUREMENTS)						
	CARRIER WEIGHT	BASE WEIGHT (inc. carrier)	WEIGHT PER (in) OF STROKE	INERTIA (kg-cm ²) BASE ACTUATOR (inc. carrier assy.)	INERTIA (kg-cm ²) PER (in) OF STROKE	REPEATABILITY
	(kg)	(kg)	(kg)			(mm)
TKB10	0.3	1.5	0.09	0.48	0.41	±0.05
TKB25	1.1	4.8	0.21	3.22	1.29	±0.05
TKB50	1.5	6.8	0.28	4.61	2.05	±0.05
TKB75	1.5	8.3	0.32	5.97	2.54	±0.05

 ¹ The listed values relating to straightness/flatness are intended for reference purposes only, and not as an engineering standard of absolute tolerance for a given actuator. Appropriate installation is the single most important factor in reducing such deviation, so good engineering practices such as measurement, mapping, etc. must be employed in applications with stringent straightness/flatness requirements.

² Heat generated by the motor and drive should be taken into consideration as well as linear velocity and work cycle time. For applications that require operation outside of the recommended temperature range, contact the factory.

LARGE FRAME MOTORS AND SMALLER SIZE ACTUATORS: Cantilevered motors need to be supported, if subjected to continuous rapid reversing duty and/or under dynamic conditions.

TKS

TKB

Sold & Serviced By:

 **ELECTROMATE**

Toll Free Phone (877) SERV098

Toll Free Fax (877) SERV099

www.electromate.com

sales@electromate.com

TKB Rodless Belt Drive Actuator

DIMENSIONS

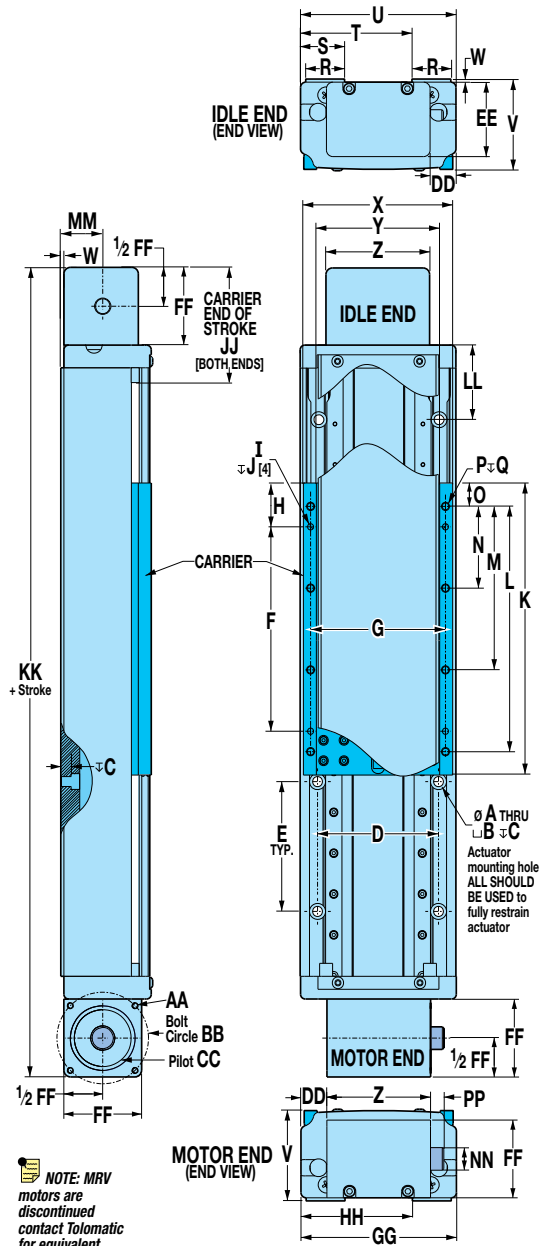

NOTE: MRV motors are discontinued contact Tolomatic for equivalent replacement

SIZE	10	25	50	75
A Ø	0.19	0.26	0.26	0.34
mm	4.8	6.6	6.6	8.6
B Ø	0.31	0.53	0.44	0.53
mm	7.9	13.5	11.2	13.5
C	0.17	0.92	0.28	0.34
mm	4.3	23.4	7.1	8.6
D	2.330	3.580	2.270	2.939
mm	59.18	90.93	57.66	74.65
E	2.500	2.500	5.000	5.000
mm	63.50	63.50	127.00	127.00
F	3.937	3.937	5.118	5.512
mm	100.00	100.00	130.00	140.00
G	2.599	3.937	4.724	5.315
mm	66.00	100.00	120.00	135.00
H	0.84	1.49	1.25	1.12
mm	21.4	38.0	31.8	28.4
I	0.12	0.24	0.24	0.24
mm	3.0	6.0	6.0	6.0
J	Thru	Thru	Thru	Thru
mm				
K	5.63	6.93	7.62	7.75
mm	142.9	175.9	193.5	196.9
L	4.725	5.512	7.086	7.244
mm	120.02	140.00	180.00	184.00
M	3.150	3.543	4.724	4.882
mm	80.00	90.00	120.00	124.00
N	1.575	1.968	2.362	2.362
mm	40.00	50.00	60.00	60.00
O	0.45	0.71	0.27	0.25
mm	11.4	18.0	6.8	6.4
P	M4	M6	M8	M8
mm				
Q	0.31	Thru	Thru	Thru
mm	7.9			
R	0.75	1.00	1.75	1.75
mm	19.1	25.4	44.5	44.5
S	0.85	1.22	2.00	2.00
mm	21.6	31.0	50.8	50.8
T	2.15	3.28	3.50	4.13
mm	54.6	83.3	88.9	104.9

SIZE	10	25	50	75
U	3.00	4.50	5.50	6.13
mm	76.2	114.3	139.7	155.6
V	1.74	2.72	3.14	3.42
mm	44.2	69.1	79.8	86.9
W	0.06	0.06	0.06	0.06
mm	1.5	1.5	1.5	1.5
X	2.88	4.35	5.35	5.97
mm	73.0	110.6	135.9	151.7
Y	2.38	3.35	4.10	4.72
mm	60.3	85.2	104.1	119.9
Z	2.00	2.88	3.71	3.94
mm	50.8	73.0	94.3	100.0
AA	M5	M5	M5	M5
mm				
BB	1.768	2.475	2.475	2.475
mm	44.90	62.86	62.86	62.86
CC	1.251	1.751	1.751	1.751
mm	31.78	44.48	44.48	44.48
DD	0.50	0.81	0.90	1.10
mm	12.7	20.7	22.9	27.9
EE	1.44	2.25	2.25	2.25
mm	36.5	57.2	57.2	57.2
FF	1.50	2.25	2.25	2.25
mm	38.1	57.2	57.2	57.2
GG	3.00	4.50	5.50	6.13
mm	76.2	114.3	139.7	155.6
HH	2.15	3.28	3.50	4.13
mm	54.6	83.3	88.9	104.9
JJ	2.19	3.25	3.37	3.37
mm	55.6	82.4	85.6	85.6
KK	10.00	13.42	14.37	14.81
mm	254.0	340.9	365.0	376.1
LL	1.43	1.63	1.75	1.75
mm	37.0	41.3	44.5	44.5
MM	0.81	1.44	1.83	1.86
mm	20.6	36.5	46.5	47.2
NN	0.436	0.500	0.500	0.500
mm	11.07	12.70	12.70	12.70

SIZE	10	25	50	75				
FRAME	23		23		34	23	34	34
MOTOR	MRS	"MRV"	MRS	"MRV"	34	23	34	34
PP	1.40	0.71	1.46	0.79	0.79	0.81	0.81	0.82
mm	35.6	18.1	37.0	20.1	20.1	20.5	20.5	20.8

TKS

TKB

Sold & Serviced By:

ELECTROMATE

Toll Free Phone (877) SERV098

Toll Free Fax (877) SERV099

www.electromate.com

sales@electromate.com

TKB Rodless Belt Drive Actuator

DIMENSIONS

TKB DIRECT DRIVE MOTOR MOUNTING

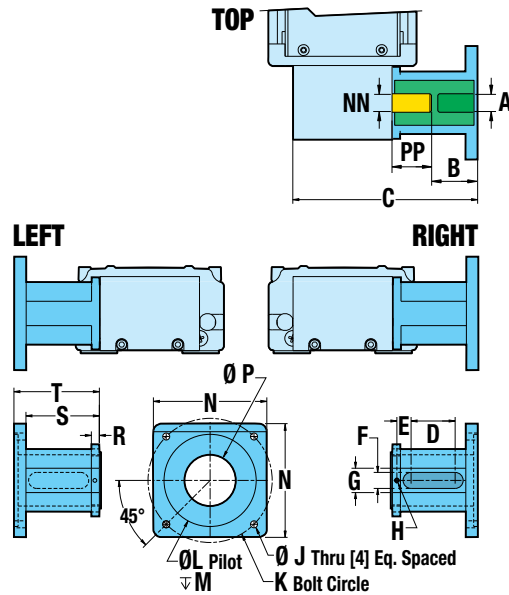

If a Tolomatic motor is not specified in the configuration string, customer's motor must conform to the shaft dimensions shown for mounting compatibility. Please specify your motor type and frame size when ordering.

NOTE: MRB & MRV motors are discontinued contact Tolomatic for information

SIZE	10		25		50		75	
FRAME	23	23	34	23	34	34	34	34
A								
mm								
B	1.667	1.936	1.686	1.920	1.670	1.661		
mm	42.34	49.17	42.82	48.77	42.42	42.19		
C	4.63	5.85	5.85	5.85	5.85	6.19		
mm	117.6	1.486	1.486	1.486	1.486	157.2		
D	1.45	1.38	1.60	1.38	1.60	1.60		
mm	36.8	34.9	40.6	34.9	40.6	40.6		
E	0.34	0.47	0.36	0.47	0.36	0.36		
mm	8.6	11.9	9.1	11.9	9.1	9.1		
F	0.38	0.50	0.50	0.50	0.50	0.50		
mm	9.5	12.7	12.7	12.7	12.7	12.7		
G	0.77	0.76	0.76	0.76	0.76	0.76		
mm	19.6	19.3	19.3	19.3	19.3	19.3		
H	Ø M3	Ø M3	Ø M3	Ø M3	Ø M3	Ø M3		
J	M5	M5	M5	M5	M5	M5		
K	2.625	2.625	3.875	2.625	3.875	3.875		
mm	66.68	66.68	98.43	66.68	98.43	98.43		
L	1.503	1.503	2.877	1.503	2.877	2.877		
mm	38.2	38.2	73.1	38.2	73.1	73.1		
M	0.13	0.13	0.13	0.13	0.13	0.13		
mm	3.3	3.3	3.3	3.3	3.3	3.3		
N	2.25	2.25	3.54	2.25	3.54	3.54		
mm	57.2	57.2	89.9	57.2	89.9	89.9		
P	0.75	1.35	1.60	1.35	1.60	1.60		
mm	19.1	34.3	40.6	34.3	40.6	40.6		
R	0.25	0.25	0.25	0.25	0.25	0.25		
mm	6.4	6.4	6.4	6.4	6.4	6.4		
S	2.26	2.35	2.10	2.35	2.10	2.10		
mm	57.3	59.8	53.4	59.8	53.4	53.4		
T	2.63	2.73	2.48	2.73	2.48	2.48		
mm	66.9	69.3	62.9	69.3	62.9	62.9		
NN	Ø 0.375	Ø 0.500	Ø 0.500	Ø 0.500	Ø 0.500	Ø 0.500		
mm	9.53	12.70	12.70	12.70	12.70	12.70		
PP	0.965	0.793	0.793	0.808	0.808	0.817		
mm	24.51	20.14	20.14	20.52	20.52	20.75		

TKS & TKB: MOUNTING PLATE OPTION

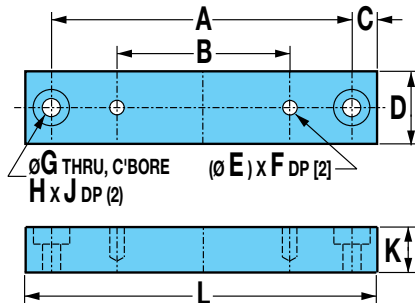

SIZE	10	25	50	75
A	3.500	5.125	6.250	7.000
mm	88.90	130.18	158.75	177.80
B	2.330	3.580	2.270	2.939
mm	59.10	90.93	57.66	74.65
C	0.25	0.31	0.38	0.50
mm	6.4	8.0	9.5	12.7
D	0.75	1.00	1.00	1.00
mm	19.1	25.4	25.4	25.4
E	M4x0.7	M6x1.0	M6x1.0	M6x1.0
mm				
F	0.31	0.50	0.50	0.31
mm	7.8	12.7	12.7	7.8

SIZE	10	25	50	75
G	Ø 0.19	Ø 0.26	Ø 0.26	Ø 0.34
mm	Ø 4.8	Ø 6.6	Ø 6.6	Ø 8.6
H	Ø 0.31	Ø 0.44	Ø 0.44	Ø 0.53
mm	Ø 7.8	Ø 11.1	Ø 11.1	Ø 13.4
J	0.17	0.28	0.28	0.31
mm	4.3	7.1	7.1	7.8
K	0.75	0.88	0.63	0.63
mm	19.1	22.3	16.0	16.0
L	4.00	5.75	7.00	8.00
mm	101.6	146.0	177.8	203.2

Sold & Serviced By:

ELECTROMATE

Toll Free Phone (877) SERV098

Toll Free Fax (877) SERV099

www.electromate.com

sales@electromate.com

TKS

TKB

TKB Rodless Belt Drive Actuator

DIMENSIONS

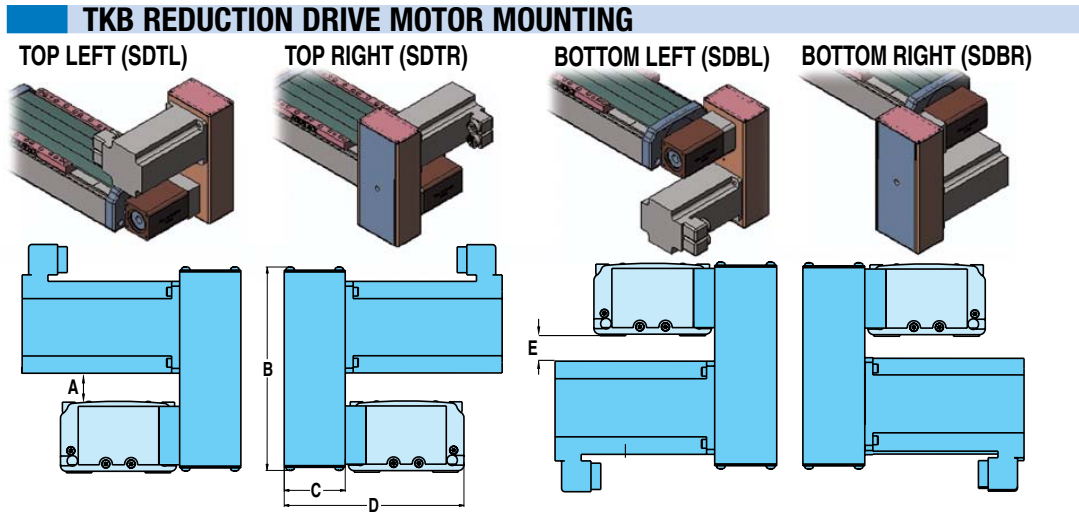

DIMENSIONS

		A		B		C		D		E	
		in	mm	in	mm	in	mm	in	mm	in	mm
10	11 Frame Motor	1.21	30.7	5.70	144.8	2.13	54.1	4.50	114.3	1.33	33.7
	21, 22, 23, 24 Frame Motor	0.86	21.9	5.70	144.8	2.13	54.1	4.50	114.3	0.98	24.9
25	21, 22, 23, 24 Frame Motor	1.77	44.9	7.02	178.3	2.13	54.1	5.67	144.1	1.61	40.8
	31, 32, 33 Frame Motor	1.12	28.5	7.79	197.9	2.38	60.5	5.92	150.4	0.96	24.4
50	21, 22, 23, 24 Frame Motor	2.50	63.4	8.34	211.8	2.13	54.1	6.48	164.6	1.96	49.7
	31, 32, 33 Frame Motor	1.85	47.0	8.98	228.1	2.38	60.5	6.73	170.9	1.31	33.3
75	31, 32, 33 Frame Motor	1.60	40.7	8.98	228.1	2.38	60.5	7.00	177.9	1.28	32.5

SPECIFICATIONS

		WEIGHT OF REDUCTION DRIVE				REDUCTION INERTIA AT MOTOR SHAFT			
		1:1		2:1		1:1		2:1	
		lbs	kg	lbs	kg	lb-in ²	kg-cm ²	lb-in ²	kg-cm ²
10	11, 21, 22, 23, 24 Frame Motor	1.80	0.82	1.80	0.82	0.039	0.1141	0.047	0.1368
	21, 22, 23, 24 Frame Motor	2.55	1.16	2.78	1.26	0.036	0.1054	0.227	0.6628
25	31, 32, 33 Frame Motor	2.80	1.27	3.03	1.37	0.036	0.1054	0.227	0.6628
	21, 22, 23, 24 Frame Motor	2.87	1.30	3.10	1.40	0.036	0.1054	0.227	0.6628
50	31, 32, 33 Frame Motor	3.44	1.56	3.60	1.63	0.036	0.1054	0.227	0.6628
	31, 32, 33 Frame Motor	3.44	1.56	3.60	1.63	0.036	0.1054	0.227	0.6628

REDUCTION EFFICIENCY: 0.95

 **NOTE:** MRB & MRV motors are discontinued contact Tolomatic for information

TKS

TKB

Sold & Serviced By:

 **ELECTROMATE**

Toll Free Phone (877) SERV098

Toll Free Fax (877) SERV099

www.electromate.com

sales@electromate.com

TKS & TKB Rodless Actuators

SWITCHES





DC REED AND HALL-EFFECT

There are 4 sensing choices: DC reed, form A (open) or form C (open or closed); Hall-effect, sourcing, PNP (open); Hall-effect, sinking, NPN (open); each with either flying leads. Commonly used to send analog signals to PLC (programmable logic controllers), TLL, CMOS circuit or other controller device. These switches are activated by the actuator's magnet.

Switches contain reverse polarity protection.

If necessary to remove factory installed switches, be sure to reinstall on the same of side of actuator with scored face of switch toward internal magnet.

SPECIFICATIONS

ORDER CODE	REED DC		HALL-EFFECT DC	
	R T	B T	T T	K T
PART NUMBER	3600-9082	3600-9084	3600-9088	3600-9090
LEAD	5M	5M	5M	5M
CABLE SHIELDING	UNSHIELDED	UNSHIELDED	UNSHIELDED	UNSHIELDED
SWITCHING LOGIC	"A" NORMALLY OPEN	"C" NORMALLY OPEN OR CLOSED	PNP (SOURCING) NORMALLY OPEN	NPN (SINKING) NORMALLY OPEN
MECHANICAL CONTACTS	SINGLE-POLE SINGLE-THROW	SINGLE-POLE DOUBLE-THROW	NO, THESE ARE SOLID STATE COMPONENTS	
COIL DIRECT	YES	YES	—	
POWER LED	NONE	NONE	NONE	NONE
SIGNAL LED	RED 		RED 	RED 
OPERATING VOLTAGE	200 VDC MAX.	120 VDC MAX.	5 - 25 VDC	
OUTPUT RATING	—		25 VDC, 200MA DC	
OPERATING TIME	0.6 MSEC MAX. (INCLUDING BOUNCE)	0.7 MSEC MAX. (INCLUDING BOUNCE)	< 10 MICRO SEC.	
OPERATING TEMPERATURE	-40°F [-40°C] TO 158°F [70°C]		0°F [-18°C] TO 150°F [66°C]	
RELEASE TIME	1.0 MSEC. MAX.		—	
ON TRIP POINT	—		150 GAUSS MAXIMUM	
OFF TRIP POINT	—		40 GAUSS MINIMUM	
**POWER RATING (WATTS)	10.0 §	3.0 § §	5.0	
VOLTAGE DROP	2.6 V TYPICAL AT 100 MA	NA	—	
RESISTANCE	0.1 Ω INITIAL (MAX.)		—	
CURRENT CONSUMPTION	—		200 MA AT 25 VDC	
CABLE MIN. BEND RADIUS	STATIC	0.630" [16MM]		
	DYNAMIC	NOT RECOMMENDED		

⚠ CAUTION: DO NOT OVER TIGHTEN SWITCH HARDWARE WHEN INSTALLING!

⚠ ** WARNING: Do not exceed power rating (Watt = Voltage X Amperage). Permanent damage to sensor will occur.

§ Maximum current 500mA (not to exceed 10VA) Refer to Temperature vs. Current graph and Voltage Derating graph

§§ Maximum current 250mA (not to exceed 3VA) Refer to Temperature vs. Current graph and Voltage Derating graph

Reed Switch Life Expectancy: Up to 200,000,000 cycles (depending on load current, duty cycle and environmental conditions)

Sold & Serviced By:



Toll Free Phone (877) SERV098

Toll Free Fax (877) SERV099

www.electromate.com

sales@electromate.com

TKS & TKB Rodless Actuators

SWITCH PERFORMANCE

TEMP. vs CURRENT, DC REED

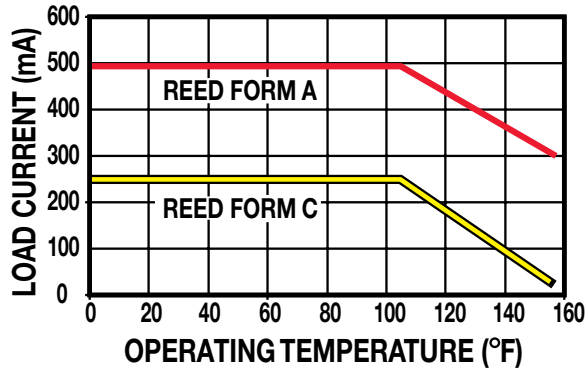

VOLTAGE DERATING, DC REED

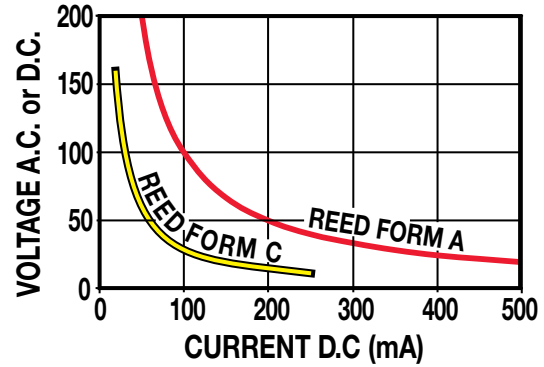

WIRING DIAGRAMS

DC REED, FORM A

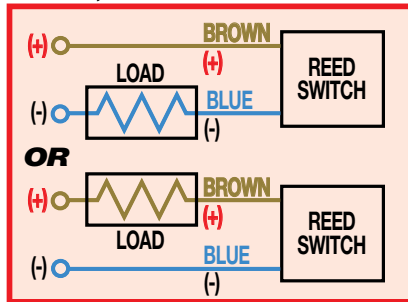

DC REED, FORM C

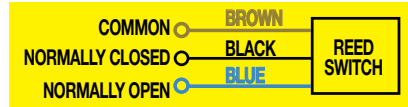

HALL-EFFECT, SOURCING, PNP

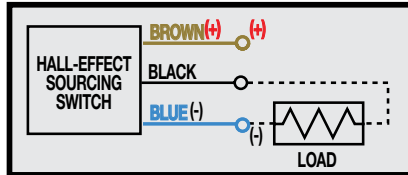

HALL-EFFECT, SINKING, NPN

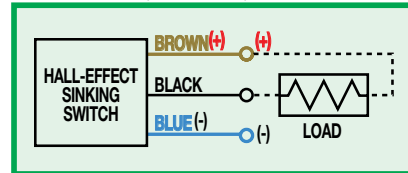

INSTALLATION INFORMATION



⚠
THE NOTCHED FACE OF THE SWITCH INDICATES THE SENSING SURFACE AND MUST FACE TOWARD THE MAGNET.

TKS

TKB

Sold & Serviced By:

ELECTROMATE

Toll Free Phone (877) SERV098

Toll Free Fax (877) SERV099

www.electromate.com

sales@electromate.com

COMPILE APPLICATION REQUIREMENTS

ORIENTATION

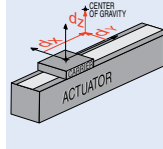
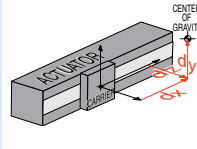
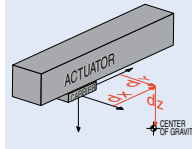
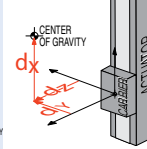
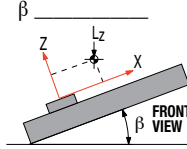
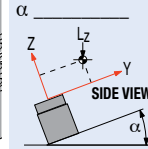
 Horizontal

 Side

 Horizontal Down

 Vertical

 Angled °

 Load attached to carrier OR Load supported by other mechanism

APPLICATION DATA WORKSHEET

Fill in known data. Not all information is required for all applications

DISTANCE FROM CENTER OF CARRIER TO LOAD CENTER OF GRAVITY

 d_x _____

 d_y _____

 d_z _____

 inch
(U.S. Standard)

 millimeter
(Metric)

STROKE LENGTH

 inch (SIK)
(U.S. Standard)

 millimeters
(Metric)

▲ NOTE: If load or force on carrier changes during cycle use the highest numbers for calculations

LOAD

 lb.
(U.S. Standard)

 kg.
(Metric)

THRUST REQUIRED

 lbf.
(U.S. Standard)

 N
(Metric)

 F_z _____

 F_y _____

BENDING MOMENTS APPLIED TO CARRIER

 in.-lbs.
(U.S. Standard)

 N-m
(Metric)

 M_x _____

 M_y _____

 M_z _____

PRECISION

Repeatability _____

 inch

 millimeters

OPERATING ENVIRONMENT

Temperature, Contamination, etc.

MOTION PROFILE

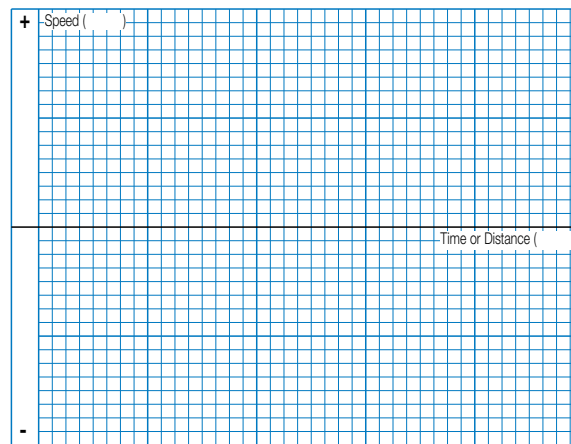

Graph your most demanding cycle, including accel/decel, velocity and dwell times. You may also want to indicate load variations and I/O changes during the cycle. Label axes with proper scale and units.

MOVE PROFILE

Move Distance _____

 inch

 millimeters

Dwell Time After Move _____

Max. Speed _____

 in/sec

 mm/sec

TKS

MOVE TIME

 sec

TKS

NO. OF CYCLES

 per minute

 per hour

CONTACT INFORMATION

 Name, Phone, Email
 Co. Name, Etc.

Sold & Serviced By:

Toll Free Phone (877) SERV098

Toll Free Fax (877) SERV099

www.electromate.com
sales@electromate.com

SELECTION GUIDELINES

The process of selecting a load bearing actuator for a given application can be complex. It is highly recommended that you contact Tolomatic or a Tolomatic Distributor for assistance in selecting the best actuator for your application. The following overview of the selection guidelines are for educational purposes only.

1 CHOOSE ACTUATOR SIZE

Choose an actuator that has the thrust, speed and moment load capacity to move the load. Use the Critical Speed graph (page TK_11&12) for the screw and the Moment and Load Capacity table (pg. TK_8) for the actuator.

2 COMPARE LOAD TO MAXIMUM LOAD CAPACITIES

Calculate the application load (combination of load mass and forces applied to the carrier) and application bending moments (sum of all moments M_x , M_y , and M_z applied to the carrier). Be sure to evaluate the magnitude of dynamic inertia moments. When a rigidly attached load mass is accelerated or decelerated, its inertia induces bending moments on the carrier. Careful attention to how the load is decelerated at the end of the stroke is required for extended actuator performance and application safety. If either load or any of your moments exceed figures indicated in the

Moment and Load Capacity table (pg. TK_10) for the actuator consider:

- 1) Higher capacity bearing style
- 2) A larger actuator size
- 3) Auxiliary carrier
- 4) External guide system

3 CALCULATE LOAD FACTOR LF

For loads with a center of gravity offset from the carrier account for both applied (static) and dynamic loads. The load factor (LF) must not exceed the value of 1.5

$$L_f = \frac{M_x}{M_{x_{max}}} + \frac{M_y}{M_{y_{max}}} + \frac{M_z}{M_{z_{max}}} + \frac{F_y}{F_{y_{max}}} + \frac{F_z}{F_{z_{max}}} \leq 1.5$$

If LF does exceed the value of 1.5, consider the four choices listed in step #2.

4 ESTABLISH YOUR MOTION PROFILE AND CALCULATE ACCELERATION RATE

Using the application stroke length and maximum carrier velocity (or time to complete the linear motion), establish the motion profile. Select either triangular (accel-decel) or trapezoidal (accel-constant speed-decel) profile. Now calculate the maximum acceleration and deceleration rates of the move. Based on the stroke length, speed and acceleration rate, etc. select either a screw-driven (TKS) or belt-driven (TKB). In a TKS screw-driven actuator speed should not exceed the value in the critical speed capacity graph (page TK_11&12) for the screw/nut combination chosen. Also, do not exceed safe rates of dynamic inertia moments determined in step #3. In a TKB belt-driven actuator verify that the belt thrust and acceleration values to not exceed allowable limits (page TK_21).

SPEED FACTOR

FOR APPLICATIONS WITH HIGH SPEED OR SIGNIFICANT SHOCK AND VIBRATION: Calculated values of loads and bending moments must be increased by speed factor from the graph below to obtain full rated life of profiled rail bearing system.

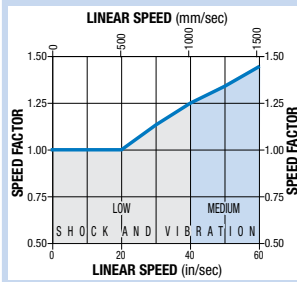

calculate the maximum acceleration and deceleration rates of the move. Based on the stroke length, speed and acceleration rate, etc. select either a screw-driven (TKS) or belt-driven (TKB). In a TKS screw-driven actuator speed should not exceed the value in the critical speed capacity graph (page TK_11&12) for the screw/nut combination chosen. Also, do not exceed safe rates of dynamic inertia moments determined in step #3. In a TKB belt-driven actuator verify that the belt thrust and acceleration values to not exceed allowable limits (page TK_21).

5 SELECT THE LEAD SCREW

Based on the application requirements for accuracy, backlash, quiet operation, life, etc. select the appropriate lead screw type (Acme screw with a solid nut or ball screw with a standard or anti-backlash nut) and the pitch (lead). For additional information on screw selection, consult "Which Screw? Picking the Right Technology" (#9900-4644) available at www.tolomatic.com.

6 SELECT MOTOR (GEARHEAD IF NECESSARY) AND DRIVE

To help select a motor and drive, use the sizing equations located in the Engineering Resources section [ENGR] to calculate the application thrust and torque requirements. Refer to Motor sections & [MRS] to determine the motor and drive.

7 DETERMINE MOUNTING PLATE REQUIREMENTS

- Consult the Support Recommendations graph for the model selected (page TK_10)
- Cross reference the application load and maximum distance between supports
- Select the appropriate number of mounting plates if required for motor and adapter clearance.

8 CONSIDER OPTIONS

- BE2 Bellows for ingress protection
- LU Low dust generating grease
- BRK In-line mounted brake
- Switches - Reed, Solid State PNP or NPN, all available normally open or normally closed

TKS

TKB

Sold & Serviced By:

ELECTROMATE

Toll Free Phone (877) SERV098

Toll Free Fax (877) SERV099

www.electromate.com

sales@electromate.com

TKS Rodless Screw Drive Actuator

ORDERING

BASE MODEL SPECIFICATIONS

TKS 50 BNO2 SK55 LMB

OPTIONS SPECIFICATIONS

DC18 KT2 BE2 BRK LU MP4

MODEL

TKS TrueTrack Screw Drive Actuator

PAYLOAD LIMITS

10	100 lbs	50	500 lbs
25	250 lbs	75	750 lbs

NUT/SCREW CONFIGURATION

MODELS

SOLID NUT / PITCH (turn/in)	SERIES
SN01	TKS50
SN02	TKS10, 25
SN04	TKS75

BALL NUT / PITCH (turn/in)	SERIES
BN01	TKS75
BN02	TKS25, 50, 75
BN04	TKS75
BN05	TKS25, 50
BN08	TKS10

STROKE LENGTH

SK Stroke, then enter desired stroke length in decimal inches

MODEL	MAX STROKE* (in)
TKS10 Ball Nut	29
TKS10 Solid Nut	96
TKS25 Ball Nut	63
TKS25 Solid Nut	96
TKS50 Ball Nut	63
TKS50 Solid Nut	96
TKS75 Ball/Solid Nut	96

*Actuator cover has maximum stroke of 48 inches

! *Not all codes listed are compatible with all options.*

Use Tolomatic Sizing Software to determine available options and accessories based on your application requirements.

MOTOR MOUNTING / REDUCTIONS

! *The length on the leadscrew and coupling device is determined by motor selection. Motor type and frame size must be specified when ordering.*

(must choose one)

- LMI** In-Line mount
- LMB** In-Line mount with brake
- LMG** In-Line mount with gearhead
- RPL1** 1:1 Reverse-Parallel mount left
- RPR1** 1:1 Reverse-Parallel mount right
- RPB1** 1:1 Reverse-Parallel mount bottom
- RPT1** 1:1 Reverse-Parallel mount top
- RPL2** 2:1 Reverse-Parallel mount left
- RPR2** 2:1 Reverse-Parallel mount right
- RPB2** 2:1 Reverse-Parallel mount bottom
- RPT2** 2:1 Reverse-Parallel mount top

! *When the LMB option is selected, the configurator picks the appropriate screw and hardware to accommodate the mounting of the brake based on motor selection. The brake option "BRK" must also be indicated in the configuration string.*

When the LMG option is selected, the configurator picks the appropriate screw and hardware to accommodate the mounting of the gearhead based on motor selection. A gearhead reduction must also be indicated in the configuration string. Please reference the motor ordering pages for available options.

AUXILIARY CARRIER

DC_ Auxiliary Carrier, then center-to-center spacing desired in decimal inches. (Center-to-Center spacing will add to overall dead length and will not subtract from the stroke length)

SWITCHES

- RT_** Reed Switch (Form A) with 5-meter lead, and quantity desired
- BT_** Reed Switch (Form C) with 5-meter lead, and quantity desired
- KT_** Hall-effect Sinking Switch with 5-meter lead, and quantity desired
- TT_** Hall-effect Sourcing Switch with 5-meter lead, and quantity desired
- SP*_** Sensor Package

*Includes: Two Form C reed switches w/5-meter leads, mounted 1" from end-of-stroke and one Hall-effect sinking switch w/5-meter lead, mounted 2" from end-of-stroke on motor end.

BELLOWS

BE2 Bellows option (increases the dead length of the actuator, see pg. tk_12)

BRAKE OPTION

BRK In-line mounted brake***
***Used with the LMB in-line mounting option.

SPECIAL LUBRICATION

LU Low dust generating grease

MOUNTING PLATES

MP_ Mounting Plates plus quantity desired



! *NOTE: MRV motors are discontinued contact Tolomatic for equivalent replacement*

FIELD RETROFIT KITS

ITEM	TKS10	TKS25	TKS50	TKS75
Mounting Plates	0601-9803	0602-9803	0603-9803	0604-9803

TKS

TKS

Sold & Serviced By:

ELECTROMATE

Toll Free Phone (877) SERV098

Toll Free Fax (877) SERV099

www.electromate.com

sales@electromate.com

TKB Rodless Belt Drive Actuator

ORDERING

BASE MODEL SPECIFICATIONS

TKB 50 SK48 SDBR2

MODEL
TKB TruTrack Belt Drive Actuator

PAYLOAD LIMITS

10	100 lbs	50	500 lbs
25	250 lbs	75	750 lbs

STROKE LENGTH

SK Stroke, then enter desired stroke length in decimal inches

MODEL	MAX STROKE* (in)
TKB All Sizes	96

*Actuator cover has maximum stroke of 48 inches

MOTOR MOUNTING / REDUCTIONS
(must choose one)

DIRECT DRIVE

SDL Direct Drive - Left
SDR Direct Drive - Right

▲ A motor size and code must be selected when specifying a 1:1 or 2:1 reduction.

REDUCTION DRIVE

SDTL1 1:1 Reduction Drive / Top Left
SDTR1 1:1 Reduction Drive / Top Right
SDBL1 1:1 Reduction Drive / Bottom Left
SDBR1 1:1 Reduction Drive / Bottom Right
SDTL2 2:1 Reduction Drive / Top Left
SDTR2 2:1 Reduction Drive / Top Right
SDBL2 2:1 Reduction Drive / Bottom Left
SDBR2 2:1 Reduction Drive / Bottom Right

OPTIONS SPECIFICATIONS

DC18 KT2 BE2 LU MP4

AUXILIARY CARRIER

DC_ Auxiliary Carrier, then center-to-center spacing desired in decimal inches. (Center-to-Center spacing will add to overall dead length and will not subtract from the stroke length)

SWITCHES

RT_ Reed Switch (Form A) with 5-meter lead, and quantity desired
BT_ Reed Switch (Form C) with 5-meter lead, and quantity desired
KT_ Hall-effect Sinking Switch with 5-meter lead, and quantity desired
TT_ Hall-effect Sourcing Switch with 5-meter lead, and quantity desired
SP*_ Sensor Package

*Includes: Two Form C reed switches w/5-meter leads, mounted 1" from end-of-stroke and one Hall-effect sinking switch w/5-meter lead, mounted 2" from end-of-stroke on motor end.

BELLOWS

BE2 Bellows option (increases the dead length of the actuator, see pg. TKB_8)

SPECIAL LUBRICATION

LU Low dust generating grease

MOUNTING PLATES

MP_ Mounting Plates plus quantity desired

NOTE: MRV motors are discontinued contact Tolomatic for equivalent replacement

TKS

TKB

FIELD RETROFIT KITS				
ITEM	TKB10	TKB25	TKB50	TKB75
Mounting Plates	0601-9803	0602-9803	0603-9803	0604-9803

Sold & Serviced By:

ELECTROMATE

Toll Free Phone (877) SERV098

Toll Free Fax (877) SERV099

www.electromate.com

sales@electromate.com