

MXE SCREW DRIVE ACTUATORS

ENDURANCE TECHNOLOGYSM

S SOLID BEARING

P PROFILED RAIL



LINEAR SOLUTIONS MADE EASY

THE MXE ELECTRIC ACTUATOR – DESIGNED TO OUTLAST EVERY RODLESS ACTUATOR ON THE MARKET

The MXE electric actuator is exactly what you expect from the industry's number one rodless supplier. Designed with our exclusive **ENDURANCE TECHNOLOGY** features, the MX delivers superior performance to meet the most demanding applications. Nobody knows rodless like Tolomatic, and the MX proves it.

- **DURABLE BEARINGS.** Two bearing choices to match your application needs. Solid bearing design optimizes stress distribution for optimal performance. Profiled rail design uses recirculating ball technology to reduce friction and extend actuator life.
- **DURABLE BANDS.** Stainless steel bands are stronger and will not elongate like elastomer (non-metallic) bands, providing a reliable seal over the life of the actuator.



S-SOLID BEARING

- Large bearing surface contact area optimizes stress distribution on bearing for long service life
- Large carrier mounting pattern for more load stability and compatibility with existing BCS applications
- Engineered bearing material does not require additional lubrication
- Solid bearings are field replaceable

P-PROFILED RAIL

- Recirculating ball bearings with reduced friction for reliable service life
- High load and bending moment capacities
- Low profile to fit your application
- High precision bearings feature smooth, low breakaway motion

Our broad line of MX products includes electric actuators (belt-drive & screw-drive) and pneumatic rodless cylinders.

World class product performance, fifteen days built-to-order and legendary customer service . . . what you expect from the leader . . . Tolomatic!



SELECT THE PERFORMANCE YOU NEED

Choose from: • Two Bearing Models • Six Actuator Sizes • Built to Your Specified Stroke Length

MOMENT & LOAD CAPACITY COMPARISON

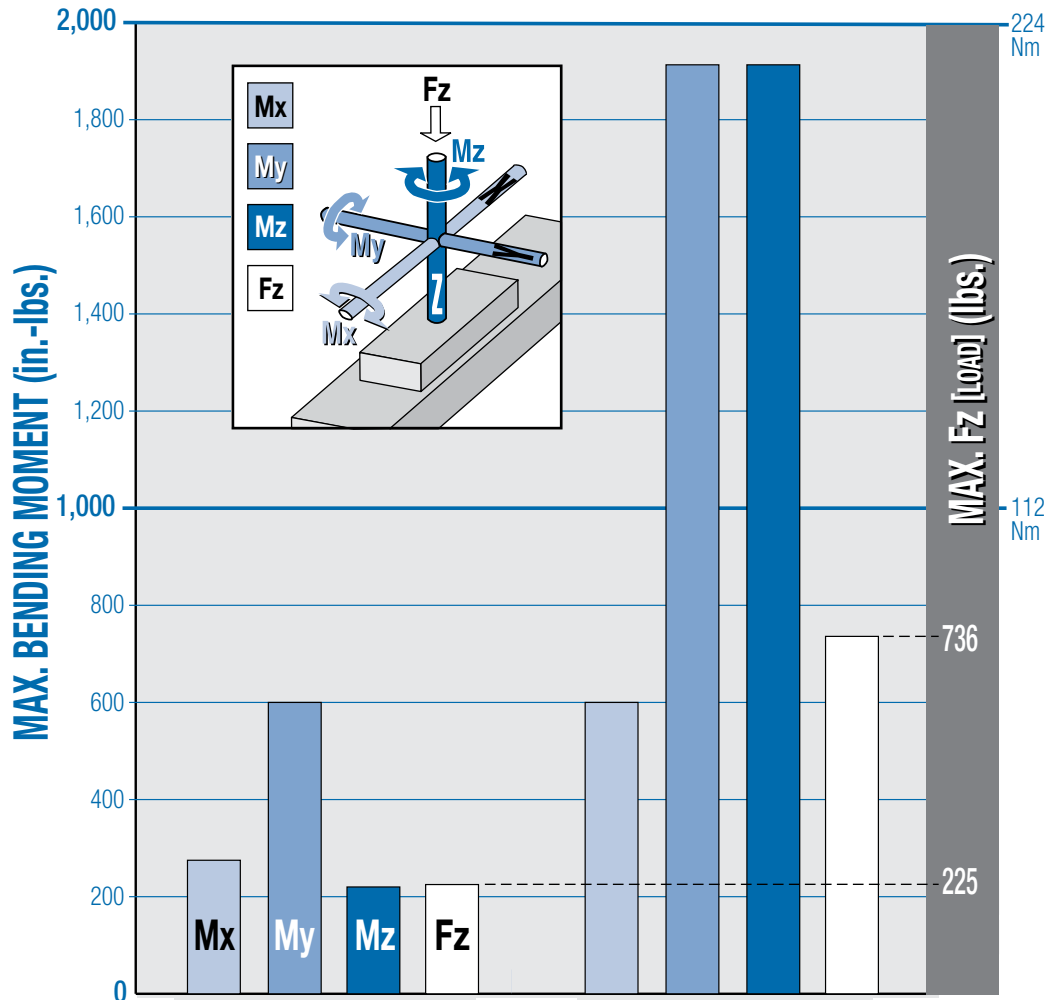
Graph for model comparison, data from MXE40 actuator



	S	P
Tolomatic MX Electric Actuator Model		
Bearing Type	Solid Bearing	Profiled Rail
Moment Capacity	Moderate + Mx Capacity	High
Ideal Applications	<ul style="list-style-type: none"> • Side Loads • Moderate or Light Loads • Guided Loads 	<ul style="list-style-type: none"> • High Moment Loads • High Speeds with Heavy Loads • High Precision
Product Features	Page MXE_4	Page MXE_6

Introduction2

Comparison.....3

S Solid Bearing Features.....4

P Profiled Rail Features.....6

S Moment and Load Capacity8

P Moment and Load Capacity10

Specifications13

Tube Clamp Requirements16

Screw Critical Speed Capacities.....17

S Solid Bearing Dimensions.....27

P Profiled Rail Bearing Dimensions29

Inline Motor Mounting Dimensions.....31

S Reverse Parallel Motor Mounting Dimensions.....35

P Reverse Parallel Motor Mounting Dimensions.....40

Switches45

Application Data Worksheet47

Selection Guidelines48

S Adjustment Procedures49

Service Parts50

Ordering51

MXE-S SOLID BEARING SCREW ACTUATOR

ENDURANCE TECHNOLOGYSM

Endurance Technology features are designed for maximum durability to provide extended service life.

The MXE-S rodless electric screw-drive actuator is designed for applications requiring moderate load carrying and guidance. The MXE-S actuator utilizes two field replaceable solid bearings that optimize stress distribution for optimal performance. Built-to-order in stroke lengths up to 178 inches.

LIGHTWEIGHT ALUMINUM DESIGN

• Clear anodized extrusion design is optimized for rigidity and strength

STAINLESS STEEL BAND

• Exterior dust band made of fatigue resistant, durable, flexible and corrosion resistant stainless steel

RETAINED DUST BAND

• Retained dust band keeps contaminants from entering the actuator interior, protecting components for reduced maintenance and increased uptime

LARGE FLEXIBLE MOUNTING PATTERN

- Carrier gives more load stability
- Compatibility with existing BCS applications
- More fastening options

DUST WIPER

• Formed end cap and side dust wipers keep contaminants from entering the actuator's internal area

MULTIPLE SCREW TECHNOLOGIES YOU CAN CHOOSE:

- Solid nuts of engineered resins for quiet performance at the lowest cost - 5 choices
- Ball nuts offer positioning accuracy and repeatability with longer life, low-backlash available - 3 choices



NON-WEAR BAND RETENTION

• Magnetically retained band is not subject to wear as are mechanically retained systems

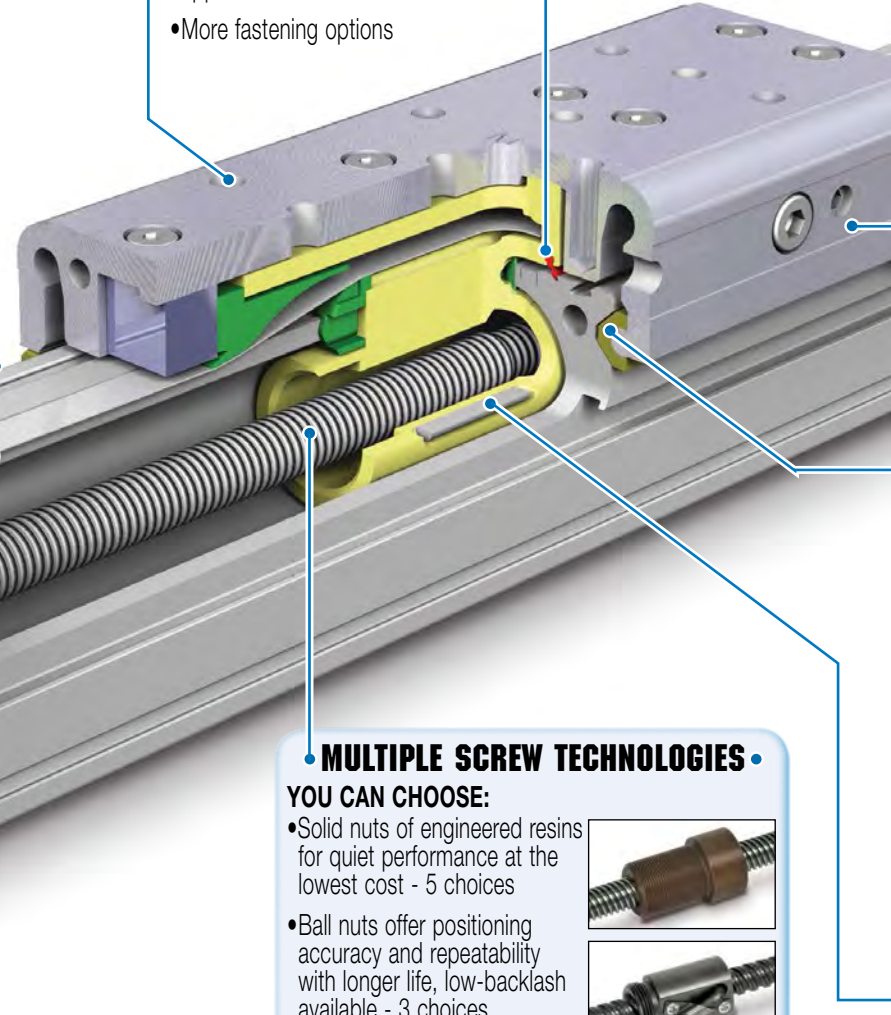
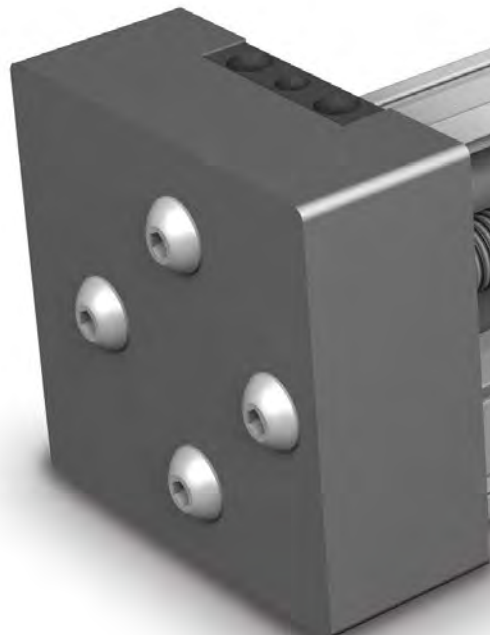

• INCH OR METRIC MOUNTING •

- Your choice of inch (US standard) or metric mounting to the carrier

• YOUR MOTOR HERE •

YOU CAN CHOOSE:

- Motor or gearbox supplied and installed by Tolomatic
- Specify the device to be installed and actuator ships with proper mounting hardware - MXE is a "Your Motor Here" actuator for easy in-line motor installation. Check our website (www.tolomatic.com/ymh) for complete YMH information
- Specify and ship your device to Tolomatic for factory installation

• MOTOR ORIENTATION •

YOU CAN CHOOSE:

- In-line option directly couples the driving shaft and is a one-piece housing construction for optimum alignment and support of the motor
- Reverse-parallel option minimizes the overall length and offers a 1:1 or 2:1 belt ratio

• NON-BINDING BEARING ARMS •

- Bearings are tensioned indirectly, providing bind free adjustment

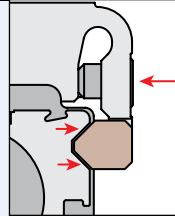

NOTE: Boxed letters indicate ordering codes

• TRAPEZOIDAL BEARINGS •

- Trapezoidal design maximizes bearing surface area for less pressure on bearing surfaces; less pressure results in less wear
- Engineered bearing material has low static and dynamic friction with low wear properties for long lasting, smooth operation
- Bearings are field replaceable for extended service life

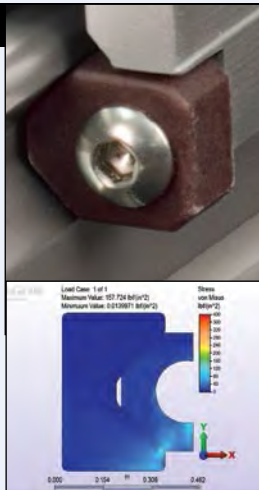

• INTERNAL MAGNETS •

- Standard feature that allows sensor installation on the open side or bottom of the extrusion

OPTIONS



AUXILIARY CARRIER DC

- 2X higher Fz (load) capacity
- High bending moment capacity



FLOATING MOUNT FL

- Compensates for non-parallelism between MX actuator and externally guided load



TUBE CLAMPS TC

- Used for intermediate support
- Flush with bottom of actuator to retain low profile
- Drop-in, adjustable mounting locations (MXE16 uses T-nuts with mounting plates)



MOUNTING PLATES MP

- To provide clearance for motor and mount
- Use in conjunction with tube clamps



SWITCHES

- Wide variety of sensing choices: Reed, Solid State PNP or NPN, all available normally open or normally closed
- Flush mount, drop-in installation
- Bright LEDs, power & signal indication
- CE rated, RoHS compliant

MXE-P PROFILED RAIL SCREW ACTUATOR

ENDURANCE TECHNOLOGYSM

Endurance Technology features are designed for maximum durability to provide extended service life.

The MXE-P rodless electric screw-drive actuator is designed for applications requiring moderate to heavy load carrying and guidance. The MXE-P actuator features a profiled rail system with recirculating ball linear guides for optimal performance. Built-to-order in stroke lengths up to 178 inches.

DUST WIPER

- Formed end cap and side dust wipers keep contaminants from entering the actuator's internal area

INTERNAL MAGNETS

- Standard feature that allows sensor installation on the open side or bottom of the extrusion

STAINLESS STEEL BAND

- Exterior dust band made of fatigue resistant, durable, flexible and corrosion resistant stainless steel

RECIRCULATING BALL BEARINGS

- Recirculating ball bearings are used to reduce friction and extend actuator life
- Designed with a grease pocket between ball elements to reduce friction, noise and maintenance
- Large permissible moment loads
- High speed operation, low heat generation
- High precision, smooth, low friction motion

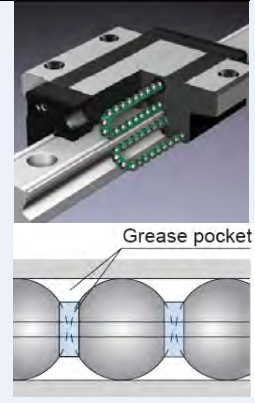

LIGHTWEIGHT ALUMINUM DESIGN

- Clear anodized extrusion design is optimized for rigidity and strength

INCH OR METRIC MOUNTING

- Your choice of inch (US standard) or metric mounting to the carrier

• LOW CARRIER HEIGHT •

- Reduces overall actuator envelope
- Large mounting pattern for excellent load stability

• YOUR MOTOR HERE •

YOU CAN CHOOSE:

- Motor or gearbox supplied and installed by Tolomatic
- Specify the device to be installed and actuator ships with proper mounting hardware - MXE is a "Your Motor Here" actuator for easy in-line motor installation. Check our website (www.tolomatic.com/y mh) for complete information
- Specify and ship your device to Tolomatic for factory installation

• MOTOR ORIENTATION •

YOU CAN CHOOSE:

- In-line option directly couples the driving shaft and is a one-piece housing construction for optimum alignment and support of the motor
- Reverse-parallel option minimizes the overall length and offers a 1:1 or 2:1 belt ratio

• NON-WEAR BAND RETENTION •

- Magnetically retained band is not subject to wear as are mechanically retained systems
- Immediate band engagement and release results in less drag on carrier for lower friction force during initial carrier movement

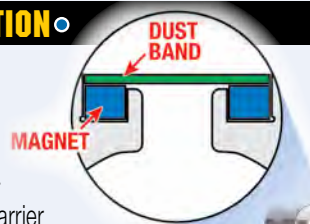

• RETAINED DUST BAND •

- Retained dust band keeps contaminants from entering the actuator interior, protecting components for reduced maintenance and increased uptime

NOTE: Boxed letters indicate ordering codes

• MULTIPLE SCREW TECHNOLOGIES •

YOU CAN CHOOSE:

- Solid nuts of engineered resins offer quiet performance at the lowest cost - 5 choices
- Ball nuts offer positioning accuracy and repeatability with longer life, low-backlash available - 3 choices



OPTIONS



AUXILIARY CARRIER DC

- 2X higher Fz (load) capacity
- High bending moment capacity



TUBE CLAMPS TC

- Used for intermediate support
- Flush with bottom of actuator to retain low profile
- Drop-in, adjustable mounting locations (MXE16 uses T-nuts with Mounting Plates)



MOUNTING PLATES MP

- To provide clearance for motor and mount
- Use in conjunction with tube clamps

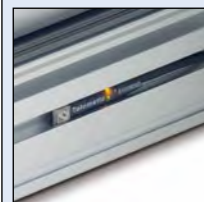

SWITCHES

- Wide variety of sensing choices: Reed, Solid State PNP or NPN, all available normally open or normally closed
- Flush mount, drop-in installation
- Bright LEDs, power & signal indication
- CE rated, RoHS compliant

S SOLID BEARING MOMENT AND LOAD CAPACITY

STANDARD CARRIER

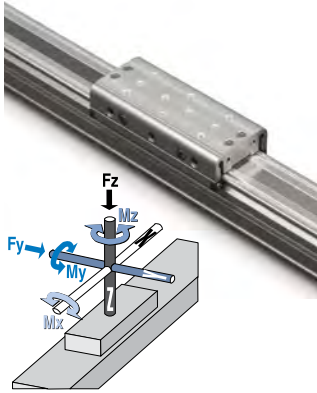

SIZE	MAXIMUM BENDING MOMENTS						MAX. LOAD	
	Mx		My		Mz		Fz	
	in-lbs	N-m	in-lbs	N-m	in-lbs	N-m	lbf	N
16	22	2.5	19	2.1	25	2.8	35	156
25	60	6.8	110	12.4	34	3.8	70	311
32	100	11.3	350	39.5	140	15.8	150	667
40	275	31.1	600	67.8	220	24.9	225	1,001
50	315	35.6	1,155	131	341	38.5	315	1,401
63	585	66.1	2,340	264	520	58.8	520	2,313



Use sizing software or call Tolomatic (1-800-328-2174) with application information. We will provide any assistance needed to determine the proper MXE screw-driven actuator.

⚠ The above ratings are the maximum values for shock-free, vibration-free operation in a typical industrial environment, which must not be exceeded even in dynamic operation. Contact Tolomatic for assistance in selecting the most appropriate actuator for your application.

The moment and load capacity of the actuator's bearing system is based on an L10 life of 200,000,000 linear inches of travel. Life of the actuator will vary for each application depending on the combined loads, motion parameters and operating conditions. The load factor (L_f) for each application must not exceed a value of 1 (as calculated below). Exceeding a load factor of 1 will diminish the actuator's rated life.

$$L_f = \frac{M_x}{M_{x_{max}}} + \frac{M_y}{M_{y_{max}}} + \frac{M_z}{M_{z_{max}}} + \frac{F_y}{F_{y_{max}}} + \frac{F_z}{F_{z_{max}}} \leq 1$$

With combined loads, L_f must not exceed the value 1.

S SOLID BEARING MOMENT AND LOAD CAPACITY

DC AUXILIARY CARRIER

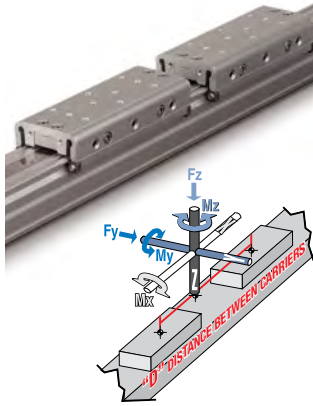

SIZE	"D" MINIMUM		MAXIMUM BENDING MOMENTS*						MAX. LOAD	
			M _x		M _y		M _z		F _z	
	in	mm	in-lbs	N-m	in-lbs	N-m	in-lbs	N-m	lbf	N
16	5.0	127	44	5.0	175	19.8	175	19.8	70	311
25	6.0	152	120	13.6	420	47.5	420	47.5	140	623
32	7.0	178	200	22.6	1,050	119	1,050	119	300	1,334
40	8.5	216	550	62.1	1,913	216	1,913	216	450	2,002
50	8.6	218	630	71.2	2,709	306	2,709	306	630	2,802
63	13.0	330	1,170	132	6,760	764	6,760	764	1,040	4,626

*At minimum "D" distance see graph below for complete information

AUXILIARY CARRIER BENDING MOMENTS WITH INCREASED "D" DISTANCE BETWEEN CARRIERS

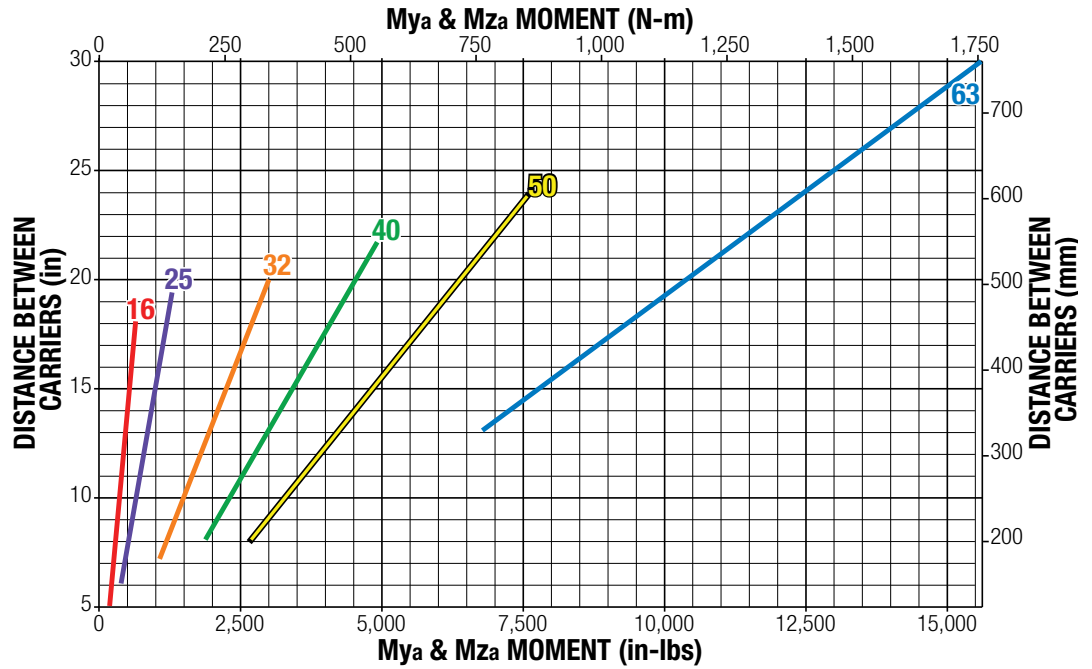

Ratings were calculated with the following conditions:

- 1.) Coupling between carriers is rigid.
- 2.) Load is equally distributed between carriers.
- 3.) Coupling device applies no misalignment loads to carriers.

⚠ The above ratings are the maximum values for shock-free, vibration-free operation in a typical industrial environment, which must not be exceeded even in dynamic operation. Contact Tolomatic for assistance in selecting the most appropriate actuator for your application.

With combined loads, L_f must not exceed the value 1.

$$L_f = \frac{M_x}{M_{x_{max}}} + \frac{M_y}{M_{y_{max}}} + \frac{M_z}{M_{z_{max}}} + \frac{F_y}{F_{y_{max}}} + \frac{F_z}{F_{z_{max}}} \leq 1$$

P PROFILED RAIL MOMENT AND LOAD CAPACITY

⚠ Mating surface of mounted component must maintain a flatness of at least .0015" [0.040 mm]

STANDARD CARRIER

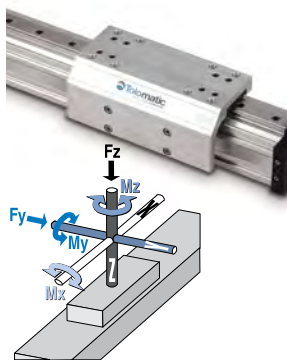

SIZE	MAXIMUM BENDING MOMENTS						MAXIMUM LOAD			
	Mx		My		Mz		Fy		Fz	
	in-lbs	N-m	in-lbs	N-m	in-lbs	N-m	lbf	N	lbf	N
16	39	4.5	339	38.3	339	38.3	217	966	217	966
25	126	14.3	502	56.7	377	42.6	449	1,996	449	1,996
32	226	25.6	1,344	152	1,344	152	569	2,531	569	2,531
40	604	68.2	1,913	216	1,913	216	736	3,274	736	3,274
50	811	91.7	3,483	394	3,483	394	1,014	4,510	1,014	4,510
63	1,019	115	5,339	603	5,339	603	1,292	5,745	1,292	5,745



Use sizing software or call Tolomatic (1-800-328-2174) with application information. We will provide any assistance needed to determine the proper MXE screw-driven actuator.

⚠ **The above ratings are the maximum values for shock-free, vibration-free operation in a typical industrial environment, which must not be exceeded even in dynamic operation. Contact Tolomatic for assistance in selecting the most appropriate actuator for your application.**

SPEED FACTOR

FOR APPLICATIONS WITH HIGH SPEED OR SIGNIFICANT SHOCK AND VIBRATION: Calculated values of loads and bending moments must be increased by speed factor from the graph at right to obtain full rated life of profiled rail bearing system.

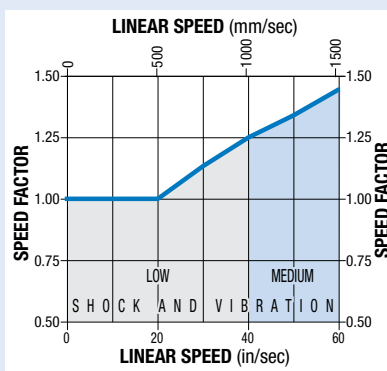

The moment and load capacity of the actuator's bearing system is based on an L10 life of 200,000,000 linear inches of travel. Life of the actuator will vary for each application depending on the combined loads, motion parameters and operating conditions. The load factor (L_f) for each application must not exceed a value of 1 (as calculated below). Exceeding a load factor of 1 will diminish the actuator's rated life.

$$L_f = \frac{M_x}{M_{x_{max}}} + \frac{M_y}{M_{y_{max}}} + \frac{M_z}{M_{z_{max}}} + \frac{F_y}{F_{y_{max}}} + \frac{F_z}{F_{z_{max}}} \leq 1$$

With combined loads, L_f must not exceed the value 1.

PROFILED RAIL LUBRICATION

Proper lubrication of profiled rail bearing system is essential for normal operation and achievement of full rated life of MXE-P actuators. Lubrication should be performed at intervals of 4,000,000 inches of travel or once every year, whichever occurs first. **However, operating conditions such as high speed or significant shock and vibration may require more frequent lubrication.** Please consult Tolomatic for recommendations.

Recommended grease types:

1. Refined mineral oil-based multi-purpose grease with lithium thickening agent.
2. High-grade synthetic oil-based grease with urea thickening agent.

PROFILED RAIL MOMENT AND LOAD CAPACITY

⚠ Mating surface of mounted component must maintain a flatness of at least .0015" [0.040mm]

AUXILIARY CARRIER

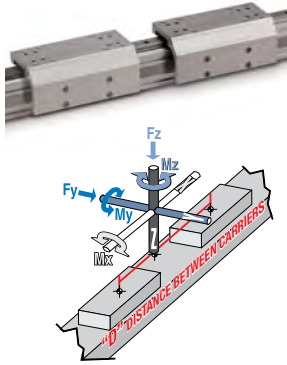

SIZE	"D" MINIMUM		MAXIMUM BENDING MOMENTS*						MAXIMUM LOAD			
			Mxa		Mya		Mza		Fya		Fza	
	in	mm	in-lbs	N-m	in-lbs	N-m	in-lbs	N-m	lbf	N	lbf	N
16	5.0	127	79	8.9	620	70.0	620	70.0	434	1,932	434	1,932
25	6.0	152	252	28.5	1,610	182	1,610	182	898	3,993	898	3,993
32	7.0	178	453	51.1	2,202	249	2,202	249	1,138	5,063	1,138	5,063
40	8.5	216	1,208	136	3,601	407	3,601	407	1,472	6,549	1,472	6,549
50	8.6	218	1,623	183	4,966	561	4,966	561	2,028	9,020	2,028	9,020
63	13.0	330	2,038	230	9,508	1,074	9,508	1,074	2,583	11,490	2,583	11,490

*At minimum "D" distance see below for complete information

AUXILIARY CARRIER BENDING MOMENTS WITH INCREASED "D" DISTANCE BETWEEN CARRIERS

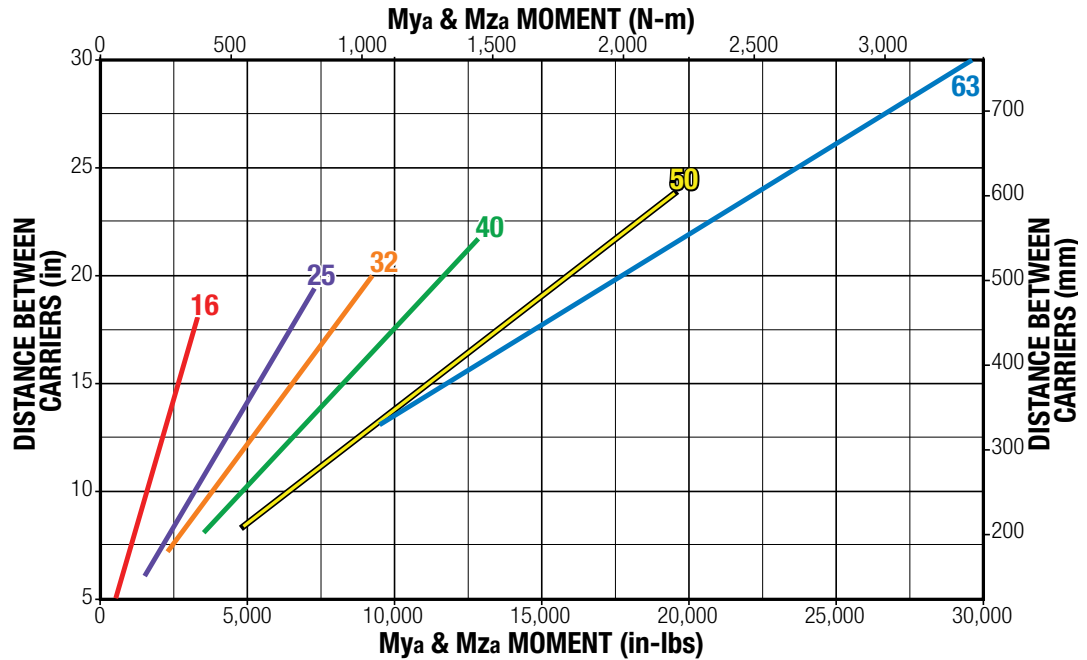

Ratings were calculated with the following conditions:

- 1.) Coupling between carriers is rigid.
- 2.) Load is equally distributed between carriers.
- 3.) Coupling device applies no misalignment loads to carriers.

⚠ *The above ratings are the maximum values for shock-free, vibration-free operation in a typical industrial environment, which must not be exceeded even in dynamic operation. Contact Tolomatic for assistance in selecting the most appropriate actuator for your application.*

With combined loads, L_f must not exceed the value 1.

$$L_f = \frac{M_x}{M_{x_{max}}} + \frac{M_y}{M_{y_{max}}} + \frac{M_z}{M_{z_{max}}} + \frac{F_y}{F_{y_{max}}} + \frac{F_z}{F_{z_{max}}} \leq 1$$

LOAD DEFLECTION

DEFLECTION ABOUT X AXIS

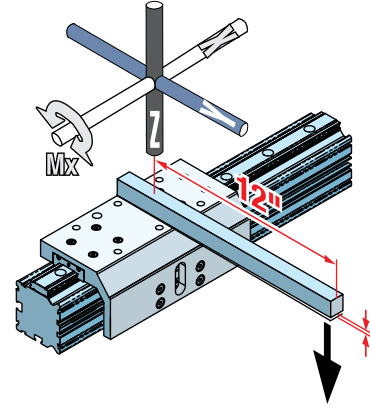
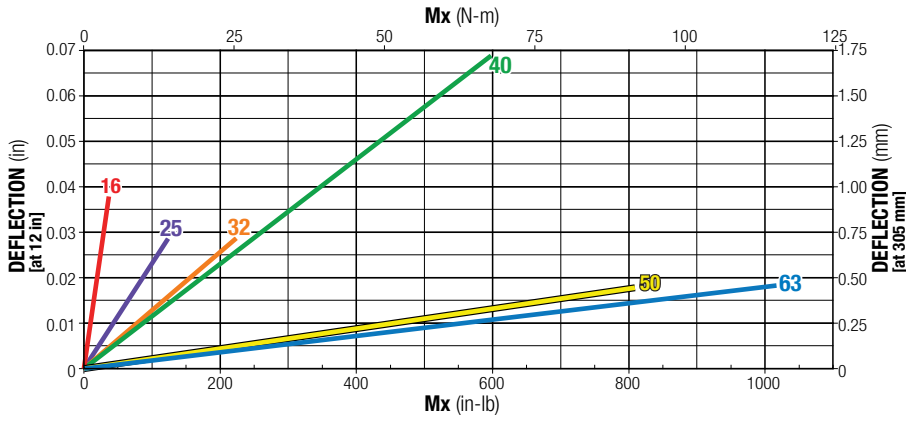

DEFLECTION ABOUT Y AXIS

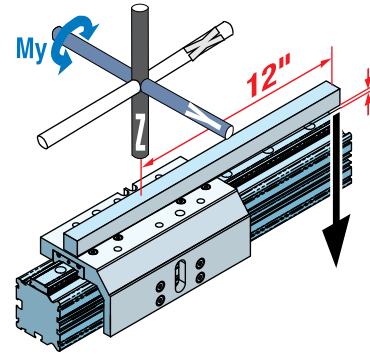
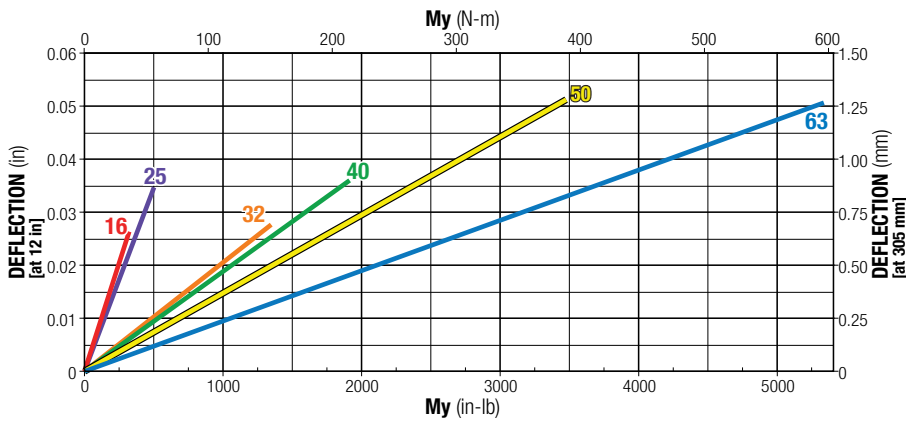

DEFLECTION ABOUT Z AXIS

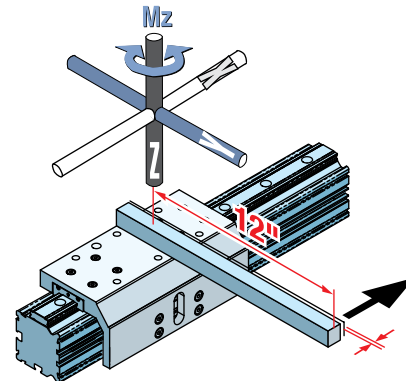
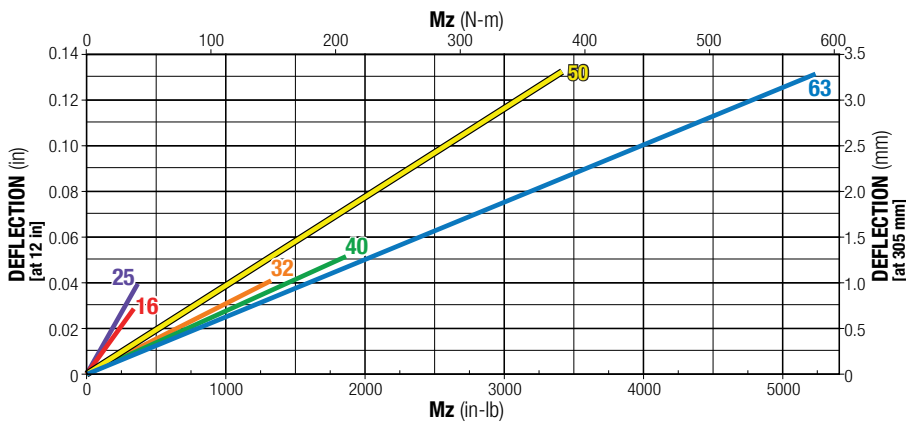

DEFLECTION TESTING WAS DONE UNDER THESE CRITERIA:

- 1.) Actuator was properly mounted with distance between mounting plates within recommendations (see Tube Clamp Requirements page MXE_16)
- 2.) Deflection was measured at 12" from center of carrier as shown

S & P ACTUATOR SPECIFICATIONS AND BREAKAWAY TORQUE

GENERAL ACTUATOR SPECIFICATIONS

ACTUATOR SERIES	CARRIER WEIGHT (including nut bracket assembly)				BASE ACTUATOR WEIGHT (excluding nut bracket and carrier assembly)				WEIGHT PER UNIT OF STROKE				STRAIGHTNESS / FLATNESS*		TEMPERATURE RANGE	
	S SOLID		P PROFILED		S SOLID		P PROFILED		S SOLID		P PROFILED		in	mm	°F	°C
	lb	kg	lb	kg	lb	kg	lb	kg	lb/in	kg/mm	lb/in	kg/mm				
MXE16	0.47	0.21	0.58	0.26	1.24	0.56	1.43	0.65	0.10	0.0018	0.12	0.0021	.00067 x L [†]	.0170 x L [†]	40 to 130	4 to 54
MXE25	0.91	0.41	1.02	0.46	2.11	0.96	2.44	1.11	0.19	0.0034	0.25	0.0045				
MXE32	1.74	0.79	2.12	0.96	2.74	1.24	3.30	1.50	0.29	0.0052	0.37	0.0066				
MXE40	3.15	1.43	3.72	1.69	5.34	2.42	6.88	3.12	0.40	0.0071	0.58	0.0104				
MXE50	5.27	2.39	6.97	3.16	14.91	6.76	18.27	8.29	0.64	0.0114	0.84	0.0150				
MXE63	12.96	5.88	14.92	6.77	35.05	15.90	39.34	17.84	1.08	0.0193	1.36	0.0243				

IP Rating - 44 Approximately equivalent to the requirements of IP44 (protected against ingress of solid particles greater than .039 in (1 mm) and splashing water)

*Actuator mounted on a flat surface and fully restrained (See tube clamp graphs page MXE 16)

† L = Maximum distance between tube clamps

FRICITION FORCE S-ACTUATORS

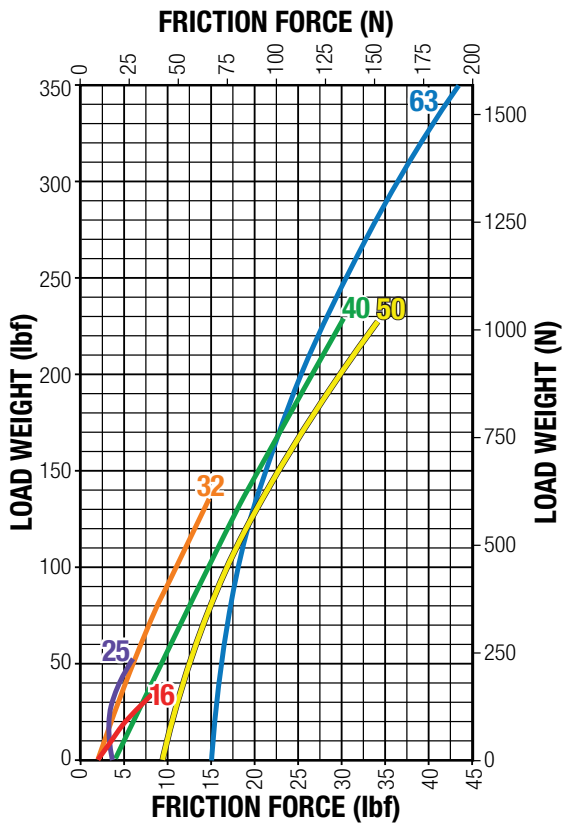

BREAKAWAY TORQUE

ACTUATOR SERIES	SCREW DIAMETER		SCREW TYPE	SCREW PITCH	BREAKAWAY TORQUE			
	in	mm			rev/in	SINGLE CARRIER		AUXILIARY CARRIER
					oz-in	N-m	oz-in	N-m
MXE16	0.250	6.35	SN	02	10	0.071	14	0.099
	0.250	6.35	SN	04	10	0.071	14	0.099
	0.250	6.35	SN	16	10	0.071	14	0.099
MXE25	0.375	9.53	BN	08	16	0.113	18	0.127
	0.375	9.53	BNL	08	16	0.113	18	0.127
	0.500	12.70	SN	01	30	0.212	46	0.325
	0.500	12.70	SN	02	25	0.177	35	0.247
MXE32	0.500	12.70	SN	05	18	0.127	22	0.155
	0.375	9.53	BN	08	16	0.113	18	0.127
	0.375	9.53	BNL	08	16	0.113	18	0.127
	0.500	12.70	SN	01	30	0.212	46	0.325
MXE40	0.500	12.70	SN	02	25	0.177	35	0.247
	0.500	12.70	SN	05	18	0.127	22	0.155
	0.500	12.70	BN	02	28	0.198	35	0.247
	0.500	12.70	BNL	02	28	0.198	35	0.247
MXE50	0.625	15.88	BN	05	35	0.247	45	0.318
	0.625	15.88	BNL	05	35	0.247	45	0.318
	0.625	15.88	SN	02	35	0.245	44	0.311
	0.750	19.05	SN	01	50	0.353	72	0.508
	0.750	19.05	BN	02	40	0.282	50	0.353
	0.750	19.05	BNL	02	40	0.282	50	0.353
MXE63	0.750	19.05	BN	05	35	0.247	45	0.318
	0.750	19.05	BNL	05	35	0.247	45	0.318
	0.750	19.05	SN	01	50	0.353	72	0.508
	0.750	19.05	SN	02	35	0.247	44	0.311
	1.000	25.40	BN	01	75	0.530	107	0.756
	1.000	25.40	BNL	01	75	0.530	107	0.756
MXE63	1.000	25.40	BN	02	75	0.530	107	0.756
	1.000	25.40	BNL	02	75	0.530	107	0.756
	1.000	25.40	BN	04	85	0.600	121	0.855
	1.000	25.40	BNL	04	85	0.600	121	0.855
	1.000	25.40	SN	04	75	0.530	107	0.756
	1.000	25.40	SN	04	75	0.530	107	0.756

S & P SPECIFICATIONS

SCREW SPECIFICATIONS

ACTUATOR SERIES	SCREW DIAMETER		SCREW TYPE	SCREW PITCH	SCREW LEAD		LEAD ACCURACY		BACKLASH		MAX THRUST		MAX STROKE	
	in	mm			rev/in	in	mm	in/ft	mm/300mm	in	mm	lb	N	in
MXE16	0.250	6.35	SN	02	0.50	12.70	0.005	0.13	0.015	0.38	45	200	31.0	787.4
	0.250	6.35	SN	04	0.25	6.35	0.005	0.13	0.015	0.38	45	200	31.0	787.4
	0.250	6.35	SN	16	0.06	1.59	0.005	0.13	0.015	0.38	45	200	31.0	787.4
MXE25	0.375	9.53	BN	08	0.13	3.18	0.004	0.10	0.015	0.38	130	578	62.3	1582.4
	0.375	9.53	BNL	08	0.13	3.18	0.004	0.10	0.002	0.05	130	578	62.3	1582.4
	0.500	12.70	SN	01	1.00	25.40	0.006	0.15	0.007	0.18	170	756	98.3	2496.8
	0.500	12.70	SN	02	0.50	12.70	0.005	0.13	0.007	0.18	170	756	134.3	3411.2
	0.500	12.70	SN	05	0.20	5.08	0.006	0.15	0.007	0.18	170	756	134.3	3411.2
MXE32	0.375	9.53	BN	08	0.13	3.18	0.004	0.10	0.015	0.38	130	578	61.9	1572.3
	0.375	9.53	BNL	08	0.13	3.18	0.004	0.10	0.002	0.05	130	578	61.9	1572.3
	0.500	12.70	SN	01	1.00	25.40	0.006	0.15	0.007	0.18	170	756	97.9	2486.7
	0.500	12.70	SN	02	0.50	12.70	0.005	0.13	0.007	0.18	170	756	133.9	3401.1
	0.500	12.70	SN	05	0.20	5.08	0.006	0.15	0.007	0.18	170	756	133.9	3401.1
MXE40	0.500	12.70	BN	02	0.50	12.70	0.003	0.08	0.015	0.38	800	3559	59.9	1521.5
	0.500	12.70	BNL	02	0.50	12.70	0.003	0.08	0.002	0.05	800	3559	59.9	1521.5
	0.625	15.88	BN	05	0.20	5.08	0.003	0.08	0.015	0.38	800	3559	59.9	1521.5
	0.625	15.88	BNL	05	0.20	5.08	0.003	0.08	0.002	0.05	800	3559	59.9	1521.5
	0.625	15.88	SN	02	0.50	12.70	0.005	0.13	0.007	0.18	200	890	131.9	3350.3
	0.750	19.05	SN	01	1.00	25.40	0.005	0.13	0.007	0.18	300	1334	131.9	3350.3
MXE50	0.750	19.05	BN	02	0.50	12.70	0.004	0.10	0.015	0.38	2700	12010	178.7	4539.0
	0.750	19.05	BNL	02	0.50	12.70	0.004	0.10	0.002	0.05	2700	12010	178.7	4539.0
	0.750	19.05	BN	05	0.20	5.08	0.003	0.08	0.015	0.38	950	4226	130.7	3319.8
	0.750	19.05	BNL	05	0.20	5.08	0.003	0.08	0.002	0.05	950	4226	130.7	3319.8
	0.750	19.05	SN	02	0.50	12.70	0.005	0.13	0.007	0.18	300	1335	130.7	3319.8
	0.750	19.05	SN	01	1.00	25.40	0.005	0.13	0.007	0.18	300	1335	130.7	3319.8
MXE63	1.000	25.40	BN	01	1.00	25.40	0.004	0.10	0.015	0.38	2500	11121	125.4	3185.2
	1.000	25.40	BNL	01	1.00	25.40	0.004	0.10	0.002	0.05	2500	11121	125.4	3185.2
	1.000	25.40	BN	02	0.50	12.70	0.004	0.10	0.015	0.38	4300	19127	125.4	3185.2
	1.000	25.40	BNL	02	0.50	12.70	0.004	0.10	0.002	0.05	4300	19127	125.4	3185.2
	1.000	25.40	BN	04	0.25	6.35	0.004	0.10	0.015	0.38	3300	14679	77.4	1966.0
	1.000	25.40	BNL	04	0.25	6.35	0.004	0.10	0.002	0.05	3300	14679	77.4	1966.0
	1.000	25.40	SN	04	0.25	6.35	0.010	0.25	0.007	0.18	400	1779	125.4	3185.2

S & P SPECIFICATIONS

REFLECTED INERTIA

ACTUATOR SERIES	SCREW DIAMETER		SCREW TYPE	SCREW PITCH	REFLECTED INERTIA									
					BASE ACTUATOR								PER IN OF STROKE	
					S SOLID				P PROFILED RAIL					
					IN-LINE		REV PARALLEL		IN-LINE		REV PARALLEL			
in	mm		rev/in	lb-in ²	kg-cm ²	lb-in ²	kg-cm ²	lb-in ²	kg-cm ²	lb-in ²	kg-cm ²	lb-in ²	kg-cm ²	
MXE16	0.250	6.35	SN	02	0.0058	0.0170	0.0058	0.0170	0.0069	0.0202	0.0069	0.0202	0.0001	0.0003
	0.250	6.35	SN	04	0.0020	0.0059	0.0020	0.0059	0.0023	0.0067	0.0023	0.0067	0.0001	0.0003
	0.250	6.35	SN	16	0.0009	0.0026	0.0009	0.0026	0.0009	0.0026	0.0009	0.0026	0.0001	0.0003
MXE25	0.375	9.53	BN	08	0.0062	0.0182	0.0062	0.0182	0.0063	0.0183	0.0063	0.0183	0.0005	0.0015
	0.375	9.53	BNL	08	0.0062	0.0182	0.0062	0.018	0.0063	0.0183	0.0063	0.0183	0.0005	0.0015
	0.500	12.70	SN	01	0.0498	0.1456	0.0498	0.1456	0.0541	0.1583	0.0541	0.1583	0.0017	0.0050
	0.500	12.70	SN	02	0.0213	0.0623	0.0213	0.0623	0.0224	0.0654	0.0224	0.0654	0.0017	0.0050
	0.500	12.70	SN	05	0.0133	0.0390	0.0133	0.0390	0.0135	0.0395	0.0135	0.0395	0.0017	0.0050
MXE32	0.375	9.53	BN	08	0.0066	0.0193	0.0066	0.0193	0.0068	0.0198	0.0068	0.0198	0.0005	0.0015
	0.375	9.53	BNL	08	0.0066	0.0193	0.0066	0.0193	0.0068	0.0198	0.0068	0.0198	0.0005	0.0015
	0.500	12.70	SN	01	0.0832	0.2436	0.0842	0.2465	0.1005	0.2940	0.1015	0.2969	0.0017	0.0050
	0.500	12.70	SN	02	0.0296	0.0868	0.0306	0.0897	0.0340	0.0994	0.0350	0.1023	0.0017	0.0050
	0.500	12.70	SN	05	0.0147	0.0429	0.0157	0.0458	0.0153	0.0449	0.0163	0.0478	0.0017	0.0050
MXE40	0.500	12.70	BN	02	0.0502	0.1468	0.0502	0.1470	0.0544	0.1593	0.0545	0.1594	0.0017	0.0050
	0.500	12.70	BNL	02	0.0502	0.1480	0.0512	0.1497	0.0544	0.1593	0.0545	0.1594	0.0017	0.0050
	0.625	15.88	BN	05	0.0506	0.1480	0.0512	0.1497	0.0512	0.1500	0.0518	0.1517	0.0042	0.0123
	0.625	15.88	BNL	05	0.0506	0.1480	0.0512	0.1497	0.0512	0.1500	0.0518	0.1517	0.0042	0.0123
	0.625	15.88	SN	02	0.0781	0.2286	0.0787	0.2304	0.0842	0.2463	0.0848	0.2480	0.0042	0.0123
	0.750	19.05	SN	01	0.2035	0.5956	0.2041	0.5973	0.2276	0.6661	0.2282	0.6679	0.0087	0.0255
MXE50	0.750	19.05	BN	02	0.1438	0.4208	0.1451	0.4246	0.1565	0.4580	0.1578	0.4618	0.0087	0.0255
	0.750	19.05	BNL	02	0.1438	0.4208	0.1451	0.4246	0.1565	0.4580	0.1578	0.4618	0.0087	0.0255
	0.750	19.05	BN	05	0.1104	0.3231	0.1117	0.3269	0.1124	0.3289	0.1137	0.3327	0.0087	0.0255
	0.750	19.05	BNL	05	0.1104	0.3231	0.1117	0.3269	0.1124	0.3289	0.1137	0.3327	0.0087	0.0255
	0.750	19.05	SN	02	0.1528	0.4472	0.1541	0.4510	0.1708	0.4998	0.1721	0.5036	0.0087	0.0255
	0.750	19.05	SN	01	0.2969	0.8689	0.2982	0.8727	0.3688	1.0793	0.3701	1.0831	0.0087	0.0255
MXE63	1.000	25.40	BN	01	0.8865	2.5943	0.8873	2.5966	0.9466	2.7688	0.9474	2.7711	0.0275	0.0805
	1.000	25.40	BNL	01	0.8865	2.5943	0.8873	2.5966	0.9466	2.7688	0.9474	2.7711	0.0275	0.0805
	1.000	25.40	BN	02	0.5966	1.7459	0.5974	1.7482	0.6116	1.7889	0.6124	1.7813	0.0275	0.0805
	1.000	25.40	BNL	02	0.5966	1.7459	0.5974	1.7482	0.6116	1.7889	0.6124	1.7813	0.0275	0.0805
	1.000	25.40	BN	04	0.5245	1.5349	0.5253	1.5372	0.5282	1.5450	0.5290	1.5473	0.0275	0.0805
	1.000	25.40	BNL	04	0.5245	1.5349	0.5253	1.5372	0.5282	1.5450	0.5290	1.5473	0.0275	0.0805
	1.000	25.40	SN	04	0.5319	1.5566	0.5327	1.5589	0.5372	1.5713	0.5380	1.5737	0.0275	0.0805

S & P TUBE CLAMP REQUIREMENTS

S SOLID BEARING

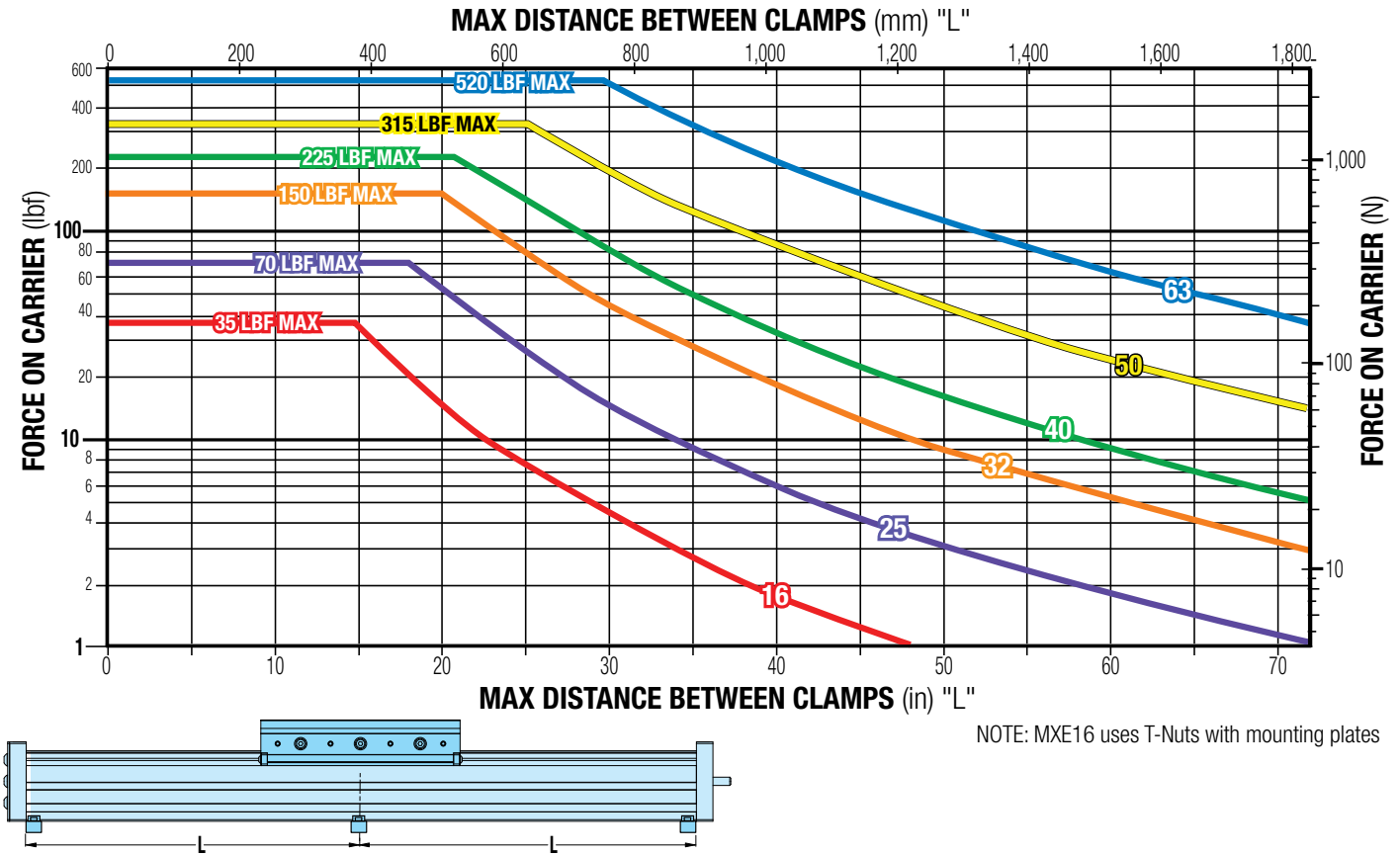

P PROFILED RAIL BEARING

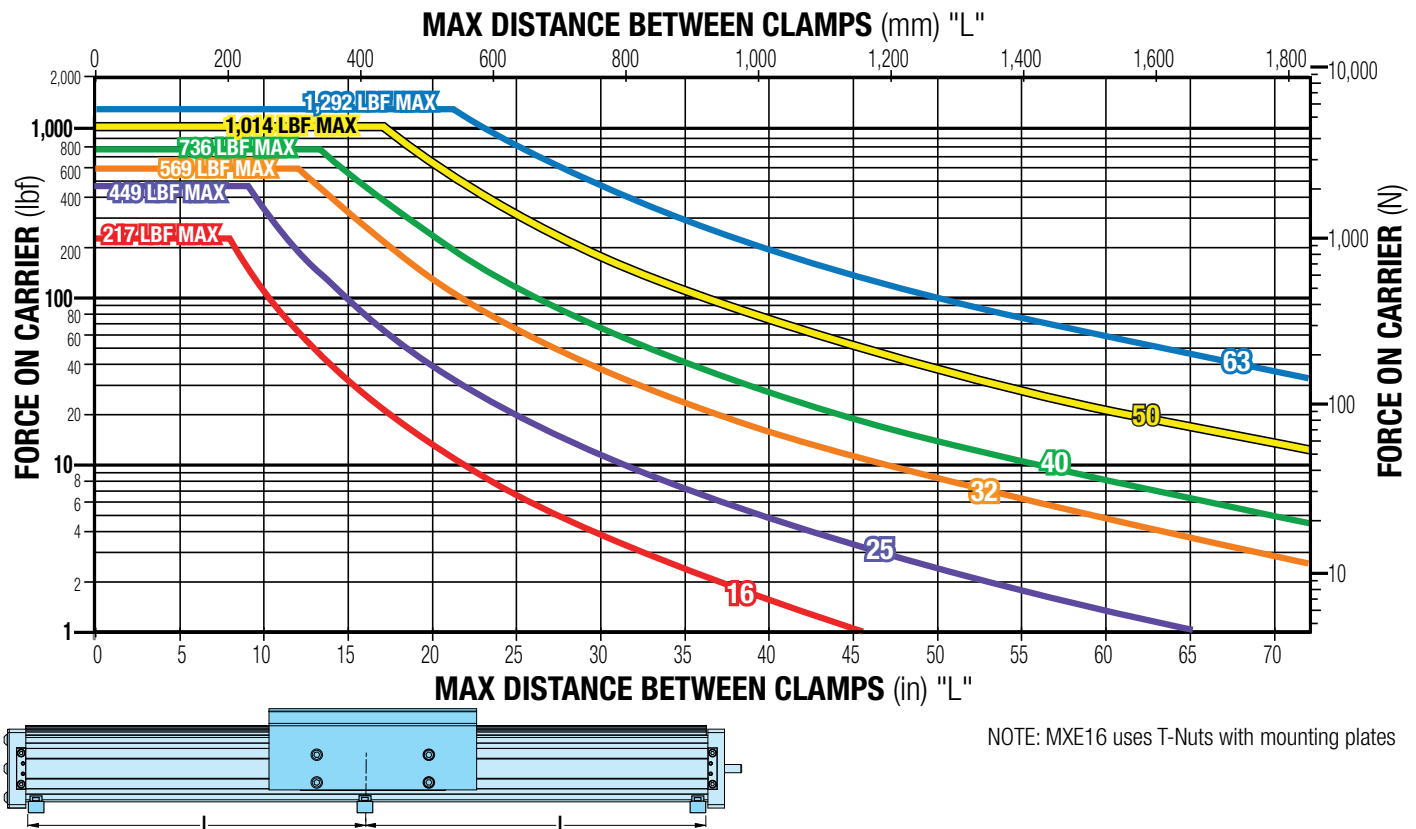

SCREW CRITICAL SPEED CAPACITIES

MXE ACME SCREW CRITICAL SPEED

MXE BALL SCREW CRITICAL SPEED

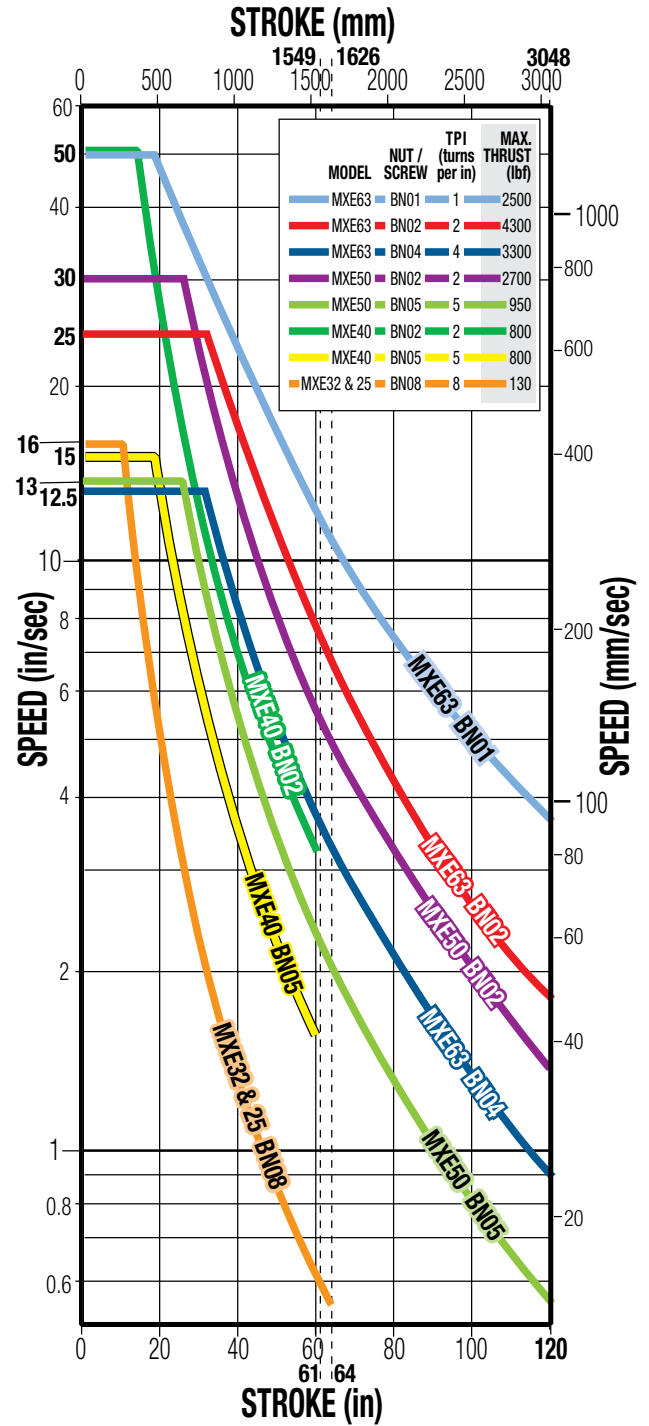
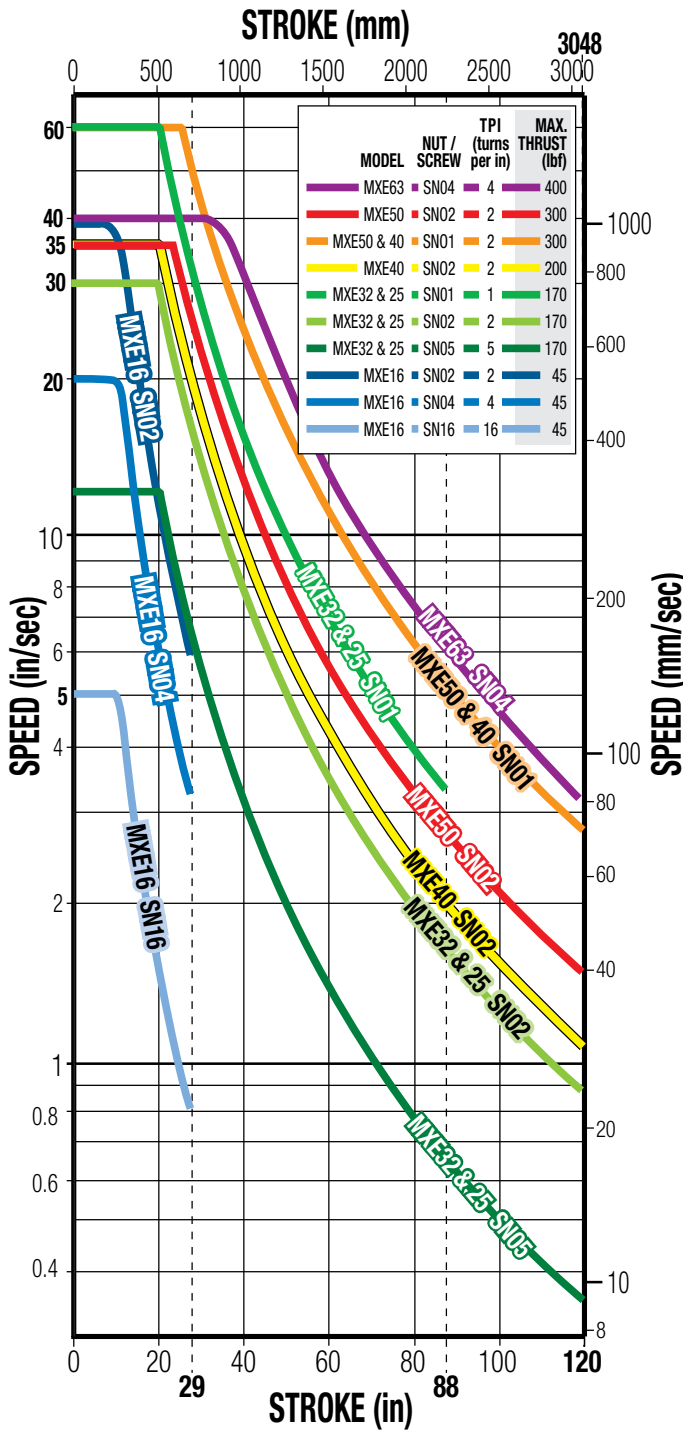

* Maximum thrust is the maximum continuous dynamic thrust subject to Thrust x Velocity limitation.

Dotted lines represent maximum stroke for screw selections.

For Screw PV limits, refer to the individual charts on the following pages for each actuator body size.

SCREW CODE DESCRIPTION

- SN** Solid Nut
- BN** Ball Nut
- BNL** Low Backlash Ball Nut

MXE16 ACME SCREW CRITICAL SPEED AND PV LIMITS

Critical Speed: 0.250" ACME

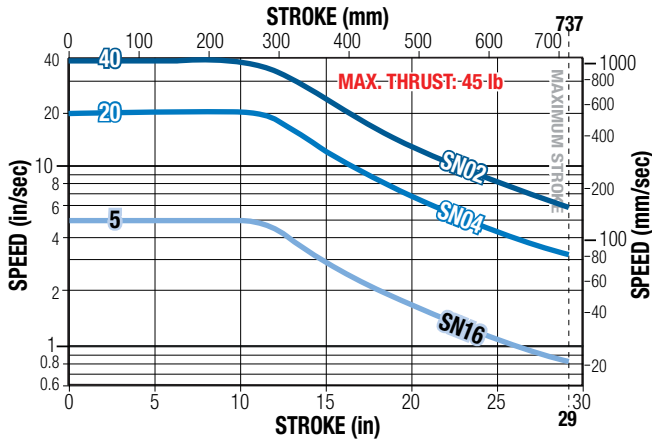

PV Limits: 2TPI Acme Screw

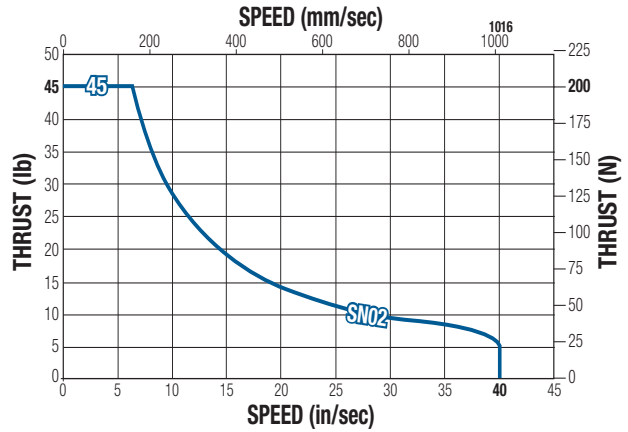

PV Limits: 4TPI Acme Screw

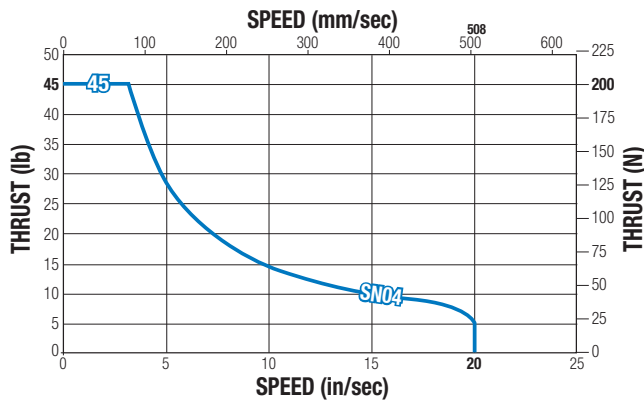

PV Limits: 16TPI Acme Screw

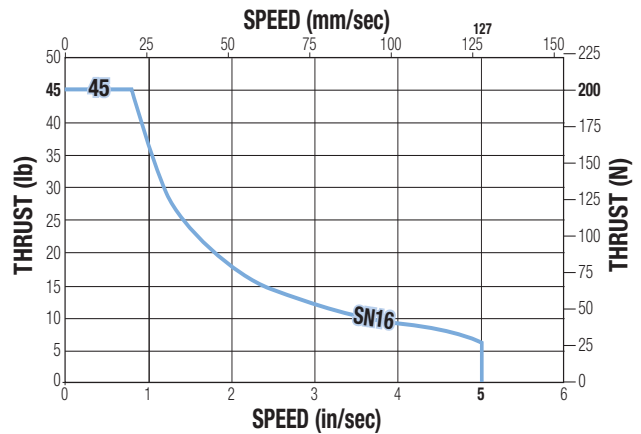

SN = Solid Nut

▲ * Maximum thrust is the maximum continuous dynamic thrust subject to Thrust x Velocity Limitation.

PV LIMITS: Any material which carries a sliding load is limited by heat buildup. The factors that affect heat generation rate in an application are the pressure on the nut in pounds per square inch and the surface velocity in feet per minute. The product of these factors provides a measure of the severity of an application.

$$\frac{P}{(\text{Max. Thrust Rating})} \times \frac{V}{(\text{Max. Speed Rating})} \leq 0.1$$

MXE25 & 32 ACME SCREW CRITICAL SPEED AND PV LIMITS

Critical Speed: 0.5" ACME

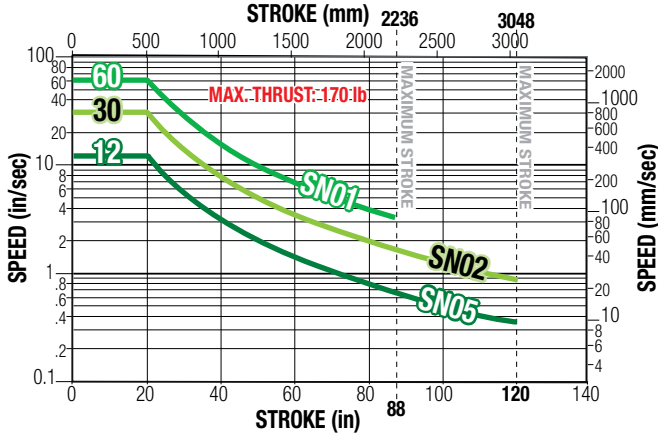

PV Limits: 1TPI Acme Screw

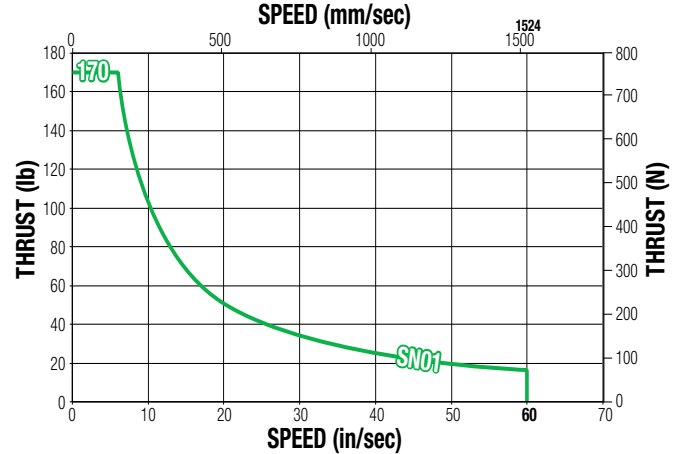

PV Limits: 2TPI Acme Screw

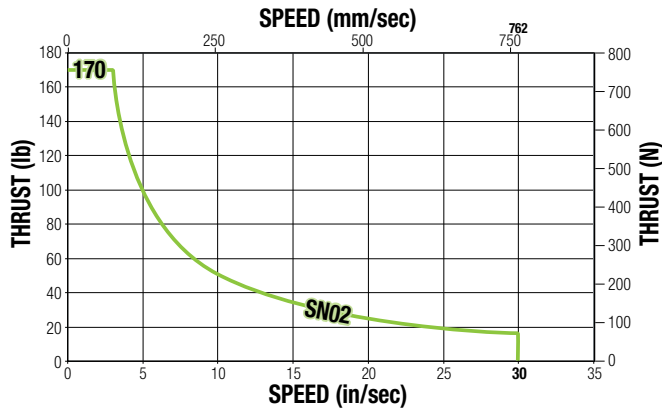

PV Limits: 5TPI Acme Screw

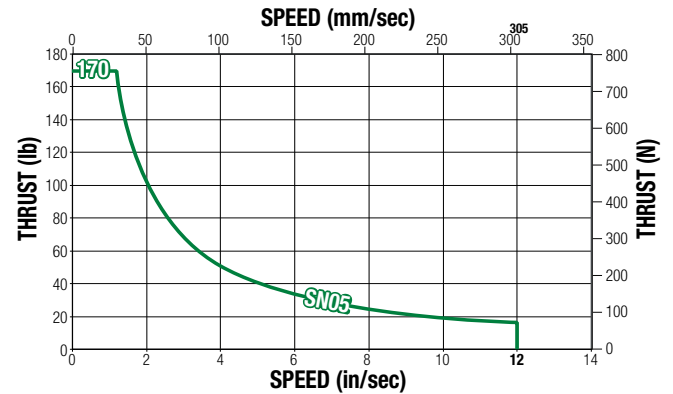

SN = Solid Nut

▲ * Maximum thrust is the maximum continuous dynamic thrust subject to Thrust x Velocity Limitation.

PV LIMITS: Any material which carries a sliding load is limited by heat buildup. The factors that affect heat generation rate in an application are the pressure on the nut in pounds per square inch and the surface velocity in feet per minute. The product of these factors provides a measure of the severity of an application.

$$\frac{P}{(\text{Max. Thrust Rating})} \times \frac{V}{(\text{Max. Speed Rating})} \leq 0.1$$

$$\left(\frac{\text{Thrust}}{(\text{Max. Thrust Rating})} \right) \times \left(\frac{\text{Speed}}{(\text{Max. Speed Rating})} \right) \leq 0.1$$

MXE25 & 32 BALL SCREW CRITICAL SPEED AND THEORETICAL LIFE

Critical Speed: 0.375", 8TPI Ball Screw

Life: 0.375", 8TPI Ball Screw

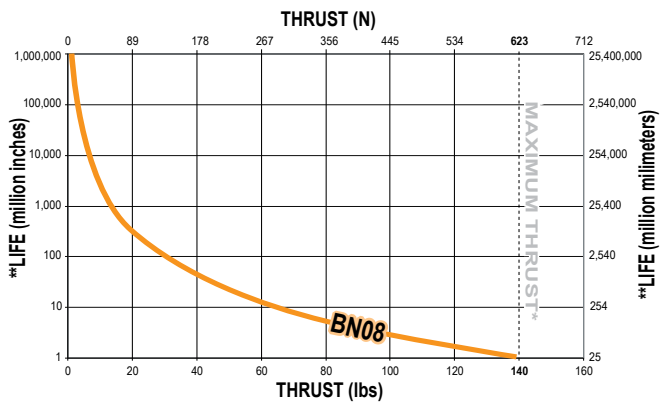
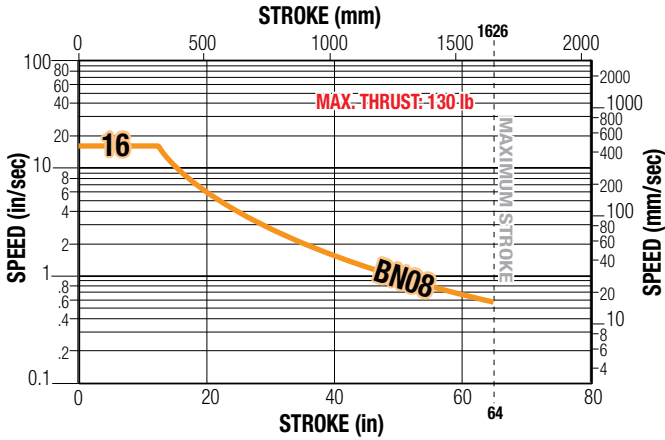

BN = Ball Nut

- ▲** *Maximum thrust reflects 90% reliability for 1 million linear inches of travel.
- **Life indicates theoretical maximum life of screw only, under ideal conditions and does not indicate expected life of actuator.

MXE40 ACME SCREW CRITICAL SPEED AND PV LIMITS

Critical Speed: 0.75" 1TPI Acme Screw

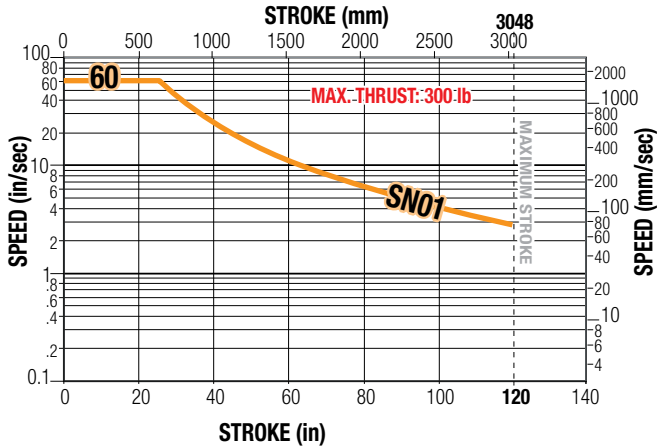

Critical Speed: 0.625" 2TPI Acme Screw

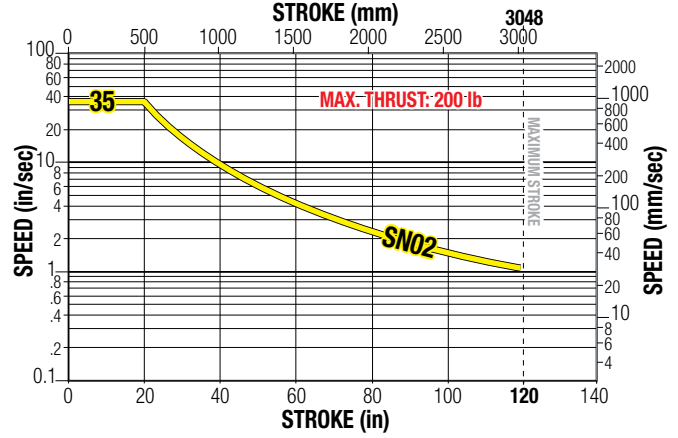

PV Limits: 1TPI Acme Screw

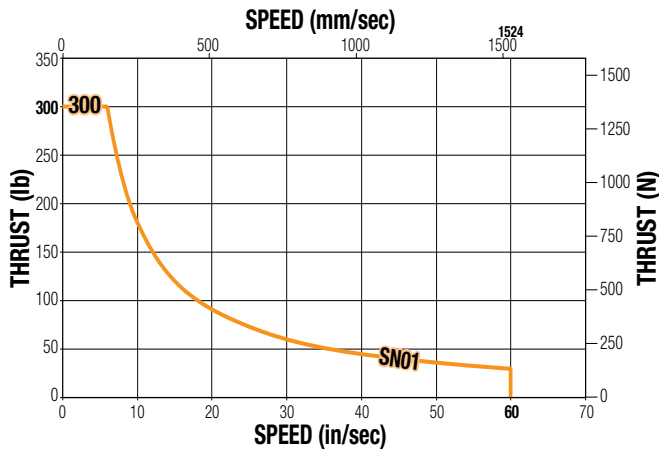

PV Limits: 2TPI Acme Screw

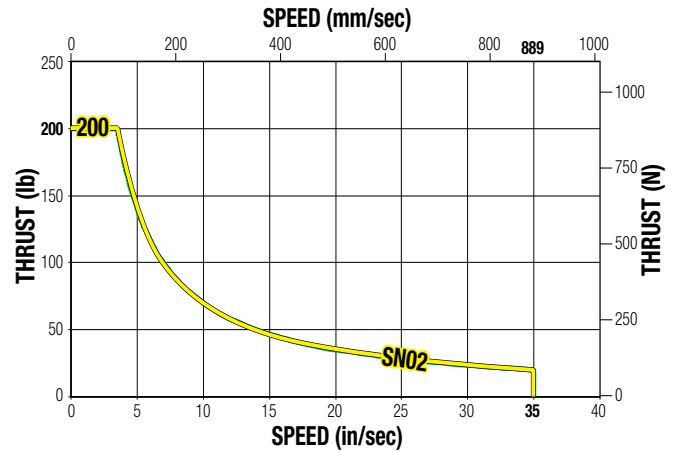

SN = Solid Nut

▲ * Maximum thrust is the maximum continuous dynamic thrust subject to Thrust x Velocity Limitation.

PV LIMITS: Any material which carries a sliding load is limited by heat buildup. The factors that affect heat generation rate in an application are the pressure on the nut in pounds per square inch and the surface velocity in feet per minute. The product of these factors provides a measure of the severity of an application.

$$\left(\frac{P}{(\text{Max. Thrust Rating})} \right) \times \left(\frac{V}{(\text{Max. Speed Rating})} \right) \leq 0.1$$

MXE40 BALL SCREW CRITICAL SPEED AND THEORETICAL LIFE

Critical Speed: 0.5", 2TPI Ball Screw

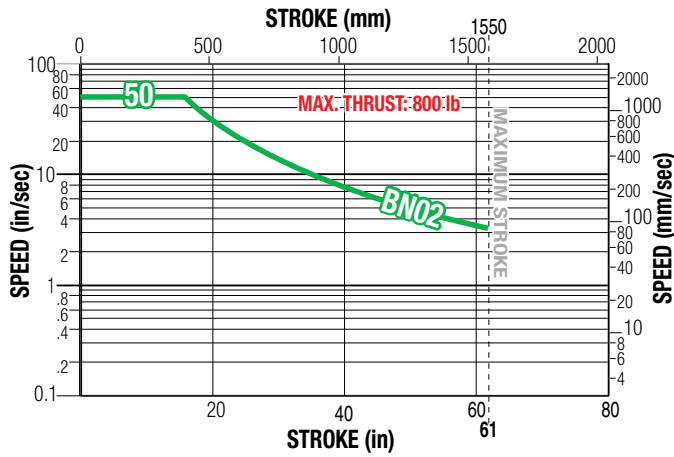

Critical Speed: 0.625", 5TPI Ball Screw

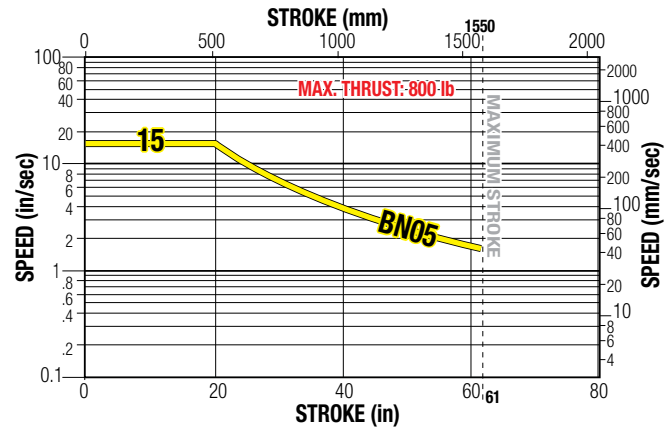

Life: 0.5" and 0.625" Ball Screws

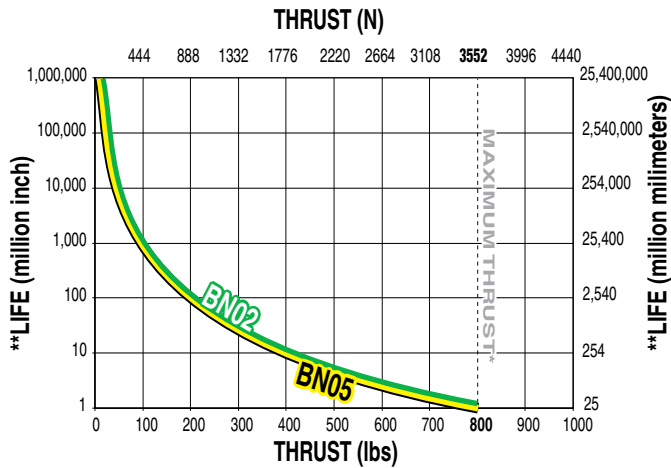

BN = Ball Nut

▲ *Maximum thrust reflects 90% reliability for 1 million linear inches of travel.

**Life indicates theoretical maximum life of screw only, under ideal conditions and does not indicate expected life of actuator.

MXE50 ACME SCREW CRITICAL SPEED AND PV LIMITS

Critical Speed: 0.75" 1 & 2TPI Acme Screw

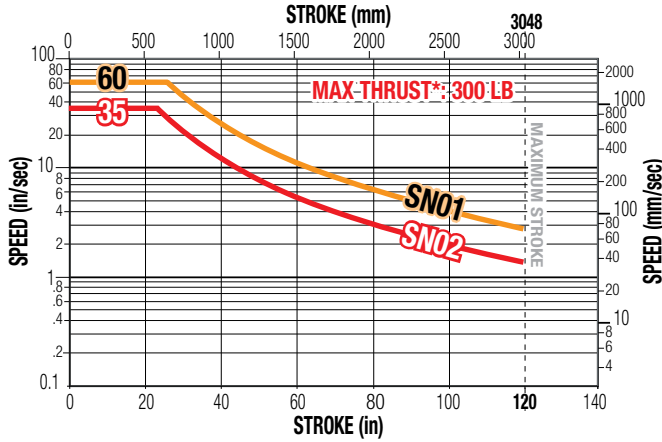

PV Limits: 1TPI Acme Screw

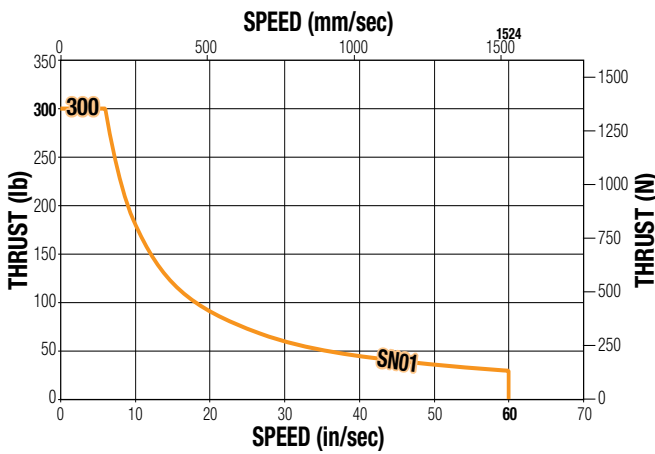

PV Limits: 2TPI Acme Screw

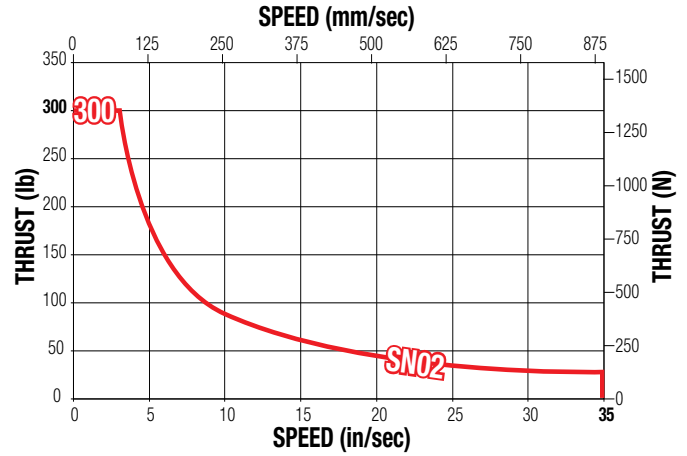

SN = Solid Nut

▲ * Maximum thrust is the maximum continuous dynamic thrust subject to Thrust x Velocity Limitation.

PV LIMITS: Any material which carries a sliding load is limited by heat buildup. The factors that affect heat generation rate in an application are the pressure on the nut in pounds per square inch and the surface velocity in feet per minute. The product of these factors provides a measure of the severity of an application.

$$\left(\frac{P}{(\text{Max. Thrust Rating})} \right) \times \left(\frac{V}{(\text{Max. Speed Rating})} \right) \leq 0.1$$

MXE50 BALL SCREW CRITICAL SPEED AND THEORETICAL LIFE

Critical Speed: 0.75", 2TPI Ball Screw

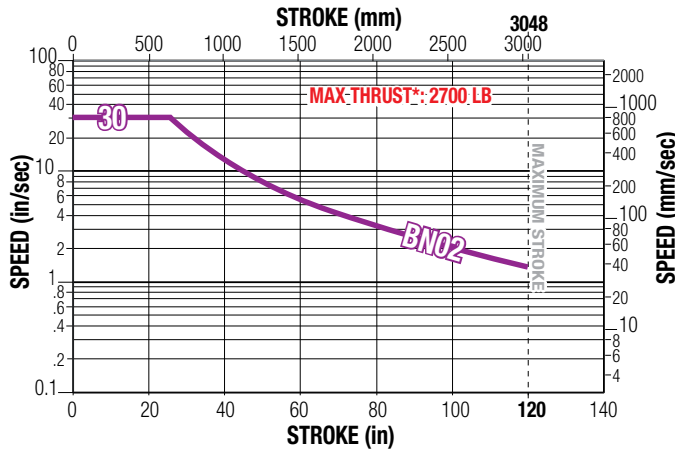

Critical Speed: 0.75", 5TPI Ball Screw

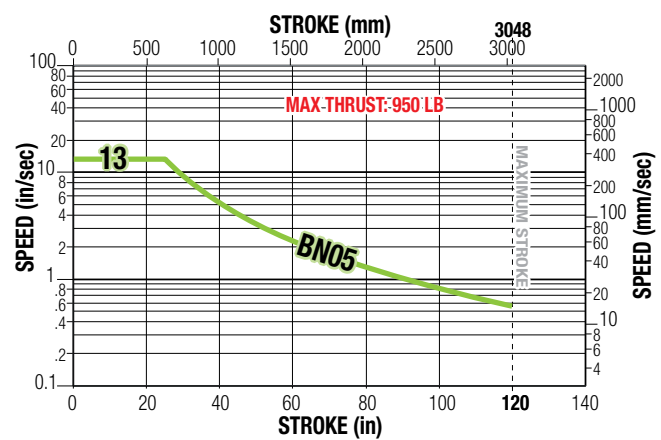

Life: 0.75", 2TPI Ball Screws

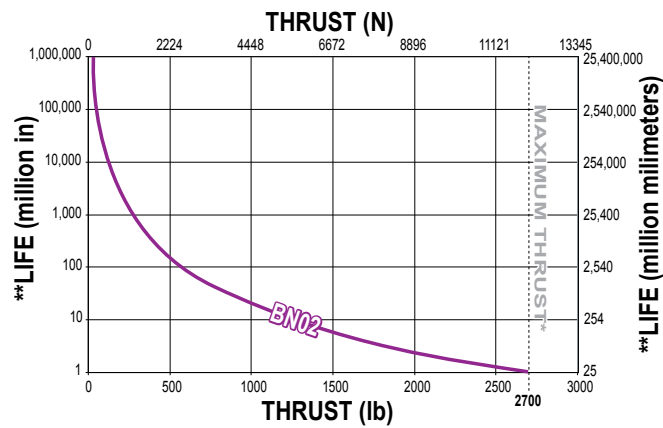

Life: 0.75", 5TPI Ball Screws

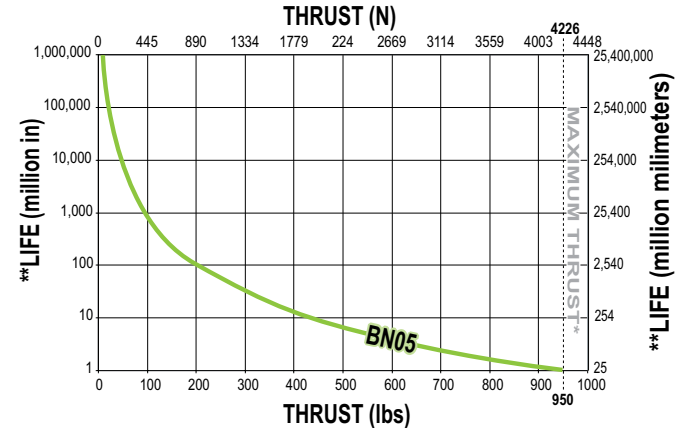

BN = Ball Nut

▲ *Maximum thrust reflects 90% reliability for 1 million linear inches of travel.

**Life indicates theoretical maximum life of screw only, under ideal conditions and does not indicate expected life of actuator.

MXE63 ACME SCREW CRITICAL SPEED AND PV LIMITS

Critical Speed: 1" , 4TPI Acme Screw

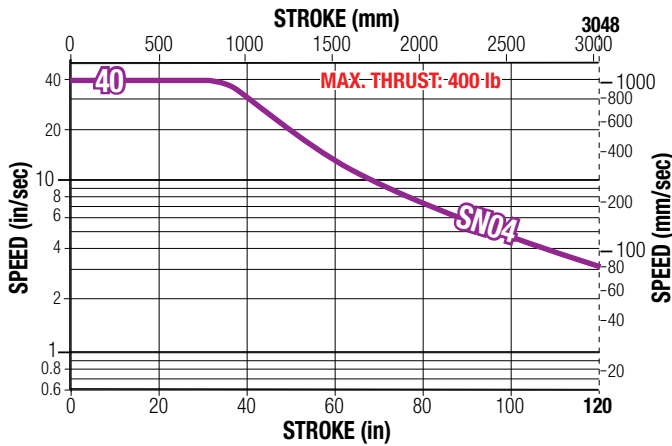

PV Limits: 4TPI Acme Screw

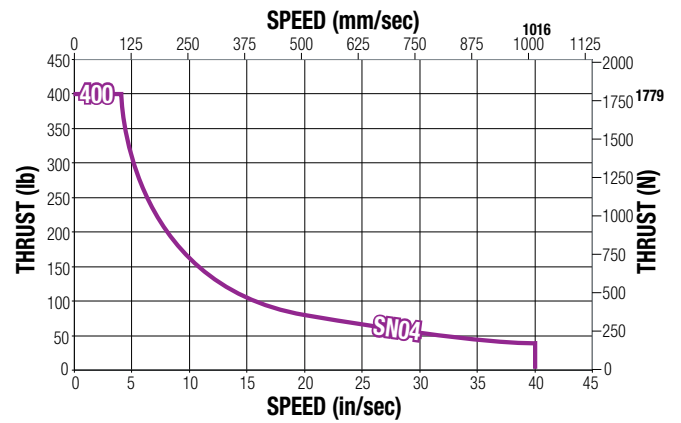

SN = Solid Nut

⚠ * Maximum thrust is the maximum continuous dynamic thrust subject to Thrust x Velocity Limitation.

PV LIMITS: Any material which carries a sliding load is limited by heat buildup. The factors that affect heat generation rate in an application are the pressure on the nut in pounds per square inch and the surface velocity in feet per minute. The product of these factors provides a measure of the severity of an application.

$$P \times V \leq 0.1$$

$$\left(\frac{\text{Thrust}}{(\text{Max. Thrust Rating})} \right) \times \left(\frac{\text{Speed}}{(\text{Max. Speed Rating})} \right) \leq 0.1$$

MXE63 BALL SCREW CRITICAL SPEED AND THEORETICAL LIFE

Critical Speed: 1", 1TPI Ball Screw

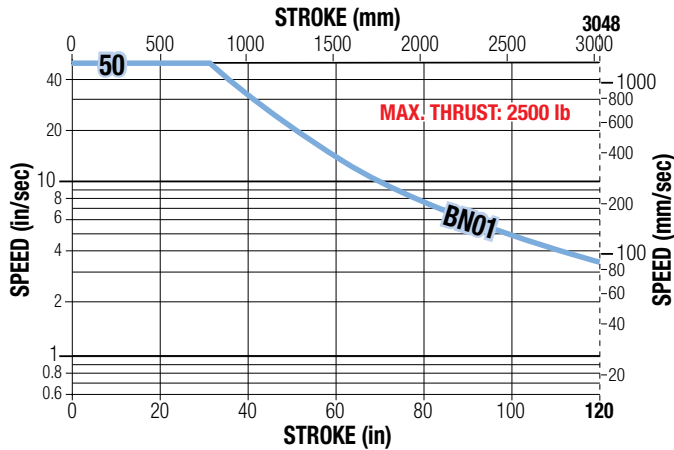

Life: 1", 1TPI Ball Screw

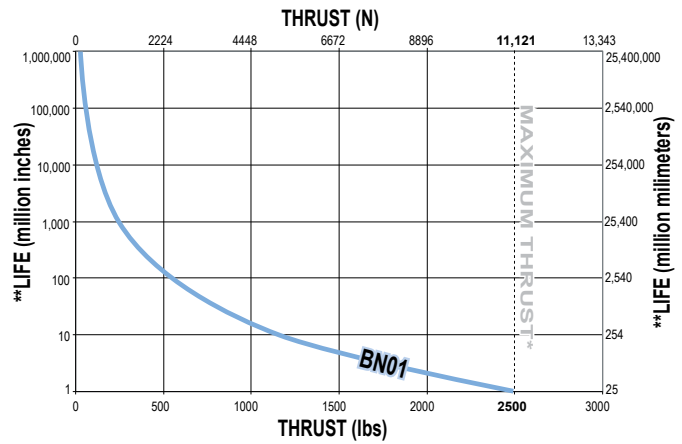

Critical Speed: 1", 2TPI Ball Screw

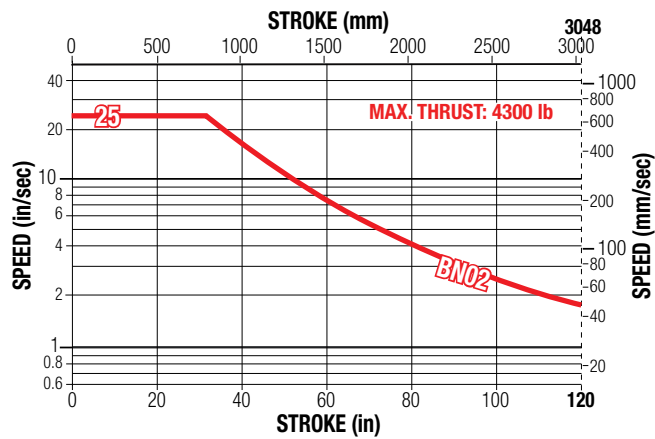

Life: 1", 2TPI Ball Screw

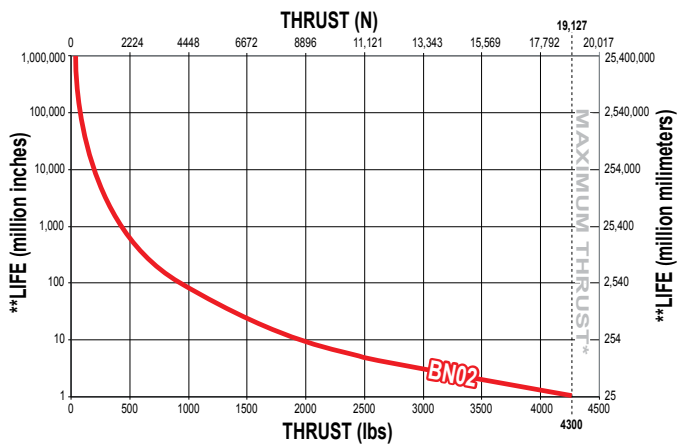

Critical Speed: 1", 4TPI Ball Screw

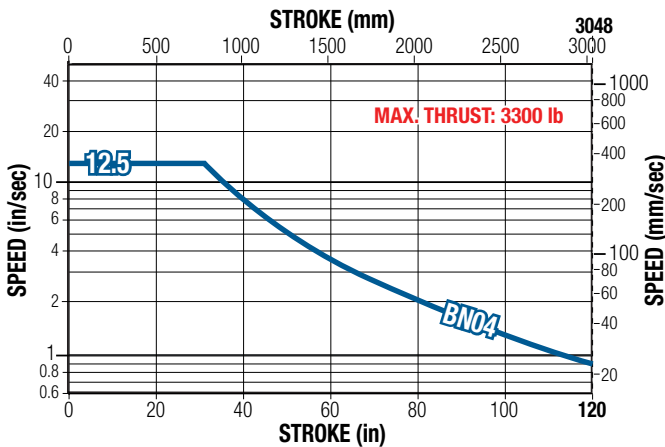

Life: 1", 4TPI Ball Screw

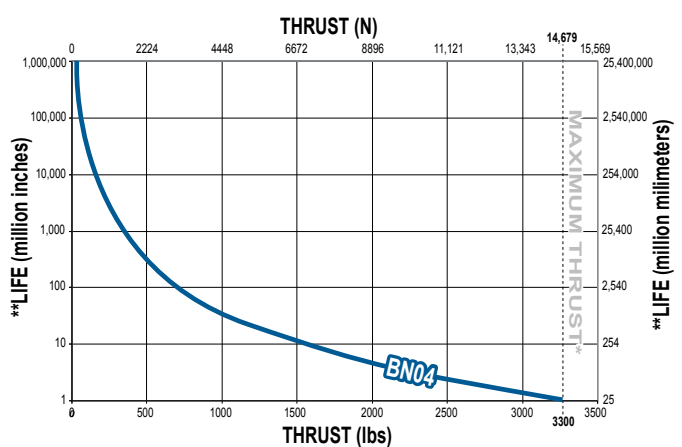

BN = Ball Nut

▲ **Maximum thrust reflects 90% reliability for 1 million linear inches of travel.*

***Life indicates theoretical maximum life of screw only, under ideal conditions and does not indicate expected life of actuator.*

S-SOLID BEARING ACTUATOR DIMENSIONS

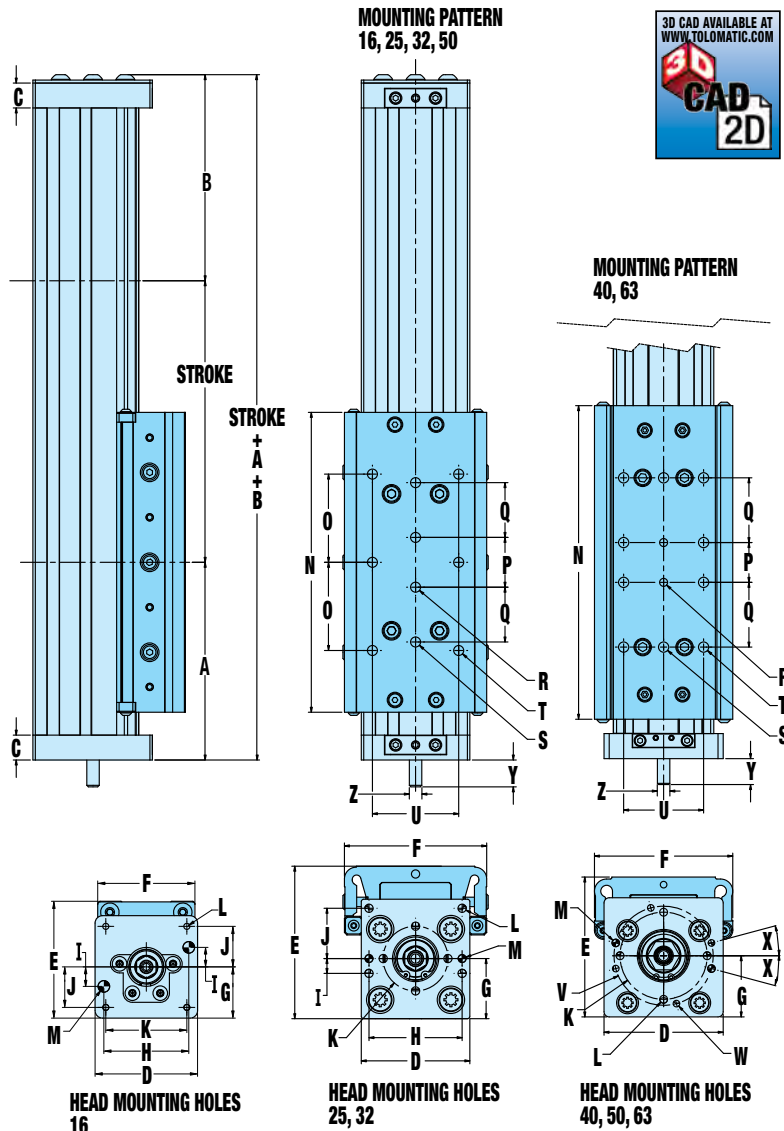

	MXE16	MXE25	MXE32	MXE40	MXE50	MXE63
A	2.72	3.79	3.97	4.93	5.58	8.32
<i>mm</i>	<i>69.1</i>	<i>96.3</i>	<i>100.9</i>	<i>125.2</i>	<i>141.7</i>	<i>211.3</i>
B	2.84	3.96	4.14	5.12	5.82	8.51
<i>mm</i>	<i>72.1</i>	<i>100.6</i>	<i>105.1</i>	<i>130</i>	<i>147.8</i>	<i>216.2</i>
C	0.50	0.92	0.50	0.63	1.31	1.88
<i>mm</i>	<i>12.7</i>	<i>23.4</i>	<i>12.7</i>	<i>16</i>	<i>33.3</i>	<i>47.8</i>
D	1.66	2.25	2.18	2.99	3.47	4.33
<i>mm</i>	<i>42.2</i>	<i>57.2</i>	<i>55.4</i>	<i>75.9</i>	<i>88.1</i>	<i>110.0</i>
E	1.89	2.30	3.06	3.51	4.44	5.50
<i>mm</i>	<i>48.0</i>	<i>58.4</i>	<i>77.8</i>	<i>89.2</i>	<i>112.8</i>	<i>139.7</i>
F	1.58	2.18	2.86	3.47	4.10	5.59
<i>mm</i>	<i>40.1</i>	<i>55.4</i>	<i>72.6</i>	<i>88.2</i>	<i>104.1</i>	<i>142.0</i>
G	0.83	0.95	1.21	1.54	1.82	2.30
<i>mm</i>	<i>21.1</i>	<i>24.1</i>	<i>30.7</i>	<i>39.1</i>	<i>46.2</i>	<i>58.4</i>
H	1.38	1.87	1.87	-	-	-
<i>mm</i>	<i>35.1</i>	<i>47.5</i>	<i>47.5</i>	-	-	-
I	0.32	0.30	0.30	-	-	-
<i>mm</i>	<i>8.1</i>	<i>7.6</i>	<i>7.6</i>	-	-	-
J	0.66	1.01	1.01	-	-	-
<i>mm</i>	<i>16.8</i>	<i>25.7</i>	<i>25.7</i>	-	-	-
K	1.31	Ø1.30	Ø1.30	Ø2.19	Ø2.69	Ø3.01
<i>mm</i>	<i>33.3</i>	<i>Ø33.0</i>	<i>Ø33.0</i>	<i>Ø55.6</i>	<i>Ø68.3</i>	<i>Ø76.5</i>
L	M3x0.5 (4)	M5x0.8 (8)	M5x0.8 (8)	M6x1.0 (4)	M6x1.0 (4)	M6x1.0 (4)
<i>mm</i>	<i>M3x0.5 (4)</i>	<i>M5x0.8 (8)</i>	<i>M5x0.8 (8)</i>	<i>M6x1.0 (4)</i>	<i>M6x1.0 (4)</i>	<i>M6x1.0 (4)</i>
M	Ø.188 (2)	Ø.158 (2)	Ø.158 (2)	Ø.189 (2)	Ø.188 (2)	Ø.188 (2)
<i>mm</i>	<i>Ø4.78 (2)</i>	<i>Ø4.01 (2)</i>	<i>Ø4.01 (2)</i>	<i>Ø4.80 (2)</i>	<i>Ø4.78 (2)</i>	<i>Ø4.78 (2)</i>
N	4.12	5.31	6.02	7.87	7.91	12.11
<i>mm</i>	<i>104.6</i>	<i>134.9</i>	<i>153</i>	<i>200</i>	<i>200.9</i>	<i>307.6</i>
O	1.18	1.57	1.77	-	1.88	-
<i>mm</i>	<i>30.0</i>	<i>39.9</i>	<i>45</i>	-	<i>47.8</i>	-
P	-	1.00	1.00	1.00	2.50	3.00
<i>mm</i>	-	<i>25.4</i>	<i>25.4</i>	<i>25.4</i>	<i>63.5</i>	<i>76.2</i>
Q	-	1.07	1.10	1.63	1.25	1.50
<i>mm</i>	-	<i>27.2</i>	<i>28</i>	<i>41.3</i>	<i>31.8</i>	<i>38.1</i>
R	-	1/4-20 (2)	1/4-20 (2)	1/4-20 (2)	3/8-16 (2)	3/8-16 (2)
<i>mm</i>	-	<i>M6x1.0 (2)</i>	<i>M8x1.25 (2)</i>	<i>M8x1.25 (2)</i>	<i>M10x1.5 (2)</i>	<i>M10x1.5 (2)</i>
S	-	#10-32 (2)	1/4-20 (2)	5/16-18 (2)	3/8-16 (2)	3/8-16 (2)
<i>mm</i>	-	<i>M6x1.0 (2)</i>	<i>M8x1.25 (2)</i>	<i>M8x1.25 (2)</i>	<i>M10x1.5 (2)</i>	<i>M10x1.5 (2)</i>
T	#8-32 (6)	1/4-20 (6)	1/4-20 (6)	5/16-18 (8)	3/8-16 (6)	3/8-16 (8)
<i>mm</i>	<i>M4x0.7 (6)</i>	<i>M6x1.0 (6)</i>	<i>M8x1.25 (6)</i>	<i>M8x1.25 (8)</i>	<i>M10x1.5 (6)</i>	<i>M10x1.5 (8)</i>
U	1.18	1.18	1.73	2.00	2.59	3.25
<i>mm</i>	<i>30.0</i>	<i>30.0</i>	<i>44.0</i>	<i>51.0</i>	<i>65.8</i>	<i>82.6</i>
V	-	-	-	Ø2.49	Ø3.01	Ø3.01
<i>mm</i>	-	-	-	<i>Ø63.2</i>	<i>Ø76.5</i>	<i>Ø76.5</i>
W	-	-	-	M5x0.8 (4)	M5x0.8 (4)	M5x0.8 (4)
<i>mm</i>	-	-	-	<i>M5x0.8 (4)</i>	<i>M5x0.8 (4)</i>	<i>M5x0.8 (4)</i>
X	-	-	-	15°	15°	15°
<i>mm</i>	-	-	-	<i>15°</i>	<i>15°</i>	<i>15°</i>

Y (Shaft length)	MXE16	MXE25	MXE32	MXE40	MXE50	MXE63
LMI	0.64	0.55	0.55	0.69	1.35	1.35
<i>mm</i>	<i>16.3</i>	<i>14.0</i>	<i>14.0</i>	<i>17.5</i>	<i>34.3</i>	<i>34.3</i>
17 FRAME RP	0.87	-	-	-	-	-
<i>mm</i>	<i>22.1</i>	-	-	-	-	-
23 FRAME RP	-	1.99	1.99	1.99	2.10	1.92
<i>mm</i>	-	<i>50.5</i>	<i>50.5</i>	<i>50.5</i>	<i>53.3</i>	<i>48.8</i>
34 FRAME RP	-	2.20	2.20	2.20	2.10	1.92
<i>mm</i>	-	<i>55.9</i>	<i>55.9</i>	<i>55.9</i>	<i>53.3</i>	<i>48.8</i>
56 FRAME RP	-	-	-	-	-	1.92
<i>mm</i>	-	-	-	-	-	<i>48.8</i>

Z (Shaft dia.)	MXE16	MXE25	MXE32	MXE40	MXE50	MXE63
LMI (BN02)	0.156	0.25	0.25	0.312	0.5	-
<i>mm</i>	<i>3.96</i>	<i>6.35</i>	<i>6.35</i>	<i>7.92</i>	<i>12.70</i>	-
LMI (all others)	0.156	0.25	0.25	0.393	0.5	0.5
<i>mm</i>	<i>3.96</i>	<i>6.35</i>	<i>6.35</i>	<i>9.98</i>	<i>12.70</i>	<i>12.70</i>
RP (BN02)	0.156	0.25	0.25	0.25	0.5	0.5
<i>mm</i>	<i>3.96</i>	<i>6.35</i>	<i>6.35</i>	<i>6.35</i>	<i>12.70</i>	<i>12.70</i>
RP (all others)	0.156	0.25	0.25	0.375	0.5	0.5
<i>mm</i>	<i>3.96</i>	<i>6.35</i>	<i>6.35</i>	<i>9.53</i>	<i>12.70</i>	<i>12.70</i>

S-SOLID BEARING OPTION DIMENSIONS

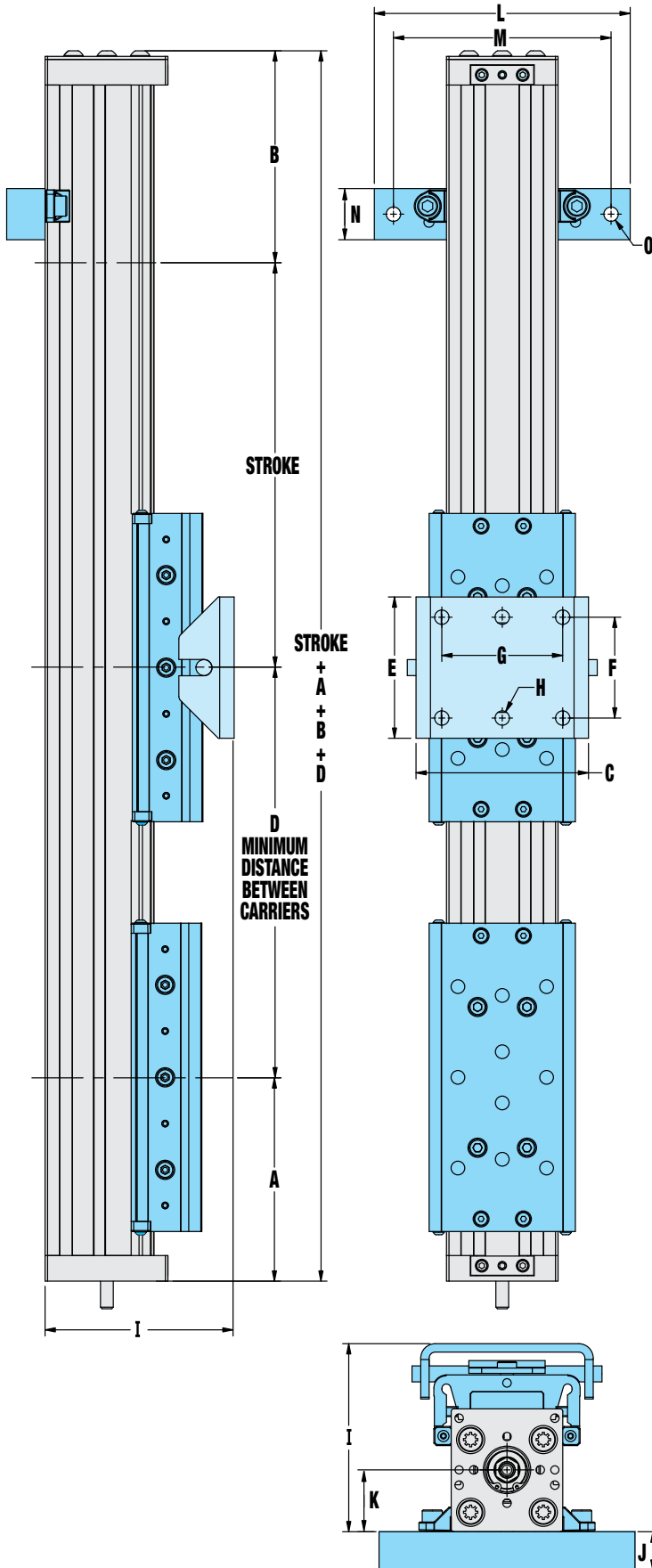

	MXE16S	MXE25S	MXE32S	MXE40S	MXE50S	MXE63S
A	2.72	3.79	3.97	4.93	5.58	8.32
mm	69.1	96.3	100.9	125.2	141.7	211.3
B	2.84	3.96	4.14	5.12	5.82	8.51
mm	72.1	100.6	105.1	130	147.8	216.2
AUXILIARY CARRIER						
D	5.00	6.00	7.00	8.50	8.60	13.00
mm	127.0	152.4	177.8	215.9	218.4	330.2
FLOATING MOUNT						
C	1.86	2.52	3.37	4.32	5.04	6.10
mm	47.2	64.1	93.3	109.7	128.0	154.9
E	0.98	1.25	2.76	3.94	3.94	5.00
mm	24.9	31.8	70.1	100.0	100.0	127.0
F	0.47	0.63	1.97	2.95	3.15	3.94
mm	11.9	15.9	50.0	74.9	80.0	100.1
G	-	-	-	2.17	-	2.76
mm	-	-	-	55.1	-	70.1
H*	0.18 (2)	0.24 (2)	0.28 (2)	0.28 (4)	0.36 (2)	0.34 (4)
mm	04.6 (2)	06.1 (2)	07.1 (2)	07.1 (4)	09.1 (2)	08.6 (4)
I	2.28	2.80	3.67	4.26	5.24	6.17
mm	57.9	71.0	93.3	108.2	133.1	156.7
MOUNTING PLATE/TUBE CLAMP KITS						
J**	0.50	1.00	0.75	0.63	1.25	1.00
mm	12.7	25.4	19.1	16.0	31.8	25.4
J***	-	1.38	1.13	1.00	1.25	1.00
mm	-	35.1	28.7	25.4	31.8	25.4
K	0.83	0.95	1.21	1.54	1.82	2.30
mm	21.1	24.1	30.7	39.1	46.2	58.4
L	2.50	4.00	5.00	5.00	5.60	8.00
mm	63.5	101.6	127.0	127.0	142.2	203.2
M	1.88	3.39	4.25	4.41	5.00	7.00
mm	47.8	86.0	108.0	112.0	127.0	177.8
N	1.00	1.00	1.00	0.79	0.79	1.00
mm	25.4	25.4	25.4	20.0	20.0	25.4
O	0.22 (2)	0.22 (2)	0.28 (2)	0.28 (2)	0.28 (2)	0.42 (2)
mm	05.6 (2)	05.6 (2)	07.1 (2)	07.1 (2)	07.1 (2)	010.7 (2)

* MXE16, MXE25, MXE32 & MXE50 USE 2 CENTER HOLES, MXE40 & MXE63 USE 4 CORNER HOLES

** MOUNTING PLATE THICKNESS FOR 23 FRAME MOTORS (17 FRAME MOTORS ON MXE16)

*** MOUNTING PLATE THICKNESS FOR 34 FRAME MOTORS (AND 56 FRAME MOTORS ON MXE63)

NOTE: MXE16 uses **M/P** (mounting plate) with included T-nuts



P-PROFILED RAIL ACTUATOR DIMENSIONS

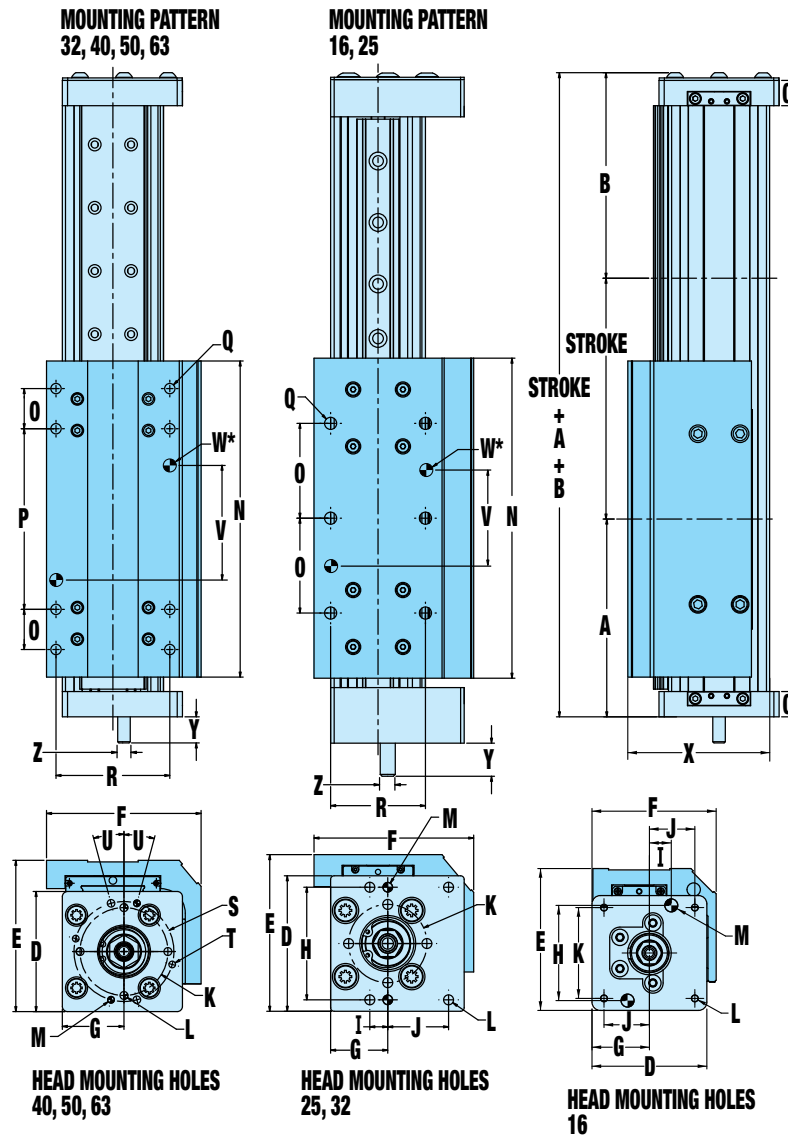

	MXE16	MXE25	MXE32	MXE40	MXE50	MXE63
A	2.72	3.79	3.97	4.93	5.58	8.32
mm	69.1	96.3	100.9	125.2	141.7	211.3
B	2.84	3.96	4.14	5.12	5.82	8.51
mm	72.1	100.6	105.1	130.0	147.8	216.2
C	0.50	0.92	0.50	0.63	1.31	1.88
mm	12.7	23.4	12.7	16.0	33.3	47.8
D	1.66	2.25	2.18	2.99	3.47	4.33
mm	42.2	57.2	55.4	75.9	88.0	110.0
E	2.05	2.60	3.05	3.77	4.90	5.71
mm	52.1	66.1	77.4	95.7	124.5	145.0
F	1.80	2.65	3.25	3.85	4.62	5.65
mm	45.7	67.4	82.6	97.8	117.3	143.5
G	0.83	0.95	1.21	1.54	1.82	2.30
mm	21.1	24.1	30.7	39.1	46.2	58.4
H	1.38	1.87	1.87	-	-	-
mm	35.1	47.5	47.5	-	-	-
I	0.32	0.30	0.30	-	-	-
mm	8.1	7.6	7.6	-	-	-
J	0.66	1.01	1.01	-	-	-
mm	16.8	25.7	25.7	-	-	-
K	1.31	Ø1.30	Ø1.30	Ø2.19	Ø2.69	Ø2.19
mm	33.3	Ø33.0	Ø33.0	Ø55.6	Ø68.3	Ø55.6
L	M3x0.5 (4)	M5x0.8 (8)	M5x0.8 (8)	M6x1.0 (4)	M6x1.0 (4)	M6x1.0 (4)
mm	M3x0.5 (4)	M5x0.8 (8)	M5x0.8 (8)	M6x1.0 (4)	M6x1.0 (4)	M6x1.0 (4)
M	Ø.188 (2)	Ø.158 (2)	Ø.158 (2)	Ø.189 (2)	Ø.188 (2)	Ø.188 (2)
mm	Ø4.78 (2)	Ø4.01 (2)	Ø4.01 (2)	Ø4.80 (2)	Ø4.78 (2)	Ø4.78 (2)
N	4.33	5.31	6.69	7.87	8.50	12.11
mm	110.0	135.0	170.0	200	215.9	207.6
O	1.58	1.57	1.07	1.00	1.00	1.57
mm	40.0	40.0	27.2	25.4	25.4	39.9
P	-	-	3.37	4.50	2.75	5.12
mm	-	-	85.6	114.3	69.9	130.0
Q	#8-32 (6)	1/4-20 (6)	5/16-18 (8)	5/16-18 (8)	5/16-18 (8)	3/18-16 (8)
mm	M4x0.7 (6)	M6x1.0 (6)	M8x1.25 (8)	M8x1.25 (8)	M8x1.25 (8)	M10x1.5 (8)
R	1.102	1.575	1.969	2.835	3.125	3.870
mm	28.00	40.00	50.00	72.00	79.38	98.30
S	-	-	-	Ø2.49	Ø3.01	Ø3.01
mm	-	-	-	Ø63.2	Ø76.5	Ø76.5
T	-	-	-	M5x0.8 (4)	M5x0.8 (4)	M5x0.8 (4)
mm	-	-	-	M5x0.8 (4)	M5x0.8 (4)	M5x0.8 (4)
U	-	-	-	15°	15°	15°
mm	-	-	-	15°	15°	15°
V	1.575	1.575	1.772	2.500	1.500	2.559
mm	40.00	40.00	45.00	63.50	38.10	65.00
W*	Ø.1583 / 1.573 (2)	Ø.2520 / 2.510 (2)	Ø.3145 / 3.135 (2)	Ø.3145 / 3.135 (2)	Ø.3145 / 3.135 (2)	Ø.3770 / 3.760 (2)
mm	Ø4.045 / 4.020 ↓ 6.35	Ø6.045 / 6.020 ↓ 6.35	Ø8.045 / 8.020 ↓ 9.53	Ø8.045 / 8.020 ↓ 12.70	Ø8.045 / 8.020 ↓ 12.70	Ø10.045 / 10.020 ↓ 12.70
X	1.81	2.30	3.05	3.53	4.71	5.51
mm	46.0	58.5	77.4	89.7	119.7	140.0

Y (Shaft length)	MXE16	MXE25	MXE32	MXE40	MXE50	MXE63
LMI	0.64	0.55	0.55	0.69	1.35	1.35
mm	16.3	14	14	17.5	34.3	34.3
17 FRAME RP	0.87	-	-	-	-	-
mm	22.1	-	-	-	-	-
23 FRAME RP	-	1.99	1.99	1.99	2.10	1.92
mm	-	50.5	50.5	50.5	53.3	48.8
34 FRAME RP	-	2.2	2.2	2.2	2.10	1.92
mm	-	55.9	55.9	55.9	53.3	48.8
56 FRAME RP	-	-	-	-	-	1.92
mm	-	-	-	-	-	48.8

Z (Shaft dia.)	MXE16	MXE25	MXE32	MXE40	MXE50	MXE63
LMI (BN02)	0.156	0.25	0.25	0.312	0.5	-
mm	3.96	6.35	6.35	7.92	12.70	-
LMI (all others)	0.156	0.25	0.25	0.393	0.5	0.5
mm	3.96	6.35	6.35	9.98	12.70	12.70
RP (BN02)	0.156	0.25	0.25	0.25	0.5	0.5
mm	3.96	6.35	6.35	6.35	12.70	12.70
RP (all others)	0.156	0.25	0.25	0.375	0.5	0.5
mm	3.96	6.35	6.35	9.53	12.70	12.70

*DOWEL HOLES ⌀ 0.003 in (M) ⌀ 0.08 mm (M)

P-PROFILED RAIL OPTION DIMENSIONS

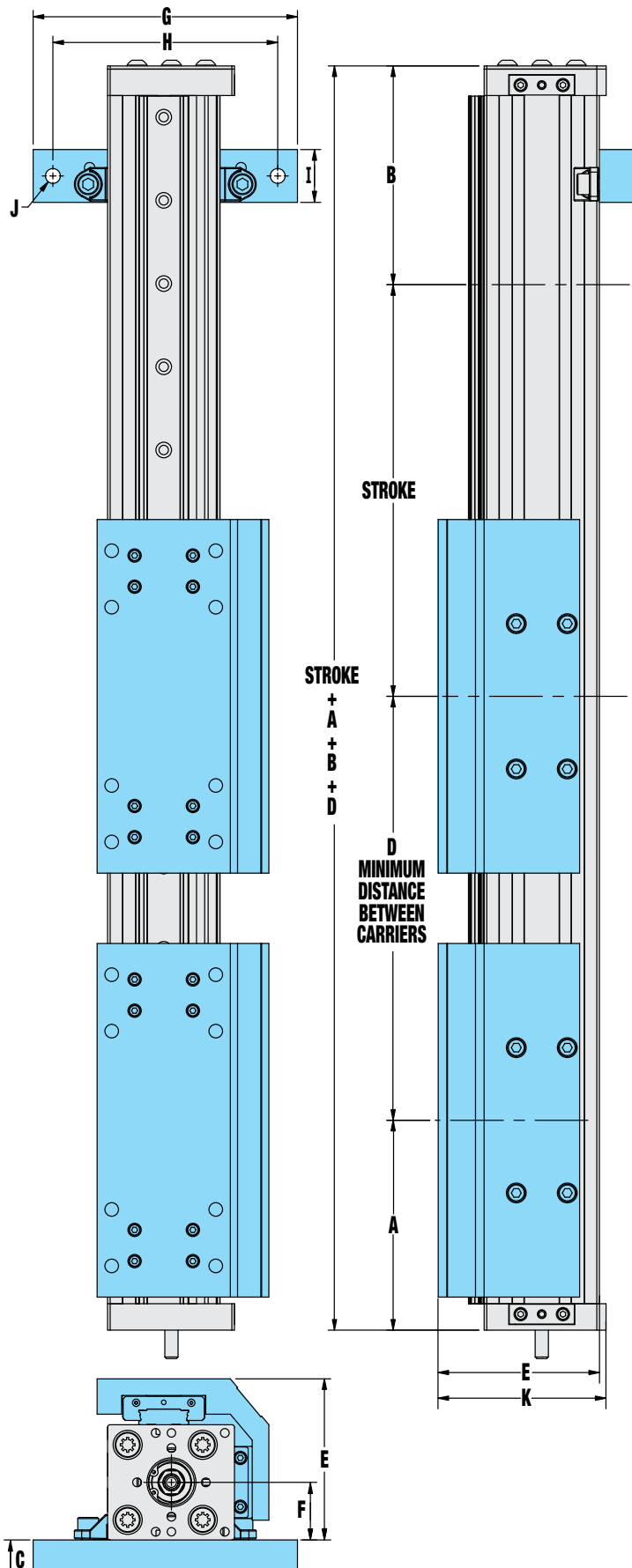

	MXE16P	MXE25P	MXE32P	MXE40P	MXE50P	MXE63P
A	2.72	3.79	3.97	4.93	5.58	8.32
<i>mm</i>	<i>69.1</i>	<i>96.3</i>	<i>100.9</i>	<i>125.2</i>	<i>141.7</i>	<i>211.3</i>
B	2.84	3.96	4.14	5.12	5.82	8.51
<i>mm</i>	<i>72.1</i>	<i>100.6</i>	<i>105.1</i>	<i>130</i>	<i>147.8</i>	<i>216.2</i>
AUXILIARY CARRIER						
D	5.00	6.00	7.00	8.50	8.60	13.00
<i>mm</i>	<i>127.0</i>	<i>152.4</i>	<i>177.8</i>	<i>215.9</i>	<i>218.4</i>	<i>330.2</i>
MOUNTING PLATE/TUBE CLAMP KITS						
C*	0.50	1.00	0.75	0.63	1.25	1.00
<i>mm</i>	<i>12.7</i>	<i>25.4</i>	<i>19.1</i>	<i>16.0</i>	<i>31.8</i>	<i>25.4</i>
C**	-	1.38	1.13	1.00	1.25	1.00
<i>mm</i>	<i>-</i>	<i>35.1</i>	<i>28.7</i>	<i>25.4</i>	<i>31.8</i>	<i>25.4</i>
E	1.81	2.30	3.05	3.53	4.71	5.51
<i>mm</i>	<i>46.0</i>	<i>58.5</i>	<i>77.4</i>	<i>89.7</i>	<i>119.7</i>	<i>140.0</i>
F	0.83	0.95	1.21	1.54	1.82	2.30
<i>mm</i>	<i>21.1</i>	<i>24.1</i>	<i>30.7</i>	<i>39.1</i>	<i>46.2</i>	<i>58.4</i>
G	2.50	4.00	5.00	5.00	5.60	8.00
<i>mm</i>	<i>63.5</i>	<i>101.6</i>	<i>127.0</i>	<i>127.0</i>	<i>142.2</i>	<i>203.2</i>
H	1.88	3.39	4.25	4.41	5.00	7.00
<i>mm</i>	<i>47.8</i>	<i>86.0</i>	<i>108.0</i>	<i>112.0</i>	<i>127.0</i>	<i>177.8</i>
I	1.00	1.00	1.00	0.79	0.79	1.00
<i>mm</i>	<i>25.4</i>	<i>25.4</i>	<i>25.4</i>	<i>20.0</i>	<i>20.0</i>	<i>25.4</i>
J	0.22 (2)	0.22 (2)	0.28 (2)	0.28 (2)	0.28 (2)	0.42 (2)
<i>mm</i>	<i>05.6 (2)</i>	<i>05.6 (2)</i>	<i>07.1 (2)</i>	<i>07.1 (2)</i>	<i>07.1 (2)</i>	<i>010.7 (2)</i>
K	2.05	2.60	3.05	3.77	1.90	5.71
<i>mm</i>	<i>52.1</i>	<i>66.1</i>	<i>77.4</i>	<i>95.7</i>	<i>124.5</i>	<i>145.0</i>

* MOUNTING PLATE THICKNESS FOR 23 FRAME MOTORS (17 FRAME MOTORS ON MXE16)

** MOUNTING PLATE THICKNESS FOR 34 FRAME MOTORS (AND 56 FRAME MOTORS ON MXE63)



S-SOLID BEARING AND P-PROFILED RAIL IN-LINE MOTOR MOUNTING

MXE16

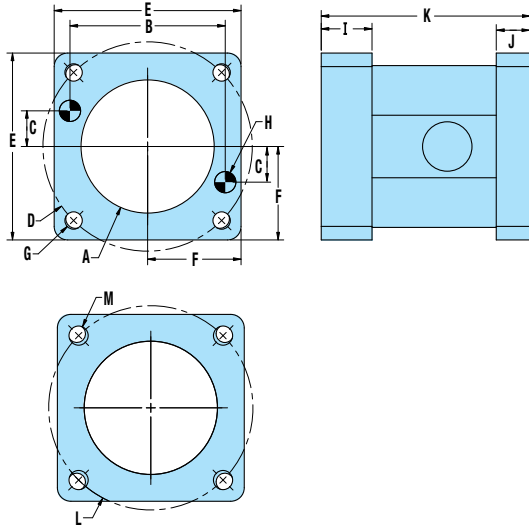

	17 Frame
A	Ø1.18
mm	Ø30.0
B	1.376
mm	34.95
C	0.316
mm	8.03
D	Ø1.855 BC
mm	Ø47.12 BC
E	1.656
mm	42.06
F	0.828
mm	21.03
G	Ø.154 (4)
mm	Ø3.91 (4)
H	Ø.1885/.1895 x .16 DP (2)
mm	Ø4.788/4.813 x 4.1 DP (2)
I	0.45
mm	11.4
J	0.30
mm	7.6
K	1.85
mm	47.0
L	Ø 1.810 BC
mm	Ø 45.97 BC
M	Ø.170 THRU (4)
mm	4.32 THRU (4)

MXE25/32

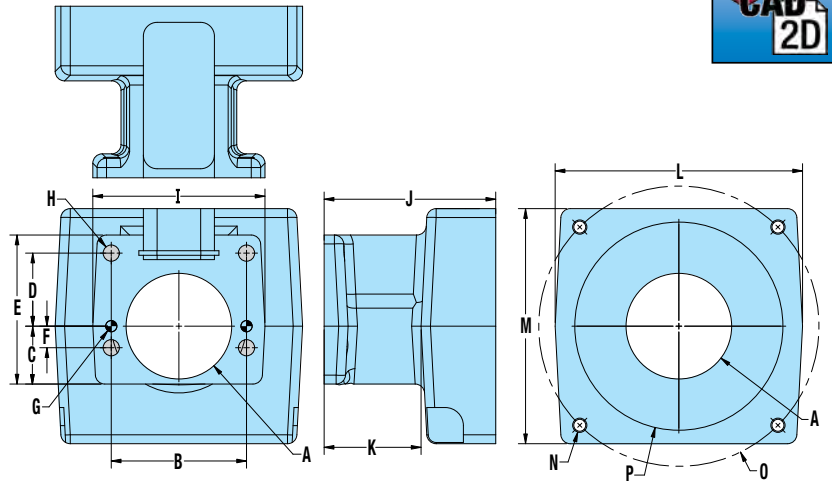

	23 Frame	MRS2x	MRS3x
A	Ø1.46	Ø1.46	Ø1.46
mm	Ø37.1	Ø37.1	Ø37.1
B	1.870	1.870	1.870
mm	47.50	47.50	47.50
C	.800	.800	.800
mm	20.32	20.32	20.32
D	1.010	1.010	1.010
mm	25.65	25.65	25.65
E	2.06	2.06	2.06
mm	52.3	52.3	52.3
F	.298	.298	.298
mm	7.57	7.57	7.57
G	Ø.1555/.1560 x .23 DP (2)	Ø.1555/.1560 x .23 DP (2)	Ø.1555/.1560 x .23 DP (2)
mm	Ø3.948/3.961 x 5.8 DP (2)	Ø3.948/3.961 x 5.8 DP (2)	Ø3.948/3.961 x 5.8 DP (2)
H	Ø.22 THRU (4)	Ø.22 THRU (4)	Ø.22 THRU (4)
mm	Ø5.7 THRU (4)	Ø5.7 THRU (4)	Ø5.7 THRU (4)
I	2.38	2.38	2.38
mm	60.5	60.5	60.5
J	2.49	1.93	2.37
mm	63.2	49.0	60.2
K	1.34	1.34	1.34
mm	34.0	34.0	34.0
L	2.80	2.60	3.42
mm	71.1	66.0	86.9
M	2.80	2.60	3.25
mm	71.1	66.0	82.6
N	#10-24 x 0.75 DP (4)	M5X0.8 x .40 DP (4)	M5X0.8 x .40 DP (4)
mm	#10-24 x 19.1 DP (4)	M5X0.8 x 10.2 DP (4)	M5X0.8 x 10.2 DP (4)
O	Ø2.625 BC	Ø2.625 BC	Ø3.875 BC
mm	Ø66.68 BC	Ø66.68 BC	Ø98.43 BC
P	Ø1.504	Ø1.504	Ø2.877
mm	Ø38.20	Ø38.20	Ø73.08

S-SOLID BEARING AND P-PROFILED RAIL IN-LINE MOTOR MOUNTING

MXE40

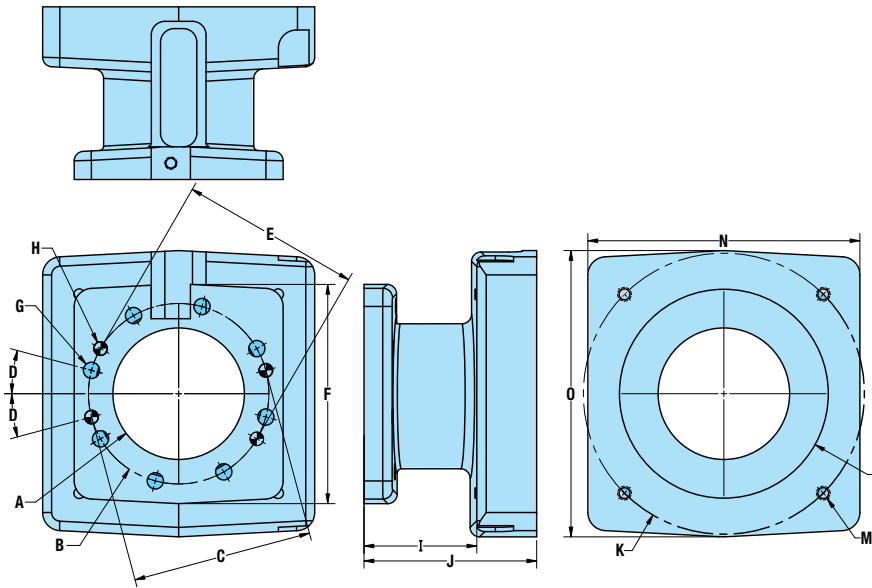

	23 Frame	34 Frame	MRS2x	MRS3x
A	Ø1.81	Ø1.81	Ø1.81	Ø1.81
mm	Ø46.0	Ø46.0	Ø46.0	Ø46.0
B	Ø2.488 BC	Ø2.488 BC	Ø2.488 BC	Ø2.488 BC
mm	Ø63.20 BC	Ø63.20 BC	Ø63.20 BC	Ø63.20 BC
C	2.488	2.488	2.488	2.488
mm	63.20	63.20	63.20	63.20
D	15°	15°	15°	15°
mm	15°	15°	15°	15°
E	2.488	2.488	-	-
mm	63.20	63.20	-	-
F	3.02	3.02	3.02	3.02
mm	76.7	76.7	76.7	76.7
G	Ø.22 THRU (8)	Ø.22 THRU (8)	Ø.22 THRU (4)	Ø.22 THRU (4)
mm	Ø.57 THRU (8)	Ø.57 THRU (8)	Ø.57 THRU (4)	Ø.57 THRU (4)
H	Ø.1865/.1875 x .23 DP (4)	Ø.1865/.1875 x .23 DP (4)	Ø.1865/.1875 x .23 DP (2)	Ø.1865/.1875 x .23 DP (2)
mm	Ø4.737/4.763 x 5.8 DP (4)	Ø4.737/4.763 x 5.8 DP (4)	Ø4.737/4.763 x 5.8 DP (2)	Ø4.737/4.763 x 5.8 DP (2)
I	1.53	1.56	1.52	1.56
mm	38.9	39.6	38.6	39.6
J	2.63	2.38	2.07	2.95
mm	66.8	60.5	52.6	74.9
K	Ø2.625 BC	Ø3.875 BC	Ø2.625 BC	Ø3.875 BC
mm	Ø66.68 BC	Ø98.43 BC	Ø66.68 BC	Ø98.43 BC
L	Ø1.504	Ø2.879	Ø1.504	Ø2.879
mm	Ø38.2	Ø73.13	Ø38.2	Ø73.13
M	#10-24 x .75 DP (4)	#10-24 x .75 DP (4)	M5x0.8 x .41 (4)	M5x0.8 x .41 (4)
mm	#10-24 x 19.1 DP (4)	#10-24 x 19.1 DP (4)	M5x0.8 x 10.4 (4)	M5x0.8 x 10.4 (4)
N	2.63	3.75	2.35	3.75
mm	66.8	95.3	59.7	95.3
O	2.63	3.95	2.35	3.95
mm	66.8	100.3	59.7	100.3

S-SOLID BEARING AND P-PROFILED RAIL IN-LINE MOTOR MOUNTING

MXE50

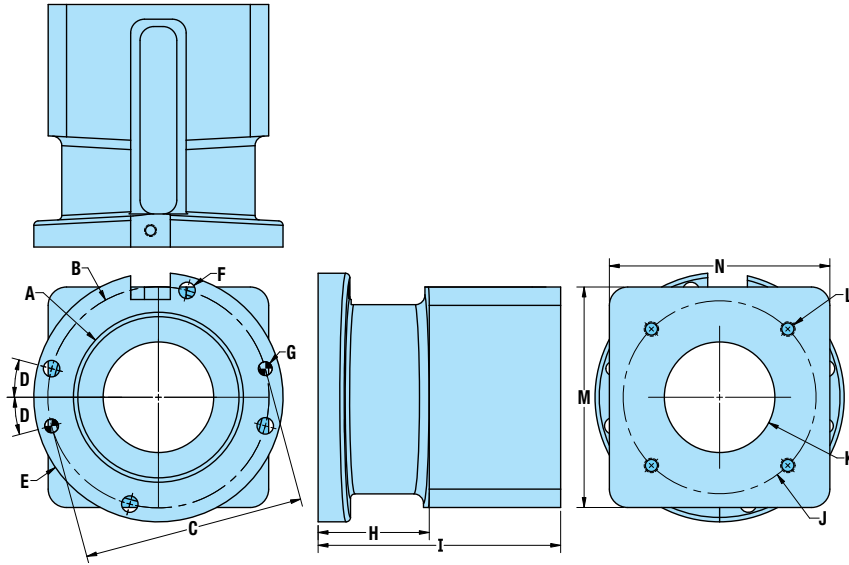

	23 Frame	34 Frame, GH3x	MRS2x	MRS3x	GH2x
A	Ø2.31	Ø2.31	Ø2.31	Ø2.31	Ø2.31
mm	Ø58.7	Ø58.7	Ø58.7	Ø58.7	Ø58.7
B	Ø3.010 BC	Ø3.010 BC	Ø3.010 BC	Ø3.010 BC	Ø3.010 BC
mm	Ø76.45 BC	Ø76.45 BC	Ø76.45 BC	Ø76.45 BC	Ø76.45 BC
C	3.010	3.010	3.010	3.010	3.010
mm	76.45	76.45	76.45	76.45	76.45
D	15°	15°	15°	15°	15°
mm	15°	15°	15°	15°	15°
E	Ø3.390	Ø3.390	Ø3.390	Ø3.390	Ø3.390
mm	Ø86.11	Ø86.11	Ø86.11	Ø86.11	Ø86.11
F	Ø.22 THRU (4)	Ø.22 THRU (4)	Ø.22 THRU (4)	Ø.22 THRU (4)	Ø.22 THRU (4)
mm	Ø5.6 THRU (4)	Ø5.6 THRU (4)	Ø5.6 THRU (4)	Ø5.6 THRU (4)	Ø5.6 THRU (4)
G	.1865/.1875 x .23 DP (2)	.1865/.1875 x .23 DP (2)	.1865/.1875 x .23 DP (2)	.1865/.1875 x .23 DP (2)	.1865/.1875 x .23 DP (2)
mm	4.737/4.763 x 5.8 DP (2)	4.737/4.763 x 5.8 DP (2)	4.737/4.763 x 5.8 DP (2)	4.737/4.763 x 5.8 DP (2)	4.737/4.763 x 5.8 DP (2)
H	1.50	1.50	1.50	1.50	1.50
mm	38.1	38.1	38.1	38.1	38.1
I	3.30	3.05	2.77	3.24	3.05
mm	83.8	77.5	70.4	82.3	77.5
J	Ø2.625 BC	Ø3.875 BC	Ø2.625 BC	Ø3.875 BC	Ø2.625 BC
mm	Ø66.68 BC	Ø98.43 BC	Ø66.68 BC	Ø98.43 BC	Ø66.68 BC
K	Ø1.504	Ø2.880	Ø1.504	Ø2.880	Ø1.504
mm	Ø38.20	Ø73.15	Ø38.20	Ø73.15	Ø38.20
L	M5x0.8 x .75 DP	M5x0.8 x .75 DP	M5x0.8 x .40 DP	M5x0.8 x .51 DP	M5x0.8 x .75 DP
mm	M5x0.8 x 19.1 DP	M5x0.8 x 19.1 DP	M5x0.8 x 10.2 DP	M5x0.8 x 13.0 DP	M5x0.8 x 19.1 DP
M	3.00	3.95	2.69	3.95	3.00
mm	76.2	100.2	68.3	100.2	76.2
N	3.00	3.75	2.69	3.75	3.00
mm	76.2	95.3	68.3	95.3	76.2

S-SOLID BEARING AND P-PROFILED RAIL IN-LINE MOTOR MOUNTING

MXE63

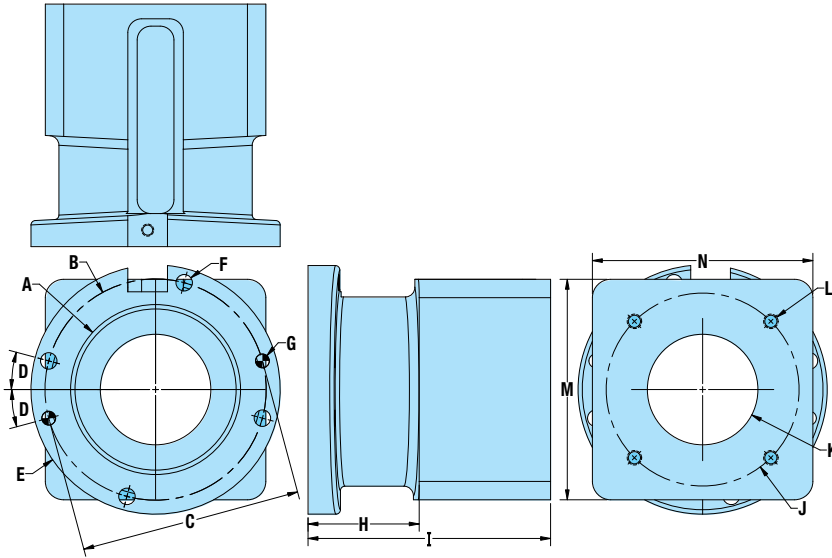

	23 Frame, GH2x	34 Frame, MRS3x	56 Frame, GH3x
A	Ø2.31	Ø2.31	Ø2.31
mm	Ø58.7	Ø58.7	Ø58.7
B	Ø3.010 BC	Ø3.010 BC	Ø3.010 BC
mm	Ø76.45 BC	Ø76.45 BC	Ø76.45 BC
C	3.010	3.010	3.010
mm	76.45	76.45	76.45
D	15°	15°	15°
mm	15°	15°	15°
E	Ø3.390	Ø3.390	Ø3.390
mm	Ø86.11	Ø86.11	Ø86.11
F	Ø.22 THRU (4)	Ø.22 THRU (4)	Ø.22 THRU (4)
mm	Ø5.6 THRU (4)	Ø5.6 THRU (4)	Ø5.6 THRU (4)
G	.1865/.1875 x .23 DP (2)	.1865/.1875 x .23 DP (2)	.1865/.1875 x .23 DP (2)
mm	4.737/4.763 x 5.8 DP (2)	4.737/4.763 x 5.8 DP (2)	4.737/4.763 x 5.8 DP (2)
H	1.50	1.50	1.50
mm	38.1	38.1	38.1
I	3.30	3.24	3.83
mm	83.8	82.3	97.3
J	Ø2.625 BC	Ø3.875 BC	Ø3.875 BC
mm	Ø66.68 BC	Ø98.43 BC	Ø98.43 BC
K	Ø1.504	Ø2.880	Ø2.880
mm	Ø38.20	Ø73.15	Ø73.15
L	M5x0.8 x .75 DP	M5x0.8 x .51 DP	M5x0.8 x .75 DP
mm	M5x0.8 x 19.1 DP	M5x0.8 x 13.0 DP	M5x0.8 x 19.1 DP
M	3.00	3.95	3.95
mm	76.2	100.2	100.2
N	3.00	3.75	3.75
mm	76.2	95.3	95.3

S-SOLID BEARING REVERSE PARALLEL MOTOR MOUNTING DIMENSIONS

MXE16S & MXE25S

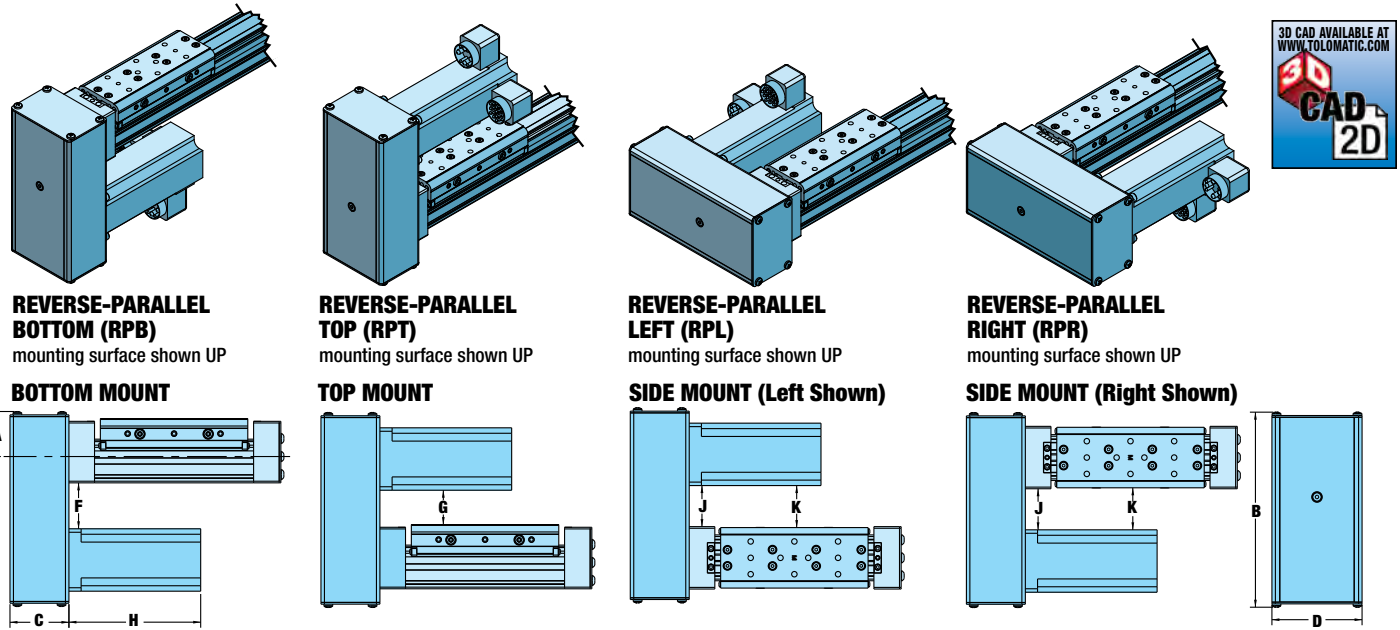

ACTUATOR	MOTOR	WEIGHT OF REDUCTION DRIVE				REDUCTION INERTIA AT MOTOR SHAFT			
		1:1		2:1		1:1		2:1	
		lbs	kg	lbs	kg	lb-in ²	kg-cm ²	lb-in ²	kg-cm ²
MXE16	BRUSHLESS 17 FRAME	0.55	0.25	0.58	0.27	0.001	0.0029	0.002	0.0059
MXE25	BRUSHLESS ALL FRAME SIZES	2.06	0.93	2.06	0.93	0.087	0.2559	0.112	0.3291
MXE25	MRS STEPPER 23-FRAME	1.92	0.87	1.92	0.87	0.022	0.064	0.046	0.135
MXE25	MRS STEPPER 34-FRAME	2.34	1.06	2.34	1.06	0.025	0.073	0.050	0.146

REDUCTION EFFICIENCY: 0.95

	MOTOR	A		B		C		D		F		G		H		J		K	
		in.	mm	in.	mm	in.	mm	in.	mm	in.	mm	in.	mm	in.	mm	in.	mm	in.	mm
BRUSHLESS	16																		
	17 Frm.	0.88	22.2	4.59	116.6	0.72	18.3	1.94	49.3	1.18	30.0	1.00	25.4	4.65	118.1	1.18	30.0	-	-
	23 Frm.	1.44	36.6	6.96	176.8	2.13	54.1	3.25	82.6	1.60	40.6	1.27	32.3	4.75	120.7	1.45	36.8	1.48	37.6
	23 Frm.	1.44	36.6	6.96	176.8	2.13	54.1	3.25	82.6	1.60	40.6	1.27	32.3	5.75	146.1	1.45	36.8	1.48	37.6
	23 Frm.	1.44	36.6	6.96	176.8	2.13	54.1	3.25	82.6	1.60	40.6	1.27	32.3	6.75	171.5	1.45	36.8	1.48	37.6
STEPPER	MXE25																		
	MRS21	1.44	36.6	6.96	176.8	2.13	54.1	3.25	82.6	1.60	40.6	1.27	32.3	1.71	43.4	1.45	36.8	1.48	37.6
	MRS22	1.44	36.6	6.96	176.8	2.13	54.1	3.25	82.6	1.60	40.6	1.27	32.3	2.19	55.6	1.45	36.8	1.48	37.6
	MRS23	1.44	36.6	6.96	176.8	2.13	54.1	3.25	82.6	1.60	40.6	1.27	32.3	3.05	77.5	1.45	36.8	1.48	37.6
	MRS31	1.96	49.8	7.47	189.7	2.38	60.5	4.00	101.6	1.02	25.9	0.69	17.5	3.11	79.0	0.87	22.1	0.9	22.9
	MRS32	1.96	49.8	7.47	189.7	2.38	60.5	4.00	101.6	1.02	25.9	0.69	17.5	4.63	117.6	0.87	22.1	0.9	22.9
MRS33	1.96	49.8	7.47	189.7	2.38	60.5	4.00	101.6	1.02	25.9	0.69	17.5	6.14	156.0	0.87	22.1	0.9	22.9	

S-SOLID BEARING REVERSE PARALLEL MOTOR MOUNTING DIMENSIONS

MXE32S

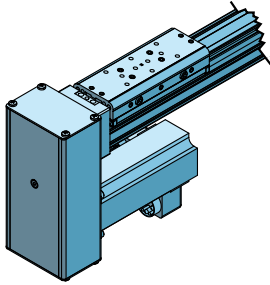

REVERSE-PARALLEL BOTTOM (RPB)
 mounting surface shown UP

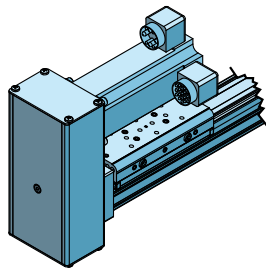

REVERSE-PARALLEL TOP (RPT)
 mounting surface shown UP

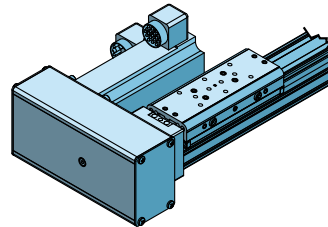

REVERSE-PARALLEL LEFT (RPL)
 mounting surface shown UP

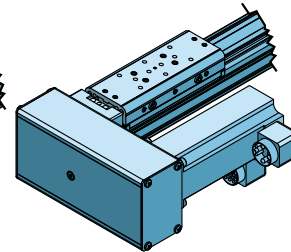

REVERSE-PARALLEL RIGHT (RPR)
 mounting surface shown UP

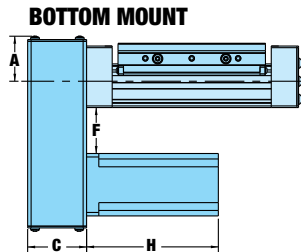

BOTTOM MOUNT

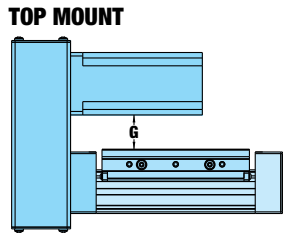

TOP MOUNT

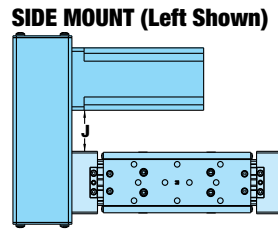

SIDE MOUNT (Left Shown)

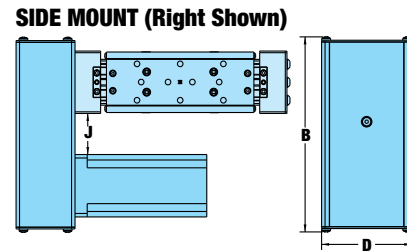

SIDE MOUNT (Right Shown)

	WEIGHT OF REDUCTION DRIVE				REDUCTION INERTIA AT MOTOR SHAFT			
	1:1		2:1		1:1		2:1	
MOTOR	lbs	kg	lbs	kg	lb-in ²	kg-cm ²	lb-in ²	kg-cm ²
BRUSHLESS ALL FRAME SIZES	2.06	0.93	2.06	0.93	0.087	0.2559	0.112	0.3291
MRS STEPPER 23-FRAME	1.92	0.87	1.92	0.87	0.022	0.064	0.046	0.135
MRS STEPPER 34-FRAME	2.34	1.06	2.34	1.06	0.025	0.073	0.050	0.146

REDUCTION EFFICIENCY: 0.95

	A		B		C		D		F		G		H		J		
	in.	mm	in.	mm	in.	mm	in.	mm	in.	mm	in.	mm	in.	mm	in.	mm	
BRUSHLESS	23 Frm.	1.44	36.6	6.96	176.8	2.13	54.1	3.25	82.6	1.40	35.6	0.75	19.1	4.75	120.7	1.18	30.0
	23 Frm.	1.44	36.6	6.96	176.8	2.13	54.1	3.25	82.6	1.40	35.6	0.75	19.1	5.75	146.1	1.18	30.0
	23 Frm.	1.44	36.6	6.96	176.8	2.13	54.1	3.25	82.6	1.40	35.6	0.75	19.1	6.75	171.5	1.18	30.0
	23 Frm.	1.44	36.6	6.96	176.8	2.13	54.1	3.25	82.6	1.40	35.6	0.75	19.1	7.75	196.9	1.18	30.0
STEPPER	MRS21	1.44	36.6	6.96	176.8	2.13	54.1	3.25	82.6	1.40	35.6	0.75	19.1	1.71	43.4	1.18	30.0
	MRS22	1.44	36.6	6.96	176.8	2.13	54.1	3.25	82.6	1.40	35.6	0.75	19.1	2.19	55.6	1.18	30.0
	MRS23	1.44	36.6	6.96	176.8	2.13	54.1	3.25	82.6	1.40	35.6	0.75	19.1	3.05	77.5	1.18	30.0
	MRS31	1.96	49.8	7.47	189.7	2.38	60.5	4.00	101.6	0.82	20.8	0.17	4.3	3.11	79.0	0.6	15.2
	MRS32	1.96	49.8	7.47	189.7	2.38	60.5	4.00	101.6	0.82	20.8	0.17	4.3	4.63	117.6	0.6	15.2
	MRS33	1.96	49.8	7.47	189.7	2.38	60.5	4.00	101.6	0.82	20.8	0.17	4.3	6.14	156.0	0.6	15.2

S-SOLID BEARING REVERSE PARALLEL MOTOR MOUNTING DIMENSIONS

MXE40S

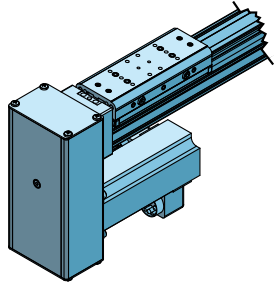

REVERSE-PARALLEL BOTTOM (RPB)
 mounting surface shown UP

BOTTOM MOUNT

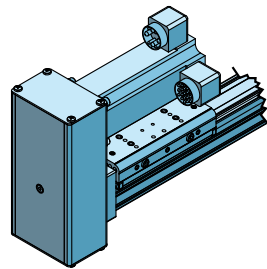
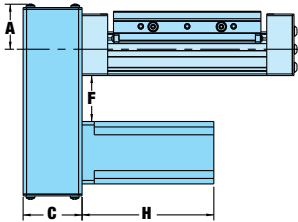

REVERSE-PARALLEL TOP (RPT)
 mounting surface shown UP

TOP MOUNT

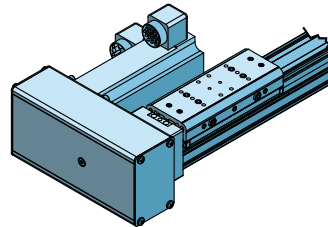
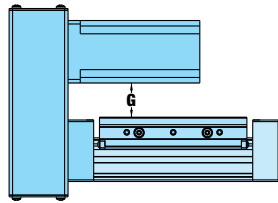

REVERSE-PARALLEL LEFT (RPL)
 mounting surface shown UP

SIDE MOUNT (Left Shown)

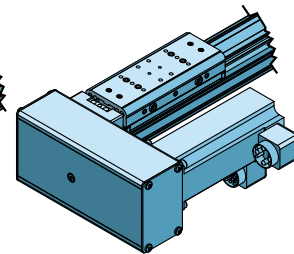
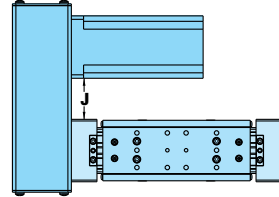

REVERSE-PARALLEL RIGHT (RPR)
 mounting surface shown UP

SIDE MOUNT (Right Shown)

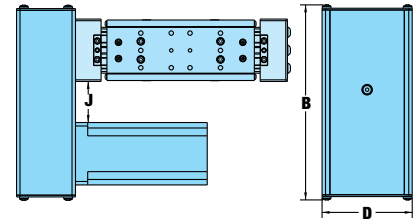

MOTOR	WEIGHT OF REDUCTION DRIVE				REDUCTION INERTIA AT MOTOR SHAFT			
	1:1		2:1		1:1		2:1	
	lbs	kg	lbs	kg	lb-in ²	kg-cm ²	lb-in ²	kg-cm ²
BRUSHLESS ALL FRAME SIZES	2.17	0.98	2.40	1.09	0.070	0.2043	0.095	0.2767
MRS STEPPER 23-FRAME	2.03	0.92	2.26	1.03	0.022	0.064	0.054	0.159
MRS STEPPER 34-FRAME	2.49	1.13	2.72	1.23	0.025	0.073	0.058	0.168

REDUCTION EFFICIENCY: 0.95

	A		B		C		D		F		G		H		J		
	in.	mm	in.	mm	in.	mm	in.	mm	in.	mm	in.	mm	in.	mm	in.	mm	
BRUSHLESS	23 Frm.	1.44	36.6	7.46	189.5	2.13	54.1	3.25	82.6	1.57	39.9	1.13	28.7	4.75	120.7	1.37	34.8
	23 Frm.	1.44	36.6	7.46	189.5	2.13	54.1	3.25	82.6	1.57	39.9	1.13	28.7	5.75	146.1	1.37	34.8
	23 Frm.	1.44	36.6	7.46	189.5	2.13	54.1	3.25	82.6	1.57	39.9	1.13	28.7	6.75	171.5	1.37	34.8
	23 Frm.	1.44	36.6	7.46	189.5	2.13	54.1	3.25	82.6	1.57	39.9	1.13	28.7	7.75	196.9	1.37	34.8
	34 Frm.	2.12	53.8	8.14	206.8	2.38	60.5	4.00	101.6	0.92	23.4	0.48	12.2	6.11	155.2	0.72	18.3
	34 Frm.	2.12	53.8	8.14	206.8	2.38	60.5	4.00	101.6	0.92	23.4	0.48	12.2	7.36	186.9	0.72	18.3
STEPPER	MRS21	1.44	36.6	7.46	189.5	2.13	54.1	3.25	82.6	1.57	39.9	1.13	28.7	1.71	43.4	1.37	34.8
	MRS22	1.44	36.6	7.46	189.5	2.13	54.1	3.25	82.6	1.57	39.9	1.13	28.7	2.19	55.6	1.37	34.8
	MRS23	1.44	36.6	7.46	189.5	2.13	54.1	3.25	82.6	1.57	39.9	1.13	28.7	3.05	77.5	1.37	34.8
	MRS31	2.12	53.8	8.14	206.8	2.38	60.5	4.00	101.6	0.99	25.1	0.55	14.0	3.11	79.0	0.79	22.1
	MRS32	2.12	53.8	8.14	206.8	2.38	60.5	4.00	101.6	0.99	25.1	0.55	14.0	4.63	117.6	0.79	22.1
	MRS33	2.12	53.8	8.14	206.8	2.38	60.5	4.00	101.6	0.99	25.1	0.55	14.0	6.14	156.0	0.79	22.1

S-SOLID BEARING REVERSE PARALLEL MOTOR MOUNTING DIMENSIONS

MXE50S

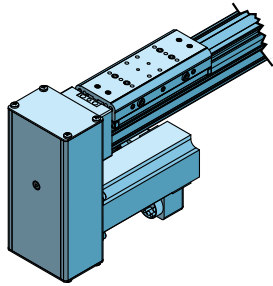

REVERSE-PARALLEL BOTTOM (RPB)
 mounting surface shown UP

BOTTOM MOUNT

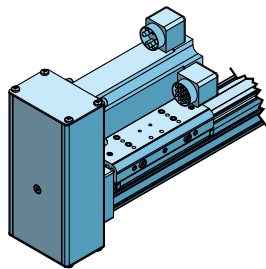
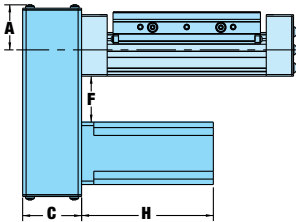

REVERSE-PARALLEL TOP (RPT)
 mounting surface shown UP

TOP MOUNT

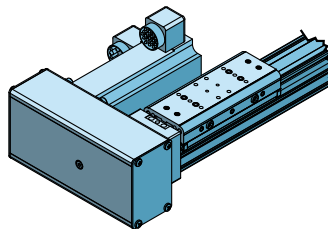
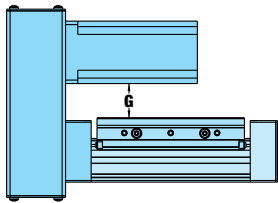

REVERSE-PARALLEL LEFT (RPL)
 mounting surface shown UP

SIDE MOUNT (Left Shown)

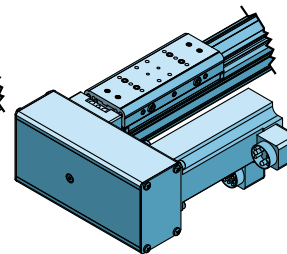
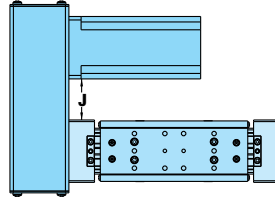

REVERSE-PARALLEL RIGHT (RPR)
 mounting surface shown UP

SIDE MOUNT (Right Shown)

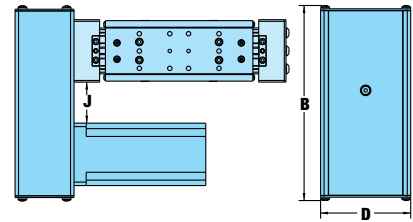

	WEIGHT OF REDUCTION DRIVE				REDUCTION INERTIA AT MOTOR SHAFT			
	1:1		2:1		1:1		2:1	
MOTOR	lbs	kg	lbs	kg	lb-in ²	kg-cm ²	lb-in ²	kg-cm ²
BRUSHLESS 23-FRAME	3.49	1.58	4.41	2.00	0.090	0.2634	0.254	0.7433
BRUSHLESS 34-FRAME	3.96	1.80	4.86	2.21	0.090	0.2634	0.254	0.7433
MRS STEPPER 23-FRAME	3.49	1.58	4.41	2.00	0.090	0.2634	0.254	0.7433
MRS STEPPER 34-FRAME	3.96	1.80	4.86	2.21	0.090	0.2634	0.254	0.7433

REDUCTION EFFICIENCY: 0.95

	A		B		C		D		F		G		H		J		
	in.	mm	in.	mm	in.	mm	in.	mm	in.	mm	in.	mm	in.	mm	in.	mm	
BRUSHLESS	23 Frm.	2.51	63.8	9.39	238.5	2.38	60.5	4.00	101.6	2.32	58.9	1.52	38.6	4.75	120.7	2.41	61.2
	23 Frm.	2.51	63.8	9.39	238.5	2.38	60.5	4.00	101.6	2.32	58.9	1.52	38.6	5.75	146.1	2.41	61.2
	23 Frm.	2.51	63.8	9.39	238.5	2.38	60.5	4.00	101.6	2.32	58.9	1.52	38.6	6.75	171.5	2.41	61.2
	23 Frm.	2.51	63.8	9.39	238.5	2.38	60.5	4.00	101.6	2.32	58.9	1.52	38.6	7.75	196.9	2.41	61.2
	34 Frm.	2.51	63.8	9.39	238.5	2.38	60.5	4.00	101.6	1.66	42.2	0.86	21.8	6.11	155.2	1.75	44.5
	34 Frm.	2.51	63.8	9.39	238.5	2.38	60.5	4.00	101.6	1.66	42.2	0.86	21.8	7.36	186.9	1.75	44.5
STEPPER	MRS21	2.51	63.8	9.39	238.5	2.38	60.5	4.00	101.6	2.32	58.9	1.52	38.6	1.71	43.4	2.41	61.2
	MRS22	2.51	63.8	9.39	238.5	2.38	60.5	4.00	101.6	2.32	58.9	1.52	38.6	2.19	55.6	2.41	61.2
	MRS23	2.51	63.8	9.39	238.5	2.38	60.5	4.00	101.6	2.32	58.9	1.52	38.6	3.05	77.5	2.41	61.2
	MRS31	2.51	63.8	9.39	238.5	2.38	60.5	4.00	101.6	1.66	42.2	0.86	21.8	3.11	79.0	1.75	44.5
	MRS32	2.51	63.8	9.39	238.5	2.38	60.5	4.00	101.6	1.66	42.2	0.86	21.8	4.63	117.6	1.75	44.5
	MRS33	2.51	63.8	9.39	238.5	2.38	60.5	4.00	101.6	1.66	42.2	0.86	21.8	6.14	156.0	1.75	44.5

S-SOLID BEARING REVERSE PARALLEL MOTOR MOUNTING DIMENSIONS

MXE63S

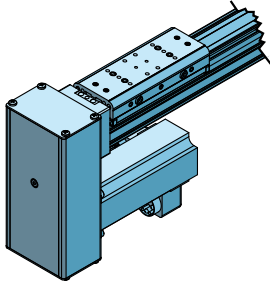

REVERSE-PARALLEL BOTTOM (RPB)
 mounting surface shown UP

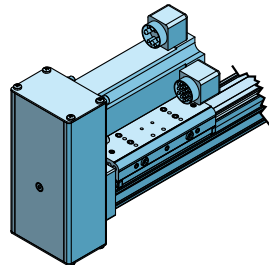

REVERSE-PARALLEL TOP (RPT)
 mounting surface shown UP

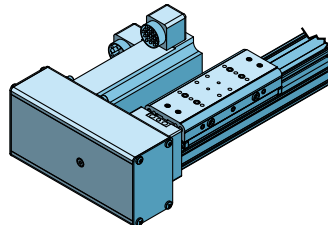

REVERSE-PARALLEL LEFT (RPL)
 mounting surface shown UP

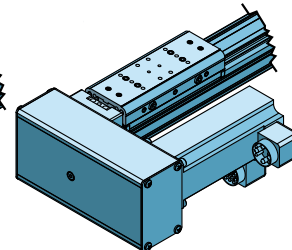

REVERSE-PARALLEL RIGHT (RPR)
 mounting surface shown UP

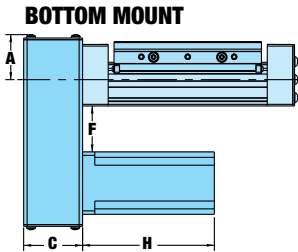

BOTTOM MOUNT

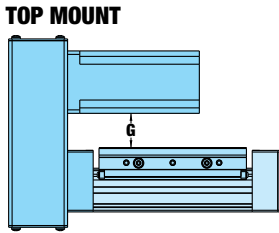

TOP MOUNT

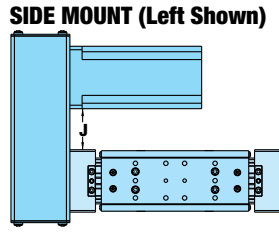

SIDE MOUNT (Left Shown)

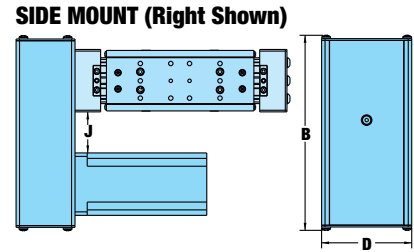

SIDE MOUNT (Right Shown)

	WEIGHT OF REDUCTION DRIVE				REDUCTION INERTIA AT MOTOR SHAFT			
	1:1		2:1		1:1		2:1	
MOTOR	lbs	kg	lbs	kg	lb-in ²	kg-cm ²	lb-in ²	kg-cm ²
BRUSHLESS 23-FRAME	3.49	1.58	4.41	2.00	0.090	0.2634	0.254	0.7433
BRUSHLESS 34-FRAME	3.94	1.79	4.84	2.19	0.087	0.2546	0.251	0.7345
BRUSHLESS 56-FRAME	4.20	1.91	5.10	2.31	0.087	0.2546	0.251	0.7345
MRS STEPPER 34-FRAME	3.96	1.80	4.86	2.21	0.090	0.2634	0.254	0.7433

REDUCTION EFFICIENCY: 0.95

	A		B		C		D		F		G		H		J		
	in.	mm	in.	mm	in.	mm	in.	mm	in.	mm	in.	mm	in.	mm	in.	mm	
BRUSHLESS	23 Frm.	2.19	55.6	9.23	234.4	2.59	65.8	5.00	127.0	0.95	24.1	1.85	47.0	4.75	120.7	1.98	50.3
	23 Frm.	2.19	55.6	9.23	234.4	2.59	65.8	5.00	127.0	0.95	24.1	1.85	47.0	5.75	146.1	1.98	50.3
	23 Frm.	2.19	55.6	9.23	234.4	2.59	65.8	5.00	127.0	0.95	24.1	1.85	47.0	6.75	171.5	1.98	50.3
	23 Frm.	2.19	55.6	9.23	234.4	2.59	65.8	5.00	127.0	0.95	24.1	1.85	47.0	7.75	196.9	1.98	50.3
	34 Frm.	2.19	55.6	10.80	275.0	2.59	65.8	5.00	127.0	2.33	59.2	1.43	36.3	6.11	155.2	2.46	62.5
	34 Frm.	2.19	55.6	10.80	275.0	2.59	65.8	5.00	127.0	2.33	59.2	1.43	36.3	7.36	186.9	2.46	62.5
	34 Frm.	2.19	55.6	10.80	275.0	2.59	65.8	5.00	127.0	2.33	59.2	1.43	36.3	8.61	218.7	2.46	62.5
STEPPER	56 Frm.	2.19	55.6	11.60	294.1	2.59	65.8	5.00	127.0	1.72	43.7	0.83	21.1	9.96	253.0	1.86	47.2
	MRS31	2.19	55.6	10.80	275.0	2.59	65.8	5.00	127.0	2.33	59.2	1.43	36.3	3.11	79.0	2.46	62.5
	MRS32	2.19	55.6	10.80	275.0	2.59	65.8	5.00	127.0	2.33	59.2	1.43	36.3	4.63	117.6	2.46	62.5
	MRS33	2.19	55.6	10.80	275.0	2.59	65.8	5.00	127.0	2.33	59.2	1.43	36.3	6.14	156.0	2.46	62.5

P-PROFILED RAIL REVERSE PARALLEL MOTOR MOUNTING DIMENSIONS

MXE16P & MXE25P

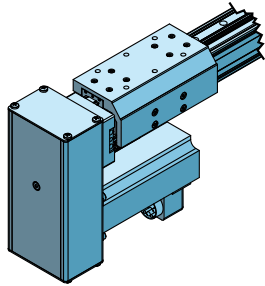

REVERSE-PARALLEL BOTTOM (RPB)
 mounting surface shown UP

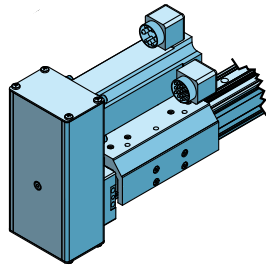

REVERSE-PARALLEL TOP (RPT)
 mounting surface shown UP

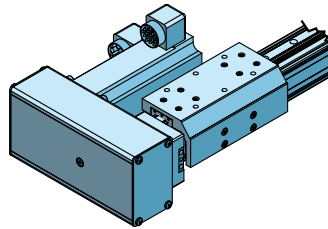

REVERSE-PARALLEL LEFT (RPL)
 mounting surface shown UP

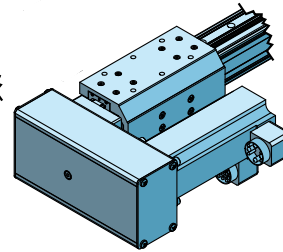

REVERSE-PARALLEL RIGHT (RPR)
 mounting surface shown UP

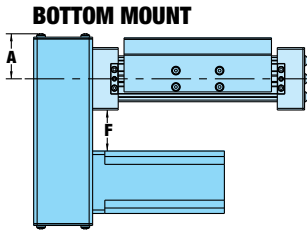

BOTTOM MOUNT

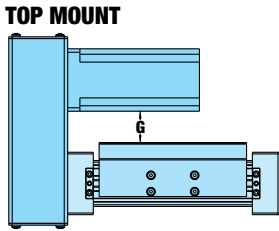

TOP MOUNT

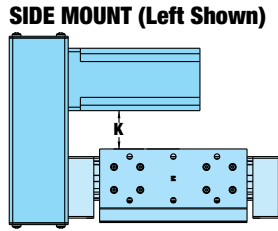

SIDE MOUNT (Left Shown)

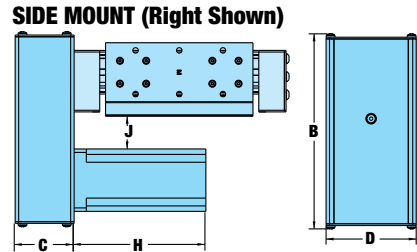

SIDE MOUNT (Right Shown)

ACTUATOR	MOTOR	WEIGHT OF REDUCTION DRIVE				REDUCTION INERTIA AT MOTOR SHAFT			
		1:1		2:1		1:1		2:1	
		lbs	kg	lbs	kg	lb-in ²	kg-cm ²	lb-in ²	kg-cm ²
MXE16	BRUSHLESS 17 FRAME	0.55	0.25	0.58	0.27	0.001	0.0029	0.002	0.0059
MXE25	BRUSHLESS ALL FRAME SIZES	2.06	0.93	2.06	0.93	0.087	0.2559	0.112	0.3291
MXE25	STEPPER 23-FRAME	1.92	0.87	1.92	0.87	0.022	0.064	0.046	0.135
MXE25	STEPPER 34-FRAME	2.34	1.06	2.34	1.06	0.025	0.073	0.050	0.146

REDUCTION EFFICIENCY: 0.95

		A		B		C		D		F		G		H		J		K		
		in.	mm	in.	mm	in.	mm	in.	mm	in.	mm	in.	mm	in.	mm	in.	mm	in.	mm	
BRUSHLESS	16	17 Frm.	0.88	22.2	4.59	116.6	0.72	18.3	1.94	49.3	1.18	30.0	0.85	21.6	4.65	118.1	1.04	26.4	1.19	30.2
		23 Frm.	1.44	36.6	6.96	176.8	2.13	54.1	3.25	82.6	1.48	37.6	1.13	28.7	4.75	120.7	1.18	30.0	1.38	35.1
	MXE25	23 Frm.	1.44	36.6	6.96	176.8	2.13	54.1	3.25	82.6	1.48	37.6	1.13	28.7	5.75	146.1	1.18	30.0	1.38	35.1
		23 Frm.	1.44	36.6	6.96	176.8	2.13	54.1	3.25	82.6	1.48	37.6	1.13	28.7	6.75	171.5	1.18	30.0	1.38	35.1
		23 Frm.	1.44	36.6	6.96	176.8	2.13	54.1	3.25	82.6	1.48	37.6	1.13	28.7	7.75	196.9	1.18	30.0	1.38	35.1
STEPPER	MXE25	MRS21	1.44	36.6	6.96	176.8	2.13	54.1	3.25	82.6	1.48	37.6	1.13	28.7	1.71	43.4	1.18	30.0	1.38	35.1
		MRS22	1.44	36.6	6.96	176.8	2.13	54.1	3.25	82.6	1.48	37.6	1.13	28.7	2.19	55.6	1.18	30.0	1.38	35.1
		MRS23	1.44	36.6	6.96	176.8	2.13	54.1	3.25	82.6	1.48	37.6	1.13	28.7	3.05	77.5	1.18	30.0	1.38	35.1
		MRS31	1.96	49.8	7.47	189.7	2.38	60.5	4.00	101.6	0.90	22.9	0.55	14.0	3.11	79.0	0.66	16.8	0.8	20.3
		MRS32	1.96	49.8	7.47	189.7	2.38	60.5	4.00	101.6	0.90	22.9	0.55	14.0	4.63	117.6	0.66	16.8	0.8	20.3
		MRS33	1.96	49.8	7.47	189.7	2.38	60.5	4.00	101.6	0.90	22.9	0.55	14.0	6.14	156.0	0.66	16.8	0.8	20.3

P-PROFILED RAIL REVERSE PARALLEL MOTOR MOUNTING DIMENSIONS

MXE32P

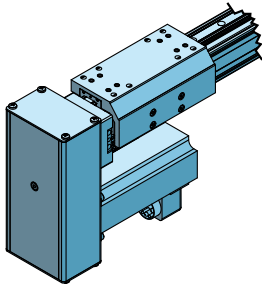

REVERSE-PARALLEL BOTTOM (RPB)
 mounting surface shown UP

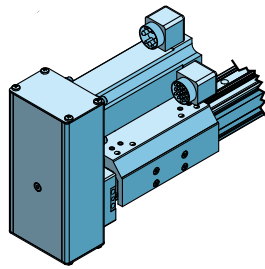

REVERSE-PARALLEL TOP (RPT)
 mounting surface shown UP

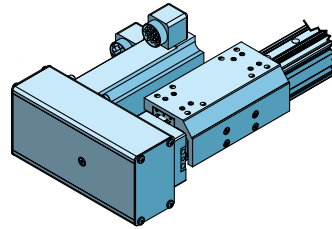

REVERSE-PARALLEL LEFT (RPL)
 mounting surface shown UP

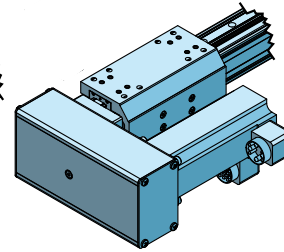

REVERSE-PARALLEL RIGHT (RPR)
 mounting surface shown UP

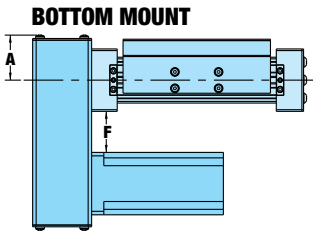

BOTTOM MOUNT

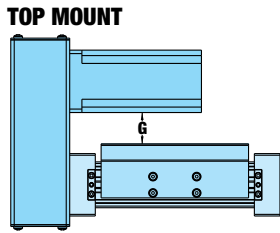

TOP MOUNT

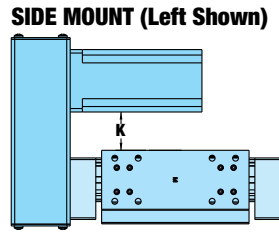

SIDE MOUNT (Left Shown)

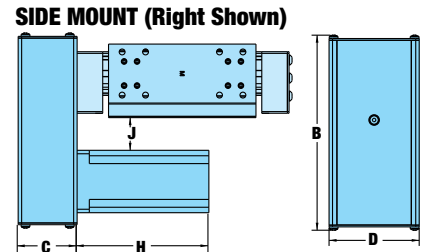

SIDE MOUNT (Right Shown)

	WEIGHT OF REDUCTION DRIVE				REDUCTION INERTIA AT MOTOR SHAFT			
	1:1		2:1		1:1		2:1	
MOTOR	lbs	kg	lbs	kg	lb-in ²	kg-cm ²	lb-in ²	kg-cm ²
BRUSHLESS ALL FRAME SIZES	2.06	0.93	2.06	0.93	0.087	0.2559	0.112	0.3291
MRS STEPPER 23-FRAME	1.92	0.87	1.92	0.87	0.022	0.064	0.046	0.135
MRS STEPPER 34-FRAME	2.34	1.06	2.34	1.06	0.025	0.073	0.050	0.146

REDUCTION EFFICIENCY: 0.95

	A		B		C		D		F		G		H		J		K		
	in.	mm	in.	mm	in.	mm	in.	mm	in.	mm	in.	mm	in.	mm	in.	mm	in.	mm	
BRUSHLESS	23 Frm.	1.44	36.6	6.96	176.8	2.13	54.1	3.25	82.6	1.52	38.6	0.65	16.5	4.75	120.7	0.76	19.3	1.20	30.5
	23 Frm.	1.44	36.6	6.96	176.8	2.13	54.1	3.25	82.6	1.52	38.6	0.65	16.5	5.75	146.1	0.76	19.3	1.20	30.5
	23 Frm.	1.44	36.6	6.96	176.8	2.13	54.1	3.25	82.6	1.52	38.6	0.65	16.5	6.75	171.5	0.76	19.3	1.20	30.5
	23 Frm.	1.44	36.6	6.96	176.8	2.13	54.1	3.25	82.6	1.52	38.6	0.65	16.5	7.75	196.9	0.76	19.3	1.20	30.5
STEPPER	MRS21	1.44	36.6	6.96	176.8	2.13	54.1	3.25	82.6	1.52	38.6	0.65	16.5	1.71	43.4	0.76	19.3	1.20	30.5
	MRS22	1.44	36.6	6.96	176.8	2.13	54.1	3.25	82.6	1.52	38.6	0.65	16.5	2.19	55.6	0.76	19.3	1.20	30.5
	MRS23	1.44	36.6	6.96	176.8	2.13	54.1	3.25	82.6	1.52	38.6	0.65	16.5	3.05	77.5	0.76	19.3	1.20	30.5
	MRS31	1.96	49.8	7.47	189.7	2.38	60.5	4.00	101.6	0.94	23.9	0.07	1.8	3.11	79.0	0.18	4.6	0.62	15.7
	MRS32	1.96	49.8	7.47	189.7	2.38	60.5	4.00	101.6	0.94	23.9	0.07	1.8	4.63	117.6	0.18	4.6	0.62	15.7
	MRS33	1.96	49.8	7.47	189.7	2.38	60.5	4.00	101.6	0.94	23.9	0.07	1.8	6.14	156.0	0.18	4.6	0.60	15.7

P-PROFILED RAIL REVERSE PARALLEL MOTOR MOUNTING DIMENSIONS

MXE40P

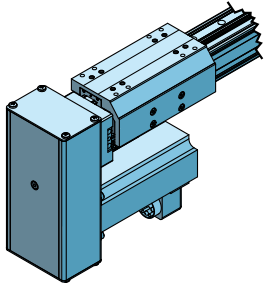

REVERSE-PARALLEL BOTTOM (RPB)

mounting surface shown UP

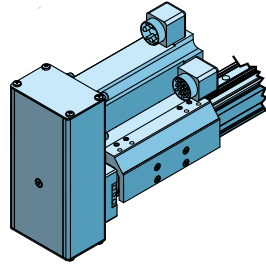

REVERSE-PARALLEL TOP (RPT)

mounting surface shown UP

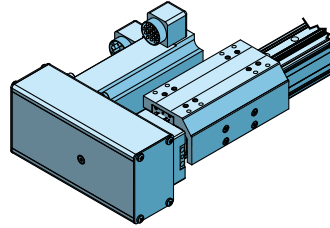

REVERSE-PARALLEL LEFT (RPL)

mounting surface shown UP

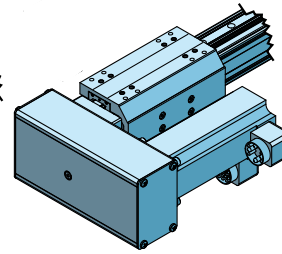

REVERSE-PARALLEL RIGHT (RPR)

mounting surface shown UP

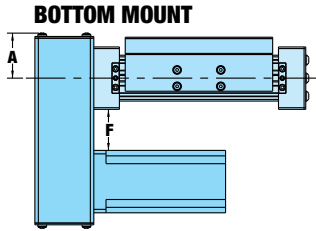

BOTTOM MOUNT

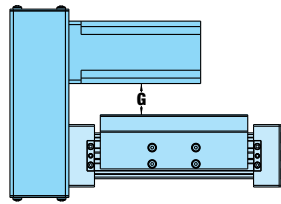

TOP MOUNT

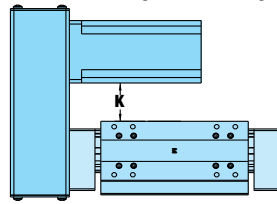

SIDE MOUNT (Left Shown)

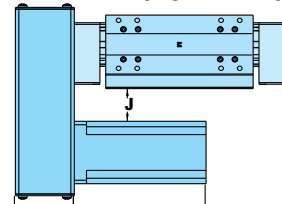

SIDE MOUNT (Right Shown)

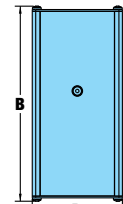

MOTOR	WEIGHT OF REDUCTION DRIVE				REDUCTION INERTIA AT MOTOR SHAFT			
	1:1		2:1		1:1		2:1	
	lbs	kg	lbs	kg	lb-in ²	kg-cm ²	lb-in ²	kg-cm ²
BRUSHLESS ALL FRAME SIZES	2.17	0.98	2.40	1.09	0.070	0.2043	0.095	0.2767
MRS STEPPER 23-FRAME	2.03	0.92	2.26	1.03	0.022	0.064	0.054	0.159
MRS STEPPER 34-FRAME	2.49	1.13	2.72	1.23	0.025	0.073	0.058	0.168

REDUCTION EFFICIENCY: 0.95

	MOTOR	A		B		C		D		F		G		H		J		K	
		in.	mm	in.	mm	in.	mm	in.	mm	in.	mm	in.	mm	in.	mm	in.	mm	in.	mm
BRUSHLESS	23 Frm.	1.44	36.6	7.46	189.5	2.13	54.1	3.25	82.6	1.61	40.9	0.83	21.1	4.75	120.7	1.18	30.0	1.18	30.0
	23 Frm.	1.44	36.6	7.46	189.5	2.13	54.1	3.25	82.6	1.61	40.9	0.83	21.1	5.75	146.1	1.18	30.0	1.18	30.0
	23 Frm.	1.44	36.6	7.46	189.5	2.13	54.1	3.25	82.6	1.61	40.9	0.83	21.1	6.75	171.5	1.18	30.0	1.18	30.0
	23 Frm.	1.44	36.6	7.46	189.5	2.13	54.1	3.25	82.6	1.61	40.9	0.83	21.1	7.75	196.9	1.18	30.0	1.18	30.0
	34 Frm.	2.12	53.8	8.14	206.8	2.38	60.5	4.00	101.6	0.96	24.4	0.18	4.6	6.11	155.2	0.53	13.5	0.53	13.5
	34 Frm.	2.12	53.8	8.14	206.8	2.38	60.5	4.00	101.6	0.96	24.4	0.18	4.6	7.36	186.9	0.53	13.5	0.53	13.5
STEPPER	34 Frm.	2.12	53.8	8.14	206.8	2.38	60.5	4.00	101.6	0.96	24.4	0.18	4.6	8.61	218.7	0.53	13.5	0.53	13.5
	MRS21	1.44	36.6	7.46	189.5	2.13	54.1	3.25	82.6	1.61	40.9	0.83	21.1	1.71	43.4	1.18	30.0	1.18	30.0
	MRS22	1.44	36.6	7.46	189.5	2.13	54.1	3.25	82.6	1.61	40.9	0.83	21.1	2.19	55.6	1.18	30.0	1.18	30.0
	MRS23	1.44	36.6	7.46	189.5	2.13	54.1	3.25	82.6	1.61	40.9	0.83	21.1	3.05	77.5	1.18	30.0	1.18	30.0
	MRS31	1.96	49.8	8.14	206.8	2.38	60.5	4.00	101.6	1.03	26.2	0.25	6.4	3.11	79.0	0.6	15.2	0.6	15.2
	MRS32	1.96	49.8	8.14	206.8	2.38	60.5	4.00	101.6	1.03	26.2	0.25	6.4	4.63	117.6	0.6	15.2	0.6	15.2
	MRS33	1.96	49.8	8.14	206.8	2.38	60.5	4.00	101.6	1.03	26.2	0.25	6.4	6.14	156.0	0.6	15.2	0.6	15.2

P-PROFILED RAIL REVERSE PARALLEL MOTOR MOUNTING DIMENSIONS

MXE50P

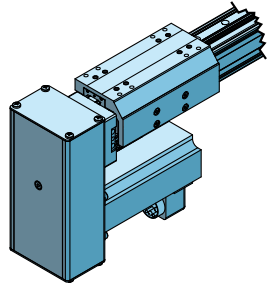

REVERSE-PARALLEL BOTTOM (RPB)
 mounting surface shown UP

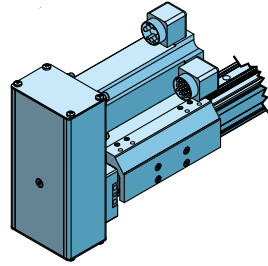

REVERSE-PARALLEL TOP (RPT)
 mounting surface shown UP

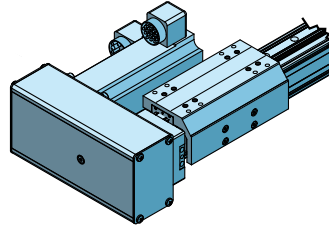

REVERSE-PARALLEL LEFT (RPL)
 mounting surface shown UP

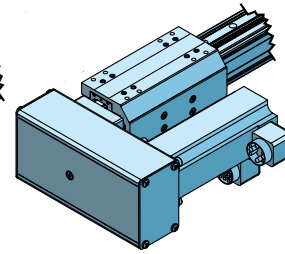

REVERSE-PARALLEL RIGHT (RPR)
 mounting surface shown UP

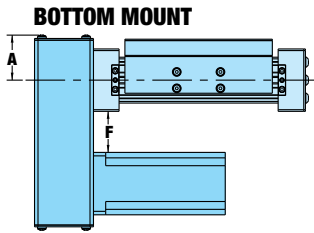

BOTTOM MOUNT

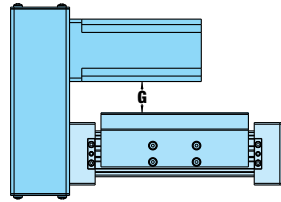

TOP MOUNT

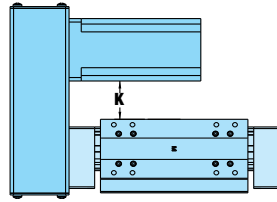

SIDE MOUNT (Left Shown)

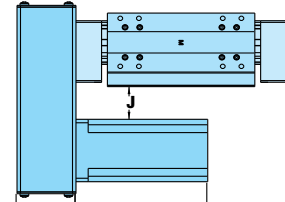

SIDE MOUNT (Right Shown)

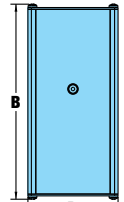

MOTOR	WEIGHT OF REDUCTION DRIVE				REDUCTION INERTIA AT MOTOR SHAFT			
	1:1		2:1		1:1		2:1	
	lbs	kg	lbs	kg	lb-in ²	kg-cm ²	lb-in ²	kg-cm ²
BRUSHLESS 23-FRAME	3.49	1.58	4.41	2.00	0.090	0.2634	0.254	0.7433
BRUSHLESS 34-FRAME	3.96	1.80	4.86	2.21	0.090	0.2634	0.254	0.7433
MRS STEPPER 23-FRAME	3.49	1.58	4.41	2.00	0.090	0.2634	0.254	0.7433
MRS STEPPER 34-FRAME	3.96	1.80	4.86	2.21	0.090	0.2634	0.254	0.7433

REDUCTION EFFICIENCY: 0.95

	MOTOR	A		B		C		D		F		G		H		J		K	
		in.	mm	in.	mm	in.	mm	in.	mm	in.	mm	in.	mm	in.	mm	in.	mm	in.	mm
BRUSHLESS	23 Frm.	2.51	63.8	9.39	238.5	2.38	60.5	4.00	101.6	2.41	61.2	0.98	24.9	4.75	120.7	1.62	41.1	2.03	51.6
	23 Frm.	2.51	63.8	9.39	238.5	2.38	60.5	4.00	101.6	2.41	61.2	0.98	24.9	5.75	146.1	1.62	41.1	2.03	51.6
	23 Frm.	2.51	63.8	9.39	238.5	2.38	60.5	4.00	101.6	2.41	61.2	0.98	24.9	6.75	171.5	1.62	41.1	2.03	51.6
	23 Frm.	2.51	63.8	9.39	238.5	2.38	60.5	4.00	101.6	2.41	61.2	0.98	24.9	7.75	196.9	1.62	41.1	2.03	51.6
	31 Frm.	2.51	63.8	9.39	238.5	2.38	60.5	4.00	101.6	1.75	44.5	0.32	8.1	6.11	155.2	0.96	24.4	1.37	34.8
	31 Frm.	2.51	63.8	9.39	238.5	2.38	60.5	4.00	101.6	1.75	44.5	0.32	8.1	7.36	186.9	0.96	24.4	1.37	34.8
STEPPER	MRS21	2.51	63.8	9.39	238.5	2.38	60.5	4.00	101.6	2.41	61.2	0.98	24.9	1.71	43.4	1.62	41.1	2.03	51.6
	MRS22	2.51	63.8	9.39	238.5	2.38	60.5	4.00	101.6	2.41	61.2	0.98	24.9	2.19	55.6	1.62	41.1	2.03	51.6
	MRS23	2.51	63.8	9.39	238.5	2.38	60.5	4.00	101.6	2.41	61.2	0.98	24.9	3.05	77.5	1.62	41.1	2.03	51.6
	MRS31	2.51	63.8	9.39	238.5	2.38	60.5	4.00	101.6	1.75	44.5	0.32	8.1	3.11	79.0	0.96	24.4	1.37	34.8
	MRS32	2.51	63.8	9.39	238.5	2.38	60.5	4.00	101.6	1.75	44.5	0.32	8.1	4.63	117.6	0.96	24.4	1.37	34.8
	MRS33	2.51	63.8	9.39	238.5	2.38	60.5	4.00	101.6	1.75	44.5	0.32	8.1	6.14	156.0	0.96	24.4	1.37	34.8

P-PROFILED RAIL REVERSE PARALLEL MOTOR MOUNTING DIMENSIONS

MXE63P

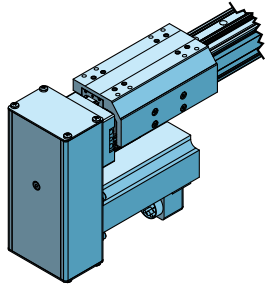

REVERSE-PARALLEL BOTTOM (RPB)
 mounting surface shown UP

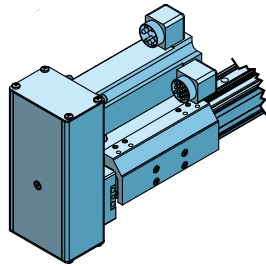

REVERSE-PARALLEL TOP (RPT)
 mounting surface shown UP

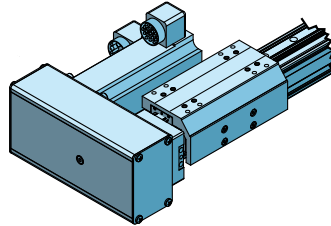

REVERSE-PARALLEL LEFT (RPL)
 mounting surface shown UP

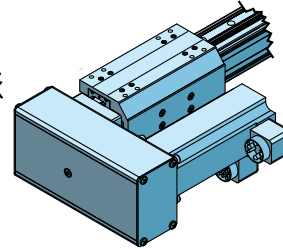

REVERSE-PARALLEL RIGHT (RPR)
 mounting surface shown UP

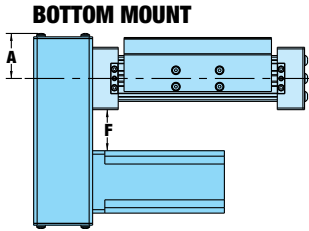

BOTTOM MOUNT

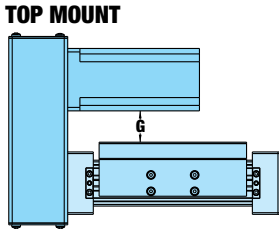

TOP MOUNT

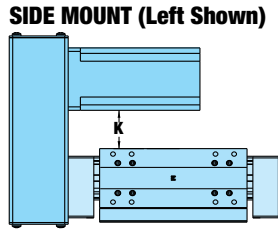

SIDE MOUNT (Left Shown)

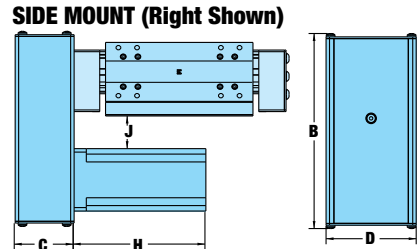

SIDE MOUNT (Right Shown)

MOTOR	WEIGHT OF REDUCTION DRIVE				REDUCTION INERTIA AT MOTOR SHAFT			
	1:1		2:1		1:1		2:1	
	lbs	kg	lbs	kg	lb-in ²	kg-cm ²	lb-in ²	kg-cm ²
BRUSHLESS 23-FRAME	3.49	1.58	4.41	2.00	0.090	0.2634	0.254	0.7433
BRUSHLESS 34-FRAME	3.94	1.79	4.84	2.19	0.087	0.2546	0.251	0.7345
BRUSHLESS 56-FRAME	4.20	1.91	5.10	2.31	0.087	0.2546	0.251	0.7345
MRS STEPPER 34-FRAME	3.96	1.80	4.86	2.21	0.090	0.2634	0.254	0.7433

REDUCTION EFFICIENCY: 0.95

	MOTOR	A		B		C		D		F		G		H		J		K	
		in.	mm	in.	mm	in.	mm	in.	mm	in.	mm	in.	mm	in.	mm	in.	mm	in.	mm
BRUSHLESS	23 Frm.	2.19	55.6	9.23	234.4	2.59	65.8	5.00	127.0	1.98	50.3	0.60	15.2	4.75	120.7	1.10	27.9	1.54	39.1
	23 Frm.	2.19	55.6	9.23	234.4	2.59	65.8	5.00	127.0	1.98	50.3	0.60	15.2	5.75	146.1	1.10	27.9	1.54	39.1
	23 Frm.	2.19	55.6	9.23	234.4	2.59	65.8	5.00	127.0	1.98	50.3	0.60	15.2	6.75	171.5	1.10	27.9	1.54	39.1
	23 Frm.	2.19	55.6	9.23	234.4	2.59	65.8	5.00	127.0	1.98	50.3	0.60	15.2	7.75	196.9	1.10	27.9	1.54	39.1
	34 Frm.	2.19	55.6	10.82	274.8	2.59	65.8	5.00	127.0	2.46	62.5	1.08	27.4	6.11	155.2	1.58	40.1	2.02	51.3
	34 Frm.	2.19	55.6	10.82	274.8	2.59	65.8	5.00	127.0	2.46	62.5	1.08	27.4	7.36	186.9	1.58	40.1	2.02	51.3
	34 Frm.	2.19	55.6	10.82	274.8	2.59	65.8	5.00	127.0	2.46	62.5	1.08	27.4	8.61	218.7	1.58	40.1	2.02	51.3
	56 Frm.	2.19	55.6	11.58	294.1	2.59	65.8	5.00	127.0	1.86	47.2	0.48	12.2	9.96	253.0	0.98	24.9	1.41	35.8
STEPPER	MRS31	2.19	55.6	10.82	274.8	2.59	65.8	5.00	127.0	2.46	62.5	1.08	27.4	3.11	79.0	1.58	40.1	2.02	51.3
	MRS32	2.19	55.6	10.82	274.8	2.59	65.8	5.00	127.0	2.46	62.5	1.08	27.4	4.63	117.6	1.58	40.1	2.02	51.3
	MRS33	2.19	55.6	10.82	274.8	2.59	65.8	5.00	127.0	2.46	62.5	1.08	27.4	6.14	156.0	1.58	40.1	2.02	51.3

SWITCHES

SPECIFICATIONS



MX products offer a wide range of sensing choices. There are 12 switch choices: reed, solid state PNP (sourcing) or solid state NPN (sinking); in normally open or normally closed; with flying leads or quick-disconnect.

Commonly used for end-of-stroke positioning, these switches allow drop-in installation anywhere along the entire actuator length. The one-piece design includes the retained fastening hardware and is designed for any open side or bottom slot on the MX. The internal piston magnet is a standard feature, therefore these switches can be installed in the field at any time.

Switches are used to send digital signals to PLC (programmable logic controller), TTL, CMOS circuit or other controller device. Switches contain reverse polarity protection. Solid state QD cables are shielded; shield should be terminated at flying lead end.



All switches are CE rated and are RoHS compliant. Switches feature bright red or yellow LED signal indicators; solid state switches also have green LED power indicators.

	Order Code	Part Number	Lead	Switching Logic	Power LED	Signal LED	Operating Voltage	**Power Rating (Watts)	Switching Current (mA max.)	Current Consumption	Voltage Drop	Leakage Current	Temp. Range	Shock / Vibration
REED	R Y	8100-9082	5m	SPST Normally Open	—	Red	5 - 240 AC/DC	**10.0	100mA	—	3.0 V max.	—	14 to 158°F [-10 to 70°C]	50 G / 9 G
	R K	8100-9083	QD*											
	N Y	8100-9084	5m	SPST Normally Closed	—	Yellow	5 - 110 AC/DC							
	N K	8100-9085	QD*											
SOLID STATE	T Y	8100-9088	5m	PNP (Sourcing) Normally Open	Green	Yellow	10 - 30 VDC	**3.0	100mA	20 mA @ 24V	2.0 V max.	0.05 mA max.		
	T K	8100-9089	QD*											
	K Y	8100-9090	5m	NPN (Sinking) Normally Open	Green	Red								
	K K	8100-9091	QD*											
	P Y	8100-9092	5m	PNP (Sourcing) Normally Closed	Green	Yellow								
	P K	8100-9093	QD*											
	H Y	8100-9094	5m	NPN (Sinking) Normally Closed	Green	Red								
	H K	8100-9095	QD*											

*QD = Quick-disconnect Enclosure classification IEC 529 IP67 (NEMA 6) CABLES: Robotic grade, oil resistant polyurethane jacket, PVC insulation

▲WARNING:** Do not exceed power rating (Watt = Voltage x Amperage). Permanent damage to sensor will occur.

SWITCHES

WIRING DIAGRAMS

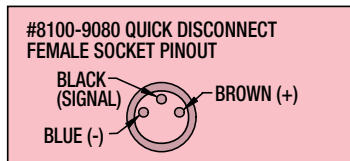
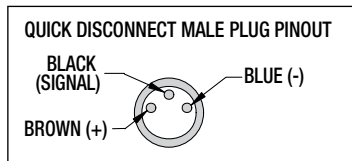
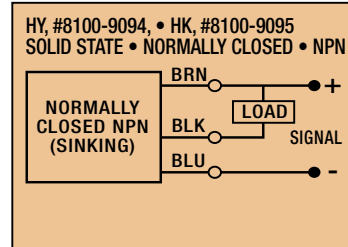
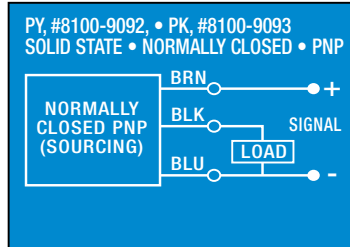
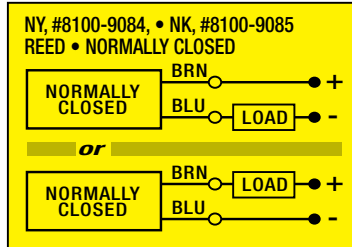
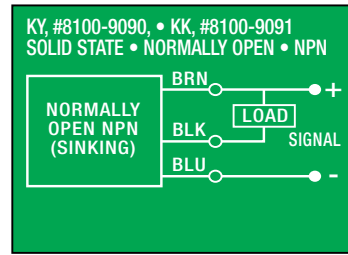
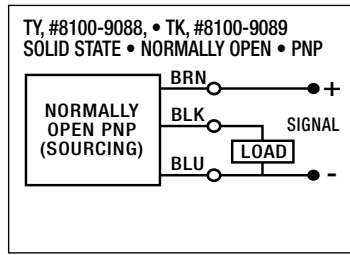
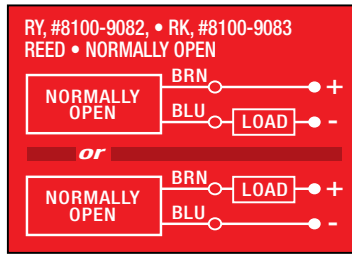

SWITCH INSTALLATION AND REPLACEMENT

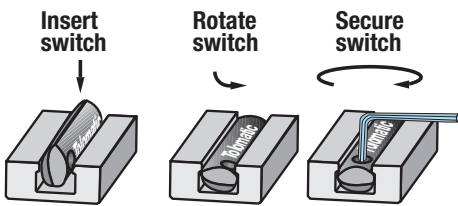

Place switch in side groove on tube at desired location with "Tolomatic" facing outward. While applying light pressure to the switch, rotate the switch halfway into the groove. Maintaining light pressure, rotate the switch in the opposite direction until it is fully inside the groove with "Tolomatic" visible. Re-position the switch to the exact location and lock the switch securely into place by tightening the screw on the switch.

SWITCH DIMENSIONS

[V] - direct connect

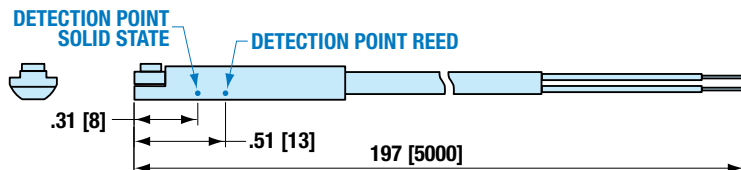

[QD] - QD (Quick-disconnect) switch

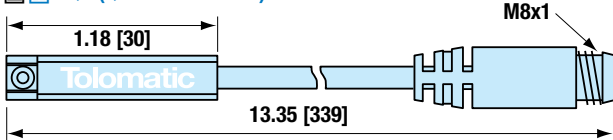

8100-9080 - QD Cable

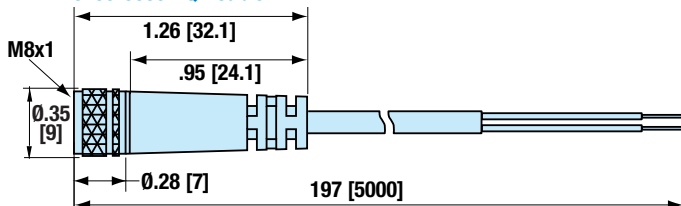

MOUNTING DIMENSIONS

16, 25, 32

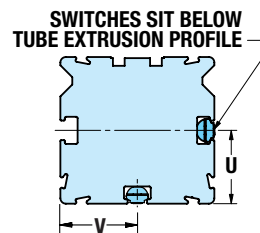

40, 50, 63

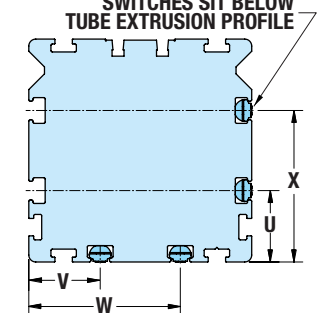

SWITCH MOUNTING

	16	25	32	40	50	63
U	0.31	0.79	1.06	0.81	1.08	1.50
mm	7.9	20.0	27.0	20.5	27.4	38.0
V	0.59	0.83	1.09	0.81	1.08	1.50
mm	15.0	21.0	27.7	20.5	27.4	38.0
W	-	-	-	1.71	2.02	2.44
mm	-	-	-	43.5	51.4	62.0
X	-	-	-	1.71	2.02	2.44
mm	-	-	-	43.5	51.4	62.0

Dimensions in inches [brackets indicate dimensions in millimeters]

COMPILE APPLICATION REQUIREMENTS

APPLICATION DATA WORKSHEET

Fill in known data. Not all information is required for all applications

ORIENTATION

Horizontal Side Horizontal Down Vertical Angled α°

Load attached to carrier OR Load supported by other mechanism

DISTANCE FROM CENTER OF CARRIER TO LOAD CENTER OF GRAVITY

d_x _____
 d_y _____
 d_z _____

inch (U.S. Standard) millimeter (Metric)

STROKE LENGTH _____

inch (S.I.K.) (U.S. Standard) millimeters (S.M.) (Metric)

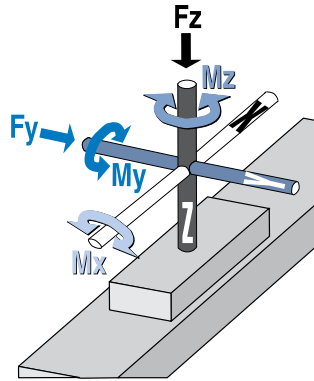

BENDING MOMENTS APPLIED TO CARRIER

M_x _____
 M_y _____
 M_z _____

in.-lbs. (U.S. Standard) N-m (Metric)

PRECISION

Repeatability _____
 inch millimeters

NOTE: If load or force on carrier changes during cycle use the highest numbers for calculations

LOAD _____

lb. (U.S. Standard) kg. (Metric)

FORCES APPLIED TO CARRIER

F_z _____
 F_y _____

lbf. (U.S. Standard) N (Metric)

OPERATING ENVIRONMENT

Temperature, Contamination, etc.

MOVE PROFILE

Move Distance _____
 inch millimeters
 Dwell Time After Move _____
 Max. Speed _____
 in/sec mm/sec

MOVE TIME _____

sec

NO. OF CYCLES _____

per minute per hour

MOTION PROFILE

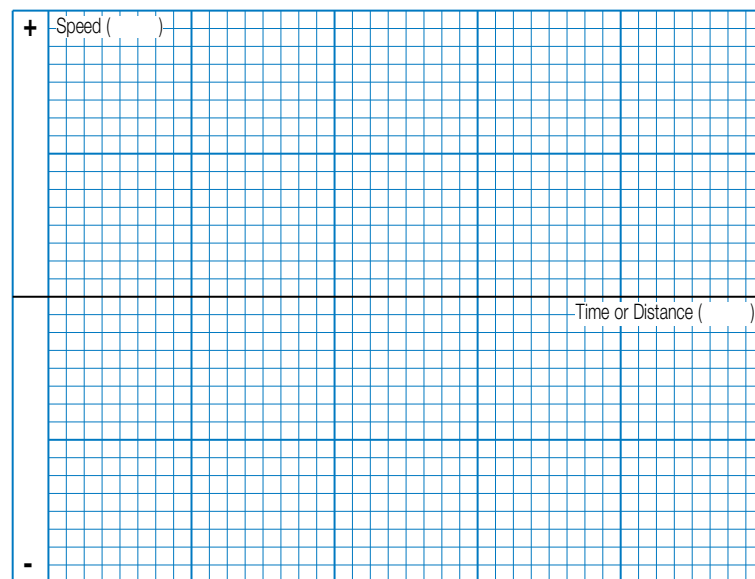

Graph your most demanding cycle, including accel/decel, velocity and dwell times. You may also want to indicate load variations and I/O changes during the cycle. Label axes with proper scale and units.

CONTACT INFORMATION

Name, Phone, Email _____
 Co. Name, Etc. _____

STOP USE THE TOLONATIC SIZING AND SELECTION SOFTWARE AVAILABLE ON-LINE AT www.tolomatic.com OR... CALL TOLONATIC 1-800-328-2174 with the above information. We will provide any assistance needed to determine the proper MX actuator for the job.

FAX 1-763-478-8080

SELECTION GUIDELINES

The process of selecting a load bearing actuator for a given application can be complex. It is highly recommended that you contact Tolomatic or a Tolomatic Distributor for assistance in selecting the best actuator for your application. The following overview of the selection guidelines are for educational purposes only.

1 CHOOSE ACTUATOR BEARING STYLE & SIZE

Choose an actuator that has the thrust, speed and moment load capacity to move the load. Use the Speed/Stroke graph (page MXE_17) for the screw and the Moment and Load Capacity tables (pg. MXE_8-11) for the actuator.

2 COMPARE LOAD TO MAXIMUM LOAD CAPACITIES

Calculate the application load (combination of load mass and forces applied to the carrier) and application bending moments (sum of all moments Mx, My, and Mz applied to the carrier). Be sure to evaluate the magnitude of dynamic inertia moments. When a rigidly attached load mass is accelerated or decelerated, its inertia induces bending moments on the carrier. Careful attention to how the load is decelerated at the end of the stroke is required for extended actuator performance and application safety. If either load or any of your moments exceed figures indicated in the Moment and Load Capacity tables (pg. MXE_8-11) for the actuator consider:

- 1) Higher capacity bearing style i.e. **S** Solid to **P** Profiled Rail
- 2) A larger actuator size
- 3) Auxiliary carrier
- 4) External guide system

3 CALCULATE LOAD FACTOR LF

For loads with a center of gravity offset from the carrier account for both applied (static) and dynamic loads. The load factor (LF) must not exceed the value of 1.

$$L_f = \frac{M_x}{M_{x_{max}}} + \frac{M_y}{M_{y_{max}}} + \frac{M_z}{M_{z_{max}}} + \frac{F_y}{F_{y_{max}}} + \frac{F_z}{F_{z_{max}}} \leq 1$$

If LF does exceed the value of 1, consider the four choices listed in step #2.

4 ESTABLISH YOUR MOTION PROFILE AND CALCULATE ACCELERATION RATE

Using the application stroke length and maximum carrier velocity (or time to complete the linear motion), establish the motion profile. Select either triangular (accel-decel) or trapezoidal (accel-constant speed-decel) profile. Now calculate the maximum acceleration and deceleration rates of the move. Acceleration/deceleration should not exceed critical speed (page MXE_17) for the

SPEED FACTOR

FOR APPLICATIONS WITH HIGH SPEED OR SIGNIFICANT SHOCK AND VIBRATION: Calculated values of loads and bending moments must be increased by speed factor from the graph below to obtain full rated life of profiled rail bearing system.

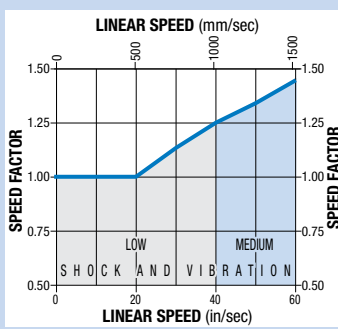

screw/nut combination chosen. Also, do not exceed safe rates of dynamic inertia moments determined in step #3.

5 SELECT THE LEAD SCREW

Based on the application requirements for accuracy, backlash, quiet operation, life, etc. select the appropriate lead screw type (Acme screw with a solid nut or ball screw with a standard or anti-backlash nut) and the pitch (lead). For additional information on screw selection, consult "Which Screw? Picking the Right Technology" (#9900-4644) available at www.tolomatic.com.

6 SELECT MOTOR (GEARHEAD IF NECESSARY) AND DRIVE

To help select a motor and drive, use the sizing equations located in the Engineering Resources section of the Tolomatic Electric Products Catalog (#3600-4609) to calculate the application thrust and torque requirements. Refer to Motor sections to determine the motor and drive.

7 DETERMINE TUBE CLAMP/MOUNTING PLATE REQUIREMENTS

- Consult the Tube Clamp Requirements graph for the model selected (page MXE_16)
- Cross reference the application load and maximum distance between supports
- Select the appropriate number of tube clamps, and mounting plates if required for motor and adapter clearance.

8 CONSIDER OPTIONS

- Choose metric or inch (US standard) load mounting. (When ordering use **SIX** for inch and **SM** for metric)
- Switches - Reed, Solid State PNP or NPN, all available normally open or normally closed
- **FL** Floating mount bracket - used when lack of parallelism occurs between the actuator and an externally guided and supported load (available for **S** Solid bearing style MXE actuators)

S SOLID BEARING 2:1 RULE

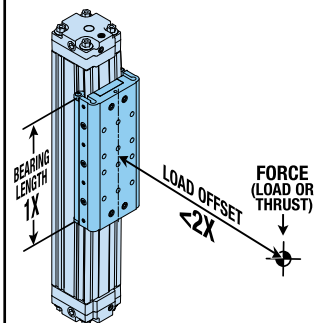

For applications using **S** solid bearings, binding or interrupted motion may occur if the load offset is equal to or greater than twice the bearing length (1X). **LOAD OFFSET** is defined as: the distance from the applied force (or the load center of gravity) to the centerline of the carrier.

If the load offset cannot be changed consider:

- 1.) Higher capacity bearing style, i.e. **S** to **P**
- 2.) Larger Bore Cylinder
- 3.) Auxiliary Carrier
- 4.) Add External Guides

ADJUSTMENT PROCEDURES

S SOLID BEARING CARRIER ADJUSTMENT

16 Series

NOTE: MXE16S requires a different carrier adjustment procedure, see below.

Tools Required:

Inch Models: 1/16 inch and 2.5mm Hex Wrench (Key)
 Metric Models: 2 and 2.5 mm Hex Wrench (Key)

1. Loosen endplate screws on both ends of the carrier.
2. Fully loosen all tension and lock screws. They do not need to be removed, just fully loosened.

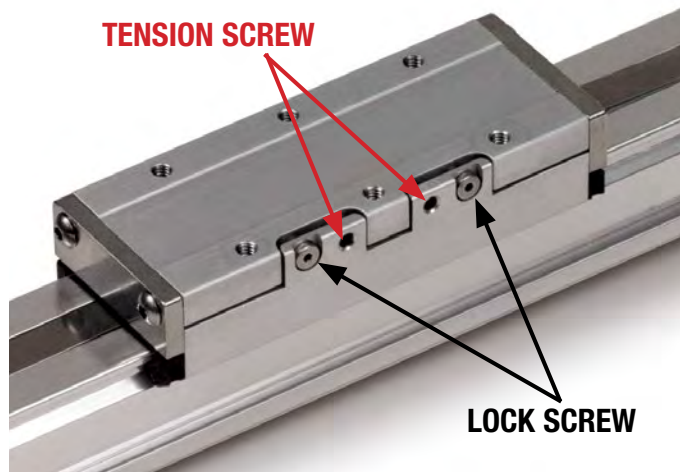

25, 32, 40, 50, 63 Series

The **S** solid bearing carrier will provide for maximum life when properly adjusted. The carrier design contains both tension and lock screws. The tension screws control the amount of pressure placed on the carrier bearings. The lock screws lock the tension screws in place and provide fine adjustment of the carrier bearings. The number of tension and lock screws will vary depending on the bore size of the actuator.

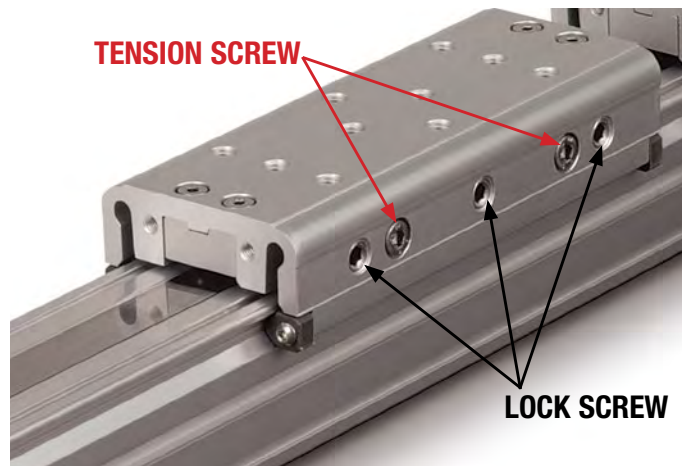

3. Tighten tension screws by turning them clockwise until the carrier is just tight enough so that no side-to-side rocking motion is present and it can easily be moved by hand over the entire stroke length with no hesitation. Very little torque on the screws is required to obtain this condition.

Note: The Tension Screws are the small set screw style fastener. The Lock Screws are the larger, low head, hex drive screws.

4. Tighten lock screws by turning them clockwise until tight. The carrier should feel snug in relation to the tube, with no side-to-side rocking motion present. If the carrier becomes too loose, loosen the lock screws, tighten the tension screws and then retighten the lock screws.
5. Once ideal carrier tension is achieved, fully tighten end plate screws on both ends of the carrier.

1. Fully loosen all tension and lock screws. They do not need to be removed, just fully loosened.
2. Tighten tension screws on both sides of carrier roughly 1/8 to 1/4 turn clockwise past where the screw starts to feel snug. The carrier should be very difficult or impossible to move by hand.
3. Next, adjust the lock screws on both sides of the carrier roughly 1/8 to 1/4 turn clockwise past where the screw starts to engage.
4. Ideal carrier tension is achieved when the carrier feels snug in relation to the tube. No rocking motion should be present. The carrier should be loose enough to be moved by hand over the entire length of the actuator. If after this process the carrier has become too loose, equally adjust all of the lock screws with a slight 1/32 turn counter-clockwise. A carrier that is adjusted too tight will increase the breakaway pressure required for motion; in extreme cases no motion will occur when air is applied.

Allen wrench sizes for carrier adjustment, Solid bearing actuators

	Tension Screw		Lock Screw	
	in	mm	in	mm
16	1/16	2	1/16	2
25	5/32	4	1/8	3
32	5/32	4	3/32	2
40	5/32	4	1/8	3
50	3/16	4	3/32	2.5
63	1/4	5	3/16	5

During the application duty cycle, this process may need to be repeated. Keeping the carrier properly adjusted will prolong the life of the **S** solid bearing system.

SERVICE PARTS ORDERING

REPAIR KITS

Repair kit includes: dust band, end caps, [Also for **S** style: bearings and bearing caps]

The part number for a repair kit begins with RK followed by model, actuator size, bearing type, and stroke length (**S_R** = inch/US Standard, **S_M** = metric) (NOTE: If unit has an auxiliary carrier also include DC and distance between carrier centers)



SWITCHES

TO ORDER SERVICE PARTS SWITCHES:

Switches for MXE include retained mounting hardware and are the same for all actuator sizes and bearing styles

Code	Part Number	Lead	Normally	Sensor Type
R Y	8100-9082	5m (197 in)	Open	Reed
R K	8100-9083*	Quick-disconnect		
N Y	8100-9084	5m (197 in)	Closed	Reed
N K	8100-9085*	Quick-disconnect		
T Y	8100-9088	5m (197 in)	Open	Solid State PNP
T K	8100-9089*	Quick-disconnect		
K Y	8100-9090	5m (197 in)	Open	Solid State NPN
K K	8100-9091*	Quick-disconnect		
P Y	8100-9092	5m (197 in)	Closed	Solid State PNP
P K	8100-9093*	Quick-disconnect		
H Y	8100-9094	5m (197 in)	Closed	Solid State NPN
H K	8100-9095*	Quick-disconnect		

*Also order mating QD cable #8100-9080

	8100-9080	Mating QD (Quick-disconnect) cable 197 in. (5m)
--	-----------	---

OPTIONS

MOUNTING OPTIONS		16		25		32	
		S Solid	P Profiled Rail	S Solid	P Profiled Rail	S Solid	P Profiled Rail
Floating Mount	Inch	8116-9536	NA	8125-9536	NA	8132-9536	NA
	Metric	8116-9036	NA	8125-9036	NA	8132-9036	NA
Tube Clamps	(2 Clamps)	NA	NA	8125-9018	8125-9018	8132-9018	8132-9018
Mounting Plate Kit	17-Frame	8316-9016	8316-9016	NA	NA	NA	NA
	23-Frame	NA	NA	8325-9016	8325-9016	8332-9016	8332-9016
	34-Frame	NA	NA	8325-9017	8325-9017	8332-9017	8332-9017

MOUNTING OPTIONS		40		50		63	
		S Solid	P Profiled Rail	S Solid	P Profiled Rail	S Solid	P Profiled Rail
Floating Mount Kit	Inch	8140-9536	NA	8150-9536	NA	8163-9536	NA
	Metric	8140-9036	NA	8150-9036	NA	8163-9036	NA
Tube Clamps	(2 Clamps)	8140-9018	8140-9018	8150-9018	8150-9018	8163-9018	8163-9018
Mounting Plate Kit	23-Frame	8340-9016	8340-9016	8350-9016	8350-9016	8363-9016	8363-9016
	34-Frame	8340-9017	8340-9017	8350-9016	8350-9016	8363-9016	8363-9016
	56-Frame	NA	NA	NA	NA	8363-9016	8363-9016



ORDERING

MODEL SELECTION (MUST BE IN THIS ORDER)

MXE 40 P SN02 SM2007-02

OPTIONS (IN ANY ORDER)

LMI DC215-9 TC8 TK2

MODEL
MXE MX Rodless Electric Actuator

SERIES

16 Series actuator	40 Series actuator
25 Series actuator	50 Series actuator
32 Series actuator	63 Series actuator

BEARING

S Solid Bearing
P Profiled Rail

NUT/SCREW CONFIGURATION

SOLID NUT / PITCH (turn/in) SERIES

SN01	MXE 25, 32, 40, 50
SN02	MXE 16, 25, 32, 40, 50
SN05	MXE 25, 32
SN04	MXE 16, 63
SN16	MXE 16

BALL NUT / PITCH (turn/in) SERIES

BN01	MXE 63
BNL01	MXE 63
BN02	MXE 40, 50, 63
BNL02	MXE 40, 50, 63
BN04	MXE 63
BNL04	MXE 63
BN05	MXE 40, 50
BNL05	MXE 40, 50
BN08	MXE 25, 32
BNL08	MXE 25, 32

STROKE LENGTH & MOUNTING TYPE

SK _____ Stroke, enter desired stroke length in **inches**

SM _____ Stroke, enter desired stroke length in **millimeters**

NOTE: Actuator mounting threads and mounting fasteners will be either inch or metric; depending on how stroke length is indicated

SK=inch mounting
SM= metric mounting

MOTOR MOUNTING / REDUCTION

(must choose one)

LMI In-Line mounting
LME23 Ext. shaft for RP & 23 frame motor
LME34 Ext. shaft for RP & 34 frame motor

▲ A motor size and code must be selected when specifying a reverse-parallel mounting configuration.

RPL1 1:1 Reverse-Parallel mount left
RPR1 1:1 Reverse-Parallel mount right
RPB1 1:1 Reverse-Parallel mount bottom
RPT1 1:1 Reverse-Parallel mount top
RPL2 2:1 Reverse-Parallel mount left
RPR2 2:1 Reverse-Parallel mount right
RPB2 2:1 Reverse-Parallel mount bottom
RPT2 2:1 Reverse-Parallel mount top

MOTOR / DRIVE / CONTROLLER / PLANETARY GEARBOX

▲ Visit www.tolomatic.com for the most up-to-date information or call Tolomatic 1-800-328-2174

AUXILIARY CARRIER

DC _____ Auxiliary Carrier, enter center-to-center spacing desired in **inches (SK)** or **millimeters (SM)**

(Same unit of measure as stroke length is required)

▲ Center-to-center spacing between carriers adds to overall length of the actuator, this distance will not be subtracted from stroke length specified in the previous step

MOUNTING

TC_ Tube Clamps, enter number of pairs
FL Floating Mount
MP_ Mounting Plates, & quantity

▲ NOTE: Floating Mount is not available with "P" Profiled Rail

SWITCHES

RY_ Reed Switch (Normally Open) with 5-meter lead, & enter quantity desired
RK_ Reed Switch (Normally Open) with 5-meter lead/QD, & quantity
NY_ Reed Switch (Normally Closed) with 5-meter lead, & quantity
NK_ Reed Switch (Normally Closed) with 5-meter lead/QD, & quantity
TY_ Solid State Switch PNP (Normally Open) w/ 5-meter lead, & quantity
TK_ Solid State Switch PNP (Normally Open) w/ 5-meter lead/QD, & quantity
KY_ Solid State Switch NPN (Normally Open) w/ 5-meter lead, & quantity
KK_ Solid State Switch NPN (Normally Open) w/ 5-meter lead/QD, & quantity
PY_ Solid State Switch PNP (Normally Closed) w/ 5-meter lead, & quantity
PK_ Solid State Switch PNP (Normally Closed) w/ 5-meter lead/QD, & quantity
HY_ Solid State Switch NPN (Normally Closed) w/ 5-meter lead, & quantity
HK_ Solid State Switch NPN (Normally Closed) w/ 5-meter lead/QD, & quantity

VISIT www.tolomatic.com/mxe FOR COMPLETE, UP-TO-DATE INFORMATION

▲ Not all codes listed are compatible with all options.

Call Tolomatic 1-800-328-2174 to determine available options and accessories based on your application requirements.

THE TOLOMATIC DIFFERENCE What you expect from the industry leader.



EXCELLENT CUSTOMER SERVICE & TECHNICAL SUPPORT

Our people make the difference! Expect prompt, courteous replies to all of your application and product questions.



INDUSTRY LEADING DELIVERIES

Tolomatic continues to offer the fastest delivery of standard catalog products. Modified and custom products ship weeks ahead of the competition.

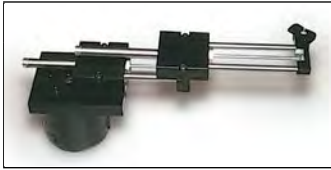

INNOVATIVE PRODUCTS

From standard catalog products... to modified products... to completely unique custom products, Tolomatic designs and builds the best solutions for your challenging applications.



ONLINE SIZING & SELECTION SOFTWARE

Online sizing that is easy to use, accurate and always up-to-date. Input your application data and the software will determine a Tolomatic electric actuator to meet your requirements.



3D MODELS & 2D DRAWINGS AVAILABLE ON THE WEB

Easy to access CAD files are available in many popular formats.

ALSO CONSIDER THESE OTHER TOLOMATIC PRODUCTS:



PNEUMATIC PRODUCTS

RODLESS CYLINDERS: Band Cylinders, Cable Cylinders, MAGNETICALLY COUPLED CYLINDERS/SLIDES; GUIDED ROD CYLINDER SLIDES

"FOLDOUT" BROCHURE #9900-9075
 PRODUCTS BROCHURE #9900-4028



ELECTRIC PRODUCTS

ROD & GUIDED ROD STYLE ACTUATORS, HIGH THRUST ACTUATORS, SCREW & BELT DRIVE RODLESS ACTUATORS, MOTORS, DRIVES AND CONTROLLERS

"FOLDOUT" BROCHURE #9900-9074
 PRODUCTS BROCHURE #9900-4016



POWER TRANSMISSION PRODUCTS

GEARBOXES: Float-A-Shaft®, Slide-Rite®; DISC CONE CLUTCH; CALIPER DISC BRAKES

"FOLDOUT" BROCHURE #9900-9076
 PRODUCTS BROCHURE #9900-4029



3800 County Road 116 • Hamel, MN 55340 U.S.A.
 Phone: (763) 478-8000 • Fax: (763) 478-8080

Toll-Free: **1-800-328-2174**

Email: help@tolomatic.com • <http://www.tolomatic.com>

All brand and product names are trademarks or registered trademarks of their respective owners. Information in this document is believed accurate at time of printing. However, Tolomatic assumes no responsibility for its use or for any errors that may appear in this document. Tolomatic reserves the right to change the design or operation of the equipment described herein and any associated motion products without notice. Information in this document is subject to change without notice.

Visit www.tolomatic.com for the most up-to-date technical information

