

BCS RODLESS SCREW DRIVE ACTUATORS

ENDURANCE TECHNOLOGYSM



CONTENTS

BCS Features	BCS_2
Critical Speed Capacities	BCS_4
Specifications	BCS_6
Support Recommendations	BCS_8
BCS10 Specifications	BCS_10
BCS10 Dimensions	BCS_12
BCS15 Specifications	BCS_14
BCS15 Dimensions	BCS_17
BCS20 Specifications	BCS_19
BCS20 Dimensions	BCS_21
Switches	BCS_23
Application Data Worksheet	BCS_25
Selection Guidelines	BCS_26
Ordering	BCS_27

BCS RODLESS SCREW DRIVE ACTUATORS

ENDURANCE TECHNOLOGYSM

Endurance Technology features are designed for maximum durability to provide extended service life.

This rodless style actuator is designed for carrying light to moderate loads at an economical price. Based upon our BC2 pneumatic band cylinder, it utilizes a guidance system consisting of an adjustable carrier bracket with two solid bearing rods that transmit the load to the actuator body for superior load support. Built-to-order in stroke lengths up to 120 inches with multiple screw options available.

ADJUSTABLE CARRIER BRACKET

- Allows for easy adjustment and replacement of the load bearings throughout the life of the actuator
- Allows customizing the bearing tension and free play of the carrier to meet the applications requirements



FORMED END CAP WIPERS

- Prevent contaminants from entering the sealing band area to protect internal components

LOAD-BEARING CARRIER DESIGN

- Engineered resin bearings provide guidance, low friction loss and long life
- Load and moments are transmitted directly to the actuator body



SCREW SUPPORT BEARINGS

- High thrust bearing assembly design isolates the motor from axial forces

MULTIPLE SCREW TECHNOLOGIES

YOU CAN CHOOSE:

- Solid nuts of bronze or engineered resins offering quiet performance at the lowest cost; anti-backlash available



- Ball nuts offer positioning accuracy and repeatability with longer life; low-backlash available



TOLOMATIC...LINEAR SOLUTIONS MADE EASY

EXTERNAL BUMPERS

- Bumpers protect the screw and nut assembly from damage at end of stroke

STAINLESS STEEL SEALING BAND

- Prevents contaminants from entering the screw and nut area for prolonged life
- Fatigue resistant stainless steel bands are specifically made to offer long life and will not elongate



LIGHTWEIGHT ALUMINUM DESIGN

- Black anodized extrusion design is optimized for rigidity and strength
- External switch channels on both sides allow easy placement and adjustment of position indicating switches

MOTOR ORIENTATION

YOU CAN CHOOSE:

- Inline option directly couples the driving shafts and is a one-piece housing construction for optimum alignment and support of the motor
- Reverse-parallel option minimizes the overall length and offers a 1:1 or 2:1 belt ratio

YOUR MOTOR HERE

YOU CAN CHOOSE:

- Motor or gearbox supplied and installed by Tolomatic
 - Specify the device to be installed and actuator ships with proper mounting hardware
 - Specify and ship your device to Tolomatic for factory installation
- LMI (inline) motor mount only

OPTIONS



CARRIER OPTIONS

- AUXILIARY CARRIER** doubles the load capacity and increases bending moments capacity significantly



- FLOATING MOUNT** compensates for non-parallelism between the actuator and an external support or guidance system



MOUNTING OPTIONS

- SURFACE MOUNT** tapped holes are provided on the underside of the actuator heads, as a standard feature, for direct mounting



- TUBE SUPPORTS** provide intermediate support of the actuator body throughout long stroke lengths

METRIC OPTION

- Provides metric tapped holes for mounting of load to carrier and of actuator to mating surfaces



SWITCHES

- Styles include: reed, hall-effect or triac. Select either 15ft potted cable with flying leads or 6in to quick-disconnect coupler with mating 15ft cable-

Sold & Serviced By:

 **ELECTROMATE**

Toll Free Phone (877) SERV098

Toll Free Fax (877) SERV099

www.electromate.com

sales@electromate.com

BCS Rodless Screw Drive Actuators

ACME SCREW/NUT COMBINATIONS

ACME SCREW CRITICAL SPEED CAPACITIES

CRITICAL SPEED WITH US CONVENTIONAL ACME SCREW

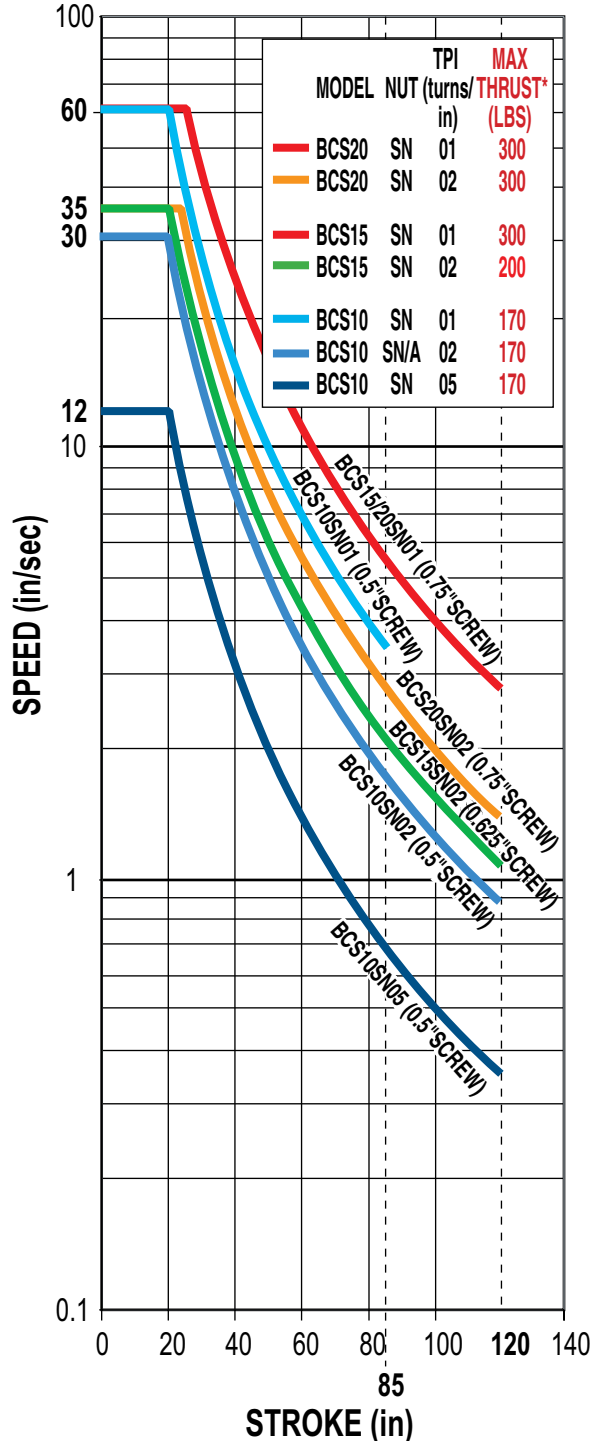

CRITICAL SPEED WITH METRIC ACME SCREW

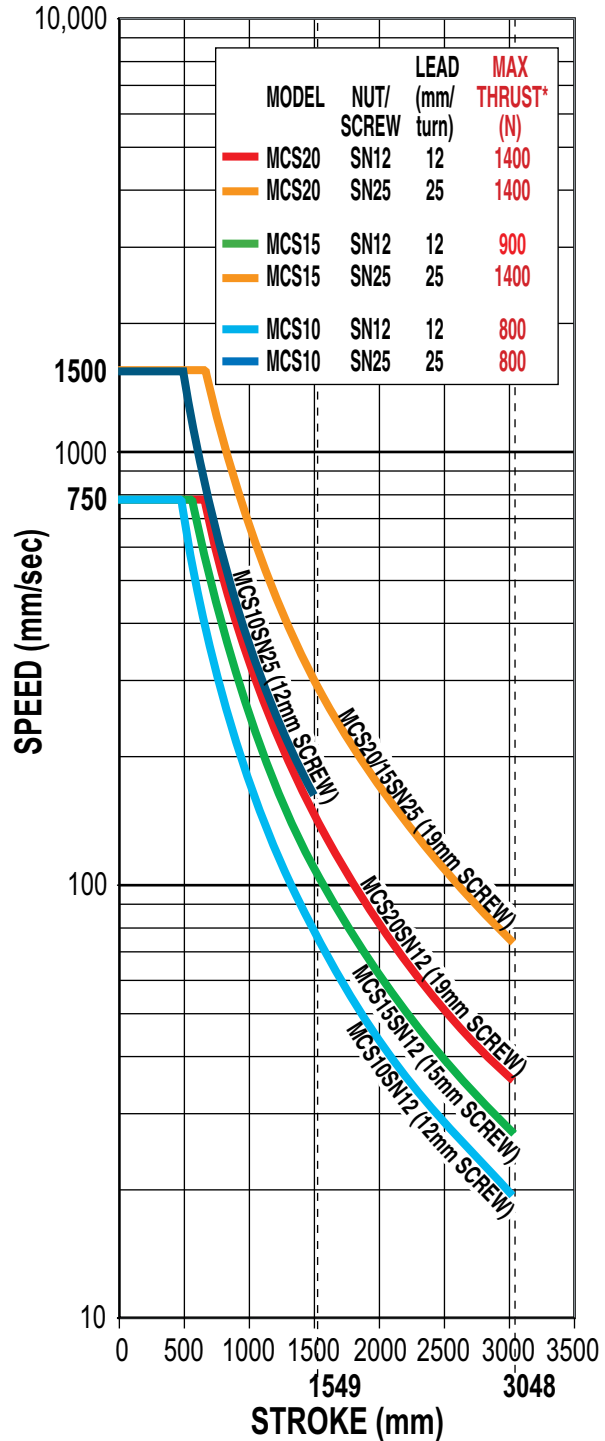

Sold & Serviced By:



Toll Free Phone (877) SERV098
 Toll Free Fax (877) SERV099
 www.electromate.com
 sales@electromate.com

*Maximum thrust is the maximum continuous dynamic thrust subject to Thrust x Velocity limitation.

Dotted lines represent maximum stroke for screw selections.

For Screw PV limits, refer to the individual charts located in the technical section for each actuator body size.

BCS Rodless Screw Drive Actuators

BALL SCREW/NUT COMBINATIONS

BALL SCREW CRITICAL SPEED CAPACITIES

CRITICAL SPEED WITH US CONVENTIONAL BALL SCREW

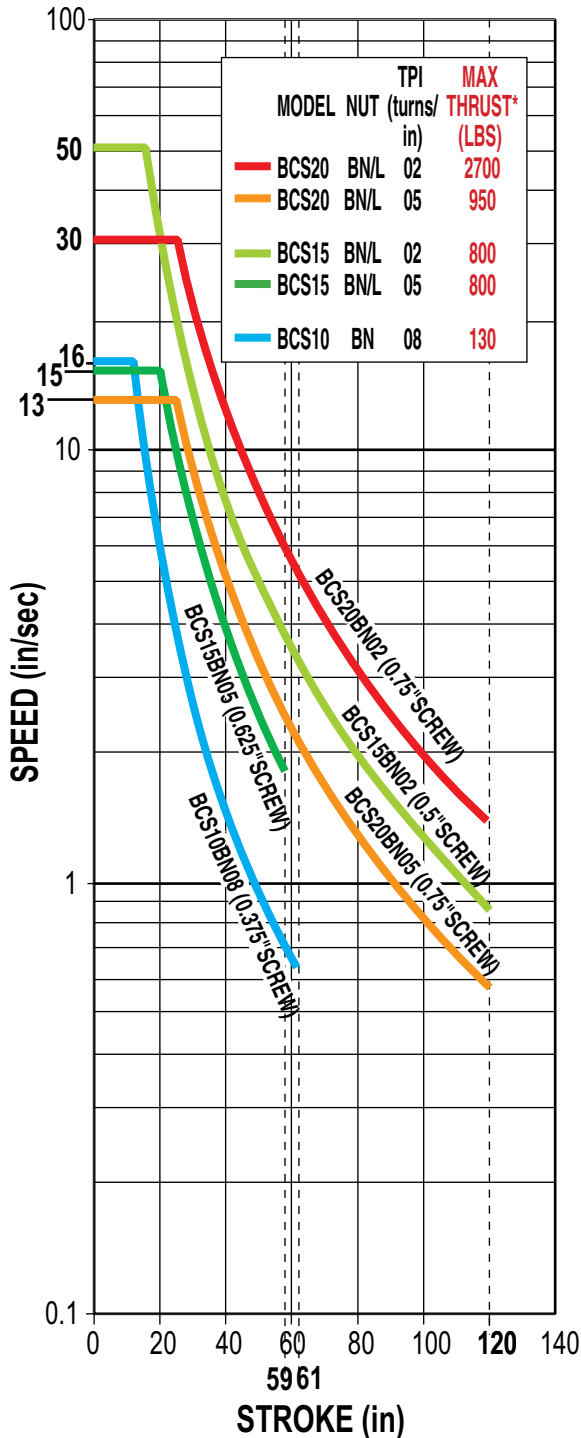

CRITICAL SPEED WITH METRIC BALL SCREW

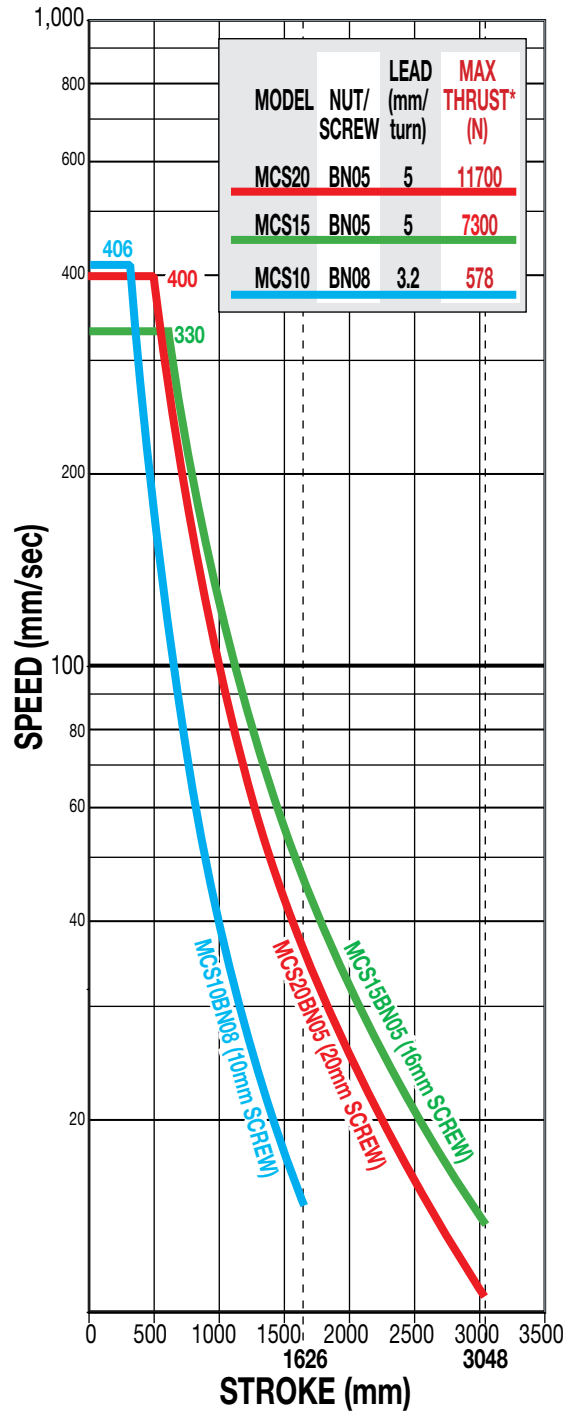

* Maximum thrust reflects 90% reliability for 1 million linear inches of travel.

Dotted lines represent maximum stroke for screw selections.

Refer to the technical section for each actuator body size for details on life calculations for individual screws.

BCS Rodless Screw Drive Actuators

BALL SCREW SPECIFICATIONS

BALL SCREW LIFE CALCULATION

LIFE CAPACITIES WITH US CONVENTIONAL BALL SCREW

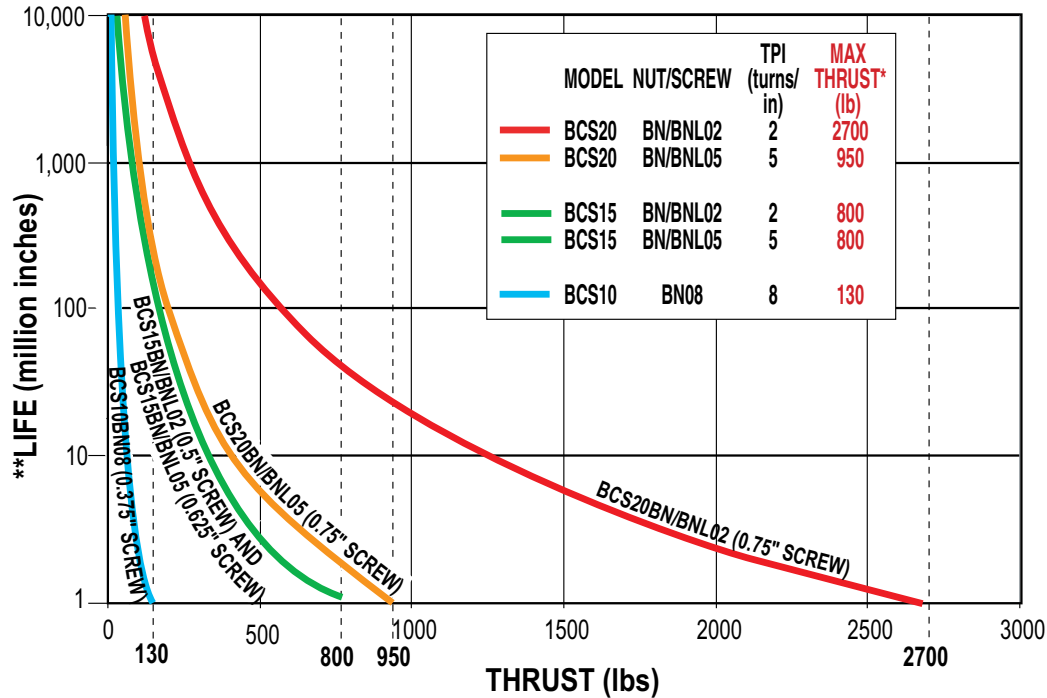

LIFE CAPACITIES WITH METRIC BALL SCREW

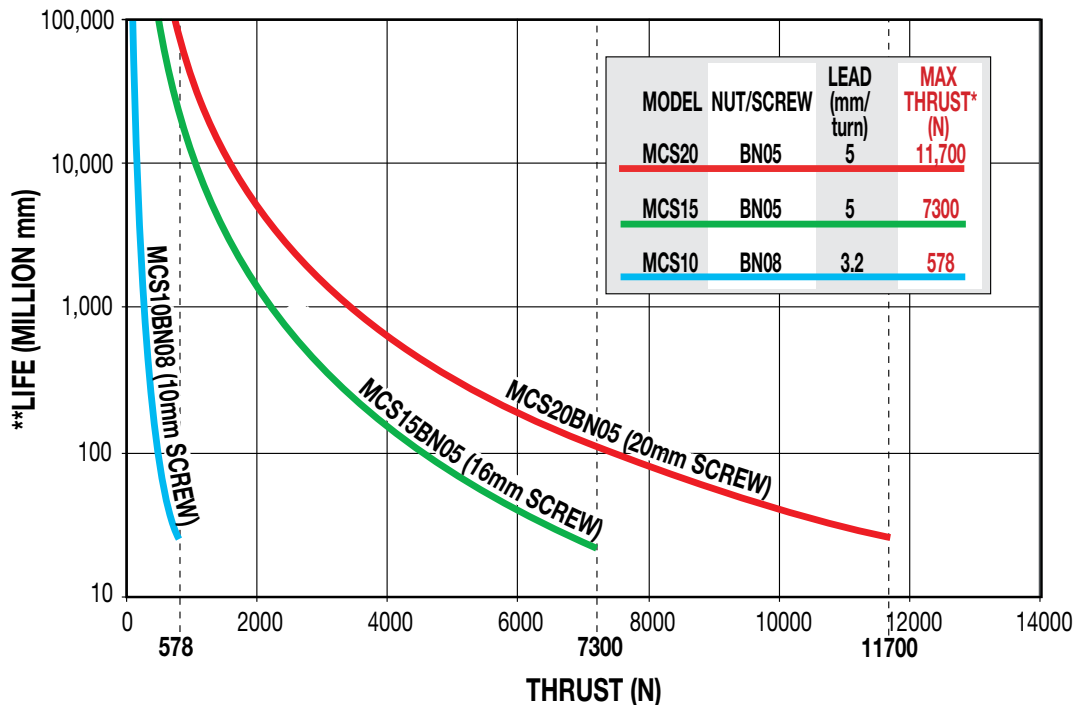

* Maximum thrust reflects 90% reliability for 1 million linear inches of travel.

Dotted lines represent maximum thrust for screw selections.

**Life indicates theoretical maximum life of screw only, under ideal conditions and does not indicate expected life of actuator.

BCS Rodless Screw Drive Actuators

SPECIFICATIONS

SPECIFICATIONS RELATED TO ACTUATOR SIZE AND SCREW SELECTION

US CONVENTIONAL LEAD SCREWS											
ACTUATOR SERIES	SCREW DIA. (in)	SCREW TYPE	TPI (turns/in)	LEAD ACCURACY (in/ft)	BACKLASH (in)	MAXIMUM THRUST* (lb)	MAXIMUM STROKE (in)	INERTIA (lb-in ²)			BREAKAWAY TORQUE (lb-in)
								BASE ACTUATOR		PER/in OF STROKE	
								In Line	Rev. Parallel		
BCS10	0.375	BN	08	0.004	0.015	130	61	0.0046	0.0054	0.0005	1.000
	0.375	BNL	08	0.004	0.002	130	61	0.0046	0.0054	0.0005	1.000
	0.500	SN	01	0.006	0.007	170	85	0.0321	0.0348	0.0017	1.857
	0.500	SN	02	0.005	0.007	170	120	0.0190	0.0217	0.0017	1.563
	0.500	SNA	02	0.005	0.003	170	120	0.0190	0.0217	0.0017	1.563
	0.500	SN	05	0.006	0.007	170	120	0.0153	0.0180	0.0017	1.125
BCS15	0.500	BN	02	0.003	0.015	800	59	0.0299	0.0327	0.0017	1.375
	0.500	BNL	02	0.003	0.002	800	59	0.0299	0.0327	0.0017	1.375
	0.625	BN	05	0.003	0.015	800	59	0.0455	0.0524	0.0042	1.188
	0.625	BNL	05	0.003	0.002	800	59	0.0455	0.0524	0.0042	1.188
	0.625	SN	02	0.005	0.007	200	120	0.0558	0.0627	0.0042	1.563
	0.750	SN	01	0.005	0.007	300	120	0.1391	0.1536	0.0087	2.188
BCS20	0.750	BN	02	0.004	0.015	2700	120	0.1241	0.1374	0.0087	1.750
	0.750	BNL	02	0.004	0.002	2700	120	0.1241	0.1374	0.0087	1.750
	0.750	BN	05	0.003	0.015	950	120	0.1091	0.1224	0.0087	1.563
	0.750	BNL	05	0.003	0.002	950	120	0.1091	0.1224	0.0087	1.563
	0.750	SN	01	0.005	0.007	300	120	0.1775	0.1908	0.0087	3.125
	0.750	SN	02	0.005	0.007	300	120	0.1241	0.1374	0.0087	2.188

METRIC LEAD SCREWS											
ACTUATOR SERIES	SCREW DIA. (mm)	SCREW TYPE	LEAD (mm/turn)	LEAD ACCURACY (mm/300)	BACKLASH (mm)	MAXIMUM THRUST* (N)	MAXIMUM STROKE (mm)	INERTIA (kg-m ² x 10 ⁻⁶)			BREAKAWAY TORQUE (N-m)
								BASE ACTUATOR		PER/mm OF STROKE	
								In Line	Rev. Parallel		
MCS10	10	BN	3.2	0.13	0.38	578	1549	31.94	37.50	3.472	0.11
	10	BNL	3.2	0.13	0.05	578	1549	31.94	67.50	3.472	0.11
	12	SN	12	0.13	0.18	800	3048	4.53	5.18	0.410	0.20
	12	SN	25	0.13	0.18	800	1626	8.34	8.98	0.410	0.28
MCS15	15	SN	12	0.13	0.18	900	3048	13.22	14.83	0.966	0.27
	16	BN	5	0.13	0.38	7300	1499	13.69	15.77	1.258	0.16
	16	BNL	5	0.13	0.05	7300	1499	13.69	15.77	1.258	0.16
	19	SN	25	0.13	0.18	1400	3048	39.98	44.17	2.517	0.32
MCS20	19	SN	12	0.13	0.18	1400	3048	35.42	39.28	2.517	0.39
	19	SN	25	0.13	0.18	1400	3048	50.95	54.81	2.517	0.57
	20	BN	5	0.13	0.38	11700	3048	38.61	43.32	3.102	0.25
	20	BNL	5	0.13	0.05	11700	3048	38.61	43.32	3.102	0.25

SCREW CODE	DESCRIPTION
SN	Solid Nut
SNA	Anti-backlash Solid Nut
BN	Ball Nut
BNL	Low-Backlash Ball Nut



Contact Tolomatic for higher accuracy and lower backlash options.

* For Acme screws, maximum thrust is the maximum continuous dynamic thrust subject to Thrust x Velocity limitation.

For ball screws, maximum thrust reflects 90% reliability for 1 million linear inches of travel.

BCS Rodless Screw Drive Actuators

SPECIFICATIONS

GENERAL ACTUATOR SPECIFICATIONS

BCS US CONVENTIONAL ACTUATORS					
ACTUATOR SERIES	CARRIER WEIGHT (lb)	BASE WEIGHT (lb) (Including Carrier)	WEIGHT PER/IN OF STROKE (lb)	TEMPERATURE RANGE* (F)	IP RATING**
BCS10	0.69	2.91	0.176	40 - 130	44
BCS15	1.94	6.61	0.392	40 - 130	44
BCS20	2.81	14.59	0.666	40 - 130	44

MCS METRIC ACTUATORS					
ACTUATOR SERIES	CARRIER WEIGHT (kg)	BASE WEIGHT (kg) (Including Carrier)	WEIGHT PER/mm OF STROKE (g)	TEMPERATURE RANGE* (C)	IP RATING**
MCS10	0.31	1.32	3.1	4 - 54	44
MCS15	0.88	2.90	7.0	4 - 54	44
MCS20	1.27	6.62	11.9	4 - 54	44



* Heat generated by the motor and drive should be taken into consideration as well as linear velocity and work cycle time. For applications that require operation outside of the recommended temperature range, contact Tolomatic.

** Protected against ingress of solid particles greater than .039 in (1mm) and splashing water

LARGE FRAME MOTORS AND SMALLER SIZE ACTUATORS: Cantilevered motors need to be supported, if subjected to continuous rapid reversing duty and/or under dynamic conditions.

BCS CARRIER BRACKET BOLT ADJUSTMENT (ALL SIZES)



BCS carrier bracket adjustment bolts should be adjusted to suit each individual application, depending on the degree of rigidity required. A good starting point is to tighten the nut on the bolt until there is no lateral movement of the bolt. Then,

equally tighten each nut on the carrier bolt while moving the carrier by hand along the length of the stroke. When all lateral play in the carrier is eliminated and free movement along the length of the stroke is maintained, your carrier bracket is adjusted properly. Some applications may require fine tuning of this adjustment to gain more lateral play or a higher degree of rigidity. In demanding applications, carrier adjustments should be done periodically.



*** CAUTION:**

Over-tightening increases drive torque of motor and drive.

FRICTION FORCE

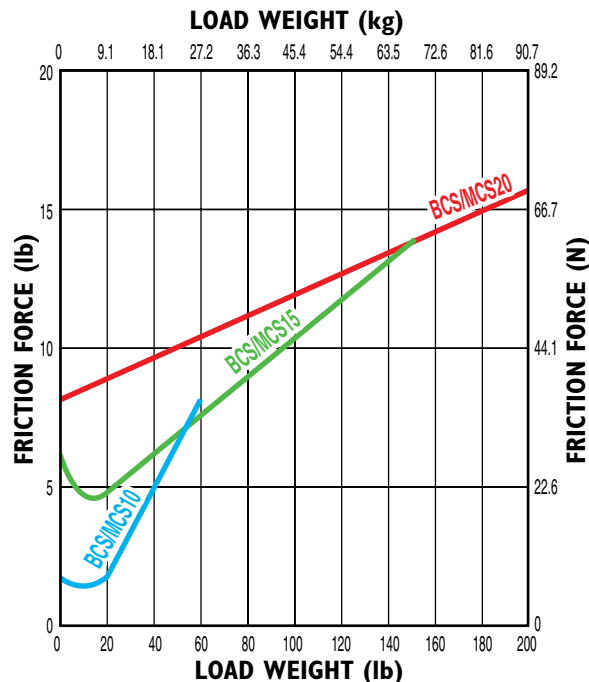

SUPPORT RECOMMENDATIONS

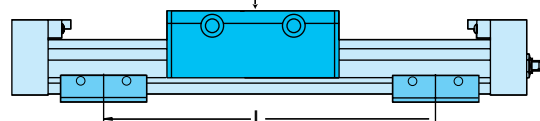
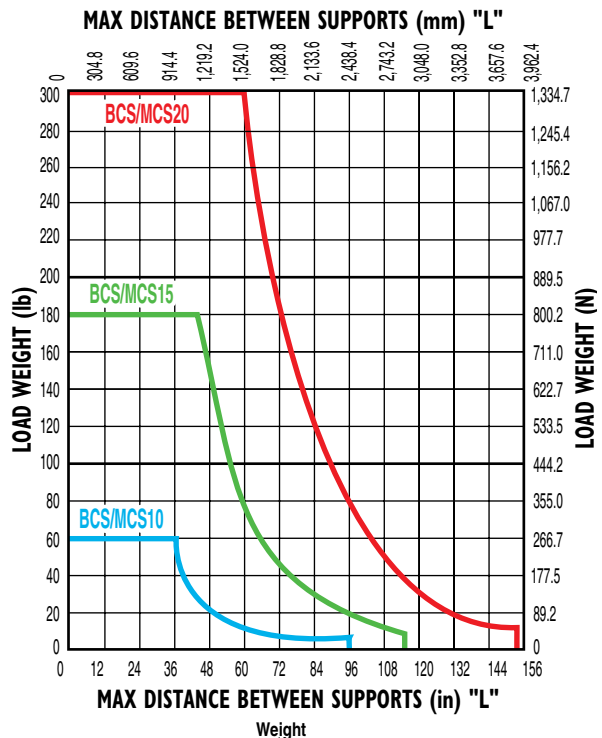

BCS Rodless Screw Drive Actuators

SPECIFICATIONS

DYNAMIC BENDING MOMENTS AND LOADS

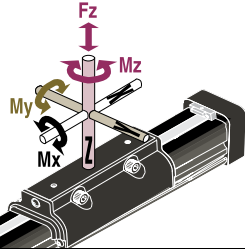
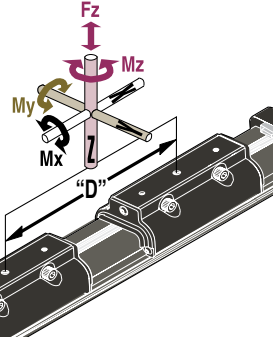
STANDARD CARRIER	MAXIMUM BENDING MOMENTS AND LOADS		US CONVENTIONAL			METRIC		
			BCS10	BCS15	BCS20	MCS10	MCS15	MCS20
	Mx Moment (Roll)	(lb-in : N-m)	55	275	300	6.2	31.1	33.9
	My Moment (Pitch)	(lb-in : N-m)	100	500	1100	11.3	56.5	124.3
	Mz Moment (Yaw)	(lb-in : N-m)	30	200	325	3.4	22.6	36.7
	Fz Load (Lateral)	(lb : N)	60	180	300	267	801	1335
AUXILIARY CARRIER: Increases rigidity, load-carrying capacity and moments			BCS10	BCS15	BCS20	MCS10	MCS15	MCS20
	Mx Moment (Roll)	*(lb-in : N-m)	110	550	600	12.4	62.1	67.8
	My Moment (Pitch)	*(lb-in : N-m)	287	1453	2430	32.4	164.1	274.6
	Mz Moment (Yaw)	*(lb-in : N-m)	287	1453	2430	32.4	164.1	274.6
	Fz Load (Lateral)	(lb : N)	120	360	600	534	1602	2670
	Minimum Dimension 'D'	(in : mm)	5.10	6.50	8.10	129.5	165.0	206.0

! Please see *BCS Carrier Bracket Bolt Adjustment* on page *BCS_6*

! Breakaway torque will increase when using the Auxiliary carrier option. When ordering, determine your working stroke and enter this value into the configuration string. Overall actuator length will automatically be calculated.

*Loads shown in table are at minimum "D" dimension, for ratings with longer "D" dimension see graph below.

AUXILIARY CARRIER: BENDING MOMENT AT 'D' DISTANCE

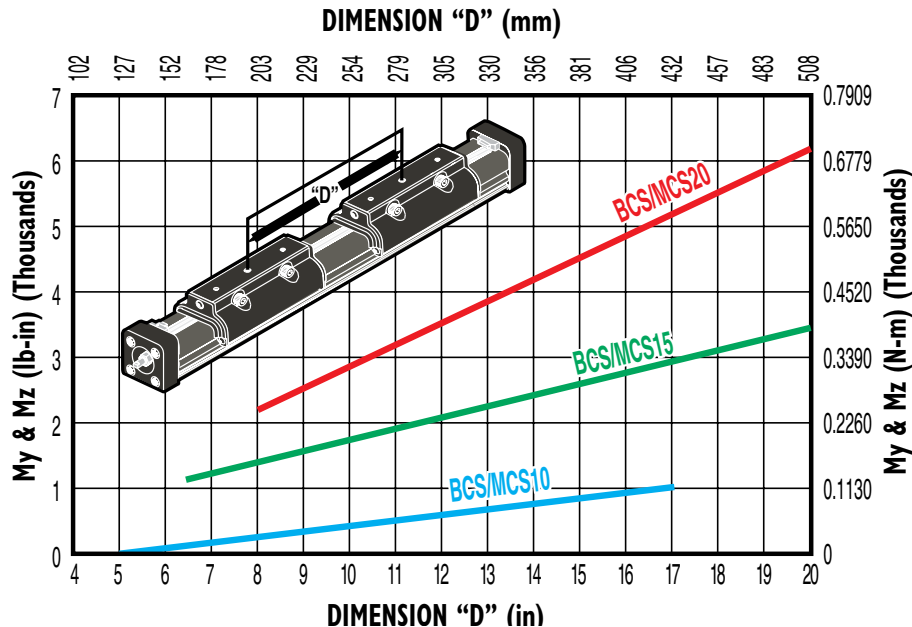

Rates shown on charts were calculated with these assumptions:

- 1.) Coupling between carriers is rigid.
- 2.) Load is equally distributed between carriers.

3.) Coupling device applies no misalignment loads to carriers.

* Customer must specify Dimension "D" (Distance between carrier center lines) in configuration string.



BCS10 Rodless Screw Drive Actuator

ACME SCREW SPECIFICATIONS

BCS10/MCS10 ACME SCREW CRITICAL SPEED AND PV LIMITS

CRITICAL SPEED WITH 1/2" US CONVENTIONAL ACME SCREW

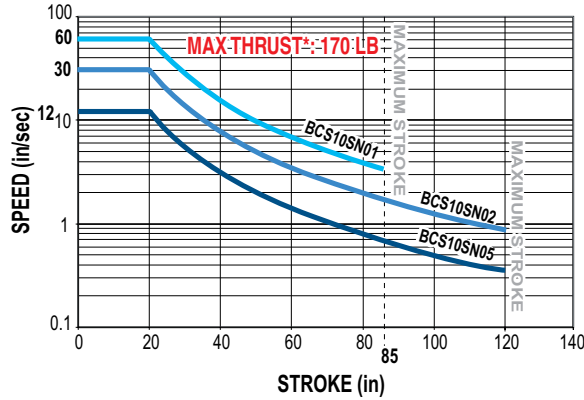

CRITICAL SPEED WITH 12mm METRIC ACME SCREW

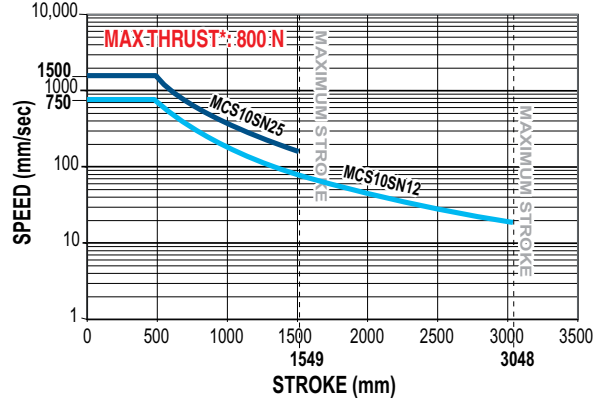

PV LIMITS: 1/2" 1 TPI US CONVENTIONAL ACME SCREW

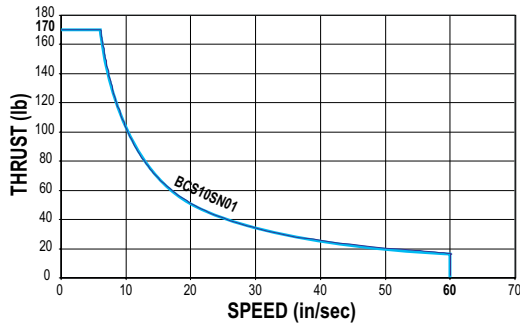

PV LIMITS: 12mm ACME METRIC SCREW w/25mm LEAD

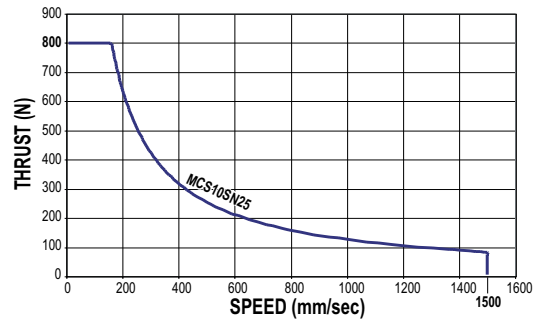

PV LIMITS: 1/2" 2 TPI US CONVENTIONAL ACME SCREW

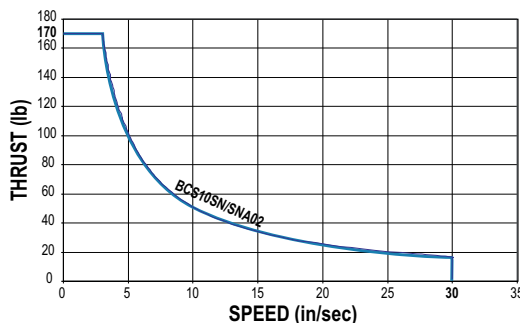

PV LIMITS: 12mm ACME METRIC SCREW w/12mm LEAD

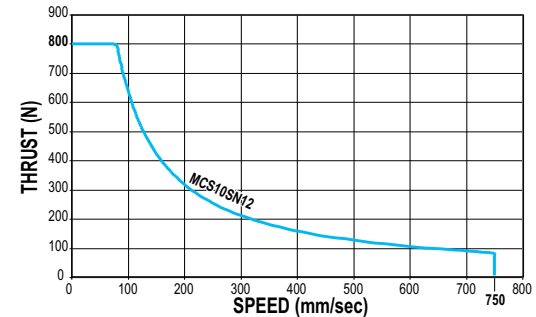

PV LIMITS: 1/2" 5 TPI US CONVENTIONAL ACME SCREW

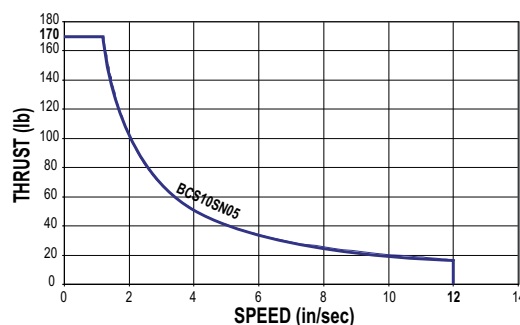

SN = Solid Nut
 SNA = Solid Anti-backlash Nut

 * Maximum thrust is the maximum continuous dynamic thrust subject to Thrust x Velocity limitation.

PV LIMITS: Any material which carries a sliding load is limited by heat buildup. The factors that affect heat generation rate in an application are the pressure on the nut in pounds per square inch and the surface velocity in feet per minute. The product of these factors provides a measure of the severity of an application.

$$\left(\frac{P}{(\text{Max. Thrust Rating})} \right) \times \left(\frac{V}{(\text{Max. Speed Rating})} \right) \leq 0.1$$

BCS10 Rodless Screw Drive Actuator

BALL SCREW SPECIFICATIONS

BCS/MCS10 BALL SCREW SPECIFICATIONS

CRITICAL SPEED WITH 3/8" US CONVENTIONAL BALL SCREW

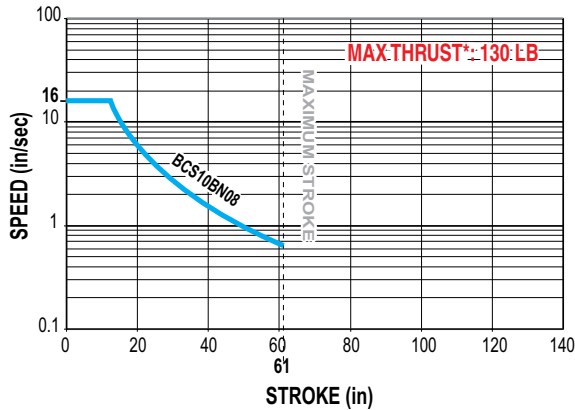

CRITICAL SPEED WITH 10mm METRIC BALL SCREW

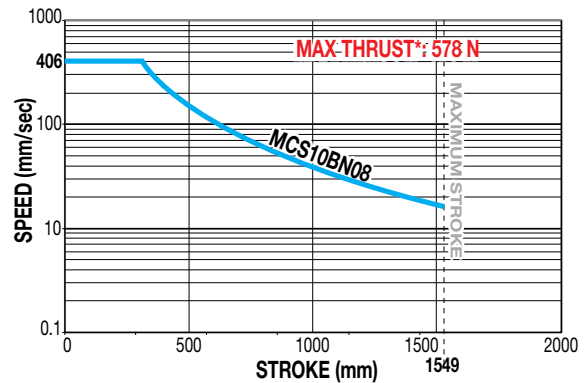

LIFE CALCULATION: 3/8" 8TPI US CONVENTIONAL BALL SCREW

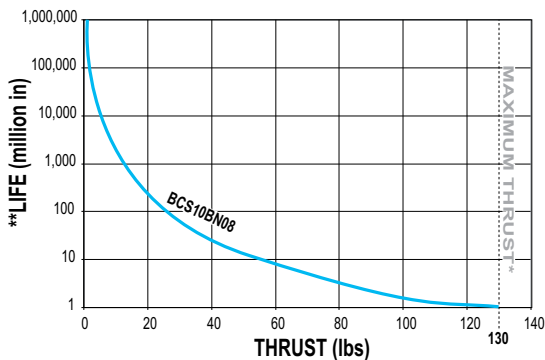

LIFE CALCULATION: 10mm METRIC BALL SCREW w/3.2mm LEAD

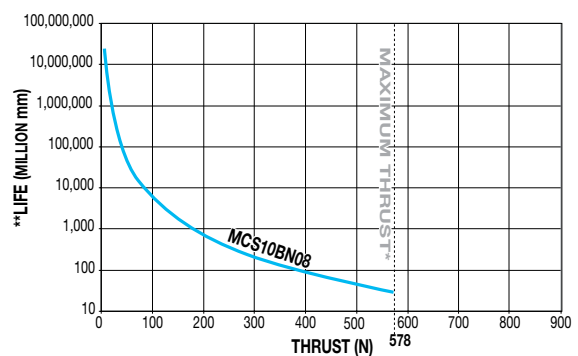

BN = Ball Nut



*** Maximum thrust reflects 90% reliability for 1 million linear inches of travel.**

****Life indicates theoretical maximum life of screw only, under ideal conditions and does not indicate expected life of actuator.**

BCS10 Rodless Screw Drive Actuator

DIMENSIONS

BCS10/MCS10 ACTUATOR AND OPTIONS

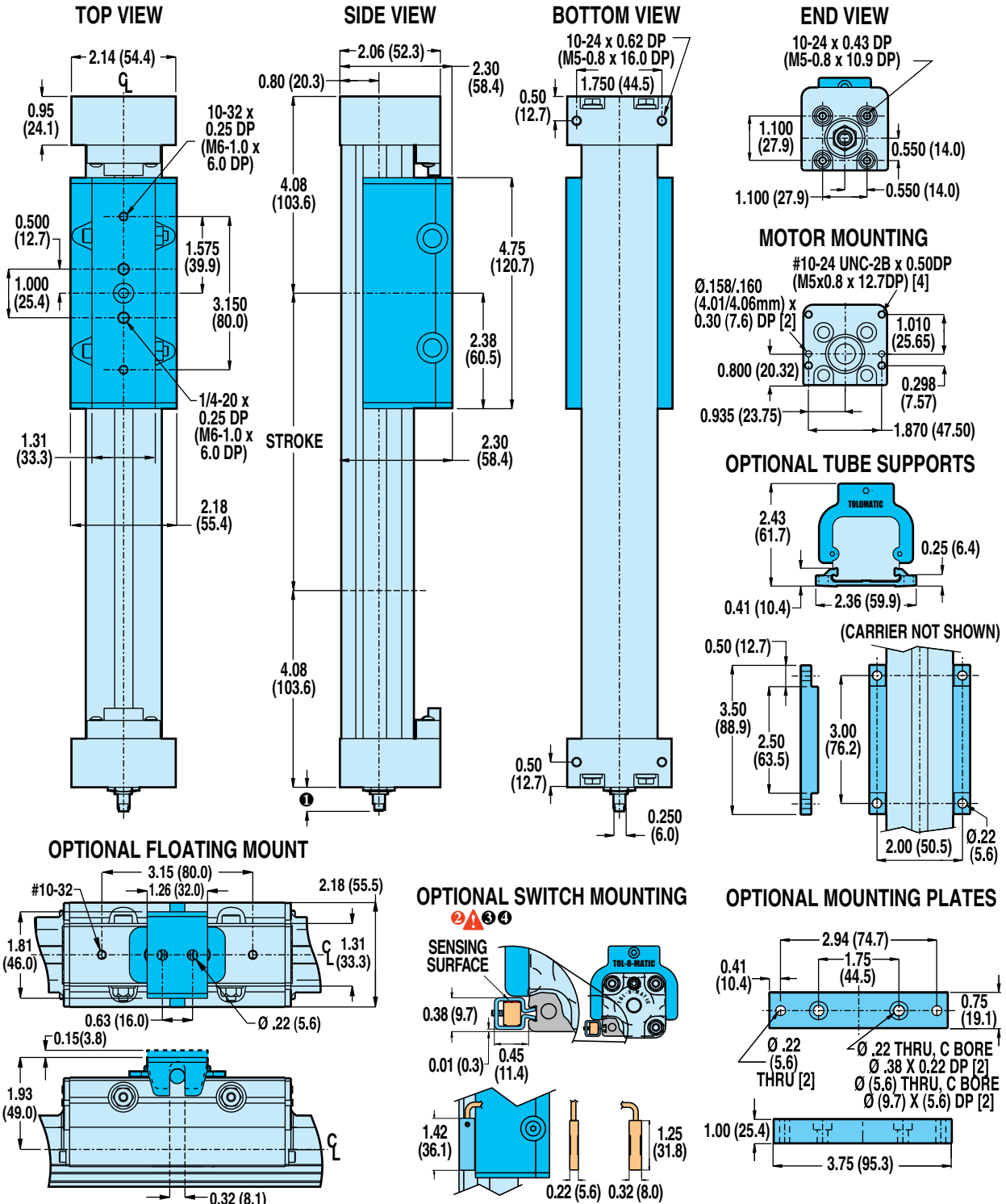

1 SHAFT LENGTH

In-line mounting	0.53 (13.5)
Extended shaft for RP & 23-frame motor	1.89 (48.0)
Extended shaft for RP & 34-frame motor	2.10 (53.3)
Extended shaft for purchases prior to 6/24/02	1.53 (38.9)

2 CAUTION: DO NOT OVERTIGHTEN SWITCH HARDWARE WHEN INSTALLING

3 NOTE: The scored face of the switch indicates the sensing surface and must face toward the magnet

4 NOTE: Some actuators require switch mounting on a specific side of the actuator. Call Tolomatic 1-800-328-2174 for details

BCS10 Rodless Screw Drive Actuator

DIMENSIONS

BCS/MCS10: IN-LINE MOUNT FOR MOTORS OR GEARHEADS

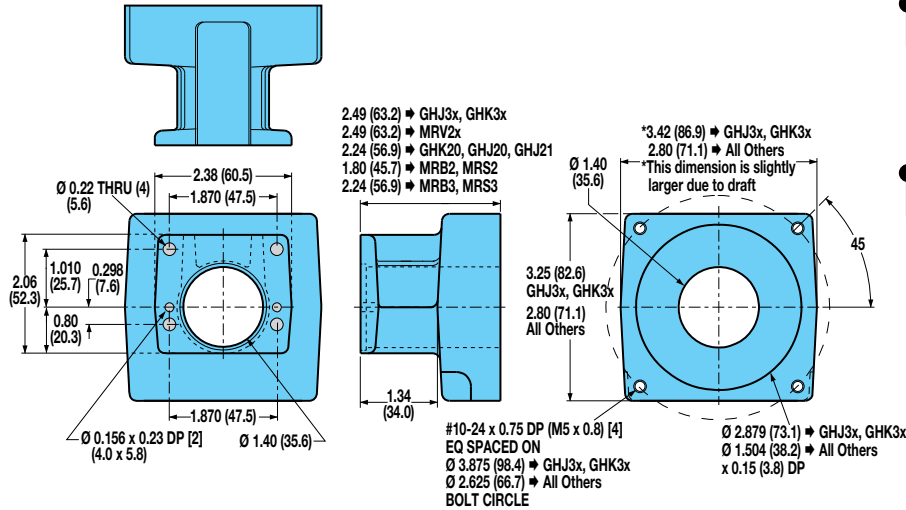

For gearhead dimensions and specifications, refer to literature #3600-4161

NOTE: MRB & MRV motors are discontinued contact Tolomatic for information on YMH (Your Motor Here)

BCS/MCS10: REVERSE PARALLEL MOUNTING

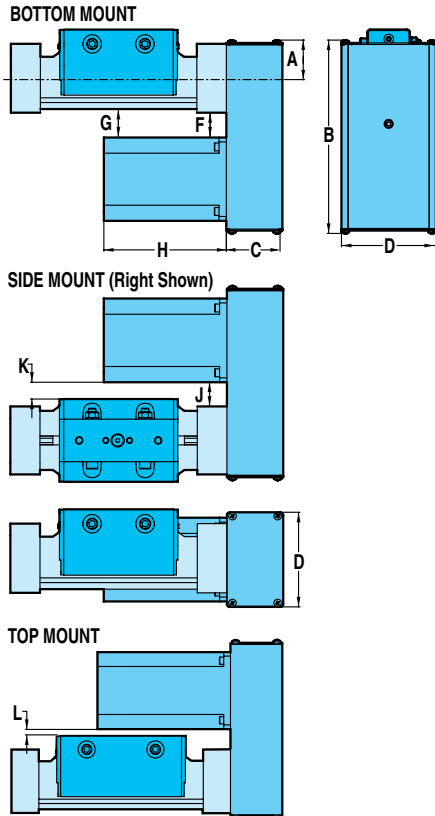

SPECIFICATIONS

NEMA 23 Frame	WEIGHT OF REDUCTION DRIVE				REDUCTION INERTIA AT MOTOR SHAFT			
	1:1		2:1		1:1		2:1	
	lbs	kg	lbs	kg	lb-in ²	kg-cm ²	lb-in ²	kg-cm ²
	2.06	0.9344	2.06	0.9344	0.070	0.2043	0.095	0.2767

REDUCTION EFFICIENCY: 0.95

DIMENSIONS

NEMA 23 Frame	A		B		C		D		F		G		H*		J		K		L		
	in.	mm	in.	mm	in.	mm	in.	mm	in.	mm	in.	mm	in.	mm	in.	mm	in.	mm	in.	mm	
	Size																				
21	4.75	120.7																			
22	5.75	146.1											1.54	39.1	1.83	46.5	1.11	28.2			
23	6.75	171.5																			
24	7.75	196.9																			

*H: Typical Motor Length



BCS15 Rodless Screw Drive Actuator

ACME SCREW SPECIFICATIONS

BCS15 US CONVENTIONAL ACME SCREW SPECIFICATIONS

CRITICAL SPEED WITH 5/8" US CONVENTIONAL ACME SCREW

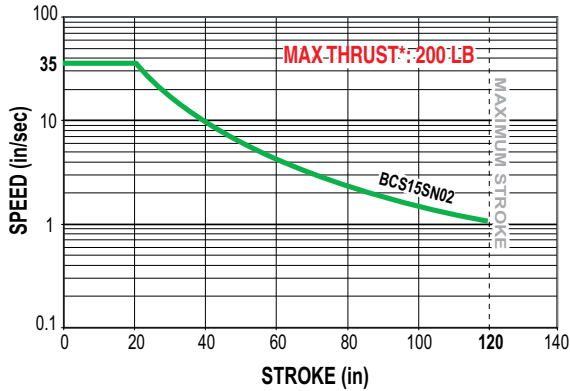

CRITICAL SPEED WITH 3/4" US CONVENTIONAL ACME SCREW

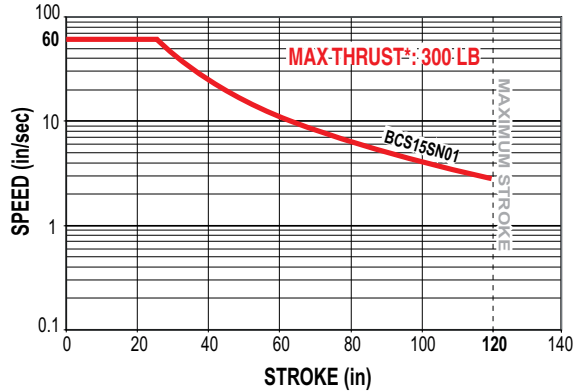

PV LIMITS: 5/8" 2TPI US CONVENTIONAL ACME SCREW

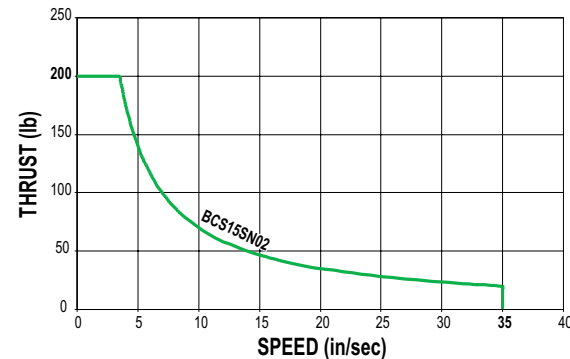

PV LIMITS: 3/4" 1TPI US CONVENTIONAL ACME SCREW

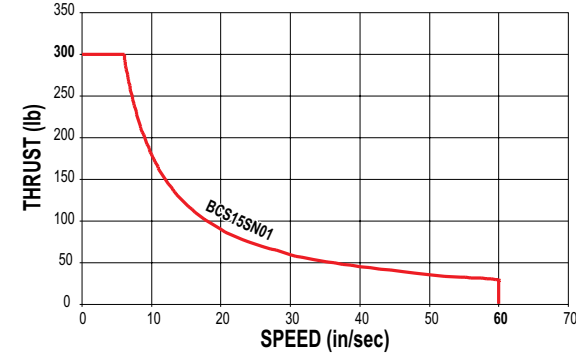

SN = Solid Nut
SNA = Solid Anti-backlash Nut

*** Maximum thrust is the maximum continuous dynamic thrust subject to Thrust x Velocity limitation.**

PV LIMITS: Any material which carries a sliding load is limited by heat buildup. The factors that affect heat generation rate in an application are the pressure on the nut in pounds per square inch and the surface velocity in feet per minute. The product of these factors provides a measure of the severity of an application.

$$\left(\frac{\text{P}}{\text{Thrust}} \right) \times \left(\frac{\text{V}}{\text{Speed}} \right) \leq 0.1$$

$$\left(\frac{\text{Thrust}}{\text{(Max. Thrust Rating)}} \right) \times \left(\frac{\text{Speed}}{\text{(Max. Speed Rating)}} \right) \leq 0.1$$

BCS15 Rodless Screw Drive Actuator

ACME SCREW SPECIFICATIONS

MCS15 METRIC ACME SCREW SPECIFICATIONS

CRITICAL SPEED WITH 15mm METRIC ACME SCREW

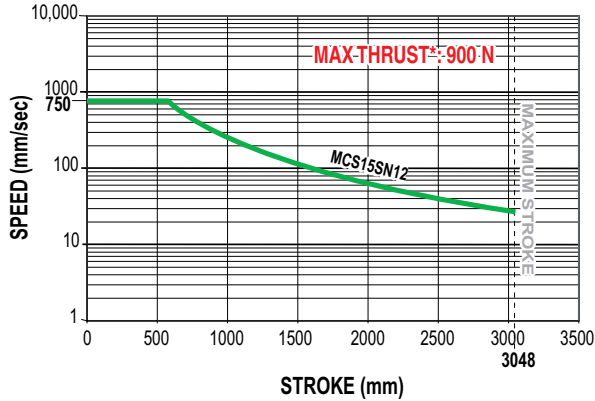

CRITICAL SPEED WITH 19mm METRIC ACME SCREW

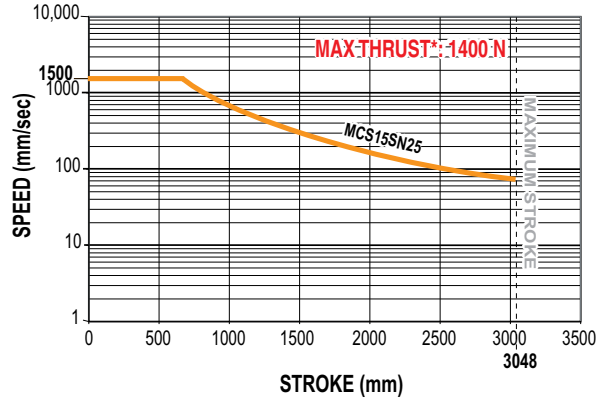

PV LIMITS: 15mm METRIC ACME SCREW w/12mm LEAD

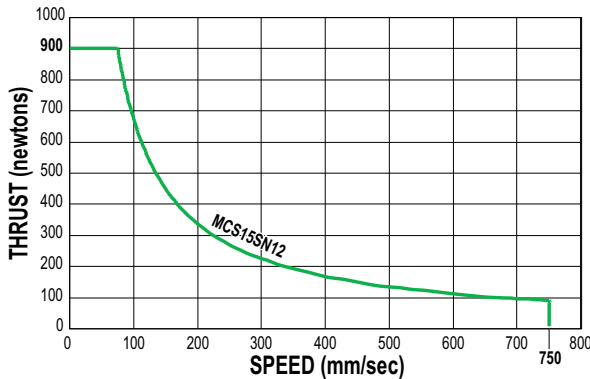

PV LIMITS: 19mm METRIC ACME SCREW w/25mm LEAD

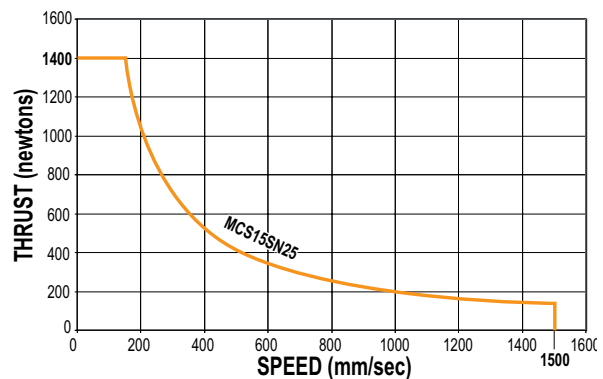

SN = Solid Nut



* Maximum thrust is the maximum continuous dynamic thrust subject to Thrust x Velocity limitation.

PV LIMITS: Any material which carries a sliding load is limited by heat buildup. The factors that affect heat generation rate in an application are the pressure on the nut in pounds per square inch and the surface velocity in feet per minute. The product of these factors provides a measure of the severity of an application.

$$\left(\frac{P}{(\text{Max. Thrust Rating})} \right) \times \left(\frac{V}{(\text{Max. Speed Rating})} \right) \leq 0.1$$

BCS15 Rodless Screw Drive Actuator

BALL SCREW SPECIFICATIONS

BCS/MCS15 BALL SCREW SPECIFICATIONS

CRITICAL SPEED WITH 1/2" US CONVENTIONAL BALL SCREW

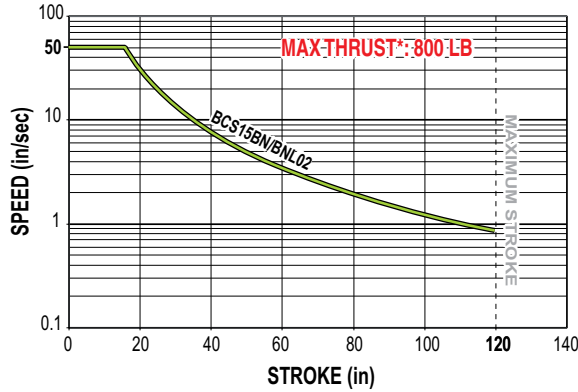

CRITICAL SPEED WITH 16mm METRIC BALL SCREW

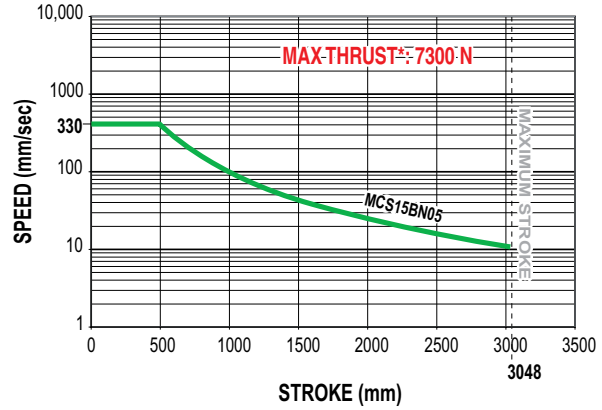

CRITICAL SPEED WITH 5/8" US CONVENTIONAL BALL SCREW

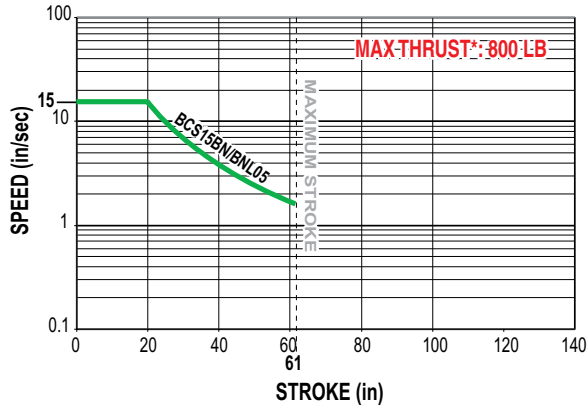

LIFE CALCULATION: 16mm METRIC BALL SCREW w/5mm LEAD

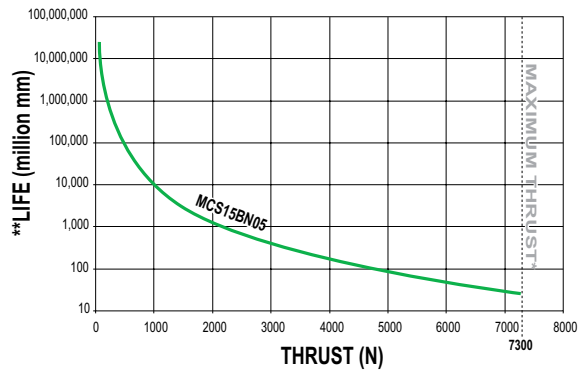

LIFE CALCULATION: 1/2" w/2TPI & 5/8" w/5TPI US CONVENTIONAL BALL SCREW

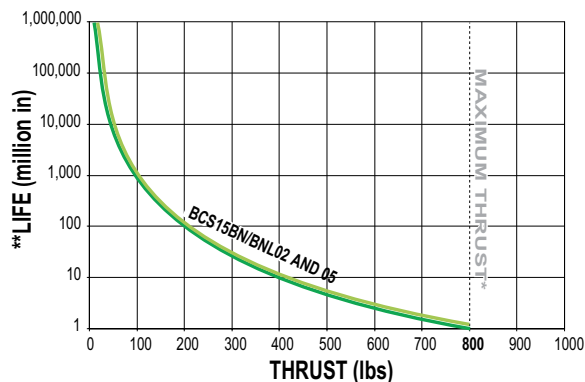

BN = Ball Nut
BNL = Ball Nut with Low-Backlash



*** Maximum thrust reflects 90% reliability for 1 million linear inches of travel.**

****Life indicates theoretical maximum life of screw only, under ideal conditions and does not indicate expected life of actuator.**

BCS15 Rodless Screw Drive Actuator

DIMENSIONS

BCS15/MCS15 ACTUATOR AND OPTIONS

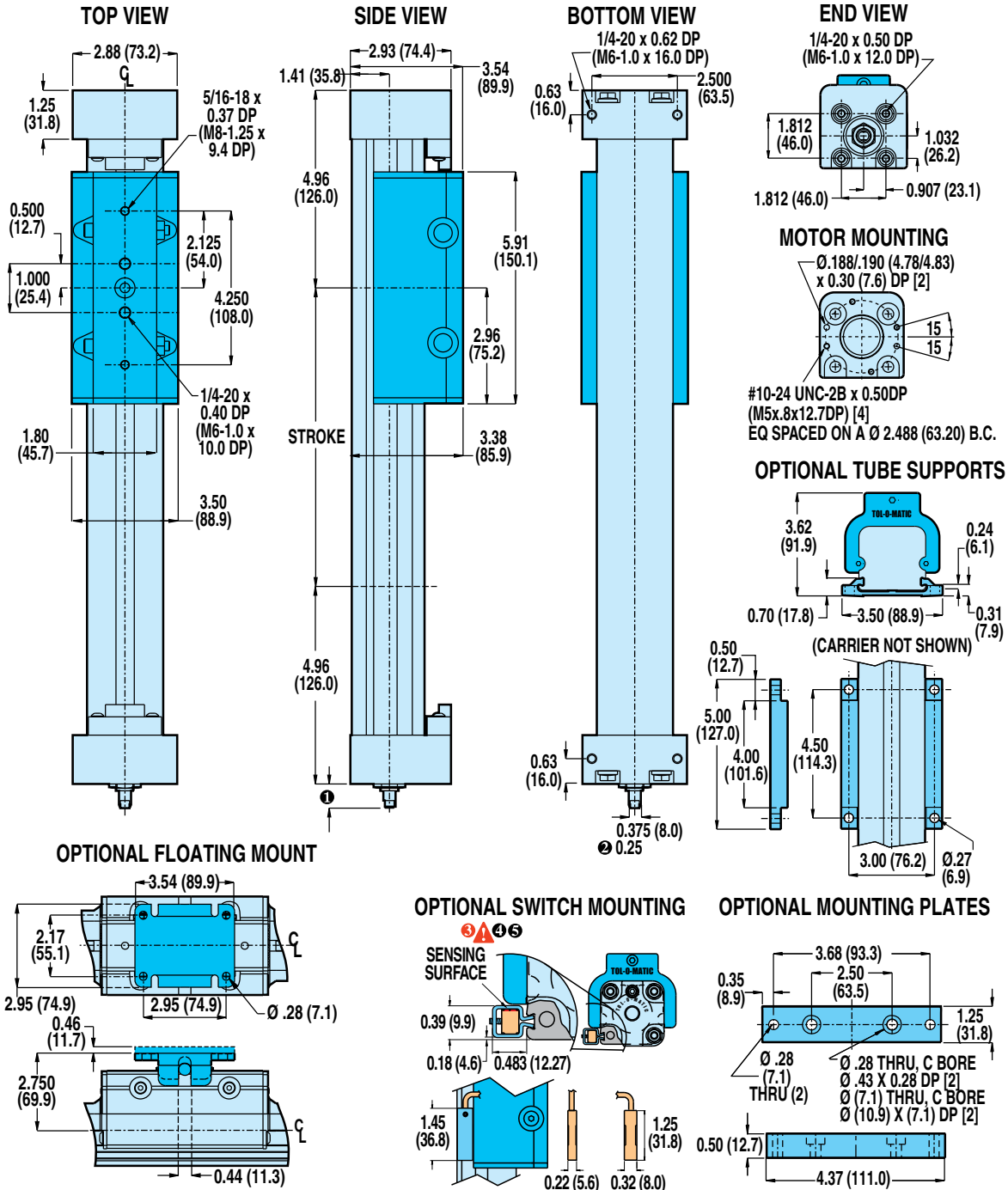

① **SHAFT LENGTH**

In-line mounting	0.65 (16.5)
Extended shaft for RP & 23-frame motor	1.94 (49.3)
Extended shaft for RP & 34-frame motor	2.15 (54.6)
Extended shaft for RP & 40-frame motor	2.31 (58.7)
Extended shaft for purchases prior to 6/24/02	1.90 (48.2)

② **FOR 1/2" 2TPI BALL-SCREW STYLE ONLY**

⚠ CAUTION: DO NOT OVERTIGHTEN SWITCH HARDWARE WHEN INSTALLING

④ **NOTE:** The scored face of the switch indicates the sensing surface and must face toward the magnet

⑤ **NOTE:** Some actuators require switch mounting on a specific side of the actuator. Call Tolomatic 1-800-328-2174 for details

BCS15 Rodless Screw Drive Actuator

DIMENSIONS

BCS/MCS15: IN-LINE MOUNT FOR MOTORS AND GEARHEADS

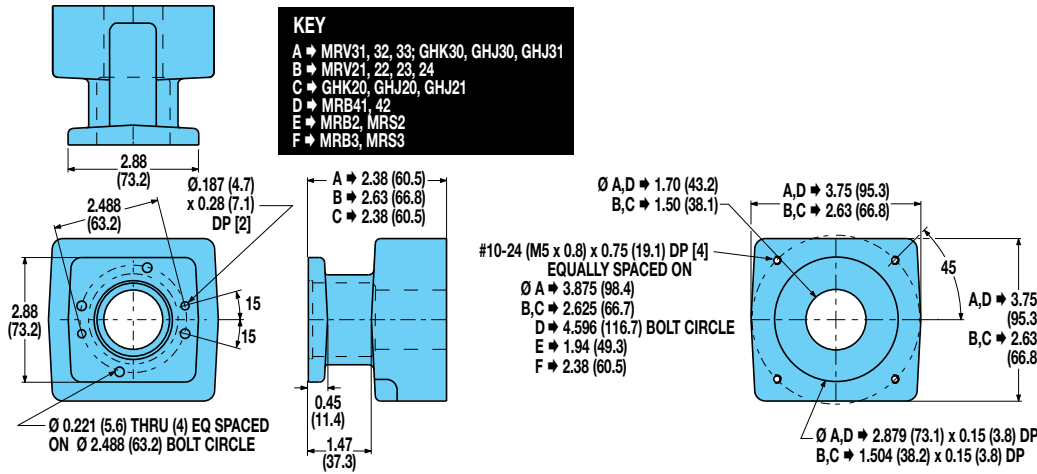

BCS/MCS15: REVERSE PARALLEL MOUNTING

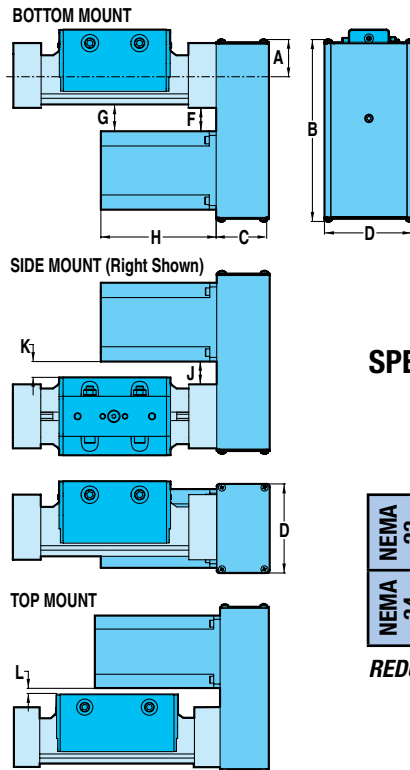

SPECIFICATIONS

	WEIGHT OF REDUCTION DRIVE				REDUCTION INERTIA AT MOTOR SHAFT			
	1:1		2:1		1:1		2:1	
	lbs	kg	lbs	kg	lb-in ²	kg-cm ²	lb-in ²	kg-cm ²
NEMA 23 Frame	2.17	0.9843	2.40	1.0886	0.070	0.2043	0.095	0.2767
NEMA 34 Frame	2.61	1.1839	2.84	1.2882	0.070	0.2043	0.095	0.2767

REDUCTION EFFICIENCY: 0.95

DIMENSIONS

	A		B		C		D		F		G		H*		J		K		L		
	in.	mm	in.	mm	in.	mm	in.	mm	in.	mm	in.	mm	in.	mm	in.	mm	in.	mm	in.	mm	
NEMA 23 Frame	1.44	36.6	7.46	189.4	2.13	54.0	3.25	82.6	1.70	43.2	1.85	47.0	21	4.75	120.7	1.67	42.4	1.86	47.2	0.98	25.3
													22	5.75	146.1						
													23	6.75	171.5						
													24	7.75	196.9						
NEMA 34 Frame	2.12	53.8	8.14	206.6	2.38	60.3	4.00	101.6	1.05	26.7	1.21	30.7	31	6.11	155.2	1.02	25.9	1.21	30.7	0.33	8.9
													32	7.36	186.9						
													33	8.61	218.7						

*H: Typical Motor Length

BCS20 Rodless Screw Drive Actuator

ACME SCREW SPECIFICATIONS



BCS/MCS20 ACME SCREW SPECIFICATIONS

CRITICAL SPEED WITH 3/4" US CONVENTIONAL ACME SCREW

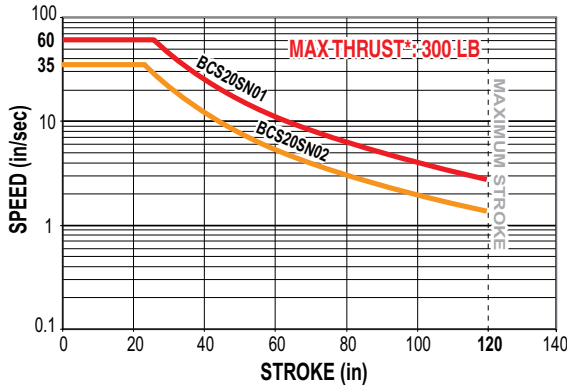

CRITICAL SPEED WITH 19mm METRIC ACME SCREW

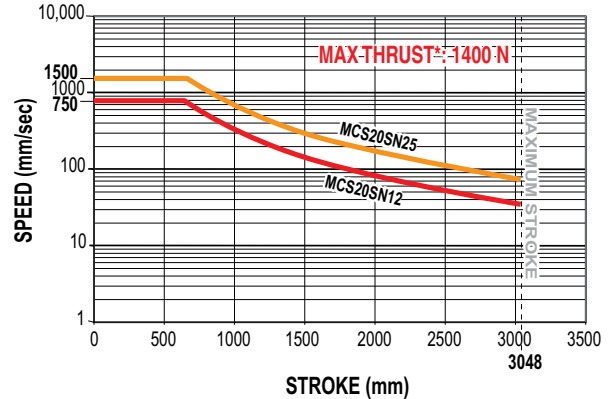

PV LIMITS: 3/4" 1TPI US CONVENTIONAL ACME SCREW

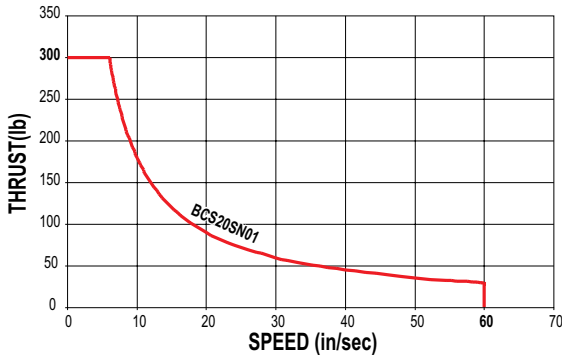

PV LIMITS: 19mm METRIC ACME SCREW w/25mm LEAD

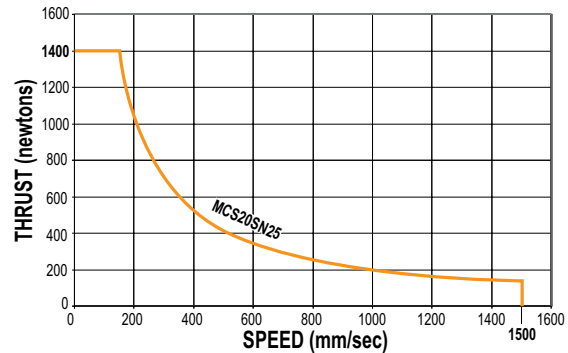

PV LIMITS: 3/4" 2TPI US CONVENTIONAL ACME SCREW

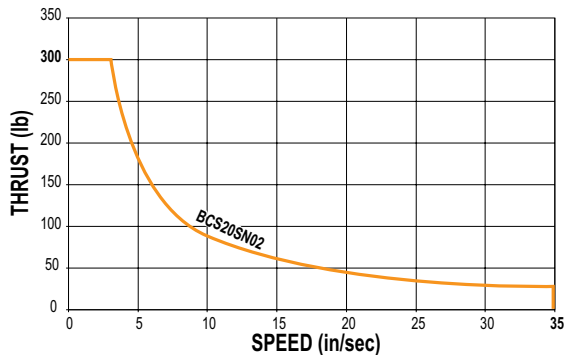

PV LIMITS: 19mm METRIC ACME SCREW w/12mm LEAD

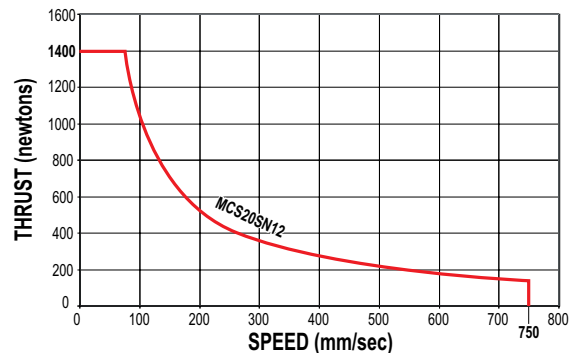

SN = Solid Nut
 SNA = Solid Anti-backlash Nut

 * Maximum thrust is the maximum continuous dynamic thrust subject to Thrust x Velocity limitation.

PV LIMITS: Any material which carries a sliding load is limited by heat buildup. The factors that affect heat generation rate in an application are the pressure on the nut in pounds per square inch and the surface velocity in feet per minute. The product of these factors provides a measure of the severity of an application.

$$\frac{P}{(\text{Max. Thrust Rating})} \times \frac{V}{(\text{Max. Speed Rating})} \leq 0.1$$

BCS20 Rodless Screw Drive Actuator

BALL SCREW SPECIFICATIONS

BCS20/MCS20 BALL SCREW SPECIFICATIONS

CRITICAL SPEED WITH 3/4" US CONVENTIONAL BALL SCREW, 2TPI

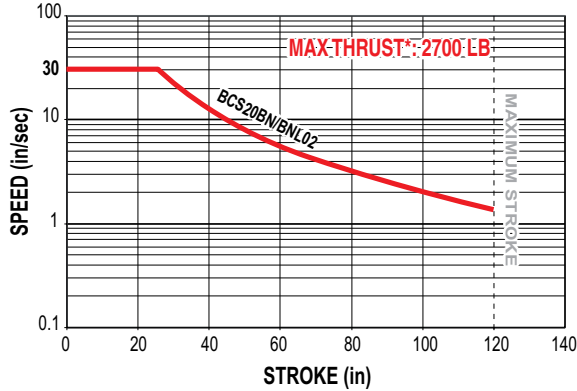

LIFE CALCULATION: 3/4" US CONVENTIONAL BALL SCREW, 5TPI

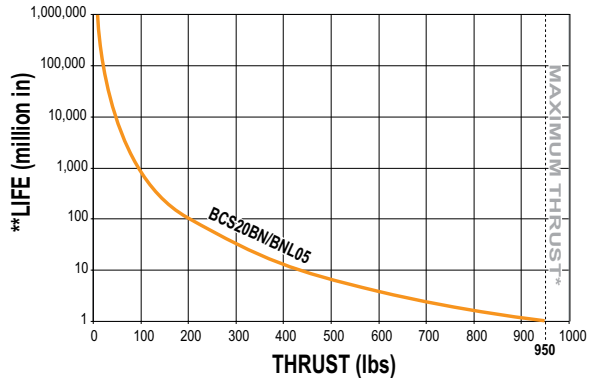

LIFE CALCULATION: 3/4" US CONVENTIONAL BALL SCREW, 2TPI

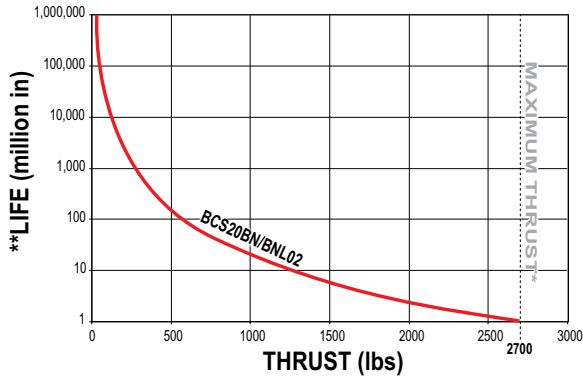

CRITICAL SPEED WITH 20mm METRIC BALL SCREW

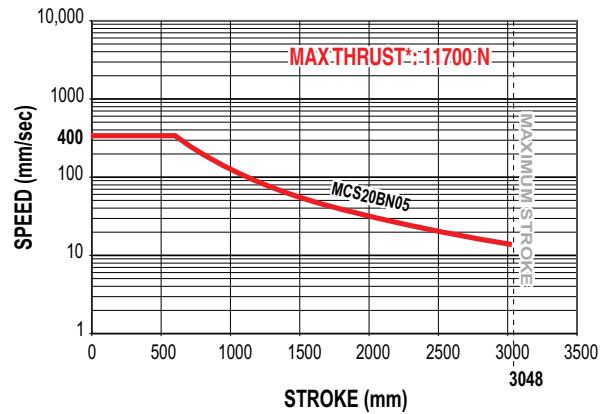

CRITICAL SPEED WITH 3/4" US CONVENTIONAL BALL SCREW, 5TPI

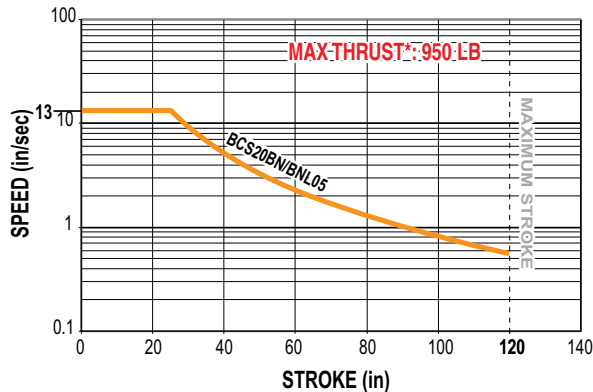

LIFE CALCULATION: 20mm METRIC BALL SCREW w/5mm LEAD

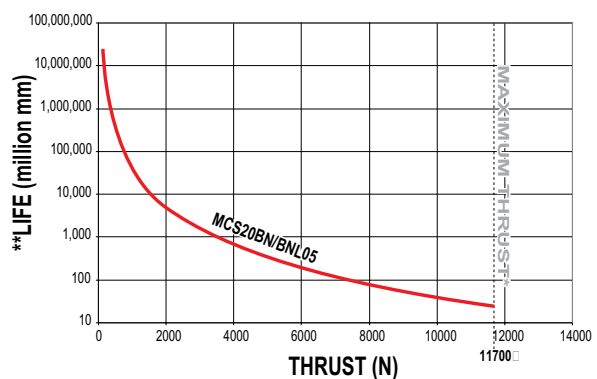

BN = Ball Nut
 BNL = Ball Nut with Low-Backlash



* Maximum thrust reflects 90% reliability for 1 million linear inches of travel.

**Life indicates theoretical maximum life of screw only, under ideal conditions and does not indicate expected life of actuator.

BCS20 Rodless Screw Drive Actuator

DIMENSIONS

BCS20 ACTUATOR AND OPTIONS

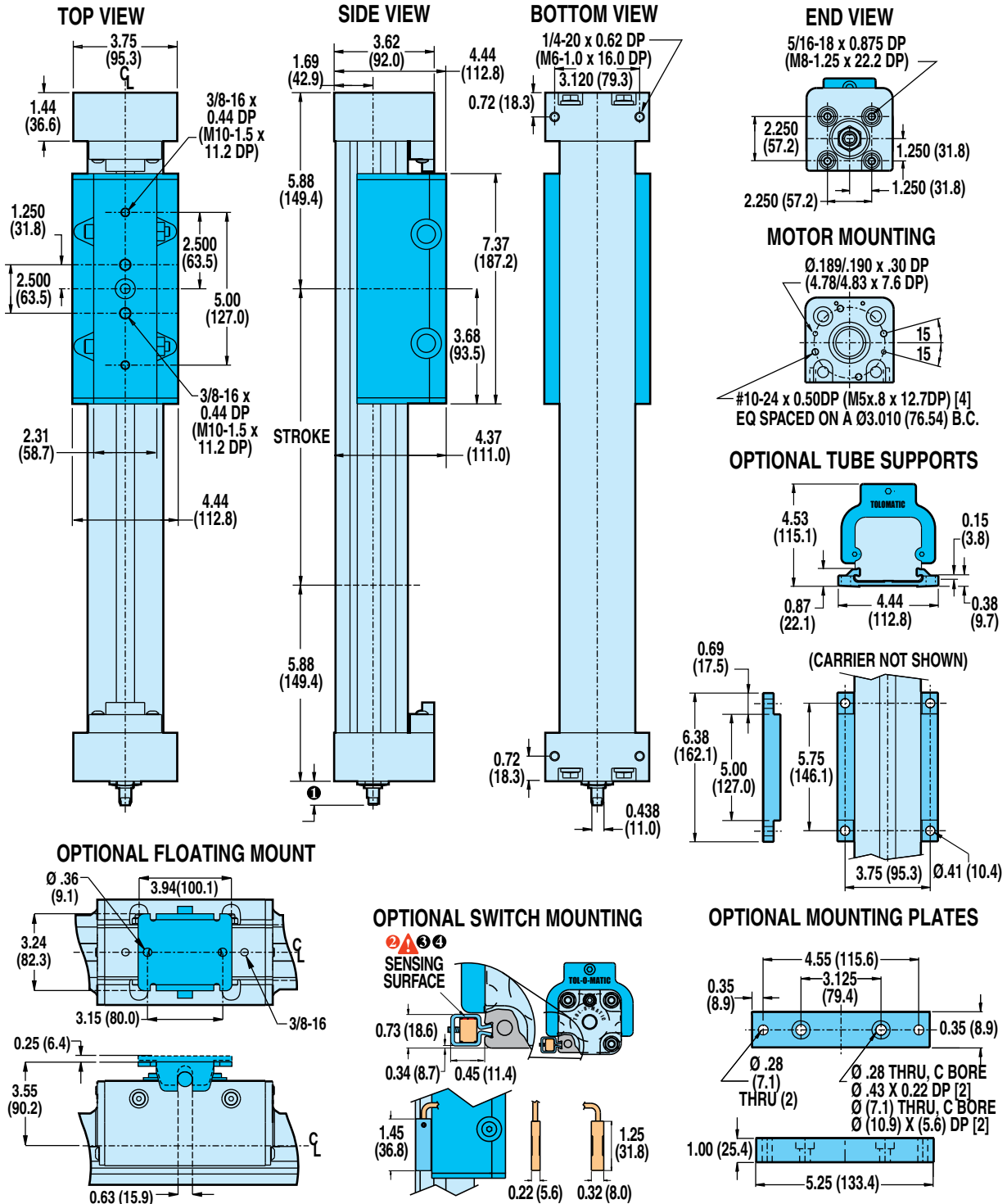

① **SHAFT LENGTH**

In-line mounting	0.78 (19.8)
Extended shaft for RP & 23-frame motor	2.16 (54.9)
Extended shaft for RP & 34-frame motor	2.16 (54.9)
Extended shaft for RP & 40-frame motor	2.31 (58.7)
Extended shaft for purchases prior to 6/24/02	2.28 (57.9)

⚠ **CAUTION: DO NOT OVERTIGHTEN SWITCH HARDWARE WHEN INSTALLING**

Ⓜ **NOTE: The scored face of the switch indicates the sensing surface and must face toward the magnet**

④ **NOTE: Some actuators require switch mounting on a specific side of the actuator. Call Tolomatic 1-800-328-2174 for details**

BCS20 Rodless Screw Drive Actuator

DIMENSIONS

BCS/MCS20: IN-LINE MOUNT FOR MOTORS AND GEARHEADS

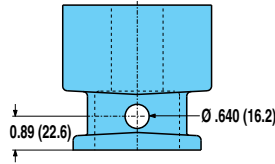

MOTORS KEY

- A → MRV3x, MRB3x
- B → MRV2x
- C → GHK20x, GHJ20x, GHJ21x, GHJ30x, GHJ31x, GHK30
- D → MRB4x
- E → MRB2, MRS2
- F → MRB3, MRS3

For gearhead dimensions and specifications, refer to literature #3600-4161

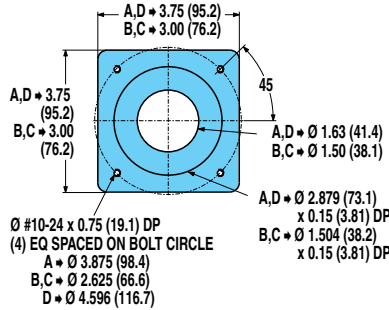
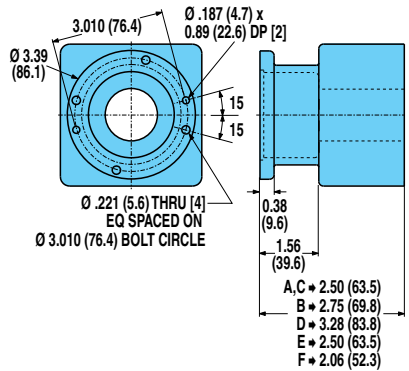

NOTE: MRB & MRV motors are discontinued contact Tolomatic for information on YMH (Your Motor Here)

BCS/MCS20: REVERSE PARALLEL MOUNTING

BOTTOM MOUNT

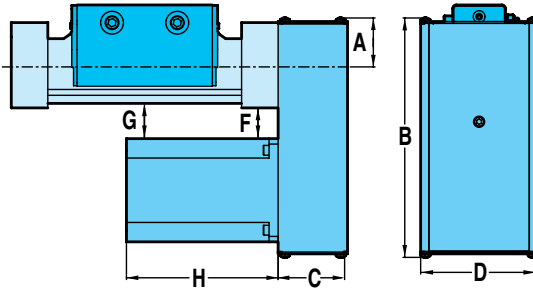

TOP MOUNT

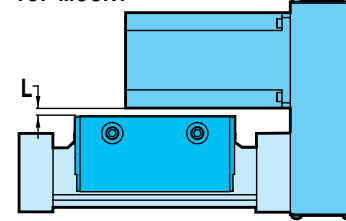

SIDE MOUNT (Right Shown)

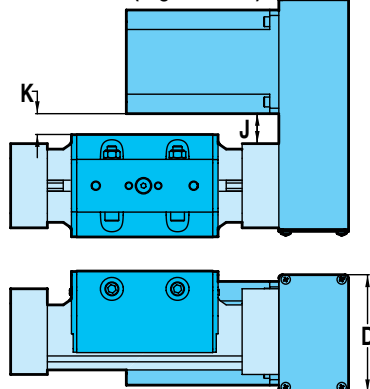

SPECIFICATIONS

	WEIGHT OF REDUCTION DRIVE				REDUCTION INERTIA AT MOTOR SHAFT			
	1:1		2:1		1:1		2:1	
	lbs	kg	lbs	kg	lb-in ²	kg-cm ²	lb-in ²	kg-cm ²
NEMA 23 Frame	3.11	1.41	3.27	1.48	0.118	0.3447	0.100	0.2928
NEMA 34 Frame	3.18	1.44	3.34	1.51	0.118	0.3447	0.100	0.2928

REDUCTION EFFICIENCY: 0.95

DIMENSIONS

	A		B		C		D		F		G		H*		J		K		L		
	in.	mm	in.	mm	in.	mm	in.	mm	in.	mm	in.	mm	in.	mm	in.	mm	in.	mm	in.	mm	
NEMA 23 Frame	1.44	36.6	9.31	236.5	2.38	60.3	4.00	101.6	2.44	61.8	2.50	63.5	21	4.75	120.7	2.25	57.2	2.56	65.0	1.38	34.9
													22	5.75	146.1						
													23	6.75	171.5						
													24	7.75	196.9						
NEMA 34 Frame	1.96	49.7	9.83	249.6	2.38	60.3	4.00	101.6	1.79	45.5	1.86	47.2	31	6.11	155.2	1.61	40.9	1.92	48.8	0.73	18.5
													32	7.36	186.9						
													33	8.61	218.7						

*H: Typical Motor Length

BCS Rodless Screw Drive Actuators

SWITCHES



There are 10 sensing choices: DC reed, form A (open) or form C (open or closed); AC reed (Triac, open); Hall-effect, sourcing, PNP (open); Hall-effect, sinking, NPN (open); each with either flying leads or QD (quick disconnect). Commonly used to send analog signals to PLC (programmable logic controllers), TLL, CMOS circuit or other controller device. These switches are activated by the actuator's magnet.

Switches contain reverse polarity protection. QD cables are shielded; shield should be terminated at flying lead end.

If necessary to remove factory installed switches, be sure to reinstall on the same side of actuator with scored face of switch toward internal magnet.

SPECIFICATIONS

ORDER CODE	REED DC				REED AC		HALL-EFFECT DC			
	R T	R M	B T	B M	C T	C M	T T	T M	K T	K M
PART NUMBER	3600-9082	3600-9083	3600-9084	3600-9085	3600-9086	3600-9087	3600-9088	3600-9089	3600-9090	3600-9091
LEAD	5m	QD*	5m	QD*	5m	QD*	5m	QD*	5m	QD*
CABLE SHIELDING	Unshielded	Shielded†	Unshielded	Shielded†	Unshielded	Shielded†	Unshielded	Shielded†	Unshielded	Shielded†
SWITCHING LOGIC	"A" Normally Open		"C" Normally Open or Closed		Triac Normally Open		PNP (Sourcing) Normally Open		NPN (Sinking) Normally Open	
MECHANICAL CONTACTS	Single-Pole Single-Throw		Single-Pole Double-Throw		Single-Pole Single-Throw		NO, These Are Solid State Components			
COIL DIRECT	Yes		Yes		Yes		—			
POWER LED	None	None		None		None	None		None	None
SIGNAL LED	Red	None		None		Red	Red		Red	Red
OPERATING VOLTAGE	200 Vdc max.		120 Vdc max.		120 Vac max.		5 - 25 Vdc			
OUTPUT RATING	—		—		—		25 Vdc, 200mA dc			
OPERATING TIME	0.6 msec max. (including bounce)		0.7 msec max. (including bounce)		—		< 10 micro sec.			
OPERATING TEMPERATURE	-40°F [-40°C] to 158°F [70°C]						0°F [-18°C] to 150°F [66°C]			
RELEASE TIME	1.0 msec. max.		—		—		—			
ON TRIP POINT	—		—		—		150 Gauss maximum			
OFF TRIP POINT	—		—		—		40 Gauss minimum			
**POWER RATING (WATTS)	10.0 §		3.0 §§		10.0		5.0			
VOLTAGE DROP	2.6 V typical at 100 mA		NA		—		—			
RESISTANCE	0.1 Ω Initial (Max.)		—		—		—			
CURRENT CONSUMPTION	—		—		1 Amp at 86°F [30°C]	0.5 Amp at 140°F [60°C]	200 mA at 25 Vdc			
FREQUENCY	—		—		47 - 63 Hz		—			
CABLE MIN. BEND RADIUS	STATIC	0.630" [16mm]								
	DYNAMIC	Not Recommended								

CAUTION: DO NOT OVER TIGHTEN SWITCH HARDWARE WHEN INSTALLING!

**** WARNING:** Do not exceed power rating (Watt = Voltage X Amperage). Permanent damage to sensor will occur.

*QD = Quick Disconnect; Male coupler is located 6" [152mm] from sensor, Female coupler to flying lead (part #2503-1025) distance is 197" [5m] also see Cable Shielding specification above

REPLACEMENT OF QD SWITCHES MANUFACTURED BEFORE JULY 1, 1997: It will be necessary to replace or rewire the female end coupler.



Reed Switch Life Expectancy: Up to 200,000,000 cycles (depending on load current, duty cycle and environmental conditions)

†Shielded from the female quick disconnect coupler to the flying leads. Shield should be terminated at flying lead end.

§ Maximum current 500mA (not to exceed 10VA) Refer to Temperature vs. Current graph and Voltage Derating graph

§§ Maximum current 250mA (not to exceed 3VA) Refer to Temperature vs. Current graph and Voltage Derating graph

BCS Rodless Screw Drive Actuators

PERFORMANCE

TEMP. vs CURRENT, DC REED

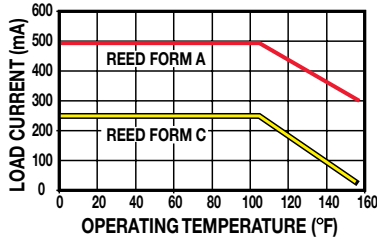

TEMP. vs CURRENT, AC REED

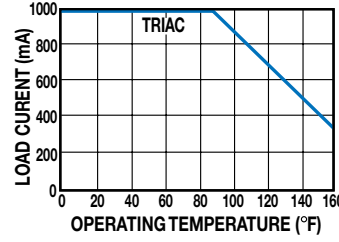

VOLTAGE DERATING, DC REED

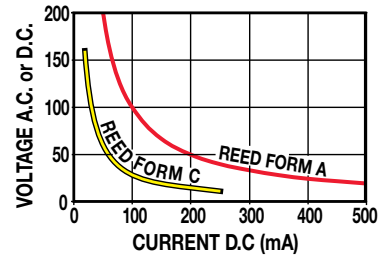

WIRING DIAGRAMS

R**T** & **R****M** DC REED, FORM A

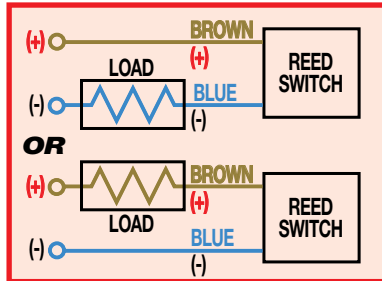

C**T** & **C****M** AC REED, TRIAC

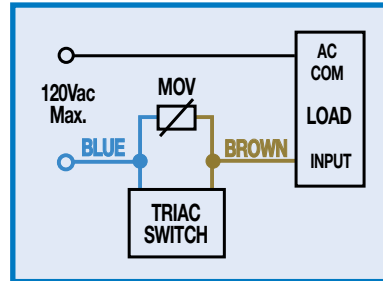

INSTALLATION INFORMATION



⚠
 THE NOTCHED
 FACE OF THE
 SWITCH INDICATES
 THE SENSING
 SURFACE AND
 MUST FACE
 TOWARD THE
 MAGNET.

B**T** & **B****M** DC REED, FORM C

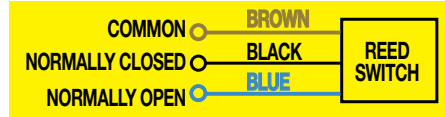

T**T** & **T****M** HALL-EFFECT, SOURCING, PNP

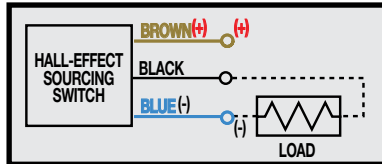

K**T** & **K****M** HALL-EFFECT, SINKING, NPN

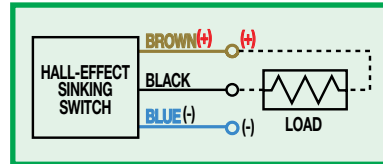

COMPILE APPLICATION REQUIREMENTS

APPLICATION DATA WORKSHEET

Fill in known data. Not all information is required for all applications

ORIENTATION

- Horizontal Side

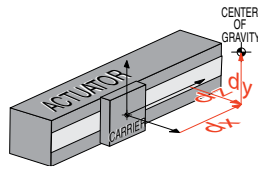
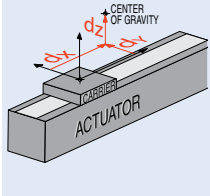

- Horizontal Down Vertical

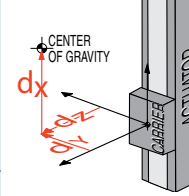
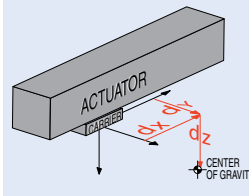

- Angled °

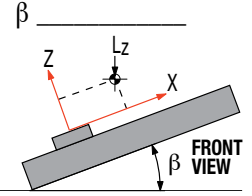
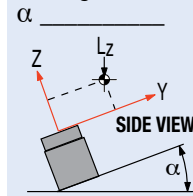

- Load attached to carrier OR Load supported by other mechanism

DISTANCE FROM CENTER OF CARRIER TO LOAD CENTER OF GRAVITY

d_x _____
 d_y _____
 d_z _____

- inch (U.S. Standard) millimeter (Metric)

STROKE LENGTH _____

- inch (S I) (U.S. Standard) millimeters (Metric)

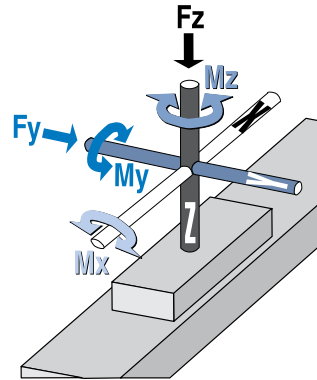

BENDING MOMENTS APPLIED TO CARRIER

M_x _____
 M_y _____
 M_z _____

- in.-lbs. (U.S. Standard)

- N-m (Metric)

PRECISION

Repeatability _____

- inch millimeters

OPERATING ENVIRONMENT

Temperature, Contamination, etc.

NOTE: If load or force on carrier changes during cycle use the highest numbers for calculations

LOAD _____

- lb. (U.S. Standard) kg. (Metric)

THRUST REQUIRED

- lbf. (U.S. Standard) N (Metric)

F_z _____
 F_y _____

MOTION PROFILE

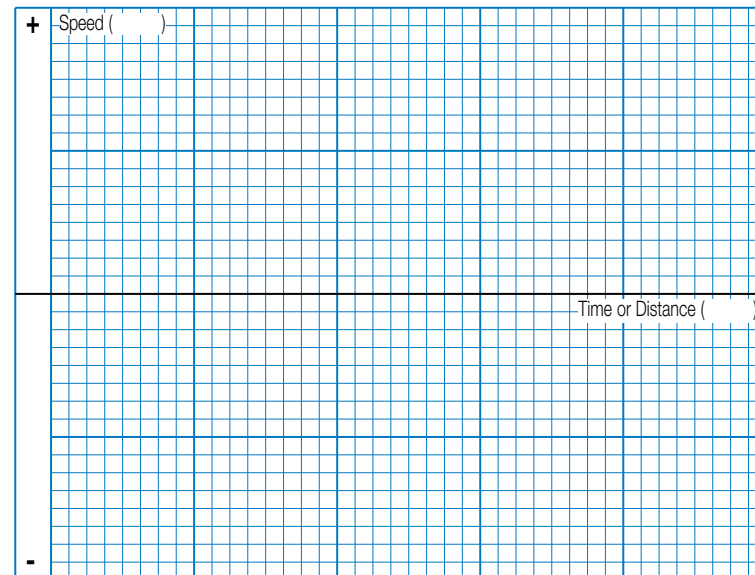

Graph your most demanding cycle, including accel/decel, velocity and dwell times. You may also want to indicate load variations and I/O changes during the cycle. Label axes with proper scale and units.

MOVE PROFILE

Move Distance _____

- inch millimeters

Dwell Time After Move _____

Max. Speed _____

- in/sec mm/sec

MOVE TIME _____

- sec

NO. OF CYCLES _____

- per minute per hour

CONTACT INFORMATION

Name, Phone, Email _____
 Co. Name, Etc. _____

SELECTION GUIDELINES

The process of selecting a load bearing actuator for a given application can be complex. It is highly recommended that you contact Tolomatic or a Tolomatic Distributor for assistance in selecting the best actuator for your application. The following overview of the selection guidelines are for educational purposes only.

1 CHOOSE ACTUATOR SIZE

Choose an actuator that has the thrust, speed and moment load capacity to move the load. Use the Critical Speed graphs (page BCS_4-5) for the screw and the Moment and Load Capacity table (pg. BCS_9) for the actuator.

2 COMPARE LOAD TO MAXIMUM LOAD CAPACITIES

Calculate the application load (combination of load mass and forces applied to the carrier) and application bending moments (sum of all moments M_x , M_y , and M_z applied to the carrier). Be sure to evaluate the magnitude of dynamic inertia moments. When a rigidly attached load mass is accelerated or decelerated, its inertia induces bending moments on the carrier. Careful attention to how the load is decelerated at the end of the stroke is required for extended actuator performance and application safety. If either load or any of your moments exceed figures indicated in the Moment and Load Capacity table (pg. BCS_9) for the actuator consider:

- 1) Higher capacity bearing style
- 2) A larger actuator size
- 3) Auxiliary carrier
- 4) External guide system

3 CALCULATE LOAD FACTOR L_F

For loads with a center of gravity offset from the carrier account for both applied (static) and dynamic loads. The load factor (L_F) must not exceed the value of 1.

$$L_F = \frac{M_x}{M_{x_{max}}} + \frac{M_y}{M_{y_{max}}} + \frac{M_z}{M_{z_{max}}} + \frac{F_y}{F_{y_{max}}} + \frac{F_z}{F_{z_{max}}} \leq 1$$

If L_F does exceed the value of 1, consider the four choices listed in step #2.

4 ESTABLISH YOUR MOTION PROFILE AND CALCULATE ACCELERATION RATE

Using the application stroke length and maximum carrier velocity (or time to complete the linear motion), establish the motion profile. Select either triangular (accel-decel) or trapezoidal (accel-constant speed-decel) profile. Now calculate the maximum acceleration and deceleration rates of the move. Speed should not exceed critical speed value as shown on graphs (page BCS_4-5) for the screw/nut combination cho-

SPEED FACTOR

FOR APPLICATIONS WITH HIGH SPEED OR SIGNIFICANT SHOCK AND VIBRATION: Calculated values of loads and bending moments must be increased by speed factor from the graph below to obtain full rated life of profiled rail bearing system.

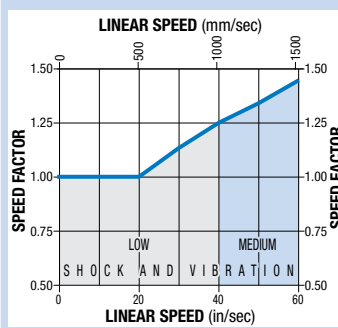

sen. Also, do not exceed safe rates of dynamic inertia moments determined in step #3.

5 SELECT THE LEAD SCREW

Based on the application requirements for accuracy, backlash, quiet operation, life, etc. select the appropriate lead screw type (Acme screw with a solid nut or ball screw with a standard or anti-backlash nut) and the pitch (lead). For additional information on screw selection, consult "Which Screw? Picking the Right Technology" (#9900-4644) available at www.tolomatic.com.

6 SELECT MOTOR (GEARHEAD IF NECESSARY) AND DRIVE

To help select a motor and drive, use the sizing equations located in the Engineering Resources section [ENGR] to calculate the application thrust and torque requirements. Refer to Motor sections [MRV] & [MRS] to determine the motor and drive.

7 DETERMINE TUBE SUPPORT/MOUNTING PLATE REQUIREMENTS

- Consult the Support Recommendations graph for the model selected (page BCS_8)
- Cross reference the application load and maximum distance between supports
- Select the appropriate number of tube supports, and mounting plates if required for motor and adapter clearance.

8 CONSIDER OPTIONS

- Choose metric or inch (US conventional) load mounting.
- Switches - Reed, Solid State PNP or NPN, all available normally open or normally closed
- **FL** Floating mount bracket - used when lack of parallelism occurs between the actuator and an externally guided and supported load

S SOLID BEARING 2:1 RULE

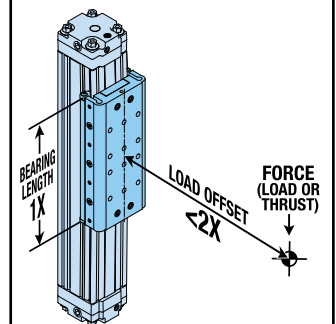

For applications using **BCS** actuator, binding or interrupted motion may occur if the load offset is equal to or greater than twice the bearing length (1X). **LOAD OFFSET** is defined as: the distance from the applied force (or the load center of gravity) to the centerline of the carrier.

If the load offset cannot be changed consider:

- 1.) Higher capacity bearing style
- 2.) Larger Bore Cylinder
- 3.) Auxiliary Carrier
- 4.) Add External Guides

BCS Rodless Screw Drive Actuators

ORDERING

BASE MODEL SPECIFICATIONS

BCS **20** **BN02** **SK45** **RPL1**

OPTIONS SPECIFICATIONS

DC18 **KT2** **MP4**

MODEL TYPE

BCS BCS Series US Conventional Screw Drive
MCS MCS Series Metric Screw Drive

TUBE BORE DIAMETER

10 1-inch (25 mm) bore
15 1-1/2-inch (40 mm) bore
20 2-inch (50 mm) bore

NUT/SCREW CONFIGURATION

INCH (US Conventional) MODELS

SOLID NUT / PITCH (turn/in)	SERIES
SN01	BCS10, 15, 20
SN02	BCS10, 15, 20
SNA02	BCS10, 15
SN05	BCS10, 15

BALL NUT / PITCH (turn/in)	SERIES
BN02	BCS15, 20
BNL02	BCS15, 20
BN05	BCS15, 20
BNL05	BCS15, 20
BN08	BCS10
BNL08	BCS10

METRIC MODELS

SOLID NUT / LEAD (mm/turn)	SERIES
SN12	MCS10, 15, 20
SN25	MCS10, 15, 20

BALL NUT / LEAD (mm/turn)	SERIES
BN08	MCS10
BNL08	MCS10
BN05	MCS15, 20
BNL05	MCS15, 20

STROKE LENGTH

SK Stroke, then enter desired stroke length in decimal inches

MOTOR MOUNTING / REDUCTIONS

(must choose one)

LMI In-Line mounting
LME23 Ext. shaft for RP & 23 frame motor
LME34 Ext. shaft for RP & 34 frame motor
LME40 Ext. shaft for RP & 40 frame motor
****LMX** Extended shaft - old style (see note)
****For replacement actuators with extended motor shafts purchased prior to 6/24/02 use LMX**

▲ A motor size and code must be selected when specifying a reverse-parallel mounting configuration.

RPL1 1:1 Reverse-Parallel mount left
RPR1 1:1 Reverse-Parallel mount right
RPB1 1:1 Reverse-Parallel mount bottom
RPT1 1:1 Reverse-Parallel mount top
RPL2 2:1 Reverse-Parallel mount left
RPR2 2:1 Reverse-Parallel mount right
RPB2 2:1 Reverse-Parallel mount bottom
RPT2 2:1 Reverse-Parallel mount top

AUXILIARY CARRIER

DC Auxiliary Carrier, then center-to-center spacing desired in decimal inches. (Center-to-Center spacing will add to overall dead length and will not subtract from the stroke length)

SWITCHES

RM Reed Switch (Form A) with 5-meter lead/QD (*quick-disconnect*), & quantity
RT Reed Switch (Form A) with 5-meter lead, and quantity desired
BM Reed Switch (Form C) with 5-meter lead/QD, and quantity desired
BT Reed Switch (Form C) with 5-meter lead, and quantity desired
KM Hall-effect Sinking Switch with 5-meter lead/QD, and quantity desired
KT Hall-effect Sinking Switch with 5-meter lead, and quantity desired
TM Hall-effect Sourcing Switch with 5-meter lead/QD, and quantity desired
TT Hall-effect Sourcing Switch with 5-meter lead, and quantity desired
CM TRIAC Switch with 5-meter lead/QD, and quantity desired
CT TRIAC Switch with 5-meter lead, and quantity desired

SUPPORTS AND MOUNTING PLATES

(both may be selected)

TS Tube Supports plus quantity desired
MP Mounting Plates plus quantity desired

FLOATING MOUNT

FL Floating Mount Bracket

Your Motor Here

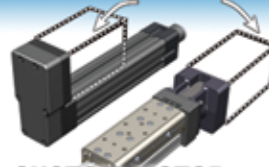

CUSTOM MOTOR MOUNTS. 15 DAYS.

Tolomatic electric actuators are compatible with over 60 motor manufacturers and hundreds of motor models.

▲ Not all codes listed are compatible with all options.

Use the Sizing Software to determine available options and accessories based on your application requirements.

FIELD RETROFIT KITS

ITEM	B3S10	B3S15	B3S20	M3S10	M3S15	M3S20
Tube Supports	4510-1010	4515-1010	4520-1010	4510-1010	4515-1010	4520-1010
Mounting Plates	0910-9133	0915-9135	0920-9038	0510-9105	0515-9138	0520-9105