

Parameter	Remarks	Symbol	Unit	TB12		TB15		TB30	
Winding type				N	S	N	S	N	S
Motor type, max voltage ph-ph				3-phase synchronous Iron core, 400V _{ac rms} (600V _{dc})					
Ultimate Force @ 10°C/s increase	magnet @ 25°C	F _u	N	1800		2250		4500	
Peak Force @ 6°C/s increase	magnet @ 25°C	F _p	N	1600		2000		4000	
Continuous Force*	coils @ 100°C	F _c	N	760		950		1900	
Maximum Speed**	@ 560 V	v _{max}	m/s	3	6	2.5	6	2.5	6
Motor Force Constant	mount. sfc. @ 20°C	K	N/A _{rms}	186	93	225	93	225	93
Motor Constant	coils @ 25°C	S	N ² /W	1750		2150		4300	
Ultimate Current	magnet @ 25°C	I _u	A _{rms}	13.0	26	13.5	33	27	66
Peak Current	magnet @ 25°C	I _p	A _{rms}	10.0	20	10.0	25	20	50
Maximum Continuous Current	coils @ 100°C	I _c	A _{rms}	4.1	8.2	4.2	10.2	8.5	20.5
Back EMF Phase-Phase _{peak}		B _{emf}	V / m/s	152	76	183	76	183	76
Resistance per Phase*	coils @ 25°C ex. cable	R _f	Ω	6.3	1.6	7.6	1.3	3.8	0.65
Induction per Phase	I < 0.6 I _p	L _f	mH	51	13	60	10	30	5
Electrical Time Constant*	coils @ 25°C	τ _e	ms	8		8		8	
Maximum Continuous Power Loss	all coils	P _c	W	430		530		1060	
Thermal Resistance	coils to mount. sfc.	R _{th}	°C/W	0.15		0.12		0.06	
Thermal Time Constant*	to max. coil temp.	τ _{th}	s	90		90		90	
Temperature Cut-off / Sensor				PTC 1kΩ / KTY83-122					
Coil Unit Weight	ex. cables	W	kg	4.9		5.9		11.6	
Coil Unit Length	ex. cables	L	mm	244		290		562	
Motor Attraction Force	rms @ 0 A	F _a	N	3400		4150		8300	
Magnet Pitch NN		τ	mm	24		24		24	
Cable Mass		m	kg/m	0.3		0.3		0.3	
Cable Type (Power)	length 1 m	d	mm (AWG)	11.9 (14)					
Cable Type (Sensor)	length 1 m	d	mm (AWG)	4.3 (26)					

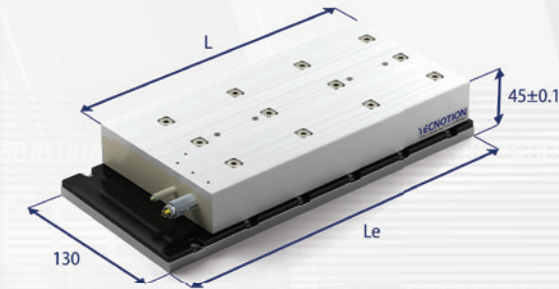

TB12 on 288mm magnet plate shown

Approvals



Magnet plate dimensions

Le (mm)	192	288
M5 bolts	8	12
Mass (kg/m)	10.5	

Magnet plates can be butted together.

All specifications ±10%

* These values are only applicable when the mounting surface is at 20°C and the motor is driven at maximum continuous current. If these values differ in your application, please check our simulation tool.

** Actual values depend on bus voltage. Please check the F/V diagram in our simulation tool.

*** Production date October 2013

Mounting instructions and flatness or parallelism requirements can be found in the Iron Core installation manual. CAD files and 3D models can be downloaded from our website.

MAGNET PLATES

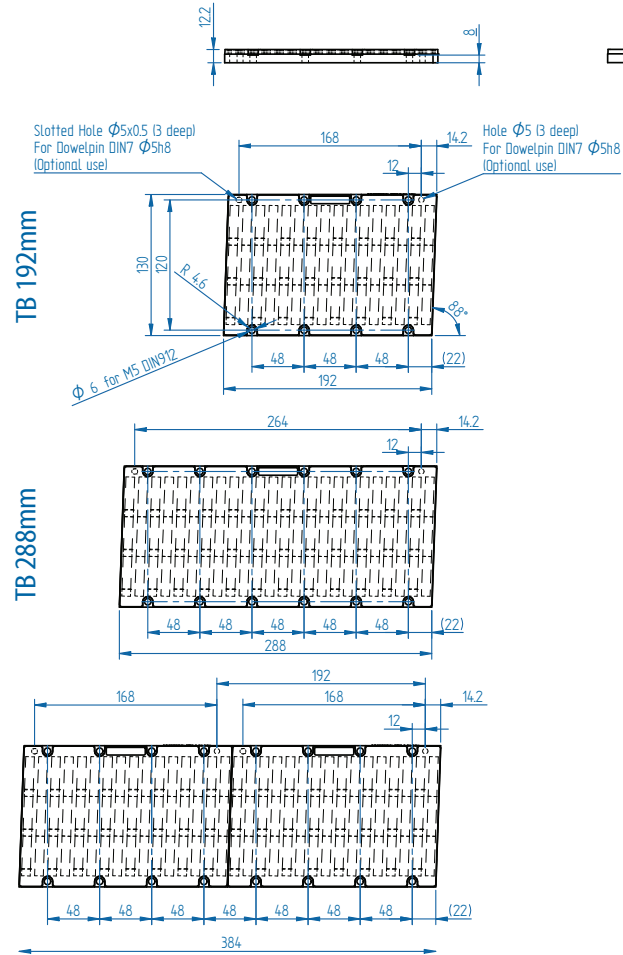
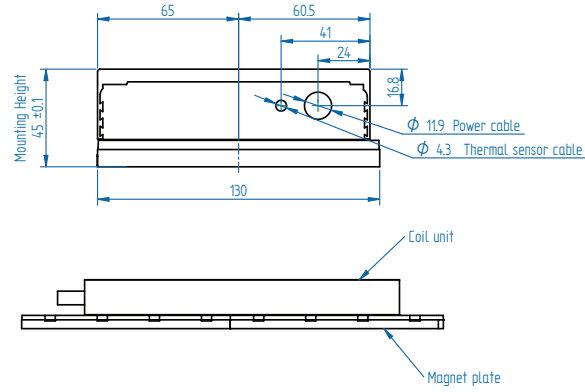

COIL UNITS

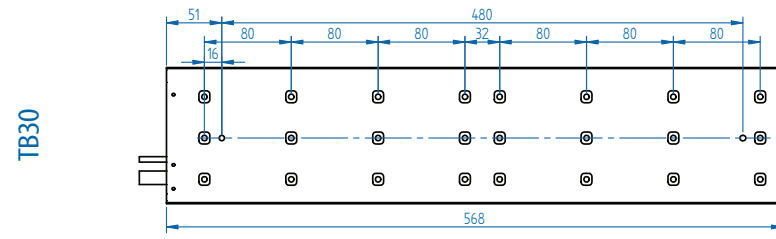
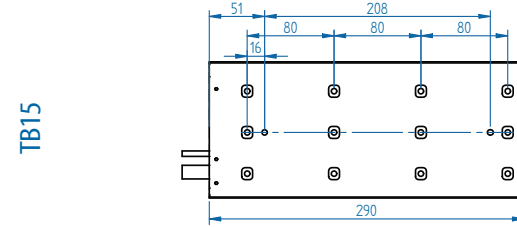
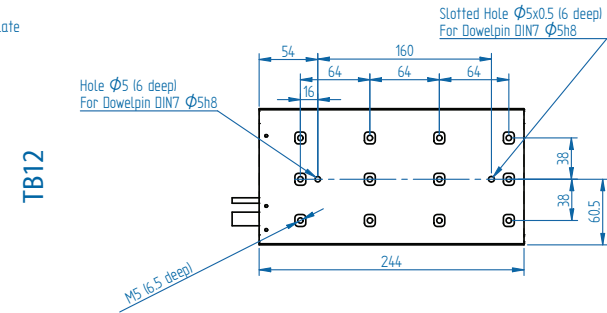
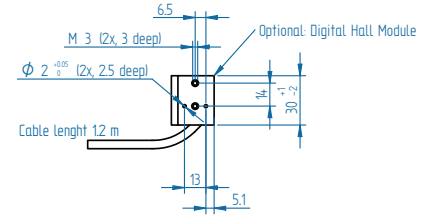

2x TB 192 mm

TB 192mm

TB 288mm

TB30

TB12

TB15