



## POSITION AND MOTION SENSORS



Sold & Serviced By:



Canadian and International Sales

**ELECTROMATE**

877-737-8698

[sales@electromate.com](mailto:sales@electromate.com)

[www.electromate.com](http://www.electromate.com)

U.S. Sales

**SERVO2GO.com**

877-378-0240

[sales@servo2go.com](mailto:sales@servo2go.com)

[www.servo2go.com](http://www.servo2go.com)

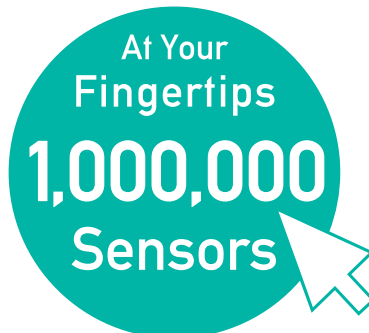

The One Stop Encoder Shop

# POSITAL FRABA

## Over 50 Years Experience with Position Sensors

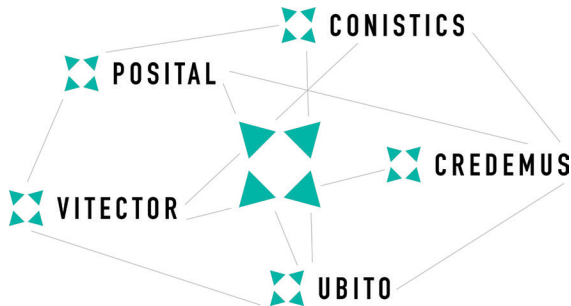

POSITAL is a manufacturer of sensors for motion control and safety assurance systems. The company's products, which include rotary encoders, inclinometers and linear position sensors, are used in a wide range of settings, from manufacturing to mining, agriculture to energy. POSITAL is a member of the international FRABA Group. FRABA Group is a market-leading enterprise that makes use of advanced product design and production to ensure that its customers enjoy the benefits of technology leadership, choice, quality and competitive prices.

### History

FRABA Group dates back to 1918, when its predecessor, Franz Baumgartner elektrische Apparate GmbH, was established in Cologne/Germany to manufacture relays. In 1973, FRABA introduced one of the first non-contact, absolute multiturn encoders. Since then, the company has played a trend-setting role in the development of rotary encoders and other sensor products.

### Service and Production

POSITAL has a global reach with subsidiaries in Europe, North America and Asia – and sales and distribution partners around the world. Products are manufactured in advanced production facilities. The computer-guided, semi-automated production system tracks each device from order, through assembly and testing, to final delivery.

### Other Brands of the Fraba Group include:

- > **UBITO**  
Offers Wiegand technology-based assemblies to be used in a variety of innovative applications.
- > **VITECTOR**  
Manufactures and supplies safety systems for the door and gate market.
- > **CREDEMUS**  
A digital platform for manufacturers with a highly complex portfolio and low order volume.
- > **CONISTICS**  
Offers manufacturing services to produce small lot sizes in a wide range of configurations.

### Sold & Serviced By:



Canadian and International Sales

**ELECTROMATE**

877-737-8698

[sales@electromate.com](mailto:sales@electromate.com)

[www.electromate.com](http://www.electromate.com)

U.S. Sales

**SERVO2GO.com**

877-378-0240

[sales@servo2go.com](mailto:sales@servo2go.com)

[www.servo2go.com](http://www.servo2go.com)

# CATALOG OVERVIEW

## > IXARC Absolute Encoders

Wide Selection of Absolute Rotary Encoders .....	4
Main Variations and Applications .....	5
Product Selection and Overview .....	6

## > IXARC Incremental Encoders

Programmable Incremental Encoders .....	8
Main Variations and Applications .....	9
Product Selection and Overview .....	10

## > IXARC Kit Encoders

Absolute Multiturn Kit Encoders / Incremental Kit Encoders .....	12
Absolute Multiturn Hollow Shaft Kit Encoders .....	13
Product Selection .....	14
Main Variations and Applications .....	15

## > LINARIX Draw Wire Sensors

Versatile Linear Sensors .....	16
Main Variations and Applications .....	17
Product Selection and Overview .....	18

## > TILTIX Inclinometers

Precise And Robust Tilt Sensors .....	20
Mounting options and Applications .....	21
Product Selection and Overview .....	22

## > Wiegand Sensors

Self-powered Magnetic Sensing and Pulse Energy Harvesting .....	24
The Wiegand Experts and Applications .....	25
The Wiegand Effect .....	26

## > Why Choose POSITAL?

.....	27
-------	----

## > Accessories

The Right Accessory for Every Application .....	28
Overview .....	29

## > POSITAL Worldwide

.....	31
-------	----

### Disclaimer

© FRABA B.V. all rights reserved. We do not assume responsibility for technical inaccuracies or omissions. Specifications are subject to change without notice.

Version 20210823

# IXARC ABSOLUTE ENCODERS

## Wide Selection of Absolute Rotary Encoders



Absolute rotary encoders are capable of providing unique position values from the moment they are switched on. Even movements that occur while the system is without power are translated into accurate position values once the encoder is powered up again. Another advantage is their high number of variations. Absolute encoders can either be singleturn or multiturn with different resolutions and communication interfaces. The user also can choose from thousands of mechanical and connection configurations to meet their needs.

- > **Maintain Position Information**  
Even when Power is Lost
- > **Compact Size**  
Down to Ø 36 mm
- > **15+ Communication Interfaces**  
Industry Classics and Latest Trends
- > **Programmable Parameters**  
To Better Fit your Application
- > **Wiegand Technology**  
No Battery, No Maintenance
- > **High Shock and Vibration Resistance**  
Insensitive to Dust and Humidity
- > **Heavy Duty Enclosures**  
Stainless Steel and ATEX Versions Available
- > **Safety Ready – Through Clever Design**  
Tandem Redundant Encoders

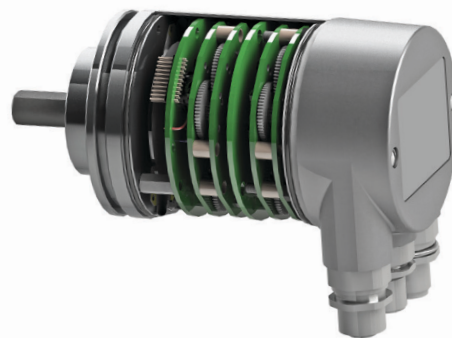
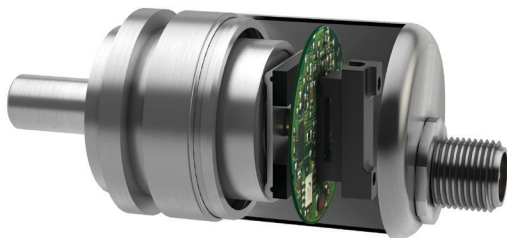

Sold & Serviced By:



Canadian and International Sales

**ELECTROMATE**

877-737-8698

[sales@electromate.com](mailto:sales@electromate.com)

[www.electromate.com](http://www.electromate.com)

U.S. Sales

**SERVO2GO.com**

877-378-0240

[sales@servo2go.com](mailto:sales@servo2go.com)

[www.servo2go.com](http://www.servo2go.com)

# IXARC ABSOLUTE ENCODERS

## Main Variations

Motion control applications range from factory automation to control systems for mobile machines. They all have their specificities but still require precise, real-time information about the physical location of mechanical equipment. POSITAL's line of absolute encoders is designed to address seemingly all problematic you can face.

### Singleturn Vs Multiturn

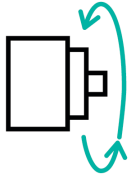

- > Singleturn:  
Shorter housing
- > Multiturn:  
Up to 65,536 revolutions

### Variety of Interfaces



- > Ethernet Based
- > Fieldbus Classics
- > Analog, Parallel, SSI
- > IO-Link

### Magnetic Vs Optical

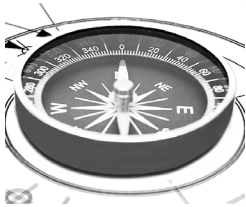

- > Optical: High Resolution, Ideal for magnetic fields
- > Magnetic: Robust and Durable, No Battery, No Gear

### Flange & Shaft Options

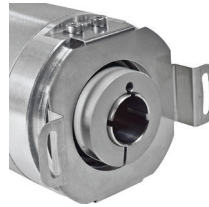

- > Solid or Hollow Shaft
- > Multiple Flanges Design to Fit All Applications
- > Couplings, Tethers, Adapters Available

## Applications

IXARC absolute encoders always ensure reliable positioning; they never require a reference run by then increasing the safety and efficiency of the machines. Their compact size makes them ideal for applications ranging from healthcare equipment to factory automation.

### Food & Beverage



- > Stainless Steel Version
- > Chemical Resistance
- > Accurate Process Monitoring

### Factory Automation



- > Compact Size
- > Ideal for Retrofitting
- > Reliable at Maximum Speed

### Industrial Valves, Water Wastewater

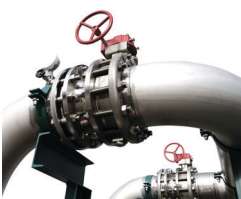

- > Variety of Interfaces
- > IP69K Rating
- > 16 bits Resolution

### Oil & Gas



- > ATEX Encoders
- > Zone 1&21
- > Zone 2&22

# IXARC ABSOLUTE ENCODERS

## How to Select the Right Absolute Encoder for your Application

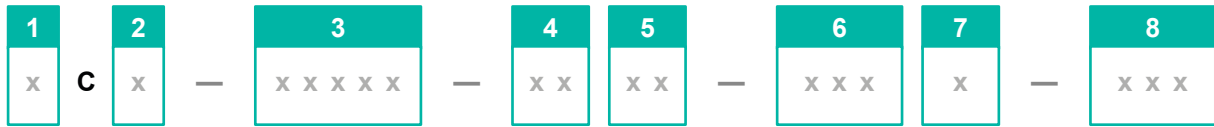

### 1. Technology – Accuracy

Magnetic or Optical. Magnetic technology uses a permanent magnet while the latter uses an optical code-disc.



### 2. Certificate

CE and/or UL, ATEX Zone 1&21 and 2&22 as well as redundant technology available.



### 3. Communication Interface

Represents the language used by the encoder to transmit the data to the master or the network.



### 4. Revolution

Maximum number of turns. This parameter is indicated in bits, e.g., 14 bits (= 16,384 revolutions).



### 5. Resolution

Number of steps (divisions) per turn. This parameter is indicated in bits, e.g., 12 bits (= 4,096 divisions).



### 6. Mechanical Design

Describes the mechanical characteristics of the encoder: flange design and size, shaft diameter, options.



### 7. Protection Class – Material

Informs about the protection level of the encoder against its environment (water & dust ingress).

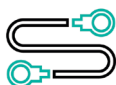

### 8. Connection Type

Describes the medium via which the encoder transmits the output signal over.

Sold & Serviced By:



Canadian and International Sales

**ELECTROMATE**

877-737-8698

[sales@electromate.com](mailto:sales@electromate.com)

[www.electromate.com](http://www.electromate.com)

U.S. Sales

**SERVO2GO.com**

877-378-0240

[sales@servo2go.com](mailto:sales@servo2go.com)

[www.servo2go.com](http://www.servo2go.com)

# IXARC ABSOLUTE ENCODERS

## 1 Accuracy (Technology)

≤ 0.02° (Optical)                      ≤ 0.09° (Magnetic)                      ≤ 0.02° (Optical) + ≤ 0.09° (Magnetic)

## 2 Certificate

CE / UL                      ATEX (1&21 + 2&22)                      Redundant                      SIL

## 3 Communication Interface

Analog	SSI	Profibus	CANopen	J1939
Ethernet/IP	EtherCAT	Profinet	Powerlink	Modbus TCP
IO-Link	DeviceNet	Profisafe	CANsafe	Modbus RTU
Parallel	BiSS-C			

## 4 Revolution (Number of Turns)

Singleturn                      04 – 08 bits (Analog)                      Up to 31 bits

## 5 Resolution (Steps per Turn)

Programmable                      Up to 16 bits

## 6 Flange

<b>Flange Design</b>	Hollow Shaft: Blind Hollow; Through Hollow	Solid Shaft: Clamping; Square; Synchro
<b>Flange Size</b>	Ø 36; 58; 78	Ø 36; 38; 40; 42; 50; 58; 78; 115 Ø 52.3; 63.5; 80
<b>Shaft diameter</b>	Ø 6; 8; 10; 11; 12; 14; 15; 16 Ø ¼"; 3/8"; ½"; 5/8"	Ø 6; 8; 10; 11; 12 Ø ¼"; 3/8"
<b>Options</b>	Clamping ring, Set Screw	Shaft Flat, Double Flat, Keyway

## 7 Material / Protection class

Aluminum – Steel	Stainless Steel V2A	Stainless Steel V4A
IP54; IP64 / IP65	IP64 / IP65; IP67	IP67; IP68 / IP69K

## 8 Connection Type

<b>Type</b>	Cable	Connection Cap	Connector
<b>Orientation</b>	Axial; Radial; Angular	Radial	Axial; Radial
<b>Range</b>	1 m; 2 m; 5 m; 10 m	M12; Blind Plugs; Cable Glands	M12; M23; M27; MS16; D-Sub
<b>Option</b>	LED	1 – 3 exits	1 – 3 exits; LED

Sold & Serviced By:



Canadian and International Sales

**ELECTROMATE**

877-737-8698

sales@electromate.com

www.electromate.com

U.S. Sales

**SERVO2GO.com**

877-378-0240

sales@servo2go.com

www.servo2go.com

# IXARC INCREMENTAL ENCODERS

## Programmable Incremental Encoders



Incremental rotary encoders generate an output signal each time the shaft rotates a certain angle. The number of signals (pulses) per turn, also called PPR, defines the resolution of the device. The internal components of an incremental encoder are much simpler than the ones of an absolute encoder. This fits the need of many applications for simple, cost effective solutions while still providing accurate positioning. They are available with common configurations such as A, B, Z, and inverted signals available as HTL (Push-Pull) or TTL (RS422). POSITAL magnetic encoders can all be configured via the UBIFAST configuration tool: helping reduce inventory levels.

- > **Programmable Pulse per Revolution**  
Any PPR from 1 to 16,384
- > **High Performance due to Signal Processing**  
Phase Angle:  $90^\circ \pm 14^\circ$
- > **Industry Leading Sensing Technology**  
Accuracy  $\pm 0.0878^\circ$
- > **Programmable Output**  
Push-Pull (HTL) or RS422 (TTL)
- > **Magnetic Technology**  
Simple Design – No Code Discs
- > **High Shock and Vibration Resistance**  
Insensitive to Dust and Humidity
- > **Heavy Duty Enclosures**  
IP69K and Stainless Steel Versions Available
- > **Large Variety of Flange Configurations**  
With a Range of Shaft Diameters





# IXARC INCREMENTAL ENCODERS

## Main Variations

Our mission is to help our customers address all problems they can possibly face in the field. That is why we offer a wide range of mechanical and housing variations; ensuring a quality sensor that fits your needs.

### Compact and Cost Effective



- > Ø36 - 58 mm Housing
- > Solid or Hollow Shaft
- > Connector or Cable
- > Highly Versatile

### Through Hollow Shaft



- > Ø58 – 77 – 100 mm Housing
- > Shaft from 9.52 mm up to 44.45 mm (3/8" up to 1 3/4")

### The Industry Classics



- > Cube Encoder
- > Square Flanges
- > Ø40 & 50 mm Clamping Flanges

### Heavy Duty



- > IP69K
- > Stainless Steel Housing
- > Up to 300g Shock Resistance

## Applications

IXARC incremental encoders are ideal for various industries due to their small size and excellent performance. Their economic magnetic design makes them ideal for motor feedback, material handling applications and OEMs.

### Medical Equipment



- > Used in MRI and CT Scanner Tables
- > Height Positioning
- > Compact Sizes

### Material Handling



- > Efficient, Accurate and Safe Positioning
- > AGV, Conveyors, Baggage Handling, etc.

### Mobile Machines



- > Sensors for Tough Jobs
- > Hazardous Environments
- > High Pressure & Temperature Resistant

### Renewable Energy



- > Photovoltaic, Turbines, Parabolic Systems
- > Speed Control System
- > Increased Efficiency in Extreme Environments

Sold & Serviced By:



Canadian and International Sales

**ELECTROMATE**

877-737-8698

[sales@electromate.com](mailto:sales@electromate.com)

[www.electromate.com](http://www.electromate.com)

U.S. Sales

**SERVO2GO.com**

877-378-0240

[sales@servo2go.com](mailto:sales@servo2go.com)

[www.servo2go.com](http://www.servo2go.com)

# IXARC INCREMENTAL ENCODERS

## How to Select the Right Incremental Encoder for your Application



### 1. Technology – Accuracy

Magnetic or Optical. Magnetic technology uses a permanent magnet while the latter uses an optical code-disc.



### 2. Certificate

All our products are certified CE and/or UL.



### 3. Communication Interface

Indicates whether the encoder is programmable or not and what time of output driver is defined.



### 4. Pin out

Indicates whether the output signal presents an index channel and/or differential signals or not.



### 5. Pulse count

Number of steps (divisions) per turn. This parameter can be programmed from 1 to 16,384 PPR.



### 6. Mechanical Design

Describes the mechanical characteristics of the encoder: flange design and size, shaft diameter, options.



### 7. Protection Class – Material

Informs about the protection level of the encoder against its environment (water & dust ingress).

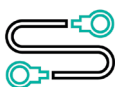

### 8. Connection Type

Describes the medium via which the encoder transmits the output signal over.

Sold & Serviced By:

*Canadian and International Sales*  
 **ELECTROMATE**  
 877-737-8698  
[sales@electromate.com](mailto:sales@electromate.com)  
[www.electromate.com](http://www.electromate.com)

*U.S. Sales*  
 **SERVO2GO.com**  
 877-378-0240  
[sales@servo2go.com](mailto:sales@servo2go.com)  
[www.servo2go.com](http://www.servo2go.com)

## IXARC INCREMENTAL ENCODERS

<b>1 Accuracy (Technology)</b>	$\leq 0.02^\circ$ (Optical)	$\leq 0.09^\circ$ (Magnetic)		
<b>2 Certificate</b>	CE / UL	ATEX (1&21 + 2&22)		
<b>3 Incremental Interface</b>	<b>Programmable HTL/TTL</b>	Default Push-Pull (HTL)	Default RS422 (TTL)	
	<b>Non-Programmable</b>	Push-Pull (HTL)	RS422 (TTL)	
<b>4 Pin Assignment</b>	A, /A, B, /B	A, B, Z	A, B, Z, /A, /B, /Z	
<b>5 Pulse Count (PPR)</b>	<b>Programmable</b>	1 – 16,384		
	<b>Non-Programmable</b>	360; 512; 1000; 1024; 2000; 2048; 2500		
<b>6 Flange</b>	<b>Flange Design</b>	Hollow Shaft: Blind Hollow; Through Hollow	Solid Shaft: Clamping; Cube; Square; Synchro	
	<b>Flange Size</b>	$\varnothing$ 36; 42; 58; 77; 100	$\varnothing$ 36; 40; 42; 50; 58; 115 $\varnothing$ 52.3; 57.15; 63.5; 68; 80	
	<b>Shaft Diameter</b>	$\varnothing$ 6; 8; 10; 11; 12; 14; 15; 16; 20; 25; 30; 38; 40; 42 $\varnothing$ 1/4"; 3/8" 1/2"; 5/8"; 3/4"; 7/8"; 1"; 1 1/4"; 1 1/2"; 1 5/8"; 1 3/4"	$\varnothing$ 6; 8; 10; 11; 12; 15 $\varnothing$ 1/4"; 3/8"	
	<b>Options</b>	Clamping ring, Set Screw	Shaft Flat, Double Flat, Keyway 5 mm	
<b>7 Material / Protection Class</b>	Aluminum – Steel IP54; IP64 / IP65	Stainless Steel V4A IP67; IP68 / IP69K		
<b>8 Connection Type</b>	<b>Type</b>	Cable	Connector	Terminal Box
	<b>Orientation</b>	Axial; Radial; Angular	Axial; Radial	
	<b>Range</b>	1 m; 2 m; 5 m; 10 m	M12; M23; MS12; MS14; MS16; MS18	

Sold & Serviced By:



Canadian and International Sales

**ELECTROMATE**

877-737-8698

[sales@electromate.com](mailto:sales@electromate.com)

[www.electromate.com](http://www.electromate.com)

U.S. Sales

**SERVO2GO.com**

877-378-0240

[sales@servo2go.com](mailto:sales@servo2go.com)

[www.servo2go.com](http://www.servo2go.com)

# IXARC KIT ENCODERS

## Absolute Multiturn Kit Encoders / Incremental Kit Encoders



POSITAL kit encoders offer smart, maintenance-free and cost-efficient solutions for the most challenging tasks in real time motion feedback. Fusion of sensing technologies results in unique designs with uninterrupted, battery-free multiturn function, powered by a Wiegand pulse with every rotation. The gear-free, compact and economically optimized concept is ideal for integration into servo, stepper or BLDC motors. No special equipment is required for the installation. There are various mechanical configurations starting from 22 mm outer diameter. Enhanced signal processing software enables high-resolution position measurement with excellent latency compensation.

- > **Compact Design**  
22mm or 36mm Diameter
- > **Absolute Measurement**  
17bit Singleturn Resolution
- > **Open Source Interfaces**  
Biss-C, Biss-Line, SSI, SPI
- > **Incremental Kit Encoders**  
Compatible To Common Standards
- > **Wiegand Technology**  
Multiturn Without Battery or Gear
- > **Easy To Install**  
No Special Equipment or Skills Required
- > **Mechanical Design**  
Compatible With Common Bolt Patterns
- > **Insensitive To Dust and Moisture**  
-40°C to +105°C Temperature Range

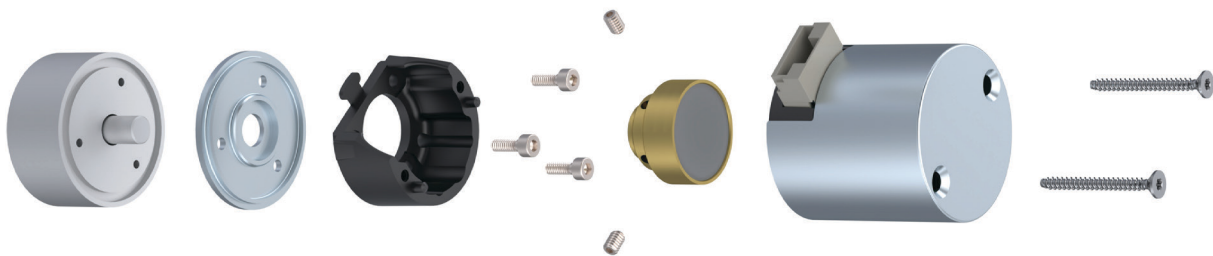

# IXARC KIT ENCODERS

## Absolute Multiturn Hollow Shaft Kit Encoders

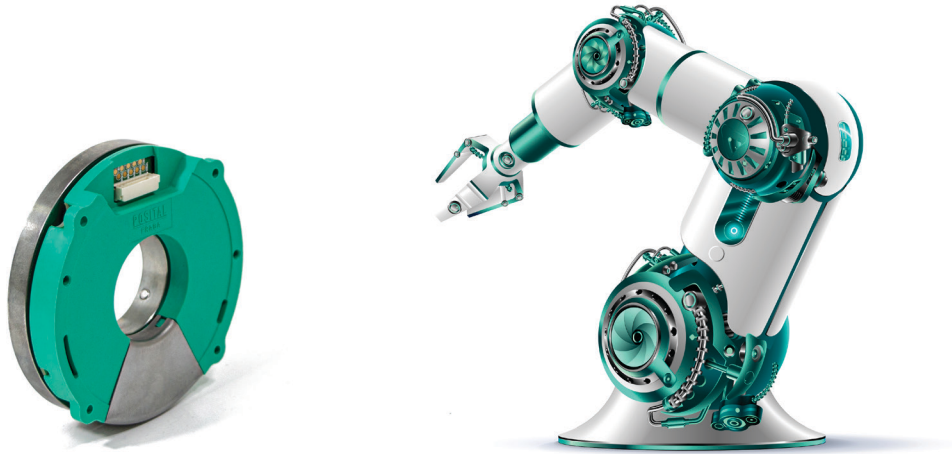

POSITAL's hollow shaft kit encoders offer a wide multiturn range without the need for a battery or gear system. They have a slim design of just 18 mm thickness. They offer a resolution of up to 19 bit and are designed for integration into hollow shaft motors and robots. In robotic systems, the hollow shaft design enables cables and compressed air to be routed inside of the robotic arm. The singleturn system is based on capacitive technology and is combined with POSITAL's proven Wiegand multiturn technology. Special tools or costly equipment are not required for the assembly of these kit encoders to motors.

- > **Hollow Bearingless Center Design**  
With 30mm and 50mm Inner Diameter
- > **Multiturn Without Battery or Gear**  
Energy-Harvesting Wiegand Sensor
- > **Singleturn Resolution**  
Up to 19 bit
- > **Open Source Interfaces**  
BiSS-C, SSI
- > **Slim Design**  
Thickness 18mm
- > **Easy to Install**  
No Calibration or Special Equipment Required
- > **Insensitive To Dust & Moisture**  
Can be Installed in Any Factory
- > **Optimal Mechanical Layout**  
For Robotic Joints and Drives

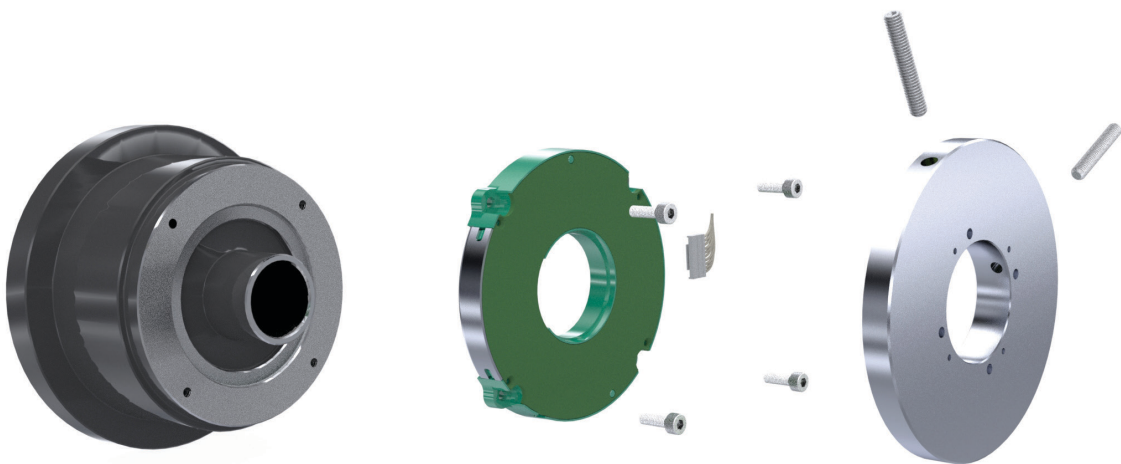

# IXARC KIT ENCODERS

## How to Select the Right Kit Encoder for your Application

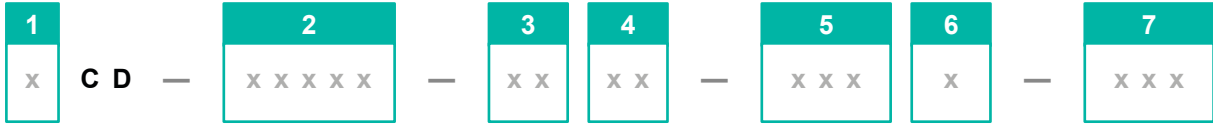

### 1. Technology – Accuracy

Magnetic encoders provide 17 Bit resolution, capacitive hollow shaft encoders up to 19 Bit.

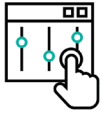

### 2. Communication Interface

BISS-C, SSI, BISS-Line (4 and 2 wire), SPI and incremental interfaces are available.



### 3. Revolution

A Multiturn range of up to 40 Bits is possible, 16 Bits is common.



### 4. Resolution

17 Bit (Magnetic), 19 Bit (Capacitive) or 1024 PPR (Incremental).



### 5. Mechanical Interface

22 mm and 36 mm outer diameter for on axis magnetic versions, 30 or 50 mm inner diameter (hollow shaft).



### 6. Magnetic Shield / Housing / Magnet Hub Shaft Adapter

Magnet hub shaft adapters are available with set screw and press fit installation.

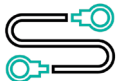

### 7. Connection Type

All kit encoders have JST connectors; housings with M12 connectors or cable clip are available.

Sold & Serviced By:



Canadian and International Sales

**ELECTROMATE**

877-737-8698

[sales@electromate.com](mailto:sales@electromate.com)

[www.electromate.com](http://www.electromate.com)

U.S. Sales

**SERVO2GO.com**

877-378-0240

[sales@servo2go.com](mailto:sales@servo2go.com)

[www.servo2go.com](http://www.servo2go.com)

# IXARC KIT ENCODERS

## Main Variations

POSITAL KIT encoders offer you battery-less, cost-efficient solutions for fast motion control of servo or stepper motors and robotic systems. There are various mechanical configurations starting from 22 mm outer diameter that are compatible with common mechanical interfaces (bolt patterns).

### Multiturn Kit-Encoder: On Axis



- > From 22 mm Diameter
- > No Battery – No Gear
- > Robust & Easy To Install
- > BiSS-C, BiSS Line, SSI
- > -40 to 105 °C

### Multiturn Kit-Encoder: Hollow Shaft

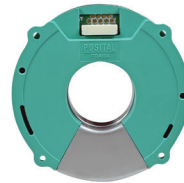

- > Up To 50 mm Inner Diameter
- > No Battery – No Gear
- > BISS, SSI, Incremental
- > Robust & Easy To Install

### Multiturn Module



- > No Battery - No Gear
- > Large Multiturn Range up to 40 Bit
- > SPI Interface

### Incremental Kit Encoder



- > Compatible with Common Interfaces
- > Up to 1024 PPR Resolution
- > Easy To Install

## Applications

POSITAL Kit Encoders are designed for integration into servo motors, stepper motors and robotic systems as used in many different applications. Examples:

### AGV – Autonomous Guided Vehicle



- > Multiturn Without Battery
- > No Maintenance
- > Robust - High Availability

### Robotic Systems



- > Very Slim Multiturn For Small Joints
- > High Precision For Exact Positioning
- > No Calibration

### Linear Actuator

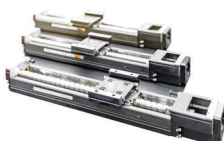

- > Multiturn Range
- > No Homing After Loss of Power
- > Compatible With Common Interfaces

### Stepper / Servo Motor



- > Multiturn Without Battery
- > Cost Efficient Closed Loop Control

# LINARIX DRAW WIRE SENSORS

## Versatile Linear Sensors



Draw wire sensors, also called cable pull sensors, are designed to perform linear position measurement using an encoder and thus providing high accuracy sensing. Connected to a draw wire, the encoder delivers a signal proportional to the cable that is pulled out. While pinion and racks require perfect alignment and soldering, a draw wire sensor offers an easy-to-install system with a large variety of interface options. Thanks to the powerful UBIFAST configuration tool, customers can define the needed resolution after selecting the desired measuring range. It therefore answers any type of application involving linear displacement.

- > **Wide Range of Measuring Lengths**  
1 to 15 m (3' to 49')
- > **Absolute Position Measurement**  
15+ Communication Interfaces
- > **High Linearity**  
Even with Long Cycle Times
- > **Define Your Own Measuring Length**  
Scalable Analog Output
- > **Teach-in Functionalities**  
No Software or Programming Required
- > **Outdoor Application Ready**  
With Protection Class up to IP69K
- > **Safety Ready – Through Clever Design**  
Tandem Redundant Encoders
- > **Tilt and Linear Measurement in One Sensor**  
When Combined with POSITAL Inclinometer

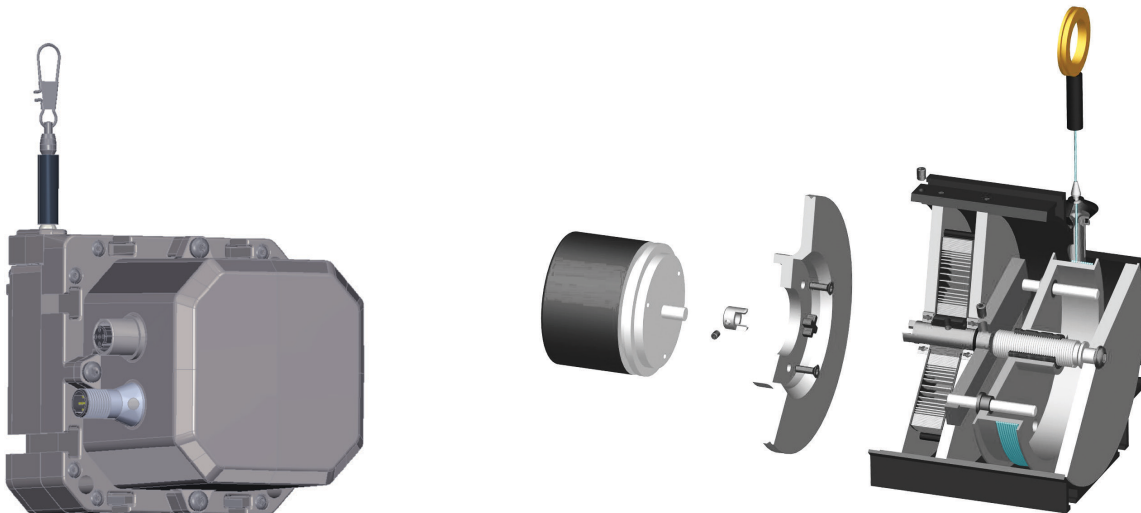



# LINARIX DRAW WIRE SENSORS

## Main Variations

LINARIX linear sensors are available in many configurations to meet any application's requirements, from near clean room conditions to harbors handling arms and construction cranes. Options include a wide variety of outputs (including analog, fieldbus and Ethernet variants), heavy duty housings and compact designs.

### Extruded Metal Housings



- > Robust
- > Flexible Mounting
- > Acceleration up to 7g
- > Suitable for Demanding Environments

### Machined Metal Housings



- > Economical
- > Compact
- > Suitable for Industrial Environments

### Plastic Housings



- > Highly Economical
- > Small Footprint
- > High Accuracy
- > OEM's Favorite

### Variety of Interfaces



- > Ethernet Based
- > Fieldbus Classics
- > Analog, Parallel, SSI
- > IO-Link

## Applications

LINARIX sensors provide highly reliable and precise measurements thanks to the accuracy of the absolute encoders in combination with high quality draw wire mechanics. Their rugged construction ensures reliable performance and long lifetimes even under extreme conditions. For example, articulation boom lifts and telescopic boom lifts present similar constraints: simultaneously managing angle and extension. POSITAL draw wire sensors with an integrated inclinometer offer single sensor which allows precise positioning while articulating your boom crane.

### Medical Systems

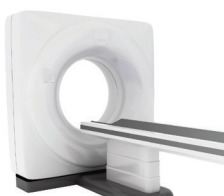

- > Length and Height Measurement
- > High Resolution
- > Durable and Low-cost

### Material Handling



- > Linear Accuracy up to 0.35 mm
- > Up to IP69K
- > -40°C to +85 °C

### Cranes



- > Rugged Draw Wire
- > Measuring Range from 3 m to 15 m
- > Resolution up to 4 µm

### Slide and Vertical Floodgates



- > User Defined Programmability
- > Large Variety of Interfaces

# LINARIX DRAW WIRE SENSORS

## How to Select the Right Draw Wire Sensor for your Application

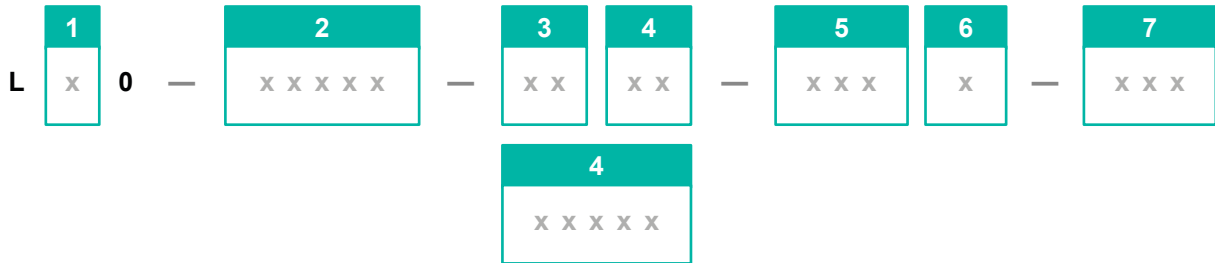

### 1. Technology – Accuracy

Magnetic or Optical. Magnetic technology uses a permanent magnet while the latter uses an optical code-disc.

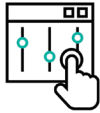

### 2. Communication Interface

Represents the language used by the encoder to transmit the data to the master or the network.

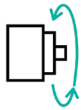

### 3. Revolution

Maximum number of turns. This parameter is indicated in bits, e.g., 14 bits (= 16,384 revolutions).



### 4. Resolution

Number of steps (divisions) per turn. This parameter is indicated in bits, e.g., 12 bits (= 4,096 divisions).

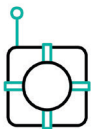

### 5. Draw Wire (Measurement Range – Enclosure – Connection Orientation)

Characteristics of the draw wire adapter: measuring length, enclosure material, connection orientation.



### 6. Protection Class

Informs about the protection level of the encoder against its environment (water & dust ingress).

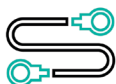

### 7. Connection Type

Describes the medium via which the encoder transmits the output signal over.

Sold & Serviced By:



Canadian and International Sales

**ELECTROMATE**

877-737-8698

[sales@electromate.com](mailto:sales@electromate.com)

[www.electromate.com](http://www.electromate.com)

U.S. Sales

**SERVO2GO.com**

877-378-0240

[sales@servo2go.com](mailto:sales@servo2go.com)

[www.servo2go.com](http://www.servo2go.com)

# LINARIX DRAW WIRE SENSORS

## 1 Accuracy (Technology)

≤ 0.02° (Optical)                      ≤ 0.09° (Magnetic)                      ≤ 0.02° (Optical) + ≤ 0.09° (Magnetic)

## 2 Communication Interface

Analog	SSI	Profibus	CANopen	J1939
Ethernet/IP	EtherCAT	Profinet	Powerlink	Modbus TCP
Parallel	DeviceNet	Incremental Programmable		

## 3 Resolution (Steps per Turn)

0.1mm/pulse (Incremental)      12 bits      13 bits      16 bits      Draw Wire Only      Programmable

## 4 Draw Wire Adapter

<b>Measurement Range</b>	1 – 2.9 m	3 – 6.9 m	7 – 15 m
<b>Enclosure</b>	Extruded Metal	Machined Metal	Plastic
<b>Connection Orientation</b>	Axial	Radial 2; 3; 4; 6; 8; 9; 10	

## 5 Protection Class

IP54                      IP64 / IP65

## 6 Connection Type

<b>Type</b>	Cable	Connection Cap	Connector
<b>Orientation</b>	Axial; Radial; Angular	Radial	Axial; Radial
<b>Range</b>	1 m; 2 m; 5 m; 10 m	M12; Blind Plugs; Cable Glands	M12; M23; M27; MS16; D-Sub
<b>Option</b>	LED	1 – 3 exits	1 – 3 exits; LED

### Easily Define the Output of your Linear Sensor

With POSITAL's LINARIX draw wires, simply press the set one button, pull the cable up to the distance you want to measure, press the set two button, and let the cable retract. This allows for anyone to simply define their own draw wire output (i.e. 0-10V at 0 to 5m or 0 to 4.252m) to match their application.



- > Easily Scale Your Measurement Range for Analog Versions
- > Programmable Versions Done Simply via UBIFAST
- > Large Variety of Interfaces: Analog, SSI, CANopen

Sold & Serviced By:



Canadian and International Sales

**ELECTROMATE**

877-737-8698

sales@electromate.com

www.electromate.com

U.S. Sales

**SERVO2GO.com**

877-378-0240

sales@servo2go.com

www.servo2go.com

# TILTIX INCLINOMETERS

## Precise And Robust Tilt Sensors

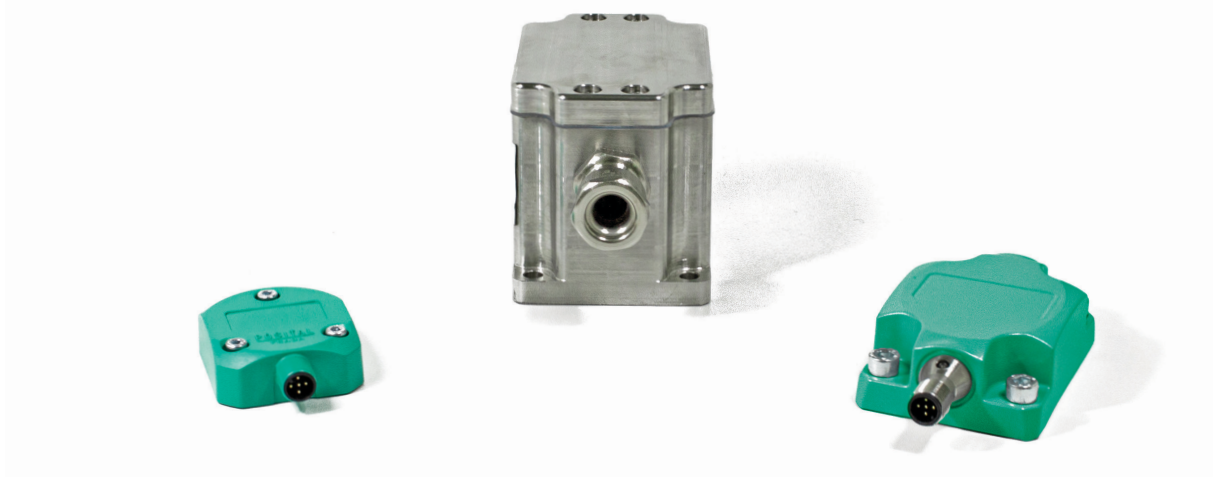

Inclinometers, also called tilt sensors, are designed to measure the angle of an object with respect to the force of gravity. These tilt or level meters determine the angle orientation in space with gravity as reference and output these values via the appropriate electrical interface. Inclinometers are easy to integrate to an application because there is no need for mechanical linkages other than the installation itself – a real advantage for design engineers. POSITAL's inclinometer portfolio offers solutions for different industries to tackle all application-specific challenges.

- > **Single and Dual Axis Measurement**  
Up to 360° Single and up to +/-180° Dual
- > **Horizontal or Vertical Mounting Orientation**  
For the Perfect Fit
- > **Analog and Digital Interfaces Available**  
CANopen, RS232, SSI, J1939, DeviceNet
- > **Ex-Proof Versions Available**  
For Mining or Oil and Gas Applications
- > **High Shock and Vibration Resistance**  
Up to 200g
- > **Different Inclinometer Technologies**  
Tackle the Challenges of Each Application
- > **Durable & Robust Housing Concept**  
Up to IP69K
- > **Dynamic Inclinometers**  
Ideal for Applications with Dynamic Movements



# TILTIX INCLINOMETERS

## Dynamic Inclinometer

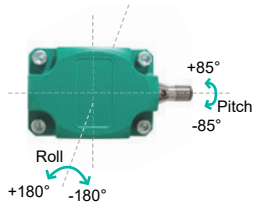

- > Accurate Measurement During Dynamic Movements
- > Output of Accelerations and Rate of Rotation

## Static Inclinometers



- > High Accuracy in Slow Moving Applications

## Mounting Options

### Horizontal mounting

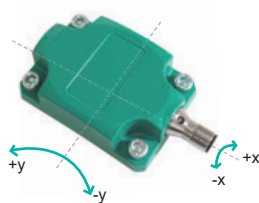

- > Dual Axis Output
- > Ideal for Levelling Tasks
- > Often Used on Chassis of Mobile Machines or Other Platforms

### Vertical mounting

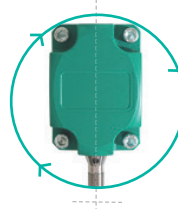

- > Single or Dual Axis Output
- > Monitor Angles of Excavator Booms, Firetruck Ladders or Solar Panels

## Applications

Inclinometers offer an easy and efficient way of monitoring spatial orientations without the need for mechanical linkages – a real advantage for design engineers.

**Dynamic inclinometers** output a clean measurement signal that can be used reliably on mobile equipment such as cranes, construction, mining, agricultural machinery and other applications where sudden movements, shocks and vibrations are likely to be encountered.

**Static inclinometers** can significantly improve operating safety in mobile machines, platform leveling or medical applications by continuously monitoring the tilt or inclination angles. Inclinometers are much easier to install and thus less expensive compared to rotary encoders, making them ideal for applications such as solar trackers, scissor lift tables, and aerial work platforms.

### Excavator



- > Reliable Angle Measurement of Booms and Chassis
- > Able to Withstand High Shocks and Vibrations

### Concrete Pump Truck



- > Stable Monitoring of Boom Angles
- > IP69K Protection for Outdoor Usage

### Solar Energy



- > Accurate Angle Measurement for Alignment of Solar Panels Even During Large Temperature Fluctuations

### Aerial Work Platform & Scissor Lift



- > Platform Monitoring on Slow Moving Material Handling Equipment and Hoists

# TILTIX INCLINOMETERS

## How to Select the Right Inclinometer for your Application



### 1. Accuracy – Application/Technology

Depending on the application and measurement task a static or dynamic inclinometer with specific accuracy can be selected.



### 2. Certificate

For most applications, a standard product without special certification is sufficient. POSITAL offers special product versions with ATEX certification for mining or oil-and-gas applications.

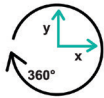

### 3. Measurement Range

Different measurement ranges and mounting orientations can be selected, depending on the mounting position on the application.



### 4. Communication Interface

POSITAL offers a wide range of commonly used interfaces from CANopen, SAE J1939, to Analog with different current or voltage outputs and Modbus RTU and SSI.



### 5. Housing

Choose between cost efficient fiber-reinforced plastic, heavy duty die-cast aluminum, or a stainless steel V4A or aluminum ATEX housing.

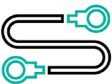

### 6. Connection Type

M12 connectors and PVC or PUR cable exits of different length are available. We offer dual connector variants with integrated T-coupler (Bus-in and Bus-out) that minimize cabling efforts and costs for BUS systems like CANopen or SAE J1939.

Sold & Serviced By:



Canadian and International Sales

**ELECTROMATE**

877-737-8698

[sales@electromate.com](mailto:sales@electromate.com)

[www.electromate.com](http://www.electromate.com)

U.S. Sales

**SERVO2GO.com**

877-378-0240

[sales@servo2go.com](mailto:sales@servo2go.com)

[www.servo2go.com](http://www.servo2go.com)

# TILTIX INCLINOMETERS

<b>1 Accuracy (Technology)</b>	0.10°	0.30°			
<b>2 Certificate</b>	ATEX Zone 1&21 (Oil+Gas)	ATEX Zone 1&21 (Mining)	CE / UL		
<b>3 Measurement Range</b>					
<b>1 Axis</b>	90°; 120°; 180°; 270°; 360°				
<b>2 Axes</b>	± 10°; ± 20°; ± 30°; ± 40°; ± 60°; ± 80°; ± 90°;				
<b>Pitch &amp; Roll</b>	± 85°/± 180° Vertical Mount; ± 85°/± 180° Horizontal Mount				
<b>4 Communication Interface</b>	Analog	CANopen	J1939	SSI	Modbus RTU
<b>5 Housing</b>	Aluminum	Fiber-Reinforced Plastic	Stainless Steel V4A		
<b>6 Connection Type</b>					
<b>Cable</b>	1; 2; 5; 10 m				
<b>Connector</b>	M12; 2 x M12 (m+f); 2 x M12 (m+m)				

## ATEX Explosion Proof Certified InclInometers



- > Compliance with IECEx and ATEX Directives
- > Zone 1/21 Mining or Oil and Gas
- > Group I (Mining) Ex I M2 Ex e mb I Mb
- > Group II (Above Ground Operations)

Sold & Serviced By:



Canadian and International Sales

**ELECTROMATE**

877-737-8698

[sales@electromate.com](mailto:sales@electromate.com)

[www.electromate.com](http://www.electromate.com)

U.S. Sales

**SERVO2GO.com**

877-378-0240

[sales@servo2go.com](mailto:sales@servo2go.com)

[www.servo2go.com](http://www.servo2go.com)

# WIEGAND SENSORS

## Self-Powered Magnetic Sensing and Pulse Energy Harvesting



Wiegand sensors offer bipolar magnetic sensing without the need for any external voltage or current to be applied. The unique material properties of the sensor mean that consistent pulses are produced with every incidence of magnetic field polarity switching. In addition to magnetic sensing, ultra-low power electronics can be powered by harvesting the energy of a single pulse. Alternatively, successive pulses can be stored to offset the energy demand of circuits, or used to 'wake-up' intermittently powered electronic circuits. This makes it the perfect magnetic sensor for low-power and energy-saving applications.

- > **Millions of Pulses, No Reduction in Energy**  
Pulse Energy is Unaffected by Repeated and Continuous Use Over Time
- > **High Signal Noise Ratio**  
High Slew Rate & Pulse Voltage Provide Superior SNR to Other Magnetic Sensor Technologies
- > **Frequency Independent Pulse Energy**  
Consistent Energy Level Even at Extremely Low Frequencies of Magnetic Field Change
- > **High Triggering Frequency**  
Consistent Pulse Width Means Events Can be Differentiated at Frequencies up to 40kHz
- > **Zero Mechanical Wear**  
No Mechanical Elements & Non-Contact Sensing
- > **The Wiegand Experts**  
Entire Production Chain from Wire to Sensor





# WIEGAND SENSORS

## The Wiegand Experts

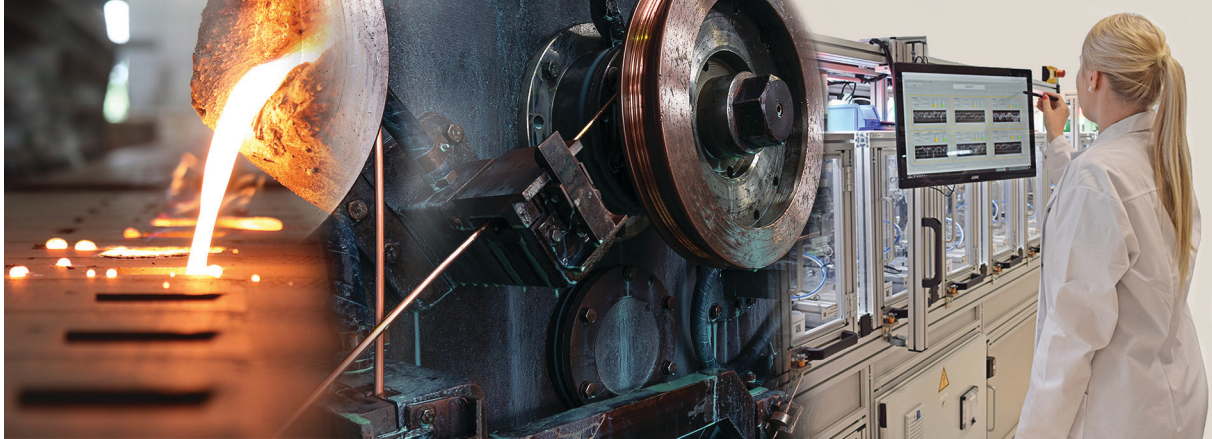

Having successfully implemented Wiegand technology since 2006, we took over wire production from the World's leading Wiegand wire manufacturer in 2013. Under the brand POSITAL, significant expertise and a strong team has been built focusing on Wiegand wire production and the application of Wiegand Sensors in Multiturn rotary encoders. The entire production chain, from the smelting of alloys through to the final production of Wiegand sensors and assemblies, is controlled and optimized by our engineering and logistics teams. Continuous improvement of product quality and production efficiencies have pushed the possibilities of the technology and in 2021, UBITO was launched as a new brand to take Wiegand Technology into large new market segments.

## Applications

Wiegand Sensors are used effectively in a number of applications which exploit the pulses either as signals or for energy harvesting, and sometimes even both. They have already been implemented in water and gas meters, multi-turn rotary encoders and many other applications. The advent of ultra-low power electronics and ultra-efficient integrated circuits opens up a wide range of new applications for this uniquely useful little wire.

### Pulsing / Metering



- > Flowmeters
- > Tachometers
- > Proximity Sensors (Intrinsically safe)

### Condition Monitoring

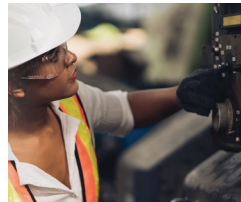

- > Autonomous Wireless IoT Sensor Units
- > Preventative Maintenance
- > Self-powered

### Power Transmission



- > Low Frequency Wireless Power Transmission (e.g. Transcutaneous)
- > Kinetic Energy Harvest (e.g. Mag-drive Pumps)

### Battery-free Multiturn



- > POSITAL Absolute Multiturn Encoders

# WIEGAND SENSORS

## The Wiegand Effect

Magnetic 'fast reversals' inherent in the Wiegand Effect occur inside the wire at the heart of the sensor. These reversals can be harnessed to induce distinct energy pulses in a pick-up coil. Combined with its self-powering nature, this reliable pulse behavior makes Wiegand sensors the ideal sensing solution for many applications.

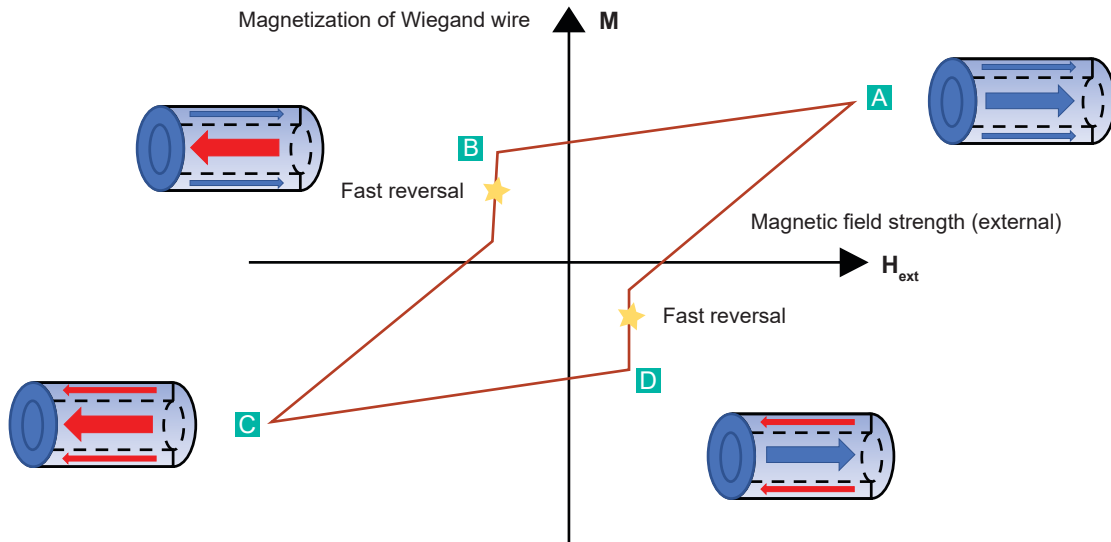

- A** At the beginning of the cycle, the magnetic polarity of the outer shell and the inner core both follow the external field.
- B** As the wire is exposed to a moderate external field of the opposite polarity, the outer layer of the wire shields the core, with both retaining their initial polarity. However, when the strength of the external field overwhelms the influence of the outer layer, the polarity of the core suddenly reverses. This sudden change in polarity creates a current pulse in a coil surrounding the wire.
- C** The increasing external field eventually cause the polarity of the outer shell to reverse as well as the wire reaches saturation.
- D** As the external field diminishes, the wire retains its 'new' polarity. When the external field (now reversed) reaches the critical threshold, the core material of the Wiegand wire will 'flip' back to its previous polarity, producing a current pulse in the surrounding coil. This is then followed by a reversal of the polarity of the outer layer. The wire is now back in State A.

Sold & Serviced By:



Canadian and International Sales

**ELECTROMATE**

877-737-8698

[sales@electromate.com](mailto:sales@electromate.com)

[www.electromate.com](http://www.electromate.com)

U.S. Sales

**SERVO2GO.com**

877-378-0240

[sales@servo2go.com](mailto:sales@servo2go.com)

[www.servo2go.com](http://www.servo2go.com)

# WHY CHOOSE POSITAL?

## Mass Customization



### Online Product Configurator



POSITAL's online product finder allows customers to "build" their own sensors by specifying performance characteristics, mechanical features, and communications interfaces. These devices will then be custom-assembled through a computer-controlled manufacturing system that ensures quality, traceability and rapid delivery; all at prices comparable to mass-produced items.

### 1 Million Products

POSITAL encoders are based on a modular architecture that makes it possible for the company to offer an extremely wide range of configuration options. With a wide variety of mechanical options and programmable software features, POSITAL sensors can be installed in any application - from limited-space industrial environments to tough outdoor settings.

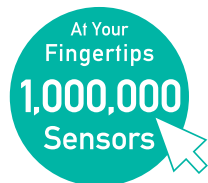

### ENCODERMATCH

After many years of successfully replacing and retrofitting thousands of sensors, POSITAL has created an easy-to-use cross reference finder. Encodermatch allows you to find a replacement with only two pieces of information: the manufacturer and the product key. The database includes more than 20 international encoder manufacturers and over 1 million products. And the list is still growing!

### 36 Month Warranty

All products sold under the POSITAL brand name include a 36 month (3 years) warranty from the date of shipping. This is an industry leading timeframe, supported by decades of experience with rotary encoders.



Sold & Serviced By:



## ACCESSORIES

### The Right Accessory for Every Application

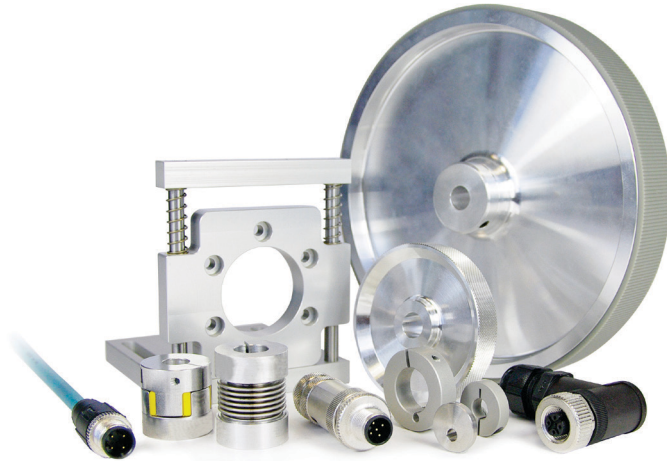

POSITAL offers a wide selection of accessories that simplify sensor installation and help to ensure a long and reliable service life for both the sensors and the machinery they are monitoring. Different industrial environments pose different challenges, which is why POSITAL is continuously adding new accessories to its portfolio. The quality of the accessories can be as important as the quality of the encoder or inclinometer therefore we encourage users to rely on field-tested POSITAL accessories.

#### > **Wide Range of Accessories**

POSITAL provides wide range of accessories from mechanical mounting interfaces to electrical connection systems, including spare parts and configuration modules.

#### > **One-Stop Shop**

POSITAL aims to provide a one-stop shop for all accessory needs to offer solutions that meet the specification of our customer's applications.

#### > **Readiness and Availability**

All of our accessories are ready for order. Stocks are indicated directly online and delivery can be performed within 3 working days. We provide partners with lot size and project discounts.

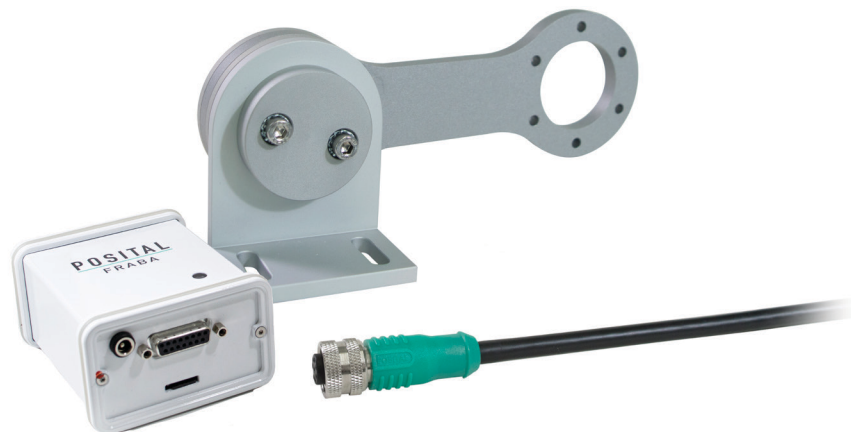

# ACCESSORIES

## 1 Connectors and Cables



- > M12, M23 Female and Male Connectors
- > Straight and Right-Angled Connectors
- > Wide Range of Cable Diameter
- > Cables Lengths: 1m to 10m (Up to 30m)

## 2 Couplings



Couplings are used to attach the encoder shaft to the machines' moving shaft.

- > Bellow Coupling (D1: 6, 8, 10 mm; D2: 6, 6.35, 8, 9.52, 10, 12 mm)
- > Jaw couplings (D1: 6, 8, 10, 12 mm; D2: 6, 6.35, 8, 9.52, 10, 12 mm)
- > Disc Coupling (D1: 6, 10, 12 mm; D2: 6, 10, 12 mm)
- > Double Loop (D1: 10, 12 mm, D2: 8, 9.52, 10, 12, 12.7 mm)

## 3 Measuring Wheels



Measuring Wheels coupled with rotary encoders are a simple way to measure direct linear motion.

- > Wheel Circumference: 200, 304.8, 500 mm
- > Surface Structure: Cross-hatched Knurling; Smooth; Studded; Corrugated

## 4 Draw Wire Adapters



Draw Wires or Cable Pull adapters, when combined with encoders, accurately measure the linear position and communicate the position over the interface of your choice.

- > Measurement Lengths: 1.90, 2, 2.40, 3, 5, 6, 7.50, 10, 15, 30 m
- > Draw Wire Adapters (Standard/ Explosion Proof), Draw Wire Accessories
- > Machined Metal Cylindrical/Rectangular Housing; Plastic; Extruded Metal

## 5 Mounting Bracket and Adapter Flanges

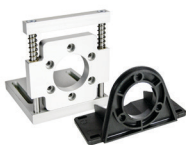

Mounting bracket and adapter flanges are generally used with POSITAL encoders to custom-fit the customer's installation needs.

- > Compatible with Synchro or Clamping flanges  $\varnothing 36$ ,  $\varnothing 42$ , 58 mm
- > Adapted size:  $\varnothing 58$ , 63.5, 65, 67, 78, 80, 90, 100, 116 mm

## ACCESSORIES

### 6 Configuration and Interface Modules



- > UBIFAST Configuration Tool (for IXARC Encoders)
- > SSI2USB Interface Modules

### 7 Counters & Display Modules



- > Interfaces: Analog, SSI, Incremental
- > Outputs: Digital, Analog, Relay (Programmable)

### 8 Explosion Proof Accessories



- > Ex-Proof Blind Plugs
- > Ex-Proof Cable Glands
- > Ex-Proof Draw Wires

### 9 Clamping Rings



- > Diameters  $\varnothing 6$ , 12, 15 mm
- > Stainless Steel and Aluminum

### 10 Torque Support

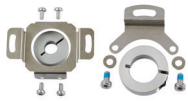

- > Tethers & Stator Couplings
- > Flanges  $\varnothing 36$  mm &  $\varnothing 58$  mm
- > Adapted size:  $\varnothing 42$  – 150 mm

### 11 Clamp Discs



- > Secure Clamp Flange
- > Simple Zero-Point Setting
- > Centered or Eccentric Holes

### 12 Reducing Adapter



- > Blind & Thru Hollow Shaft
- > Reduced Diam.:  $\varnothing 6$  – 14 mm
- > Material: Brass, Stainless Steel

### 13 Connection Caps



- > Interfaces: Profibus, CANopen, DeviceNet
- > Aluminum, Stainless Steel
- > Blind Plugs, Cable Glands, Connectors

Sold & Serviced By:



Canadian and International Sales

**ELECTROMATE**

877-737-8698

[sales@electromate.com](mailto:sales@electromate.com)

[www.electromate.com](http://www.electromate.com)

U.S. Sales

**SERVO2GO.com**

877-378-0240

[sales@servo2go.com](mailto:sales@servo2go.com)

[www.servo2go.com](http://www.servo2go.com)

# POSITAL WORLDWIDE

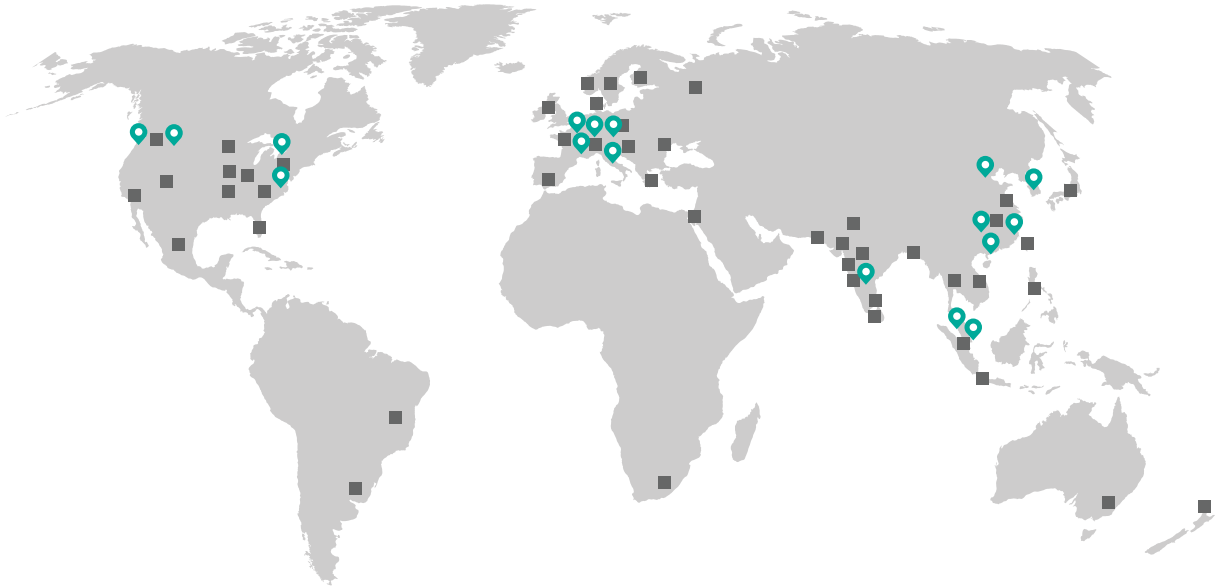

Sold & Serviced By:

 Canadian and International Sales  
**ELECTROMATE**  
877-737-8698  
[sales@electromate.com](mailto:sales@electromate.com)  
[www.electromate.com](http://www.electromate.com)

U.S. Sales  
**SERVO2GO.com**  
877-378-0240  
[sales@servo2go.com](mailto:sales@servo2go.com)  
[www.servo2go.com](http://www.servo2go.com)

## Become a Partner

POSITAL is evolving and growing, entering new industries and new regional markets. Therefore, we are looking for new distributors: Distribution Partners, System Integrators and Registered Distributors. Our global distributor program clarifies which types of partnerships we are offering, along with their associated benefits and obligations.



Sold & Serviced By:



*Canadian and International Sales*

**ELECTROMATE**

**877-737-8698**

[sales@electromate.com](mailto:sales@electromate.com)

[www.electromate.com](http://www.electromate.com)

*U.S. Sales*

**SERVO2GO.com**

**877-378-0240**

[sales@servo2go.com](mailto:sales@servo2go.com)

[www.servo2go.com](http://www.servo2go.com)

**Join Our Network!**



Cologne (EMEA) – Hamilton (Americas) – Singapore (APAC) – Shanghai (China)