

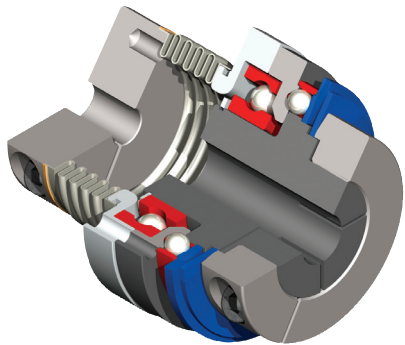

▶ SAFETY COUPLING OVERVIEW



Safety couplings are used to minimize expensive damage when a collision occurs in a high performance servo drive system. When a collision occurs, the safety coupling will stop the destructive inertial forces instantly and eliminate downtime and repair costs often associated when just an overload relay is used.

Safety couplings are spring loaded form fit couplings that transmit torque through the use of a special degressive cup spring in which the hardened and polished balls are preloaded into the spherical indentations. When an overload occurs, the hub (with its ball cage) will over twist and press the balls out of the indentations to disengage. Only the balls and cup spring move axially resulting in a very low disengagement mass. A proximity switch is used to initiate an emergency stop to shut the servo motor down.

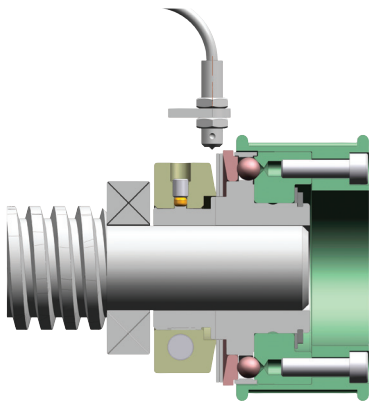

Safety Coupling Mechanism:

Automatic Re-engagement Versions

Re-engagement occurs at the same reference point every 360°. Versions are available that will automatically re-engage or remain disengaged until drive rotation is reversed.

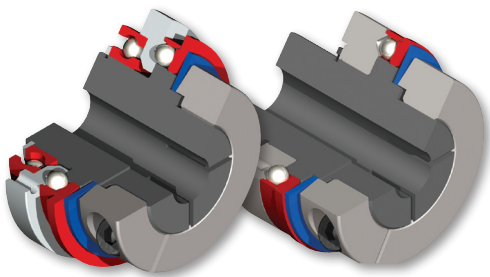

Bearing Support Versions

Integrated ball bearing or sliding bearing to support the pulley. This eliminates the need for support inside the pulley and allows for a more compact overall design.

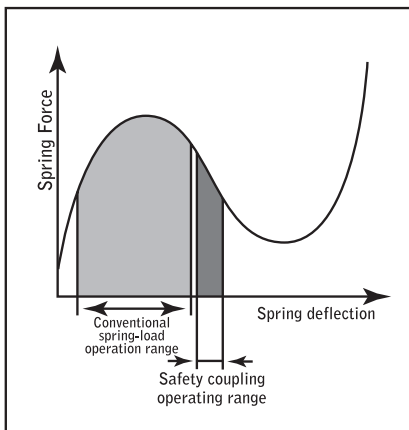

Degressive Spring Curve

Special springs were developed to operate on the diminishing side of the spring curve resulting in immediate torque drop off at activation and reduced destructive forces and damage.

Sold & Serviced By:



Toll Free Phone (877) SERV098
Toll Free Fax (877) SERV099
www.electromate.com
sales@electromate.com

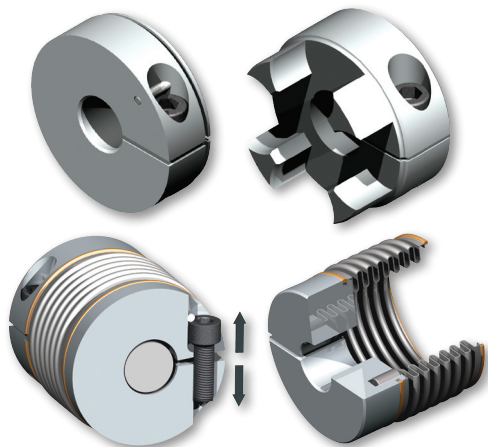

Clamping Methods:

Aluminum Radial Clamping Hub • High tensile strength, low weight aerospace aluminum provides very low inertia for better system performance.

- New EASY Clamp System prevents damage to hubs for easy shaft mounting and dismounting while compensating for tolerance differences between shaft and hub.
- Balancing Plug is positioned at a precise angle in the hub for balanced, high speed performance.
- Precision machined involutes (not a die cast).
- Zero backlash torque transmission is guaranteed through the elimination of keyways.
- Only one clamping screw allows for fast installation.



Steel Conical Bushings (also available in aluminum versions)

- High clamping forces to insure safe transmission of torque and backlash free connection.
- Additional draw-off holes provide easy hub removal.
- Unique hub design offers shortest coupling length.

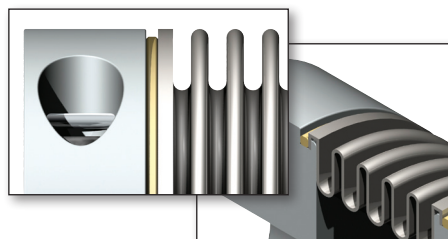

Connection Method:

Brass Wire Press-Fit Connection

- Mechanically formed between hub and multi-layered bellows for a strong zero backlash connection.
- No glue connection insures connection in high temperature, chemical sensitive applications.

Torque Transmission Elements:

Bellows



- Guarantees a zero backlash torque transmission with extremely high torsional stiffness while maintaining flexibility for compensation of misalignment.
- Low mass moment of inertia for increased system performance.
- Maintenance free up to temperatures of 300°C (572°F).
- Depending upon torsional stiffness requirements, lateral spring rates and lengths, standard bellows are available in 2, 4 and 6 corrugations. For longer lengths, custom manufacturing is available.

Elastomers

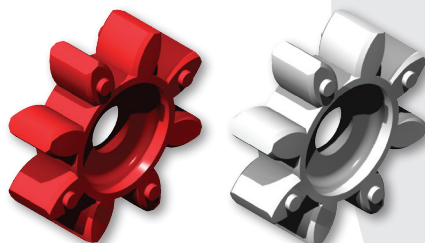

- Elastomers vary in hardness values from 98 Shore A (red) for maximum dampening capabilities to the 72 Shore D (white) where higher stiffness is required.
- Excellent electrical insulator to prevent the transfer of electrical fields.
- Involute shaped teeth provide easy plug-in assembly for long and durable life.

Sold & Serviced By:

 **ELECTROMATE**

Toll Free Phone (877) SERV098

Toll Free Fax (877) SERV099

www.electromate.com

sales@electromate.com



SKB-KP DIRECT DRIVE BELLOWS SAFETY COUPLING

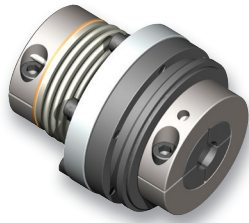

Major Features

- Bellows safety coupling with radial clamping hubs.
- Upon disengagement, coupling will re-engage automatically at only one point per revolution and retain the drive's reference point.
- Bellow compensates for axial, lateral and angular misalignment.
- Adjustable disengagement torque.

Material

- Stainless steel bellow; aluminum and steel hubs; steel safety element

Technical data/Dimensions

Size SKB-KP	Disengagement Torque Range		Moment of Inertia	Torsion Resistance	Max. Lateral Misalignment	Mass	Screw Size	Torque to Tighten Screws		Outer Diameter	Length	Switching Distance	Bore Range øD1*		Bore Range øD2**	
	Nm (lb-in)		10 ⁻³ kgm ² (lb-in ²)	Nm/ arcmin (lb-ft/Deg)	mm (inch)	kg (lbs)		*Al Hub Nm (lb-in)	**Steel Hub Nm (lb-in)				mm (inch)	mm (inch)	mm (inch)	mm (inch)
SKB-KP-6	2 (18)	6 (53)	0.13 (0.44)	2.1 (93)	0.15 (0.006)	0.45 (0.99)	M5	7 (62)	10 (89)	52.5 (2.067)	81 (3.189)	0.9 (0.035)	6 (0.236)	19 (0.748)	6 (0.236)	16 (0.630)
SKB-KP-12	6 (53)	12 (106)	0.13 (0.44)	2.1 (93)	0.15 (0.006)	0.45 (0.99)	M5	7 (62)	10 (89)	52.5 (2.067)	81 (3.189)	0.9 (0.035)	8 (0.315)	19 (0.748)	8 (0.315)	16 (0.630)
SKB-KP-15	8 (71)	15 (133)	0.5 (1.71)	9 (399)	0.2 (0.008)	1 (2.20)	M6	14 (124)	18 (159)	69 (2.717)	94.5 (3.720)	1.2 (0.047)	9 (0.354)	30 (1.181)	10 (0.394)	25.4 (1.000)
SKB-KP-30	13 (115)	30 (266)	0.5 (1.71)	9 (399)	0.2 (0.008)	1 (2.20)	M6	14 (124)	18 (159)	69 (2.717)	94.5 (3.720)	1.2 (0.047)	12 (0.472)	30 (1.181)	12 (0.472)	25.4 (1.000)
SKB-KP-45	22 (195)	45 (398)	0.5 (1.71)	9 (399)	0.2 (0.008)	1 (2.20)	M6	14 (124)	18 (159)	69 (2.717)	94.5 (3.720)	1.2 (0.047)	16 (0.630)	30 (1.181)	14 (0.551)	25.4 (1.000)
SKB-KP-60	25 (221)	60 (531)	1.5 (5.13)	20 (886)	0.2 (0.008)	1.9 (4.19)	M8	35 (310)	40 (354)	88 (3.465)	107 (4.213)	1.6 (0.063)	15 (0.591)	38 (1.496)	18 (0.709)	35 (1.378)
SKB-KP-100	40 (354)	100 (885)	1.5 (5.13)	20 (886)	0.2 (0.008)	1.9 (4.19)	M8	35 (310)	40 (354)	88 (3.465)	107 (4.213)	1.6 (0.063)	20 (0.787)	38 (1.496)	18 (0.709)	35 (1.378)
SKB-KP-150	60 (531)	150 (1328)	1.5 (5.13)	20 (886)	0.2 (0.008)	1.9 (4.19)	M8	35 (310)	40 (354)	88 (3.465)	107 (4.213)	1.6 (0.063)	25 (0.984)	38 (1.496)	24 (0.945)	35 (1.378)
SKB-KP-230	80 (708)	230 (2036)	5.5 (18.79)	28 (1240)	0.2 (0.008)	3.8 (8.38)	M10	65 (575)	80 (708)	115 (4.528)	132 (5.197)	1.8 (0.071)	25 (0.984)	43 (1.693)	24 (0.945)	44 (1.732)
SKB-KP-330	130 (1151)	330 (2921)	5.5 (18.79)	28 (1240)	0.2 (0.008)	3.8 (8.38)	M10	65 (575)	80 (708)	115 (4.528)	132 (5.197)	1.8 (0.071)	32 (1.260)	43 (1.693)	32 (1.260)	44 (1.732)
SKB-KP-500	200 (1770)	500 (4425)	14 (47.84)	52 (2303)	0.2 (0.008)	6.8 (14.99)	M12/M14	115 (1018)	220 (1947)	137 (5.394)	152.5 (6.003)	2.5 (0.098)	35 (1.378)	55 (2.165)	28 (1.102)	58 (2.283)
SKB-KP-800	350 (3098)	800 (7081)	16 (54.67)	106 (4694)	0.2 (0.008)	7.2 (15.87)	M14	200 (1770)	220 (1947)	137 (5.394)	169 (6.654)	2.5 (0.098)	42 (1.654)	70 (2.756)	40 (1.575)	58 (2.283)
SKB-KP-1000	500 (4425)	1000 (8851)	80 (273.37)	80 (3542)	0.3 (0.012)	20 (44.09)	M14/M16	185 (1637)	290 (2567)	181 (7.126)	236 (9.291)	3.7 (0.146)	50 (1.968)	75 (2.953)	42 (1.654)	100 (3.937)
SKB-KP-2000	800 (7081)	2000 (17702)	88 (300.71)	140 (6199)	0.3 (0.012)	21 (46.30)	M16	290 (2567)	290 (2567)	181 (7.126)	239 (9.409)	3.7 (0.146)	65 (2.559)	85 (3.346)	45 (1.772)	100 (3.937)
SKB-KP-3000	1500 (13276)	3000 (26552)	111 (379.30)	280 (12398)	0.2 (0.008)	30 (66.14)	M16	290 (2567)	290 (2567)	181 (7.126)	263 (10.354)	3.7 (0.146)	70 (2.756)	85 (3.346)	50 (1.968)	100 (3.937)

Sold & Shipped By:

 Toll Free Phone (877) SERV099

 Toll Free Fax (877) SERV099

www.electromate.com

sales@electromate.com



SKY-KS SERIES SAFETY COUPLING

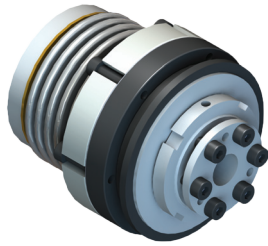

Major Features

- Bellows safety coupling with self-centering conical hub and radial clamping hub.
- Upon disengagement, coupling will re-engage automatically at only one point per revolution and retain the drive's reference point.
- Bellow compensates for axial, lateral and angular misalignment.
- Adjustable disengagement torque.

Material

- Stainless steel bellow; aluminum and steel hubs; steel safety element

Size SKY-KS	Disengagement Torque Range		Moment of Inertia	Torsion Resistance	Max. Lateral Misalignment	Mass	Screw Size	Torque to Tighten Screws		Outer Diameter	Length	Bore Range øD1*		Bore Range øD2**	
	Nm (lb-in)	Nm (lb-in)	10 ⁻³ kgm ² (lb-in ²)	Nm/ arcmin (lb-ft/Deg)	mm (inch)	kg (lbs)	*/**	Nm* (lb-in)	Nm** (lb-in)	mm (inch)	mm (inch)	mm (inch)	mm (inch)	mm (inch)	mm (inch)
SKY-KS-6	2 (18)	6 (53)	0.12 (0.41)	2.1 (93)	0.15 (0.006)	0.5 (1.10)	M4/M3	3 (27)	2 (18)	52.5 (2.067)	80 (3.150)	6 (0.236)	16 (0.630)	5 (0.197)	11.5 (0.453)
SKY-KS-12	6 (53)	12 (106)	0.12 (0.41)	2.1 (93)	0.15 (0.006)	0.5 (1.10)	M4/M3	3 (27)	2 (18)	52.5 (2.067)	80 (3.150)	6 (0.236)	16 (0.630)	5 (0.197)	11.5 (0.453)
SKY-KS-15	8 (71)	15 (133)	0.44 (1.50)	9 (399)	0.2 (0.008)	0.98 (2.16)	M4	4 (35)	4 (35)	69 (2.717)	86 (3.386)	9 (0.354)	19 (0.748)	9 (0.354)	17 (0.669)
SKY-KS-30	13 (115)	30 (266)	0.44 (1.50)	9 (399)	0.2 (0.008)	0.98 (2.16)	M4	4 (35)	4 (35)	69 (2.717)	86 (3.386)	9 (0.354)	19 (0.748)	9 (0.354)	17 (0.669)
SKY-KS-45	22 (195)	45 (398)	0.44 (1.50)	9 (399)	0.2 (0.008)	0.98 (2.16)	M4	4 (35)	4 (35)	69 (2.717)	86 (3.386)	10 (0.394)	19 (0.748)	10 (0.394)	17 (0.669)
SKY-KS-60	25 (221)	60 (531)	1.4 (4.78)	20 (886)	0.2 (0.008)	1.9 (4.19)	M6	14 (124)	14 (124)	88 (3.465)	99 (3.898)	12 (0.472)	24 (0.945)	12 (0.472)	24 (0.945)
SKY-KS-100	40 (354)	100 (885)	1.4 (4.78)	20 (886)	0.2 (0.008)	1.9 (4.19)	M6	14 (124)	14 (124)	88 (3.465)	99 (3.898)	12 (0.472)	24 (0.945)	12 (0.472)	24 (0.945)
SKY-KS-150	60 (531)	150 (1328)	1.4 (4.78)	20 (886)	0.2 (0.008)	1.9 (4.19)	M6	14 (124)	14 (124)	88 (3.465)	99 (3.898)	14 (0.551)	24 (0.945)	14 (0.551)	24 (0.945)
SKY-KS-230	80 (708)	230 (2036)	5.1 (17.43)	28 (1240)	0.2 (0.008)	3.9 (8.60)	M6	14 (124)	14 (124)	115 (4.528)	117 (4.606)	18 (0.709)	35 (1.378)	18 (0.709)	35 (1.378)
SKY-KS-330	130 (1151)	330 (2921)	5.1 (17.43)	28 (1240)	0.2 (0.008)	3.9 (8.60)	M6	14 (124)	14 (124)	115 (4.528)	117 (4.606)	22 (0.866)	35 (1.378)	22 (0.866)	35 (1.378)
SKY-KS-500	200 (1770)	500 (4425)	12.5 (42.71)	52 (2303)	0.2 (0.008)	6.7 (14.77)	M8	34 (301)	34 (301)	137 (5.394)	143 (5.630)	28 (1.102)	42 (1.654)	28 (1.102)	42 (1.654)
SKY-KS-800	350 (3098)	800 (7081)	14.6 (49.89)	106 (4694)	0.2 (0.008)	7.7 (16.98)	M10/M8	65 (575)	34 (301)	137 (5.394)	152 (5.984)	30 (1.181)	48 (1.890)	30 (1.181)	44 (1.732)
SKY-KS-1000	500 (4425)	1000 (8851)	58 (198.19)	80 (3542)	0.3 (0.012)	16 (35.27)	M10/ M12	65 (575)	115 (1018)	181 (7.126)	208 (8.189)	40 (1.575)	60 (2.362)	40 (1.575)	62 (2.441)
SKY-KS-2000	800 (7081)	2000 (17702)	69 (235.78)	140 (6199)	0.3 (0.012)	18.5 (40.79)	M12	115 (1018)	115 (1018)	181 (7.126)	211 (8.307)	42 (1.654)	70 (2.756)	40 (1.575)	62 (2.441)
SKY-KS-3000	1500 (13276)	3000 (26552)	70.5 (240.91)	260 (11513)	0.2 (0.008)	19 (41.89)	M12	115 (1018)	115 (1018)	181 (7.126)	211 (8.307)	48 (1.890)	70 (2.756)	48 (1.890)	62 (2.441)

Coupling must be selected so nominal torque is higher than highest operational torque of the application (i.e., during acceleration). Bore diameters smaller than the minimum are possible but reliable transmission of nominal torque cannot be guaranteed.

*Bellows side of coupling
**Safety element

ELECTROMATE
 Toll Free Phone (877) SERV098
 Toll Free Fax (877) SERV099
 www.electromate.com
 sales@electromate.com

SKB-EK DIRECT DRIVE ELASTOMER SAFETY COUPLING

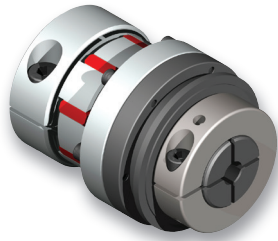

Major Features

- Elastomer safety coupling with radial EASY Clamp System hubs.
- Upon disengagement, coupling will re-engage automatically at only one point per revolution and retain the drive's reference point.
- Star-shaped elastomer element with involute tooth profile and high shore hardness ensures zero backlash over life of product.
- Electrically insulating and dampens oscillation resonance.

Material

- Aluminum and steel hubs; elastomer spider; steel safety element

Technical data/Dimensions

Size SKB-EK	Disengagement Torque Range		Moment of Inertia	Torsion Resistance	Max. Lateral Misalignment	Mass	Screw Size	Torque to Tighten Screws		Outer Diameter	Length	Switching Distance	Bore Range øD1*		Bore Range øD2**	
	Nm (lb-in)		10 ⁻³ kgm ² (lb-in ²)	Nm/arcmin (lb-ft/Deg)	mm (inch)	kg (lbs)		*Al Hub Nm (lb-in)	**Steel Hub Nm (lb-in)	mm (inch)	mm (inch)	mm (inch)	min. mm (inch)	max. mm (inch)	min. mm (inch)	max. mm (inch)
SKB-EK-6	2 (18)	6 (53)	0.13 (0.44)	0.24 (11)	0.1 (0.004)	0.44 (0.97)	M5	8 (71)	10 (89)	52.5 (2.067)	77 (3.031)	0.9 (0.035)	8 (0.315)	20 (0.787)	6 (0.236)	16 (0.630)
SKB-EK-12	6 (53)	12 (106)	0.13 (0.44)	0.24 (11)	0.1 (0.004)	0.44 (0.97)	M5	8 (71)	10 (89)	52.5 (2.067)	77 (3.031)	0.9 (0.035)	8 (0.315)	20 (0.787)	8 (0.315)	16 (0.630)
SKB-EK-15	8 (71)	15 (133)	0.5 (1.71)	0.61 (27)	0.1 (0.004)	1 (2.20)	M6	14 (124)	18 (159)	69 (2.717)	91.5 (3.602)	1.2 (0.047)	12 (0.472)	32 (1.260)	10 (0.394)	25.4 (1.000)
SKB-EK-30	13 (115)	30 (266)	0.5 (1.71)	0.61 (27)	0.1 (0.004)	1 (2.20)	M6	14 (124)	18 (159)	69 (2.717)	91.5 (3.602)	1.2 (0.047)	12 (0.472)	32 (1.260)	12 (0.472)	25.4 (1.000)
SKB-EK-45	22 (195)	45 (398)	0.5 (1.71)	0.61 (27)	0.1 (0.004)	1 (2.20)	M6	14 (124)	18 (159)	69 (2.717)	91.5 (3.602)	1.2 (0.047)	14 (0.551)	32 (1.260)	14 (0.551)	25.4 (1.000)
SKB-EK-60	25 (221)	60 (531)	1.5 (5.13)	1.05 (46)	0.1 (0.004)	2 (4.41)	M8	35 (310)	40 (354)	88 (3.465)	107 (4.213)	1.6 (0.063)	16 (0.630)	38 (1.496)	18 (0.709)	35 (1.378)
SKB-EK-100	40 (354)	100 (885)	1.5 (5.13)	1.05 (46)	0.1 (0.004)	2 (4.41)	M8	35 (310)	40 (354)	88 (3.465)	107 (4.213)	1.6 (0.063)	19 (0.748)	38 (1.496)	18 (0.709)	35 (1.378)
SKB-EK-150	60 (531)	150 (1328)	1.5 (5.13)	1.05 (46)	0.1 (0.004)	2 (4.41)	M8	35 (310)	40 (354)	88 (3.465)	107 (4.213)	1.6 (0.063)	22 (0.866)	38 (1.496)	24 (0.945)	35 (1.378)
SKB-EK-230	80 (708)	230 (2036)	5.6 (19.14)	2 (89)	0.12 (0.005)	4.2 (9.26)	M12/M10	115 (1018)	80 (708)	115 (4.528)	134 (5.276)	1.8 (0.071)	24 (0.945)	43 (1.693)	24 (0.945)	42 (1.654)
SKB-EK-330	130 (1151)	330 (2921)	5.6 (19.14)	2 (89)	0.12 (0.005)	4.2 (9.26)	M12/M10	115 (1018)	80 (708)	115 (4.528)	134 (5.276)	1.8 (0.071)	32 (1.260)	43 (1.693)	32 (1.260)	42 (1.654)
SKB-EK-500	200 (1770)	500 (4425)	17 (58.09)	8 (354)	0.15 (0.006)	8.6 (18.96)	M14	185 (1637)	220 (1947)	137 (5.394)	167.5 (6.594)	2.5 (0.098)	30 (1.181)	70 (2.756)	28 (1.102)	58 (2.283)
SKB-EK-800	350 (3098)	800 (7081)	17 (58.09)	8 (354)	0.15 (0.006)	8.6 (18.96)	M14	185 (1637)	220 (1947)	137 (5.394)	167.5 (6.594)	2.5 (0.098)	42 (1.654)	70 (2.756)	40 (1.575)	58 (2.283)
SKB-EK-1000	500 (4425)	1000 (8851)	79 (269.95)	12 (531)	0.1 (0.004)	19.5 (42.99)	M14/M16	185 (1637)	290 (2567)	181 (7.126)	204 (8.031)	3.7 (0.146)	48 (1.890)	70 (2.756)	42 (1.654)	100 (3.937)

Sold & Serviced By:

ELECTROMATE

Toll Free Phone (877) SERV098

Toll Free Fax (877) SERV099

www.electromate.com

sales@electromate.com

SKY-ES SERIES SAFETY COUPLING

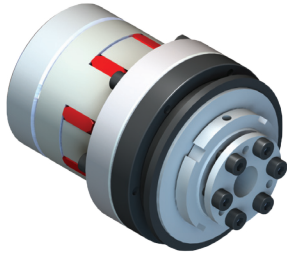

Major Features

- Elastomer safety coupling with self-centering conical hub and radial clamping hubs.
- Upon disengagement, coupling will re-engage automatically at only one point per revolution and retain the drive's reference point.
- Star-shaped elastomer element with involute tooth profile and high shore hardness ensures zero backlash over life of product.
- Electrically insulating and dampens oscillation resonance.

Material

- Steel hubs; elastomer spider; steel safety element

Size SKY-ES	Disengagement Torque Range		Moment of Inertia	Torsion Resistance	Max. Lateral Misalignment	Mass	Screw Size	Torque to Tighten Screws		Outer Diameter	Length	Bore Range øD1*		Bore Range øD2**	
	Nm (lb-in)		10 ⁻³ kgm ² (lb-in ²)	Nm/arcmin (lb-ft/Deg)	mm (inch)	kg (lbs)	*/**	Nm* (lb-in)	Nm** (lb-in)	mm (inch)	mm (inch)	mm (inch)	mm (inch)	mm (inch)	mm (inch)
SKY-ES-6	2 (18)	6 (53)	0.13 (0.44)	0.24 (11)	0.1 (0.004)	0.5 (1.10)	M4/M3	4 (35)	2 (18)	52.5 (2.067)	83 (3.268)	9 (0.354)	19 (0.748)	5 (0.197)	11.5 (0.453)
SKY-ES-12	6 (53)	12 (106)	0.13 (0.44)	0.24 (11)	0.1 (0.004)	0.5 (1.10)	M4/M3	4 (35)	2 (18)	52.5 (2.067)	83 (3.268)	9 (0.354)	19 (0.748)	5 (0.197)	11.5 (0.453)
SKY-ES-15	8 (71)	15 (133)	0.5 (1.71)	0.6 (27)	0.1 (0.004)	1 (2.20)	M5/M4	8 (71)	4 (35)	69 (2.717)	100 (3.937)	12 (0.472)	26 (1.024)	9 (0.354)	17 (0.669)
SKY-ES-30	13 (115)	30 (266)	0.5 (1.71)	0.6 (27)	0.1 (0.004)	1 (2.20)	M5/M4	8 (71)	4 (35)	69 (2.717)	100 (3.937)	12 (0.472)	26 (1.024)	9 (0.354)	17 (0.669)
SKY-ES-45	22 (195)	45 (398)	0.5 (1.71)	0.6 (27)	0.1 (0.004)	1 (2.20)	M5/M4	8 (71)	4 (35)	69 (2.717)	100 (3.937)	12 (0.472)	26 (1.024)	10 (0.394)	17 (0.669)
SKY-ES-60	25 (221)	60 (531)	1.4 (4.78)	1.05 (46)	0.1 (0.004)	1.9 (4.19)	M5/M6	8 (71)	18 (159)	88 (3.465)	115.5 (4.547)	12 (0.472)	36 (1.417)	12 (0.472)	24 (0.945)
SKY-ES-100	40 (354)	100 (885)	1.4 (4.78)	1.05 (46)	0.1 (0.004)	1.9 (4.19)	M5/M6	8 (71)	18 (159)	88 (3.465)	115.5 (4.547)	12 (0.472)	36 (1.417)	12 (0.472)	24 (0.945)
SKY-ES-150	60 (531)	150 (1328)	1.4 (4.78)	1.05 (46)	0.1 (0.004)	1.9 (4.19)	M5/M6	8 (71)	18 (159)	88 (3.465)	115.5 (4.547)	14 (0.551)	36 (1.417)	14 (0.551)	24 (0.945)
SKY-ES-230	80 (708)	230 (2036)	5.5 (18.79)	2 (89)	0.12 (0.005)	4.3 (9.48)	M8/M6	35 (310)	18 (159)	115 (4.528)	145.5 (5.728)	19 (0.748)	40 (1.575)	18 (0.709)	35 (1.378)
SKY-ES-330	130 (1151)	330 (2921)	5.5 (18.79)	2 (89)	0.12 (0.005)	4.3 (9.48)	M8/M6	35 (310)	18 (159)	115 (4.528)	145.5 (5.728)	19 (0.748)	40 (1.575)	22 (0.866)	35 (1.378)
SKY-ES-500	200 (1770)	500 (4425)	18.5 (63.22)	8 (354)	0.15 (0.006)	8.8 (19.40)	M12/M8	115 (1018)	35 (310)	137 (5.394)	187 (7.362)	25 (0.984)	60 (2.362)	28 (1.102)	44 (1.732)
SKY-ES-800	350 (3098)	800 (7081)	18.5 (63.22)	8 (354)	0.15 (0.006)	8.8 (19.40)	M12/M8	115 (1018)	35 (310)	137 (5.394)	187 (7.362)	28 (1.102)	60 (2.362)	30 (1.181)	44 (1.732)
SKY-ES-1000	500 (4425)	1000 (8851)	57 (194.78)	12 (531)	0.1 (0.004)	16 (35.27)	M12/M12	115 (1018)	115 (1018)	181 (7.126)	218 (8.583)	48 (1.890)	60 (2.362)	40 (1.575)	70 (2.756)

Coupling must be selected so nominal torque is higher than highest operational torque of the application (i.e., during acceleration). Bore diameters smaller than the minimum are possible but reliable transmission of nominal torque cannot be guaranteed.

*Bellows side of coupling

**Safety element

Sold & Serviced By:



Toll Free Phone (877) SERV098

Toll Free Fax (877) SERV099

www.electromate.com

sales@electromate.com



SKB SERIES INDIRECT DRIVE SAFETY COUPLING



Major Features

- Pulley safety coupling with self-centering conical hub and integrated bearing.
- Upon disengagement, coupling will re-engage automatically at only one point per revolution and retain the drive's reference point.
- Integrated bearing for high axial and radial loading to support pulleys, gears or sprockets.
- Adjustable disengagement torque.

Material

- Steel hubs; steel safety element

Size SKB	Disengagement Torque Range		Moment of Inertia 10 ⁻³ kgm ² (lb-in ²)	Mass kg (lbs)	Screw Size	Torque to Tighten Screws Nm (lb-in)	Thread Size for Pulley	Outer Diameter mm (inch)	Length mm (inch)	Switching Distance mm (inch)	Bore Range	
	Nm (lb-in)	mm (inch)									min. mm (inch)	max. mm (inch)
SKB-6	2	6	0.09	0.36	M5	10	6xM3	52	41	0.9	6	16
	(18)	(53)										
SKB-12	6	12	0.09	0.36	M5	10	6xM3	52	41	0.9	8	16
	(53)	(106)										
SKB-15	8	15	0.36	0.8	M6	18	6xM4	69	48	1.2	10	25.4
	(71)	(133)										
SKB-30	13	30	0.36	0.8	M6	18	6xM4	69	48	1.2	12	25.4
	(115)	(266)										
SKB-45	22	45	0.36	0.8	M6	18	6xM4	69	48	1.2	14	25.4
	(195)	(398)										
SKB-60	25	60	1.1	1.5	M8	40	6xM6	87	55.5	1.6	18	35
	(221)	(531)										
SKB-100	40	100	1.1	1.5	M8	40	6xM6	87	55.5	1.6	18	35
	(354)	(885)										
SKB-150	60	150	1.1	1.5	M8	40	6xM6	87	55.5	1.6	24	35
	(531)	(1328)										
SKB-230	80	230	4.2	3.3	M10	80	6xM8	113	71.5	1.8	24	44
	(708)	(2036)										
SKB-330	130	330	4.2	3.3	M10	80	6xM8	113	71.5	1.8	32	44
	(1151)	(2921)										
SKB-500	200	500	12.2	6.2	M14	220	8xM8	136	87.5	2.5	28	58
	(1770)	(4425)										
SKB-800	350	800	12.2	6.2	M14	220	8xM8	136	87.5	2.5	40	58
	(3098)	(7081)										
SKB-1000	500	1000	76	20	M16	290	12xM10	181	142	3.7	42	100
	(4425)	(8851)										
SKB-2000	800	2000	76	20	M16	290	12xM10	181	142	3.7	48	100
	(7081)	(17702)										
SKB-3000	1500	3000	76	20	M16	290	12xM10	181	142	3.7	60	100
	(13276)	(26552)										

Coupling must be selected so nominal torque is higher than highest operational torque of the application (i.e., during acceleration)
Bore diameters smaller than the minimum are possible but reliable transmission of nominal torque cannot be guaranteed.

Sold & Serviced By:

 Toll Free Phone (877) SERV098
 Toll Free Fax (877) SERV099
www.electromate.com
sales@electromate.com

▶ SKG SERIES INDIRECT DRIVE SAFETY COUPLING

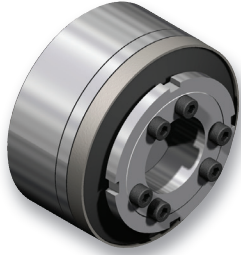

Major Features

- Pulley safety coupling with self-centering conical hub and integrated bearing.
- Upon disengagement, coupling will re-engage automatically at only one point per revolution and retain the drive's reference point.
- Integrated bearing for high axial and radial loading to support pulleys, gears or sprockets.
- Adjustable disengagement torque.

Material

- Aluminum and steel hubs; steel safety element

Size SKG	Disengagement Torque Range		Moment of Inertia 10 ⁻³ kgm ² (lb-in ²)	Mass kg (lbs)	Screw Size	Torque to Tighten Screws	Outer Diameter mm (inch)	Length mm (inch)	Thread Size for Pulley	Switching Distance mm (inch)	Bore Range	
	Nm (lb-in)	Nm (lb-in)				Nm (lb-in)					min. mm (inch)	max. mm (inch)
SKG-4	2	4	0.2 (0.68)	0.5 (1.10)	M4	4	60 (2.362)	40 (1.575)	4xM4	1 (0.039)	12 (0.472)	18 (0.709)
	(18)	(35)				(35)						
SKG-9	4	9	0.2 (0.68)	0.5 (1.10)	M4	4	60 (2.362)	40 (1.575)	4xM4	1 (0.039)	12 (0.472)	18 (0.709)
	(35)	(80)				(35)						
SKG-18	9	18	0.2 (0.68)	0.5 (1.10)	M4	4	60 (2.362)	40 (1.575)	4xM4	1 (0.039)	12 (0.472)	18 (0.709)
	(80)	(159)				(35)						
SKG-23	9	23	0.7 (2.39)	1.1 (2.43)	M5	8	77 (3.031)	54 (2.126)	4xM6	1.4 (0.055)	18 (0.709)	25.5 (1.004)
	(80)	(204)				(71)						
SKG-35	18	35	0.7 (2.39)	1.1 (2.43)	M5	8	77 (3.031)	54 (2.126)	4xM6	1.4 (0.055)	18 (0.709)	25.5 (1.004)
	(159)	(310)				(71)						
SKG-75	25	75	0.7 (2.39)	1.1 (2.43)	M5	8	77 (3.031)	54 (2.126)	4xM6	1.4 (0.055)	18 (0.709)	25.5 (1.004)
	(221)	(664)				(71)						
SKG-100	50	100	1.8 (6.15)	1.9 (4.19)	M6	12	92 (3.622)	55 (2.165)	4xM6	1.4 (0.055)	22 (0.866)	39 (1.535)
	(443)	(885)				(106)						
SKG-170	65	170	3 (10.25)	2.4 (5.29)	M6	12	105 (4.134)	66 (2.598)	4xM6	1.7 (0.067)	22 (0.866)	39 (1.535)
	(575)	(1505)				(106)						
SKG-270	100	270	10.4 (35.54)	5 (11.02)	M8	35	135 (5.315)	85 (3.346)	4xM6	2.2 (0.087)	29 (1.142)	44 (1.732)
	(885)	(2390)				(310)						
SKG-550	200	550	10.7 (36.56)	5.3 (11.68)	M8	35	135 (5.315)	85 (3.346)	4xM6	2.2 (0.087)	29 (1.142)	44 (1.732)
	(1770)	(4868)				(310)						

Coupling must be selected so nominal torque is higher than highest operational torque of the application (i.e., during acceleration).
Bore diameters smaller than the minimum are possible but reliable transmission of nominal torque cannot be guaranteed.



▶ SKX-L SERIES SAFETY COUPLING



Major Features

- Pulley safety coupling with extended hub for smaller pulleys with radial clamping hub.
- Upon disengagement, coupling will re-engage automatically at only one point per revolution and retain the drive's reference point.
- Integrated sliding bearing to support pulleys, gears or sprockets.
- Adjustable disengagement torque.

Material

- Steel hubs; steel safety element

Size SKX-L	Disengagement Torque Range		Moment of Inertia	Mass	Screw Size	Torque to Tighten Screws	Thread Size for Pulley	Outer Diameter	Length	Switching Distance	Bore Range		Extended Diameter
	Nm (lb-in)		10 ⁻³ kgm ² (lb-in ²)	kg (lbs)		Nm (lb-in)		mm (inch)	mm (inch)	mm (inch)	mm (inch)	mm (inch)	mm (inch)
SKX-L-6	2	6	0.05	0.25	M5	10	6xM3	42	46	0.9	7	16	20
	(18)	(53)	(0.17)	(0.55)									
SKX-L-12	6	12	0.05	0.25	M5	10	6xM3	42	46	0.9	11	16	20
	(53)	(106)	(0.17)	(0.55)									
SKX-L-15	8	15	0.25	0.65	M6	18	6xM4	60	52	1.2	11	25.4	30
	(71)	(133)	(0.85)	(1.43)									
SKX-L-30	13	30	0.25	0.65	M6	18	6xM4	60	52	1.2	15	25.4	30
	(115)	(266)	(0.85)	(1.43)									
SKX-L-45	22	45	0.25	0.65	M6	18	6xM4	60	52	1.2	18	25.4	30
	(195)	(398)	(0.85)	(1.43)									
SKX-L-60	25	60	0.95	1.5	M8	40	6xM6	76	69	1.6	18	35	42
	(221)	(531)	(3.25)	(3.31)									
SKX-L-100	40	100	0.95	1.5	M8	40	6xM6	76	69	1.6	22	35	42
	(354)	(885)	(3.25)	(3.31)									
SKX-L-150	60	150	0.95	1.5	M8	40	6xM6	76	69	1.6	26	35	42
	(531)	(1328)	(3.25)	(3.31)									
SKX-L-230	80	230	3.3	3	M10	80	6xM8	104	84	1.8	25	42	50
	(708)	(2036)	(11.28)	(6.61)									
SKX-L-330	130	330	3.3	3	M10	80	6xM8	104	84	1.8	32	42	50
	(1151)	(2921)	(11.28)	(6.61)									
SKX-L-500	200	500	10.7	6	M14	220	6xM10	132	104	2.5	35	58	65
	(1770)	(4425)	(36.56)	(13.23)									
SKX-L-800	350	800	10.7	6	M14	220	6xM10	132	104	2.5	42	58	65
	(3098)	(7081)	(36.56)	(13.23)									

Coupling must be selected so nominal torque is higher than highest operational torque of the application (i.e., during acceleration).
Bore diameters smaller than the minimum are possible but reliable transmission of nominal torque cannot be guaranteed.

Sold & Serviced By:

 Toll Free Phone (877) SERV098
 Toll Free Fax (877) SERV099
www.electromate.com
sales@electromate.com