

# GAM Spiral Bevel Gearboxes

Configurable

Reliable

Economical



**GAM**

Sold & Serviced By:  **ELECTROMATE**  
GAM Can. Just Ask.

Toll Free Phone (877) SERV098  
Toll Free Fax (877) SERV099  
[www.electromate.com](http://www.electromate.com)  
[sales@electromate.com](mailto:sales@electromate.com)



## GAM Spiral Bevel Gearboxes

When you need a spiral bevel gearbox that you can count on, choose GAM. Our spiral bevel gearboxes are highly configurable, reliable, and economical right angle solutions designed for use in a wide range of applications.

Precision cut spiral bevel gears are hardened and then lapped in pairs for ideal tooth contact and torque transmission, enabling 94-98% efficiencies and backlash between 10 and 30 arc-min (Reduced backlash versions available). Offered in 11 frame sizes, they can be constructed with a multitude of shaft configurations, and oriented in any direction to easily incorporate into your machine design.

1. **Housing** Sturdy cast iron housing (Aluminum in size 35mm and 45mm) - all 6 sides can be used for mounting
2. **Bearings** Deep groove ball bearings handle axial and radial loading. (Reinforced and taper roller options available)
3. **Spiral Bevel Gearing** Precision cut, hardened, and lapped in pairs for ideal tooth contact. Mathematically precise ratios from 1:1 to 6:1
4. **Input** Available with shaft input or integrated motor adapter and coupling to easily mount to any IEC, NEMA, or servo motor
5. **Output** Solid shaft with key or keyed hollow shaft are standard. (Smooth shaft or shrink disc clamping available)
6. **Seals** Lubricated for life and protected with high quality NBR seals. (Viton® and FPM seals available)

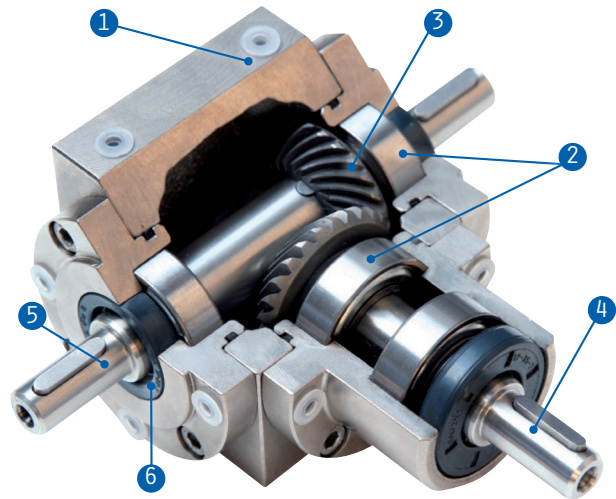

## Quality Gearboxes...Quickly!

Advanced inventory and production models allow us to ship these gearboxes quickly at a fair price, and with an ISO 9001:2000 certified quality system in place, you are assured a high quality solution.

## Special Options for Special Applications

From stainless steel shafts, electrolytic nickel coated housings, VITON® seals, to NOTOX® lubrication, GAM V-Series can be designed for use in industries that have strict requirements including pharmaceutical, medical, chemical, and food processing. For applications in explosive environments, ATEX compliant gearbox solutions can be configured.

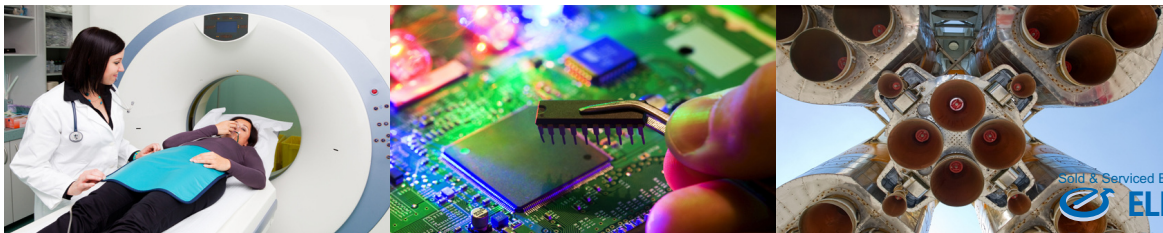

## Adaptable to Any Application

Whether you need to multiply torque, decrease / increase motor speed, or simply turn a right angle, the modular design of our spiral bevel gearboxes means that they can be configured for virtually any application.

### Shaft Input

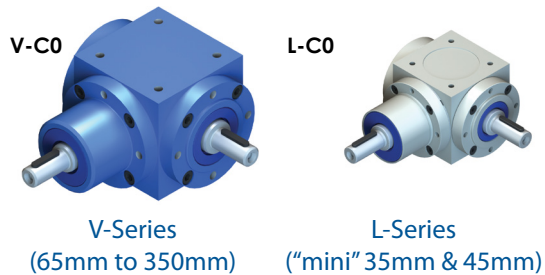

### Integrated Motor Mount Input

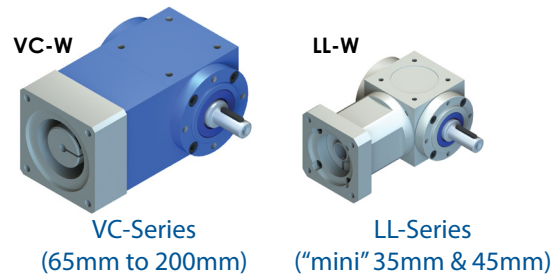

## Dependable by Design

Carefully engineered and crafted with high quality materials, our spiral bevel gearboxes are robust and can handle high shock loads. Since they are maintenance free and lubricated for life, have confidence knowing that they are built to last. Put one onto your machine and forget about it!

## When Size Matters

- Torques up to 4,440Nm (39,297 lb-in)
- Frame sizes up to 350mm (13.78")
- Power up to 267kW (360 horsepower)

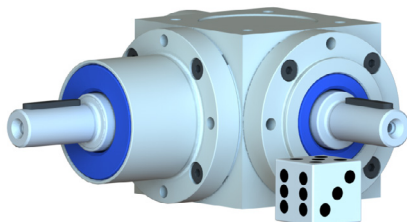
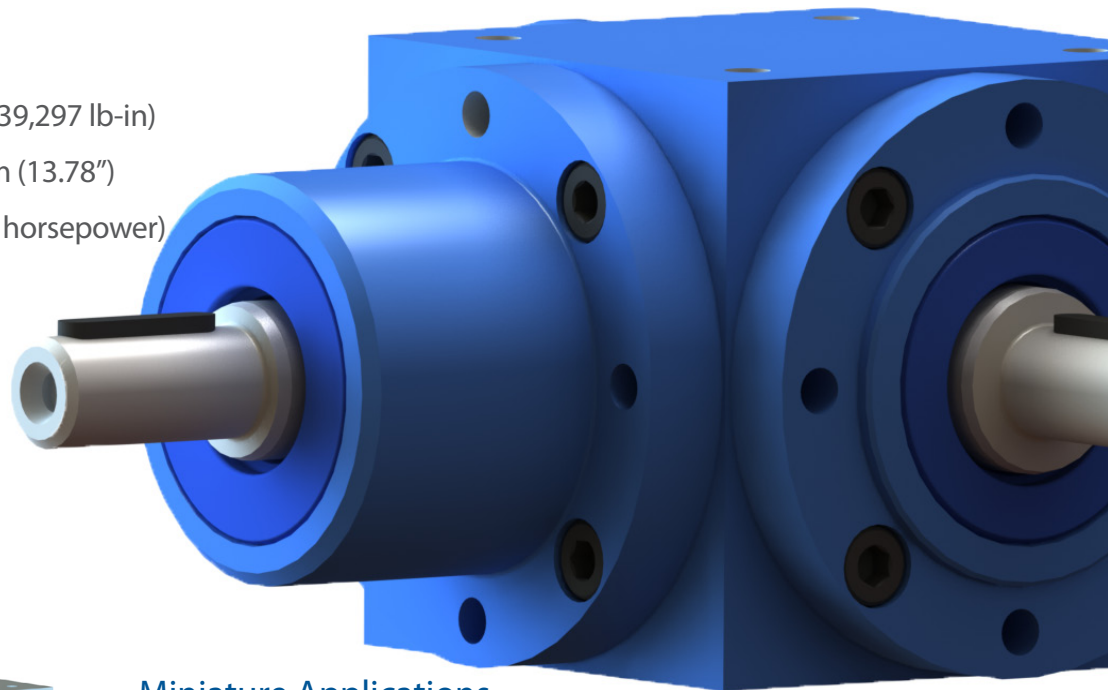

## Miniature Applications

For miniature mechatronic applications when space is a premium, our L-Series is the best option available on the market. The housings are manufactured from high-strength aluminum which means they are light weight, dissipate heat efficiently, and resist corrosion.



Toll Free Phone (877) SERV098  
Toll Free Fax (877) SERV099  
[www.electromate.com](http://www.electromate.com)  
[sales@electromate.com](mailto:sales@electromate.com)

## Solution Example - Lift System

1. V-G0 Three shafts and three bevel gears allows for the proper alignment and shaft rotation
2. VC-T Dual shaft with integrated motor mount for a compact design
3. EKZ Elastomer line shaft (distance coupling) – span distances up to 3m (10ft)

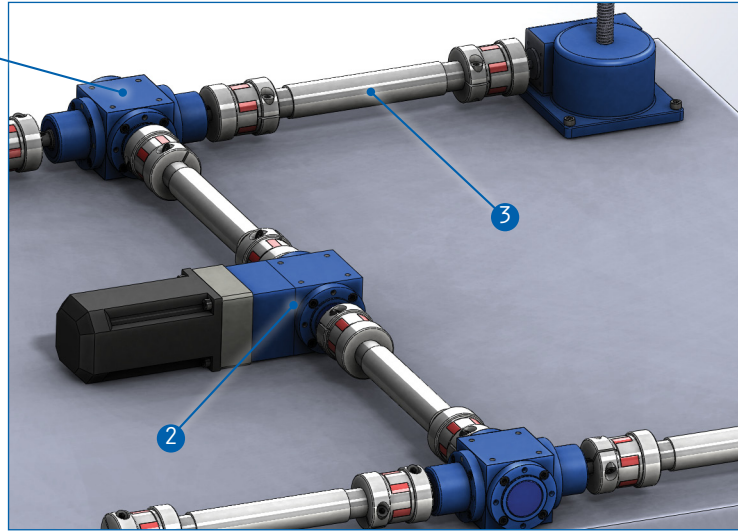

## Shaft Configurations

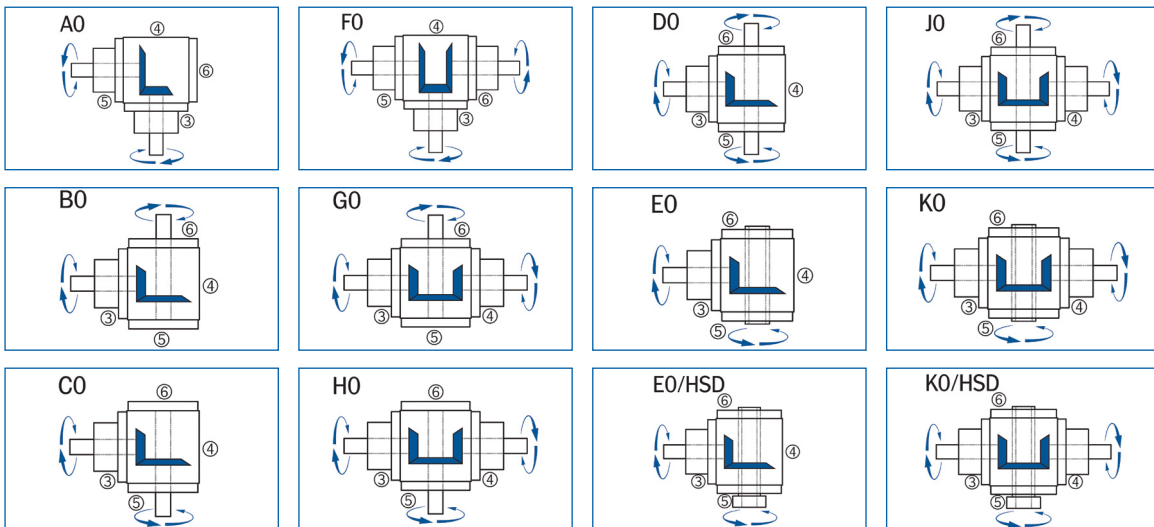

## Other GAM power transmission gearboxes available

VS – Speed Increaser

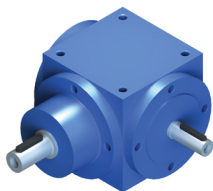

V-Multishaft

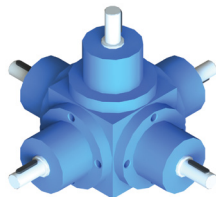

VL- IEC Flange Input

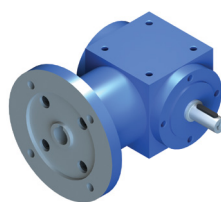

SLC - Servo Worm

