

Galil Motion Control



DMC - 500x0

Datasheet

Galil Motion Control

270 Technology Way, Rocklin, CA

1-800-377-6329

Sold & Serviced By:
 ELECTROMATE
Toll Free Phone (877) SERV098
Toll Free Fax (877) SERV099
www.electromate.com
sales@electromate.com

Product Description

The DMC-500x0 EtherCAT Controller is Galil Motion Control's newest entry in its latest generation of digital motion controllers. Incorporating all of the features of our flagship Accelera series controller and designed with compatibility and flexibility in mind, the DMC-500x0 allows integration of remote EtherCAT drives into new and existing applications with just a handful of configuration commands.

The DMC-500x0 is offered in 1 through 8 axis formats. Axes 1 - 4 can be configured as either local or EtherCAT drives while axes 5 - 8 can be configured for additional EtherCAT drives. Unique to the motion control industry, this ability to mix and match local and EtherCAT drives on the same controller provides increased flexibility for any application. In addition, the DMC-500x0 is fully compatible with Galil's internal servo and stepper motor amplifiers as well as third party external drives.

EtherCAT drives can be configured in software to close the PID control loop on the controller or on the drive. In the first mode, torque commands are sent to the motor amplifier after closing the control loop using Galil's on board PID control algorithm. This mode allows access to the Galil's standard PID control loop features, including advanced PID compensation, velocity feedforward, acceleration feedforward, integrator limits, notch filter, low pass filter and backlash compensation. In the second mode, the servo control loop is closed on the EtherCAT drive with the Galil controller sending motion profile commands at rates of up to 2.5 kHz on a 1-4 axis controller.

Standard opto-isolated inputs for each local axis include a forward limit, reverse limit and homing input. The controller also features 8 uncommitted opto-isolated inputs and 8 uncommitted opto-isolated high power outputs. The DMC-500x0 includes 8 uncommitted analog inputs, allowing the controller to interface with analog sensors such as joysticks and temperature sensors. Inputs from two separate encoders are available for each local servo axis. Local auxiliary encoder inputs are also available for axes configured for EtherCAT, providing access to Galil's dual feedback PID control loop.

One Ethernet port and two RS-232 ports are provided for communication with a host PC. Multiple EtherCAT drives can be connected in a daisy chain configuration and connected to the controller's EtherCAT port, simplifying wiring and decreasing setup time.



Features

- Configurable controller for up to 8 axes of EtherCAT Master with any of the first 4 axes for local control or EtherCAT Master
- 10/100BASE-T Ethernet port; (1) EtherCAT Port; (2) RS232 ports up to 115 kbaud
- Available with internal, multi-axis servo or stepper drives. Or, connect to conventional external drives (only first four axes)
- For local axes, accepts up to 22 million counts per second of quadrature encoder for servos; Outputs up to 6 MHz for steppers; EtherCAT command speed up to 1 billion counts per second
- Sample times as low as 375 microseconds for 1-4 axes and 750 microseconds for 5-8 axes
- First four axes, advanced PID compensation with velocity and acceleration feedforward, integration limits, notch filter and low-pass filter
- Modes of motion include jogging, point-to-point positioning, position tracking, contouring, linear and circular interpolation, electronic gearing, ECAM and PVT
- Ellipse scaling, slow-down around corners, infinite segment feed and feed rate override
- Multitasking for concurrent execution of up to eight application programs
- Non-volatile memory for application programs (4000 Lines), variables and arrays (24000)
- Dual encoders for every local servo axis
- Optically isolated home input, forward and reverse limits for every local axis. EtherCAT axes use for home and limit switches at drive.
- Uncommitted, I/O:
 - 8 optically isolated inputs and 8 optically isolated outputs
 - Isolated, high-power outputs for driving brakes or relays (local axis only)
 - 8 uncommitted analog inputs
 - High speed position latch and output compare
 - 32 additional 3.3V TTL I/O (5V option)
 - More I/O available with RIO PLC
- 2 line x 8 character LCD
- Accepts single 20 - 80 VDC input
- Communication drivers for Windows and Linux
- Custom hardware and firmware options available

| Motion Controller | |
|----------------------|---|
| Processor | RISC-based clock multiplying processor with DSP functions, Galil's 5 th generation ASIC |
| Communication | 10/100 Base-T Ethernet with Auto MDIX Main and Aux RS232 serial ports More options available see below. |
| Program memory size | 4000 lines x 80 characters |
| # of Variables | 510 |
| # of Arrays | 24000 array elements in 30 arrays |
| Position Range | 32-bit, automatic rollover |
| Maximum Velocity | 22 million counts/s |
| Maximum Acceleration | 2 billion counts/s ² |

| Power and Mechanical | |
|-------------------------|--|
| Power requirements | 20-80 V _{DC} , 12-16 W @ 25 deg C |
| Operational temperature | 0 – 70 deg C |
| Humidity | 20 – 95 % RH, non-condensing |
| Dimensions | 8.05" x 7.25" x 1.41" |



| Configurable Filter Features |
|------------------------------|
| Proportional |
| Integral |
| Derivative |
| Notch |
| Torque limit |
| Offset |
| Feed-forward acceleration |
| Dual-loop feedback mode |
| Backlash compensation |
| Profile filtering |
| Low-pass filter (Pole) |
| Feed-forward velocity |

| Modes of Motion | |
|---------------------------------------|--|
| Position Relative & Position Absolute | Absolute and relative positioning following a trapezoidal velocity profile. Phase correction and profile smoothing available. |
| Jogging | Velocity control where no final endpoint is prescribed. |
| Vector Mode | 2D motion path consisting of linear and arc segments. Motion along the path is continuous at the prescribed vector speed even at transitions between linear and circular segments. |
| Linear Interpolation | 1-8 axes of coordinated linear profiling. |
| Gearing & Gantry Mode | Electronic gearing and gantry mode with ramped gearing. |
| Electronic Camming (ECAM) | Following an arbitrary trajectory based upon a master encoder position. |
| Contour | Allows any arbitrary profile and any set of axes to be prescribed. |
| PVT | Motion path described in incremental position, velocity, and change of time. |

| General Purpose I/O | | | |
|-----------------------------------|---------------|---|---|
| | Number of I/O | Voltage | Details |
| Opto-isolated inputs ¹ | 8 | 5-24 V _{DC} | Can be configured for use as high-speed latch (position capture). |
| Opto-isolated outputs | 8 | 12-24 V _{DC} | 500mA Sourcing, can be configured as a brake output. |
| Analog Inputs | 8 | ±10, ±5, 0-5, 0-10 V | 12-bit, 16-bit optional, can be used as position feedback |
| Extended I/O | 32 | 3.3 V _{DC} , 5V _{DC} optional | I/O configurable in banks of 8 |

| Feature Specific I/O Local Axes | | |
|------------------------------------|--|--|
| | Description | Details |
| Reverse/Forward Limit Switches | 5-24 V _{DC} opto-isolated | |
| Home Input | 5-24 V _{DC} opto-isolated | |
| Amplifier Enable Output | +5, +12V _{DC} controller powered or 5-24V _{DC} opto-isolated | See ICM Modules for all AMP enable options. |
| Stepper (Step/Dir signals) | 0-5 V _{DC} Step/Dir TTL Signal | 6 MHz max output |
| Servo control (Motor command line) | ±10V analog output | 16-bit resolution |
| Quadrature Encoder Inputs | +/-12V _{DC} or TTL | 22 MHz input max See ICM Modules for all feedback options |
| Hall inputs | 3x 0-5V TTL inputs | When equipped with some AMP Modules |
| Abort | 5-24V _{DC} opto-isolated | |
| Reset | 5-24V _{DC} opto-isolated | |
| Electronic lock-out | 5-24V _{DC} opto-isolated | When equipped with AMP Modules |
| Output compare | 0-5V TTL | Also known as pulse on position |
| Error out | 0-5V TTL | |

¹ Each unused auxiliary encoder can be used as 2 additional digital inputs.

Ordering Options

The DMC-500x0 is modular by nature, meaning that a customer must specify several components in order to create a full part number. The user must specify the main control board (DMC), the communication board (CMB), and the interconnect module (ICM) to have a complete unit. The user can also specify an optional internal amplifier (AMP or SDM). How these models stack up internally is shown in Figure 1.1.

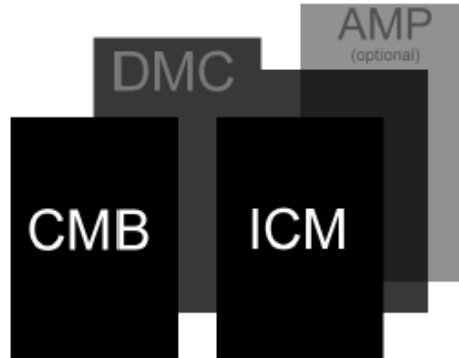

Figure 1.1: Abstract internal layout of the DMC-500x0

Each module has its own set of part numbers and configuration options that make the full part number of a DMC-500x0 unit. The DMC has the part number format "DMC-500x0(Y)," the CMB is "-C023(Y)," the ICM is "-IXXX(Y)," and the AMP/SDM is "-DXXX(Y)," where X designates different module options and Y designates different configuration options for these modules. The full DMC-500x0 part number would be the full string of individual module part numbers combined as shown in Figure 1.2.

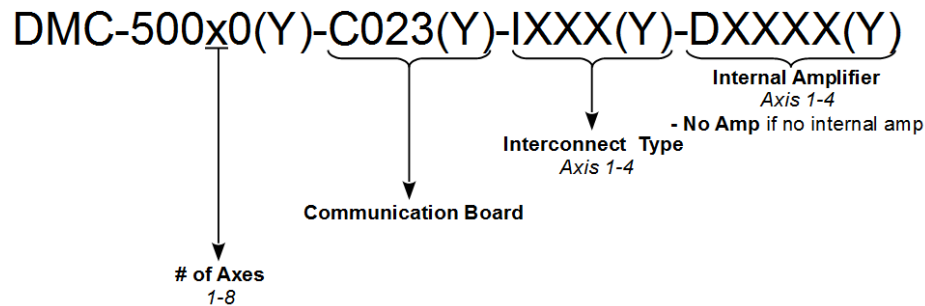

Figure 1.2: Layout of a complete DMC-500x0 part number

Use the Part Number Generator for building your DMC-500x0
<http://www.galil.com/order/part-number-generator/dmc-500x0>

| Example Part Numbers | |
|---------------------------|--|
| DMC-50060-C023-I000-D3540 | 6-axis Ethernet/EtherCAT internal/external drives C023, default: 100-BaseT Ethernet, EtherCAT, 32 Extended I/O I000, default: Axis connector with D-type connectors D3540: Four 600W servo drives w/ sine commutation |
| DMC-50040-C023-(5V)-I200 | 4-axis Ethernet/EtherCAT internal/external drives C023, default: 100BaseT Ethernet, EtherCAT, 32 Extended I/O, 5V option I200: Separate axis connector for external Amps Notes <ul style="list-style-type: none"> No internal amplifiers are selected. The default amplifier enable is 5V internally powered, high amplifier enable sinking. Amplifier enables circuits that can be specified by a Y-option in the ICM. |

DMC-500x0

DMC-500x0(Y) – C023(Y) – IXXX(Y) – DXXXX(Y)



DMC-500x0

DMC-500x0 Options

| Part Number | Description |
|-------------|--|
| DIN | DIN Rail Mount |
| 12V | Power Controller with 12 V _{DC} |
| 16bit | 16-bit analog inputs |
| 4-20mA | 4-20mA analog inputs |
| ISCNTL | Isolate Controller Power |
| TRES | Encoder terminating resistors |
| ETL | ETL certification |
| MO | Motor off jumper installed by default |

CMB Modules

DMC – 500x0(Y) – C023(Y) – IXXX(Y) – DXXXX(Y)

The CMB (communication board) provides the DMC-500x0 with a communication interface to external devices, an LCD screen for displaying default status codes or customized messages, and 32 configurable TTL I/O. The CMB-41023 has 1 Ethernet port and 1 EtherCAT port.



DMC-500x0

| Modules | Description |
|----------------------------|--------------------------------------|
| CMB-41023 (-C023, default) | 1 Ethernet port and 1 EtherCAT port |
| Options | |
| Part Number | Description |
| 5V | Configures extended I/O for 5V logic |
| P422 | RS-422 on Main and Aux serial port |
| P1422 | RS-422 on main serial port only |
| P2422 | RS-422 on auxiliary serial port |

ICM Modules

DMC – 500x0(Y) – C023(Y) – IXXX(Y) – DXXXX(Y)

ICM (interconnect modules) provide the pin-out interface from the I/O of the DMC controller to external devices. These pin-outs include signals for driving external amplifiers, limit switches, homing, opto-isolated inputs/outputs, and more.

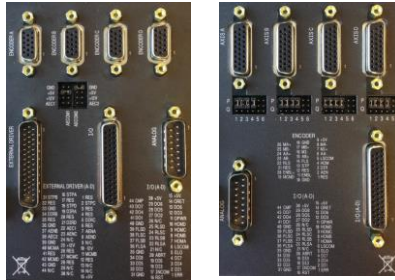

ICM-42000 (-I000) and ICM-42100 (-I100) (left). ICM-42200 (-I200) (right).

| Modules | | Description | | | |
|---|---------------------|---|-----------------------|------------------|-------------|
| ICM-42000 (-I000, default) | | Default interconnect board | | | |
| ICM-42100 (-I100) | | Same mechanical layout and pin-out as ICM-42000 (-I000). Allows additional internal hardware for Sin/Cos feedback signals. Encoder inputs are terminated with 120Ω. | | | |
| ICM-42200 (-I200) | | 26-pin encoder connector that includes external amplifier I/O. Recommended for use when interfacing with external amplifiers. | | | |
| Options | | | | | |
| Part Number | | Description | | | |
| DIFF | | Differential ±10 motor command outputs | | | |
| STEP | | Differential STEP/DIR outputs | | | |
| Amplifier Enable (local drive only) | | | | | |
| The amplifier enable part number requires one option to be specified from the following three categories: | | | | | |
| Voltage | | Logic | | Sinking/Sourcing | |
| Part Number | Description | Part Number | Description | Part Number | Description |
| 5V | +5V internal power | HAEN | High amplifier enable | Sink | Sinking |
| 12V | +12V internal power | LAEN | Low Amplifier enable | Source | Sourcing |
| 24V | 5-24V opto-isolated | | | | |

AMP Modules

DMC – 500x0(Y) – C023(Y) – IXXX(Y) – DXXXX(Y)

| | AMP-430x0 (-D30x0) | AMP-43140 (-D3140) | AMP-43240 (-D3240) | AMP-435x0 (-D35x0) | AMP-43640 (-D3640) | AMP-43740(D3740) |
|------------------------------------|-----------------------------|-------------------------|-----------------------------|-----------------------------|--------------------|-----------------------------|
| Motor type | Brushed/ 3φ Brushless servo | Brushed Servo | Brushed/ 3φ Brushless servo | Brushed/ 3φ Brushless servo | 3φ Brushless servo | Brushed/ 3φ Brushless servo |
| Amplifier Axes | 4 or 2 | 4 | 4 | 4 or 2 | 4 | 4 |
| Current Drive | PWM | Linear | PWM | PWM | Linear | PWM |
| Drive Mode | Chopper, Inverter | Linear | Chopper | Phase Shift | Linear | Phase Shift |
| Commutation | Trap w/120° halls | Brushed only | Trap w/120° halls | Sinusoidal | Sinusoidal | Sinusoidal |
| Power per axis (Watts per channel) | 500 | 20 | 750 | 600 | 20 | 1200 |
| Cont. Current (Amps) | 7 | 1 | 10 | 8 | 1 | 16 |
| Peak Current (Amps) | 10 | 1 | 20 | 15 | 2 | 30 |
| Bus Voltage (VDC) | 20 or 80 ¹ | +/- 12-30 bipolar | 20-80 ¹ | 20-80 ¹ | 15-40 | 20-80 |
| Gains (A/V) | 0.4, 0.7, 1.0 | 0.01 ² , 0.1 | 0.5, 1.0, 2.0 | 0.4, 0.8, 1.6 | 0.2 | 0.8, 1.6, 3.2 |
| Switching Freq. (kHz) | 60 or 140 ³ | – | 24 | 33 | – | 20 |
| Current loop BW (kHz) ⁴ | 8 | 10 | 3 | 4 | 8 | 2.5 |
| Min. Inductance (mH) | 0.2 - 0.5 | .05 | 0.8 | 0.5 | .05 | 1 |
| Over-Voltage | Yes | No | Yes | Yes | No | Yes |
| Under-Voltage | Yes | No | Yes | Yes | No | Yes |
| Over-Current | Yes | Fused | Yes | Yes | Fused | Yes |
| Short Circuit | Yes | Fused | Yes | Yes | Fused | Yes |
| Over-Temperature | Yes | Thermal Shutdown | Yes | Yes | Thermal Shutdown | Yes |
| ELO | Yes | Yes | Yes | Yes | Yes | Yes |
| Adjustable Current Loop | Yes | No | Yes | Yes | No | Yes |
| Shunt Option | Yes | No | Yes | Yes | Yes | Yes |
| SSR Option | No | Yes | No | No | No | No |

¹Contact Galil regarding the 160 V_{DC} option.

²Available by ordering the 100mA option.

³Contact Galil regarding the 130 kHz option.

⁴Current loop bandwidth is system dependent. These values are what can be typically expected.

⁵0.75 mH @ 24 V_{DC} bus voltage and 1.2 mH minimum @ 48 V_{DC} bus voltage

⁶0.2 mH when using chopper mode, 0.5 when using inverter mode

SDM Modules

The following embedded stepper amplifier drives are in the same black box as the DMC. Like our servo options, they are available in banks of 2 or 4-axes; note the 2-axes options take up the same space as a bank of 4-axes.

| | SDM-440x0 (-D40x0) | SDM-44140 (-D4140) |
|-----------------------|---|-----------------------|
| Motor type | Stepper | Stepper |
| Amplifier Axis | Bank of 2 or 4 axis | Bank of 4 axis |
| Microstepping | 1, $\frac{1}{2}$, $\frac{1}{4}$, $\frac{1}{16}$ | $\frac{1}{64}$ |
| Power per axis | 42 W | 180 W |
| Peak Current | 1.4 A/φ | 3.0 A/φ |
| Bus Voltage | 12-30 V _{DC} | 20-60 V _{DC} |
| Gains | 0.5, 0.75, 1.0, 1.4 | 0.5, 1.0, 2.0, 3.0 |
| Switching Freq. | 27 kHz (nominal) | 60 kHz |
| Min. Inductance | 0.5 mH | 0.5 mH |
| Over-Voltage | No | No |
| Under-Voltage | No | Yes |
| Over-Current | Yes | Yes |
| Short Circuit | Yes | Yes |
| Over-Temperature | No | No |
| ELO | Yes | Yes |
| Low Current Mode (LC) | Yes | Yes |





AMP/SDM Options

The following options can apply to both our servo and stepper (AMP/SDM) modules.



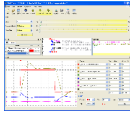
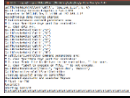
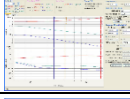
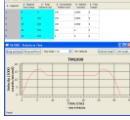







| Part Number | Description |
|--------------------|--|
| HALLF ¹ | Filtered hall sensors |
| SSR ¹ | Solid state relay |
| ISAMP | Isolates power between amplifiers (two banks of AMP/SDMs required) |

¹ Not available for all amplifier options

Accessories

| Image | Part Number | Description |
|---|-----------------------------|--|
|  | GALILSUITE SOFTWARE | Servo Tuning and Analysis with Program Editor and Terminal |
|  | GALILTOOLS SOFTWARE | GalilTools programming software for Galil controllers |
|  | EPICS SOFTWARE | Communication Drivers and Device Support to create a Galil EPICS IOC |
|  | FREQUENCY ANALYSIS SOFTWARE | Servo Tuning in Frequency Domain |
|  | GALILPVT | Galil PVT Software for PVT mode of Motion |
|  | PSR-12-24 | 12A-24 VDC Power supply |
|  | PSR-6-48 | 6A-48 VDC Power Supply |
|  | BLM-N23-50-1000-B | Nema 23 Brushless Motor with 1000-line encoder |
|  | CABLE-15-1M | 15-pin HD male D to discrete wires-1 meter |

Accessories

| Image | Part Number | Description |
|---|---------------|--|
|  | CABLE-15-2M | 15-pin HD male D to discrete wires-2 meter |
|  | CABLE-26-1M | 26-pin HD male D to discrete wires-1 meter |
|  | CABLE-44F-1M | 44-pin HD female D to discrete wires-1 meter |
|  | CABLE-44M-1M | 44-pin HD male D to discrete wires-1 meter |
|  | CABLE-9-PIN-D | RS232 female to female straight through cable |
|  | ICS-48015-M | 15-pin D HD male to screw term |
|  | ICS-48026-M | 26-pin D HD male to screw terminals |
|  | ICS-48032-F | 44-pin D HD female to screw term with opto-isolation |
|  | ICS-48044-F | 44-pin D HD female to screw term |
|  | ICS-48044-M | 44-pin D HD male to screw terminals |
|  | ICS-48115-F | 15-pin D LD female to screw term |