

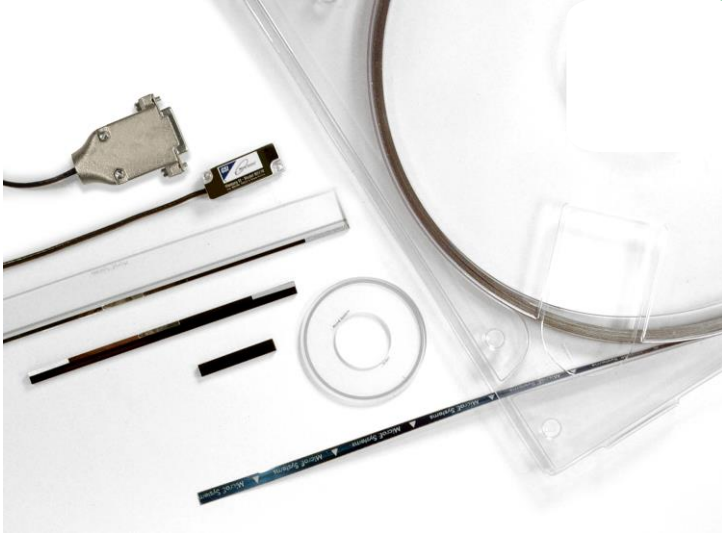

Mercury II™ 5000 Series Encoders

High Performance Encoders with Digital Output



The new Mercury II 5000 (MII5000) Series Encoders represents a breakthrough in performance, offering class-leading resolution and accuracy, digital output from the sensor, the smallest sensor size, unmatched versatility, robustness, smart programmable features, and easy installation.

RoHS
 CE

Mercury II: The Next Generation

High Resolution Digital Output/Serial Word Directly From the Sensor

MicroE Systems revolutionized encoder technology with the original Mercury™ series. Smaller, faster, and smarter than anything before, it set the standard for innovation. Now Mercury II, MicroE Systems newest series of reflective incremental encoders, takes another giant step forward by giving you “best-in-class” performance, unparalleled versatility, superior robustness, and unmatched ease of use. You get all of this from a single encoder system.

Specifications

Resolution	Linear: 5µm to 1.22nm Rotary: 20k to 268M CPR*
Linearity	Tape Scale: $\leq \pm 5\mu\text{m}/\text{m}^{**}$
Accuracy	Glass Scales: Linear: $\pm 1\mu\text{m}$ available $\pm 1.5\mu\text{m}$ to $\pm 5\mu\text{m}$ standard Rotary: Up to ± 2.1 arc-sec
Outputs	A-quad-B, Index Pulse, and Dual Limits (MII5500/5700/5800) High Speed Serial Word in SPI format (MII5800Si/Pa)
Scales	Same Sensor for Tape or Glass, Linear or Rotary

* More is possible with custom diameter grating

**Over any one meter of travel after slope correction in customer's controller

System Features at a Glance

- Mercury II 5000 Series Encoders consists of:
 - MII5500/5700/5800 - A-quad-B Outputs
 - MII5800Si/Pa (Pa - Panasonic) - High Speed Serial Interfaces
- Serial interface for Panasonic MINAS A4 and A5 series servo drives (for use with linear axes)
- High-resolution interpolated digital output directly from the sensor; resolution from 5µm to 1.2mm
- Small sensor - 11mm tall sensor fits tight spaces
- Faster - up to 5m/s at 0.1µm resolution (MII5000). Up to 10 m/s at 1.2nm resolution (MII5800Si/Pa)
- Smarter - programmable filter and other features
- Cut-to-length Marker and Laser tape scale come in dispensers up to 30m
- Linear glass scales for high accuracy
- Stick-on optical index and left/right limits
- Bi-directional optical index is repeatable to 1LSB
- Low power consumption

- Broadest alignment tolerances and pushbutton setup with LEDs
- Differential outputs for high reliability in high EMI environments
- Software for setup, programmable features, and diagnostics
- RoHS and CE compliant

Optional Features

- Tape scale length - up to 30m per dispenser
- Glass scale length or diameter: linear lengths from 10mm to 1m or custom sizes. Rotary diameters from 44mm to 121mm or custom sizes
- Sensor cable length of 1m, 3m, 5m, or custom length up to 10m
- SmartPrecision™ II Software



Mercury II™ 5000 Series Encoders

High Performance Encoders with Digital Output



System Configurations

Standard and Optional Equipment

Standard Equipment



Encoder Sensor

Same sensor for linear tape, linear glass, or rotary glass scales. All electronics, including interpolation, are in the sensor.

Sensor Cable

The standard high flex life cable is double shielded and available in lengths of 1m, 3m, 5m, or custom.

Connector

RS-422 compliant 15-pin standard D-sub connector.

SmartPrecision™ Alignment Tool for Setup - ATMII5000

- Provides fast and easy sensor alignment, index setup, and limit setup.
- Status and setup LEDs: red/yellow/green signal strength LEDs assist during setup and provide diagnostics at a glance; status LEDs for both limits; power-indicating LED.
- Includes AC/DC power supply (not shown).
- Use pushbutton or software for setup.
- Built-in SmartPrecision II Software for setup and diagnostics only a web browser is needed (use of software is optional).
- Ethernet software connectivity supports remote connection to the Alignment Tool and MII5000 Series Encoders and multiple encoders/computers.

Note: Alignment tool and software not for use in servo control.



Optional Equipment

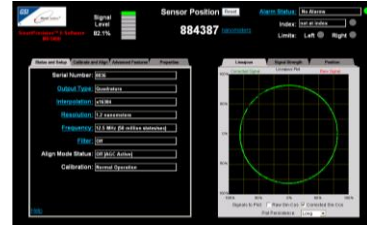

SmartPrecision II™ Software

The software performs setup and diagnostics, includes displays for encoder output, multiple data plots, and is used for programmable functions. It is built into the ATMII5000 Alignment Tool; use is optional. See Page 12 for details. Requires Ethernet cable.

Installation Accessories



Tape Scale Applicator Tool



Tape Scale Shears

Sold & Serviced By:



Toll Free Phone (877) SERV098

Toll Free Fax (877) SERV099

www.electromate.com

sales@electromate.com

System Features at a Glance

The Mercury II 5000 Series Encoder is built on the field-proven Mercury technology platform. Known for being smaller, smarter, and faster, Mercury II builds on the original Mercury series and adds increased performance, versatility, robustness, and ease-of-use.

Mercury II 5000 Series Encoder features include:

- Small, low-mass sensor with ultra-low Z-height fits in compact motion systems.
- All electronics are in the sensor for maximum space savings, system reliability and ease of integration; a variety of connector options are possible, including use of your own connector.
- Superior resolution and accuracy - resolutions up to 1.2nm (linear), 268M CPR (rotary); cyclic error of ± 20 nm typical (linear glass scales); long range accuracy up to $\pm 1\mu\text{m}$ (linear glass scales up to 130mm long).
- High-speed operation - 5m/s at 0.1 μm resolution (Quadrature Output); 10m/s at 1.2nm resolution (Serial Output).

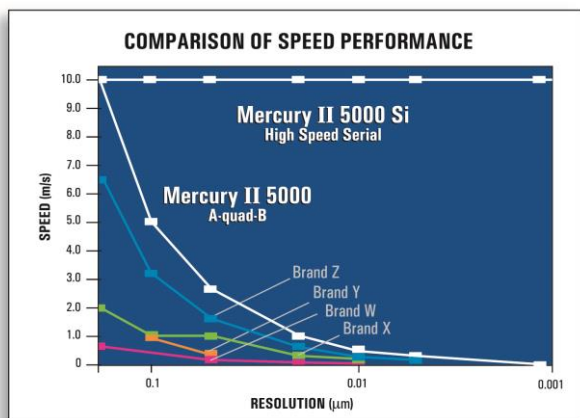
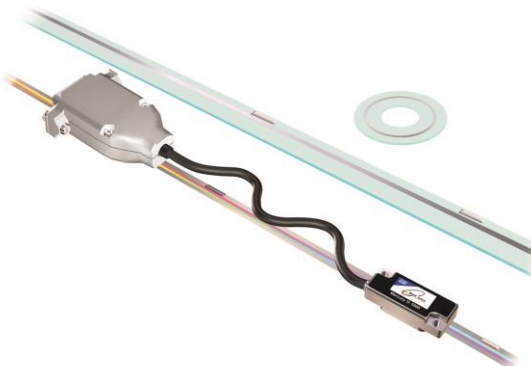

- Versatility - one sensor works with tape or glass scales, linear or rotary.
- Broad sensor alignment tolerances and the alignment tool's built-in red/yellow/green setup LEDs and pushbutton setup, make setup fast and eliminate ancillary setup instruments.

- Adhesive-mount laser tape scale supplied in continuous lengths for cut-to-length convenience and inventory savings; mounts on virtually any surface - metals, granite, glass, composites, or ceramics.
- Stick-on optical index and limit markers can be placed anywhere required, are easy to apply, and require no adjustment; markers work on both laser tape and linear glass scales.
- Convenient tape scale applicator tool ensures consistency and speedy installation.
- Low power consumption: only 180mA with A, B, I, LL, and RL outputs terminated for quad output, and only 172mA system total with all outputs terminated for serial output.
- Robustness features include all differential digital outputs, all digital signals from the sensor, and double-shielded cabling for superior EMI/RFI immunity; scale contamination resistance ensures encoder operation even with fingerprints, oil, dust and other forms of contamination.
- Fail-safe dual optical limits have differential outputs (LVTTTL) and reduce motion system cabling; limit markers fit right on the 6mm wide tape scale for maximum space savings.
- Included software makes setup and diagnostics easy; Ethernet connectivity allows you to use any computer.

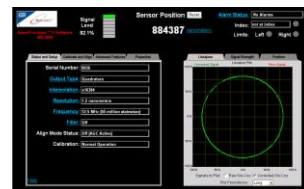

Sold & Serviced By:

 Toll Free Phone (877) SERV098
 Toll Free Fax (877) SERV099
www.electromate.com
sales@electromate.com

Mercury II™ 5000 Series Encoders



High Performance Encoders with Digital Output

Smallest Sensor, Lowest System Height, Smallest Tape Scale System, Broader Alignment Tolerances, and More

Why Mercury II Encoders make it Easier to Design High Performance into Your Equipment

Mercury II Can Reduce System Size and Cost

Mercury II 5000 Series Encoder system height with tape scale is 22% shorter than competitive encoders with digital output from the sensor, making it easier to fit into your design. This reduction can also cut motion system weight and cost by allowing the use of smaller motors and stages. Mercury II 5000 optical index and limit markers are placed within the 6mm width of the tape scale, saving even more space by eliminating external index and limit magnets

Smallest Tape Scale System

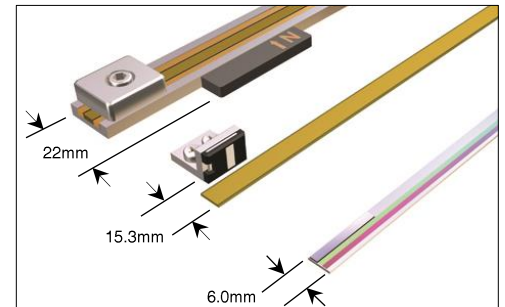

Lowest System Height

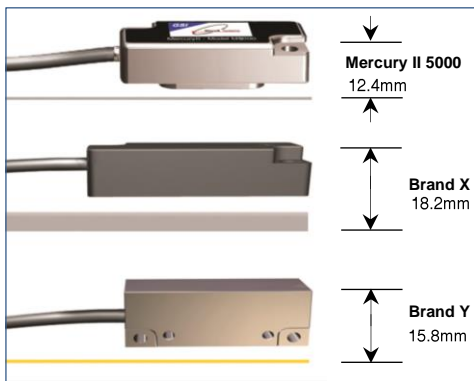

Mechanical Dimension Comparison*

	Mercury II 5000 with Tape Scale	Brand X	Brand Y	Mercury II vs. Best Competitor
System height	12.4mm	18.2mm	15.8mm	22% better
Sensor Z height	11.0mm	12mm	14.8mm	9% better
Standoff tolerance	± 0.15mm	± 0.1mm	± 0.1mm	50% better
Tape scale width**	6.0mm	22.0mm	15.3mm	155% better

*Based on published specifications for encoders with digital output from the sensor.

**Tape scale system width including index and limits.

Eliminate the Frustration of Touchy Encoder Alignment

With Mercury's patented PurePrecision™ optics, you can push the sensor against your reference surface, tighten the screws and you're finished: try that with Brand X or Y.

This performance is possible thanks to relaxed alignment tolerances, particularly in the theta Z axis. Mercury II offers a ± 2° sweet spot – that's a 300% improvement over the best competitive encoder – that will result in dramatic savings in manufacturing costs.

No other commercially available encoder is easier to align, easier to use, or easier to integrate into your designs.

Alignment Tolerance Comparison*

	Mercury II **	Brand X	Brand Y	Mercury II vs. Best Competitor
theta Z	±2.0°	±0.006°	± 0.5°	Mercury is 300% better
theta Y	±1.0°	Unspecified	± 1.0°	
theta X	±1.0°	±0.1°	± 1.0°	

*Based on published specifications for encoders with digital output from the sensor.

**Measured at a constant temperature for one axis at a time with all other axes at their ideal positions.

Theta Z Alignment Tolerance

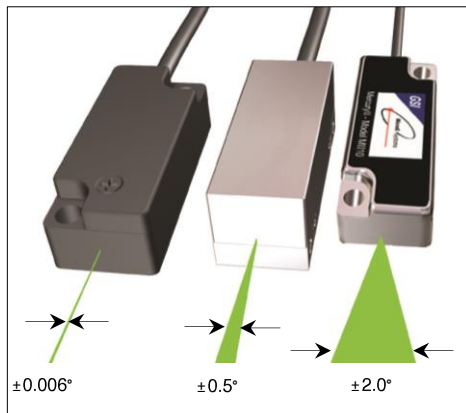

Lowest Power Consumption

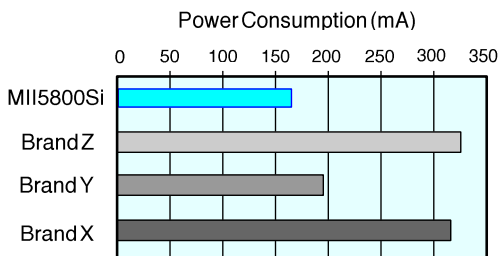

Note: All encoders shown with A, B, and I terminated. MII5800Si shown with all signals terminated.

The MII5000 Series Encoders use advanced electronics, giving MII5000s the lowest power consumption of any high-performance digital-output encoder:

- Lowest heat generation/dissipation
- Cost and size savings in the controls/drives
- More system design flexibility

Sold & Serviced By:

 Toll Free Phone (877) SERV098
 Toll Free Fax (877) SERV099
www.electromate.com
sales@electromate.com

Specifications

Resolution and Maximum Speed Tables - Quadrature Output

Mercury II 5000 systems (models 5500/5700/5800) have programmable interpolation from x4 to x16384 in integer steps. Below are tables of sample values. For applications requiring up to 10m/s at full resolution, use the MII5800Si/PA with high speed serial interface.

Linear – 20µ Grating Pitch

Maximum Interpolation	Resolution	Maximum Speed*	Applicable Mercury II Models
x 4	5.000µm/count	10000mm/sec	5500, 5700, 5800
x 10	2.000µm/count	10000mm/sec	5500, 5700, 5800
x 20	1.000µm/count	10000mm/sec	5500, 5700, 5800
x 40	0.500µm/count	10000mm/sec	5500, 5700, 5800
x 80	0.250µm/count	10000mm/sec	5500, 5700, 5800
x 100	0.200µm/count	10000mm/sec	5500, 5700, 5800
x 200	0.100µm/count	5000mm/sec	5500, 5700, 5800
x 400	0.050µm/count	2500mm/sec	5500, 5700, 5800
x 1000	20.0nm/count	1000mm/sec	5700, 5800
x 2000	10.0nm/count	500mm/sec	5700, 5800
x 4000	5.00nm/count	250mm/sec	5700, 5800
x 8000	2.50nm/count	125mm/sec	5800
x 16384	1.22nm/count†	61mm/sec	5800

Note: †Value rounded for readability; use the following formula to calculate the exact resolution in units of µm/count:

$$Resolution = \frac{20\mu}{Interpolation\ Multiplier}$$

Rotary – 20µ Grating Pitch

Interpolation Note: The range of available values is x4 to x16384 in integer steps; sample values below.

Rotary Glass Scale Diameter	Fundamental Resolution	Interpolation						
		x4	x20	x40	x400	x1000	x4000	x16384
44.45mm	5000 Lines							
	interpolated resolution (CPR)	20000	100000	200000	2000000	5000000	20000000	81920000
	interpolated resolution (arc-sec/count)**	64.8	12.96	6.48	0.648	0.259	0.0648	0.01582
	interpolated resolution (µrad/count)**	314	62.8	31.4	3.14	1.257	0.314	0.0767
	maximum speed* (RPM)	6000	6000	6000	1500	600	150	36.6
63.50mm	8192 Lines							
	interpolated resolution (CPR)	32768	163840	327680	3276800	8192000	32768000	134217728
	interpolated resolution (arc-sec/count)**	39.6	7.91	3.96	0.396	0.1582	0.0396	0.00966
	interpolated resolution (µrad/count)**	191.7	38.3	19.17	1.917	0.767	0.1917	0.0468
	maximum speed* (RPM)	3660	3660	3660	915	366	91.5	22.3
120.65mm	16384 Lines							
	interpolated resolution (CPR)	65536	327680	655360	6553600	16384000	65536000	268435456
	interpolated resolution (arc-sec/count)**	19.78	3.96	1.978	0.1978	0.0791	0.01978	0.00483
	interpolated resolution (µrad/count)**	95.9	19.17	9.59	0.959	0.383	0.0959	0.0234
	maximum speed* (RPM)	1830	1830	1830	457	183.1	45.7	11.17
Applicable Mercury II Models		5500, 5700, 5800	5500, 5700, 5800	5500, 5700, 5800	5700, 5800	5700, 5800	5800	5800

Note*: Maximum speed produces an encoder quadrature output of 50 million states per second (12.5MHz). See page 9 for additional output frequencies. Maximum speeds shown above will be reduced if a lower quadrature output frequency is selected.

Note:** Resolution values shown are approximate. To calculate exact resolution values, convert from CPR (Counts Per Revolution) to the desired units.

Note: To calculate desired rotary interpolation multiplier, use the following equation:

$$Interpolation\ Multiplier = \frac{Desired\ Resolution\ (CPR)}{Fundamental\ Scale\ Resolution\ (Lines)}$$

Note: Specifications assume XOR function which is available in all standard controllers.

Sold & Serviced By:

 Toll Free Phone (877) SERV098
 Toll Free Fax (877) SERV099
www.electromate.com
sales@electromate.com

Specifications

Resolution and Maximum Speed Tables - Serial Output

Mercury II 5800Si/Pa systems have programmable interpolation from x4 to x16384 in binary steps. Below is a table of examples. Unlike A-quadrant encoders, the MII5800Si/Pa resolution does not drop off with speed.

Linear – 20µ Grating Pitch

Interpolation Multiplier	Interpolation Bits	Resolution	Maximum Speed
x 4	2	5.000µm/count	10000mm/sec
x 8	3	2.500µm/count	10000mm/sec
x 16	4	1.250µm/count	10000mm/sec
x 32	5	0.6250µm/count	10000mm/sec
x 64	6	0.3125µm/count	10000mm/sec
x 128	7	0.15625µm/count	10000mm/sec
x 256	8	0.078125µm/count	10000mm/sec
x 512	9	0.0390625µm/count	10000mm/sec
x 1024	10	19.53125nm/count	10000mm/sec
x 2048	11	9.765625nm/count	10000mm/sec
x 4096	12	4.8828125nm/count	10000mm/sec
x 8192	13	2.44140625nm/count	10000mm/sec
x 16384	14	1.220703125nm/count	10000mm/sec

Rotary – 20µ Grating Pitch

Note: The range of available values is x4 to x16384 in binary steps; sample values below.

Rotary Glass Scale Diameter	Fundamental Resolution	Interpolation			
44.45mm	5000 Lines	x4	x1024	x4096	x16384
	interpolated resolution (CPR)	20000	5120000	20480000	81920000
	interpolated resolution (arc-sec/count)*	64.8	0.253	0.0630	0.01582
	interpolated resolution (µrad/count)*	314	1.23	0.306	0.0767
	maximum speed (RPM)	6000	6000	6000	6000
63.50mm	8192 Lines	x4	x1024	x4096	x16384
	interpolated resolution (CPR)	32768	8388608	33554432	134217728
	interpolated resolution (arc-sec/count)*	39.6	0.154	0.038	0.00966
	interpolated resolution (µrad/count)*	191.7	0.749	0.187	0.0468
	maximum speed (RPM)	3660	3660	3660	3660
120.65mm	16384 Lines	x4	x1024	x4096	x16384
	interpolated resolution (CPR)	65536	16777216	67108864	268435456
	interpolated resolution (arc-sec/count)*	19.78	0.0772	0.01978	0.00481
	interpolated resolution (µrad/count)*	95.9	0.375	0.0937	0.0234
	maximum speed (RPM)	1830	1830	1830	1830

Note*: Resolution values are approximate. To calculate exact resolution values, convert from CPR (Counts Per Revolution) to the desired units.

Note: To calculate desired rotary interpolation multiplier, use the following equation:

$$\text{Interpolation Multiplier} = \frac{\text{Desired Resolution (CPR)}}{\text{Fundamental Scale Resolution (Lines)}}$$

Sold & Serviced By:

 Toll Free Phone (877) SERV098
 Toll Free Fax (877) SERV099
 www.electromate.com
 sales@electromate.com

Mercury II™ 5000 Series Encoders



High Performance Encoders with Digital Output

Specifications

System

Scales

- PurePrecision Marker Tape or Laser Tape scales - available in continuous lengths up to 30m.
- Linear glass scales for high accuracy.
- Rotary glass scales for rotary applications.

Grating Period 20µm

Signal Period 20µm

System Resolution 5µm - 0.00122µm* in integer interpolation steps (factory set or user programmed using included SmartPrecision II Software.

*Value rounded for readability. Use the formula **20µm/interpolation multiplier** to calculate the exact resolution in units of µm/count.

Accuracy/Linearity

Cyclical Error

Tape Scales: ± 30nm typical over any 20µm movement
Glass Scales: ± 20nm typical over any 20µm movement

Tape Scale Linearity: ≤ ± 5µm/m

Glass Scale Accuracy

High Accuracy

Grade: ≤±1µm for scales up to 130mm
≤±2µm for scales from 130mm to 1m

Standard

Accuracy Grade: ≤ ±1.5µm for scales up to 130mm
≤ ±5µm for scales from 130mm to 1m

Note: Accuracy is the maximum error over the specified movement when compared to a NIST-traceable laser interferometer standard used at room temperature.

Rotary Accuracy*	Scale O.D.	Microradians	Arc-Seconds
	44.45mm	± 38	± 7.8
	63.50mm	± 19	± 3.9
	120.65mm	± 10	± 2.1

Note: *Based on ideal scale mounting concentricity.

Index: Built-in or stick-on; bi-directional, full speed. Stick-on optical marker can be placed anywhere.

Note: After power up, the index mark must be passed once at ≤ 1m/s for proper operation.

Limits: Separate built-in or stick-on left and right limits. Laser-written embedded index and limits available. Contact MicroE

Note: Sensor below shown with tape scale. Refer to the Mercury II 5000 interface drawings for additional details and important notes.

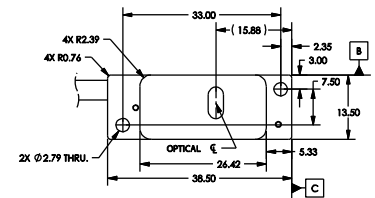
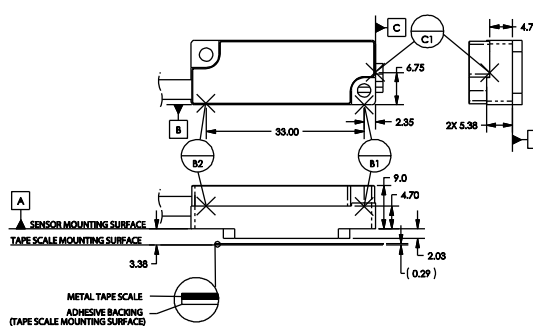
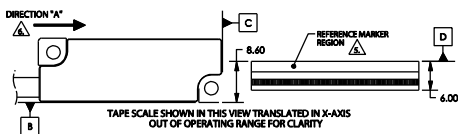

Sensor Size

H: 11.03mm

W: 13.50mm

L: 38.50mm

Operating and Electrical Specifications

Agency Standards Conformance: In accordance with Electromagnetic Compatibility Directive 2004/108/EC: EN 55011:2007, EN 61000-4-2, -3, -6

SPI Interface Clock Speed: 25MHz - 50MHz

Max Sample Rate: 227,272 position reads/s - 50MHz clock

Power Supply: 5VDC ±5%

@ 140mA (no outputs terminated)

@ 180mA (quad A, B, I, and both limits terminated)

@ 172mA (all serial I/O connections terminated)

Temperature

Operating: 0°C to 70°C

Storage: -20°C to 85°C

Humidity: 10 - 90% RH non-condensing

EMI CE Compliant

Shock: 300G 0.5 ms half sine (Sensor)

Vibration: 30G @ 17Hz

Sensor 3g (Sensor without cable)

Weight:

Cable: Double Shield

Maximum length: 10m

(contact MicroE Systems for applications >5m)

Diameter: 4.2mm

Flex Life: 20 x 10⁶ cycles @ 20mm bending radius

Reliability Information

5 Year Expected Reliability: >99.8% under normal operating conditions.

Sold & Serviced By:



Toll Free Phone (877) SERV098

Toll Free Fax (877) SERV099

www.electromate.com

sales@electromate.com

Sensor Electronics



The Mercury II 5000 Series Encoders have all electronics, including interpolation, built in to the sensor. This compact, versatile system includes the following features:

- Programmable interpolation level and output bandwidth, and low-pass filter
- Accuracy optimization - sensor signals are automatically optimized to improve system accuracy and maximize repeatability
- Bi-directional index with repeatability of 1LSB
- A-quad-B tri-state output alarm for low signal (MII5000). Alarm on output pin (and bit in serial word) for low signal (MII5800Si/Pa)
- All settings and setup parameters are stored in non-volatile memory
- Superior EMI/RFI immunity - CE compliant, and all outputs are differential and RS422 compatible

Programmable Interpolation

For the Mercury II 5000 Series Encoder, the sensor has programmable interpolation that is selectable over the range x4 to x16384 in integer steps (depending on model), providing output resolutions that can be matched to your application requirements. This feature allows reduced inventory and field spare parts costs since one electronics module can be programmed for many different resolution requirements and different motion axes. Motion system development engineers also benefit from the flexibility of programmable interpolation by allowing them to vary the encoder's resolution during motion system loop tuning and optimization. Linear resolutions can range from 5µm to 1.2nm in convenient increments and rotary resolutions from 20k CPR to 268 million CPR. Specify the interpolation value at the time of ordering or select the interpolation at your site using SmartPrecision II Software.

Programmable Maximum Output Frequency

For encoder applications combining high resolution and high speed, the sensor supports up to 50 million quadrature state changes per second.* By specifying the maximum output frequency to match your controller's capability - ranging from approximately 0.098 to 50 million quadrature state changes per second - the Mercury II encoder system will never produce encoder counts faster than your controller can read them. Specify the encoder's maximum output frequency at the time of ordering or select the setting at your site using MicroE's SmartPrecision II Software.

Note*: "Quadrature state changes per second" is the reciprocal of "dwell time" or "edge separation." For example, 50 million states per second = 0.02 µsec dwell time.

High Speed Serial Interface*

Motion system engineers who are optimizing their system can boost its performance by interfacing their SPI-compatible controller with the Mercury II 5800Si/Pa. Its industry standard SPI high-speed serial data interface is supported by multiple DSP chip manufacturers, including TI, Motorola, and Analog Devices, and provides a robust connection that is ideal for encoder interfacing. With the Mercury II 5800Si, encoder position values are sent directly into the controller's DSP. Limitations of encoders with A-quad-B output are completely eliminated. Standard features include:

- Very high motion speed with high encoder resolution - up to 10m/s movements with 1.2nm** resolution.
- 50MHz maximum input clock frequency/Sample rate of 227,272 position reads/sec with 50MHz clock.
- RS422 voltage levels are resistant to electromagnetic Interference and support long cable runs.
- Two index modes:
Mode 0: Zeros the position value at power up, without reference to the index mark. No changes are made to the position word at the index mark.
Mode 1: Zeros the position value at every encounter with the index mark.

The index mode can be factory set or selected by the customer using SmartPrecision II Software - see page 11 for software features.

Note*: Mercury II 5000 Series Encoder supports Panasonic serial interface (MII5800Pa).

Note:** Resolution values shown are approximate - see pages 5 and 6 for exact values.

Dual limits

Mercury II includes electrically fail-safe independent left and right limits with differential outputs. The limit outputs are non-latching. Optically, full reflectivity on the optical limit track is the normal operating condition; loss of signal on the optical limit track triggers a limit output, making them optically fail-safe. The output for limits is active-low, making them electrically fail-safe. Limit outputs can be configured for active-low or active-high at the time of ordering, or by the customer using SmartPrecision II Software, to match your controller's requirement.

Programmable Low Pass Filter

The Mercury II 5000 Series Encoder has a programmable low-pass input filter for enhanced performance in low speed applications. The filter can be disabled for full bandwidth or set from 0.01% - 40% of the sample rate in steps of 0.01%, where the frequency is -3dB output roll-off.

Sold & Serviced By:

Toll Free Phone (877) SERV098
Toll Free Fax (877) SERV099
www.electromate.com
sales@electromate.com

Mercury II™ 5000 Series Encoders



High Performance Encoders with Digital Output

Quadrature Inputs/Outputs

15-Pin Standard Male D-sub Connector Configuration

Pin	Function
1	Right Limit+
2	GND
3	Right Limit-
4	Index-
5	B-
6	A-
7	+5V
8	+5V
9	GND
10	Left Limit+
11	Left Limit-
12	Index+
13	B+
14	A+
15	Do Not Connect

Mechanical Information – 15-Pin Connector

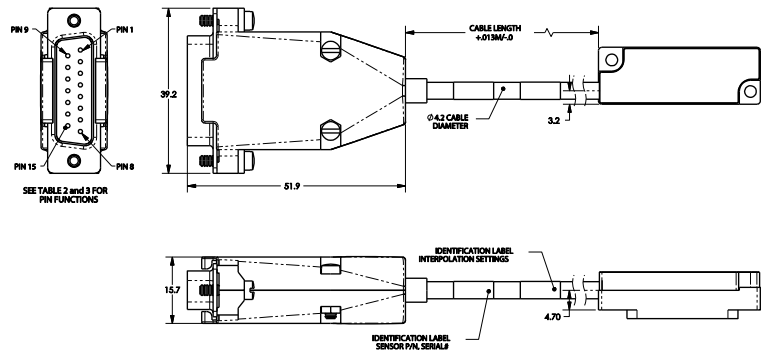

Note: Tri-state alarm: A and B are tri-stated if the encoder signal becomes too low for reliable operation.

Maximum Quadrature Output Frequency

Output Frequency (MHz)	A-Quad-B Output Rate (millions of states/sec)	Dwell Time (or edge separation) (µsec)
12.50	50.00	0.02
6.25	25.00	0.04
3.125	12.50	0.08
1.563	6.25	0.16
0.781	3.125	0.32
0.391	1.5625	0.64
0.195	0.78125	1.28
0.098	0.390625	2.56
0.049	0.1953125	5.12
0.024	0.09765625	10.24

Note: Values shown are approximate. Exact values may be calculated using either of the following equations:

$$\text{Output Frequency} = 12.5\text{MHz}/2^n$$

$$\text{Output Rate} = 50/2^n$$

where n = number of steps below 12.5MHz
 where n = number of steps below 50 million states per second

Output Signals

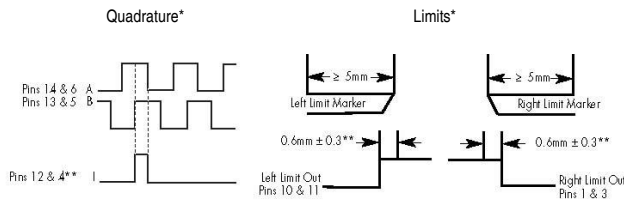

Signal Termination for A-quad-B, Index, and Limits

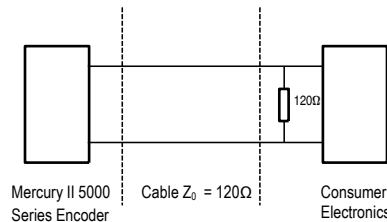

*Output signals are IEEE 422 compliant, 3.3V differential logic.
 **Note: At some interpolation values, the index pulse may be aligned with states of A or B other than the ones shown.
 ***Above are with reference to the sensor's optical centerline (see interface drawings).

Sold & Serviced By:

 Toll Free Phone (877) SERV098
 Toll Free Fax (877) SERV099
www.electromate.com
sales@electromate.com

Serial Inputs/Outputs

15-pin standard Male D-sub connector

Pin	Name	Direction	Description
1	nCS+	Input	
2	GND*		
3	nCS-	Input	Negative True Chip Select (Capture Start)
4	Reserved - do not connect		Must be floating at host
5	SCLOCK_OUT-	Output	
6	SDATA_OUT-	Output	
7	+5V*		
8	+5V*		
9	GND*		
10	SCLOCK_IN+*	Input	Serial Clock from Host to Sensor
11	SCLOCK_IN-*	Input	
12	Reserved - do not connect		Must be floating at host
13	SCLOCK_OUT+	Output	Serial Clock from Sensor to Host
14	SDATA_OUT+	Output	Serial Data from Sensor to Host
15	Do Not Connect	Output	

Note*: The following are pin outs for MII5800Pa (Panasonic): Pins 2,7,8,9 are same for both MII5800Si/Pa; Pin 10 = REQ_SD+, Pin 11 = REQ_SD-, (REQ = Request, SD = Serial Data). All other pins are NC (no connect)

Signal Termination for Serial I/O Connections

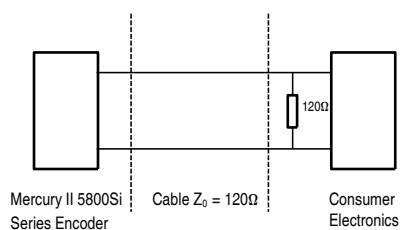

Limit Marker Positioning

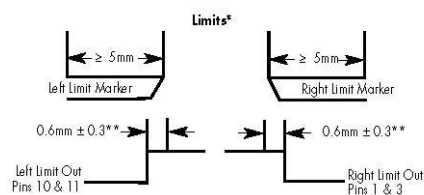

*Output signals are differential. Inverse signals are not shown for clarity.
**Above are with reference to the sensor's optical centerline (see interface drawings).

Mechanical Information – 15-Pin Connector

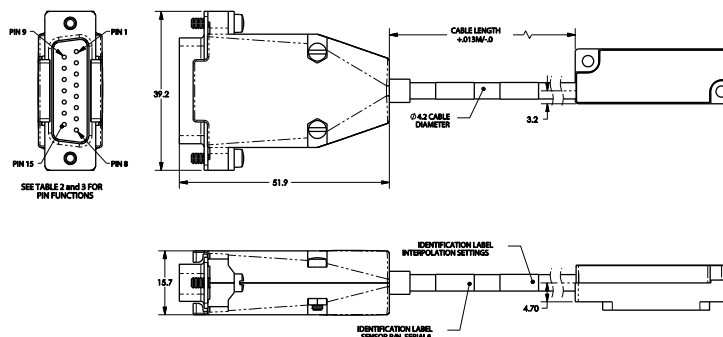

Serial Word Data Format*

The serial interface to the MII5800Si allows a serial host to receive position and status information from the sensor at up to 250,000 position reads/sec. This supports applications up to 10m/s with 1.2nm resolution in servo control, and applications where a device such as a laser or camera must be triggered from the encoder at a particular position.

Note*: For MII6800Si only. MII6800Pa: Panasonic serial interface supported.

58 Bit Data Word

Start	Position	Status	CRC	Stop
4 Bits	4 - 35 Bits	9 Bits	6 Bits	4 Bits

The data word length is up to 58 bits. The data word consists of four start bits, a position word of 4 to 35 bits (35 bits is full interpolation depth), nine bits of status, a 6-bit cyclic redundancy check (CRC) to provide data communication error detection, and four stop bits. This position word is large enough to keep track of a measurement length of 41.9 meters.

The number of position bits is determined by adding the number of interpolation bits (valid range: 2-14) and the number of fringe count bits (valid range: 2-21). Interpolation bits determine the interpolation multiplier (for example: 14 bits = x16384 interpolation; see pages 5 and 6 for tables of output resolutions). Fringe count bits determine the maximum number of 20µm fringes that can be counted in the position word (for example: 21 bits = 2097152 fringes = 41.9 meters). Most applications can use 14 interpolation bits and 21 fringe count bits. Use fewer interpolation or fringe count bits if your motion controller requires a shorter data word for faster transfer rates than can be achieved with the maximum data word of 58 bits. The number of interpolation and fringe count bits is specified at the time of ordering, but may be changed using SmartPrecision II Software.

The status bits include index window, left limit, right limit, and signal level alarms.

Important controller interfacing information such as a timing diagram, signal descriptions, and the CRC formula are in the Mercury II 5000 Installation Manual.

Sold & Serviced By:
ELECTROMATE
Toll Free Phone (877) SERV098
Toll Free Fax (877) SERV099
www.electromate.com
sales@electromate.com

SmartPrecision II™ Software

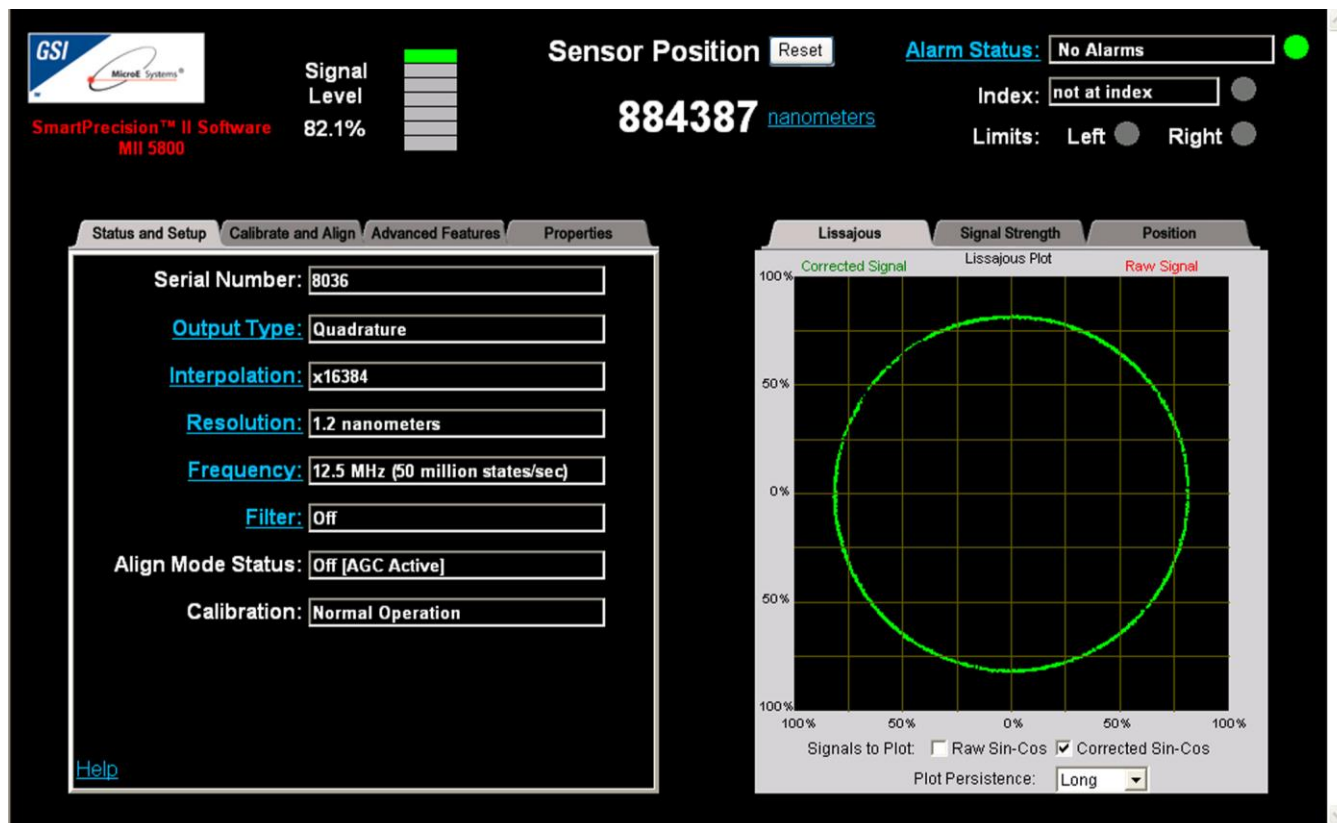

Why use software with an encoder?

Mercury II 5000 Series Encoder Alignment Tool includes built-in SmartPrecision II Software. The Alignment Tool's pushbutton setup process does not require use of the software; however SmartPrecision II Software adds unique functionality:

- Verify encoder operation using digital readouts and data plots such as Lissajous.
- Get support from trained MicroE Systems' support personnel for diagnosing customer equipment, no matter where the equipment is located throughout the world.
- Use Mercury II's programmable features for more rapid integration and motion system optimization.
- Perform encoder setup with the convenience and step-by-step prompts of a software interface.

Included with every Mercury II 5000 Series Encoder Alignment Tool, SmartPrecision II Software can perform setup and diagnostic functions locally or remotely across a LAN or WAN. It operates from the encoder using simple Java commands and thus does not require any software to be installed on the computer other than a standard web browser (such as Internet Explorer). Compatible with numerous web browsers and operating systems, its features include simultaneous displays of:

- Position in engineering units
- Lissajous plot
- Encoder signal level
- Status of software alarms, index and limits
- Status of programmable encoder settings
- Encoder serial number

Sold & Serviced By:

 Toll Free Phone (877) SERV098
 Toll Free Fax (877) SERV099
www.electromate.com
sales@electromate.com

SmartPrecision II™ Software

Program Mercury II 5000 Series Encoder Electronics

- Set interpolation in integer steps and filter roll-off frequency (quadrature output frequency) for MII5000 or in binary steps from x4 to x16,384 for MII5800Si
- Set maximum output frequency to match your controller
- Disable/enable low-pass filter and set filter roll-off frequency
- Set limit logic when necessary to match your controller's requirements
- Set grating type
- Set index mode
- Select reflective or non-reflective grating type

Install Mercury II 5000 Series Encoder

- Align sensor using Signal Level display and Lissajous data plot
- Locate index and see when sensor is over the scale's index mark
- Verify sensor output over length of scale using the Signal Strength plot
- Encoder Calibration

Verify Mercury II 5000 Series Encoder Operation

- Read encoder position in engineering units of your choice
- View data plots (software not for use while using encoder in servo control)
- Check software alarms and programmable settings

Diagnose Mercury II 5000 Series Encoder Performance

- Capture signal data and email it to MicroE for rapid diagnostic support
- Check software alarms and programmable settings

Ethernet Connectivity Features

The software resides in the ATMII5000 Alignment Tool as a 'web server' and is accessed using an Ethernet connection. The computer does not need any special software to be installed, so virtually any computer can connect instantly to an ATMII5000 Alignment Tool. Ethernet connectivity advantages include:

- High speed, network data connection supports many configurations:
 - One encoder with one computer
 - Many encoders with one computer
 - Several computers and one encoder
 - Multiple encoders and multiple computers
 - One-to-one (no network), LAN, WAN, or router
- Securely connect to the encoder remotely for field support through your company's Virtual Private Network.
- The software's web server architecture can respond to a variety of requests:
 - Html pages, data requests, Java plots, etc.
 - Take requests from most operating systems
 - Take requests from a variety of sources (user with web browser, user-software, scripts, controller, etc.)
- Program your controller to communicate with the encoder using simple HTML web commands for 'observer' position data feedback or encoder status, including calibration, alarms, and limits.
- Computer operating system independence and flexibility of interfacing to your own software without needing any DLLs, drivers, or any specific hardware or software configuration.

Computer Requirements

- Any computer with a web browser (such as Internet Explorer) and Java Runtime Environment installed and enabled
- Ethernet connection to a computer, LAN, WAN or router

How to Order

SmartPrecision II Software is included with all ATMII5000 Alignment Tools and does not require any installation - just access it using your computer's web browser.

Sold & Serviced By:

 **ELECTROMATE**

Toll Free Phone (877) SERV098

Toll Free Fax (877) SERV099

www.electromate.com

sales@electromate.com

PurePrecision™ Laser Tape Scale with Stick-On Index and Limits

The Best Tape Scale Solutions Available

Mercury II PurePrecision Marker Tape and Laser Tape scales are fast and easy to install, provide excellent accuracy and take up less space than any encoder in this class because index and limit marks are contained within the tape's 6mm width.



They mount using permanent pressure-sensitive adhesive. Thermal expansion of the substrate is matched by anchoring the ends of the tape scale using epoxy.

Marker Tape and Laser Tape scales are supplied in dispensers of lengths up to 30m so that they can be cut to any length required for your application, minimizing inventory costs. They may also be ordered pre-cut to any length you specify for high-volume OEM applications.



Installation for a wide range of

lengths is fast and easy using MicroE Systems' tape applicator tool, or without a tool by hand. When using the installation tool, released paper is automatically removed from the tape. The tape's location on the mounting surface is set by a reference edge that is either machined into the substrate or is put in place temporarily.



PurePrecision Marker Tape

PurePrecision Marker Tape has built-in index and limit marks to speed installation. Manufactured into the tape scale to your

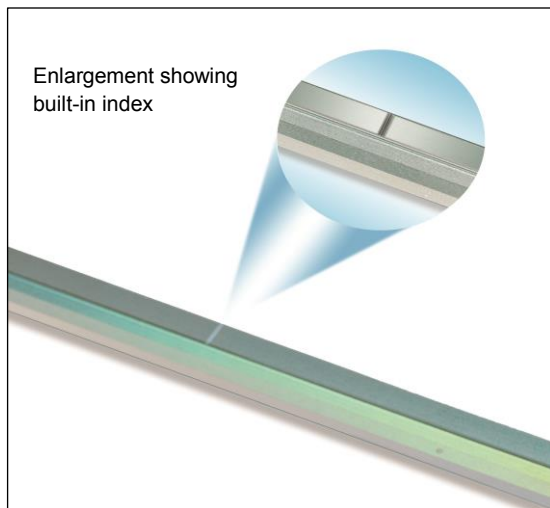

Enlargement showing built-in index

specifications using a laser etch process, installation of the tape scale is reduced to one simple step: just apply the adhesive-mount tape scale to your system's mounting surface and you are done. There is no need to mount index or limit markers or magnets. The laser-written marks are placed in the exact locations you specify – index location, number of index marks, and limit mark lengths can be specified at the time of ordering. PurePrecision Marker Tape may be ordered in pre-cut lengths for the fastest installation, or in continuous form for cutting at your site.

PurePrecision Laser Tape with Stick-On Index and Limits

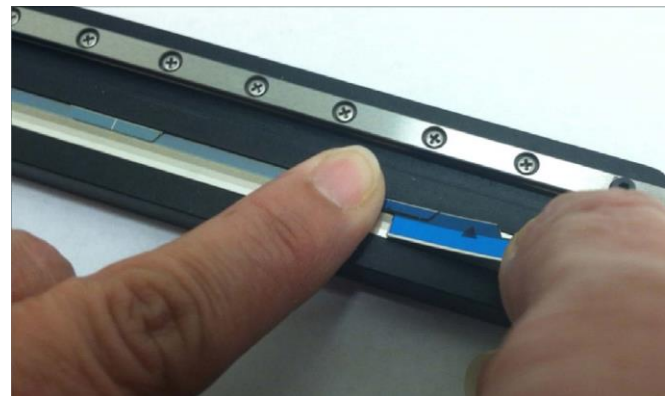

PurePrecision Laser Tape has the same high performance Inconel scale as PurePrecision Marker Tape, but without the factory written index/limit markers. Laser Tape provides the ultimate in flexibility and productivity by using stick-on index and limit markers so that you can cut the tape scale to any length you need.

The stick-on (adhesive-mount) optical index and limit markers are mounted on the tape in seconds using the same reference edge as for the tape scale. This space-saving design keeps the index and limit markers within the 6mm width of the tape, ideal for space-constrained motion systems. The index is bi-directional, operates at all encoder speeds, and is repeatable to 1LSB.

Mercury II PurePrecision Marker and Laser Tape scale may also be installed using scale applicator tools for 6mm-wide tape from other manufacturers.

Sold & Serviced By:

Toll Free Phone (877) SERV098
Toll Free Fax (877) SERV099
www.electromate.com
sales@electromate.com

PurePrecision™ Laser Tape Scale with Stick-On Index and Limits

The laser scale length that you specify for your application must be calculated as follows. This calculation applies whether your application requires end limits or not. 20mm at each end of the tape scale are not to be used for encoder feedback.

Tape Scale Length = Measuring Length + 40mm*

For Example: Measuring Length of 800mm is required, and limits will be used at the end of the tape scale. The Tape Scale Length = 800mm + 40mm = 840mm.

*When the end limits are at the ends of the tape scale and end caps are not used. The Tape Scale Length must be increased further if the limit markers are applied at a distance from the ends of the tape scale.

Index and Limit Marker Locations When End Caps not used

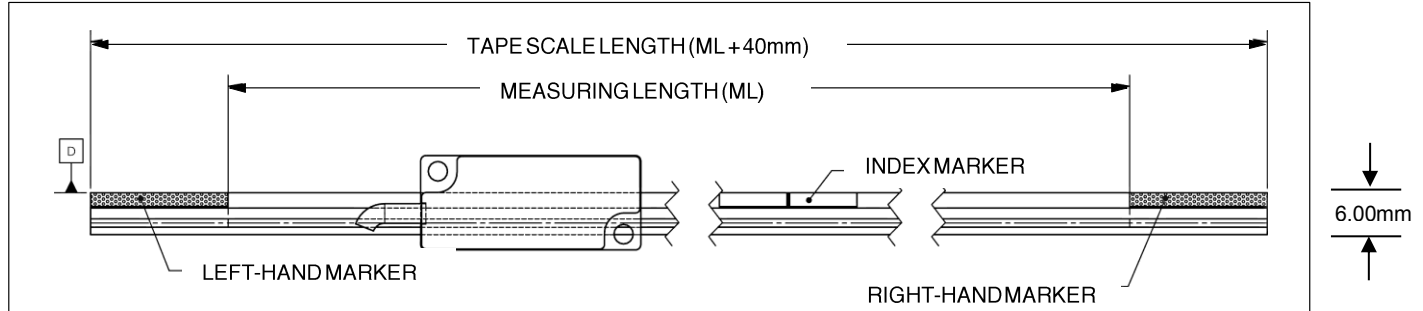

D = Mounting Surface Reference

Specifications

Linearity	≤ ±5µm/m
Material	Inconel 625
Typical CTE	13ppm/°C; thermal behavior of the tape scale is typically matched to the substrate using epoxy at the ends of the tape scale

Available Lengths

Order as much tape scale as you will require for your production and cut it to length for each job, or order pre-cut lengths to match your application requirements. Note that the Measuring Length for each axis in your equipment will be less than the Tape Scale Length depending on limits and use of end caps. PurePrecision laser tape is shipped in tubes for lengths from 40mm – 500mm and in dispensers for lengths greater than 500mm.

Order the required Tape Scale Length using the model number TS-xxxx (where xxxx=Tape Scale Length in mm [40 – 30000mm]).

For example, 9000mm Tape Scale: .TS-09000. Contact MicroE Systems for lengths greater than 30m.

Sold & Serviced By:

 Toll Free Phone (877) SERV098
 Toll Free Fax (877) SERV099
www.electromate.com
sales@electromate.com

Linear and Rotary Glass Scales

MicroE Systems offers a wide array of chrome on glass scales. Easy to install, choose from standard linear and rotary scales, or customized linear, rotary, and rotary segment scales where needed. Use linear glass scales for the highest accuracy.

Glass Scale Options

- Standard linear: 10mm - 1m (contact MicroE for longer lengths)
- Standard rotary: 44mm - 121mm diameter, with or without hubs
- Custom linear*: special lengths, widths, thickness, index mark locations, pre-printed index and limits, and special low CTE materials
- Custom rotary*: special IDs, ODs (up to 304.8mm), index mark inside the main track, and special low CTE materials
- Mounting of hubs for rotary scales: MicroE Systems can mount and align standard, custom, or customer-supplied hubs
- Rotary segments*: any angle range; wide range of radius values

Note*: Custom scales or rotary segments are available in OEM quantities. Contact your local MicroE Systems sales office.

Mercury II linear glass scales 130mm or shorter are only 6mm wide, enabling drop-in replacement of existing 6mm wide tape scale encoders for dramatic improvements in motion system resolution and accuracy

Standard Short Linear Scales

130mm and Shorter (dimensions in mm)

Specifications

Accuracy	±1.5µm standard accuracy grade ±1µm available (high accuracy grade)
Material	Soda lime glass
Typical CTE	8ppm/°C (Ultra-low CTE glass available)

Linear Glass Scales

The stick-on (adhesive-mount) optical index and limit markers are mounted on the scale in seconds usually using the same reference edge as for the scale or a metal block. This space-saving design keeps the index and limit markers within the 6mm width of the scale, ideal for space-constrained motion systems. The index is bi-directional, operates at all encoder speeds, and is repeatable to 1LSB (embedded index only).

The scale length that you specify for your application must be calculated as follows:

If your application requires end limits

$$\text{Glass Scale Length} = \text{Measuring Length} + 40\text{mm}^*$$

Example: A Measuring Length of 90mm is required, and limits will be used. Scale Length = 90mm + 40mm = 130mm.

*When the end limits are at the ends of the tape scale

If your application does not require end limits

$$\text{Glass Scale Length} = \text{Measuring Length} + 5\text{mm}$$

Example: A Measuring Length of 25mm is required, and limits will not be used. Scale Length = 25mm + 5mm = 30mm.

Factory cut-to-length flexibility

Mercury II's stick-on index and limit markers make factory cut-to-length glass scales possible, enabling rapid turnaround for any scale length and helping you exactly match your application requirements. For OEM applications, linear glass scales can be ordered with pre-printed index and limit markers that are optimized for your needs, speeding installation and maximizing motion system performance.

Order the required Scale Length using model number MIILxxxx where xxxx = Scale length in mm (10mm - 1000mm). For example: (30mm Linear Glass Scale): MIIL30.

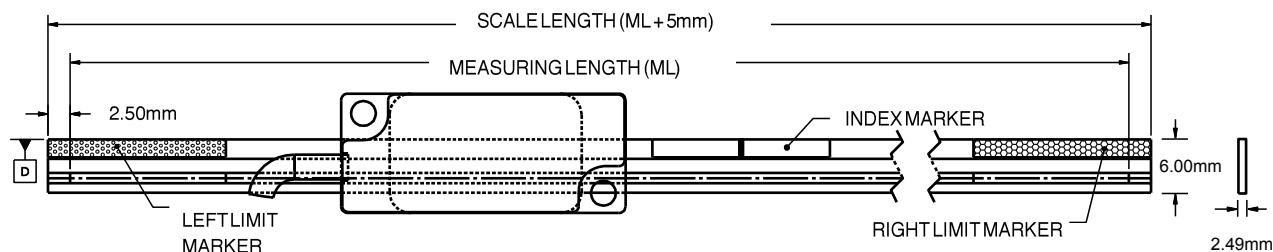

D = Mounting Surface Reference Edge

Note: The following are only examples; you can order any size. Longer scales available; contact MicroE.

Model	MIIL18	MIIL30	MIIL55	MIIL80	MIIL105	MIIL130
Scale Length	18mm	30mm	55mm	80mm	105mm	130mm
Measuring Length Without Limits	13mm	25mm	50mm	75mm	100mm	125mm
Measuring Length With Limits	N/A	N/A	15mm	40mm	65mm	90mm

Linear Glass Scales with Stick-on Index and Limits

Standard Long Linear Scales

131mm and Longer (dimensions in mm)

Specifications

Accuracy	±5µm standard accuracy grade ±2µm available (high accuracy grade)
Material	Soda lime glass
Typical CTE	8ppm/°C (Ultra-low CTE glass available)

Order the required Scale Length using model number MIILxxxx where xxxx = Scale length in mm (10mm - 1000mm).

For example: (225mm Linear Glass Scale): MIIL225. Contact MicroE Systems for lengths greater than 1m.

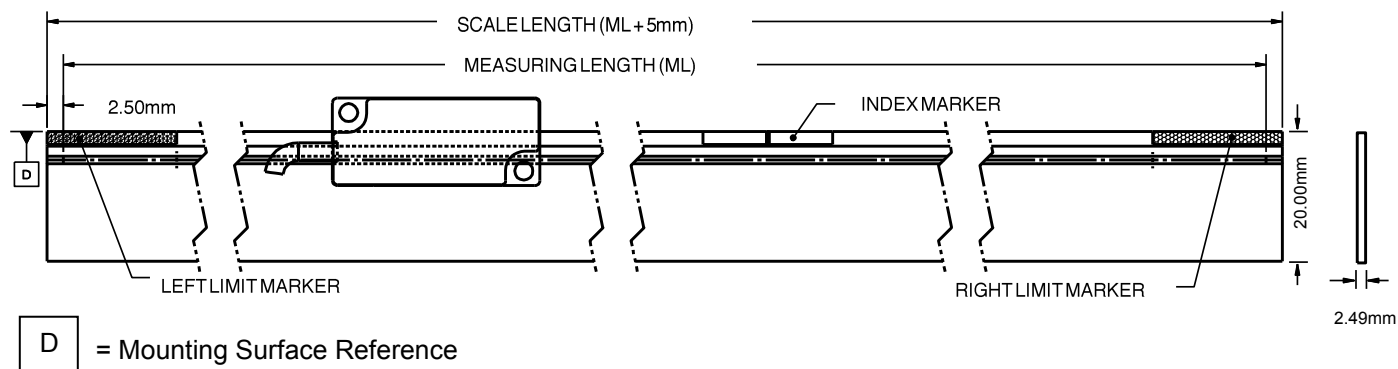

Note: The following are only examples; you can order any size.

Model	MIIL155	MIIL225	MIIL325	MIIL425	MIIL525	MIIL1000
Scale Length	155mm	225mm	325mm	425mm	525mm	1000mm
Measuring Length Without Limits	150mm	220mm	420mm	420mm	520mm	995mm
Measuring Length With Limits	115mm	185mm	285mm	385mm	485mm	960mm

Rotary Glass Scales with Built-In Index

Standard Rotary Scales

Specifications

Material	Soda lime glass
Typical CTE	8ppm/°C

Dimensions in MM

Custom scales are available including larger diameters.

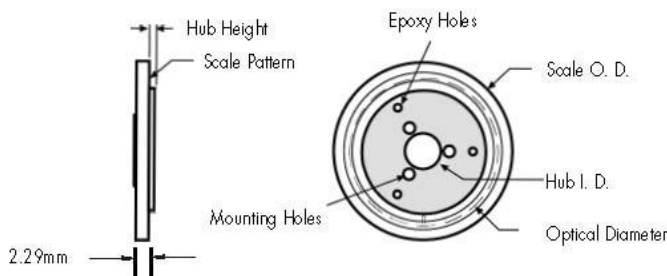

Model No.	Fundamental CPR	Scale Outer Diameter	Scale Inner Diameter	Optical Diameter	Hub Inner Diameter +0.013mm/-0.0000	Hub Height
MIIR4513	500	44.45mm	12.70mm	31.83mm	6.358mm	1.27mm
MIIR6425	8192	63.50mm	25.40mm	52.15mm	12.708mm	1.52mm
MIIR12121	16384	120.65mm	50.80mm	104.30mm	25.408mm	2.03mm

Note: MIIL5800Pa is for linear axes only.

How to Order

Sensors

MII5800, A-quad-B Output, with Resolution from 5µm to 1.2nm

MII5810-AB-16384-1-1-0 (example)

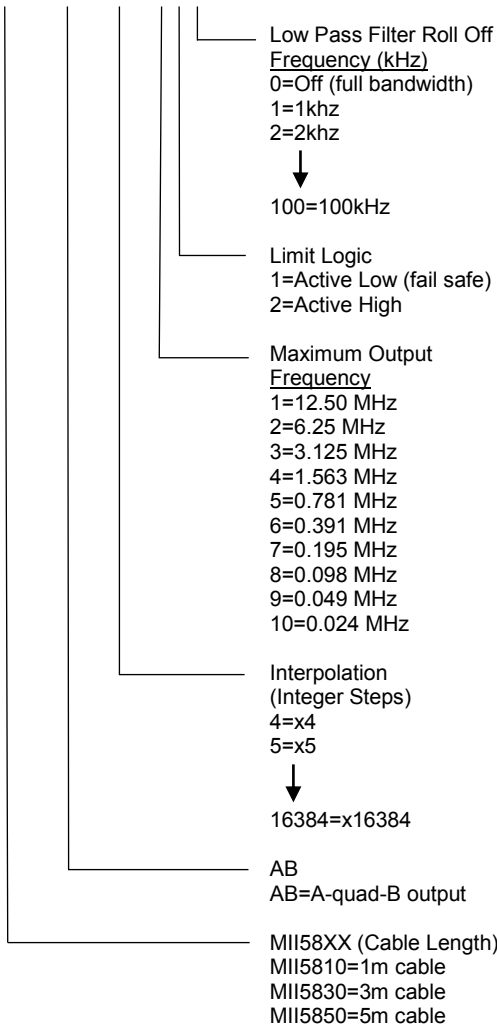

MII5700, A-quad-B Output, with Resolution from 5µm to 5nm

MII5710-AB-4000-1-1-0 (example)

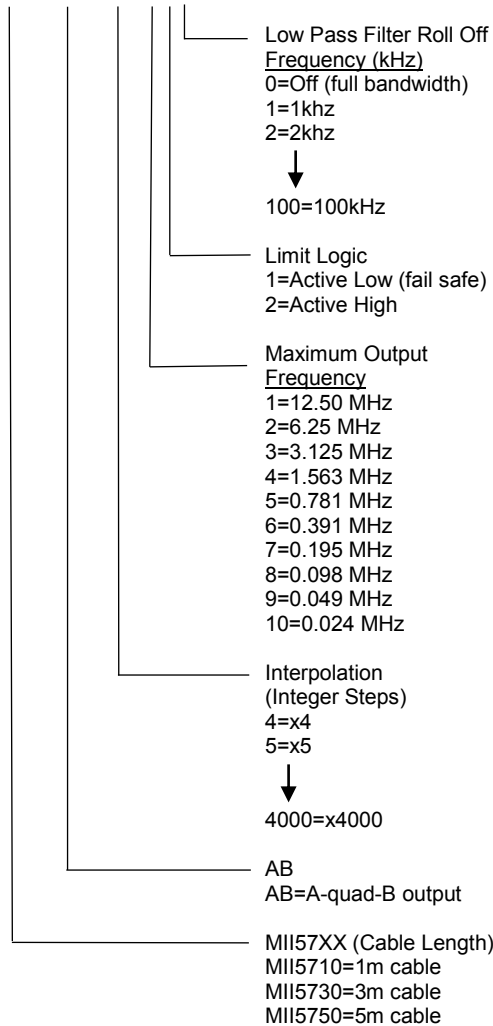

Note: All specifications are subject to change.

Sold & Serviced By:

 Toll Free Phone (877) SERV098
 Toll Free Fax (877) SERV099
www.electromate.com
sales@electromate.com

How to Order

Sensors

MII5500, A-quad-B Output, with Resolution from 5µm to 50nm

MII5510-AB-400-1-1-0 (example)

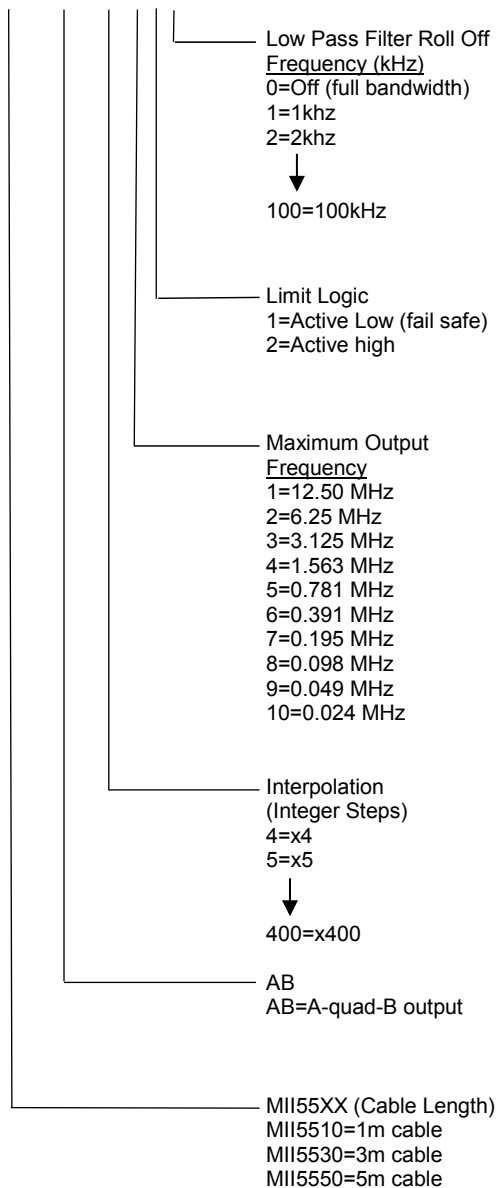

MII5800Si, Serial Output, with Output Resolution up to 1.2nm

MII5810-Si-14-21-1-0 (example)

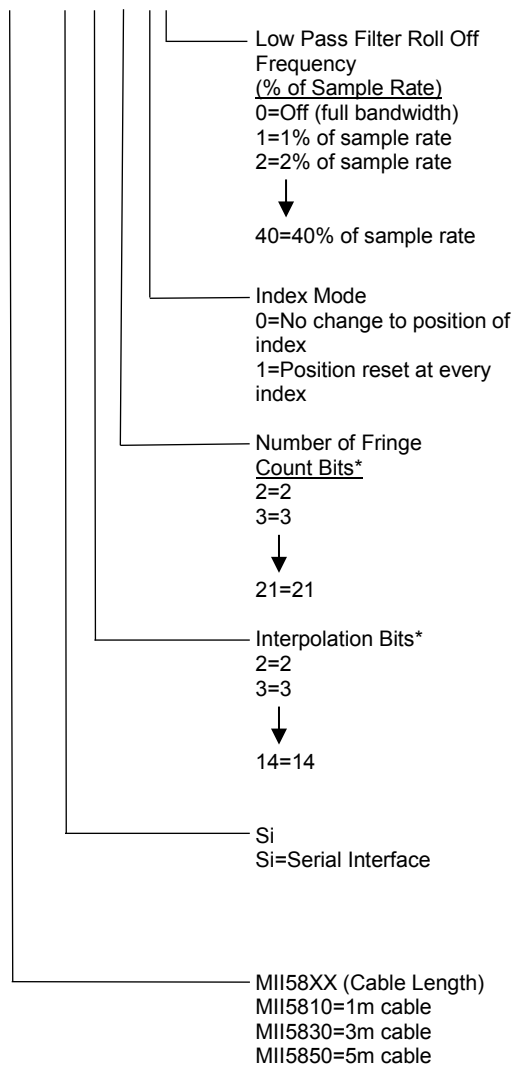

Note*: Interpolation bits plus fringe bits must be ≤35 bits.

Note: All specifications are subject to change.

Sold & Serviced By:

 Toll Free Phone (877) SERV098
 Toll Free Fax (877) SERV099
www.electromate.com
sales@electromate.com

How to Order

Sensors

MII5800Pa, Serial Output, with Output Resolution up to 1.2nm

MII5810-Pa-14-10-1-0 (example)

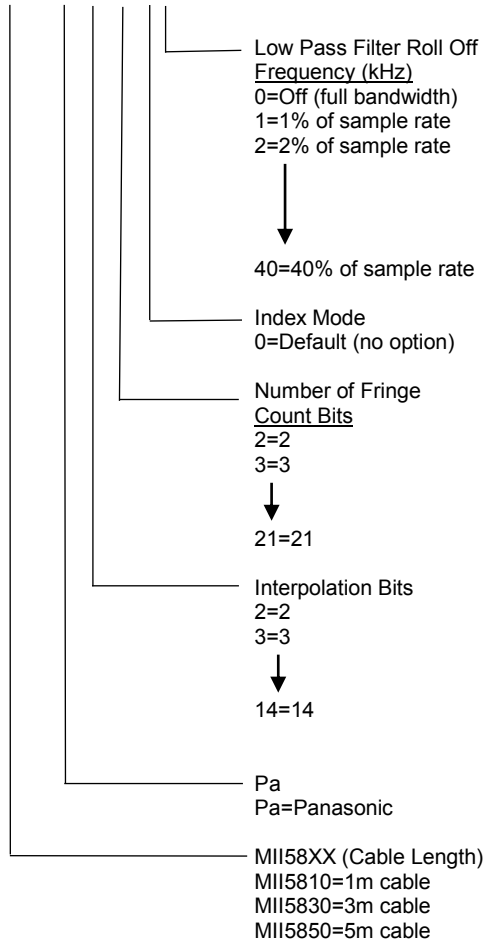

Note: Interpolation bits plus fringe bits must be ≤ 24 bits.
Note: All specifications are subject to change.

Sensor Installation Tools

- ATMII5000** *Alignment Tool Kit for MII5000 encoders includes:
- Alignment Tool
- SmartPrecision II Software
- USB Cable
- Power Supply (100V- 240VAC/50-60Hz)
- US** US=Power supply with US standard 2-prong plug
- EU** EU=Power supply with European standard 2-prong plug
- ZG-PP2** Z-Height Gauge, PurePrecision Tape Scales
- ZG-GS2** Z-Height Gauge, Glass Scales

Note*: Required for MII5000/MII6000 setup.

Adapter for Open Collector Limit Outputs

- MIIA-OCL** Small DB15 adaptor to convert 3.3V left and right limit output signals to open collector type (7407)

End Cap Kit, PurePrecision Tape Scales

- EC** Optional Tape Scale End Caps

Tape Scale Applicator Tools (use for lengths > 300mm)

- TSAT-PPT** Tape Applicator Tool for applying tape scale

Sold & Serviced By:



Toll Free Phone (877) SERV098
Toll Free Fax (877) SERV099
www.electromate.com
sales@electromate.com

How to Order

Scales

PurePrecision Marker Tape II

MT-N-A-L-9999-I

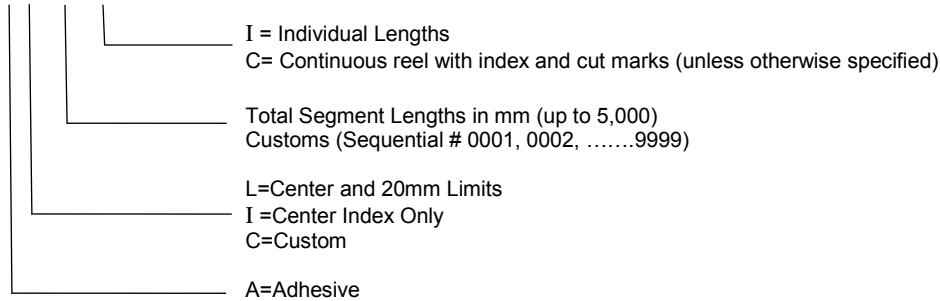

PurePrecision Laser Tape II

TS-3000

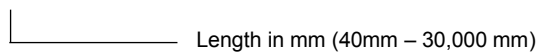

PurePrecision Linear Glass Scales

(Standard accuracy grade)

MIIL-100

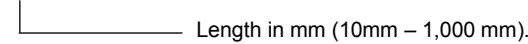

For high accuracy grade scales, contact MicroE.

Note: Index and limit markers must be ordered separately.

Stick-On Index and Limit Markers (for Laser Tape II and Performance and Value Linear Glass Scales)

RIMS Qty of 8 Stick-On Index Markers
RLMS Qty of 4 Stick-On Left Limit Markers and Qty of 4 Stick-On Right Limit Markers

Note: To use RIMS/RLMS, MII5000 must be configured for Reflective Grating Type.

PurePrecision Rotary Glass Scales

MIIRxxxx* - Hub



Note*: Custom Versions are available.

Note: Rotary glass scales are shipped not mounted to hub. Hub mounting is available, contact MicroE Systems for information.

Note: All specifications are subject to change.

Sold & Serviced By:



Toll Free Phone (877) SERV098
Toll Free Fax (877) SERV099
www.electromate.com
sales@electromate.com

Mercury II Encoders are Fully RoHS Compliant

Mercury II is fully compliant with European Directive 2002/95/EC (Restriction of use of Hazardous Substances, "RoHS").

A Document of Compliance is available upon request. "Mercury™" is a brand name of MicroE Systems; Mercury and

Mercury II encoders do not contain any mercury metal.

Vacuum-Rates and Small Diameter Rotary Encoders

Vacuum-Rated and Small Diameter Rotary Encoders

See <http://www.celeramotion.com> for Mercury linear and rotary encoders that are vacuum rated up to 10^{-8} torr, small-diameter rotary encoders with scale outside diameters from 32mm to 12mm, and low-cost PCB mount encoders.

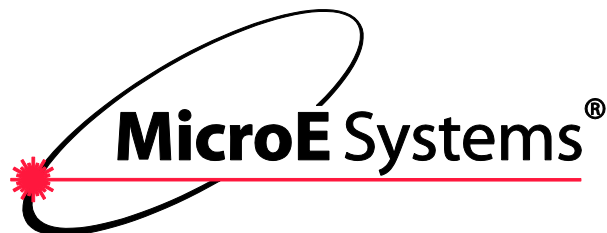

Sold & Serviced By:

 **ELECTROMATE**

Toll Free Phone (877) SERV098

Toll Free Fax (877) SERV099

www.electromate.com

sales@electromate.com