

Description

The DigiFlex® Performance™ (DP) Series digital servo drives are designed to drive brushed and brushless servomotors. These fully digital drives operate in torque, velocity, or position mode and employ Space Vector Modulation (SVM), which results in higher bus voltage utilization and reduced heat dissipation compared to traditional PWM. The drive can be configured for a variety of external command signals. Commands can also be configured using the drive's built-in Motion Engine, an internal motion controller used with distributed motion applications. In addition to motor control, these drives feature dedicated and programmable digital and analog inputs and outputs to enhance interfacing with external controllers and devices.

This DP Series drive features a CANopen interface for networking and a RS-232 interface for drive configuration and setup. Drive commissioning is accomplished using DriveWare® 7, available for download at www.a-m-c.com.

All drive and motor parameters are stored in non-volatile memory. The DPC Series Hardware Installation Manual is available for download at www.a-m-c.com.

Power Range

Peak Current	100 A (70.7 A _{RMS})
Continuous Current	60 A (60 A _{RMS})
Supply Voltage	20 - 80 VDC



Features

- ▲ Follows the CAN in Automation (CiA) 301 Communications Profile and 402 Device Profile
- ▲ Four Quadrant Regenerative Operation
- ▲ Space Vector Modulation (SVM) Technology
- ▲ Fully Digital State-of-the-art Design
- ▲ Programmable Gain Settings
- ▲ Fully Configurable Current, Voltage, Velocity and Position Limits
- ▲ PIDF Velocity Loop
- ▲ PID + FF Position Loop
- ▲ Compact Size, High Power Density
- ▲ 16-bit Analog to Digital Hardware
- ▲ On-the-Fly Mode Switching
- ▲ On-the-Fly Gain Set Switching
- ▲ Dedicated Safe Torque Off (STO) Inputs

MODES OF OPERATION

- Profile Current
- Profile Velocity
- Profile Position
- Interpolated Position Mode (PVT)

COMMAND SOURCE

- ±10 V Analog
- PWM and Direction
- Encoder Following
- Over the Network
- Sequencing
- Indexing
- Jogging

FEEDBACK SUPPORTED

- ±10 VDC Position
- Auxiliary Incremental Encoder
- EnDat® 2.1/2.2
- Hiperface®
- 1Vp-p Sine/Cosine Encoder
- Tachometer (±10 VDC)
-

INPUTS/OUTPUTS

- 3 High Speed Captures
- 4 Programmable Analog Inputs (16-bit/12-bit Resolution)
- 1 Programmable Analog Output (10-bit Resolution)
- 3 Programmable Digital Inputs (Differential)
- 7 Programmable Digital Inputs (Single-Ended)
- 4 Programmable Digital Outputs (Single-Ended)

COMPLIANCES & AGENCY APPROVALS

- RoHS II
- TÜV Rheinland® (STO)
- UL/cUL Pending
- CE Pending

Sold & Serviced By:



Toll Free Phone (877) SERV098
 Toll Free Fax (877) SERV099
www.electromate.com
sales@electromate.com

BLOCK DIAGRAM

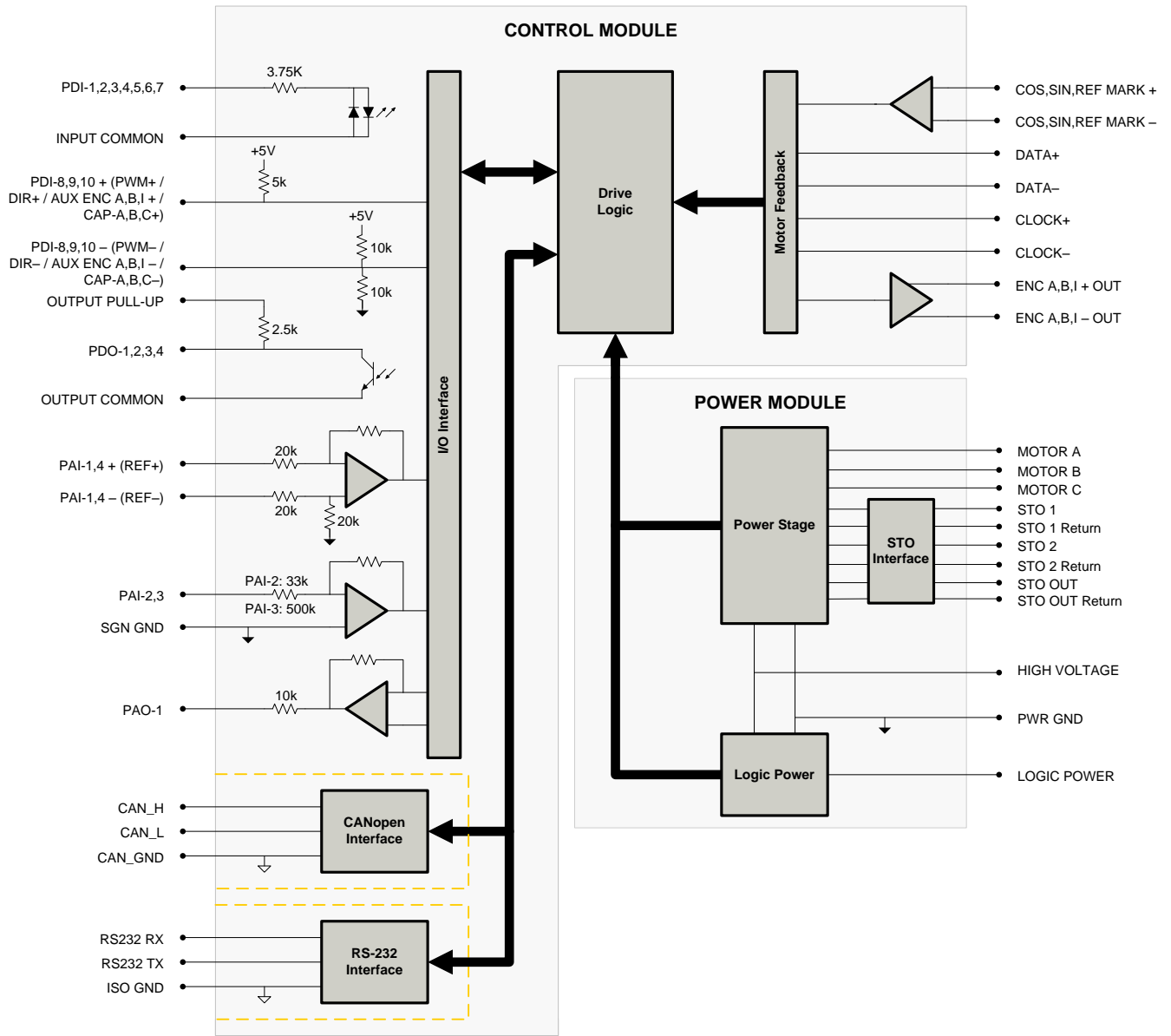

Information on Approvals and Compliances



The RoHS II Directive 2011/65/EU restricts the use of certain substances including lead, mercury, cadmium, hexavalent chromium and halogenated flame retardants PBB and PBDE in electronic equipment.



Functional Safety STO is TÜV Rheinland® certified and meets requirements of the following standards:

- EN ISO 13849-1 Category 4 / PL e
- EN IEC 61800-5-2 STO (SIL 3)
- EN62061 SIL CL3
- IEC 61508 SIL 3

Sold & Serviced By:



SPECIFICATIONS

Power Specifications		
Description	Units	Value
DC Supply Voltage Range	VDC	20 – 80
DC Bus Over Voltage Limit	VDC	88
DC Bus Under Voltage Limit	VDC	17
Logic Supply Voltage	VDC	20 - 80
Safe Torque Off Voltage ¹	VDC	24 (±6)
Maximum Peak Output Current ²	A (Arms)	100 (70.7)
Maximum Continuous Output Current ³	A (Arms)	60 (60)
Max. Continuous Output Power @ Rated Voltage	W	4560
Max. Continuous Power Dissipation @ Rated Voltage	W	240
Internal Bus Capacitance	µF	500
Minimum Load Inductance (Line-To-Line) ⁴	µH	250 (at 80 V supply); 150 (at 48 V supply); 75 (at 24 V supply)
Switching Frequency	kHz	20
Maximum Output PWM Duty Cycle	%	100
Low Voltage Supply Outputs	-	+5 VDC (250 mA)

Control Specifications		
Description	Units	Value
Communication Interfaces	-	CANopen (RS-232 for configuration)
Command Sources	-	±10 V Analog, Encoder Following, Over the Network, PWM and Direction, Sequencing, Indexing, Jogging
Feedback Supported	-	±10 VDC Position, Auxiliary Incremental Encoder, EnDat® 2.1/2.2, Hiperface®, 1Vp-p Sine/Cosine Encoder, Tachometer (±10 VDC)
Commutation Methods	-	Sinusoidal
Modes of Operation	-	Profile Current, Profile Velocity, Profile Position, Interpolated Position Mode (PVT)
Motors Supported	-	Closed Loop Vector, Single Phase (Brushed, Voice Coil, Inductive Load), Three Phase (Brushless)
Hardware Protection	-	40+ Configurable Functions, Over Current, Over Temperature (Drive & Motor), Over Voltage, Short Circuit (Phase-Phase & Phase-Ground), Under Voltage
Programmable Digital Inputs/Outputs (PDIs/PDOs)	-	10/4
Programmable Analog Inputs/Outputs (PAIs/PAOs)	-	4/1
Primary I/O Logic Level	-	24 VDC
Current Loop Sample Time	µs	100
Velocity Loop Sample Time	µs	200
Position Loop Sample Time	µs	200
Maximum Sin/Cos Encoder Frequency	kHz	200
Maximum Sin/Cos Interpolation	-	2048 counts per sin/cos cycle

Mechanical Specifications		
Description	Units	Value
Agency Approvals	-	RoHS II, TÜV Rheinland® (STO), UL/cUL Pending, CE Pending
Size (H x W x D)	mm (in)	190.5 x 111.8 x 67.3 (7.50 x 4.40 x 2.65)
Weight	g (oz)	935 (32.98)
Heatsink (Base) Temperature Range ⁵	°C (°F)	0 - 75 (32 - 167)
Storage Temperature Range	°C (°F)	-40 - 85 (-40 - 185)
Form Factor	-	Panel Mount
Cooling System	-	Natural Convection
+24V LOGIC Connector	-	2-port, 3.5 mm spaced insert connector
AUX COMM Connector	-	3-pin, 2.5 mm spaced, enclosed, friction lock header
AUX ENCODER Connector	-	15-pin, high-density, male D-sub
COMM Connector	-	Shielded, dual RJ-45 socket with LEDs
FEEDBACK Connector	-	15-pin, high-density, female D-sub
I/O Connector	-	26-pin, high-density, female D-sub
POWER Connector	-	2-port, 10.16 mm spaced, enclosed, friction lock header
MOTOR POWER Connector	-	3-port, 10.16 mm spaced, enclosed, friction lock header
STO Connector	-	8-port, 2.0 mm spaced, enclosed, friction lock header

Notes

1. STO features must be disabled for applications not using STO. See page 6 for more information.
2. Capable of supplying drive rated peak current for 2 seconds with 10 second foldback to continuous value. Longer times are possible with lower current limits.
3. Continuous A_{rms} value attainable when RMS Charge-Based Limiting is used.
4. Lower inductance is acceptable for bus voltages well below maximum. Use external inductance to meet requirements.
5. Additional cooling and/or heatsink may be required to achieve rated performance.

Sold & Serviced By:



PIN FUNCTIONS

+24V LOGIC - Logic Power Connector			
Pin	Name	Description / Notes	I/O
1	LOGIC PWR	Logic Supply Input	I
2	LOGIC GND	Logic Supply Ground	GND

AUX COMM - RS232 Communication Connector			
Pin	Name	Description / Notes	I/O
1	RS232 RX	Receive Line (RS-232)	I
2	RS232 TX	Transmit Line (RS-232)	O
3	ISO GND	Isolated Signal Ground	IGND

AUX ENCODER - Auxiliary Feedback Connector			
Pin	Name	Description / Notes	I/O
1	RESERVED	Reserved	-
2	RESERVED	Reserved	-
3	RESERVED	Reserved	-
4	PDI-8 + (PWM+ / AUX ENC A+ / CAP-B+)	Programmable Digital Input or PWM or Auxiliary Encoder or High Speed Capture (For Single-Ended Signals Leave Negative Terminal Open)	I
5	PDI-8 - (PWM- / AUX ENC A- / CAP-B-)	Programmable Digital Input or PWM or Auxiliary Encoder or High Speed Capture (For Single-Ended Signals Leave Negative Terminal Open)	I
6	PDI-9 + (DIR+ / AUX ENC B+ / CAP-C+)	Programmable Digital Input or Direction Input or Auxiliary Encoder or High Speed Capture (For Single-Ended Signals Leave Negative Terminal Open)	I
7	PDI-9 - (DIR- / AUX ENC B- / CAP-C-)	Programmable Digital Input or Direction Input or Auxiliary Encoder or High Speed Capture (For Single-Ended Signals Leave Negative Terminal Open)	I
8	PDI-10 + (AUX ENC I+ / CAP-A+)	Programmable Digital Input or Auxiliary Encoder or High Speed Capture (For Single-Ended Signals Leave Negative Terminal Open)	I
9	PDI-10 - (AUX ENC I- / CAP-A-)	Programmable Digital Input or Auxiliary Encoder or High Speed Capture (For Single-Ended Signals Leave Negative Terminal Open)	I
10	SGN GND	Signal Ground	SGND
11	SGN GND	Signal Ground	SGND
12	SGN GND	Signal Ground	SGND
13	+5V OUT	+5V Encoder Supply Output (Short Circuit Protected)	O
14	PAI-4 +	Differential Programmable Analog Input (12-bit Resolution)	I
15	PAI-4 -		I

COMM - CAN Communication Connector			
Pin	Name	Description / Notes	I/O
1	CAN_H	CAN_H Line (Dominant High)	I
2	CAN_L	CAN_L Line (Dominant Low)	I
3	CAN_GND	CAN Ground	CGND
4	RESERVED	Reserved	-
5	RESERVED	Reserved	-
6	RESERVED	Reserved	-
7	CAN_GND	CAN Ground	CGND
8	RESERVED	Reserved	-

STO – Safe Torque Off Connector*			
Pin	Name	Description / Notes	I/O
1	STO OUTPUT	Safe Torque Off Output	O
2	RESERVED	Reserved	-
3	STO-1 RETURN	Safe Torque Off 1 Return	STORET1
4	STO-1	Safe Torque Off – Input 1	I
5	STO-2 RETURN	Safe Torque Off 2 Return	STORET2
6	STO-2	Safe Torque Off – Input 2	I
7	RESERVED	Reserved	-
8	STO OUT RETURN	Safe Torque Off Output Return	STORETO

*STO features must be disabled for applications not using STO. See page 6 for more information.

Sold & Serviced By:



FEEDBACK - Feedback Connector			
Pin	Name	Description / Notes	I/O
1	COS +	Cosine Input	I
2	COS -		I
3	SIN +	Sine Input	I
4	SIN -		I
5	SGN GND	Signal Ground	SGND
6	DATA-	Differential Data Line (Differential Hall A if using 1Vp-p Sine/Cosine encoder. Pin 6 = Hall A+, Pin 7 = Hall A-. For single-ended Halls leave negative terminal open.)	I/O
7	DATA+		I/O
8	CLOCK+	Differential Clock Line (Differential Hall B if using 1Vp-p Sine/Cosine encoder. Pin 8 = Hall B+, Pin 9 = Hall B-. For single-ended Halls leave negative terminal open.)	O
9	CLOCK-		O
10	REF MARK +	Reference mark from sine/cosine encoder	I
11	RESERVED	Reserved (Differential Hall C if using 1Vp-p Sine/Cosine encoder. Pin 11 = Hall C+, Pin 12 = Hall C-. For single-ended Halls leave negative terminal open.)	-
12	RESERVED		-
13	+5V OUT	+5V Encoder Supply Output (Short Circuit Protected)	O
14	PAI-3	Programmable Analog Input (12-bit Resolution)	I
15	REF MARK -	Reference mark from sine/cosine encoder	I

I/O - Signal Connector			
Pin	Name	Description / Notes	I/O
1	PDO-1	Isolated Programmable Digital Output	O
2	OUTPUT COMMON	Digital Output Common	OGND
3	PDO-2	Isolated Programmable Digital Output	O
4	PAI-1 + (REF+)	Differential Programmable Analog Input or Reference Signal Input (16-bit Resolution)	I
5	PAI-1 - (REF-)		I
6	PAI-2	Programmable Analog Input (12-bit Resolution)	I
7	PAO-1	Programmable Analog Output (10-bit Resolution)	O
8	OUTPUT PULL-UP	Digital Output Pull-Up For User Outputs	I
9	PDI-5	Isolated Programmable Digital Input	I
10	PDO-3	Isolated Programmable Digital Output	O
11	PDI-1	Isolated Programmable Digital Input	I
12	PDI-2	Isolated Programmable Digital Input	I
13	PDI-3	Isolated Programmable Digital Input	I
14	PDO-4	Isolated Programmable Digital Output	O
15	INPUT COMMON	Digital Input Common (Can Be Used To Pull-Up Digital Inputs)	IGND
16	SGN GND	Signal Ground	SGND
17	PDI-4	Isolated Programmable Digital Input	I
18	PDI-6	Isolated Programmable Digital Input	I
19	PDI-7	Isolated Programmable Digital Input	I
20	ENC A+ OUT	Emulated Encoder Channel A Output	O
21	ENC A- OUT		O
22	ENC B+ OUT	Emulated Encoder Channel B Output	O
23	ENC B- OUT		O
24	ENC I+ OUT	Emulated Encoder Index Output	O
25	ENC I- OUT		O
26	SGN GND	Signal Ground	SGND

MOTOR POWER - Power Connector			
Pin	Name	Description / Notes	I/O
1	MOTOR A	Motor Phase A	O
2	MOTOR B	Motor Phase B	O
3	MOTOR C	Motor Phase C	O

POWER - Power Connector			
Pin	Name	Description / Notes	I/O
1	PWR GND	Power Ground (Common With Signal Ground)	PGND
2	HIGH VOLTAGE	DC Power Input	I

Sold & Serviced By:



Toll Free Phone (877) SERV098
 Toll Free Fax (877) SERV099
www.electromate.com
sales@electromate.com

HARDWARE SETTINGS

Switch Functions

Switch	Description	Setting	
		On	Off
1	Bit 0 of binary CANopen node ID. Does not affect RS-232 settings.	1	0
2	Bit 1 of binary CANopen node ID. Does not affect RS-232 settings.	1	0
3	Bit 2 of binary CANopen node ID. Does not affect RS-232 settings.	1	0
4	Bit 3 of binary CANopen node ID. Does not affect RS-232 settings.	1	0
5	Bit 4 of binary CANopen node ID. Does not affect RS-232 settings.	1	0
6	Bit 5 of binary CANopen node ID. Does not affect RS-232 settings.	1	0
7	Bit 0 of drive CANopen bit rate setting. Does not affect RS-232 settings.	1	0
8	Bit 1 of drive CANopen bit rate setting. Does not affect RS-232 settings.	1	0

Additional Details

The drive can be configured to use the address and/or bit rate stored in non-volatile memory by setting the address and/or bit rate value to 0. Use the table below to map actual bit rates to a bit rate setting. Note that higher bit rates are possible when using the value stored in NVM.

Bit Rate (kbits/sec)	Value For Bit Rate Setting
Load from non-volatile memory	0
500	1
250	2
125	3

CAN Termination Jumper Settings

Jumper	Description	Configuration			
		Header Jumper	Not Installed	Pins 1-2	Pins 2-3
J1	CAN bus termination. Install this jumper (2.54mm) on the last drive in a CAN network. This jumper is located on a 4-pin header adjacent to the RS-232 connector. It consists of the two pins furthest from the connector.		Non-terminating Node	Terminating Node	N/A
J2	Reserved.		-	-	N/A

Safe Torque Off (STO) Inputs

The Safe Torque Off (STO) Inputs are dedicated +24VDC max sinking single-ended inputs. For applications not using STO functionality, disabling of the STO feature is required for proper drive operation. STO may be disabled by installing the included mating connector for the STO connector and following the STO Disable wiring instructions as given in the hardware installation manual. Consult the hardware installation manual for more information. Alternatively, a dedicated STO Disable Key connector is available for purchase for applications where STO is not in use. Contact the factory for ordering information.

Sold & Serviced By:



Toll Free Phone (877) SERV098
 Toll Free Fax (877) SERV099
www.electromate.com
sales@electromate.com

MECHANICAL INFORMATION

+24V LOGIC - Logic Power Connector

Connector Information	2-port, 3.5 mm spaced insert connector	
Mating Connector	Details	Phoenix Contact: P/N 1840366
	Included with Drive	Yes

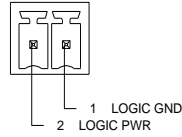

AUX COMM - RS232 Communication Connector

Connector Information	3-pin, 2.5 mm spaced, enclosed, friction lock header	
Mating Connector	Details	Phoenix: Plug P/N 1881338
	Included with Drive	Yes

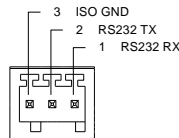

STO - Safe Torque Off Connector

Connector Information	8-port, 2.00 mm spaced, enclosed, friction lock header	
Mating Connector	Details	Molex: P/N 51110-0860 (housing); 50394-8051 (pins)
	Included with Drive	No

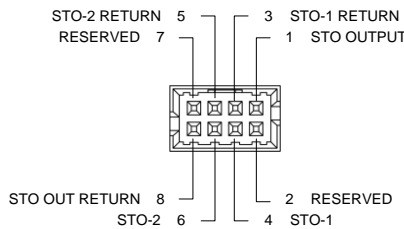

COMM - CAN Communication Connector

Connector Information	Shielded, dual RJ-45 socket with LEDs	
Mating Connector	Details	AMP: Plug P/N 5-569552-3
	Included with Drive	No

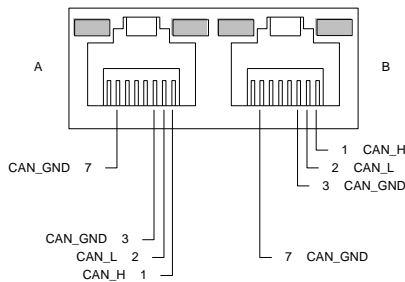

Sold & Serviced By:



AUX ENCODER - Auxiliary Feedback Connector

Connector Information	15-pin, high-density, male D-sub	
Mating Connector	Details	TYCO: Plug P/N 1658681-1; Housing P/N 5748677-1; Terminals P/N 1658686-2 (loose) or 1658686-1 (strip)
	Included with Drive	No

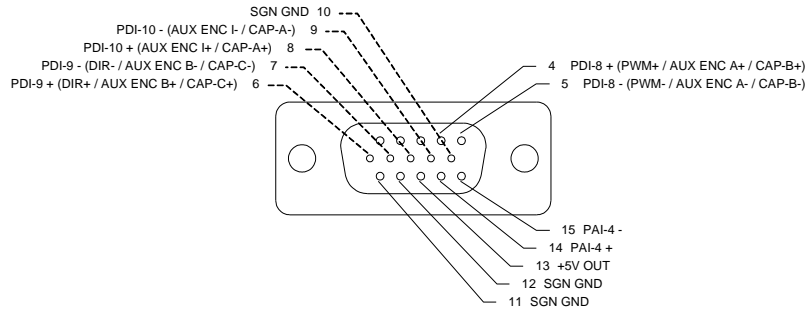

FEEDBACK - Feedback Connector

Connector Information	15-pin, high-density, female D-sub	
Mating Connector	Details	TYCO: Plug P/N 748364-1; Housing P/N 5748677-1; Terminals P/N 1658670-2 (loose) or 1658670-1 (strip)
	Included with Drive	No

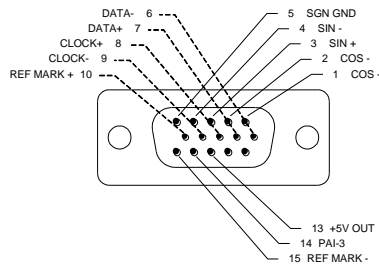

I/O - Signal Connector

Connector Information	26-pin, high-density, female D-sub	
Mating Connector	Details	TYCO: Plug P/N 1658671-1; Housing P/N 5748677-2; Terminals P/N 1658670-2 (loose) or 1658670-1 (strip)
	Included with Drive	No

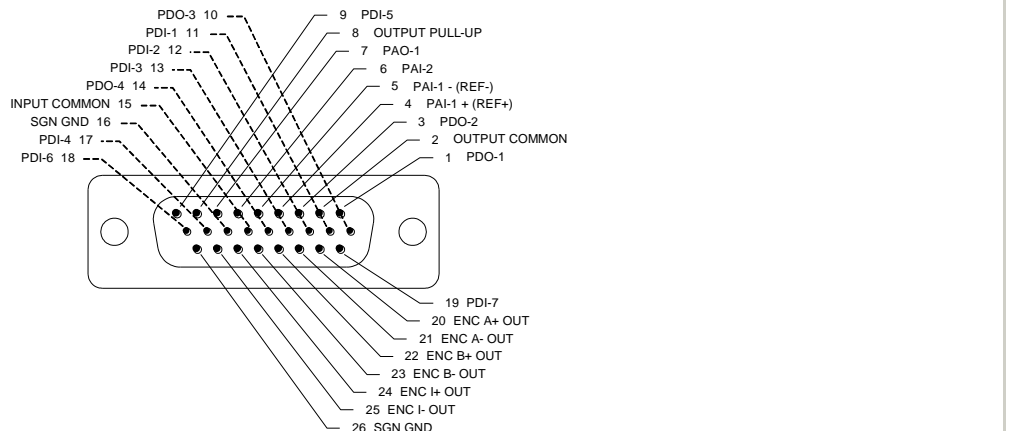

Sold & Serviced By:



Toll Free Phone (877) SERV098
Toll Free Fax (877) SERV099
www.electromate.com
sales@electromate.com

MOTOR POWER - Power Connector

Connector Information		3-pin, 10.16 mm spaced, enclosed, friction lock header
Mating Connector	Details	Phoenix Contact: P/N 1913510
	Included with Drive	Yes

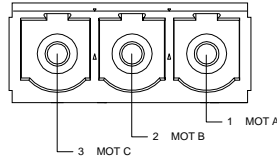

POWER - Power Connector

Connector Information		2-pin, 10.16 mm spaced, enclosed, friction lock header
Mating Connector	Details	Phoenix Contact: P/N 1913507
	Included with Drive	Yes

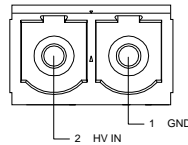

Sold & Serviced By:



MOUNTING DIMENSIONS

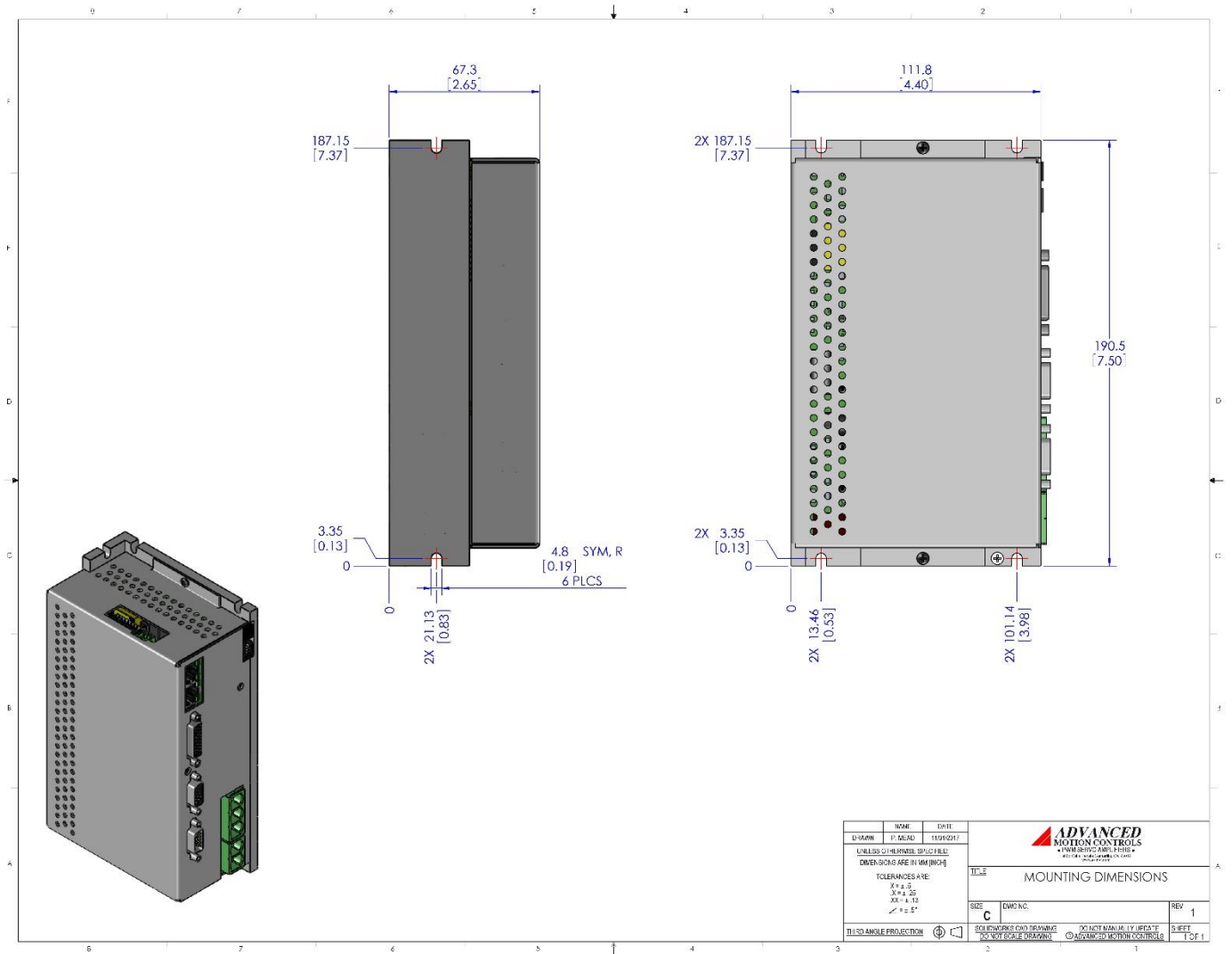

Sold & Serviced By:



Toll Free Phone (877) SERV098
Toll Free Fax (877) SERV099
www.electromate.com
sales@electromate.com

PART NUMBERING INFORMATION

Example: **D P C A N I A - 1 0 0 B 0 8 0 -**

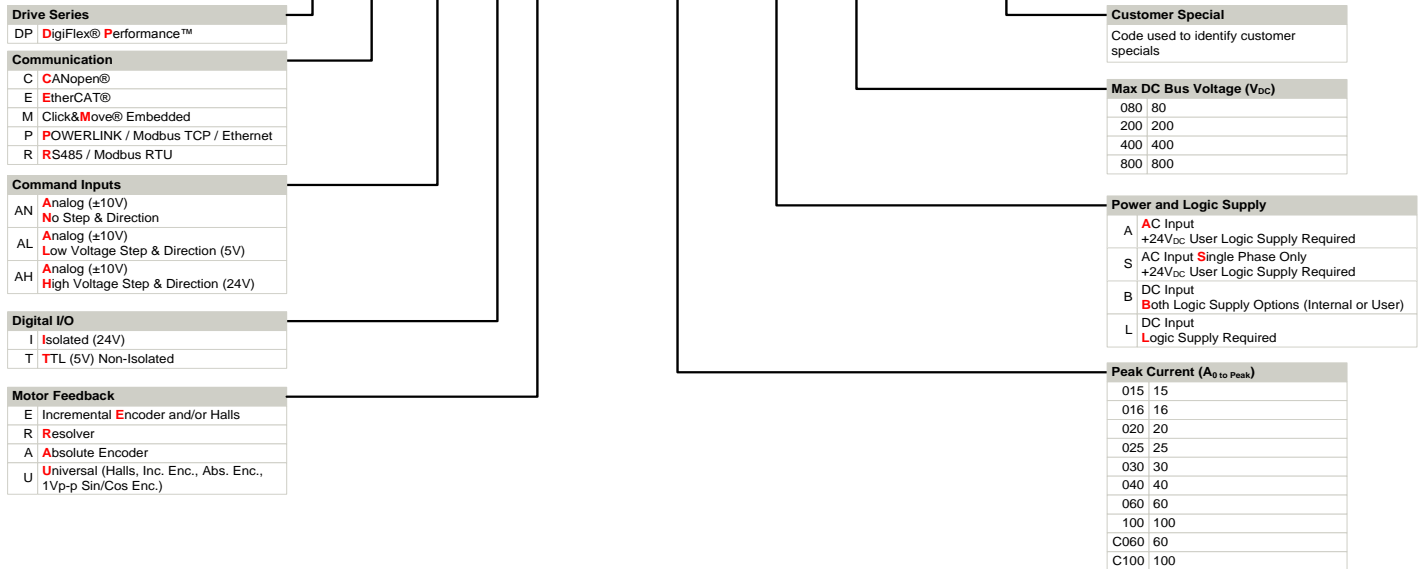

DigiFlex® Performance™ series of products are available in many configurations. Note that not all possible part number combinations are offered as standard drives. All models listed in the selection tables of the website are readily available, standard product offerings.

ADVANCED Motion Controls also has the capability to promptly develop and deliver specified products for OEMs with volume requests. Our Applications and Engineering Departments will work closely with your design team through all stages of development in order to provide the best servo drive solution for your system. Equipped with on-site manufacturing for quick-turn customs capabilities, ADVANCED Motion Controls utilizes our years of engineering and manufacturing expertise to decrease your costs and time-to-market while increasing system quality and reliability. Feel free to contact Applications Engineering for further information and details.

Examples of Customized Products

- ▲ Optimized Footprint
- ▲ Private Label Software
- ▲ OEM Specified Connectors
- ▲ No Outer Case
- ▲ Increased Current Resolution
- ▲ Increased Temperature Range
- ▲ Custom Control Interface
- ▲ Integrated System I/O
- ▲ Tailored Project File
- ▲ Silkscreen Branding
- ▲ Optimized Base Plate
- ▲ Increased Current Limits
- ▲ Increased Voltage Range
- ▲ Conformal Coating
- ▲ Multi-Axis Configurations
- ▲ Reduced Profile Size and Weight

Available Accessories

ADVANCED Motion Controls offers a variety of accessories designed to facilitate drive integration into a servo system. Visit www.a-m-c.com to see which accessories will assist with your application design and implementation.



Sold & Serviced By:



All specifications in this document are subject to change without notice. Actual product may differ from pictures provided in this document.